

**CENTER OF PRESSURE MIGRATION DURING PROLONGED
UNCONSTRAINED SITTING**

By

Jason Lusk, B.Sc.

**A Thesis
Submitted to the Faculty of Graduate Studies
in Partial Fulfillment of the Requirements
for the Degree of**

MASTER OF SCIENCE

**Department of Mechanical & Industrial Engineering
The University of Manitoba
Winnipeg, Manitoba**

© June 2003

**THE UNIVERSITY OF MANITOBA
FACULTY OF GRADUATE STUDIES

COPYRIGHT PERMISSION**

Center of Pressure Migration During Prolonged Unconstrained Sitting

BY

Jason Lusk, B.Sc.

**A Thesis/Practicum submitted to the Faculty of Graduate Studies of The University of
Manitoba in partial fulfillment of the requirement of the degree
Of
Master of Science**

Jason Lusk, B.Sc. © 2003

Permission has been granted to the Library of the University of Manitoba to lend or sell copies of this thesis/practicum, to the National Library of Canada to microfilm this thesis and to lend or sell copies of the film, and to University Microfilms Inc. to publish an abstract of this thesis/practicum.

This reproduction or copy of this thesis has been made available by authority of the copyright owner solely for the purpose of private study and research, and may only be reproduced and copied as permitted by copyright laws or with express written authorization from the copyright owner.

Abstract

It was once thought that center of pressure (COP) migration during prolonged unconstrained standing (PUS) was stochastic (random) in nature. In a recent study it was found that there are discernable patterns that can be identified when the PUS data are examined in a time series. However, there has not been much information collected on whether these patterns, or others, also exist during prolonged unconstrained sitting. The main purpose of this research was to show that during prolonged and unconstrained sitting, specific and consistent patterns of the center of pressure migration exist. Subjects were asked to sit on a force plate “chair” for a time of half an hour. The center of pressure migration was measured and data were collected on 12 subjects. These data were analyzed and it was found that three specific and consistent patterns do exist during prolonged unconstrained seating. These patterns were identified manually for all subjects. Computer software was adapted to automatically identify these patterns and the results compared favourably with the manual identification findings. The determination that such patterns exist aided in further understanding the physical mechanisms and reactions that occur during prolonged unconstrained sitting. In addition, continued modification and development of the software to more accurately identify these patterns will permit its usage in a more practical setting. This may include incorporating the information gained from its use into the development of a dynamic chair, rather than restricting its use to a research environment.

Acknowledgements

I would like to thank my advisor Dr. Christine Wu for providing me with the opportunity of pursuing my graduate degree. Thank you for having the confidence in my abilities, providing direction during the development of this thesis, and patience throughout the completion of this project.

Thank you to Mark Karpenko for assisting me in understanding and modifying the Matlab software used to analyze the data.

I would like to extend my appreciation to all of those people who volunteered their time as subjects for this research. Without you the collection of data would have been impossible.

Thank you to Krissa for encouraging me over the past few months for the extra effort needed to achieve my goals.

To my parents, thank you for your support and the sacrifices you have made over the past couple of years. I can not imagine having gone through this experience without your encouragement.

Finally, above all else, I would like to thank God for blessing me with this opportunity. Thank you for giving me the strength to accomplish the completion of this project.

Table of Contents

Abstract	ii
Acknowledgements	iii
List of Figures	vi
List of Tables	vii
1. Introduction	1
1.1 Motivations	1
1.2 Literature Review	3
1.3 Center of Pressure Migration During Standing	12
1.4 Objectives	14
1.5 Thesis Organization	14
2. Methodology and Experimental Procedure	16
2.1 Introduction	16
2.2 Equipment	16
2.3 Subject Data	19
2.4 Experimental Procedure	20
2.5 Method of Data Analysis	21
3. Manual Analysis and Results	24
3.1 Introduction	24
3.2 Preliminary Findings	24
3.3 Manual Analysis Methodology	25
3.4 Results	28

4. Computer Analysis and Results	33
4.1 Introduction	33
4.2 Program Description	34
4.3 Pattern Identification Software	38
4.4 Computer Analysis	43
5.5 Results	45
5. Discussion, Conclusions and Future Work	48
5.1 Data Comparison and Discussion	48
5.2 Software Evaluation	55
5.3 Conclusions	57
5.4 Future Work	58
References	61
Appendix A – Plotted Raw Data: Center of Pressure Migration	63
Appendix B – Plotted Filtered Data and Manual Results Tables	75
Appendix C – Identification Comparison Tables and Notes	190
Appendix D – Identified Pattern Tables	222
Appendix E – Parameter Tuning Data	225
Appendix F – Volunteer Consent Form	230

List of Figures

Figure 2.1	Kistler Portable Multicomponent Force Plate	17
Figure 2.2	The Kistler Force Plate Coordinate System	19
Figure 2.3	Frontal View of the Experimental Apparatus	22
Figure 2.4	Side View of the Experimental Apparatus	23
Figure 3.1	Identifiable Patterns During COP Migration	25
Figure 4.1	Diagram of Shift Identification	35
Figure 4.2	Diagram of Fidget Identification	36
Figure 4.3	Diagram of Drift Identification	37
Figure 4.4	Graphical User Interface for Pattern Identification Software	40
Figure 4.5	GUI with Plotted COP Data	40
Figure 4.6	GUI with Identified Patterns	41

List of Tables

Table 3.1 COP Pattern Manual Identification Order Parameters	27
Table 3.2 Manual Analysis Data for Subject 1X	31
Table 3.3 Statistical Data of Shifting Per Subject	32
Table 3.4 Statistical Data of Fidgeting Per Subject	32
Table 3.5 Statistical Data of Drifting Per Subject	32
Table 4.1 Computer Identification Data Sheet	47
Table 4.2 Statistical Data of Software Identified COP Migration Patterns	47
Table 5.1 Tabulated Results of Pattern Identification for Subject 1	49
Table 5.2 COP Migration Pattern Values for Both Identification Processes	50
Table 5.3 Manual Identification/Computer Identification Comparison	54
Table 5.4 COP Pattern Tabulation	55
Table 5.5 Software Identified Shifts that Were not Verified Manually	57

Chapter 1

Introduction

1.1 Motivations

The seated position is one of the most common positions. Whether someone is at work in front of a video display terminal, riding the bus on their way to school, or in a stadium watching a sporting event, sitting is part of our daily lives. Granted, all people do not all sit alike. Differences in physical attributes as well as functional abilities make it extremely difficult to characterize a single best sitting position. That does not mean, however, that research into sitting, sitting posture, and seating systems (chairs, cushions, etc.) is pointless. Much can be gained and has already been learned when it comes to sitting.

Most people sit as a way of relaxing much of the body, transferring a large part of the body's load to the buttocks and thigh area and off of the feet. For a large part of the population, however, sitting is not a position of rest but rather it is a necessity caused by restrictions in their mobility. Groups of people in which sitting is a commonly assumed body position include the elderly, people with spinal cord injuries (SCI), or those with other disabilities [17]. As a result, much time and effort has been put into the development of seating systems that will redistribute the large amounts of pressure experienced by the buttocks, particularly under the bony prominences of the ischial tuberosities. Cushions manufactured out of foams, gels, or those that incorporate fluid-

filled pockets are widely used in seating and positioning intervention to accomplish this pressure redistribution.

There have been many studies [6] [8] [16] [17] on the formation and occurrence of pressure sores, as they pose a serious problem for many who are users of wheelchairs or who are limited in their movement. Various factors affect the formation of pressure sores, such as body weight, muscle tone and cushion material.

While much research has taken place already in terms of seat design, the formation of pressure sores, and the mechanics and dynamics of sitting, there is still much information that is unknown. What is known is that sitting is not a static activity, but a dynamic one. Over time the body does not stay in one position when seated. Movement occurs, whether that is as a result of gravity's effect on the body or weight shifting to improve comfort.

The center of pressure (COP) is the point of application of the vertical forces acting on a surface of support and is a measurable parameter [23]. A question that arises when looking at how we move during sitting is: how does the body's COP change or migrate while in the seated position? The goal of this research is to examine the center of pressure migration at the buttocks-seat interface and to determine if identifiable patterns in migration exist when sitting occurs over a prolonged period of time. This will be accomplished by recording the center of pressure at the buttocks-seat interface for healthy subjects and subsequently analyzing the data. As there has not been much research, if any at all, into the migration of the center of pressure during prolonged sitting, subjects with intact mobility and sensation have been chosen, as opposed to those

with limited or no movement or sensation, in order to create a foundation upon which further research can be built and compared.

1.2 Literature Review

Why do we sit? What purpose does it serve? According to Cornell University's ergonomics department [1], sitting is defined as 'a body position in which the weight of the body is transferred to a supporting area mainly by the ischial tuberosities of the pelvis and their surrounding soft tissue. They go on to note that we sit to remove weight from our feet while maintaining a stable posture so that muscles not directly related to the task being accomplished can relax. How we sit and examinations of the best possible positions and postures for sitting have been the subject of much study [1] [2] [4] [11]. Two characteristics of sitting have clearly been identified: (1) sitting is dynamic in nature, and (2) there is no single best position.

One effect of sitting is that it does not take very long for discomfort to arise, particularly when maintaining one position over an extended period of time. This period of time varies among people due to differences in anatomical structure and pain threshold. For some people, discomfort may arise within a couple of minutes while for others they may sit for 20 minutes before discomfort is felt. In the seated position, the ischia of the pelvic bone bear much of the load over a comparatively small area. In an article by Sember [2], he stated the problem as follows, "We have found that when a person assumes a seated posture (this being an inherently unnatural position) the body begins to react to gravity. This reaction begins as the fat and muscle tissue directly

beneath the ischia slowly move out from under these bony prominences and allow them to 'core down' to a point approaching the skin."

Sember [2] listed the maximum loads that the ischia can bear without discomfort after 15 minutes. They are as follows: 1.2 psi (62 mmHg) for men up to the age of 30 and women up to 40; 0.5 psi (26 mmHg) to 0.9 psi (46.5 mmHg) for both men and women over the age of 40; and less than 0.3 psi (15.5 mmHg) for the elderly. Specific ages for the elderly and maximum loads for men between the ages of 30 and 40 were not discussed in the article by Sember.

As pressure continues to build under the force-bearing areas, the capillaries in the tissue are forced to close. Capillaries are part of a web-like network, embedded in the body's tissue, connecting arteries and veins. They are involved with the transport of oxygen and waste products to and from the tissue, respectively [3]. Cook and Hussey [4] state that pressures applied to tissue for even a short period of time result in a decrease or complete cessation of blood flow (ischemia) to the tissue. When ischemia is allowed to continue, pressure sores develop.

A pressure sore or pressure ulcer may be defined as an area of tissue necrosis resulting from external pressures which are applied over an extended period of time to soft tissue that overlies a bony prominence [4] [6]. Gross et al. [5] have reported that ischemia, caused by pressure greater than capillary pressure, is the primary factor in the formation of ulcers or pressure sores. A common assumption is that pressure sore formation occurs when the surface pressure at the buttocks exceeds the mean capillary pressure of 32 mmHg (0.6 psi) [6]. The belief is that exceeding this pressure would subsequently lead to ischemia and then tissue necrosis [6] [8]. Sember [2], through his

research, offered an alternative opinion to this widely held assumption. He reported that pressures above 0.73 psi (37.8 mmHg) cause the capillaries to close and therefore pressures below this threshold can be tolerated indefinitely. Sember [2] continued on to state that pressures greater than 1.7 psi (87.9 mmHg) lead to skin cell necrosis, although he does not report whether this happens immediately or after a certain amount of time has passed.

Other studies have shown that these thresholds may not be valid for all people. Crenshaw and Vistnes [6] have reported on work in which clinical studies have shown that these thresholds are exceeded without any apparent damage to the tissue of the patients. Some individuals can be exposed to larger interface pressures without the development of pressure sores while others have very little tolerance [4]. Regardless of the exact pressure that may be withstood by the capillaries, the development of pressure sores continue to be a serious problem for people with limited mobility. Aside from limiting one's ability to lead a productive life as a result of major discomfort, pressure sores are also potentially life-threatening [18]. Among those who have suffered a spinal-cord injury, 7% to 8% of deaths among this population are directly related to pressure sores [4].

While external pressures over the bony prominences have been considered the primary etiology in the development of pressure sores, there are other causes that must also be considered [9] [11]. Shear forces, created when two surfaces move across or relative to each other in opposite directions, and the associated frictional forces play important roles in the formation of ulcers. An example occurrence of these forces is when someone slides on their cushion. Further potential causes include tissue distortion,

increased temperatures in conjunction with the increased pressure, and moisture control (i.e. perspiration, urine, etc.) [4] [8]. Bacteria, while not a direct cause of pressure sores, are believed to contribute to the breakdown of tissue and delay healing [6].

Pressure sores pose serious problems for people with spinal cord injuries, as well as those people who may be limited in their mobility, such as individuals with multiple sclerosis and muscular dystrophy, and the elderly [4]. It has been reported that between 5 and 10% of people with spinal cord injuries who are wheelchair users suffer from pressure sores each year, and among the elderly who reside in nursing homes the prevalence of sores ranges from 7 to 23% [21]. Aside from the common thread of the lack of mobility, which restricts one's ability to weight shift and redistribute pressure, there may also be a lack of sensation in the buttock area which gives cause for concern. This lack of sensation reduces or removes the body's internal warnings that the tissue has been loaded for too long. Regardless of the specific associated pressures, pressure sore formation is a complicated process and past research has shown little consistency with clinical observations [6].

The body's main defence against discomfort for those who retain a level of sensation due to pressure build-up during sitting is movement. This movement may be defined by some as 'shifting' or 'fidgeting'. The interface pressure between the seat and the buttocks is altered by such movements as crossing one's legs or leaning from side-to-side or forward or backward. For people who have limited or no mobility and limited or no sensation it is increasingly difficult to relieve the pressure.

In an effort to combat and reduce the high pressures experienced by individuals who spend much of their time in a seated position, there has been much time and effort

invested into the research and development of specialized seating systems. One of the primary goals of these seating systems is to increase the effective load-bearing area of the buttocks and to minimize the pressure under the bony prominences (ischial tuberosities, sacrum, etc.). In turn, this redistributes the pressure experienced to the normally low pressure areas, those of fat and muscle, which are less prone to pressure sore development [2]. It is also important to design seating systems that maximize a person's function in order for them to remain as independent as possible [4].

Seating systems fall into two major categories: planar seating systems and contoured seating systems. Planar seating systems are made up of flat components that are supportive only where the body comes into contact with it. They may be prefabricated, to fit a variety of individuals, or they may be custom made for individuals, providing a better fit.

Contoured cushions are designed to provide a cushion that will distribute pressure across the seating surface [4]. They come in standard models or custom-contoured. Standard models are used when a contoured seat is desired but it is not essential that it fit the exact shape of the person using it. In some cases, custom contoured cushions (CCC) are used instead of the standard cushions that are commercially available. Kwiatowski and Inigo [10] define a CCC as "foam cushions that have been manufactured or modified for use by a specific individual in order to distribute the tissue/support interface pressures as desired". This is achieved by contouring the cushion so that the contact area is increased, thereby reducing the peak pressures. Envelopment and immersion also increase, reducing the pressure peaks [8]. Envelopment refers to the degree with which

the cushion surrounds the buttocks while immersion refers to the degree a person sinks into the cushion [4].

In a paper by Sprigle et al. [9] the authors note five major factors that affect contoured seats: 1) the shape of the buttocks; 2) the shape of the cushion; 3) the biomechanical properties of the buttocks influenced by tissue thickness and stiffness; 4) mechanical properties of the foam (or other materials) classified by the indentation load deflection (ILD) and density; and, 5) weight distribution on the cushion. To expand on the fourth point, in addition to the density and ILD, other cushion properties to be considered are resilience, dampening, and envelopment [4].

Developments in contoured seating have led to developments in the way such seating interventions are made. At the University of Virginia's Rehabilitation Engineering Center (UVA REC) [10] the Closed-Loop Automated Seating System (CLASS) had been developed which is to be used in conjunction with the Custom Cushion Fabrication System (CCFS). The CLASS is a seating tool that has been designed to allow for simultaneous adjustment of contours and the measurement of interfacial pressures. Its main purpose is to reduce the amount of wasted time and materials that may be associated with the fabrication of custom-contoured cushions. The usage of this tool speeds up the normally slow iterative process involved in producing custom-contoured cushions. That being said, the actual design of the CLASS is beyond the scope of this review.

The CASS, or computer-aided seating system, is another tool which is used to aid in the design of custom-contoured cushions [12]. It is a "dynamically controlled shape and pressure sensing system developed for quantification of the complex relationship

between support surface shape, tissue thickness changes and interface pressures". A second generation of CASS has been developed which is able to directly measure the interface pressure at the support surface as opposed to using indirect force measurements [13]. It also has the ability to adjust the surface shape four times more rapidly than the original. While the CASS is not likely to be developed into a tool used for support surface design, the information acquired through its use may be extremely useful in the design of custom contoured cushions.

Commercially developed cushions fall into two major types: 1) foam cushions, and 2) flotation cushions; each with their own advantages and disadvantages. Foam is the most commonly used material in the fabrication of cushions. Two of the main benefits of foam are that it is generally lightweight and reasonably inexpensive. With softer foam there is superior envelopment when compared with stiffer foam however there is a risk of bottoming out with if the foam is not thick enough. Bottoming out occurs when the foam is not thick enough to support the weight of the person and the foam compresses to such an extent that it is no longer effective as a cushion. The resilience of foam, which is its ability to recover its shape after a load has been removed or to its ability to adjust to an applied loading, is generally considered to be good, largely depending on the foam density and the structure [4]. The thermal characteristics of foam are poor, often increasing skin temperature between the buttocks and seat interface. This may contribute to the development of pressure sores.

Viscoelastic foam cushions, which become softer at operating temperatures (temperatures near body temperature), are described by Brienza and Geyer [8]. They provide better pressure distribution when compared with various other types of foams,

such as polyurethane or latex. One disadvantage in using this type of foam is that the material is temperature and time-sensitive, so the desired results may not be achieved if the ambient temperature is too low.

Flotation cushions, as described by Cook and Hussey [4], incorporate chambers filled with air, water, gels, or other viscous fluids. Most of these types of fluid-filled seats permit a high-degree of immersion, allowing the body to sink into the cushion, increasing the surface contact area and decreasing the pressure distribution. Air-filled cushions typically provide good pressure relief but the amount of envelopment is directly related to the pressure. Under-inflation of an air-cushion might lead to a bottoming out effect and over-inflation may lead to increased pressures at the interface between the buttocks and the seat. Elastomeric gels, which have a very high viscosity and subsequently almost no flow, provide poor envelopment and resilience, but do have good thermal and dampening properties. Due to its low viscosity, a water-filled cushion will provide good short-term resilience and envelopment, however, care must be taken in order to maintain the cushion's bladder. Viscous fluid-filled materials, such as silicon or polyvinyl, fall somewhere in-between the elastomeric gels and the low viscosity of water. Although the envelopment is considered adequate, the resilience of these cushions is generally poor, depending upon the surrounding membrane. They also provide decent conduction of heat away from the body [4]. A combination of foam and fluid-filled bladder cushions are also available.

Advances in seating technologies are constantly being sought. An alternative to the cushions described previously is the alternating pressure-relief system. These systems incorporate air-inflated cells which are inflated and deflated at regularly defined

intervals in order to completely relieve pressures from given areas for a period of time. During this time period, other areas will experience a greater amount of pressure. A significant drawback to this type of seating system is that concerns arise regarding the duration of the cycle and the pattern of relief.

The Total Contact Seat, which is briefly described in the article by Sember [2], is another option. Equipped with pneumatic devices, which sense pressures in the area of the ischial tuberosities, it dynamically maintains a pressure below 0.5 psi. The seat automatically readjusts to offset increased pressures that may be due to the movement of the occupant. Research performed by Gross et al. [5] was subsequently used to develop an 'Intelligent Seat' which is able to sense pressures at the body-seat interface using sensors placed underneath the upholstery. This particular seat is primarily used to optimize comfort and user fit, and not necessarily in the role of seating intervention for the elderly or those with disabilities.

Despite increased understanding regarding seating systems and the development of tools to aid in the design of cushions or seats, many clinicians agree that weight relief or decreasing the interface pressure is still essential in preventing pressure sores. People using a seating system are trained to weight shift following a prescribed program [14]. Due to the fact that many people with spinal cord injuries are unable to weight shift because of a lack of sensation in the buttocks and leg area, which prevents feelings of normal discomfort, a Wheelchair Patient Monitor (WPM) has been designed. This monitor detects patient weight shifts with the use of monitoring seat sensors and the resulting data are collected by a computer. The monitor, which can be attached to a

conventional wheelchair, includes a time based alarm that is set off when weight shifts have not occurred over a set period of time, reminding the patient to do so [6].

Research into the causes and effects of pressure sores and various seating systems has been extensive but there is still much more territory to investigate. According to Karg et al. [13], “despite these advances, there is still an urgent need for knowledge that will allow for the systematic design of support surfaces”. One aspect of sitting that has not been studied with great detail is how the center of pressure (COP) changes or migrates over an extended period of time. There has been some effort placed into understanding how the COP changes during standing. This research gives us a base with which to start when looking into how the body moves, perceptibly and seemingly imperceptibly, during extended periods of sitting. Understanding this migration may prove beneficial in gaining insight into the movement and weight shifting that goes on when people sit to redistribute pressure and relieve discomfort at the seat-buttocks interface.

1.3 Center of Pressure Migration During Standing

In a study performed by Marcos Duarte and Vladimir Zatsiorsky [15] at Penn State University, the nature of center of pressure (COP) migration during prolonged unconstrained standing was examined. Unlike previous work that looked at standing, which is cited in their research entitled Patterns of Center of Pressure Migration during Prolonged Unconstrained Standing (1999) [15], they assumed that COP migration was not stochastic (or random) in nature. Rather, they performed their research with the hypothesis that migration occurred with specific and consistent patterns.

At the outset, Duarte and Zatsiorsky [15] had four main objectives to accomplish via their research. They were: 1) describe patterns of COP migration; 2) develop software to detect COP migration patterns; 3) specify the parameters of computer algorithms and suggest a default classification procedure; and, 4) present descriptive statistics on the patterns of COP migration during prolonged unconstrained standing (PUS).

Ten healthy subjects participated in the study. They were asked to stand on a 40 x 90 cm force platform which was used to collect the COP data for each trial. Three trials were conducted with each subject on two separate occasions approximately a week apart. The first trial consisted of quiet stance for 40 seconds in which the subject was asked to remain still. The second trial was PUS for 31 minutes, with the first minute being discarded in the analysis to allow for the comfortable positioning of the subject. The third trial was the same as the first, consisting of quiet stance for 40 seconds. The first and third trials were performed to replicate previously performed experiments, however results from these trials were not presented.

Of particular interest within the study is the fact that during the second trial the subjects were allowed to change their posture at any time in order to remain as comfortable as possible.

Upon analysis of the data from the second set of trials, Duarte and Zatsiorsky [15] noted that three patterns of migration were consistently found. These patterns were identified as shifts, fidgets, and drifts. Subsequently, software was developed and default parameters were established within the program to identify the patterns.

1.4 Objectives

The primary objective of this study is to examine the center of pressure migration during prolonged unconstrained sitting and to determine if identifiable and consistent patterns occur. Secondary objectives are as follows: should these patterns occur, can they be identified manually and, subsequently, can these results be effectively identified via a previously developed computer program which will be modified for the purposes of this research. It is believed that COP migration patterns will be found during prolonged unconstrained sitting and that subsequent analysis will be able to be performed. Ultimately it is the goal of this research to better understand sitting and to make a contribution to furthering the knowledge of the dynamics involved in sitting.

1.5 Thesis Organization

The remaining chapters of this thesis are organized in the following manner. Chapter 2 describes the subject data for this research and the equipment used to obtain the center of pressure (COP) migration data. The experimental procedure and the treatment of the data are also discussed in detail. In Chapter 3 a preliminary analysis of the COP migration data is provided. This is followed by the description of the manual analysis procedure for identifying center of pressure migration patterns. The results from the manual analysis are examined. The computer analysis procedure for identifying COP migration patterns is presented in Chapter 4. The software is described and the algorithms used by the software to identify patterns are presented. In addition, the step-

by-step methodology for using the program is included along with details of the graphical user interface. To conclude the chapter, the computer analysis of the COP migration and subsequent results are presented and discussed. A comparison and discussion of the two pattern analysis procedures are presented in Chapter 5 along with concluding remarks about the findings of this research. Finally, recommendations for future work are found at the end of Chapter 5.

Chapter 2

Methodology and Experimental Procedure

2.1 Introduction

To date there has not been much research into how the center of pressure (COP) at the seat-buttocks interface moves or migrates over an extended period of time while someone is sitting. This chapter describes the methodology and experimental procedure used to obtain the center of pressure (COP) migration data during prolonged unconstrained sitting. The first section provides a brief overview of the force plate and software used in order to collect analyzable data. In support of the collected data, the equations used by the software to calculate the COP coordinates are briefly reviewed. Information specifically related to the subjects who volunteered for this research follows. The final sections provide a description of the experimental procedure and the method of data analysis. This includes the setup of the apparatus, the instructions given to each of the subjects, the data collection procedure, and how the data were analyzed after collection.

2.2 Equipment

Portable Multicomponent Force Plate for Biomechanics: the force data used to calculate the COP coordinates was collected with a Kistler multicomponent force plate, type 9286AA (Kistler Instrumente AG Winterthur, CH-8408 Winterthur, Switzerland).

This particular model of the force plate uses an external 8 channel amplifier, type 5606A. The force plate consists of an aluminum top, covered by a linoleum overlay, with four 3-component force sensors. The three force components in each sensor include the pressure in the Z-direction (compression) and the shear forces in both the X- and Y-directions, respectively. The force plate and corresponding force component directions are shown in Figure 2.1.

BioWare Biomechanical Software Analysis System [22]: this is a software package that can be easily setup to record and display reaction forces, moments and center of pressure coordinates on the contact surface. The Bioware software (version 3.21) data acquisition and manipulation program was used in conjunction with the Kistler force plate. The Real time COP data acquisition tool was utilized to collect the migration coordinates of the COP.

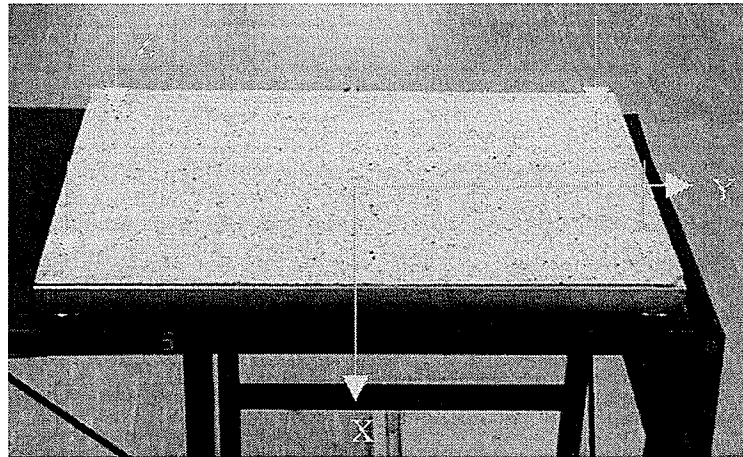

Figure 2.1- Kistler Portable Multicomponent Force Plate.

Calculation of the COP is performed internally by the software. The x-coordinate of the COP (a_x) is calculated by dividing the negative value of the plate moment about the top of the plate surface (y-axis) by the vertical force. The y-coordinate of the COP

(ay) is calculated by dividing the plate moment about the top of the plate surface (x-axis) by the vertical force. Figure 2.2 provides a visual representation of the coordinate system of the Kistler force plate and the equations are also shown.

The equations are as follows:

$a_x =$ the X-coordinate of force application (COP) = $-M_y' / F_z$ (Equation 2.1)

where: $-M_y' =$ plate moment about top of plate surface = $(F_x * a_0 - M_y)$ (Eq. 2.2)

and $F_x = f_{x12} + f_{x34}$, the anterior-posterior force (Eq. 2.3)

$a_{z0} =$ the distance from the plate surface to the Y-plane

$M_y =$ the plate moment about the Y-axis

where $M_y = a * (-f_{z1} + f_{z2} + f_{z3} - f_{z4})$ (Eq. 2.4)

and $a =$ the distance from the vertical z force to the Y-axis

$f_z =$ the vertical forces in the z-direction

$F_z =$ sum total of the vertical forces in the z-direction

$a_y =$ the Y-coordinate of force application (COP) = M_x' / F_z (Eq. 2.5)

where: $M_x' =$ plate moment about top of plate surface = $(F_y * a_0 + M_x)$ (Eq. 2.6)

and $F_y = f_{y14} + f_{y23}$, the medial-lateral force (Eq. 2.7)

$M_x =$ the plate moment the X-axis

where $M_x = b * (f_{z1} + f_{z2} - f_{z3} - f_{z4})$ (Eq. 2.8)

and $b =$ the distance from the vertical z force to the X-axis

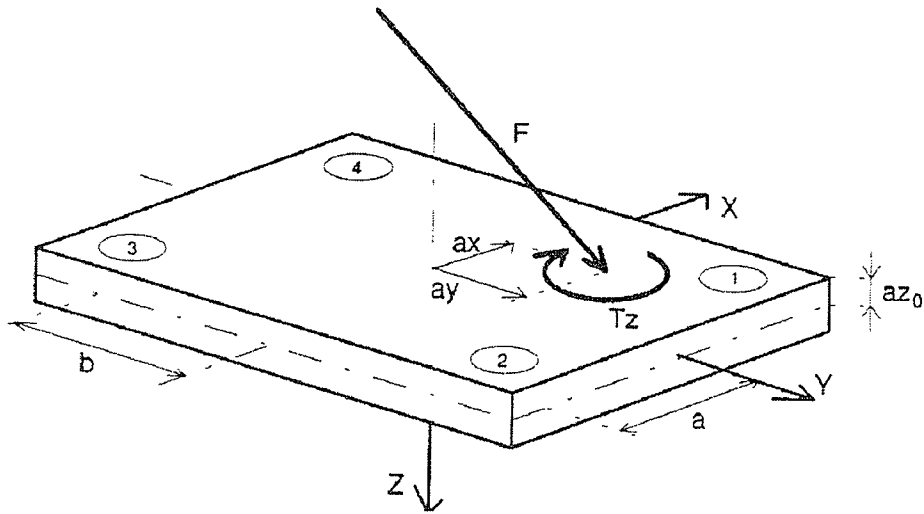

Figure 2.2 – The Kistler Force Plate Coordinate System [22]

2.3 Subject Data

Fifteen subjects (ten males and five females) with intact motion and sensation were personally contacted to participate in this study. Due to technical difficulties, the usable subject data was subsequently reduced to twelve (seven males and five females). Despite differences in pelvic structures between males and females, the data were combined in order to achieve a sample of convenience. Ethical approval for this study was received by the Committee on Research Involving Human Subjects (Faculty of Physical Education and Recreational Studies, University of Manitoba). An unsigned copy of the consent form may be found in Appendix F. The subjects ranged in age from 20 to 28 years (mean 22.9, SD 2.23). Their mean height was 173.9 cm (SD 7.89 cm) and their mean weight was 67.3 kg (SD 7.2 kg). Subjects had no prior knowledge of the purpose of the experiment prior to taking part and completing their seating trial.

2.4 Experimental Procedure

The Kistler force plate was placed on a flat, level table and was used as a seating platform. A backrest, armrests, or footrests were not used in an initial trial in which three individuals took part. The Real time COP program, which collects and displays the center of pressure data in real time, was started before the force plate was loaded. Each subject was asked to sit in the middle of the force plate and data was collected for a 30 minute trial. It was determined during the data acquisition and subsequent analysis of the COP vs. time that free swinging legs greatly altered the resultant reading of the COP migration. Therefore, in subsequent trials, a footrest was used to eliminate this problem. It should be noted that the data from the three preliminary subjects was not used and subsequently they are not included as part of the data analysis. Again, armrests and a backrest were not used in an effort to observe the COP migration due primarily to the loading at the buttocks/force plate interface.

In the same manner as the three initial trials (without the footrest), the Real time COP program was started and COP data was collected. The foot rest was placed so that each subject began the trial with a knee angle of approximately 110° and a hip angle of approximately 90° . Data acquisition was started, but data were not collected until the subject had indicated that he/she was comfortable on the force plate. Subjects were not given any instruction on how they were to sit. They were allowed to move freely, adjusting position and posture, in order to remain as comfortable as possible. Subjects were told that once data collection was underway they were required not to remove themselves from the force plate and at least one of their feet must remain resting on the footrest. Figures 2.2 and 2.3 show the subject sitting on the force plate. Subjects were

allowed to converse with someone in the room, read a book, or listen to music during the acquisition of COP data.

The data were collected in 1½ minute intervals, at a frequency of 5 Hz, and transferred to an Excel spreadsheet, completing the 30 minute trial. Center of pressure values were collected in the X-Y plane, with the X axis corresponding to the anterior-posterior (a-p) directions and the Y axis corresponding to the medial-lateral (m-l) directions.

2.5 Method of Data Analysis

The graphing tool in Excel was used to create plots of the COP migration data. Data for both the anterior-posterior (a-p) and medial-lateral (m-l) directions were plotted versus time on separate graphs. A plot of the entire trial (1800 seconds) was created for each subject (Appendix A). To view the plotted data more clearly, time segments of 180 seconds were plotted, creating twenty-two graphs for each subject. Plots were also created of the a-p data versus the m-l data to get a sense of each subject's COP migration over the seating surface for the entire 30 minute trial. Each plot was visually analyzed to determine if any consistent patterns could be identified.

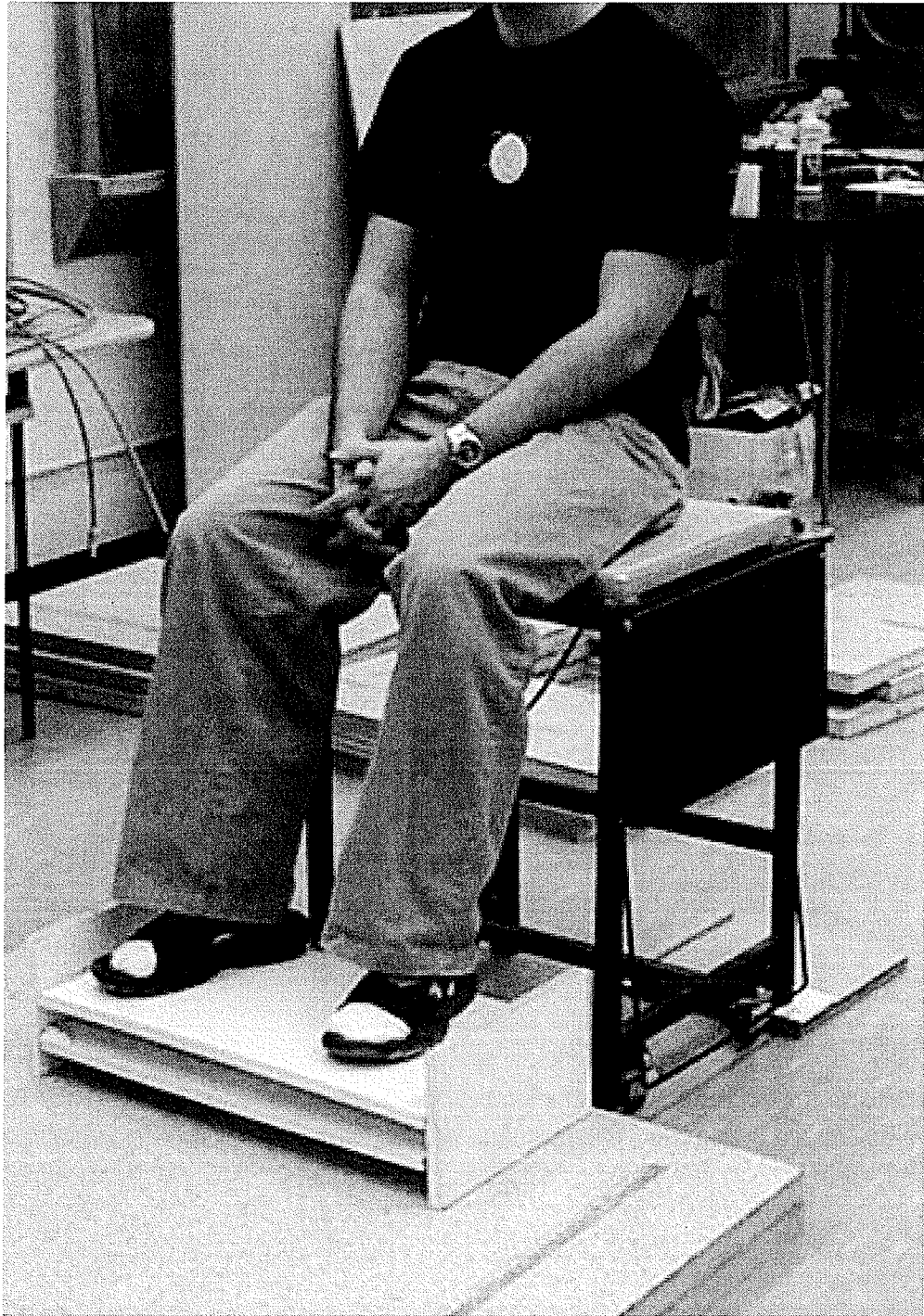

Figure 2.3 – Frontal View of the Experimental Apparatus.

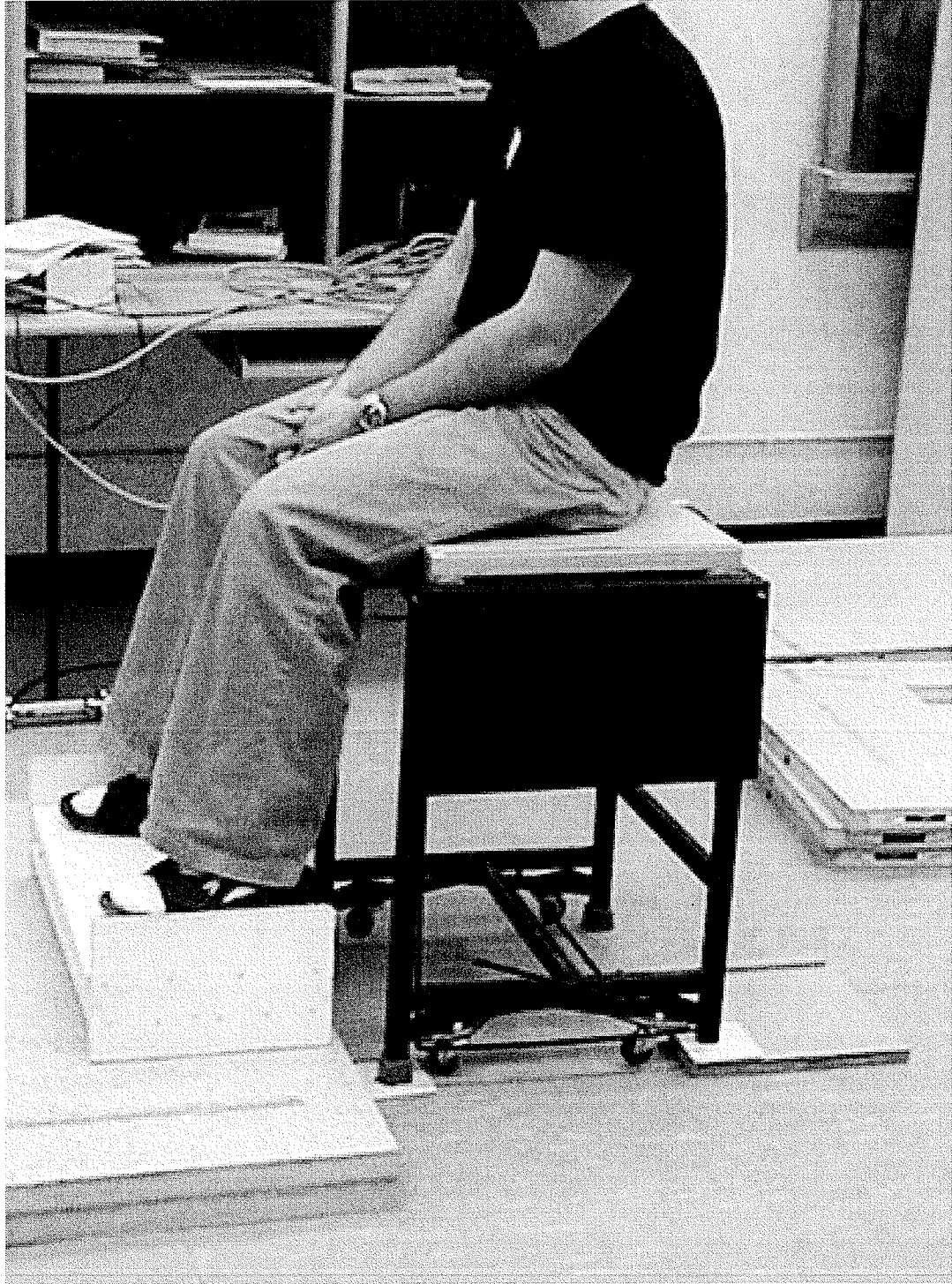

Figure 2.4 – Side View of the Experimental Apparatus.

Chapter 3

Manual Analysis and Results

3.1 Introduction

The chapter begins by presenting the findings from the preliminary analysis of the plotted center of pressure data.

Following the initial identification of COP migration patterns it is necessary to complete a more in-depth analysis of the plotted data. Within this chapter a manual analysis procedure for identifying the COP migration patterns is described. An order system is presented which allows for the systematic identification and classification of patterns.

The third section provides the results of the manual analysis. This includes statistical information corresponding to the identified patterns, as well as the average frequency of occurrence for each pattern.

3.2 Preliminary Findings

As a result of the data acquisition and preliminary analysis it has been determined that COP migration patterns do exist during prolonged unconstrained sitting. While the migrations of the COP in both the anterior-posterior and medial-lateral directions for each

subject are quite different, three distinct patterns can be identified when plots of the COP migration versus time are examined. The patterns are identified as follows: 1) shifting – a fast displacement of the average position of the COP from one region to another. It is step-like in nature. 2) fidgeting – a fast and large displacement and returning of the COP to approximately the same position. It appears as a spike in the COP migration. 3) Drifting – a slow, continuous displacement of the average position of the COP. This pattern is ramp-like in nature. An example of each of these patterns can be seen in Figure 3.1.

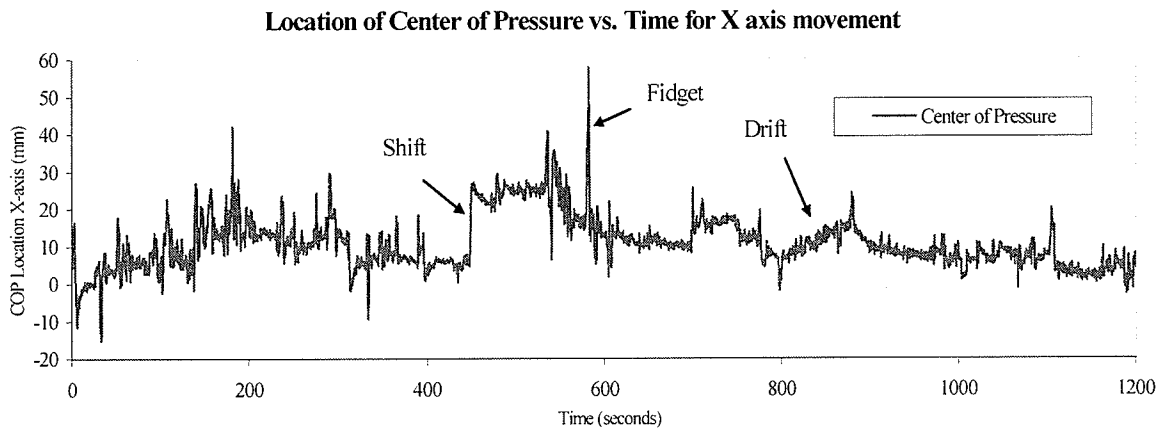

Figure 3.1 – Identifiable Patterns During COP Migration.

3.3 Manual Analysis Methodology

Manual analysis of the data was performed for two purposes: 1) to quantify the occurrence of patterns within the acquired COP data; and 2) to gather pattern identification information which would be compared to the results given subsequently when using the software to identify migration patterns.

The raw COP data was initially filtered using a low-pass Butterworth filter with a cut-off frequency of 2 Hz. Cut-off frequencies of 1.5 Hz and 2.5 Hz were also tested,

however the 2 Hz cut-off frequency provided a smooth representation of the data without eliminating the identifiable patterns, making it easier for pattern identification and classification. At 1.5 Hz the data was smoothed extensively by the filter while at 2.5 Hz the data still closely resembled the raw data. The filter and cut-off frequency were identical to those used in the computer program in order to ensure that analysis occurred on the same data.

To simplify the manual identification process, a four order system of classification was developed with varying parameters. A review of the literature did not identify an established method by which COP migration patterns could be manually identified. These parameters were created by the investigator. The parameters were created at the investigators discretion in order to identify all appropriate patterns. Patterns considered first, second, or third order were more easily identifiable as a rule. Fourth order patterns were those patterns that were questionable or more difficult to classify. Table 3.1 outlines the four orders and their associated parameters. The amplitude of the pattern refers to the height of the pattern from its origin to its highest point. Length of the pattern refers to the duration of the pattern from beginning to end.

After defining the pattern parameters, examination of the filtered data plots was undertaken. Pattern parameters were established to retain objectivity during the classification of identified patterns. In select situations, however, an interpretation of the COP plot became necessary. A certain level of subjectivity does affect some aspects of the manual identification process. This was especially true within the fourth-order patterns. For example, the patterns identified as fourth-order patterns include those

which appeared as though they may be identified as either one fidget or two shifts or those where there are combinations of patterns occurring simultaneously.

Table 3.1 – COP Pattern Manual Identification Order Parameters

ORDER	PATTERN PARAMETERS		
	SHIFT	FIDGET	DRIFT
1 st Order	amplitude > 20 mm	amplitude > 30 mm	length > 60 seconds amplitude 5 mm
2 nd Order	10 mm ampl. 20 mm	15 mm ampl. 30 mm	30sec. length 60sec. amplitude 5 mm
3 rd Order	5 mm ampl. < 10 mm	10 mm ampl. < 15 mm	Not applicable
4 th Order	amplitude 5 mm	amplitude 10 mm	Not applicable

In an effort to align the manual analysis, which is observation-based, with the computer analysis, which is mathematically-based, some characteristics or guidelines for pattern identification were borrowed from the default settings of the program. For example, the maximum width of a fidget (in units of time) should not exceed 4 seconds, or the maximum shift width (in units of time) should not exceed 5 seconds. These parameters, while not explicitly included in the manual analysis order parameters, were nonetheless followed when classifying patterns.

Data sheets were created and each identified pattern was recorded, along with its approximate time of occurrence and a brief description. The description incorporated the approximate amplitude of the pattern as well as the start and finish points where applicable. Other remarks that may have been necessary to adequately explain what was seen or why the pattern was classified as it was were included where appropriate.

The manual analysis was completed in a systematic manner for all twelve subjects, X and Y plots inclusive, and for all four pattern parameter orders. The patterns were identified sequentially beginning with the first order and concluding with the fourth order.

To ensure a high degree of accuracy in the COP migration pattern identification, the entire completed manual analysis (all data sets) was reviewed and scrutinized by the same investigator. During this process, some patterns that may have been missed were identified, while others, upon a second look, may have been reclassified appropriately. Others still may have been disregarded. The occurrences of each pattern were tabulated for each subject in the manual analysis for future comparison with the results from the computer analysis.

3.4 Results

Manual result data tables for each subject were completed and an example is presented in Table 3.2. The first column presents the approximate time at which the identified pattern occurred along with the order that the pattern falls under. The second column provides a brief description of the pattern, including the type of pattern and its amplitude, and its maximum and minimum values. Data tables for all of the subjects may be found in Appendix B. In general, all three patterns were observed in each of the subject's COP migrations. The exception to this is where drifting was seen in only one of the plots, either the X or Y data, for four subjects. Pattern occurrences for each subject are tabulated in tables in Appendix D.

Tables 3.3, 3.4, and 3.5 provide statistical information pertaining to the average occurrences for each pattern in both the x- and y-directions independently, as well as the combined information. The average number of patterns found per subject and the associated standard deviations are recorded for each order individually and then as a total.

The average number of shifts occurring in the x-direction (anterior-posterior direction) for all subjects was 27.17 ± 12.99 SD while in the y-direction (medial-lateral direction) the average number of shifts was 16.00 ± 8.97 SD. The average number of shifts per subject in both directions was 43.17 ± 19.44 SD. Fidgets occurred in the anterior-posterior direction on average 13.17 ± 7.60 SD times and in the medial-lateral direction an average of 14.58 ± 10.35 SD times per subject. For an entire trial, (i.e. the anterior-posterior and medial-lateral directions combined) there was an average of 27.75 ± 14.98 SD fidgets. On average, there were 2.75 ± 1.86 drifts in the anterior-posterior direction per subject and 2.25 ± 2.18 SD drifts in the medial-lateral direction per subject.

An alternate way of viewing the incidence of each pattern is that a shift occurred on average every 88 ± 69 seconds in the anterior-posterior direction and every 152 ± 90 seconds in the medial-lateral direction for each subject. A fidget occurred every 321 ± 490 seconds in the anterior-posterior direction and every 226 ± 204 seconds in the medial-lateral direction. In the case of drifts, as previously stated, in the a-p direction there was one trial in which no drift was identified and in the m-l direction there were three trials in which no drift was identified. Of the remaining 11 trials in the a-p direction a drift occurred on average every 884 ± 611 seconds. A drift occurred in the remaining nine trials in the m-l direction on average every 885 ± 572 seconds. These values are the averages taken over the entire subject population. It is recognized that the standard

deviations for all of the average values are quite high. This is the result of the large differences in the occurrences of patterns for each subject. This would be one explanation as to why there is such a variety in the number of occurrences of each pattern, leading to the high standard deviations. In addition to this, the force plate itself was a hard, flat surface. Unlike most chairs today, it was a great deal more uncomfortable to sit on. Due to the correlation that is made between discomfort and the movement of the body during sitting, the pain threshold of each subject also becomes a factor which leads to differences in the number of occurrences of each pattern. Someone who has a higher pain threshold will adjust their position less due to discomfort than someone who has a lower tolerance of discomfort.

Through the manual identification of COP migration patterns it was found that shifting was the most prevalent pattern observed on average in each trial for both the a-p and m-l directions. These shifts are most likely as a result of a subject adjusting leg or arm position while seated on the force plate. Drifting was found to be the least prevalent pattern identified. It is also apparent from these data that these subjects tended to shift forwards and backwards more than they did side-to-side. The actual values of identified shifts and fidgets, as seen in Appendix D, did tend to vary quite dramatically between subjects. This was not evident for drifts as the pattern was not identified as frequently as shifting or fidgeting.

Table 3.2 – Manual Analysis Data Sheet Sample for Subject 1X

Subject - 1X	Manual Pattern Identification Chart
Identifiable Patterns	
Approximate Time (seconds)	Pattern Description
1st order - 231	Shift - approximate amplitude of 35 mm (0 to -35)
241	Shift - approximate amplitude of 33 mm (-28 to 5)
270 - 425	Drift - approximate amplitude of 14 mm (-17 to -3)
733 - 1000	Drift - approximate amplitude of 14 mm (-15 to -1)
850	Fidget - approximate amplitude of 32 mm (-10 to 22)
2nd order - 8	Fidget - approximate amplitude of 19 mm (-10 to -29)
37	Fidget - approximate amplitude of 21 mm (-10 to -31)
223	Fidget - approximate amplitude of 21 mm (1 to 22)
445	Shift - approximate amplitude of 15 mm (-4 to -19)
1063	Shift - approximate amplitude of 16 mm (35 to 19) - actual amplitude may be less
1169	Shift - approximate amplitude of 16 mm (25 to 41)
1600	Shift - approximate amplitude of 13 mm (33 to 20) - with overshoot of approximately 10 mm at end of shift
3rd order - 75	Fidget - approximate amplitude of 14 mm (-19 to -33)
1564	Shift - approximate amplitude of 8 mm (30 to 22)
1657	Shift - approximate amplitude of 8 mm (23 to 31)
1662	Shift - approximate amplitude of 9 mm (31 to 22)
4th order - 125	Shift - approximate amplitude of 10 mm (-13 to -3) -prior to shift or as part of shift there is a large fidget (down) 51 mm in amplitude followed by reaction upward
197 (3 possible patterns)	Fidget - approximate amplitude of 60 mm (-5 to 55) followed by fidget downward at amplitude of 46 mm (-5 to 51) then followed by possible shift of amplitude of 19 mm (-5 to 14)
479	Shift - approximate amplitude of 10 mm (-10 to 0) shift begins with spike up (fidget-like) before settling at average COP value of 0
1117 1529 to 1565	Shift - approximate amplitude of 26 mm (31 to 5) Shifts - step-like in appearance, which if smoothed slightly would appear as a drift, total approximate amplitude of 10 mm (20 to 30) (2 shifts or 1 drift)

Table 3.3 – Statistical Data of Shifting per Subject

NUMBER OF SHIFTS						
	TOTAL		X-Direction Only		Y-Direction Only	
	Average # of Shifts	Standard Deviation	Average # of Shifts	Standard Deviation	Average # of Shifts	Standard Deviation
1 st order	4.67	6.28	3.92	4.44	0.75	2.30
2 nd order	12.83	7.40	8.17	6.09	4.67	3.47
3 rd order	14.92	7.38	8.08	5.37	6.83	3.35
4 th order	10.75	7.61	7.00	5.13	3.75	4.00
Total	43.17	19.44	27.17	12.99	16.00	8.97

Table 3.4 – Statistical Data of Fidgeting per Subject

NUMBER OF FIDGETS						
	TOTAL		X-Direction Only		Y-Direction Only	
	Average # of Fidgets	Standard Deviation	Average # of Fidgets	Standard Deviation	Average # of Fidgets	Standard Deviation
1 st order	3.08	2.97	1.58	1.83	1.50	1.68
2 nd order	9.25	5.51	4.58	2.91	4.67	3.65
3 rd order	7.25	4.18	3.25	3.05	4.00	2.66
4 th order	8.17	6.38	3.75	2.86	4.42	5.00
Total	27.75	14.98	13.17	7.60	14.58	10.35

Table 3.5 – Statistical Data of Drifting per Subject

NUMBER OF DRIFTS						
	TOTAL		X-Direction Only		Y-Direction Only	
	Average # of Drifts	Standard Deviation	Average # of Drifts	Standard Deviation	Average # of Drifts	Standard Deviation
1 st order	1.92	1.51	1.33	1.07	0.58	0.69
2 nd order	3.08	2.61	1.42	1.44	1.67	1.78
Total	5.00	3.46	2.75	1.86	2.25	2.18

Chapter 4

Computer Analysis and Results

4.1 Introduction

In the following chapter the computer analysis and results are presented. The first section provides a brief overview of the software developed by Marcos Duarte and Vladimir Zatsiorsky [15] which was used to identify the center of pressure migration patterns. This includes the algorithms within the program that are used to identify each pattern.

The next section contains the step-by-step procedure that is used to input text files into the graphical user interface of the software and details of how to set up the interface to identify patterns. Following that is a section on the methodology used in determining the parameters used to identify the COP migration patterns and the parameters decided upon for pattern identification using the software.

Results of the computer analysis are presented and discussed within the final section of the chapter.

4.2 Program Description

A program, created using MATLAB 5.1 was used for the computer identification of the COP migration patterns. The data filters within the software were modified for the purposes of this research. This program was developed by Marcos Duarte and Vladimir Zatsiorsky [15] for their studies on COP migration during standing. The graphical user interface of the software plots the selected data and allows for the selection of identification parameters which suit the user's needs. The pattern identification algorithms used in the program to identify the three COP patterns are described below.

- 1) Shifting – average values of the COP data for two consecutive moving windows were compared to determine if a shift was present. If the following equation was satisfied by any two consecutive moving windows, separated by the period W_s , a shift was identified. The variable W_s is the estimated width of the shift and is input manually into the identification program by the user.

$$\left| \frac{\bar{X}_{W_1} - \bar{X}_{W_2}}{\sqrt{SD_{W_1}^2 + SD_{W_2}^2}} \right| \geq f_{shift} \quad (\text{Equation 4.1})$$

Where: \bar{X}_{W_1} and \bar{X}_{W_2} are the average values of the COP for two consecutive moving windows W_1 and W_2 .

SD_{W_1} and SD_{W_2} are the standard deviation values of the two consecutive moving windows.

f_{shift} is the threshold value of the shift amplitude (in units of $SD_{W_1} + SD_{W_2}$).

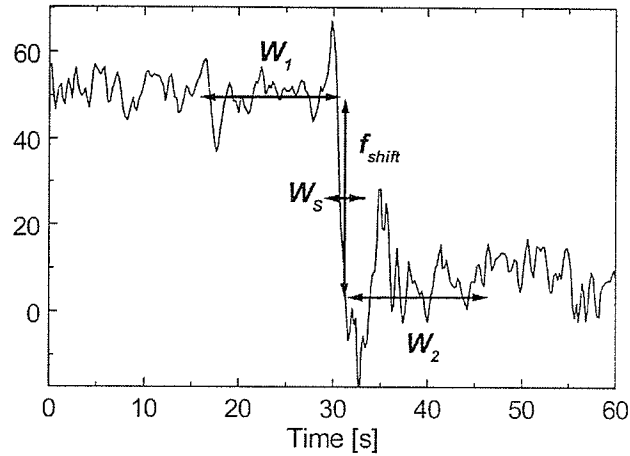

Figure 4.1 – Diagram of Shift Identification [15]

- 2) Fidgeting – a peak value of the COP is compared with the average of a window centered at the peak. If the following equation is satisfied by any peak or valley then it is classified as a fidget.

$$\left| \frac{x_f - \bar{x}_w}{SD_w} \right| \geq f_{fidget} \quad (\text{Equation 4.2})$$

Where: x_f is the amplitude of the COP peak or valley.

\bar{x}_w is the average value of the COP data in the window, W .

SD_w is the standard deviation of the COP data in the window, W .

f_{fidget} is the threshold value for the amplitude of the fidget.

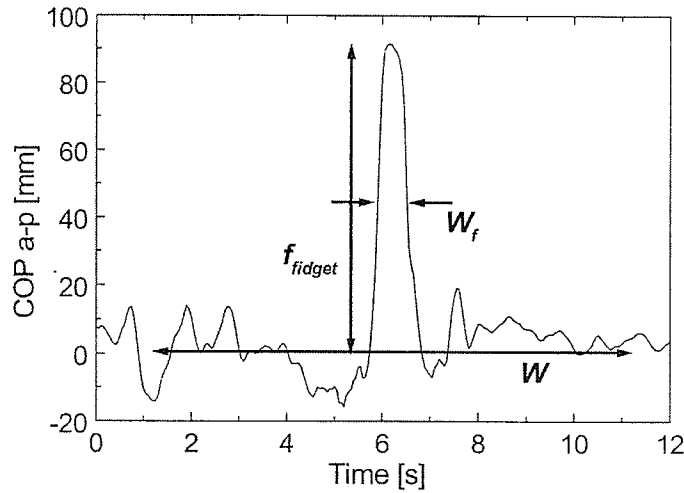

Figure 4.2 – Diagram of Fidget Identification [15]

The maximum width of a fidget, W_f , is also a parameter that needs to be satisfied and is set by the user. The program estimates this width as the full width at half maximum (FWHM).

- 3) Drifting – for the identification of drifting, the data between two shifts is smoothed using a low-pass, variable cut-off frequency filter. The cut-off frequency is $F_C = 1/2W_D$, where W_D is the minimum drift width as pre-selected by the user. When the following equation for drift identification is satisfied and the minimum length of the drift, W_D , is met, the COP migration is classified as a drift.

$$\left| \frac{X_{\max} - X_{\min}}{SD_W} \right| \geq f_{DRIFT} \quad (\text{Equation 4.3})$$

Where: X_{\max} is the local maximum.

X_{\min} is the local minimum.

SD_W is the standard deviation in the window containing the data between the maximum and minimum values.

f_{DRIFT} is the threshold value of the drift amplitude as pre-selected by the user.

W_D is the minimum drift length and is input by the user.

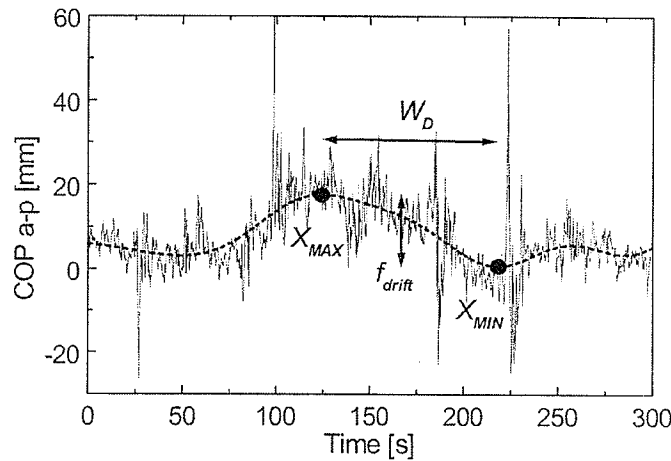

Figure 4.3 – Diagram of Drift Identification [15]

Essentially, when the difference in amplitude of a maximum and minimum, occurring consecutively, satisfies the above equation a drift is identified in the COP migration data.

In the initial documentation by Duarte and Zatsiorsky [15], a coefficient of variation (CV) is defined. However, the selection of this value has very little or no affect on the classification of drifts, therefore it was not mentioned in detail in this section as an identification parameter. This decision was based upon observations during the tuning of

the pattern parameters. The tuning process for this research is described in further detail in Section 4.4.

4.3 Pattern Identification Software

The following section includes a detailed description of how to use the software created by Duarte and Zatsiorsky [15] to identify the patterns within the center of pressure migration. The data for each subject were transferred from Excel into individual text files for computer analysis. The data in each file were set up in three columns, the first column labelled time, the second was the COP migration in the X-direction, and the third was the COP in the Y-direction. Data must be set up in columns in order for the software to read the information correctly. The procedure for data importing and analysis is as follows:

- 1) Open the Matlab command window and select 'Open File' from the File menu and select the file posttool.m. The Matlab Editor/Debugger screen opens a new window, displaying the posttool program.

- 2) From the Tools menu select Run. On the Command Window a message appears with a description of the posttool file and a prompt to "Press Any Key to Start".

- 3) Pressing a key, the graphical user interface (GUI) is opened. Figure 4.1 shows the GUI as it is opened. This is the environment into which data is imported and pattern identification occurs.

- 4) To import a data or text file, click on the import button which is located in the upper right hand corner of the GUI. This opens a dialogue window called 'Import to Posttool'. Using the options within this box a file can be imported from a workspace or

disk. Depending on the columns within the data file, the sampling frequency can be set within the window or if there is a column for time within the data file, then the sampling frequency box can be unchecked and the appropriate column can be labelled time. The columns associated with the COP migration data, within the data file, can be labelled also. For this study, column 1 was labelled Time, column 2 was labelled COPx and column 3 was labelled COPy. One final option is the ability to change the units associated with the distance, force, and COP coordinates.

5) Click on “No Time Column” to deselect this option. Within the Columns section of the window type in the column names accordingly. The units for distance remained in meters, force in Newtons, and the COP in mm.

6) Ensuring that ‘From Disk’ is selected, click on ‘Browse’ to open the appropriate data file. An open window appears from which to select the file to be analyzed. ‘All Files’ may have to be selected in the ‘Files of Type’ drop down menu when importing a text file.

7) Click on the file to be analyzed to highlight it and click on ‘Open’. The ‘Open File’ window closes and the ‘Import to Posttool’ window remains. Select ‘Okay’ to proceed.

8) On the GUI, the X-axis and Y-axis pull down menus are now available for use. In Figure 4.2, the X- and Y-axis menus display Time and COPx, respectively. Below these menus the xmin (or starting time of the plot) and xmax (end time of the plot) are shown.

9) To show the plot of the COPx data (or the anterior-posterior migration of the COP) vs. time, click on the ‘Show’ button. The plot appears. The COPx data and scale

appear along the y-axis of the plot and the time data appears along the x-axis.

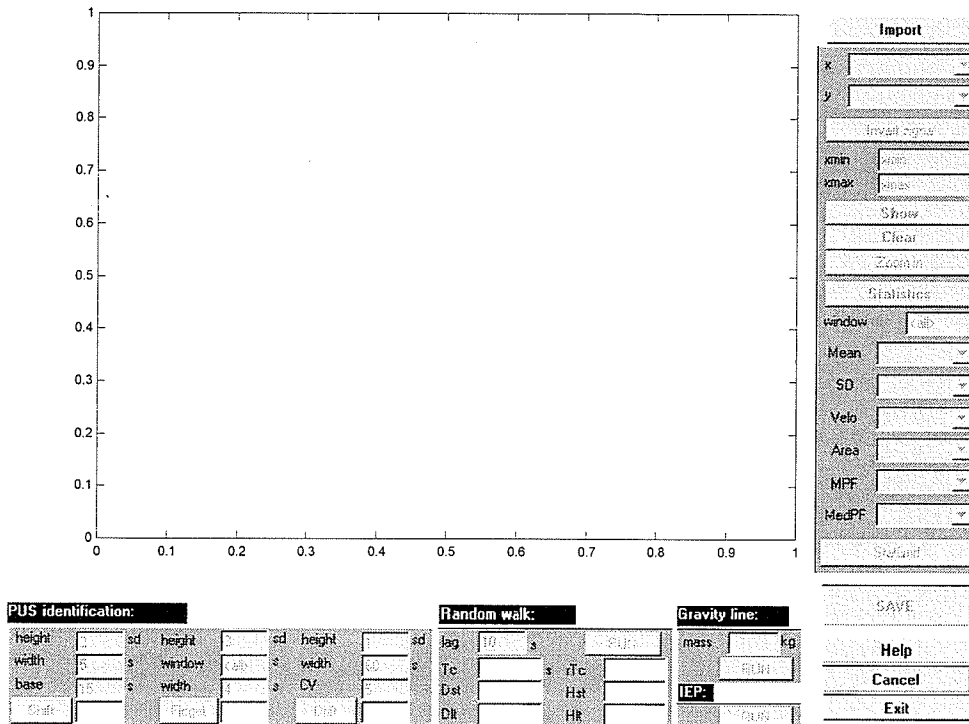

Figure 4.4 – Graphical User Interface for Pattern Identification Software

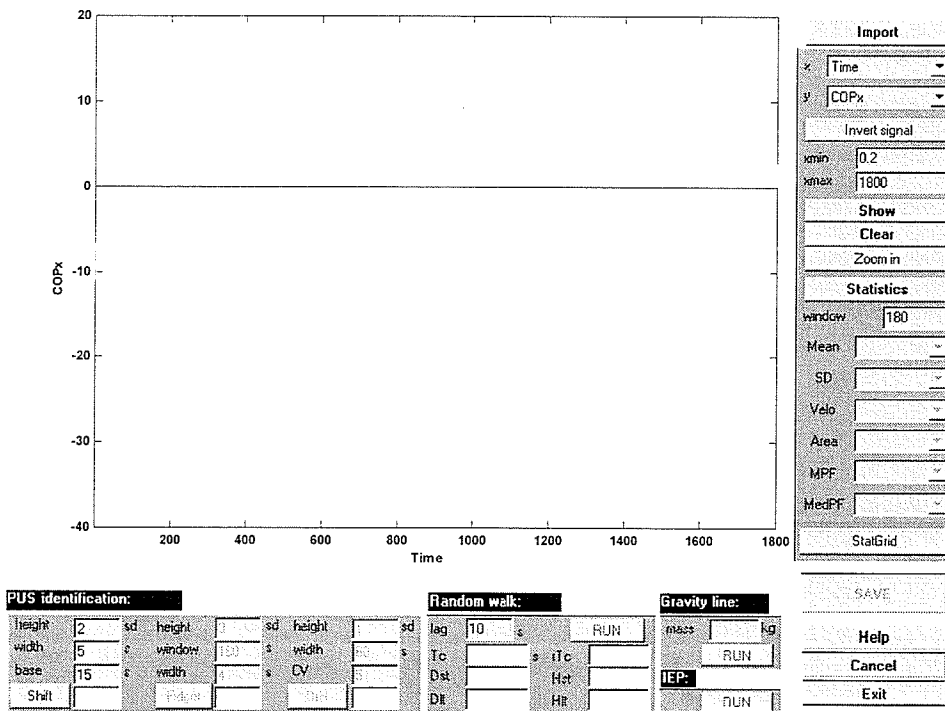

Figure 4.5 – GUI with plotted COP Data.

10) To determine the number of shifts identified by the software, set the three shift parameters, found in the lower left corner, accordingly. In Figure 4.3 for example these values are set at a height of 2 SD, a shift width of 5 seconds, and a window length of 15 seconds. Click on the 'Shift' button and the number of identified shifts appears in the box beside this button. The identified shifts will also appear on the plot. It should be noted that shifts are found prior to fidgets or drifts due to the identification algorithms used by the software. In Figure 4.3 the shifts appear as blue lines.

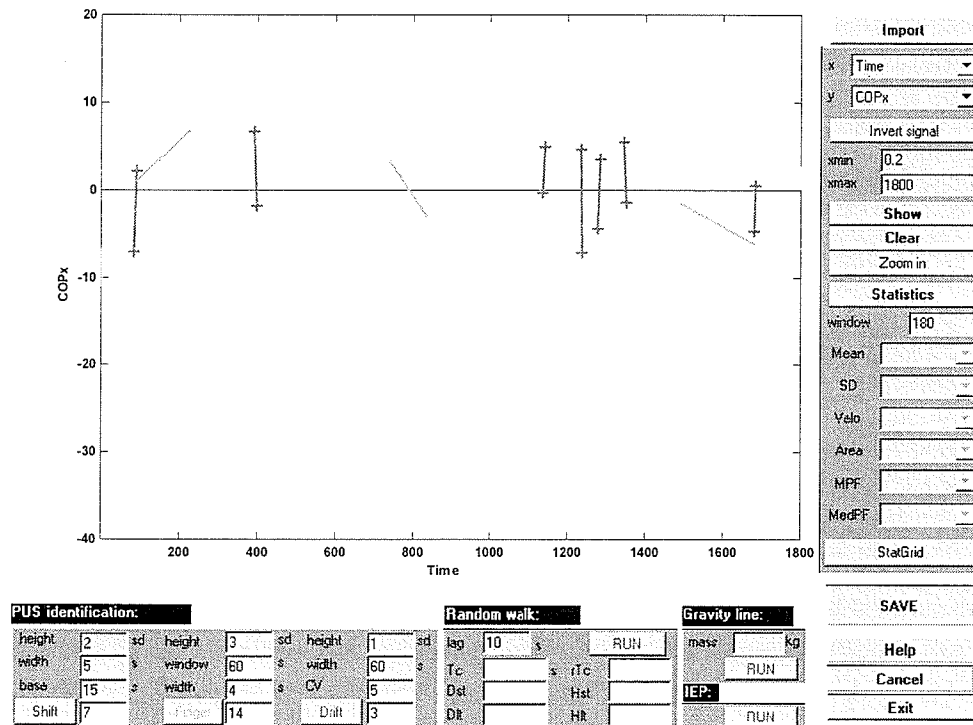

Figure 4.6 – GUI with Identified Patterns

11) Following a similar procedure, enter the fidget parameters and click on 'Fidget'. The fidgets appear as green asterisks, as seen in Figure 4.3. Again, the number of identified fidgets appears in a box to the right of the 'Fidget' button.

12) Drift identification is similar to that of the shift and fidget. Input the appropriate drift parameters, click on 'Drift' and the drifts appear as red lines, as seen in Figure 4.3.

13) To view a segment of the data three options are available. This first option is to click on the 'Zoom In' button on the right side of the GUI. A second option is to use the left and right buttons on the mouse. Placing the cursor on the plot and clicking on the left button will zoom in on the plot, while clicking on the right button will zoom back out. The third option is to change the values in the xmin and xmax boxes and then click on 'Show'. The new plot will be shown. When following the third option, it may be beneficial to clear the plot from the screen first, then enter the new values for the time (x) axis, and then repeat steps 10 – 12 to identify the patterns. This prevents the plot from becoming congested with previous plotted data.

14) To view the COP along the Y-axis, or medial-lateral direction, of the force plate, clear the plot currently on the GUI (if necessary), by selecting the 'Clear' button. From the y-axis pull down menu at the top right corner of the GUI select COPy. Once selected, select 'Show' and the COPy data will be plotted.

15) To exit the GUI, simply click on 'Exit' in the lower right hand corner of the interface.

Of further interest may be the 'Stat grid' option, located on the right hand side of the GUI. Turning this feature on allows for easier approximation of the occurrence time of a pattern, as well as pertinent amplitudes and durations. To employ the grid simply click on 'Stat grid on' and the grid will appear on the plot. Click on the same button to turn the grid off.

Plotted images may be saved or exported into a number of formats by clicking on the File menu and selecting either 'Save as' or 'Export'. Other options are available within the GUI under the Tools menu, however these were not used during this research.

4.4 Computer Analysis

A Matlab program, originally created by Duarte and Zatsiorsky [15], was modified and used to filter the COP data. The sampling rate was restricted to 5 Hz because of limitations within the software. It was felt that due to the nature of sitting, the 5 Hz sampling rate would be adequate for collecting the data. Due to the different sampling rate used for the current research compared to the research conducted by Duarte and Zatsiorsky [15], the filter within the software was modified to ensure appropriate filtered results. A fourth-order Butterworth filter, with a cut-off frequency of 2 Hz, was chosen. These filtered data were then re-plotted versus time.

A systematic approach was taken for this computer analysis. In addition to the modifications performed to the software itself, there was also a need to tune the identification parameters associated with each pattern.

Two parameters were changed systematically to determine default parameters for shift identification in the analysis of the COP migration during sitting. These parameters were the shift threshold (± 1.0 , ± 1.5 , ± 2.0 , ± 2.5 , and ± 3.0 SD) and the length of the moving windows W_1 and W_2 (15, 30, and 60 seconds). Tables for the resultant data can be found in Appendix E. Once the number of shifts was recorded for each instance it was decided that a window length of 15 seconds would be used as the first parameter. This decision was based upon the fact that as the moving window length increased, fewer

shifts were identified. Subsequently, the number of shifts identified using a window length of 15 seconds were compared to the number of shifts obtained from the manual analysis in order to determine the appropriate shift threshold. The patterns classified as fourth order patterns in the manual identification process were excluded from the value used to compare with the computer identified value. For each subject the shift threshold value that corresponded with the number of shifts that was closest to the number of shifts identified manually was noted. After all subjects had been examined, and each shift threshold value was recorded, the average was found to determine the most appropriate shift threshold value. The actual value obtained via this process was a shift threshold of 1.8125 SD which was rounded up to ± 2.0 SD. The focus of this process was to compare the number of shift occurrences rather than actual shift occurrences. It was determined that the default values for the shift parameters were: a shift threshold of ± 2.0 SD, a window length of 15 seconds, and a maximum shift duration of 5.0 seconds.

This process was repeated with both the fidget and drift parameters. The fidget parameters altered were the fidget threshold value (± 1.0 , ± 2.0 , ± 2.5 , ± 3.0 , ± 3.5 , and ± 4.0 SD) and the window length (30, 60, 120, and 180 sec.). The values for the given window length values seemed to oscillate up and down. There was no real discernable pattern as there was with the window lengths associated with the shift identification (i.e. an increasing window length was associated with fewer identified shifts). A window length of 60 seconds was selected as the default parameter for the window length. Once this had been chosen, the values which corresponded with this window length and the varying threshold values were compared to the manual identification results (again excluding fourth order patterns). The average system was used and a value of 3.178 SD was

calculated, which was rounded down to 3.0 SD. Again, the focus of this process was to compare the number of identified fidgets and not the actual occurrences. Final default values decided upon were: a fidget threshold value of ± 3.0 SD, a window length of 60 seconds, and a maximum fidget width of 4 seconds.

The drift threshold, the length of the drift, and the coefficient of variation (CV) were all initially changed to determine default values. After analyzing the number of patterns found it was determined that the CV had very little effect on the number of detected drifts. This resulted in the program's default value remaining set at 5.0 units. After a few subsequent trials had been analyzed with this process it was determined that the drift threshold default value would be set at ± 1.0 SD. At greater values of the threshold, very few drifts were being identified. Although parameter tuning was performed with 30, 60, and 90 second intervals, the default value for the minimum drift length was set at 60 seconds following comparison with the manual results.

With the default values in place, each subject's data were again analyzed using the newly found default parameters. This time around each pattern was recorded along with its approximate time of occurrence on a data sheet.

4.5 Results

Data tables similar to those used for the manual analysis were created and completed for each subject. Two significant differences were found between manual identification and computer identification recorded data. They were: 1) that the computer identification was not based upon an order system, therefore this distinction was not made; and 2) the amplitudes of each identified pattern were not recorded (although this

does not affect the identification of the patterns). An example of the computer identification data table can be seen in Table 4.1. All three patterns were present in each trial for both directions with the exception of trial 12 in which there were no shifts identified in the m-l direction.

Table 4.2 provides statistical information pertaining to the computer identification of COP migration patterns. The average number of shifts per subject in the a-p direction was 16.50 ± 7.23 SD and the average number of shifts per subject in the m-l direction was 10.00 ± 6.54 SD. In the a-p direction a shift occurred on average every 130 ± 58 seconds and in the m-l direction a shift occurred on average every 324 ± 494 seconds (based upon 11 trials).

Fidgets occurred on average 9.00 ± 4.47 times per subject in the a-p direction and 16.67 ± 6.84 times per trial in the m-l direction. Comparatively, a fidget occurred on average every 293 ± 236 seconds in the a-p direction and 134 ± 83 seconds in the m-l direction.

There were on average 5.25 ± 2.18 drifts for each subject in the a-p direction and 3.92 ± 1.83 drifts in the m-l direction. In other words, a drift occurred on average every 410 ± 201 seconds in the a-p direction and every 603 ± 418 seconds in the m-l direction. Again, the calculated standard deviations are quite high.

As with the manual results, drifting was the least frequently occurring pattern of the three in the 12 trials. Shifting occurred more frequently in the a-p direction than in the m-l direction, however this was reversed with fidgeting as the subjects tended to fidget more medial-laterally than anterior-posteriorly.

Table 4.1 – Computer Identification Data Sheet

Comp. Analysis : Subject 1X
File Name: onecomplete

Shift Parameters	
Height:	2 SD
Width:	5 sec.
Base:	15 sec.

Fidget Parameters	
Height:	3 SD
Window:	60 sec.
Width:	4 sec.

Drift Parameters	
Height:	1 SD
Width:	60 sec.
CV:	5 sec.

#Shifts	12
---------	----

#Fidgets	6
----------	---

#Drifts	10
---------	----

Approximate Time:	Pattern:
0 to 125	Drift
125	Shift
126	Fidget
153	Shift
197 to 295	Drift
201	Fidget
204	Fidget
333	Shift
338 to 434	Drift
477	Shift
481	Fidget
482 to 544	Drift
720	Shift
774	Shift
780 to 968	Drift
968	Shift
972 to 1079	Drift

Approximate Time:	Pattern:
972 to 1079	Drift
1038	Fidget
1184	Fidget
1203	Shift
1266 to 1328	Drift
1328 to 1446	Drift
1446	Shift
1522	Shift
1601	Shift
1606 to 1694	Drift
1694	Shift
1694 to 1800	Drift

Table 4.2 – Statistical Data of Software Identified COP Migration Patterns

	SHIFTS		FIDGETS		DRIFTS	
	Average #/Trial	Standard Deviation	Average #/Trial	Standard Deviation	Average #/Trial	Standard Deviation
X-direction	16.50	7.23	9.00	4.47	5.25	2.18
Y-direction	10.00	6.54	16.67	6.84	3.92	1.83
Total	26.50	12.00	25.67	9.37	9.17	2.59

Chapter 5

Discussion, Conclusions and Future Work

5.1 Data Comparison and Discussion

One of the main objectives of this research is to determine the effectiveness of the computer software in identifying COP migration patterns. This is accomplished in part by comparing COP migration patterns found via manual identification procedures with those identified via the software developed by Duarte and Zatsiorsky [15].

Before comparing the findings of the manual identification process with the computer identification process it is important to keep in mind that the identification procedures and parameters differed slightly. The primary difference was that the manual identification process identified patterns at an instant in time at different amplitudes (pattern heights corresponding to orders, and duration of pattern for drifts), whereas the computerized process compared the COP migration values against a moving average. The computer software identified a pattern when it met or exceeded a minimum standard deviation value parameter when compared to the average value of the COP migration within the specified window. Another distinction was that the manual identification was based upon observations of the plotted COP, while the computer process made use of algorithms to identify patterns in the migration. This being said, it is still beneficial to compare the results of the two identification processes. This comparison will provide insight into the similarities and differences between the outcomes of the two

identification methods as well as providing useful information regarding the intricacies of the computer program and its ability to identify COP migration patterns. Table 5.1 displays the patterns identified by both the manual analysis and computer analysis for Subject 1. The table is set up such that the patterns appear cumulatively. That is to say that the number for the first order patterns includes only those patterns that were identified as first order. However, the number of second order patterns includes those patterns identified as second order as well as those that were identified as first order. Similarly, the number of third order patterns includes those patterns that were identified as third order patterns along with the previously identified first and second order patterns. Therefore the values provide a running total of the identified patterns. The value in the fourth order row is the total number of patterns identified in that direction for that subject. To determine the specific number of identified patterns for a particular order, simply subtract the previous order total from the value which you are looking at. For example, if you wanted to determine the number of third order patterns for Subject 1 (Direction X), subtract 14 from 17 to determine that there were 3 third order patterns identified.

Table 5.1 – Tabulated Results of Pattern Identification for Subject 1

Subject 1							
Direction: X	Pattern Occurrences			Direction: Y	Pattern Occurrences		
	Shifts	Fidgets	Drifts		Shifts	Fidgets	Drifts
Manual - 1st order	3	1	3	Manual - 1st order	1	4	1
Manual - 2nd order	14	6	3	Manual - 2nd order	5	7	2
Manual - 3rd order	17	7	3	Manual - 3rd order	13	8	2
Manual - 4th order	25	13	3	Manual - 4th order	14	10	2
Computer - inclusive	12	6	10	Computer - inclusive	6	8	3

One method of comparing the effectiveness of the computer identification process is to examine the average number of each pattern found per subject by both identification procedures. The values are tabulated in Table 5.2. It is clear that more shifting was identified manually than via the computer identification software in both the a-p and m-l directions. For both methods of identification, however, shifting was more prevalent in the a-p direction than in the m-l direction. Both processes identified more fidgets occurring in the m-l direction than in the a-p direction. An observable difference is that while the average number of fidgets in each direction is nearly the same in the manual process, it is not the case for the computer identification. The manual identification process identified more fidgets on average than were identified by the computer identification process. The opposite is found for the m-l direction as the computer identification process identified more fidgets than the manual process. In both processes, drifting occurred more frequently in the a-p direction. The computer process identified approximately two more drifts on average in each trial than the manual identification process.

Table 5.2 –COP Migration Patterns Values for Both Identification Processes

	SHIFTS		FIDGETS		DRIFTS	
	Average #/Trial (Manual)	Average #/Trial (Comp.)	Average #/Trial (Manual)	Average #/Trial (Comp.)	Average #/Trial (Manual)	Average #/Trial (Comp.)
X-dir. (a-p)	27.17	16.50	13.17	9.00	2.75	5.25
Y-dir. (m-l)	16.00	10.00	14.58	16.67	2.25	3.92
Total	43.17	26.50	27.75	25.67	5.00	9.17

The data for both the manual identification and the computer identification was compiled and recorded on one data sheet. This was done to determine which patterns had

been identified by only the manual process, only the computer program process, or those patterns which had been identified by both. A sample data sheet is shown in Table 5.3 and data sheets for all subjects can be found in Appendix C.

Due to the fact that the identification processes were performed separately, many instances appear where the time of occurrence of a pattern differs slightly. This was especially the case with drift identification, as both the beginning and end of a drift were recorded with neither time being exactly the same when compared between identification processes. Nonetheless, they were still close enough to determine that the same drift was being identified. There were also patterns that were identified differently in one process than the other. For example, what may have been considered as two shifts during the manual identification process was identified as one fidget during the computer identification process. In the tabulation of how the pattern was identified (i.e. manually, computer, or both) these are counted as being identified by both. Each of these occurrences was noted accordingly for future reference as to why they may have been identified as they were and they are included in Appendix C along with the comparison tables.

Table 5.4 includes the tabulated results for all trials and shows which patterns were found exclusively by the manual identification process and those found exclusively by the computer identification process. A column for those patterns identified by both identification processes is also included. The values in parentheses, in the manual and computer columns, are the percentages of the identified patterns within that particular process that were identified by both methods. For example, 8 patterns were identified by both methods for subject 1X. These 8 patterns represent 20.5 % [total patterns =

31(manual) + 8(both) = 39 therefore $8/39 = 20.5\%$] of the patterns identified manually and 28.6 % [total patterns = 20(computer) + 8(both) = 39 therefore $8/28 = 28.6\%$] of the patterns identified by the computer software.

The fifth column in the table contains a note regarding identified drifts for that particular trial. There are some instances where the length of the recorded drift from the manual analysis does not meet the required minimum drift length used as a parameter during the computer identification. These drifts are still included in the total number of identified patterns by the manual process.

There are widespread differences in the number of patterns per trial that were identified by both identification processes. These differences are also reflected in the percentages of the patterns that were identified by both processes. The range for the manual process is 17.9 % to 68.0 % and for the computer identification process it is 18.2 % to 62.5 %. On average, however, the percentage of patterns that were identified by both processes within the manual identification totals was $40.3 \pm 13.7\%$. The percentage of patterns identified by both processes within the computer identification process was on average $44.2 \pm 14.3\%$.

These percentages of agreement are not as high as expected, however there is a good foundation to build upon for further research. Some of the discrepancies in patterns identified are due in part to the way in which the patterns are defined and subsequently identified.

For example, in the manual analysis approach, there are instances where fidgets occur in rapid succession and are identified as individual fidgets. This would not be the case in the computer analysis due to its moving average approach and standard deviation

approach. In these cases the moving average would increase such that not all of the fidgets would be identified because they do not then meet the standard deviation requirement. Another example of a potential discrepancy in identification is when there is a fidget-like undershoot or overshoot that accompanies a shift in the COP migration. For the majority of the manual analysis cases, these were identified as two distinct patterns, however this was not the case for the computer software as oftentimes only the shift was identified. This would also lead to a lower level of agreement between the two identification processes. Conversely, there were also patterns identified within the manual process that would not be identified by the computer software as they did not meet the amplitude requirements.

Table 5.4 – COP Pattern Tabulation

Subject	Pattern Identification			NOTES (MI drifts that do not qualify are still included in man. count)
	MANUAL	COMPUTER	BOTH	
1X	31 (20.5%)	20 (28.6%)	8	See comment sheet, 2 MI drifts do not qualify
1Y	16 (38.5%)	6 (62.5%)	10	1 MI drift does not qualify
2X	19 (38.7%)	27 (30.8%)	12	2 MI drifts do not qualify
2Y	9 (50.0%)	20 (31.0%)	9	2 MI drifts do not qualify
3X	37 (28.8%)	18 (45.5%)	15	1 MI drift does not qualify
3Y	25 (46.8%)	17 (56.4%)	22	4 MI drifts do not qualify and 1 MI that corresponds to CI
6X	3 (62.5%)	14 (26.3%)	5	
6Y	9 (30.8%)	18 (18.2%)	4	1 MI drift does not qualify
7X	50 (20.6%)	11 (54.2%)	13	2 MI drifts do not qualify and 1 MI that corresponds to CI (D)
7Y	32 (17.9%)	12 (36.8%)	7	3 MI drifts do not qualify and 1 MI that corresponds to CI (D)
8X	19 (45.7%)	12 (57.1%)	16	3 MI drifts do not qualify
8Y	21 (51.2%)	14 (61.1%)	22	
9X	61 (27.4%)	15 (60.5%)	23	1 MI drift does not qualify
9Y	24 (50.0%)	15 (61.5%)	24	2 MI drifts do not qualify
10X	14 (50.0%)	9 (60.9%)	14	1 MI that corresponds to CI (D)
10Y	15 (31.8%)	25 (21.9%)	7	
11X	31 (27.9%)	19 (38.7%)	12	1 MI drift does not qualify
11Y	8 (68.0%)	19 (47.2%)	17	
12X	22 (33.3%)	14 (44.0%)	11	
12Y	12 (33.3%)	12 (33.3%)	6	1 MI drift does not qualify
13X	23 (52.1%)	17 (59.5%)	25	1 MI drift does not qualify
13Y	9 (59.1%)	25 (34.2%)	13	1 MI drift that corresponds to CI
14X	22 (47.6%)	16 (55.6%)	20	2 MI drifts do not qualify
14Y	24 (35.1%)	23 (36.1%)	13	2 MI drifts do not qualify

5.2 Software Evaluation

The software created by Duarte and Zatsiorsky [15] and subsequently modified was able to identify all three COP migration patterns during seating. Patterns that were identified by the computer process only (i.e. excluding those that were found by both identification processes) were referenced manually against the plots of the filtered COP migration data to confirm that the patterns did exist. This was used as a means of double-checking the output of the computer identification program. Due to the differences in the way patterns were identified, these patterns may not have been identified originally by

the manual identification process because they may not have met the identification parameters established for manual identification. There are situations in which the program can be improved when comparing its results with those obtained via the manual identification approach.

One situation that arose when double-checking the identified patterns was that there were many instances in which the computer software identified a shift in the COP migration data however none could be seen upon manual inspection. It is unclear as to why the software identified shifts at these times, however it is possible that a shift is in fact present, though it may not be visible or large enough to be of any consequence. This may have been as a result of the standard deviation within the moving windows being so minute that an extremely small change in the COP migration data would have resulted in a shift being identified. Table 5.5 displays the number of occurrences of this phenomenon within each trial. In those trials not listed, this situation did not occur. Further explanations for these shifts can be found in the Notes section in Appendix C. In subject 11Y five fidgets were identified that were unable to be clearly identified manually. One such fidget was also unable to be identified in subject 12Y. These manually unidentifiable fidgets may be as a result of the filter used for the raw data. While most of the identified patterns are verifiable through double-checking manually, they do not appear within the manual analysis results because they did not fall within the identification parameters set for the manual analysis. These were instances where the differences in the analysis procedures affected which patterns were identified.

Taking into account the possible identification errors and the fact that improvements can be made, the software lays a good foundation on which to build further research.

Table 5.5 – Software Identified Shifts that Were Not Verified Manually

Trial Number	Number of Unverifiable Shifts
1X	6
1Y	1
2X	5
2Y	2
3X	2
3Y	8
6X	1
6Y	2
9X	1
9Y	3
10Y	2
11X	2
11Y	3
13X	3
14Y	7

5.3 Conclusions

Center of pressure (COP) migration patterns were found to exist during prolonged unconstrained seating at the seat-buttocks interface. Center of pressure migration data were collected on a Kistler force plate over a 30 minute time using the BioWare software Real-time COP function for 12 subjects. The COP data were transferred to Excel spreadsheets where they were plotted in order to determine if identifiable patterns did exist. Three identifiable patterns were found upon analyzing the COP data in both the x-direction (anterior-posterior movement) and the y-direction (medial-lateral movement).

These patterns were defined as: 1) shifts - a fast displacement of the average position of the COP from one region to another; 2) fidgets – a fast and large displacement and returning of the COP to approximately the same position; and, 3) Drifts – a slow, continuous displacement of the average position of the COP.

The software developed by Duarte and Zatsiorsky [15], which was subsequently modified for the purposes of this research, was used to identify all three COP migration patterns during prolonged unconstrained seating. Despite the inconsistencies within the patterns identified, the software is a useful tool in the analysis of COP migration patterns during seating research. It would not be recommended that this software be used within practical applications, such as the design of a dynamic chair, until further improvements have been made to increase its accuracy in pattern identification.

5.4 Future Work

The information obtained through this research provides a foundation upon which further research may be built. The fact that center of pressure migration patterns exist during prolonged seating creates more questions than are answered.

One area for improvement would be to solidify the definitions of the three patterns so that there would be more consistency in the identification of patterns, particularly in the manual identification process. While subjectivity affects how patterns are defined, it would be beneficial to reduce the amount of subjectivity involved in manual pattern identification.

While beyond the scope of this thesis, more time could be placed into increasing the effectiveness of the software developed by Duarte and Zatsiorsky [15]. This would

further enhance any other research projects that would be undertaken. This would include modifications to identify multiple fidgets in succession, or to eliminate the identification of shifts that are not really evident. It would also mean the identification of patterns occurring at approximately the same time, as in the case of shifts with over- or undershoot migrations that appear to be fidgets. There might also be improvements made to the fidget algorithm as it pertains to approximating the width of a fidget because it estimates the width as the full width at half maximum. There are occurrences of identified fidgets where the actual width of the fidget exceeds 4 seconds due to the difference in slopes of the ascending and descending sides. In any case, improvements to the algorithms would enable the transition of the software from research applications to more practical applications, such as involving the software as a component of a dynamic chair.

Further study could also be undertaken to determine if chosen threshold values are universal for all subjects or whether the sensitivity is subject dependant. That is to say should the selected parameters for a subject be personalized? Along with the refinement of the definition of each pattern, this issue may be the key to developing more agreement between the manual and computer identification processes.

There may be correlations between variables such as sex, height, or weight that may affect which parameters are chosen for the computer analysis of the center of pressure migration. It would also prove useful to look at the frequency of identified patterns as a function of time. Are certain patterns more prevalent within certain periods of time or do they occur randomly over the data acquisition period? Or are the COP migration patterns cyclical over a period of time?

Research into whether COP migration patterns can be identified or detected visually through monitoring a subject's upper or lower body movement and correlating that to the identification of the patterns using the software would be another area to pursue.

Another avenue would be to determine the correlation between forces at the seat-buttocks interface and the COP migration. In other words, can COP migration patterns be predicted based upon examining how the migration is related to application points or magnitudes of forces? This could be accomplished by synchronizing collected data from the force plate with that obtained by a force-sensing array mat.

It may also prove beneficial to determine if different seat contours affect how the COP migrates during prolonged seating. If COP migration patterns are directly related to perceived discomfort during seating, can the effectiveness of seating interventions (e.g. contoured cushions) be analyzed by examining the frequency and amplitude of COP migration patterns?

Perhaps the most interesting question is whether COP migration patterns exist for people with various disabilities, particularly those who are users of wheelchairs. If so, can this software be used to develop a dynamic chair that will aid wheelchair users and contribute to the prevention of pressure sores? Whatever the case may be, further research into how we sit, how the body reacts when in the seated position, and patterns of COP migration can only be beneficial, particularly for those who spend much of their time in the seated position.

References

- [1] **Cornell University Ergonomics Web**, 2003, "DEA 651 Class Notes - Sitting and Chair Design", <http://ergo.human.cornell.edu/DEA325notes/sitting.html>.
- [2] **Sember, J.A.**, 1994, "The Biomechanical Relationship of Seat Design to the Human Anatomy", *Hard Facts About Soft Machines – The Ergonomics of Seating*, pp. 221-229, *Taylor & Francis Ltd.*
- [3] **The Franklin Institute Online**, 2002, "Capillary Connections", <http://sln.fi.edu/biosci/vessels/capillaries.html>.
- [4] **Cook, A.M., and Hussey, S.M.**, 1995, *Assistive Technologies: Principles and Practice*, *Mosby-Year Book, Inc., St. Louis, MO.*
- [5] **Gross, C.M., Goonetilleke, R.S., Menon, K.K., Banaag, J.C.N., and Nair, C.M.**, 1994, "The Biomechanical Assessment of Prediction of Seat Comfort", *Hard Facts About Soft Machines – The Ergonomics of Seating*, pp. 231-253, *Taylor & Francis Ltd.*
- [6] **Crenshaw, R.P., and Vistnes, L.M.**, 1989, "A Decade of Pressure Sore Research: 1977-1987", *Journal of Rehabilitation Research*, Vol. 26, No. 1, pp. 63-74.
- [7] **Patterson, R.P., and Fisher, S.V.**, 1986, "Sitting Pressure-Time Patterns in Patients with Quadriplegia", *Archives of Physical and Medical Rehabilitation*, Vol. 67, pp. 812-814.
- [8] **Brienza, D.M., and Geyer, M.**, 2000, "Understanding Support Surface Technologies", *Advances in Skin & Wound Care*, Vol. 13, No. 5, pp. 237-244.
- [9] **Sprigle, S., Chung, K., and Brubaker, C.E.**, 1990, "Factors Affecting Seat Contour Characteristics", *Journal of Rehabilitation Research and Development*, Vol. 27, No. 2, pp. 127-134.
- [10] **Kwiatowski, R.J., and Inigo, R.M.**, 1993, "A Closed Loop Automated Seating System", *Journal of Rehabilitation Research*, Vol. 30, No. 4, pp. 393-404.
- [11] **Sprigle, S., Chung, K., and Brubaker, C.E.**, 1990, "Reduction of Sitting Pressures with Custom Contoured Cushions", *Journal of Rehabilitation Research and Development*, Vol. 27, No. 2, pp. 135-140.
- [12] **Karg, T.E., Brienza, D.M., Chung, K., and Brubaker, C.E.**, 1996, "Evaluation of a Surface Shape Optimization Technique for Custom Contoured Cushion Design", *Proceedings of 1996 RESNA Conference*, June 7-12, 1996.
- [13] **Karg, T.E., Brienza, D.M., Brubaker, C.E., Wang, J., and Lin C.T.**, "A System for the Design and Analysis of Seat Support Surfaces", *Proceedings of 1996 RESNA Conference*, June 7-12, 1996.
- [14] **Cumming, W.T., Tompkins, W.J., Jones, R.M., and Margolis, S.A.**, 1986, "Microprocessor-Based Weight Shift Monitors for Paraplegic Patients", *Archives of Physical and Medical Rehabilitation*, Vol. 67, pp. 172 -174.
- [15] **Duarte, M., and Zatsiorsky, V.M.**, 1999, "Patterns of Center of Pressure Migration During Prolonged Unconstrained Standing", *Motor Control*, Vol. 3, pp. 12-27.

- [16] **Sacks, A.H.**, 1989, "Theoretical Prediction of a Time-at-present Curve for Avoiding Pressure Sores", *Journal of Rehabilitation Research*, Vol. 26, No. 3, pp. 27-34.
- [17] **Cowan, T.**, 1997, "Pressure-relief Seating", *Professional Nurse*, Vol. 12, No. 11, pp. 809-817.
- [18] **Pellow, T.R.**, 1999, "A Comparison of Interface Pressure Readings to Wheelchair Cushions and Positioning: A Pilot Study", *Canadian Journal of Occupational Therapy*, Vol. 66, Issue 3, pp. 140-149.
- [19] **Grady, J.H., and de Vries, J.**, 2000, "The Clinical Significance of Present Pressure Measurement Systems", *Sixteenth International Seating Symposium*, Feb. 24-26, 2000.
- [20] **Stinson, M., Porter, A., and Eakin, P.**, 2002, "Measuring Interface Pressure: A Laboratory-Based Investigation Into the Effects of Repositioning and Sitting", *The American Journal of Occupational Therapy*, Vol. 56, No. 2, pp. 185-190.
- [21] **Aissaoui, R., Kauffmann, C., Dansereau, J., and de Guise, J.A.**, 2001, "Analysis of Pressure Distribution at the Body-Seat Interface in Able-bodied and Paraplegic subjects Using a Deformable Active Contour Algorithm", *Medical Engineering & Physics*, Vol. 23, pp. 359-367.
- [22] **Kistler Instrumente AG Winterhur**, Operating Instructions: BioWare Biomechanical Software Analysis System.
- [23] **Duarte, M., Harvey, W., and Zatsiorsky, V.M.**, 2000 "Stabilographic Analysis of Unconstrained Standing", *Ergonomics*, Vol. 43, pp. 1824-1830.

APPENDIX A – Plotted Raw Data: Center of Pressure Migration

The following appendix contains the plotted raw center of pressure migration data for all of the subjects over the complete 1800 second data acquisition period.

Subject 1

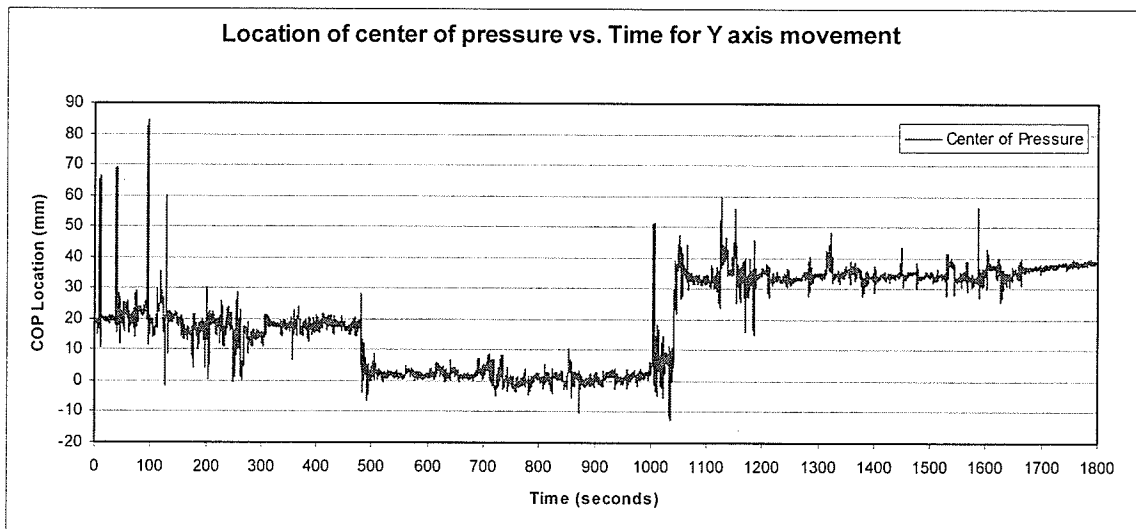
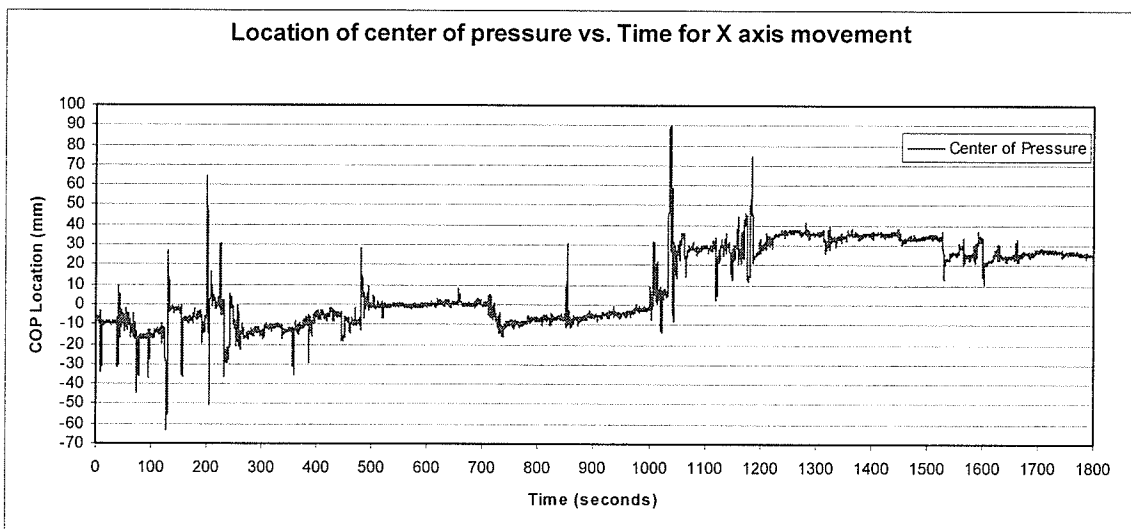

Subject 2

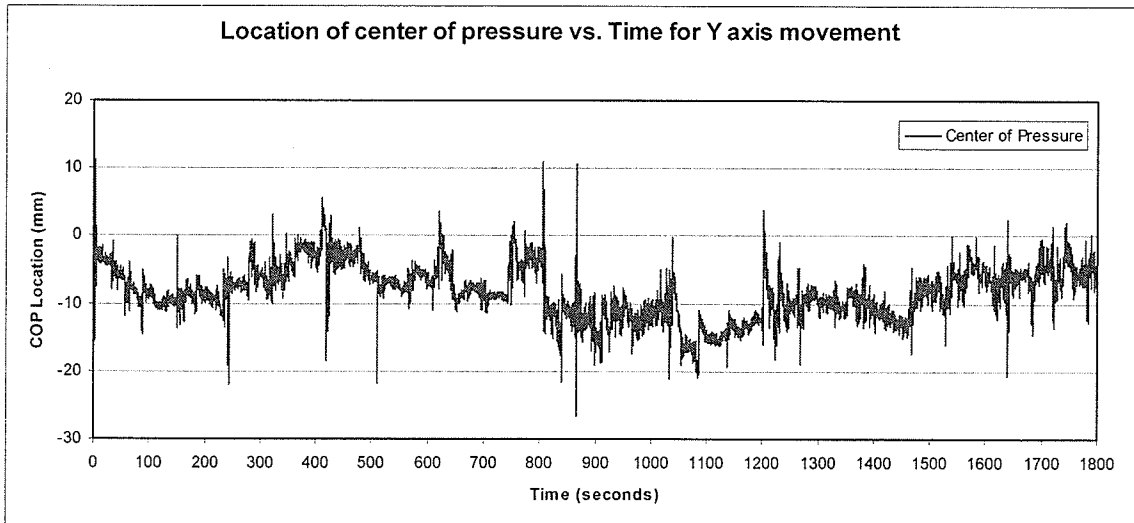
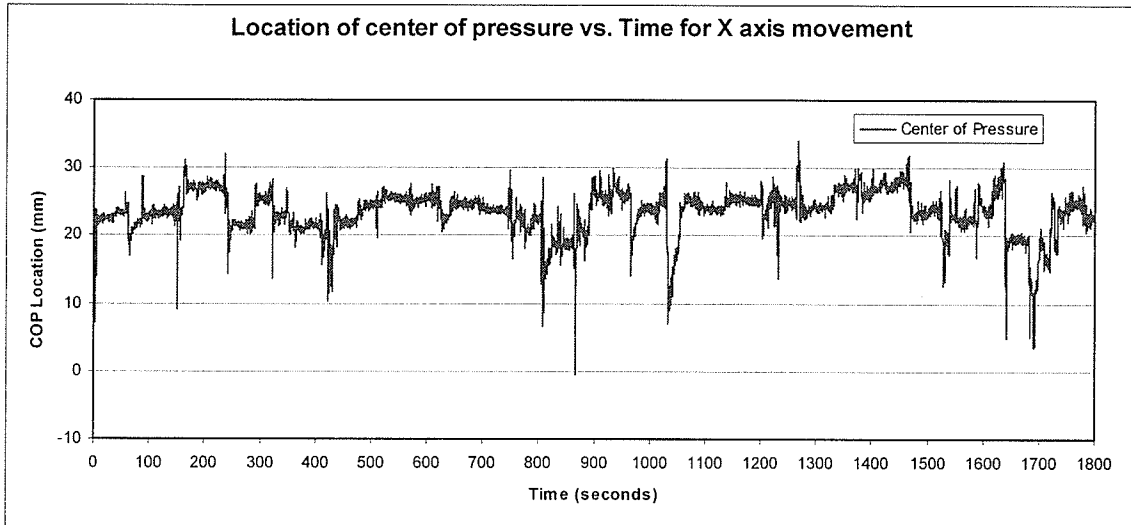

Subject 3

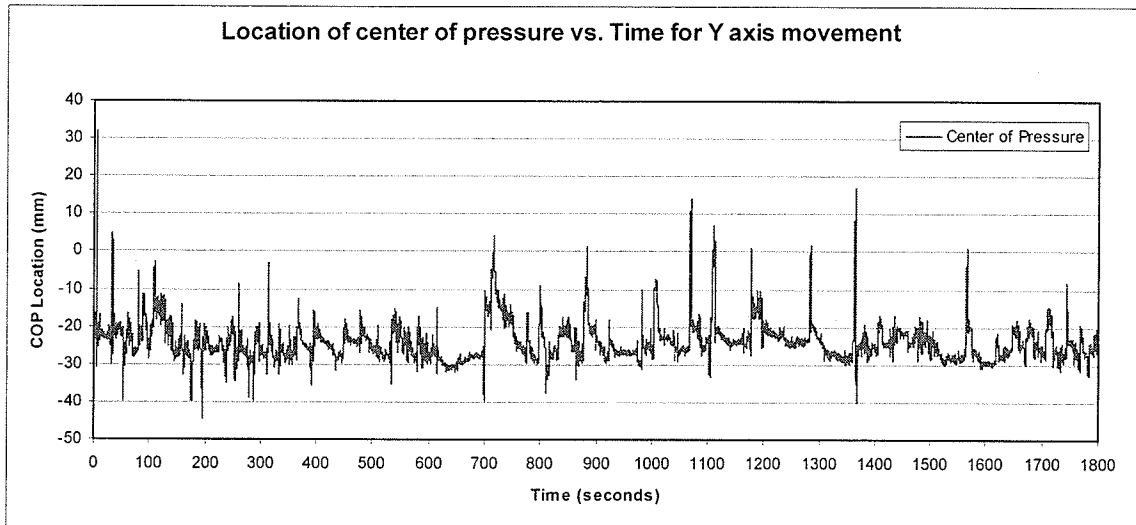
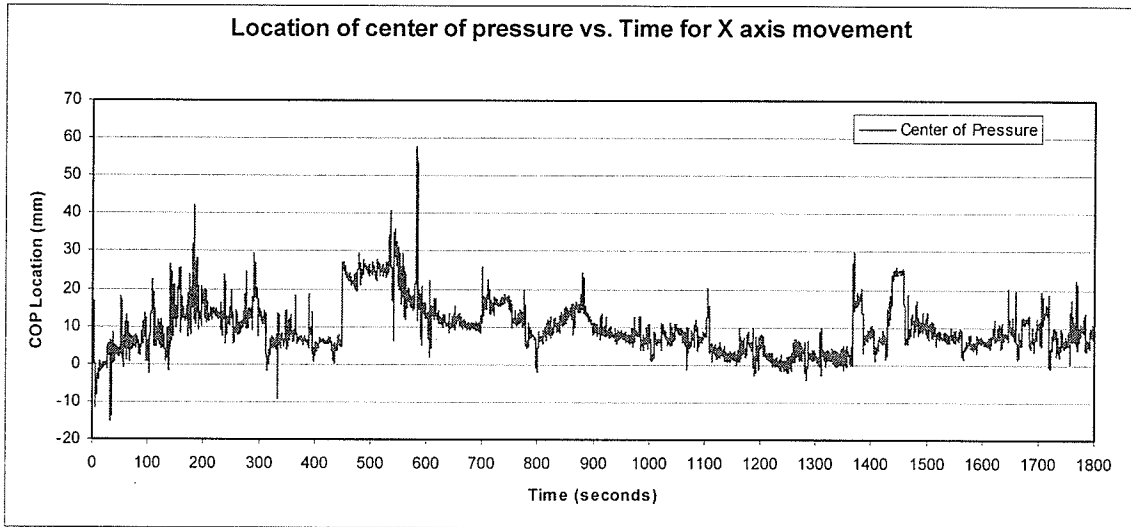

Subject 6

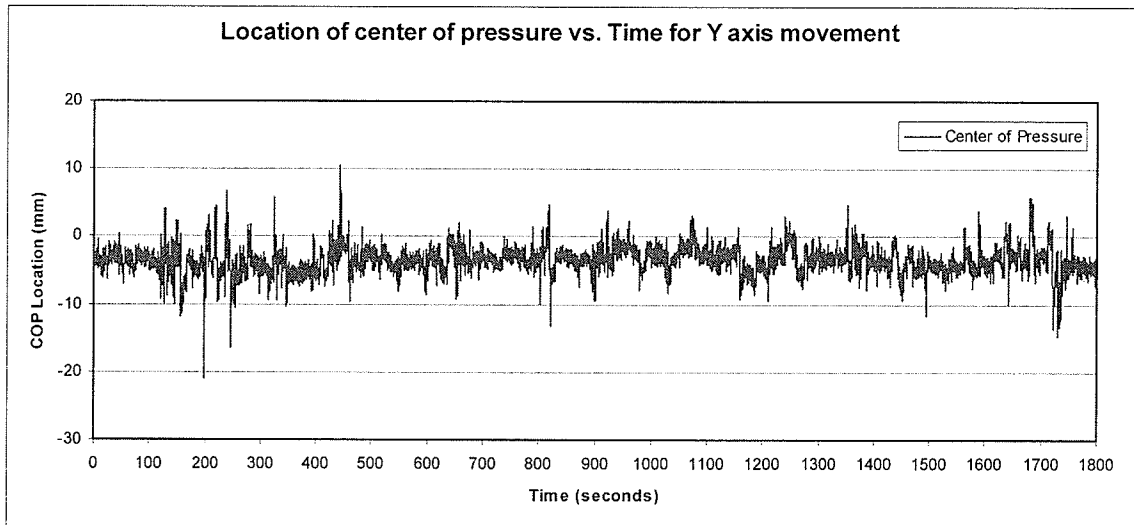
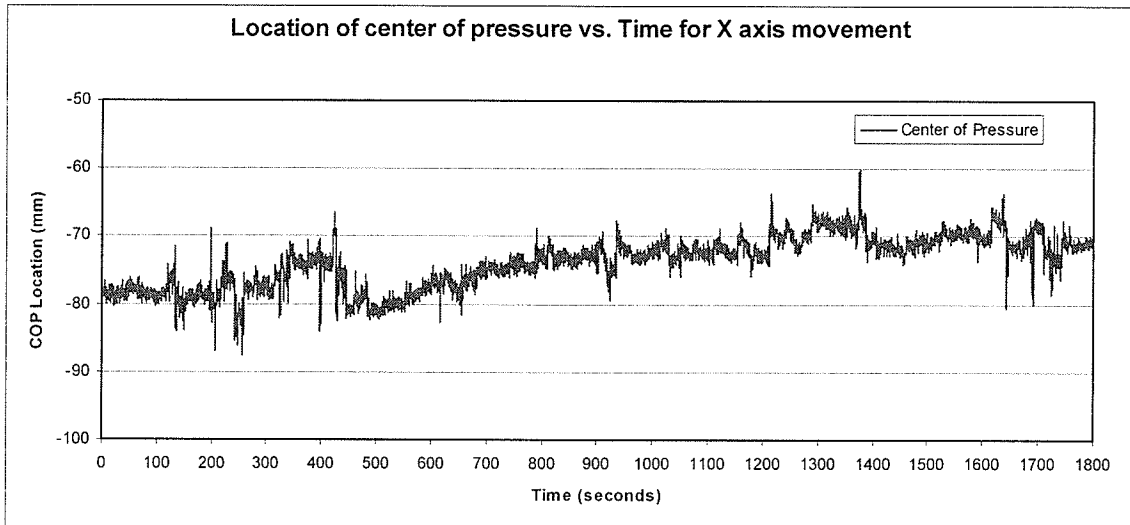

Subject 7

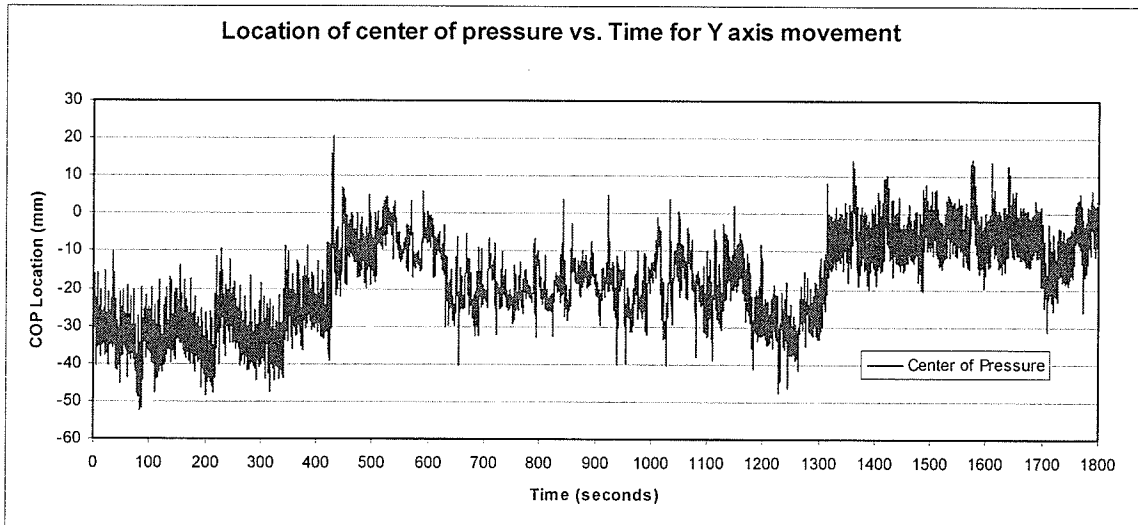
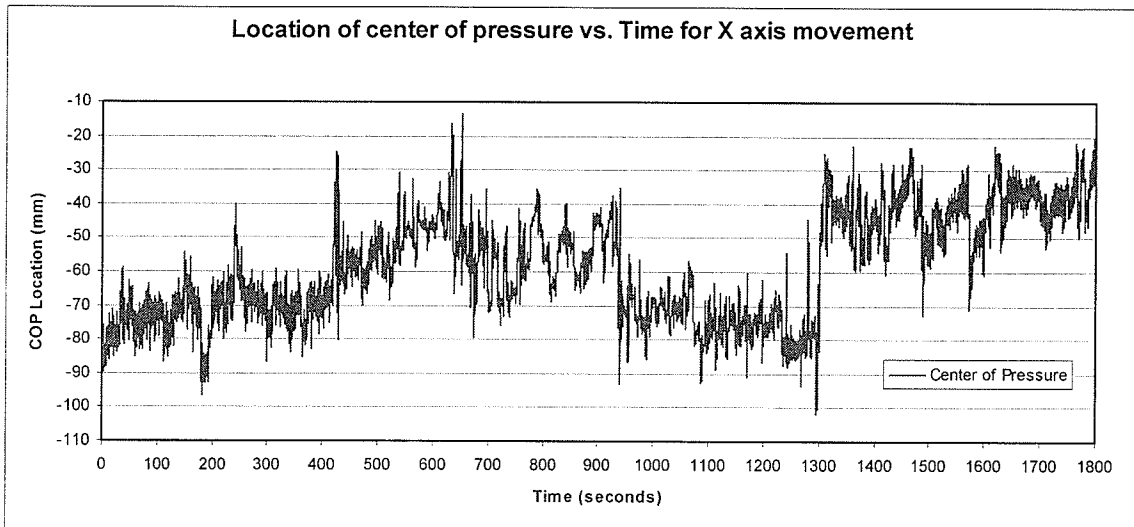

Subject 8

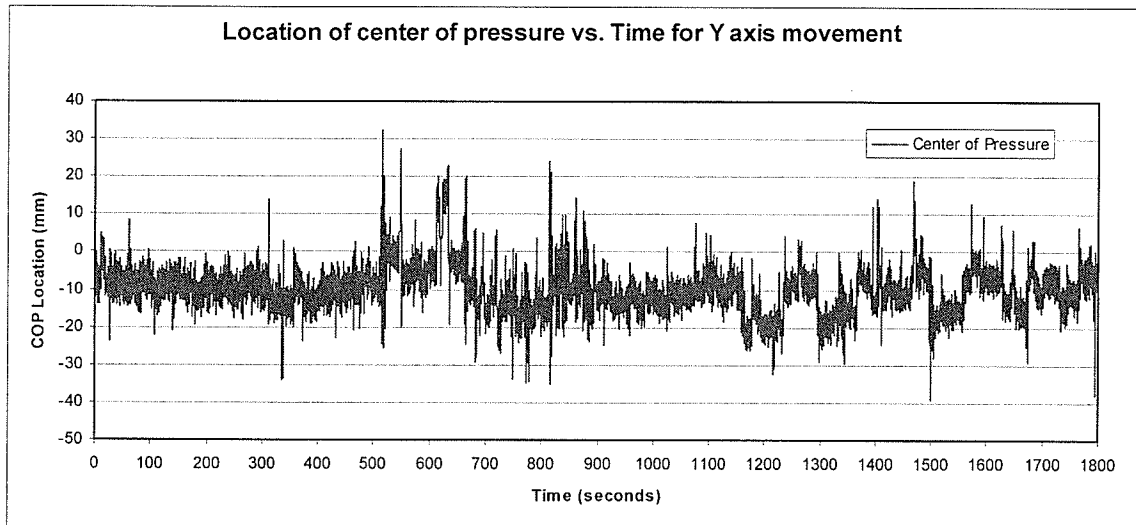
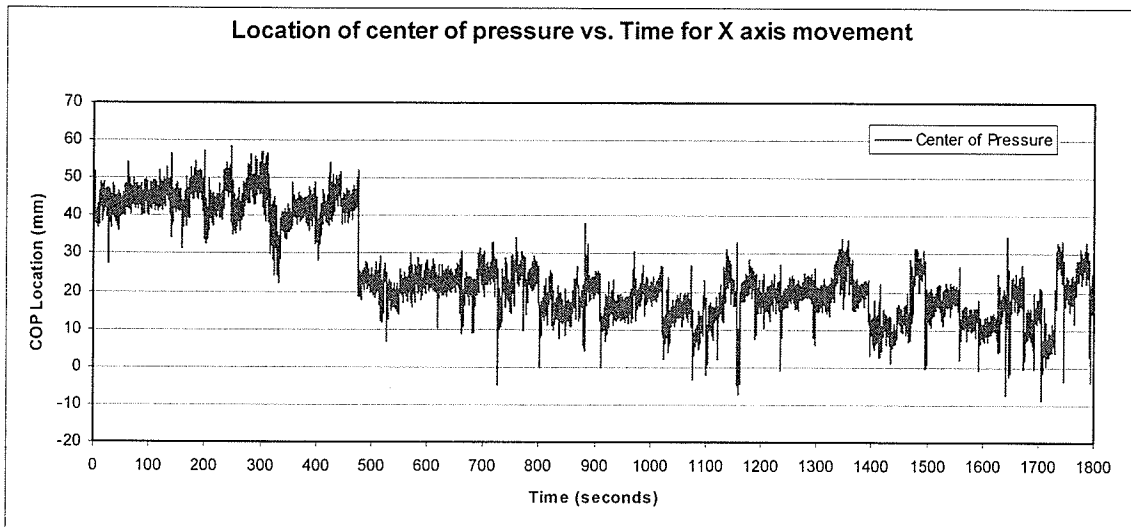

Subject 9

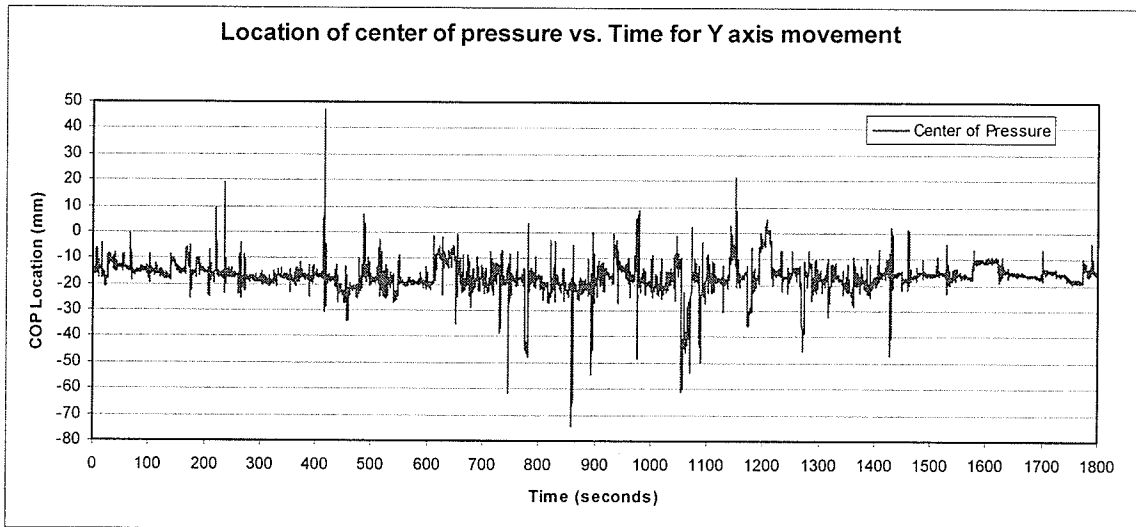
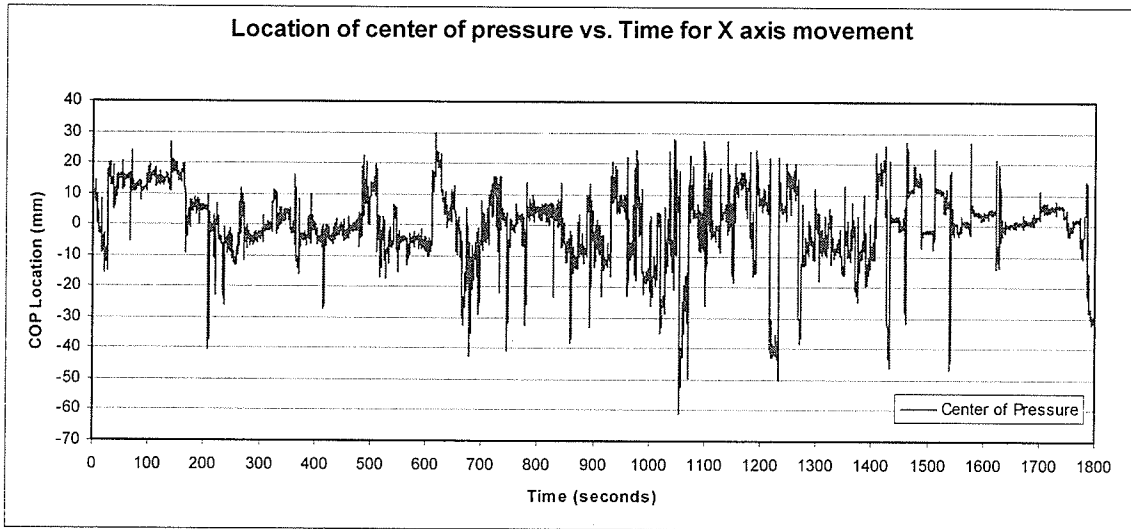

Subject 10

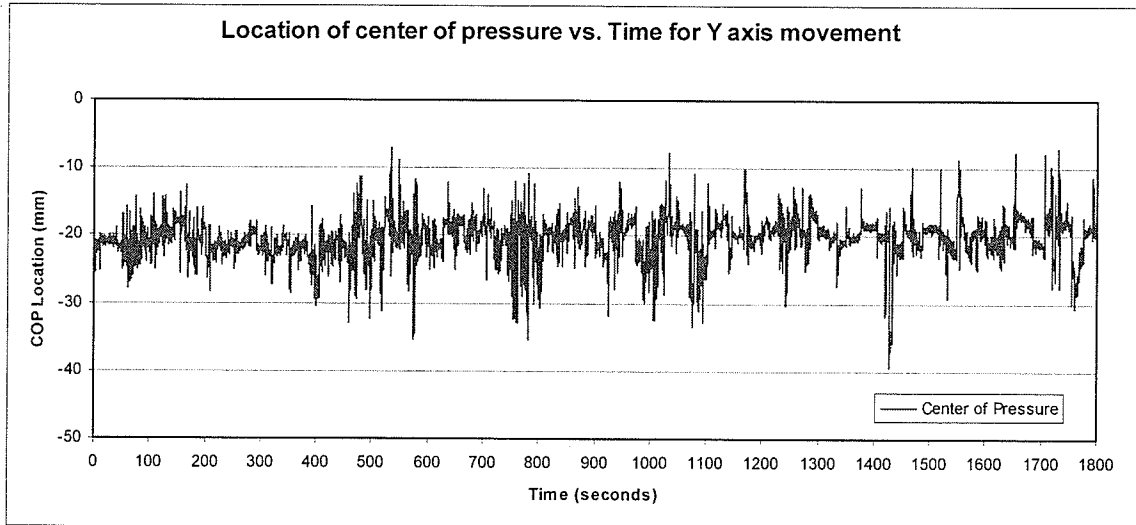
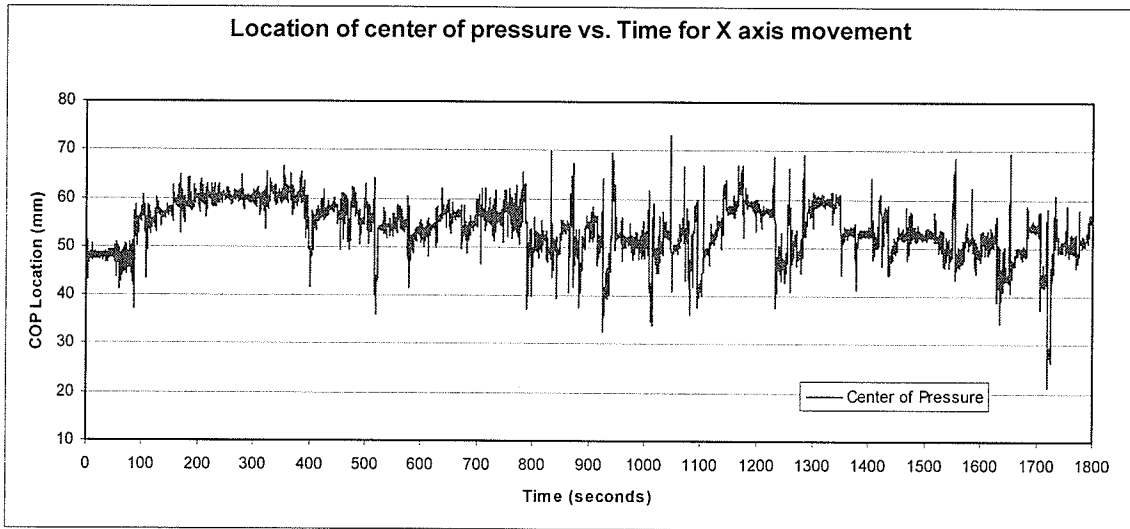

Subject 11

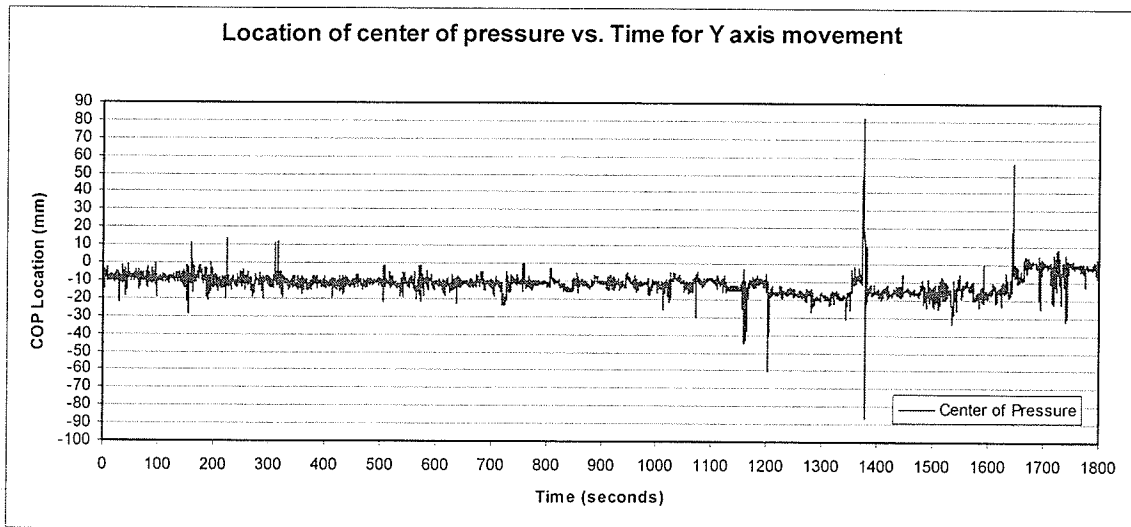
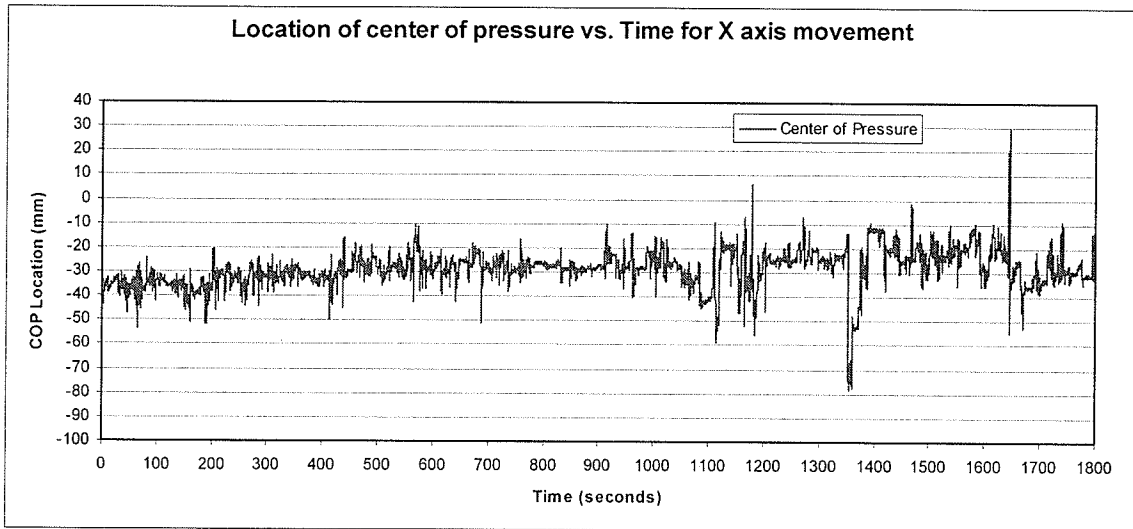

Subject 12

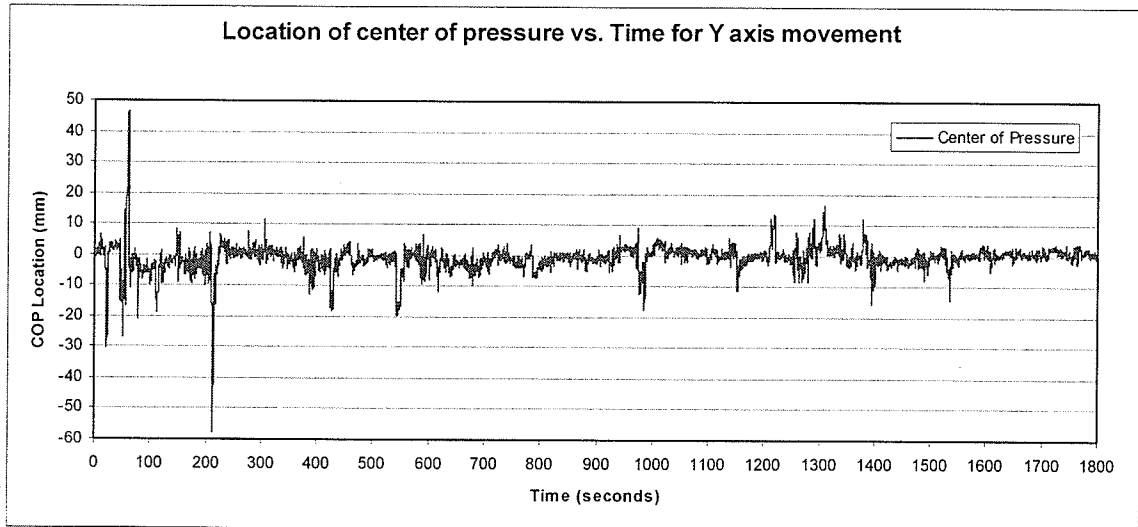
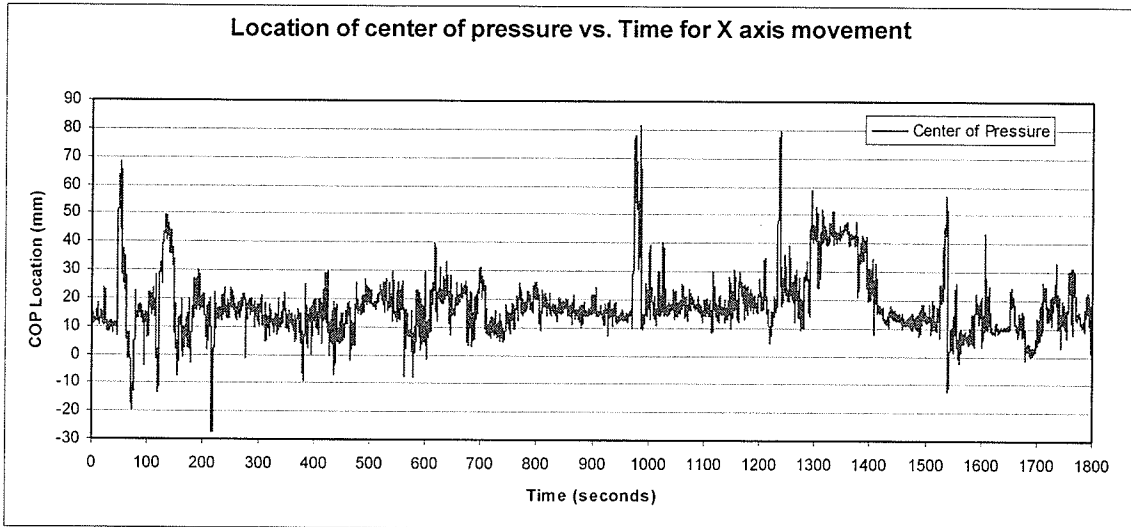

Subject 13

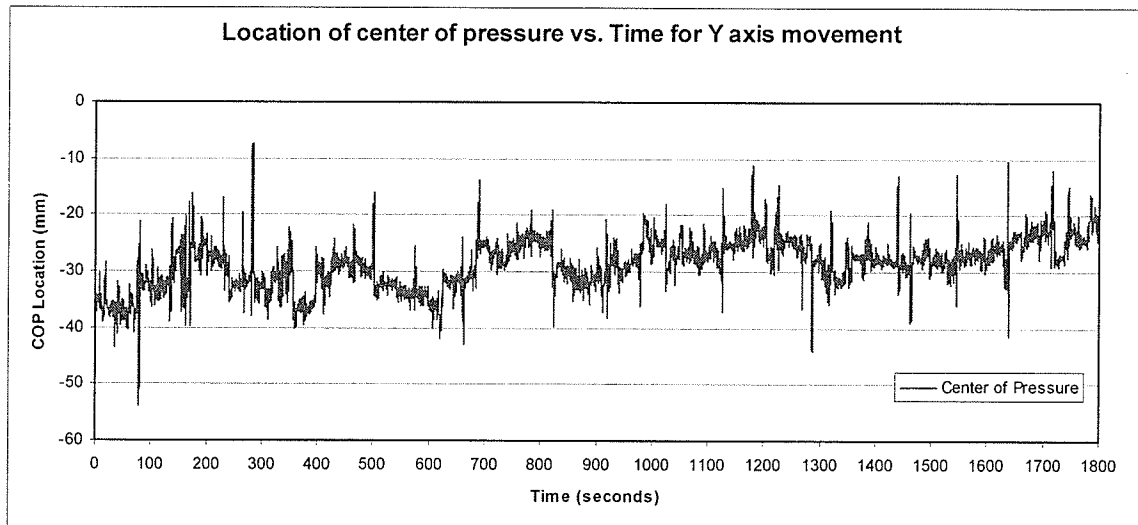
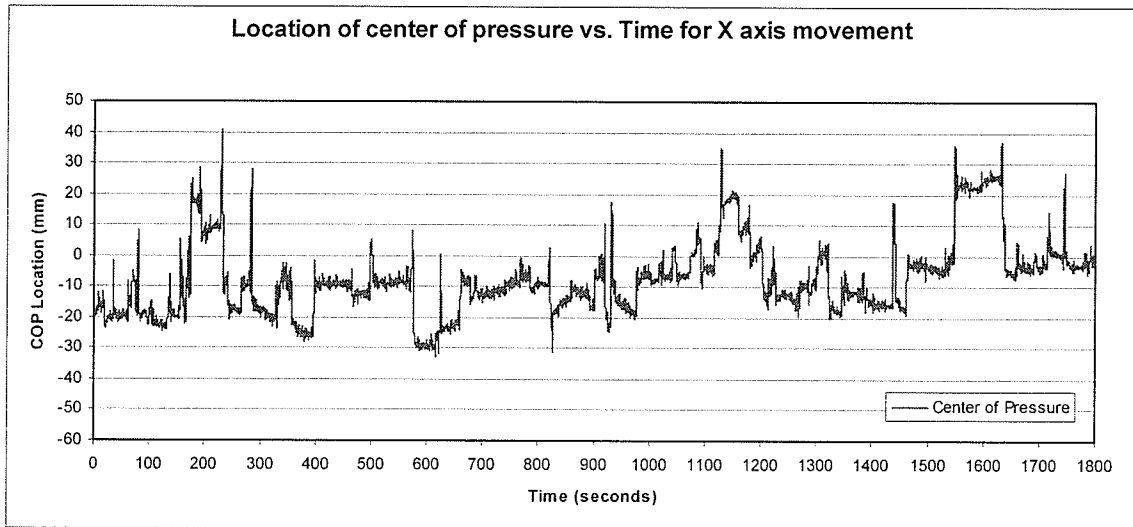

Subject 14

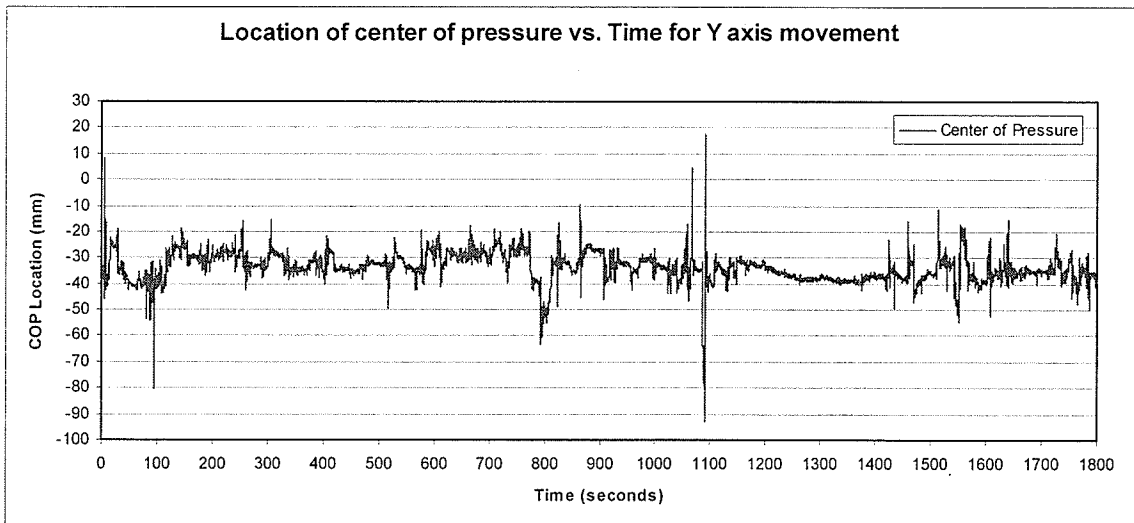
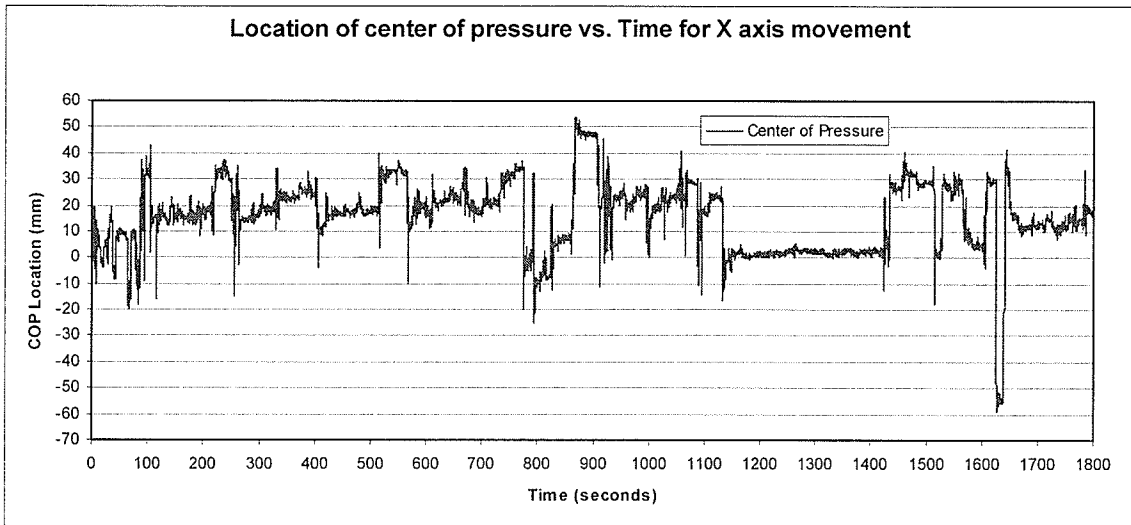

Appendix B – Plotted Filtered COP Data and Manual Results Tables

In this appendix the filtered center of pressure data plots are presented. These plots are for 180 second time segments of data to make the identification of patterns easier. Included with each group of plots are the manual identification results for this research.

Subject 1

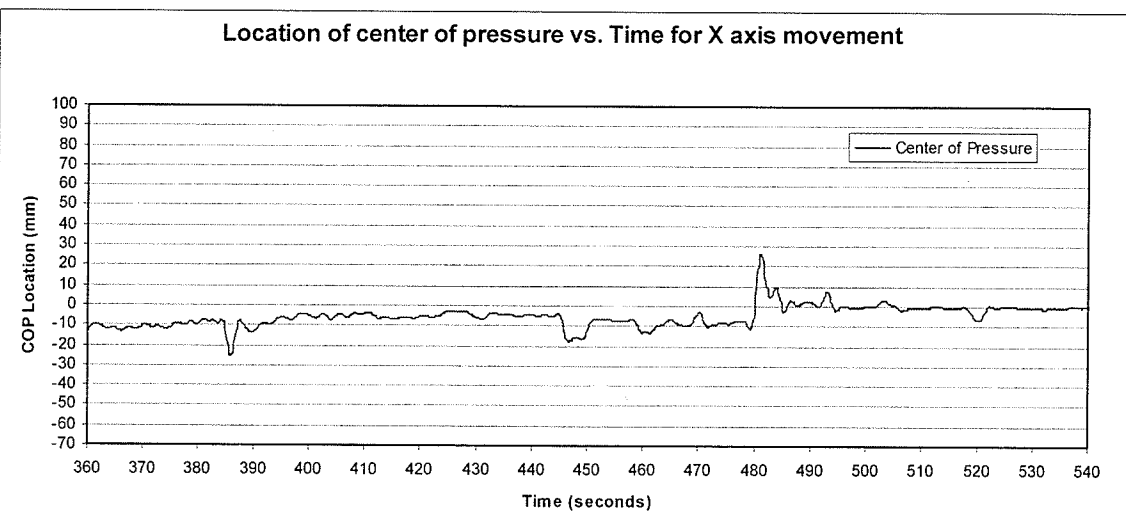
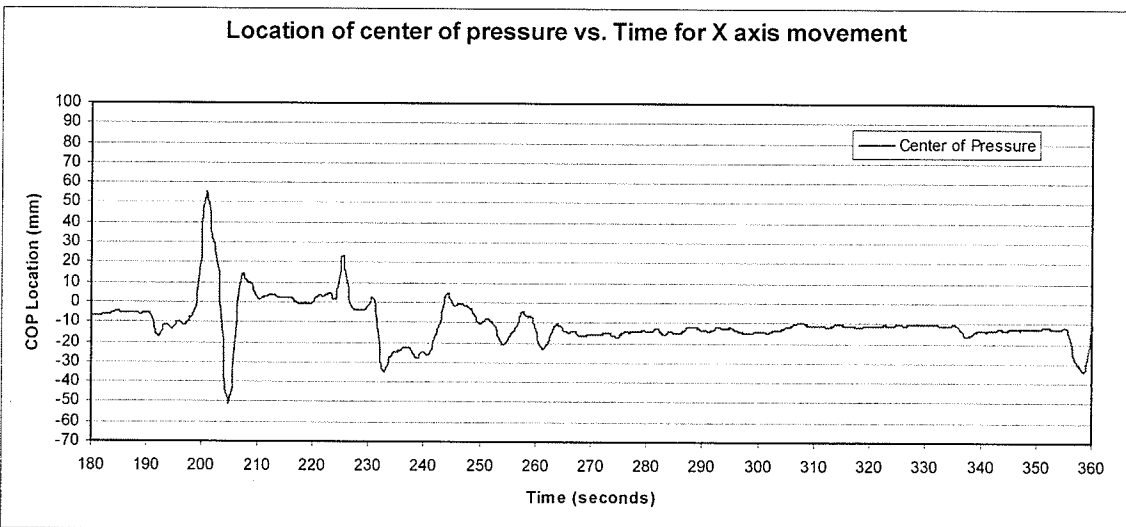
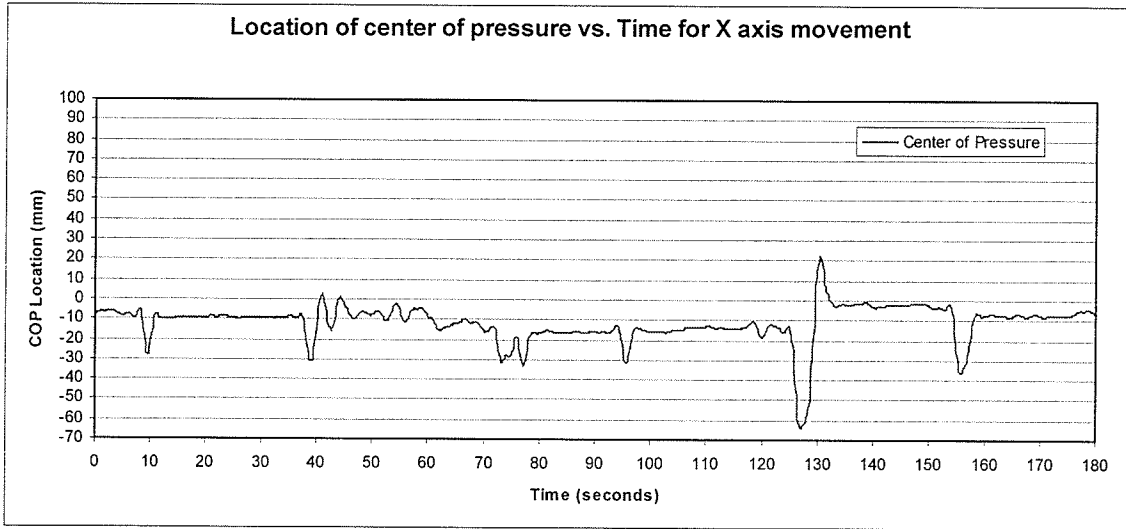

Location of center of pressure vs. Time for X axis movement

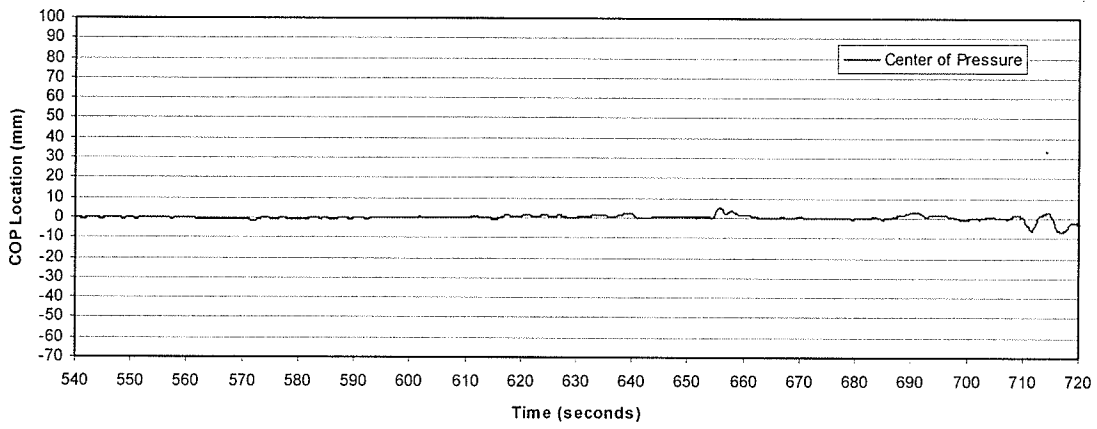

Location of center of pressure vs. Time for X axis movement

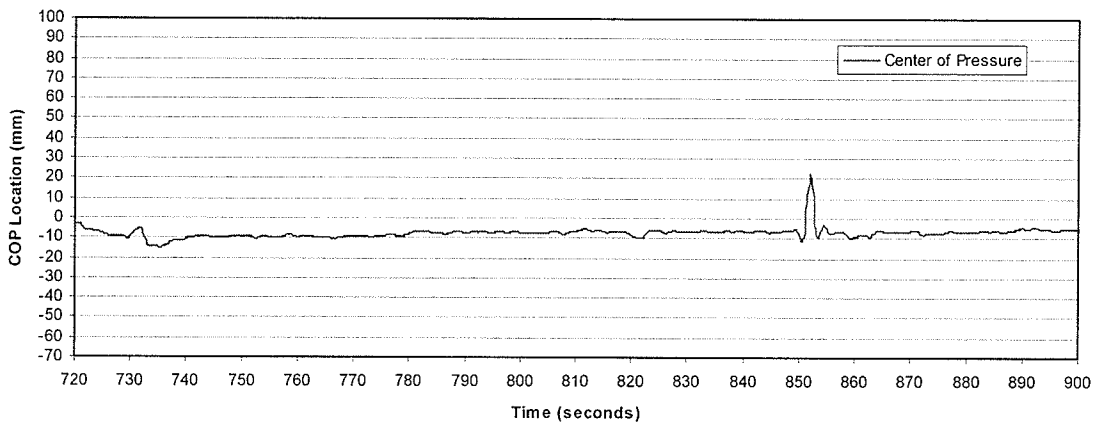

Location of center of pressure vs. Time for X axis movement

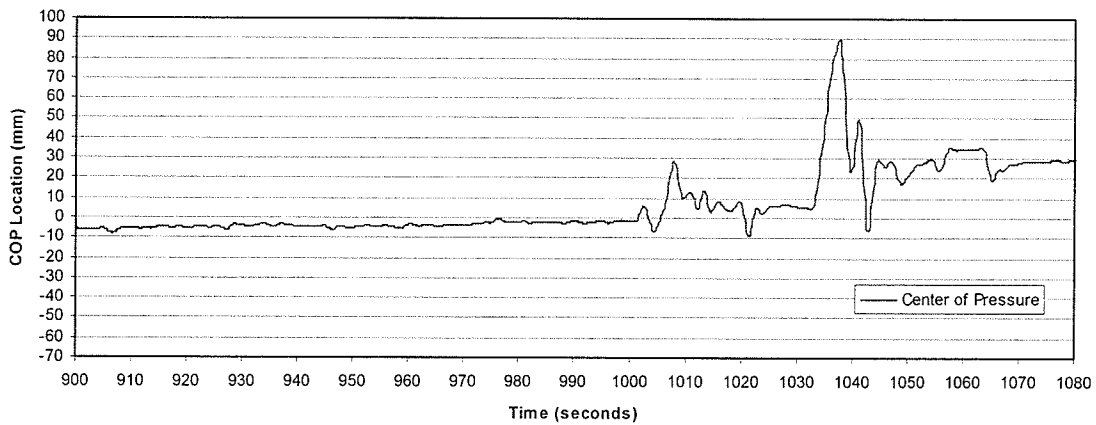

Location of center of pressure vs. Time for X axis movement

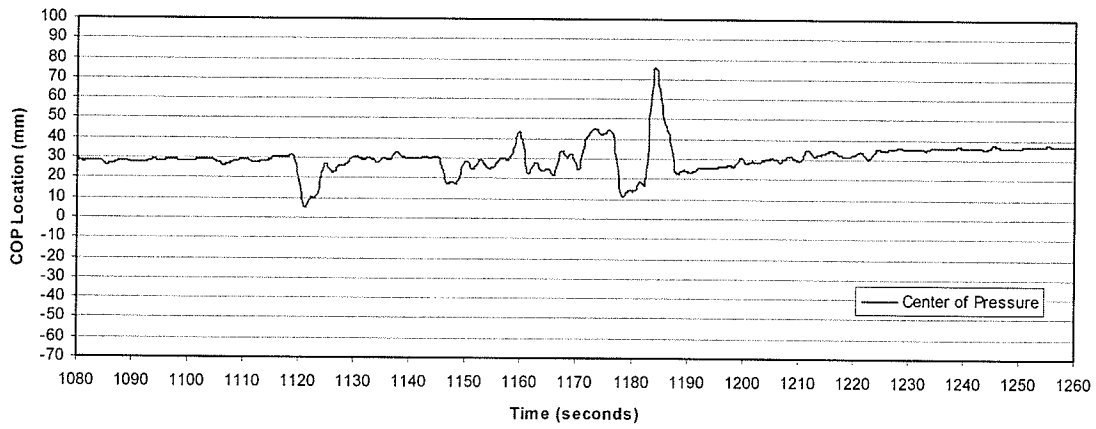

Location of center of pressure vs. Time for X axis movement

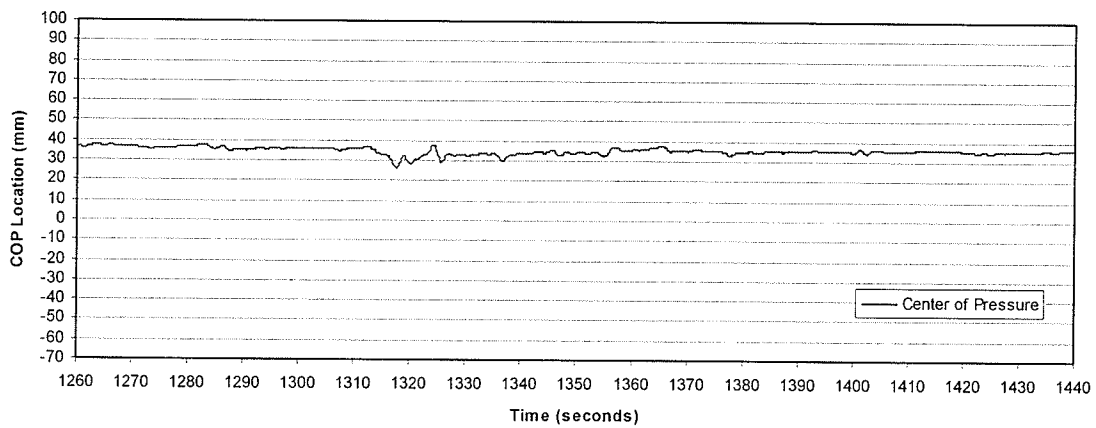

Location of center of pressure vs. Time for X axis movement

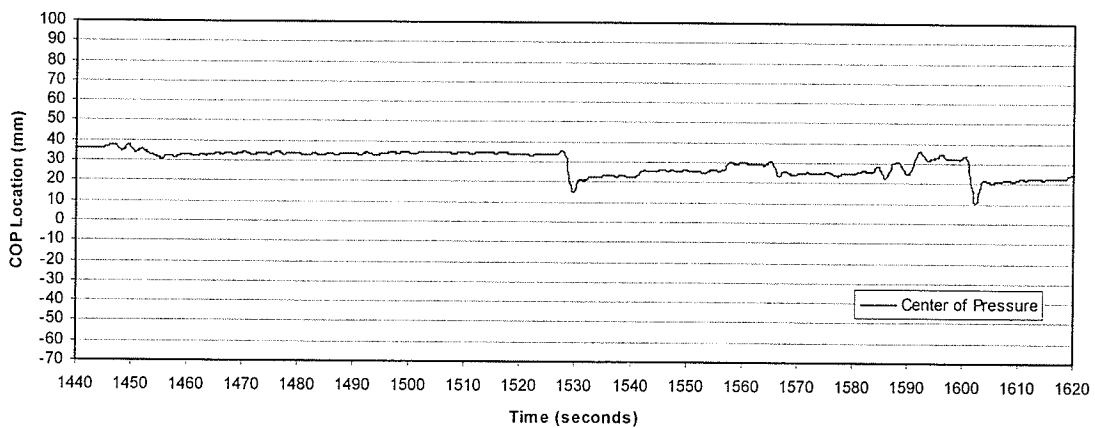

Location of center of pressure vs. Time for X axis movement

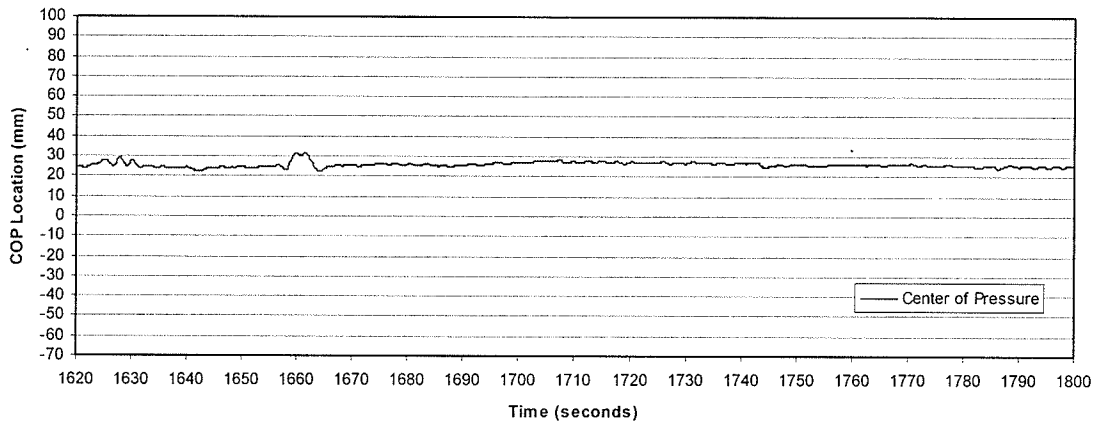

Location of center of pressure vs. Time for Y axis movement

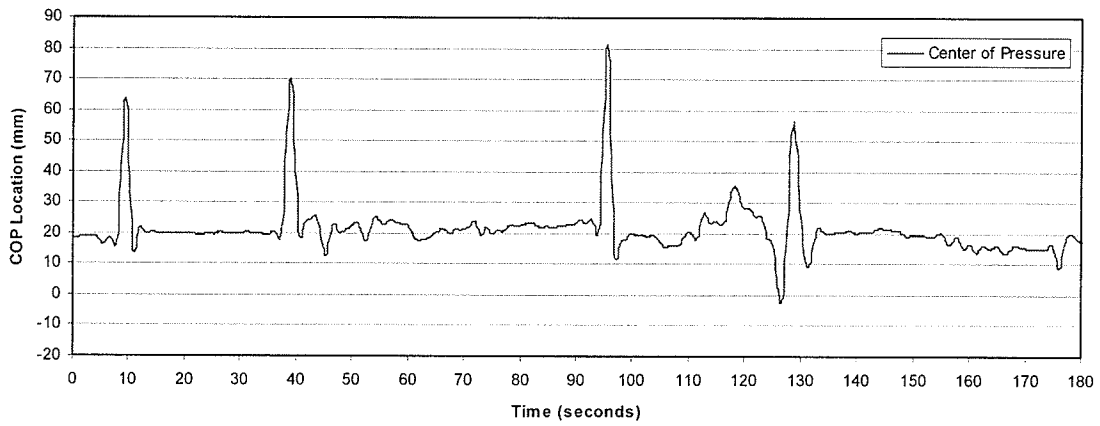

Location of center of pressure vs. Time for Y axis movement

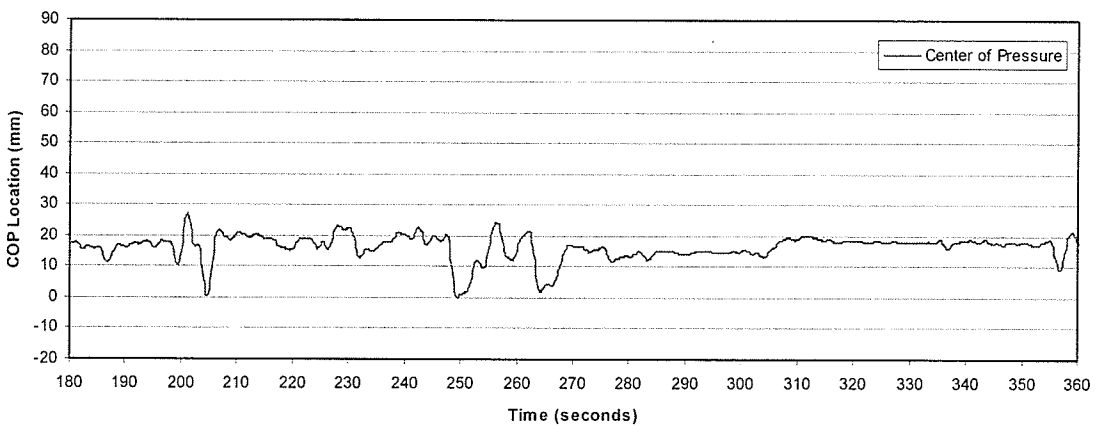

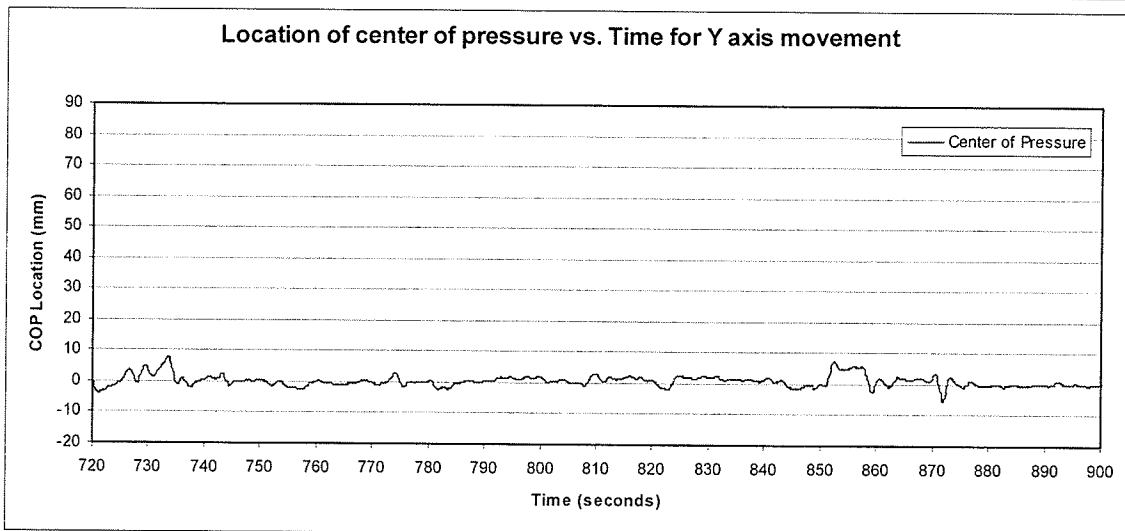
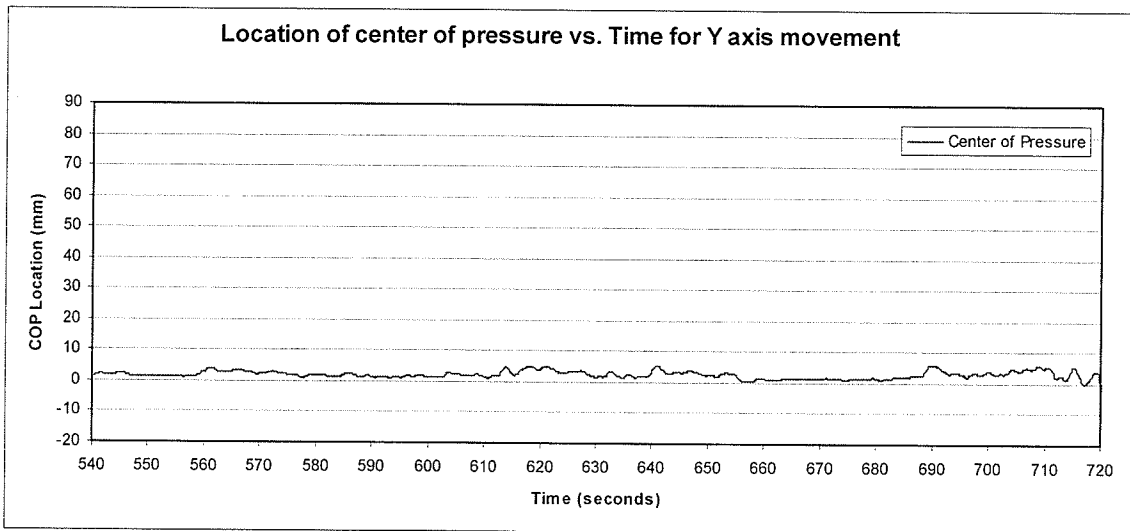
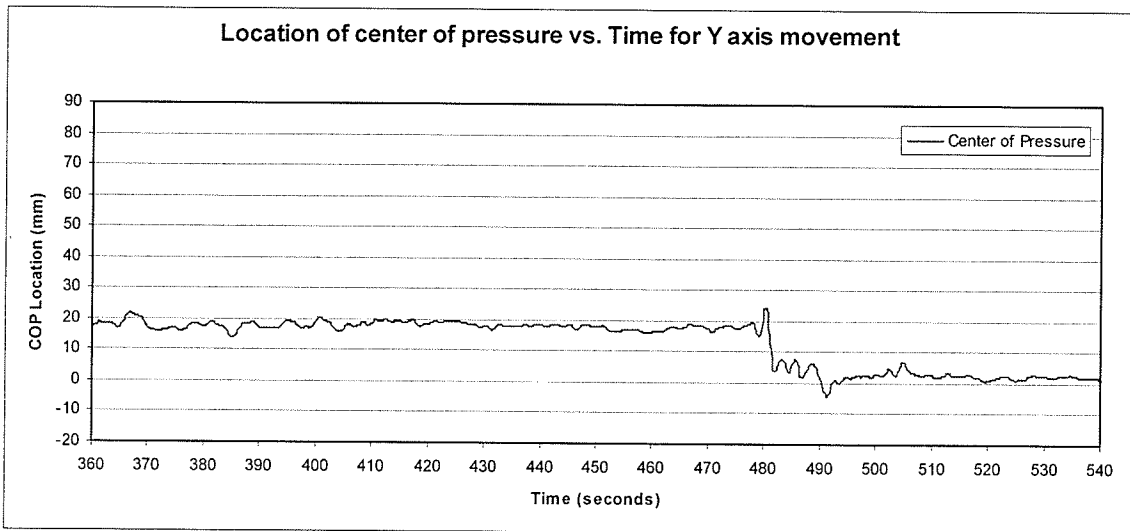

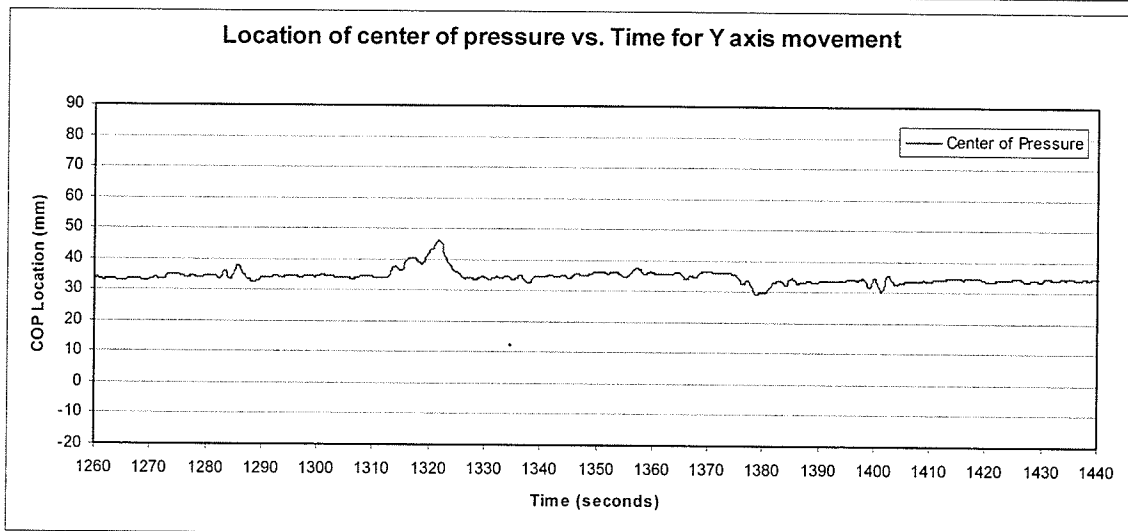
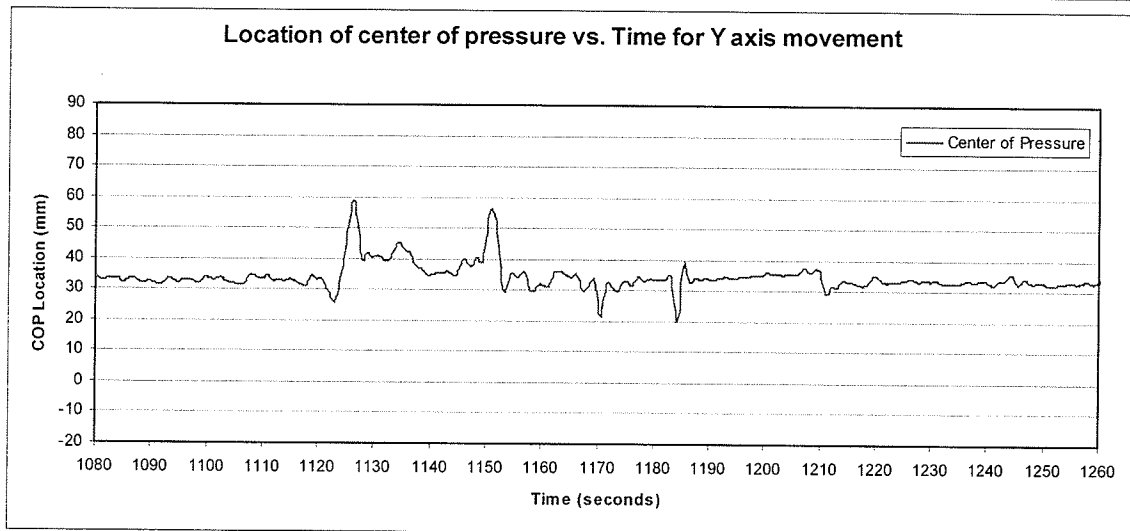
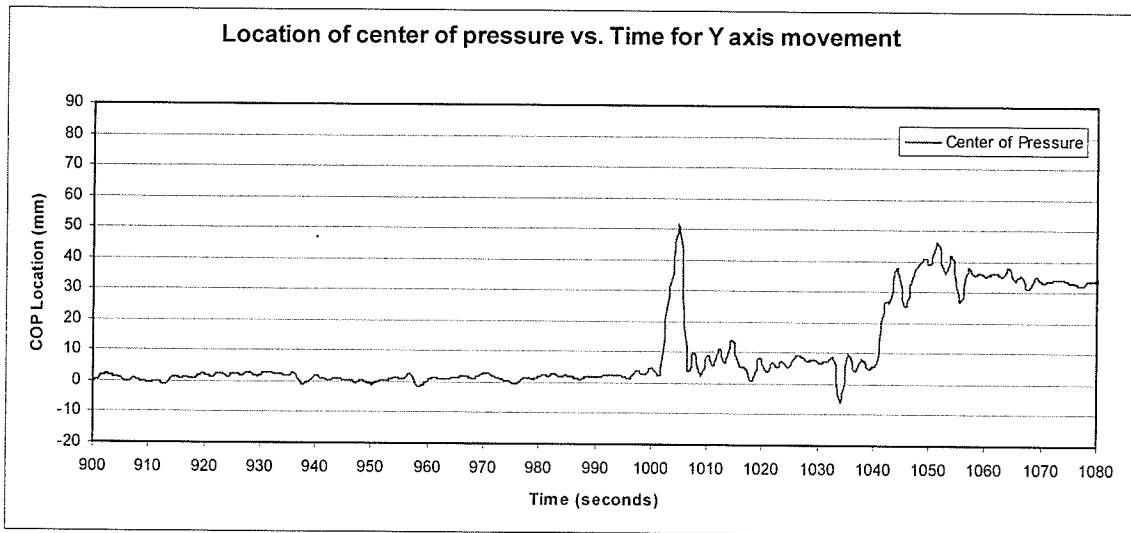

Location of center of pressure vs. Time for Y axis movement

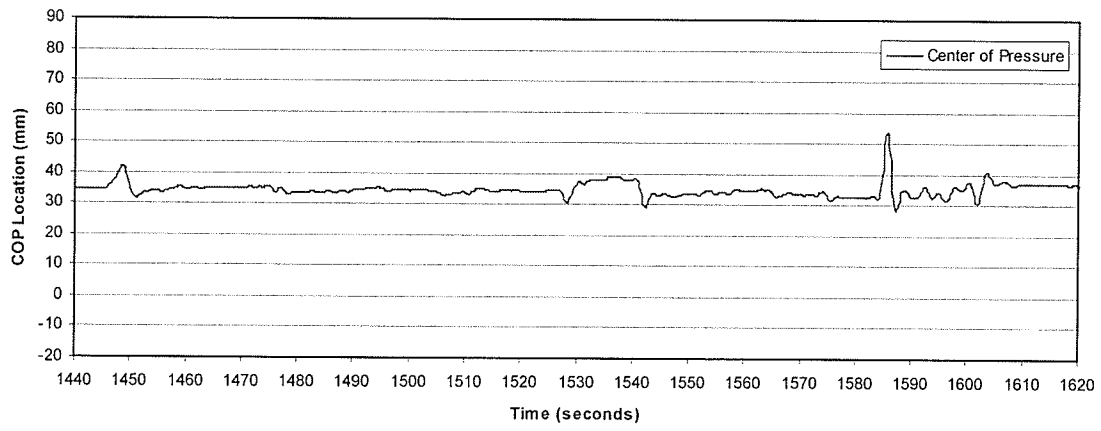

Location of center of pressure vs. Time for Y axis movement

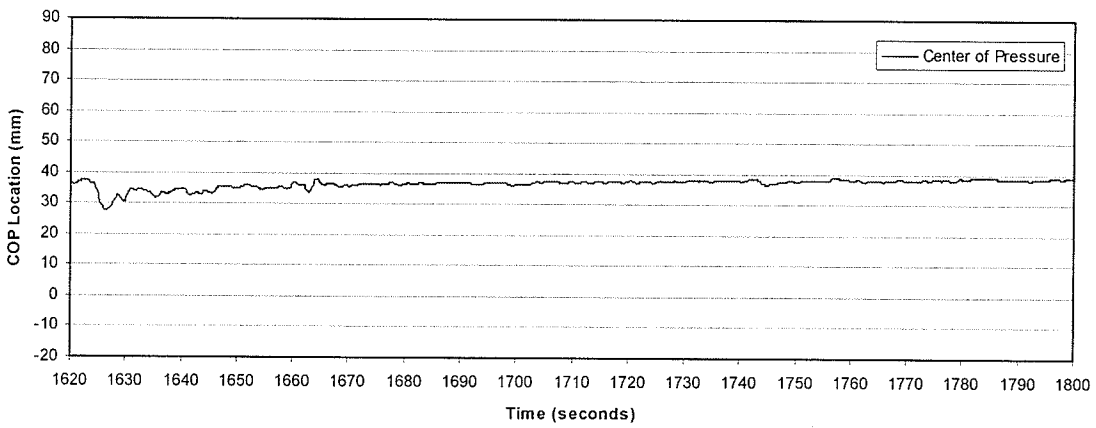

Subject - 1X	Manual Pattern Identification Chart
Approximate Time (seconds)	Pattern Description
1st order begins - 231	
241	Shift - approximate amplitude of 35 mm (0 to -35)
270 - 425	Shift - approximate amplitude of 33 mm (-28 to 5)
733 - 1000	Drift - approximate amplitude of 14 mm (-17 to -3)
850	Drift - approximate amplitude of 14 mm (-15 to -1)
850	Fidget - approximate amplitude of 32 mm (-10 to 22)
1176	Shift - approximate amplitude of 33 mm (43 to 10)
1177 - 1252	Drift - approximate amplitude of 27 mm (10 to 37)
2nd order begins - 8	
37	Fidget - approximate amplitude of 19 mm (-10 to -29)
94	Fidget - approximate amplitude of 21 mm (-10 to -31)
94	Fidget - approximate amplitude of 16 mm (-15 to -31)
223	Fidget - approximate amplitude of 21 mm (1 to 22)
384	Fidget - approximate amplitude of 17 mm (-9 to -26)
445	Shift - approximate amplitude of 15 mm (-4 to -19)
449	Shift - approximate amplitude of 10 mm (-18 to -8)
1055	Shift - approximate amplitude of 12 mm (23 to 35)
1063	Shift - approximate amplitude of 16 mm (35 to 19) - actual amplitude may be less
1145	Shift - approximate amplitude of 12 mm (30 to 18)
1148	Shift - approximate amplitude of 10 mm (18 to 28)
1165	Shift - approximate amplitude of 11 mm (21 to 32)
1169	Shift - approximate amplitude of 16 mm (25 to 41)
1527	Shift - approximate amplitude of 19 mm (35 to 16)
1589	Shift - approximate amplitude of 12 mm (24 to 36)
1600	Shift - approximate amplitude of 13 mm (33 to 20) - with overshoot of approximately 10 mm at end of shift
3rd order begins - 75	
1564	Fidget - approximate amplitude of 14 mm (-19 to -33)
1657	Shift - approximate amplitude of 8 mm (30 to 22)
1657	Shift - approximate amplitude of 8 mm (23 to 31)
1662	Shift - approximate amplitude of 9 mm (31 to 22)
4th order begins - 125	
	Shift - approximate amplitude of 10 mm (-13 to -3) -prior to shift or as part of shift there is a large fidget (down) 51 mm in amplitude followed by reaction upward
153	Fidget - approximate amplitude of 32 mm (-5 to -37) - classified as fidget because amplitude of shift does not fit within pattern parameters, shift amplitude 5 mm
197 (3 possible patterns)	Fidget - approximate amplitude of 60 mm (-5 to 55) followed by fidget downward at amplitude of 46 mm (-5 to 51) then followed by possible shift of amplitude of 19 mm (-5 to 14)
479	Shift - approximate amplitude of 10 mm (-10 to 0) shift begins with spike up (fidget-like) before settling at average COP value of 0
1032	Fidget (double-peaked) - approximate max. amplitude of first at 86 mm (4 to 90), second peak follows at lesser amplitude, this

	pattern is then followed by a shift in the data amp. of 37 mm
1117	Shift - approximate amplitude of 26 mm (31 to 5)
1123	Shift - approximate amplitude of 17 mm (10 to 27)
1182	Fidget - approximate amplitude of 56 mm (20 to 76) wider at base than 4 seconds
1529 to 1565	Shifts - step-like in appearance, which if smoothed slightly would appear as a drift, total approximate amplitude of 10 mm (20 to 30) (2 shifts or 1 drift)
Subject - 1Y	Manual Pattern Identification Chart
Approximate Time (seconds)	Pattern Description
1st order begins - 8	
	Fidget - approximate amplitude of 47 mm (16 to 63)
37	Fidget - approximate amplitude of 52 mm (18 to 70)
93	Fidget - approximate amplitude of 61 mm (20 to 81)
1001	Fidget - approximate amplitude of 49 mm (2 to 51) width may be an issue
1041	Shift - approximate amplitude of 27 mm (6 to 33)
1635 to 1800	Drift - approximate amplitude of 7 mm (32 to 39)
2nd order begins - 144 to 174	
	Drift - approximate amplitude of 6 mm (21 to 15)
246	Shift - approximate amplitude of 20 mm (20 to 0)
262	Shift - approximate amplitude of 19 mm (21 to 2)
266	Shift - approximate amplitude of 13 mm (4 to 17)
481	Shift - approximate amplitude of 16 mm (20 to 4)
1032	Fidget - approximate amplitude of 15 mm (9 to -6)
1183	Fidget - approximate amplitude of 15 mm (35 to 20)
1584	Fidget - approximate amplitude of 22 mm (32 to 54)
3rd order begins - 43	
	Fidget - approximate amplitude of 11 mm (23 to 12)
226	Shift - approximate amplitude of 7 mm (16 to 23)
230	Shift - approximate amplitude of 9 mm (22 to 13)
275	Shift - approximate amplitude of 5 mm (16 to 11)
304	Shift - approximate amplitude of 7 mm (13 to 20) more gradual than most, may not fit width of shift criteria
851	Shift - approximate amplitude of 8 mm (0 to 8) actual shift amplitude may be less, but includes slight overshoot
858	Shift - approximate amplitude of 8 mm (6 to -2)
1210	Shift - approximate amplitude of 9 mm (38 to 29)
1540	Shift - approximate amplitude of 5 mm (39 to 34)
4th order begins - 125	
	Fidget - appears to include small fidget downward and then into a large fidget upward, ampl. of small approx. 24 mm (18 to -2)
128	Fidget - approximate amplitude of 39 mm (18 to 57) second part of pattern at 125 seconds
1122	Shift - approximate amplitude of 15 mm (25 to 40) fidget-like overshoot accompanies shift

Subject 2

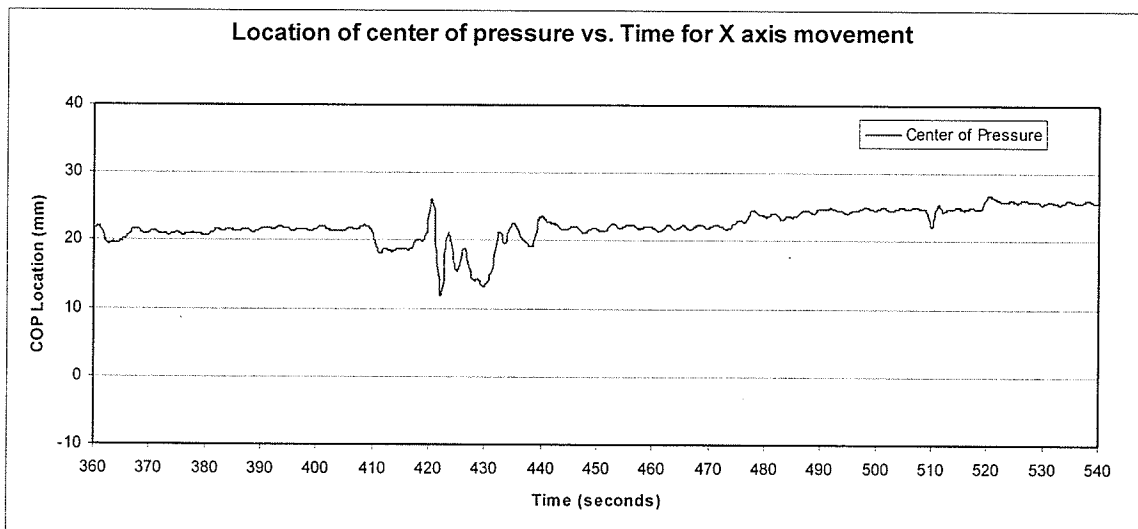
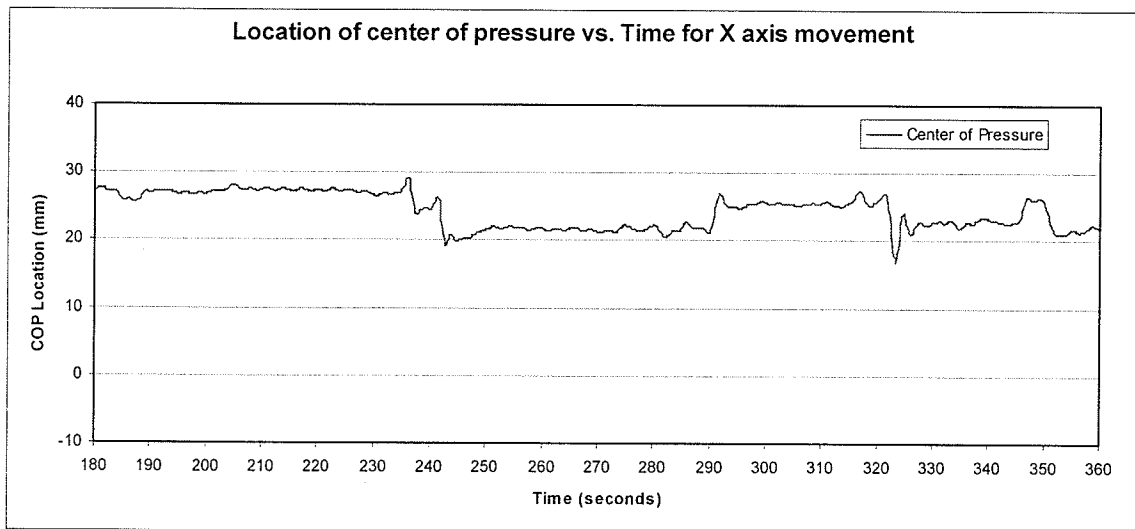
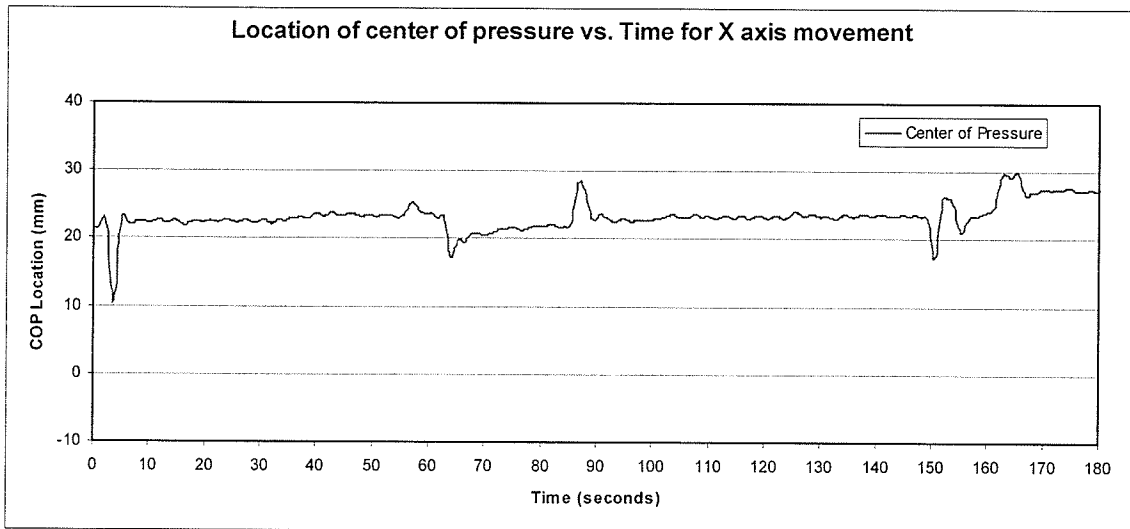

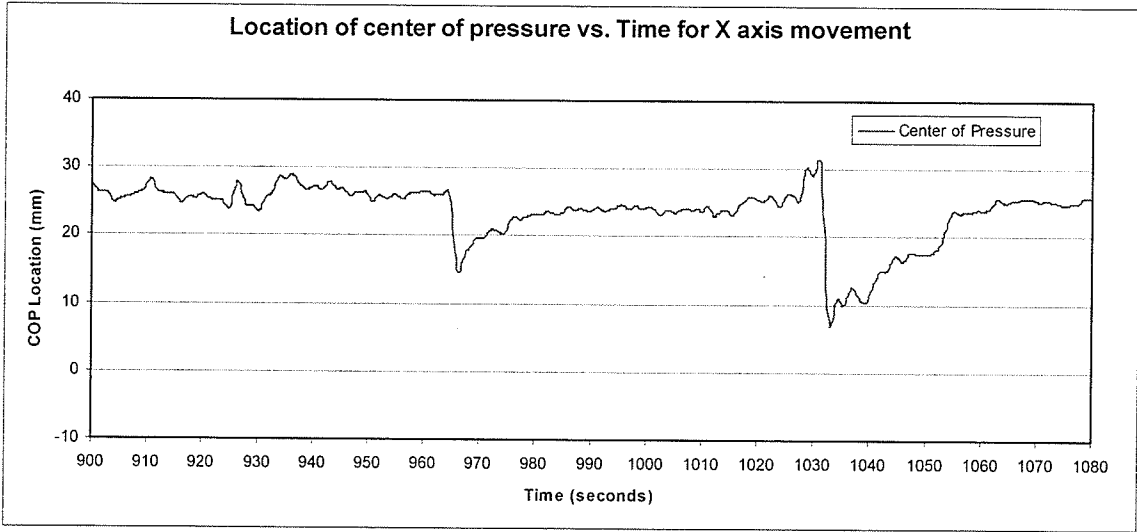
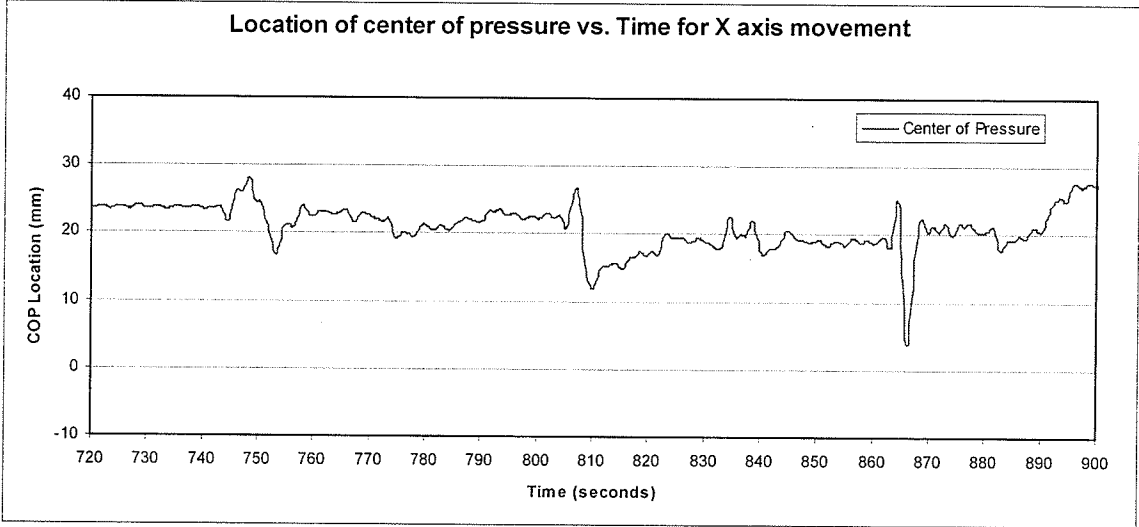
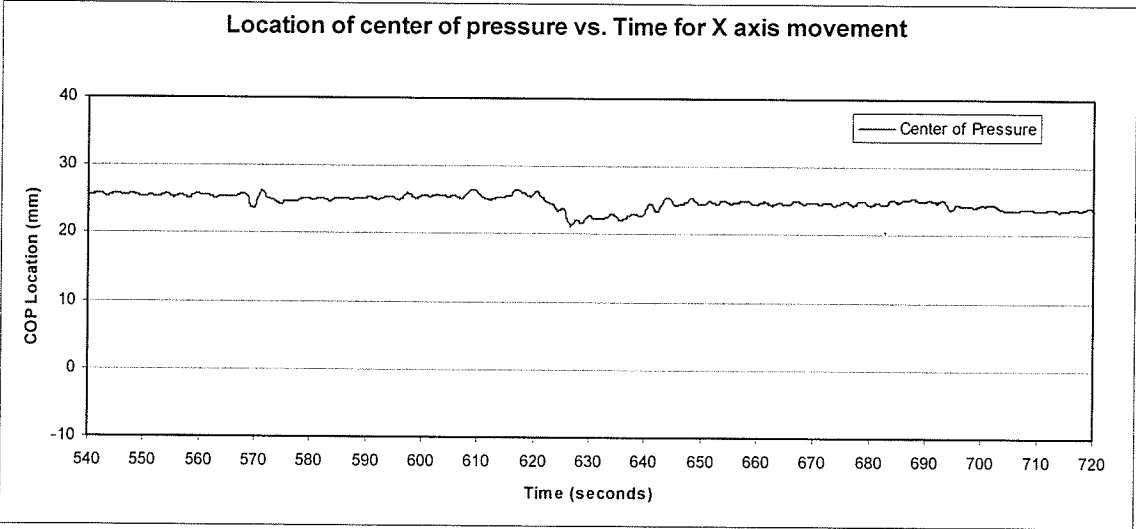

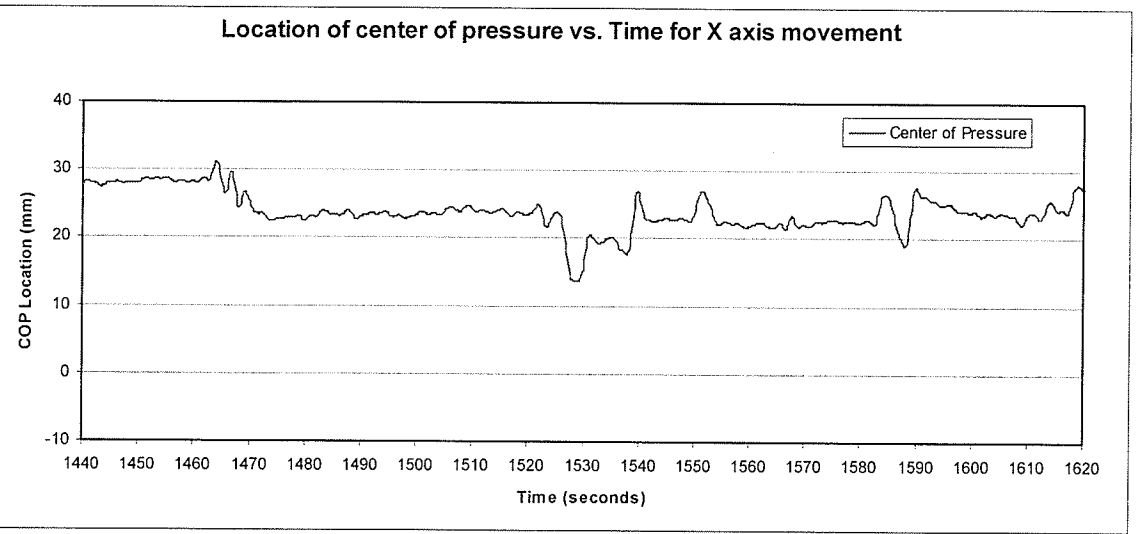
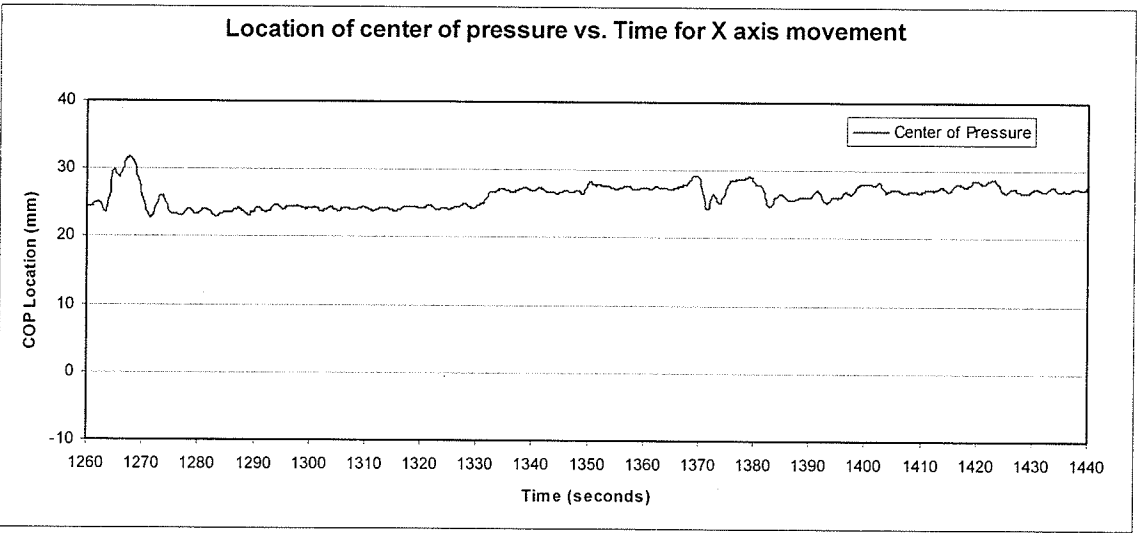
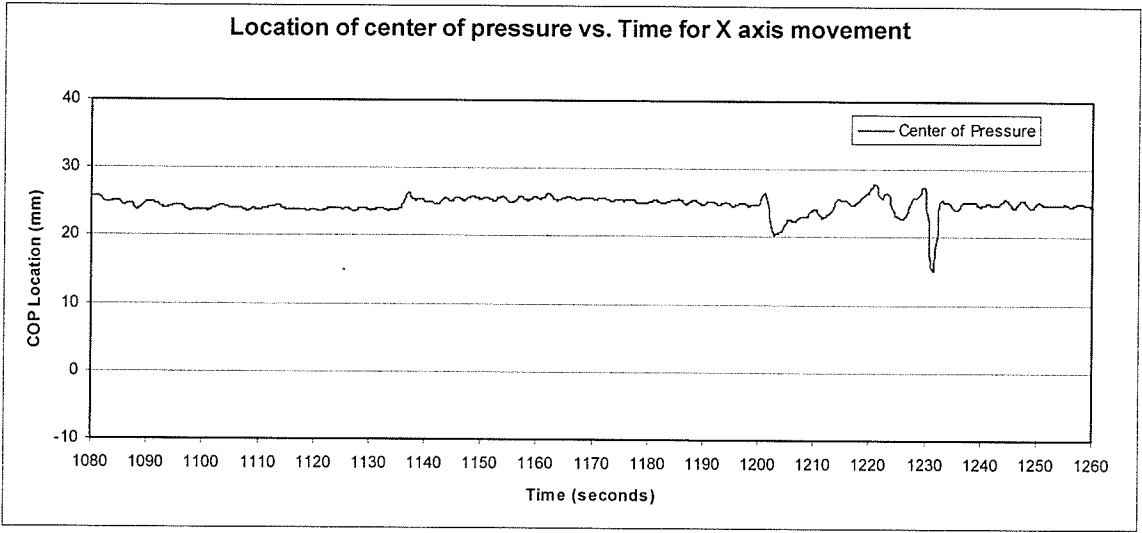

Location of center of pressure vs. Time for X axis movement

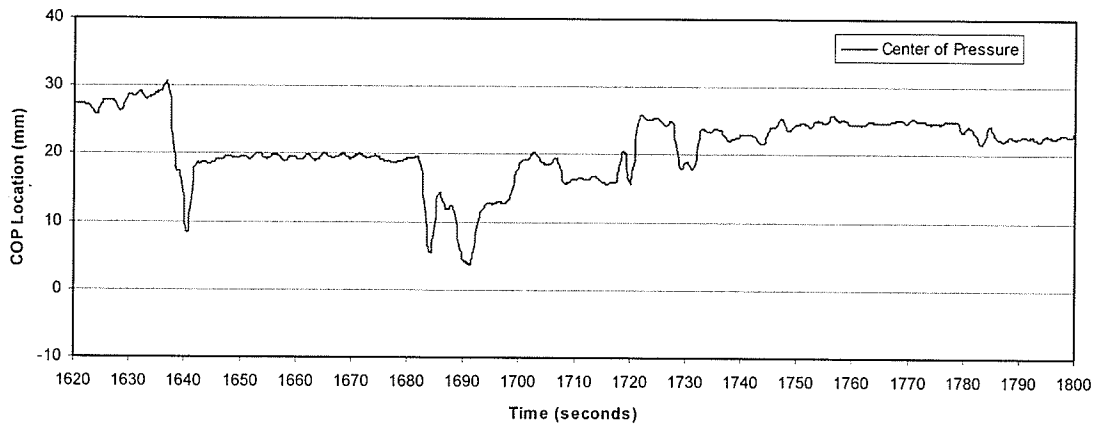

Location of center of pressure vs. Time for Y axis movement

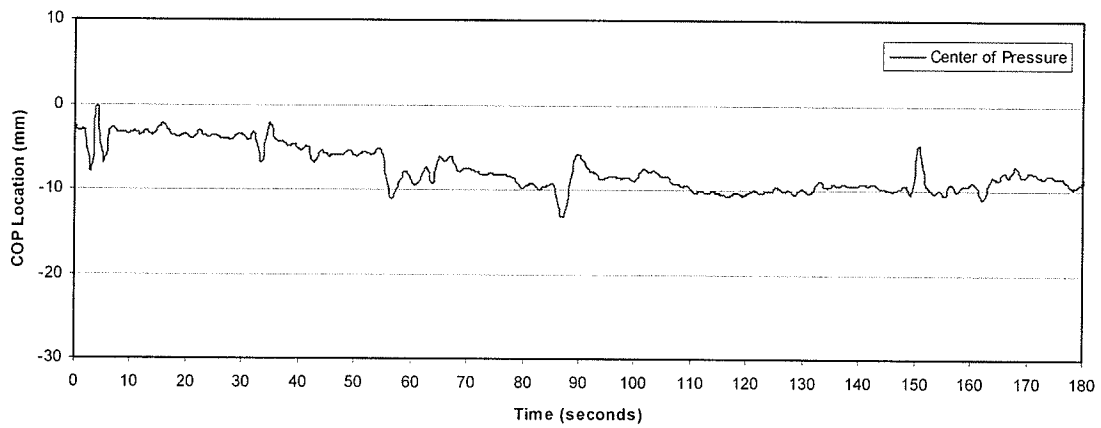

Location of center of pressure vs. Time for Y axis movement

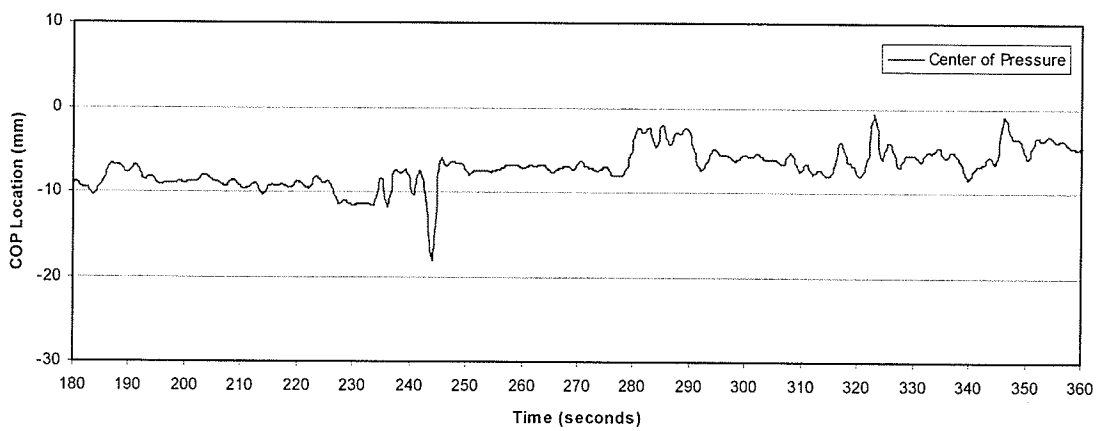

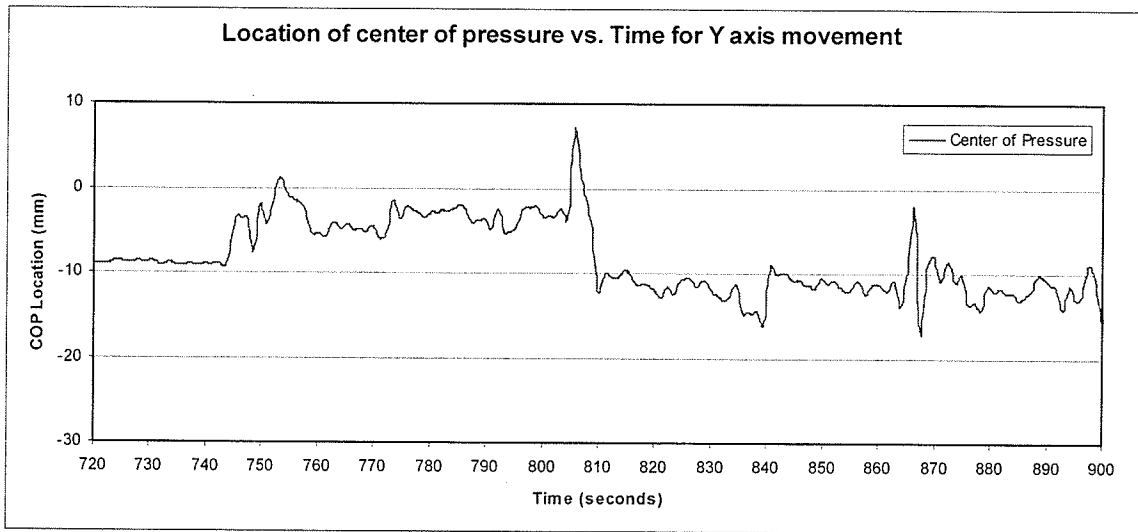
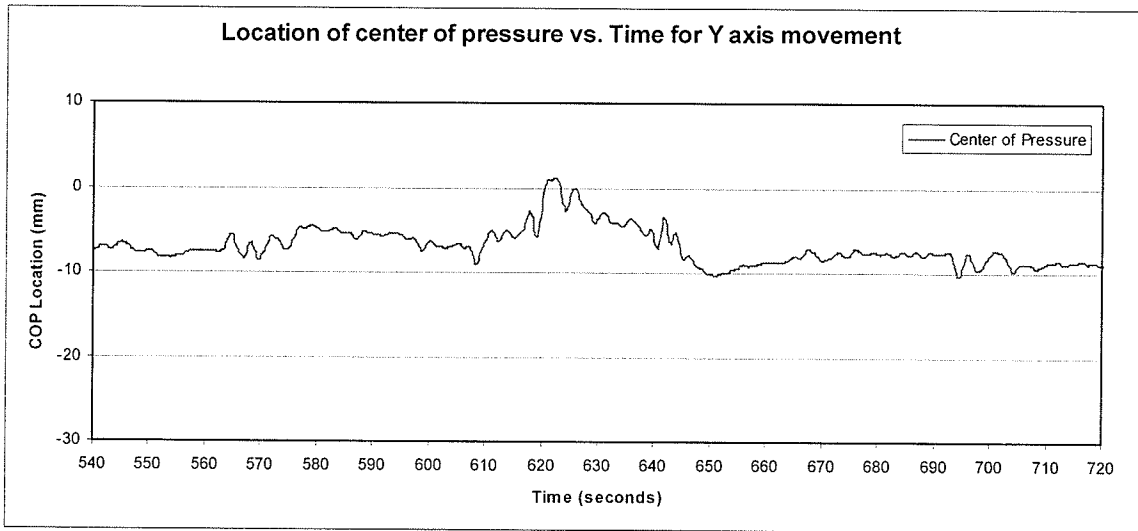
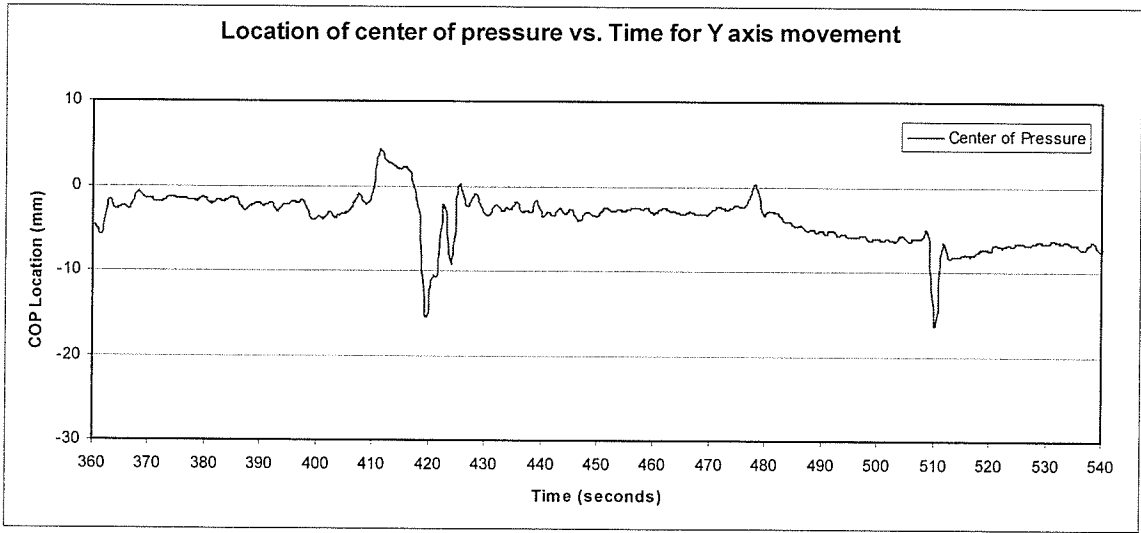

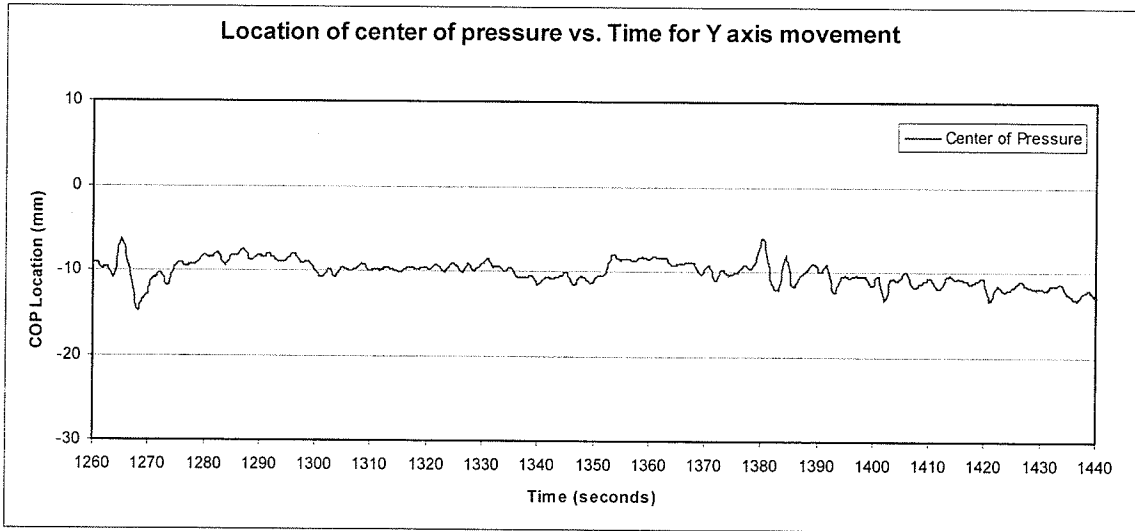
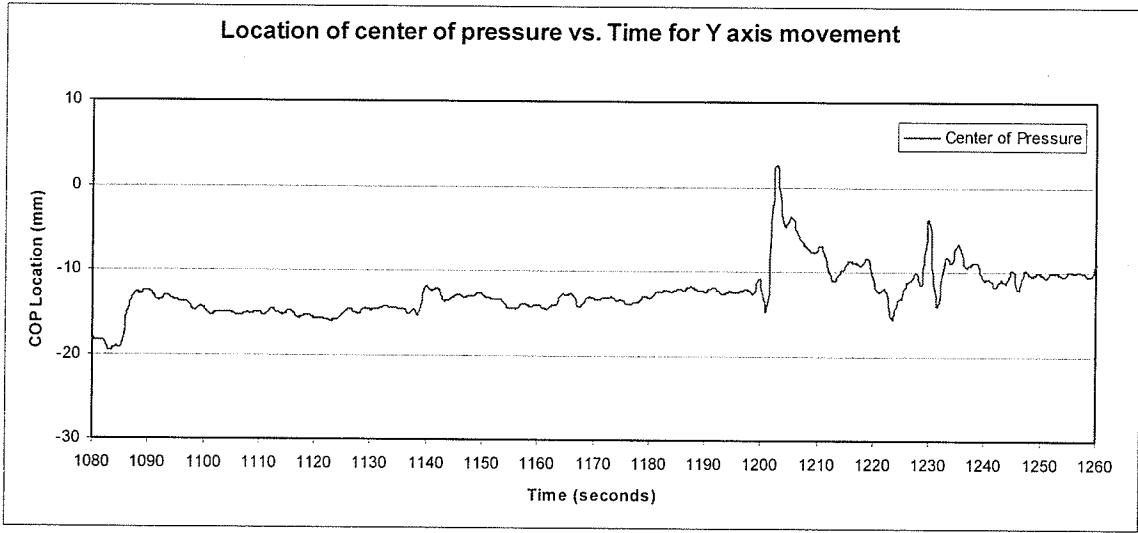
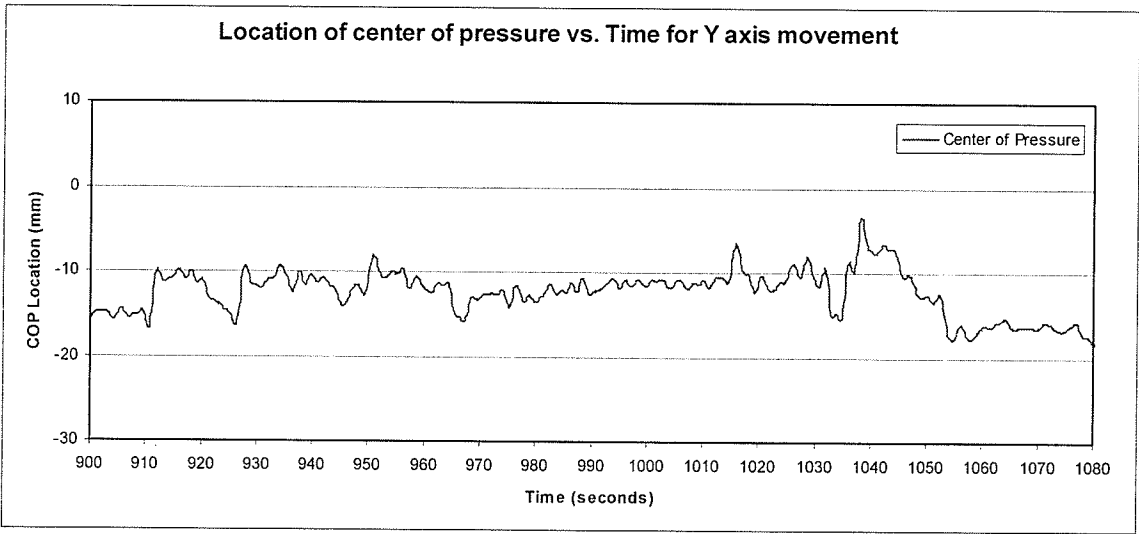

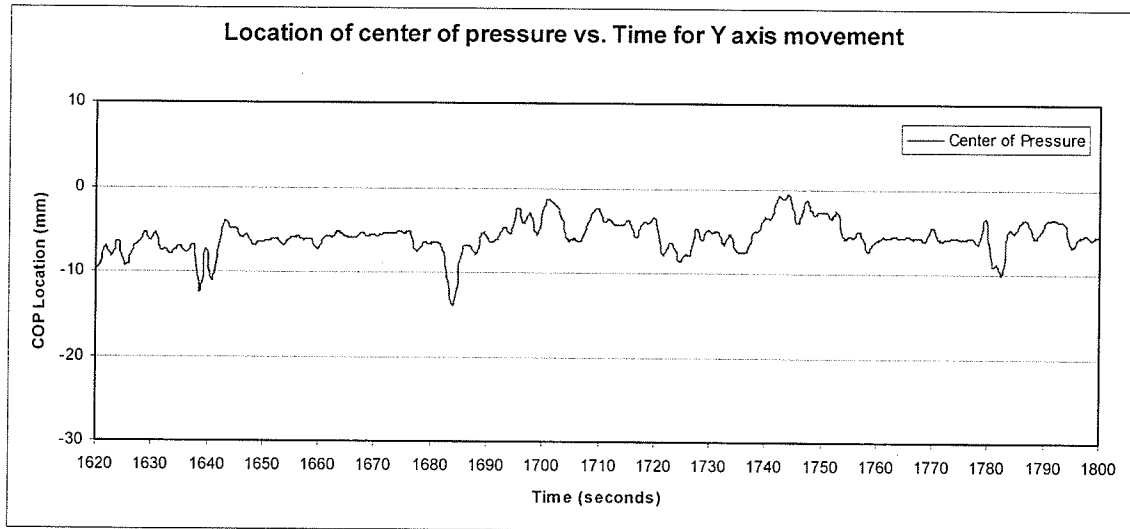
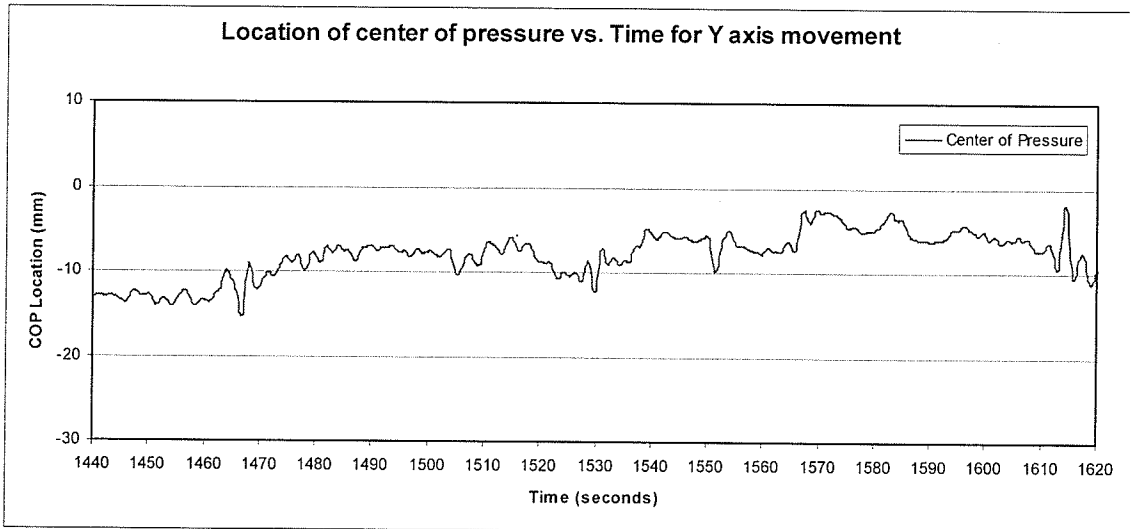

Subject - 2X	Manual Pattern Identification Chart
Approximate Time (seconds)	Pattern Description
1st order begins - 63 to 149	
	Drift - approximate amplitude of 7 mm (17 to 24)
446 to 540	Drift - approximate amplitude of 5 mm (21 to 26)
1030	Shift - approximate amplitude of 25 mm (31 to 6) (potential drifting on either side of shift, see 2nd order id sheet)
1274 to 1462	Drift - approximate amplitude of 5 mm (23 to 28)
2nd order begins - 807	
	Shift - approximate amplitude of 10 mm (22 to 12) definite shift, although actual amplitude of shift may be less than 10 as there is fidget-like pattern associated with shift
864	Fidget - approximate amplitude of 16 mm (20 to 4)
964	Shift - approximate amplitude of 12 mm (27 to 15)
965 to 995	Drift - approximate amplitude of 10 mm (15 to 25) (may be considered longer, because after a bit of a plateau the COP drifts again)
1032 to 1080	Drift - approximate amplitude of 19 mm (7 to 26)
1524	Shift - approximate amplitude of 10 mm (24 to 14)
1634	Shift - approximate amplitude of 12 mm (30 to 18)
1719	Shift - approximate amplitude of 10 mm (16 to 26)
3rd order begins - 2	
	Fidget - approximate amplitude of 13 mm (23 to 10)
60	Shift - approximate amplitude of 6 mm (23 to 17)
153	Shift - approximate amplitude of 5 mm (26 to 21)
160	Shift - approximate amplitude of 6 mm (24 to 30)
236	Shift - approximate amplitude of 5 mm (29 to 24)
241	Shift - approximate amplitude of 6 mm (26 to 20)
290	Shift - approximate amplitude of 6 mm (21 to 27)
350	Shift - approximate amplitude of 5 mm (26 to 21)
429	Shift - approximate amplitude of 8 mm (13 to 21) isn't as easily seen as shift in raw data
1202	Shift - approximate amplitude of 5 mm (25 to 20)
1230	Fidget - approximate amplitude of 11 mm (26 to 15)
1263	Shift - approximate amplitude of 6 mm (24 to 30)
1269	Shift - approximate amplitude of 7 mm (30 to 23)
1529	Shift - approximate amplitude of 7 mm (13 to 20)
1538	Shift - approximate amplitude of 6 mm (17 to 23)
1687	Shift - approximate amplitude of 9 mm (13 to 4)
1692	Shift - approximate amplitude of 9 mm (4 to 13)
1697	Shift - approximate amplitude of 6 mm (13 to 19)
1726	Shift - approximate amplitude of 7 mm (25 to 18)
1731	Shift - approximate amplitude of 6 mm (18 to 24)
4th order begins - None	

Subject - 2Y	Manual Pattern Identification Chart
Approximate Time (seconds)	Pattern Description
1st order begins - 5 to 86	Drift - approximate amplitude of 7mm (-3 to -10)
1353 to 1454	Drift - approximate amplitude of 5 mm (-8 to -13)
2nd order begins - 620 to 650	Drift - approximate amplitude of 11 mm (1 to -10)
1453 to 1490	Drift - approximate amplitude of 6 mm (-14 to -8)
3rd order begins - 54	Shift - approximate amplitude of 6 mm (-5 to -11)
241	Fidget - approximate amplitude of 11 mm (-7 to -18)
278	Shift - approximate amplitude of 5 mm (-8 to -3)
408	Shift - approximate amplitude of 6 mm (-2 to 4)
508	Fidget - approximate amplitude of 10 mm (-6 to -16)
619	Shift - approximate amplitude of 7 mm (-6 to 1)
741	Shift - approximate amplitude of 5 mm (-9 to -4)
840	Shift - approximate amplitude of 5 mm (-15 to -10)
863	Fidget - approximate amplitude of 12 mm (-14 to -2)
910	Shift - approximate amplitude of 6 mm (-16 to -10)
925	Shift - approximate amplitude of 7mm (-16 to -9)
1051	Shift - approximate amplitude of 5 mm (-13 to 18)
1084	Shift - approximate amplitude of 6 mm (-19 to -13)
4th order begins - 415	Fidget - approximate amplitude of 15 mm (0 to -15) slightly double-peaked with second less than first may also be too wide at base

Subject 3

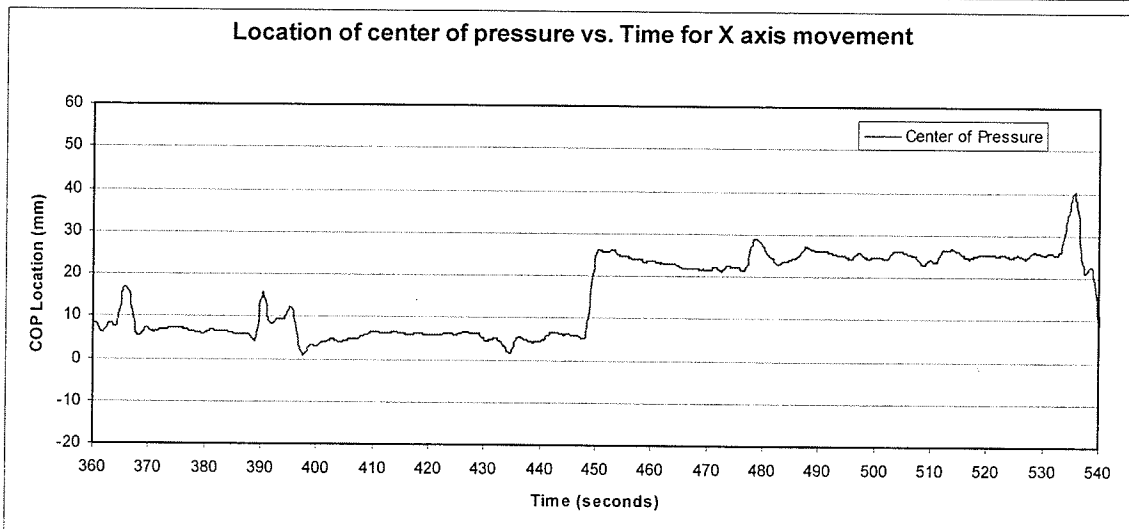
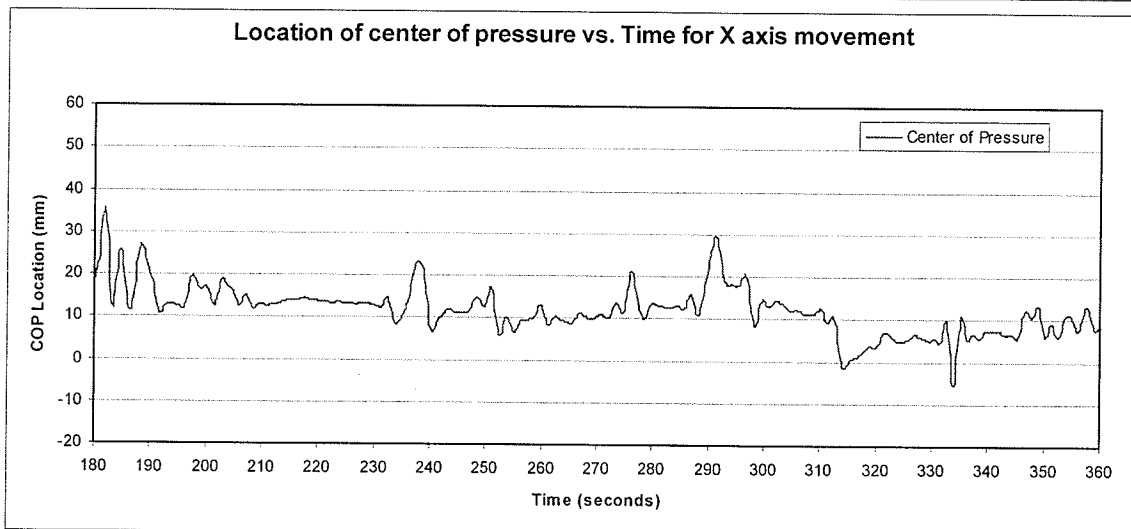
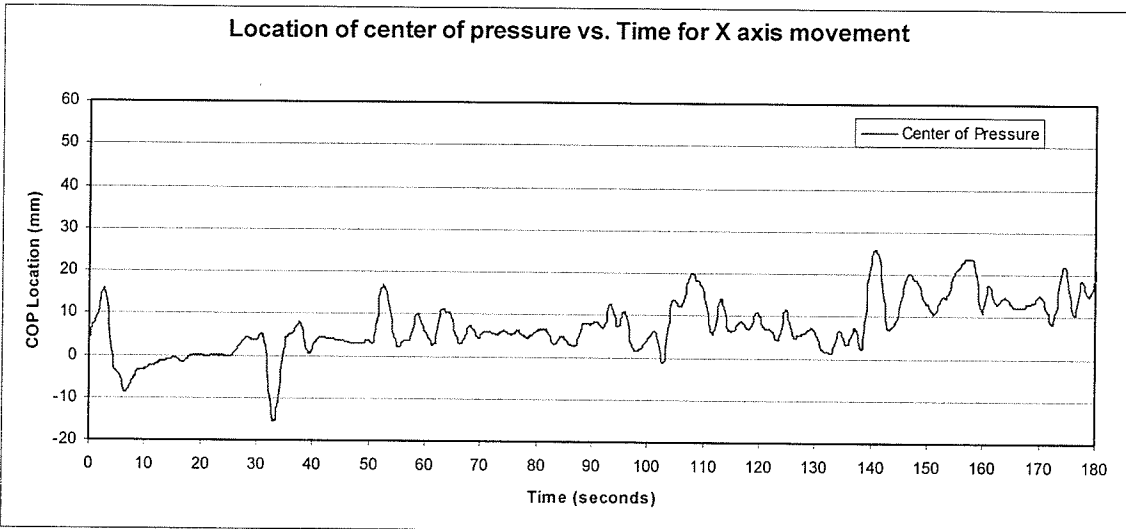

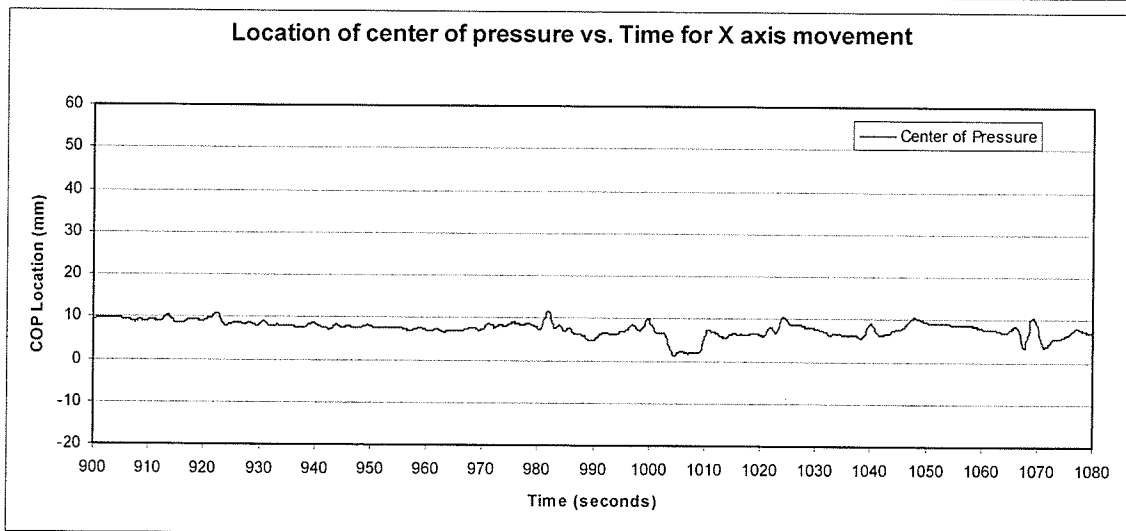
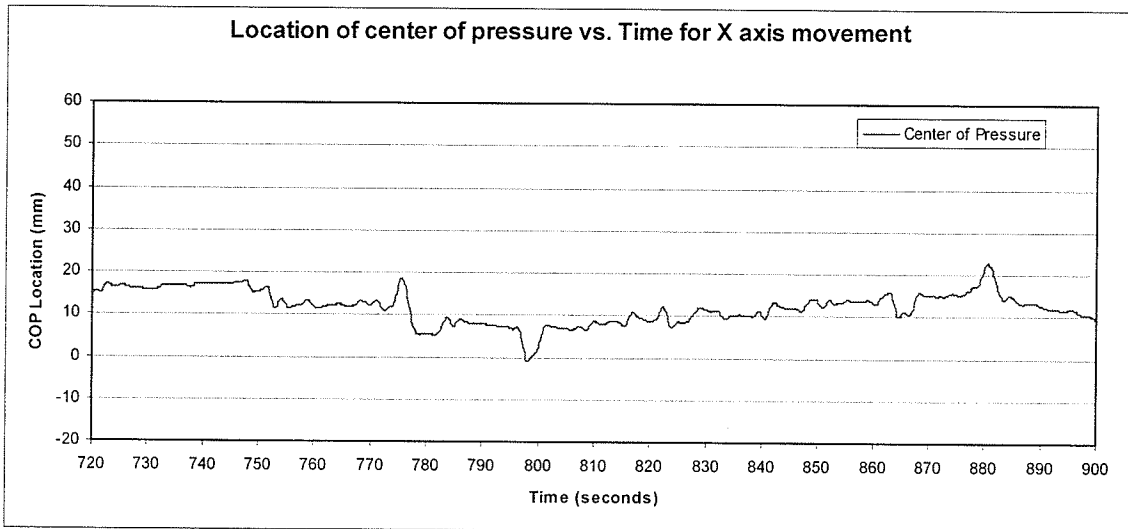
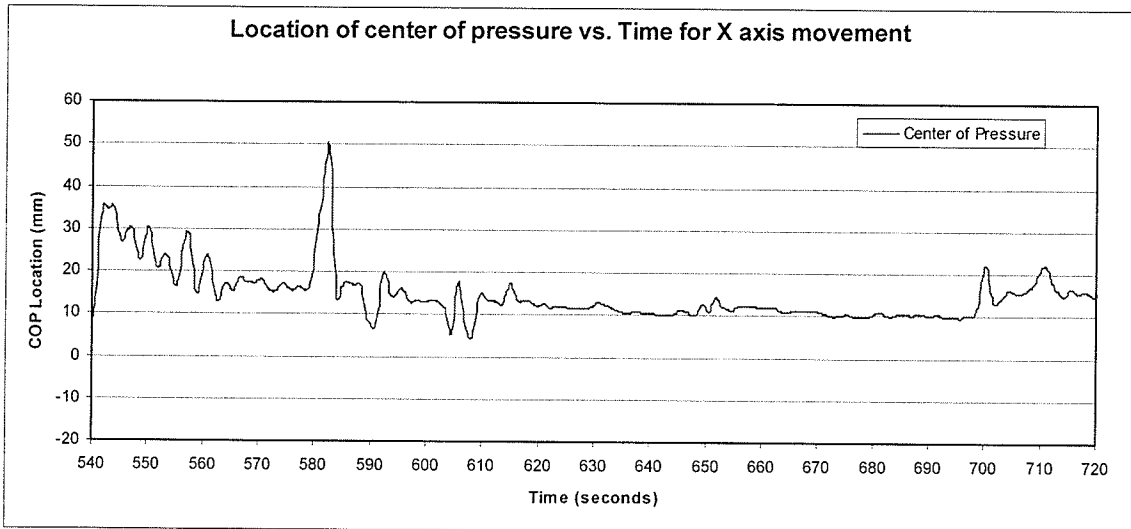

Location of center of pressure vs. Time for X axis movement

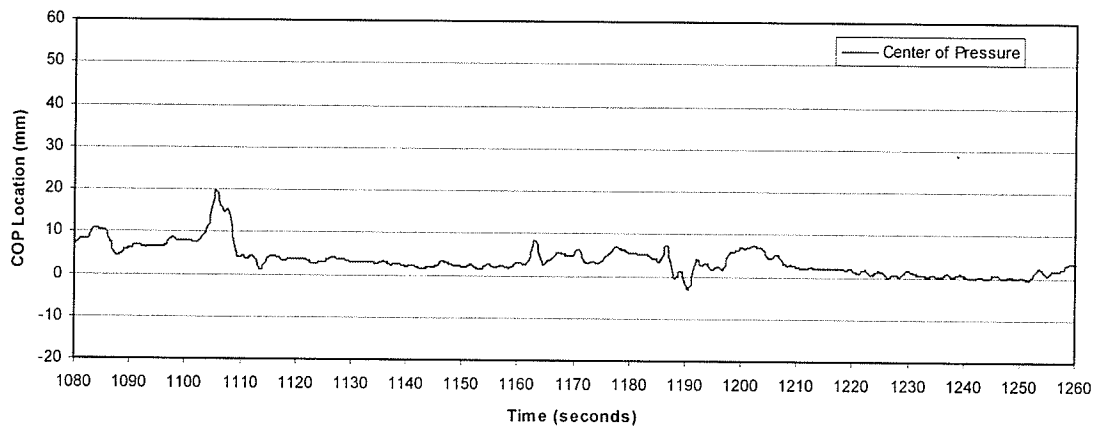

Location of center of pressure vs. Time for X axis movement

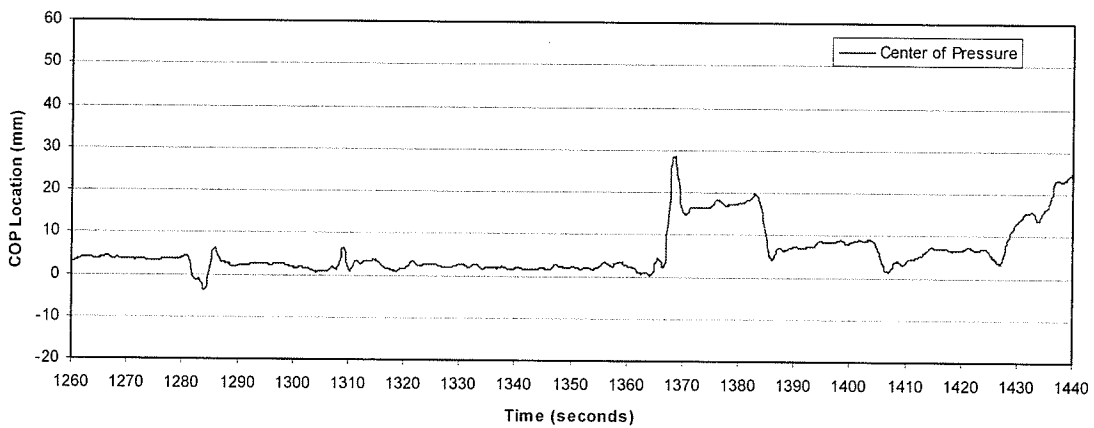

Location of center of pressure vs. Time for X axis movement

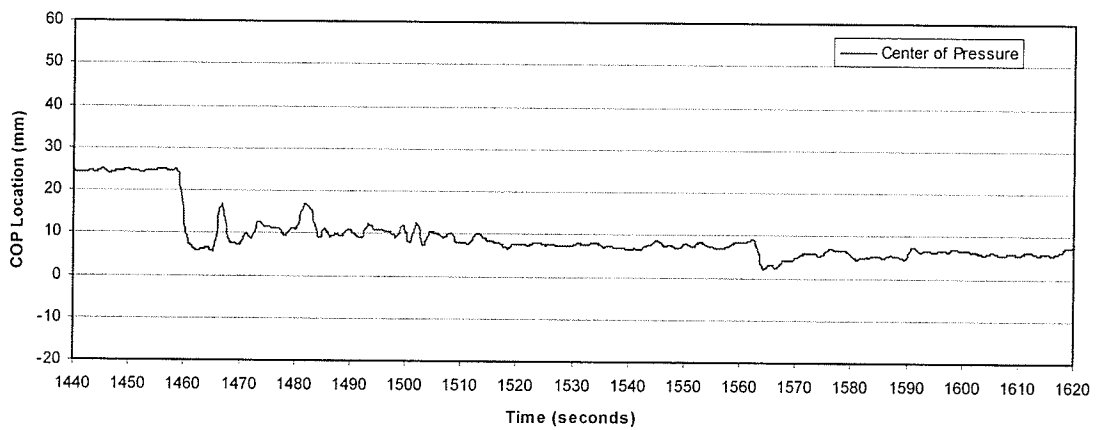

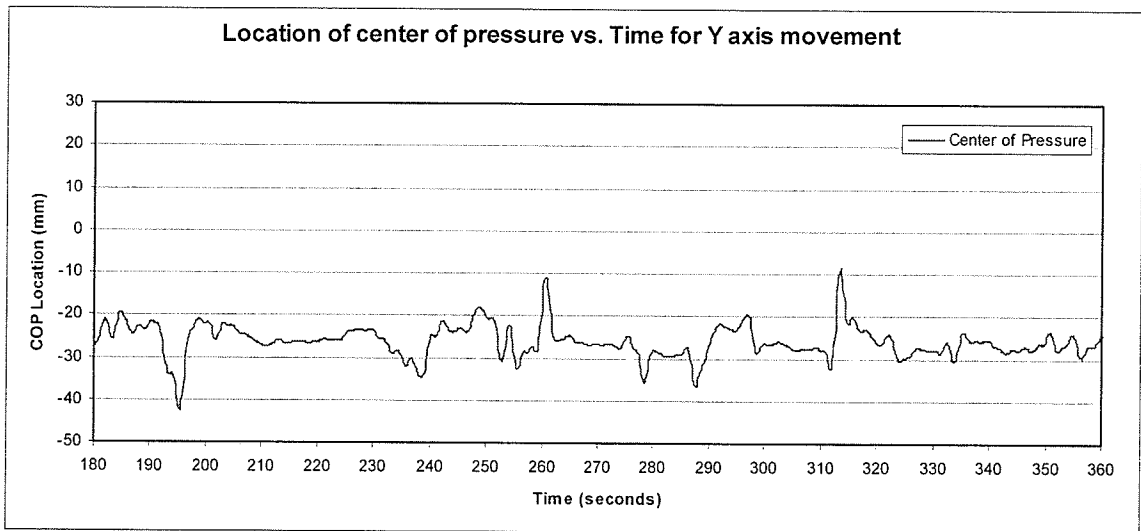
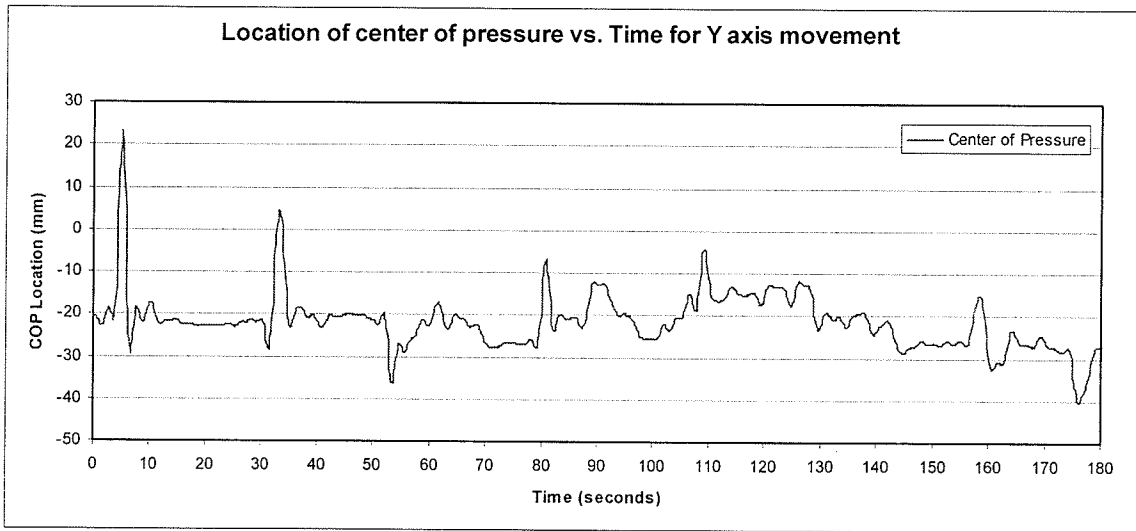
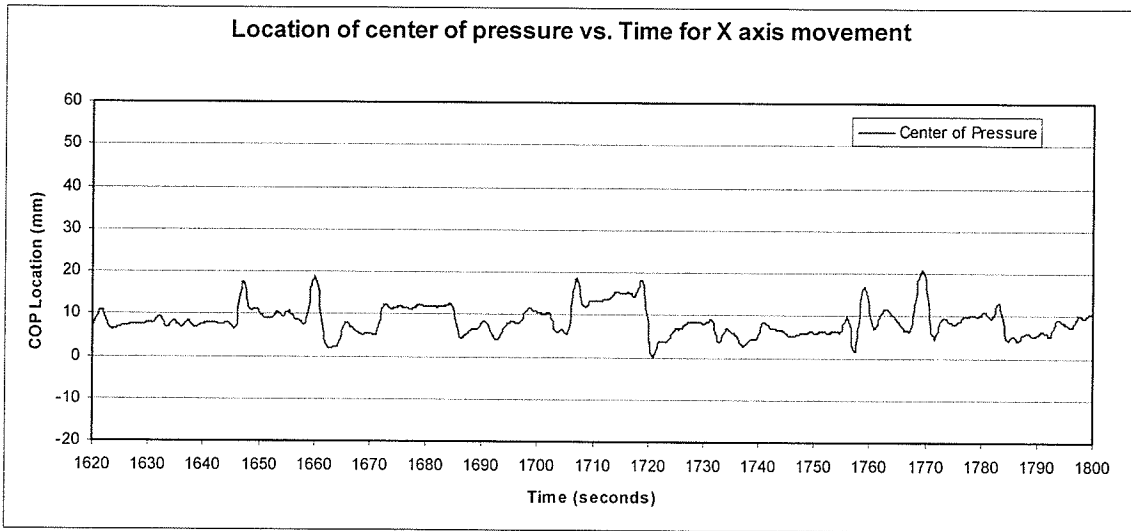

Location of center of pressure vs. Time for Y axis movement

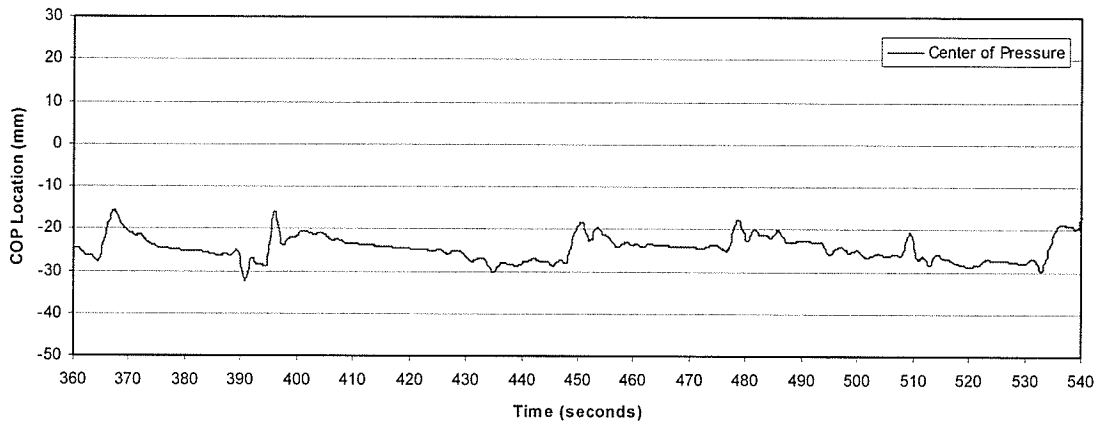

Location of center of pressure vs. Time for Y axis movement

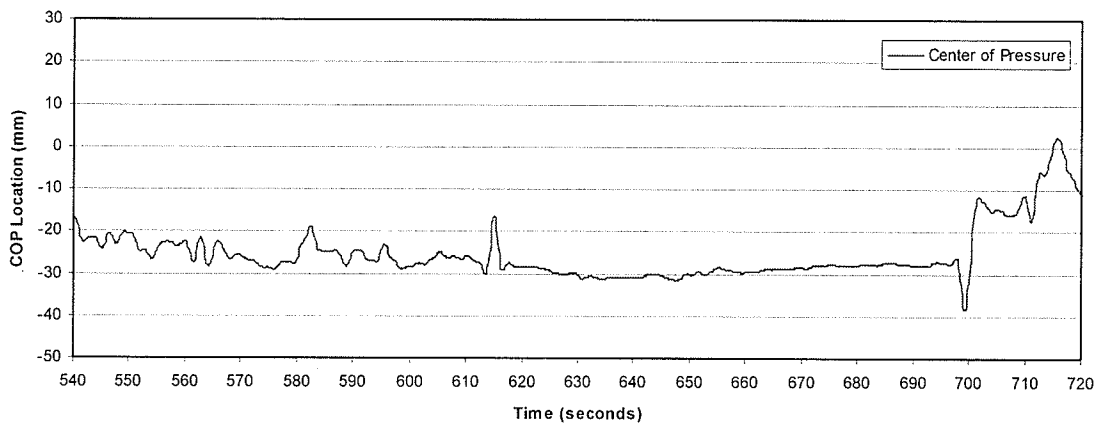

Location of center of pressure vs. Time for Y axis movement

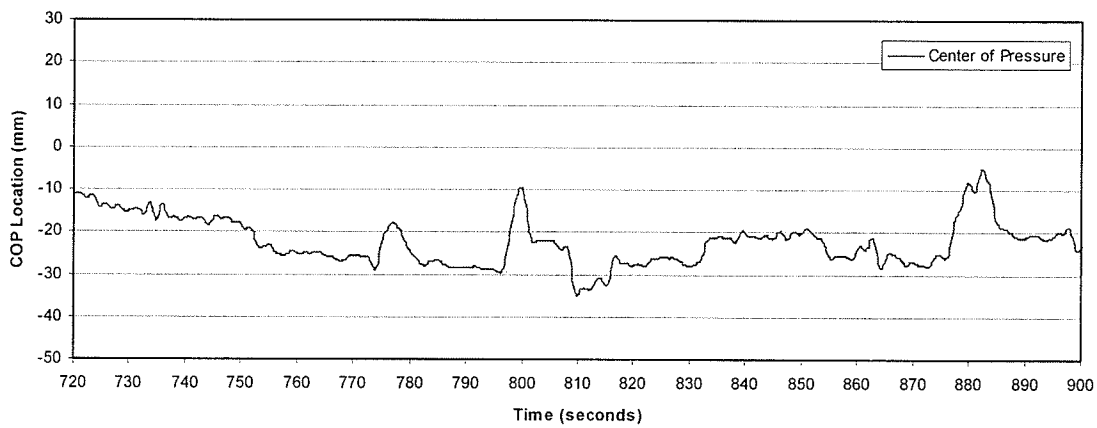

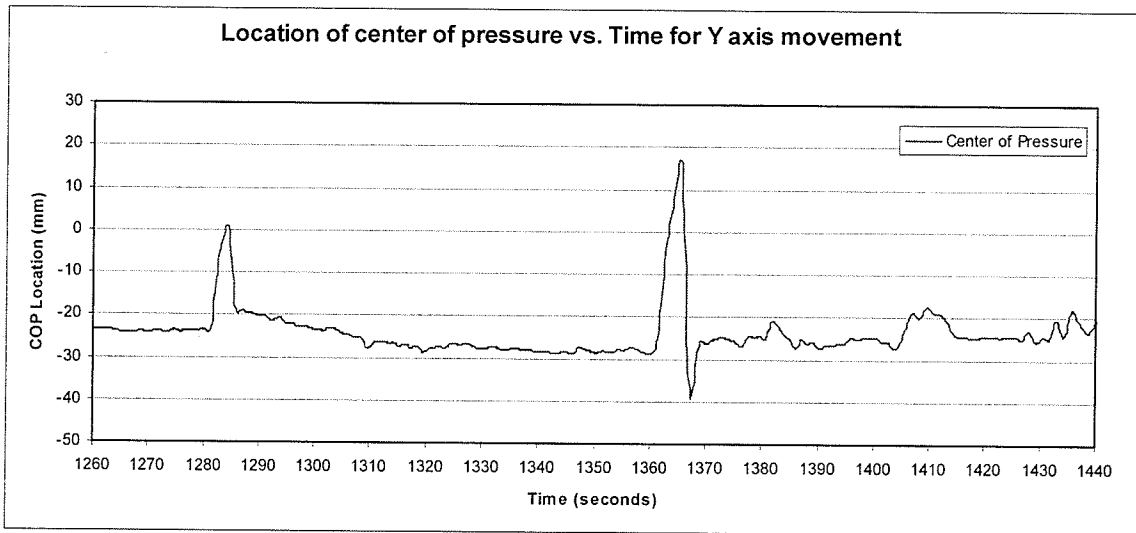
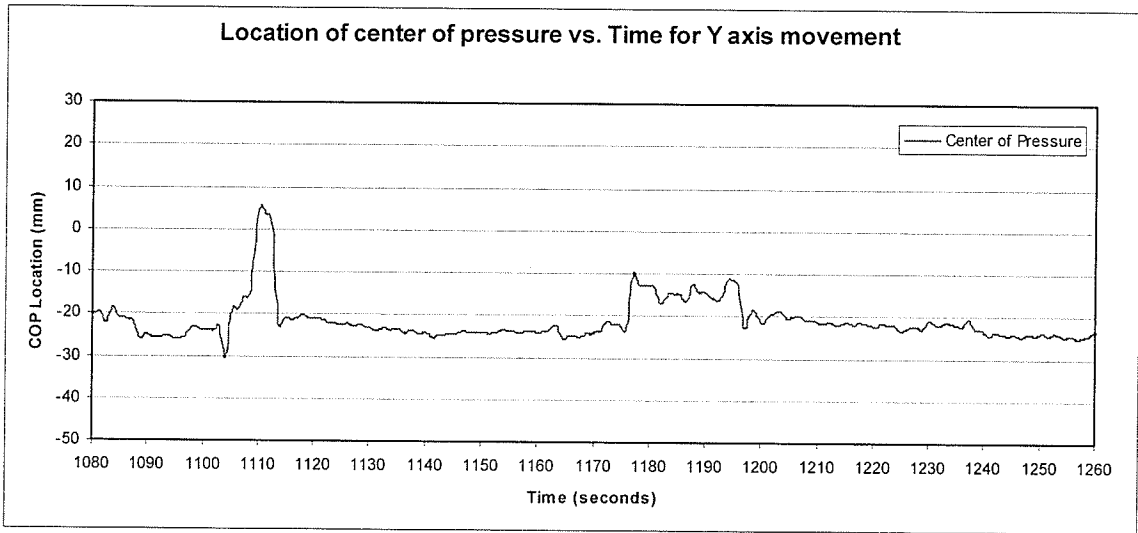
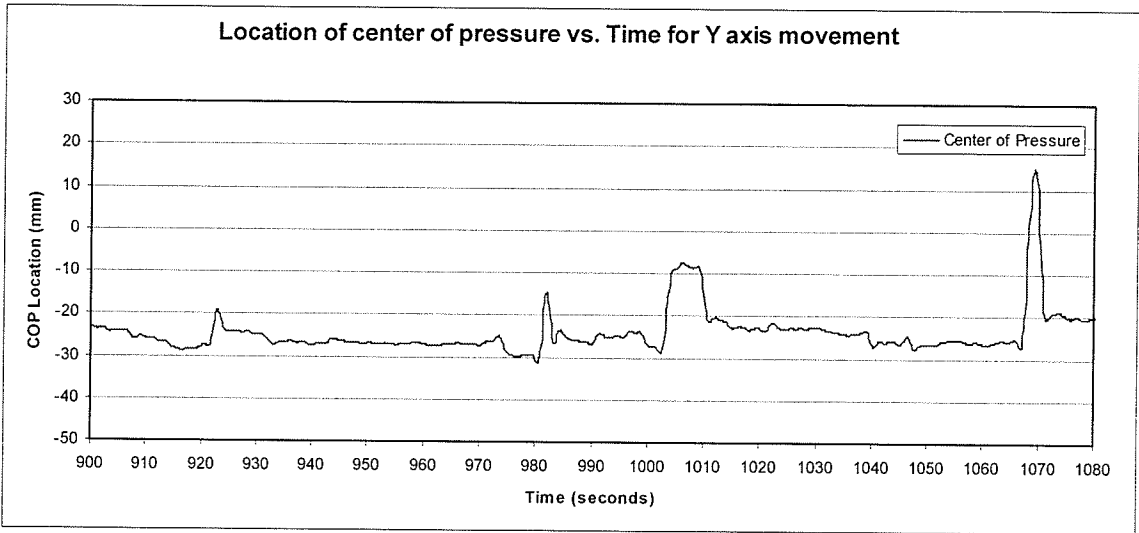

Location of center of pressure vs. Time for Y axis movement

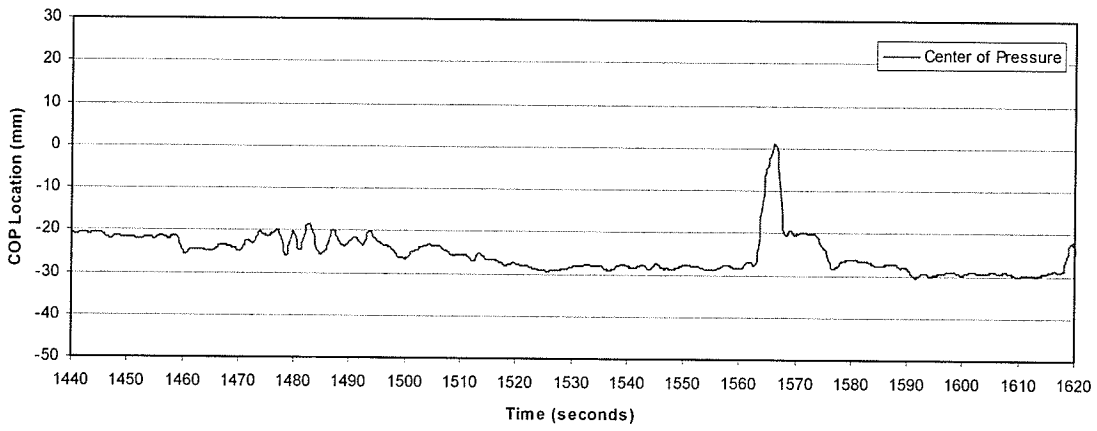

Location of center of pressure vs. Time for Y axis movement

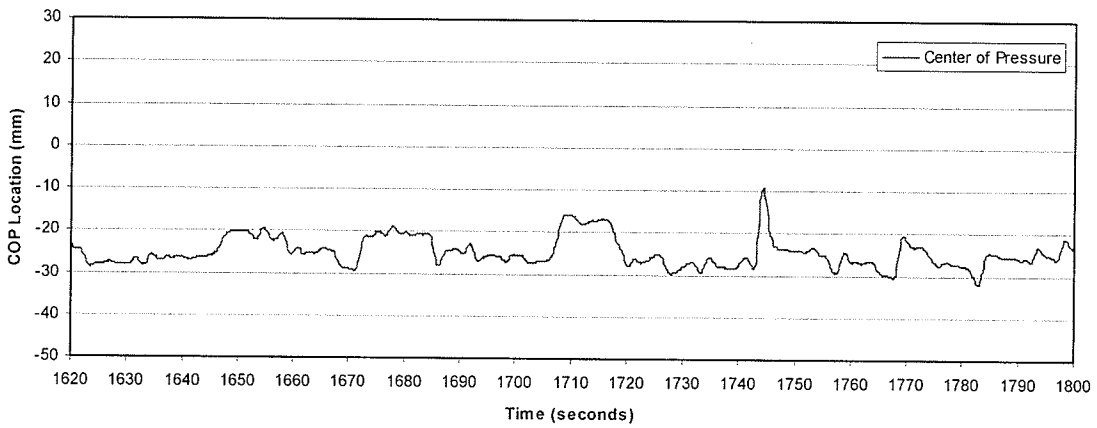

Subject - 3X	Manual Pattern Identification Chart
Approximate Time (seconds)	Pattern Description
1st order begins - 447	Shift - approximate amplitude of 21 mm (5 to 26)
542 to 680	Drift - approximate amplitude of 26 mm (36 to 10)
579	Fidget - approximate amplitude of 34 mm (16 to 50)
801 to 862	Drift - approximate amplitude of 8 mm (8 to 16)
2nd order begins - 31	Fidget - approximate amplitude of 20 mm (5 to -15)
139	Fidget - approximate amplitude of 19 mm (7 to 26)
179	Fidget - approximate amplitude of 21 mm (15 to 36)
311	Shift - approximate amplitude of 11 mm (10 to -1)
314 to 360	Drift - approximate amplitude of 10 mm (-1 to 9)
332	Fidget - approximate amplitude of 16 mm (10 to -6) pattern book-ended by peaks
533	Fidget - approximate amplitude of 15 mm (25 to 40)
1367	Shift - approximate amplitude of 13 mm (2 to 15) overshoot which may be considered a separate fidget
1382	Shift - approximate amplitude of 14 mm (20 to 6)
1457	Shift - approximate amplitude of 18 mm (25 to 7)
1720	Shift - approximate amplitude of 15 mm (17 to 2)
3rd order begins - 50	Fidget - approximate amplitude of 14 mm (3 to 17)
87	Shift - approximate amplitude of 5 mm (3 to 8)
173	Fidget - approximate amplitude of 12 mm (10 to 22)
183	Fidget - approximate amplitude of 14 mm (12 to 16)
275	Fidget - approximate amplitude of 10 mm (11 to 21)
363	Fidget - approximate amplitude of 10 mm (8 to 18)
395	Shift - approximate amplitude of 9 mm (10 to 1) bit of a peak on top of slope, which was not included in ampl.
555	Fidget - approximate amplitude of 14 mm (16 to 30)
587	Fidget - approximate amplitude of 10 mm (17 to 7) base may be too wide, but fits parameters in raw data it doesn't exactly appear to be a fidget
776	Shift - approximate amplitude of 7 mm (12 to 5) fidget at beginning was not included in amplitude
863	Shift - approximate amplitude of 6 mm (16 to 10)
867	Shift - approximate amplitude of 6 mm (16 to 10)
1003	Shift - approximate amplitude of 6 mm (7 to 1)
1009	Shift - approximate amplitude of 5 mm (2 to 7)
1086	Shift - approximate amplitude of 6 mm (10 to 4)
1280	Shift - approximate amplitude of 5 mm (4 to -1)
1285	Shift - approximate amplitude of 9 mm (-3 to 6)
1404	Shift - approximate amplitude of 8 mm (9 to 1)

Approximate Time (seconds)	Pattern Description
1465	Fidget - approximate amplitude of 10 mm (7 to 17)
1562	Shift - approximate amplitude of 7 mm (9 to 2)
1663	Shift - approximate amplitude of 6 mm (2 to 8)
1670	Shift - approximate amplitude of 7 mm (5 to 12)
1684	Shift - approximate amplitude of 8 mm (12 to 4)
1705	Shift - approximate amplitude of 7 mm (5 to 12) peak at beginning of shift before settling to shift value
1767	Fidget - approximate amplitude of 14 mm (6 to 20)
4th order begins - 60	Shift - approximate amplitude of 9 mm (2 to 11)
64	Shift - approximate amplitude of 7 mm (10 to 3) along with previous pattern, may not be sufficient data points between them to constitute a change in average COP value
186	Fidget - approximate amplitude of 16 mm (11 to 27) base may be too wide to constitute a fidget
233	Fidget - approximate amplitude of 15 mm (8 to 23) base may be too wide to constitute a fidget
250	Shift - approximate amplitude of 11 mm (17 to 6) COP appears to shift, however shift amplitude is not certain because of peaks at beginning and end of shift
288	Shift - approximate amplitude of 6 mm (12 to 18) pattern begins with fidget-like overshoot and then settles to a shift not returning to previous average value of COP
537	Fidget - approximate amplitude of 16 mm (25 to 9) pattern may indeed be a fidget, but may be superseded by a shift
604	Fidget - approximate amplitude of 13 mm (5 to 18) COP value decreases before beginning of pattern and increases right after, so identification may be skewed
796	Shift - approximate amplitude of 8 mm (7 to -1) the value of the COP does not stay at a shifted value, but rather this almost looks like a compressed fidget
800	Shift - approximate amplitude of 6 mm (1 to 7)
1658	Shift - approximate amplitude of 5 mm (7 to 2) begins with a peak before settling to shift value

Subject - 3Y	
Manual Pattern Identification Chart	
Approximate Time (seconds)	Pattern Description
1st order begins - 4	Fidget - approximate amplitude of 44 mm (-19 to 23)
1285 to 1346	Drift - approximate amplitude of 9 mm (-20 to -29)
1360	Fidget - approximate amplitude of 46 mm (-29 to 17) smaller fidget follows which fits 3rd order parameters but it is greatly overshadowed by larger fidget, base may be too wide
2nd order begins - 31	Fidget - approximate amplitude of 28 mm (-23 to 5)
80	Fidget - approximate amplitude of 21 mm (28 to -7)
260	Fidget - approximate amplitude of 15 mm (-26 to -11)
364	Shift - approximate amplitude of 12 mm (-28 to -16)

400 to 439	Drift - approximate amplitude of 8 mm (-21 to -29)
447	Shift - approximate amplitude of 10 mm (-28 to -18)
481 to 520	Drift - approximate amplitude of 9 mm (-20 to -29)
533	Shift - approximate amplitude of 11 mm (-30 to -19)
697	Shift - approximate amplitude of 15 mm (-26 to -11) pattern begins with a fidget-like migration
716 to 773	Drift - approximate amplitude of 31 mm (2 to -29)
1002	Shift - approximate amplitude of 20 mm (-29 to -9)
1008	Shift - approximate amplitude of 12 mm (-9 to -21)
1011 to 1067	Drift - approximate amplitude of 8 mm (-20 to -28)
1176	Shift - approximate amplitude of 10 mm (-23 to -13)
1204 to 1257	Drift - approximate amplitude of 6 mm (-19 to -25)
1493 to 1525	Drift - approximate amplitude of 9 mm (-20 to -29)
1706	Shift - approximate amplitude of 10 mm (-27 to -17)
1717	Shift - approximate amplitude of 11 mm (-17 to -28)
3rd order begins - 88	Shift - approximate amplitude of 9 mm (-21 to -12)
108	Fidget - approximate amplitude of 13 mm (-17 to -4)
128	Shift - approximate amplitude of 8 mm (-12 to -20)
142	Shift - approximate amplitude of 8 mm (-21 to -29)
175	Fidget - approximate amplitude of 12 mm (-28 to -40)
239	Shift - approximate amplitude of 9 mm (-34 to -25)
297	Shift - approximate amplitude of 9 mm (-20 to -29)
613	Fidget - approximate amplitude of 13 mm (-30 to -17)
832	Shift - approximate amplitude of 6 mm (-27 to -21)
1195	Shift - approximate amplitude of 7 mm (-12 to -19)
1573	Shift - approximate amplitude of 9 mm (-20 to -29)
1671	Shift - approximate amplitude of 8 mm (-29 to -21)
1768	Shift - approximate amplitude of 7 mm (-30 to -23)
4th order begins - 80	Shift - approximate amplitude of 5 mm (-25 to -20) filtering may convolute
92	Shift - approximate amplitude of 8 mm (-12 to -20)
157	Shift - approximate amplitude of 5 mm (-27 to -32) preceded by a fidget which may or may not be considered an individual pattern, approx. amplitude of 12 mm (-27 to -15)
191	Fidget - approximate amplitude of 20 mm (-22 to -42)
311	Shift - approximate amplitude of 10 mm (-30 to -20) preceded by a fidget-like pattern before settling into shift however pattern may be considered fidget with a wider base
394	Shift - approximate amplitude of 5 mm (-29 to -24) begins with fidget-like pattern before settling
796	Shift - approximate amplitude of 8 mm (-30 to -22) pattern begins with fidget-like change before settling to value
980	Shift - approximate amplitude of 5 mm (-30 to -25) shift amplitude borders on lowest parameter, so fidget at beginning of shift may dominate

1067	Shift - approximate amplitude of 8 mm (-28 to -20)
	fidget-like pattern begins shift, has an ampl. greater than 30 mm
1107 and 1111	Shift(s) - approximate amplitudes of 22 mm (-16 to 6) and 25 mm (4 to -21), pattern may be too narrow for shifts, too wide for fidget
1281	Shift - approximate amplitude of 4 mm (-24 to -20) does not fit shift parameters, so fidget at beginning may or may not dominate, approximate amplitude of 21 mm (-20 to 1)
1562	Shift - approximate amplitude of 8 mm (-28 to -20) begins with fidget-like movement before settling, approximate amplitude of 21 mm (-20 to 1)
1742	Shift - approximate amplitude of 5 mm (-29 to -24) fidget-like movement begins shift before settling, approximate amplitude of 14 mm (-24 to -10)

Subject 6

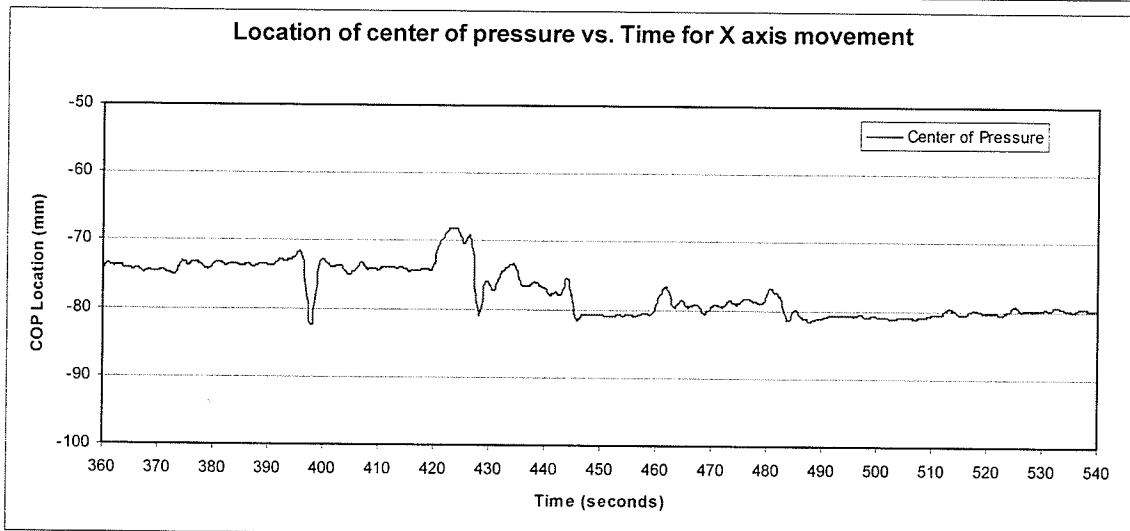
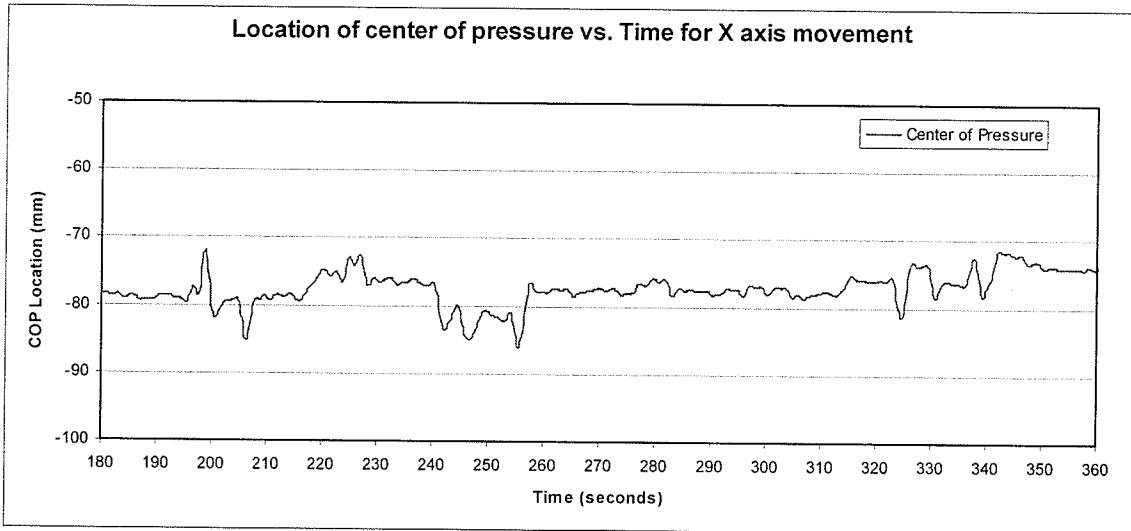
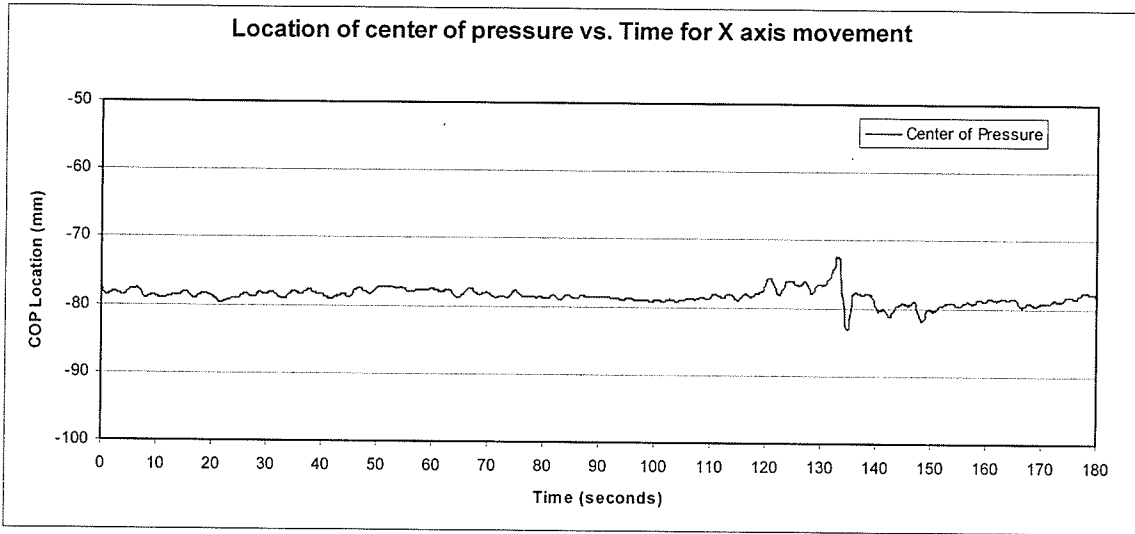

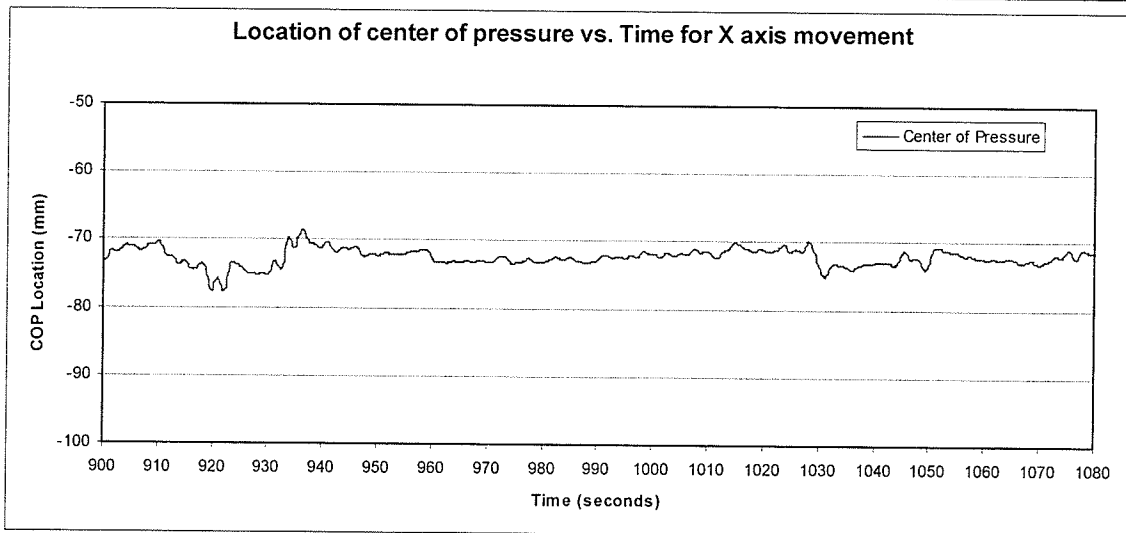
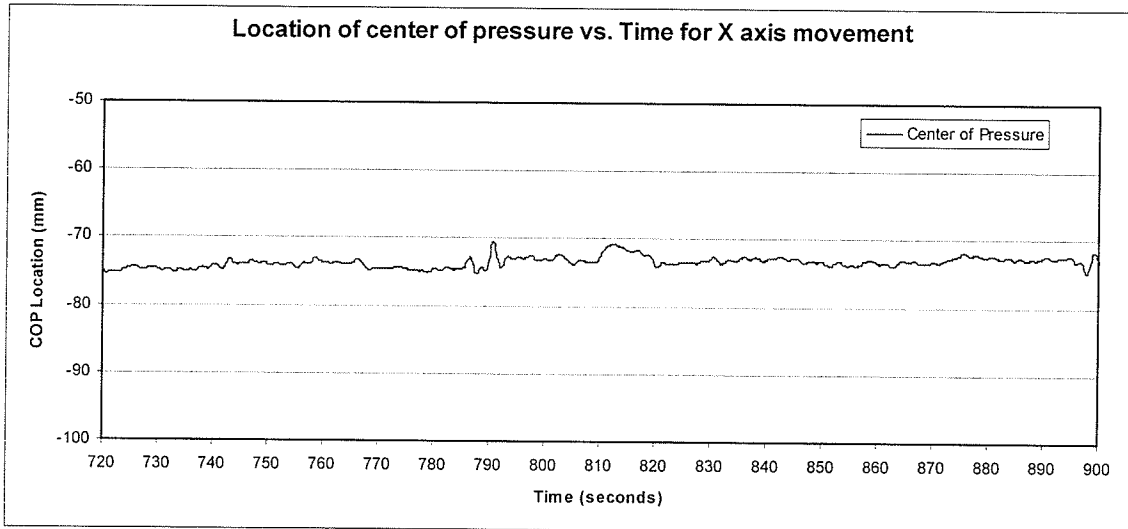
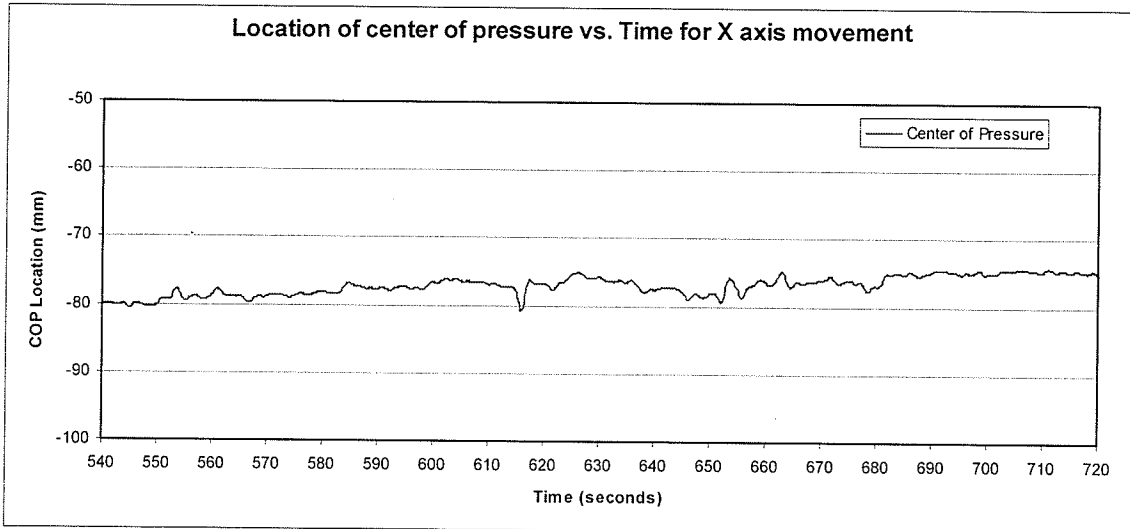

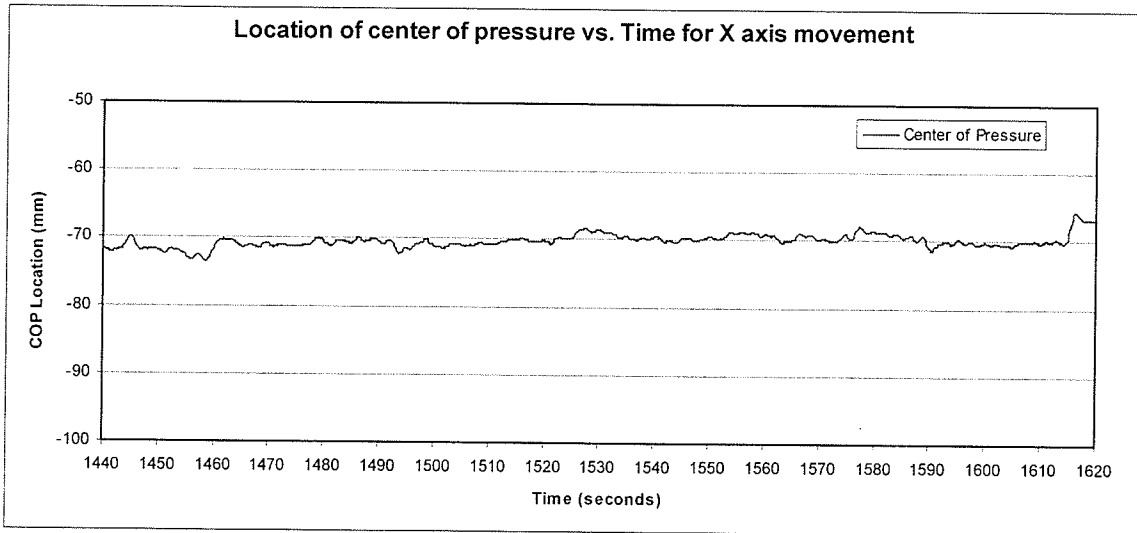
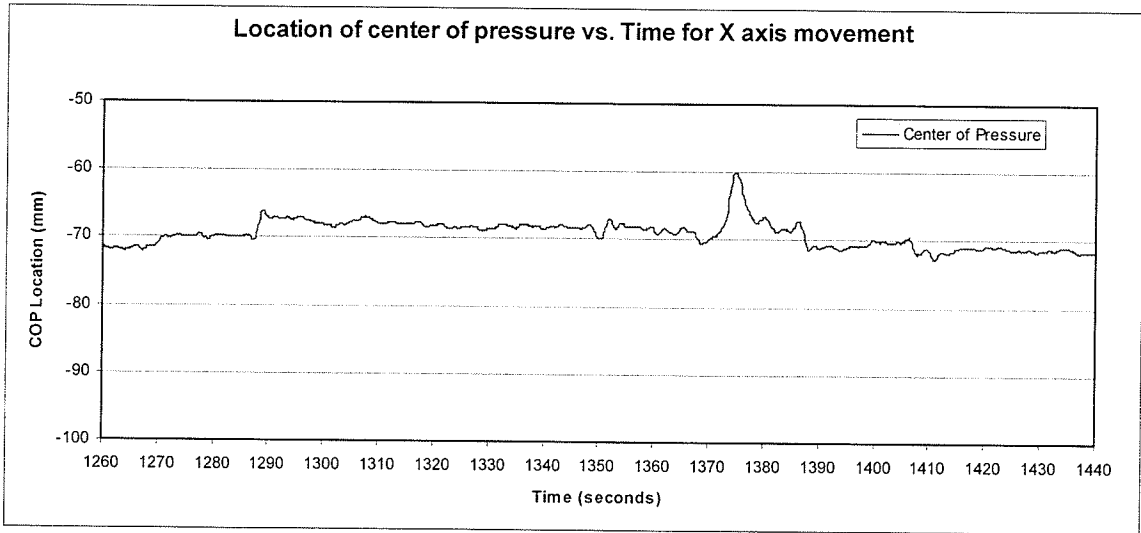
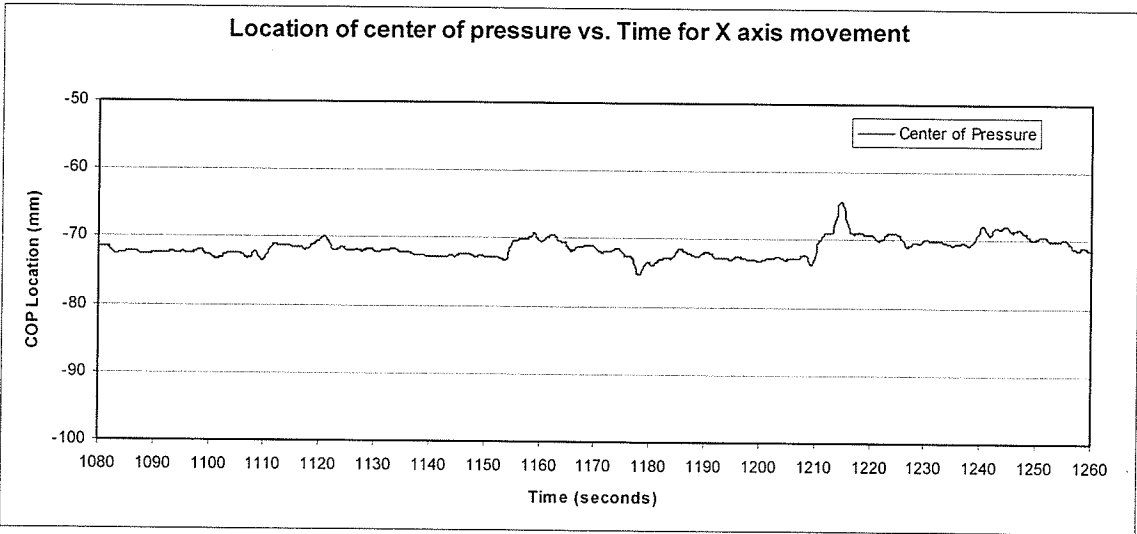

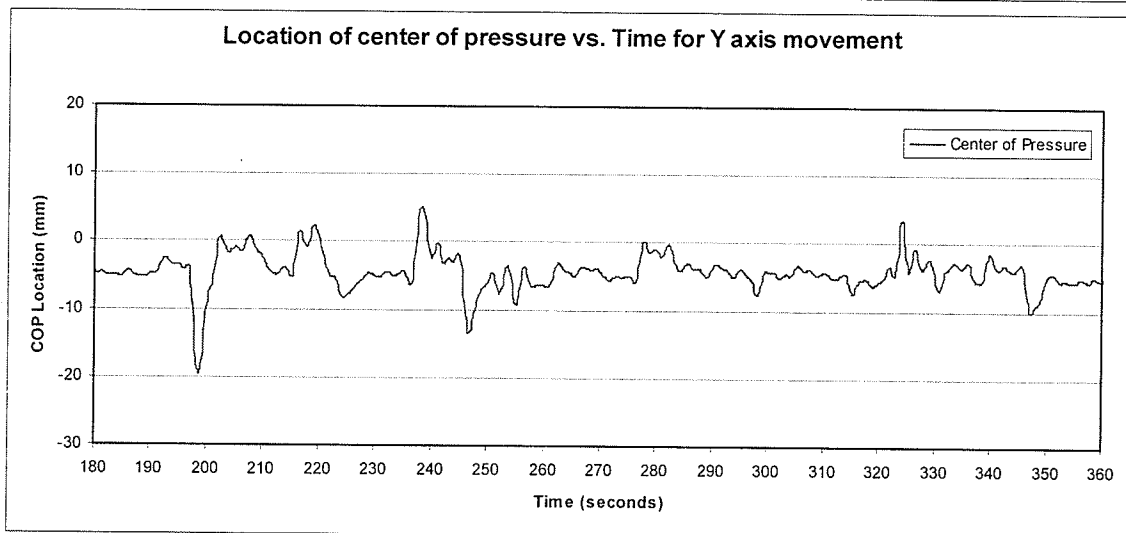
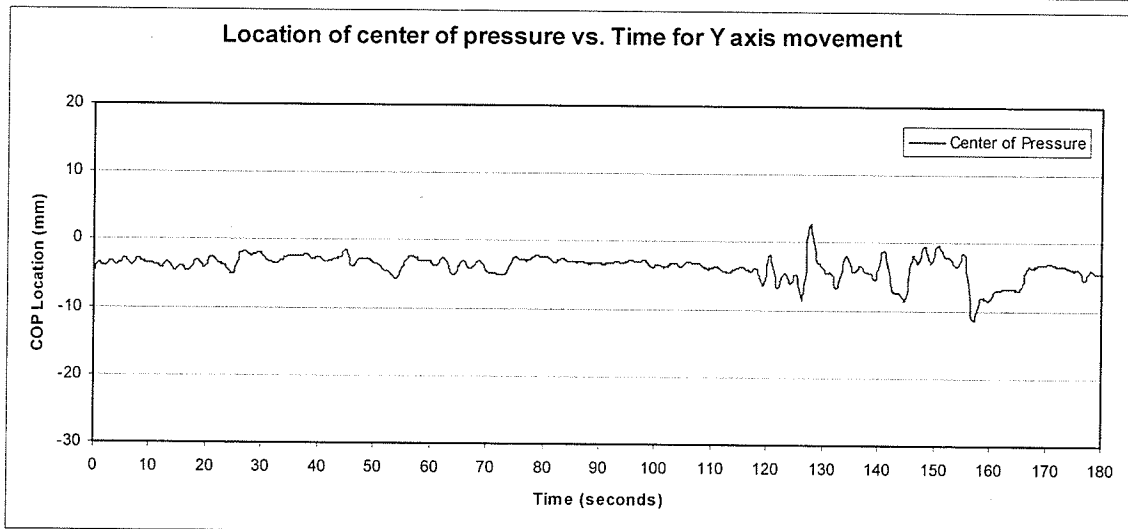
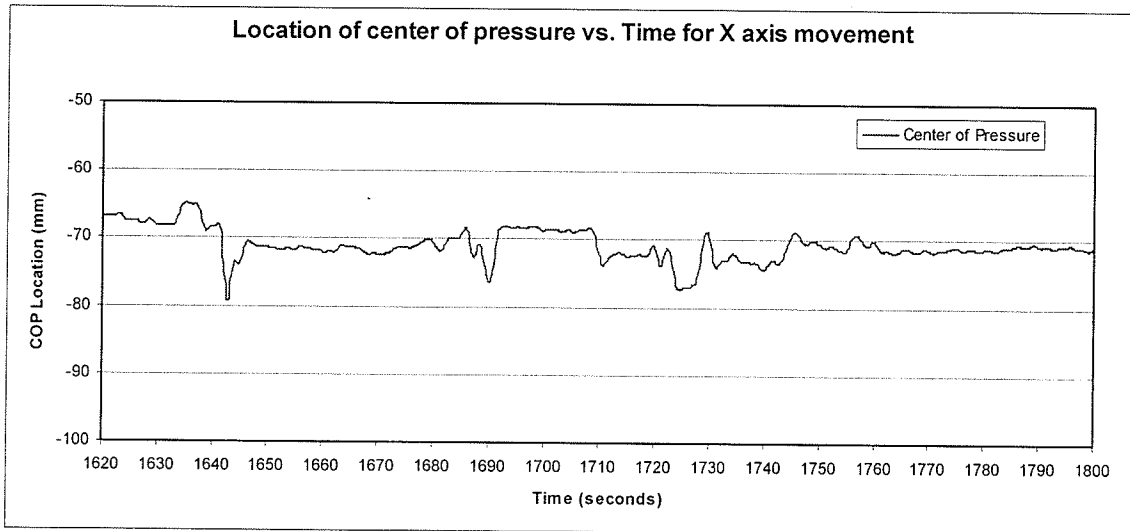

Location of center of pressure vs. Time for Y axis movement

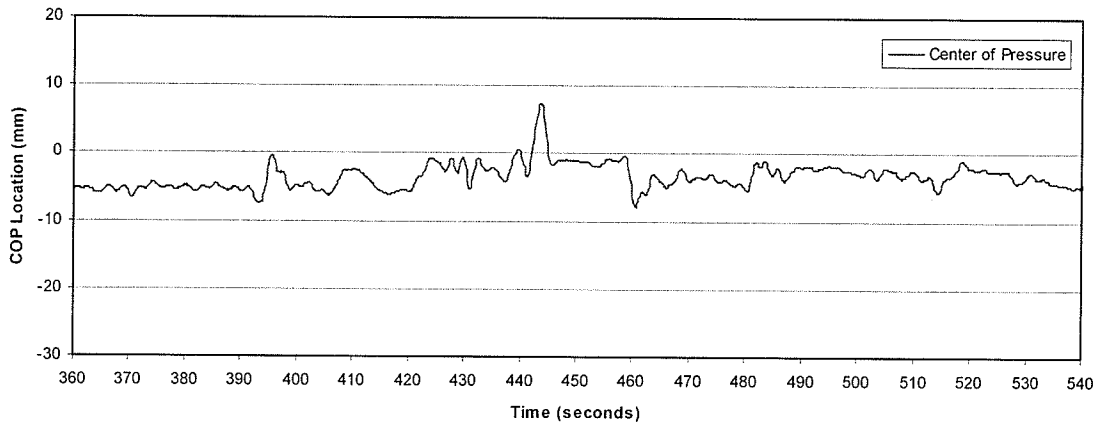

Location of center of pressure vs. Time for Y axis movement

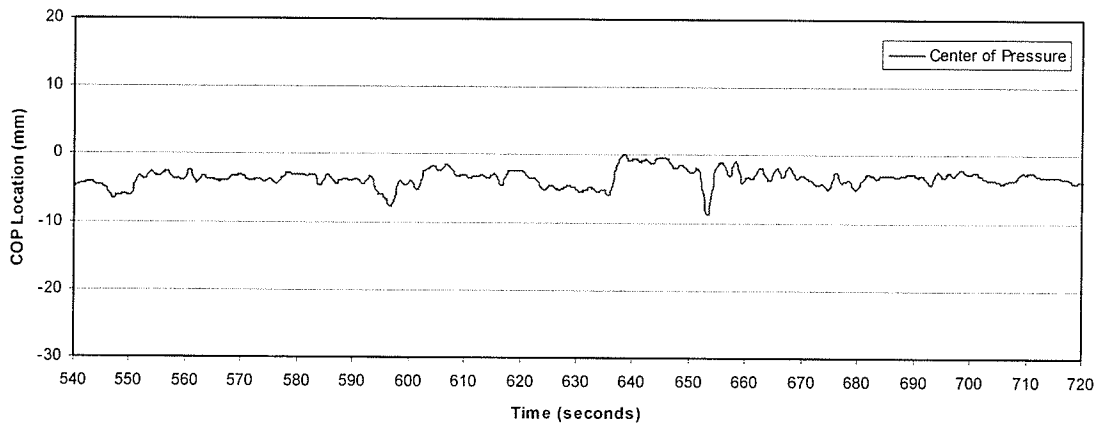

Location of center of pressure vs. Time for Y axis movement

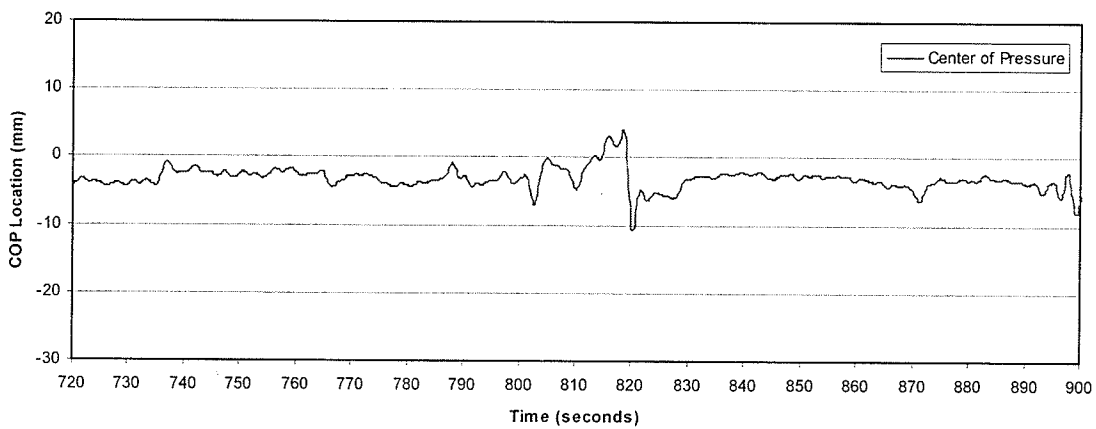

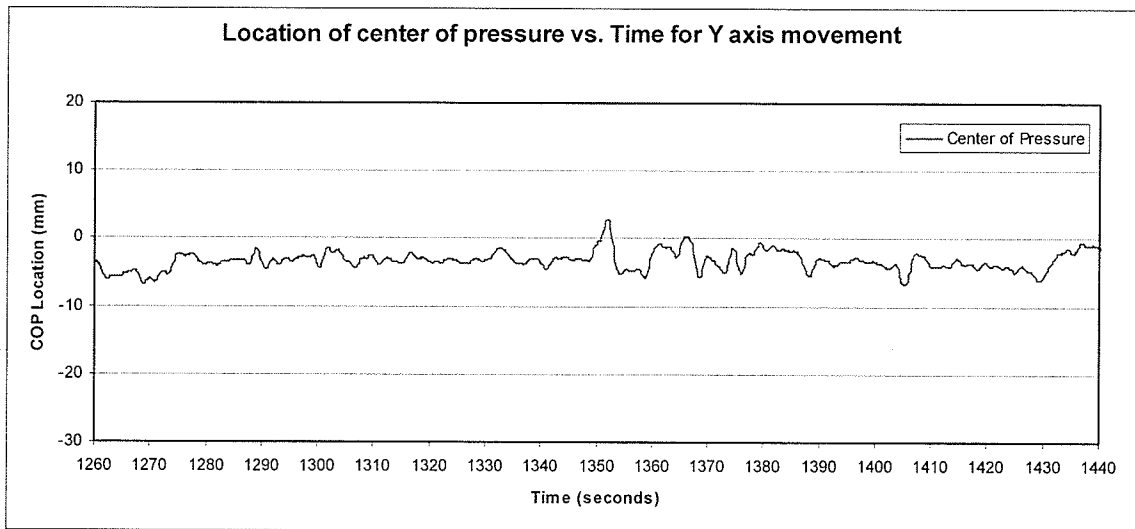
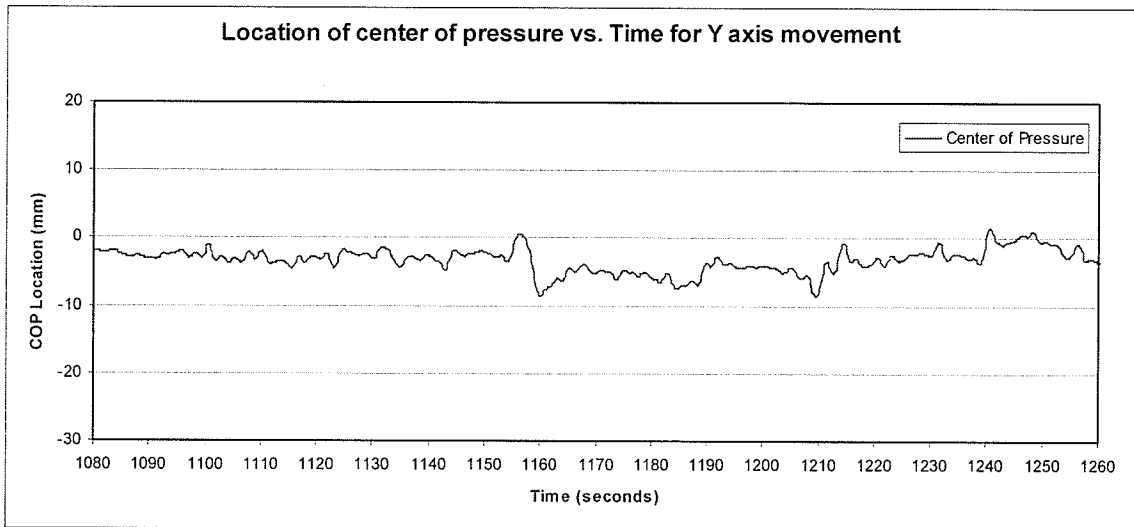
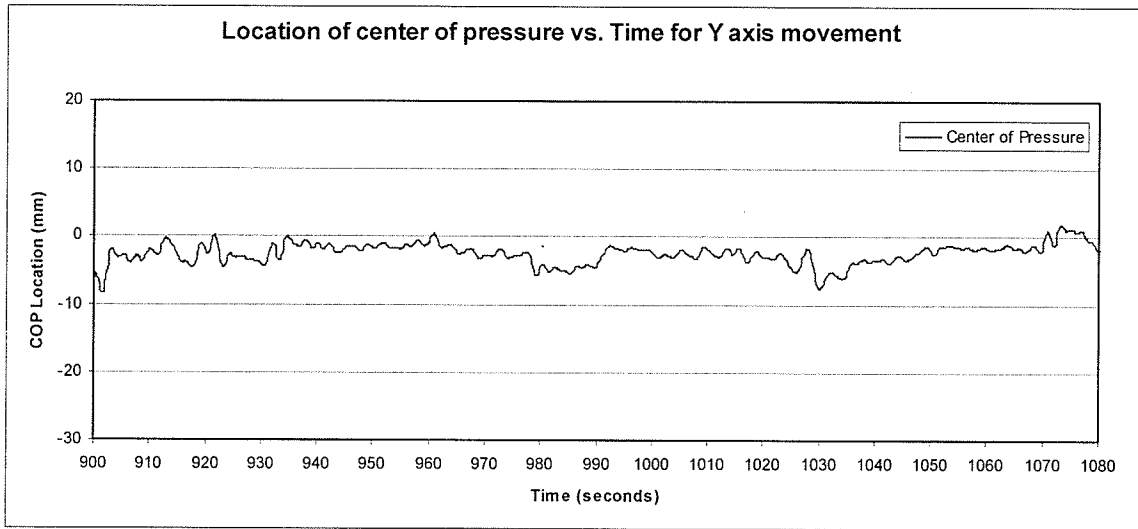

Location of center of pressure vs. Time for Y axis movement

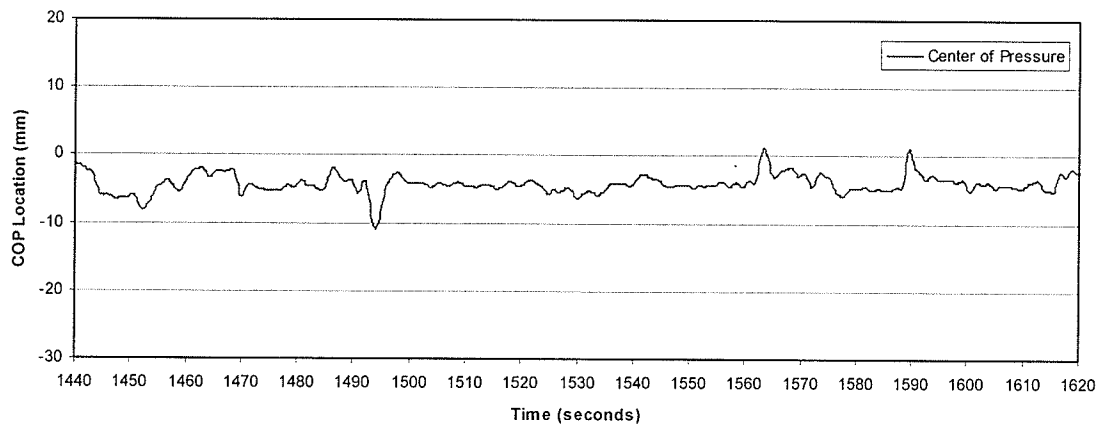

Location of center of pressure vs. Time for Y axis movement

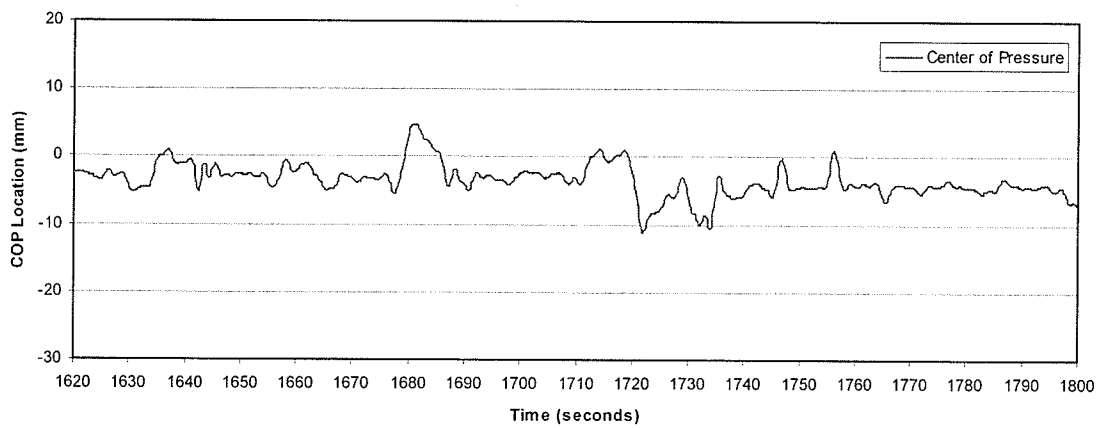

Subject - 6X	Manual Pattern Identification Chart
Approximate Time (seconds)	Pattern Description
1st order begins - 488 to 910	Drift - approximate amplitude of 11 mm (-82 to -71)
2nd order begins - None	
3rd order begins - 394	Fidget - approximate amplitude of 11 mm (-72 to -83)
418	Shift - approximate amplitude of 7 mm (-75 to -68)
1708	Shift - approximate amplitude of 5 mm (-68 to -73)
1721	Shift - approximate amplitude of 5 mm (-72 to -77) may not be considered a shift due to subsequent migration of the COP following the identified pattern
4th order begins - 240	Shift - approximate amplitude of 8 mm (-76 to -84) unclear if pattern qualifies as shift due to subsequent migration of COP
255	Shift - approximate amplitude of 5 mm (-82 to -77) unclear if pattern qualifies as shift due to migration of COP prior to this pattern, including fidget-like movement
426	Shift - approximate amplitude of 7 mm (-69 to -76) COP decreases (fidget-like) before settling at value of COP
Subject - 6Y	Manual Pattern Identification Chart
Approximate Time (seconds)	Pattern Description
1st order begins - None	
2nd order begins - 155	Shift - approximate amplitude of 10 mm (-1 to -11)
196	Fidget - approximate amplitude of 16 mm (-4 to -20)
1029 to 1073	Drift - approximate amplitude of 10 mm (-8 to 2)
1718	Shift - approximate amplitude of 12 mm (1 to -11)
3rd order begins - 144	Shift - approximate amplitude of 7 mm (-9 to -2)
277	Shift - approximate amplitude of 6 mm (-6 to 0)
440	Fidget - approximate amplitude of 10 mm (-3 to 7)
458	Shift - approximate amplitude of 7 mm (0 to -7)
635	Shift - approximate amplitude of 6 mm (-6 to 0)
817	Shift - approximate amplitude of 9 mm (4 to -5) overshoot at bottom of shift, creating fidget-like migration before settling
1633	Shift - approximate amplitude of 5 mm (-5 to 0)
4th order begins - 126	Fidget - approximate amplitude of 11 mm (-8 to 3) not a typical fidget as it may be too wide at its base, particularly due to descending side
1152	Shift - approximate amplitude of 5 mm (-3 to -8) particular pattern may not fit any of the pattern definitions shift may be from top of slope

Subject 7

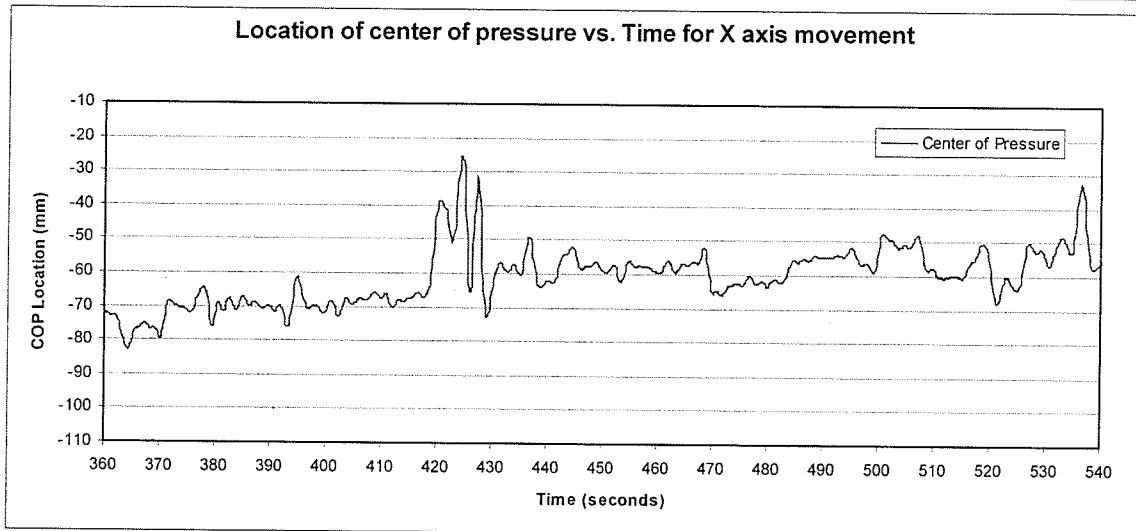
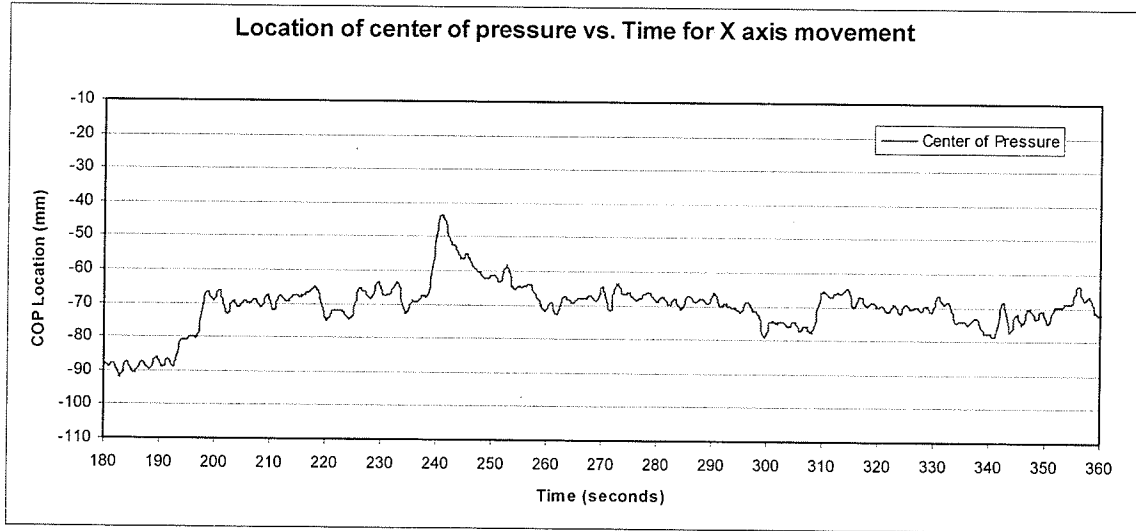
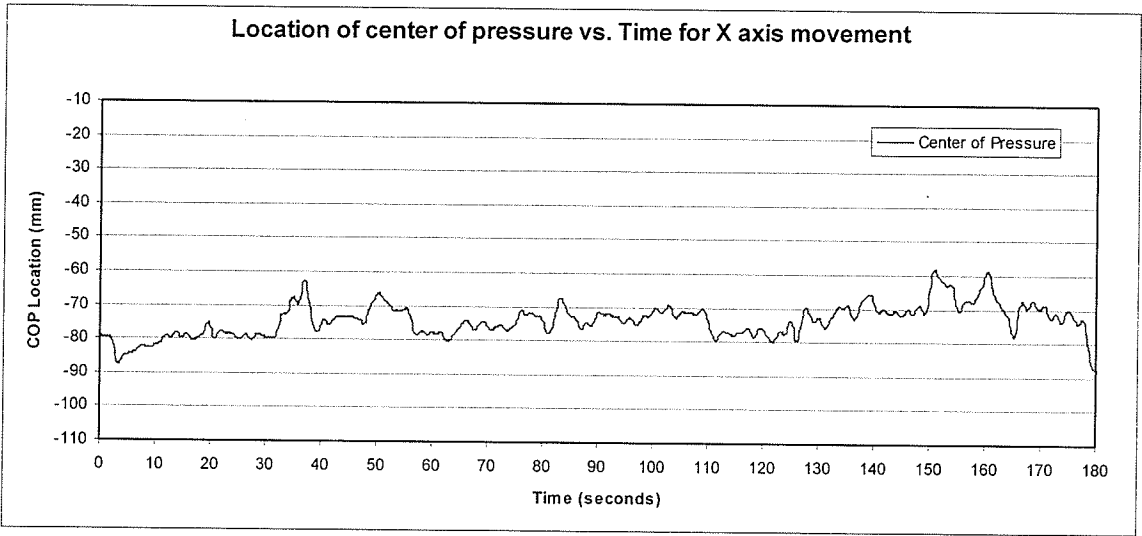

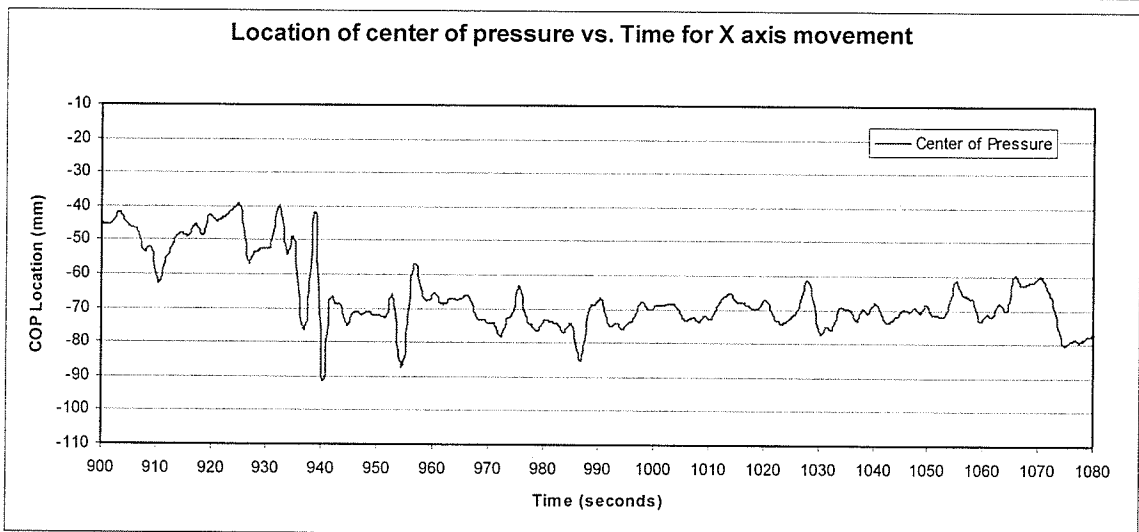
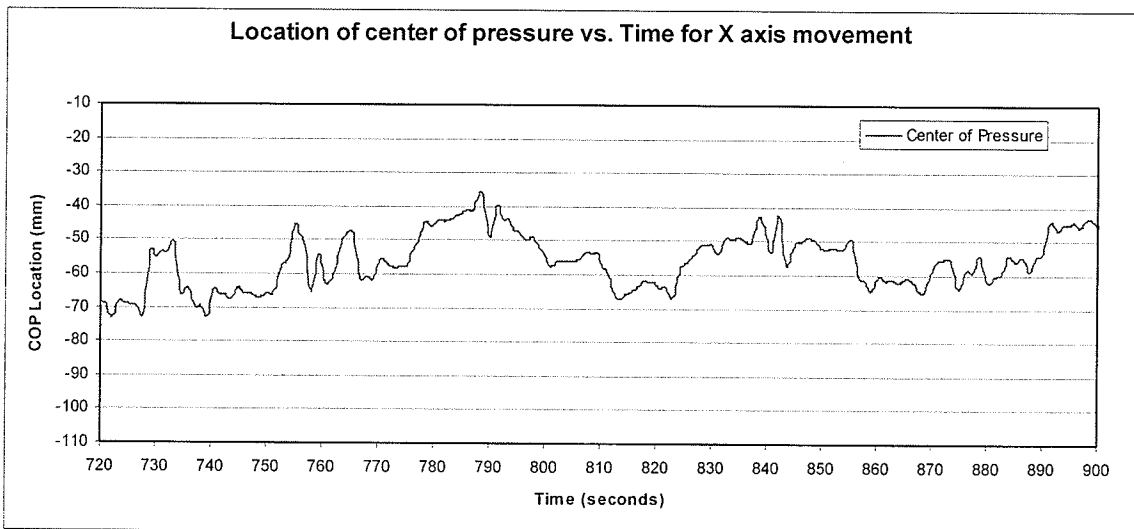
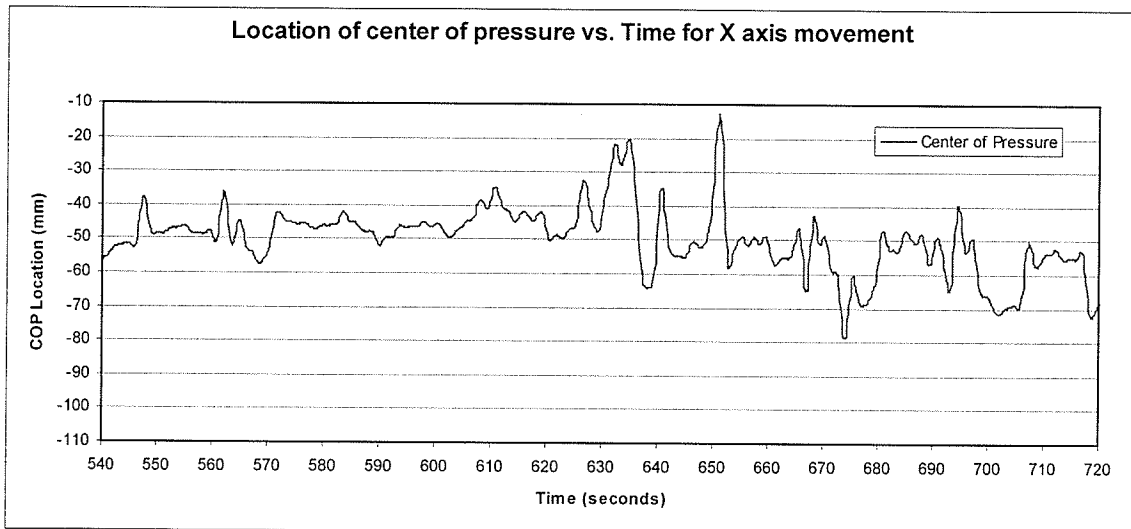

Location of center of pressure vs. Time for X axis movement

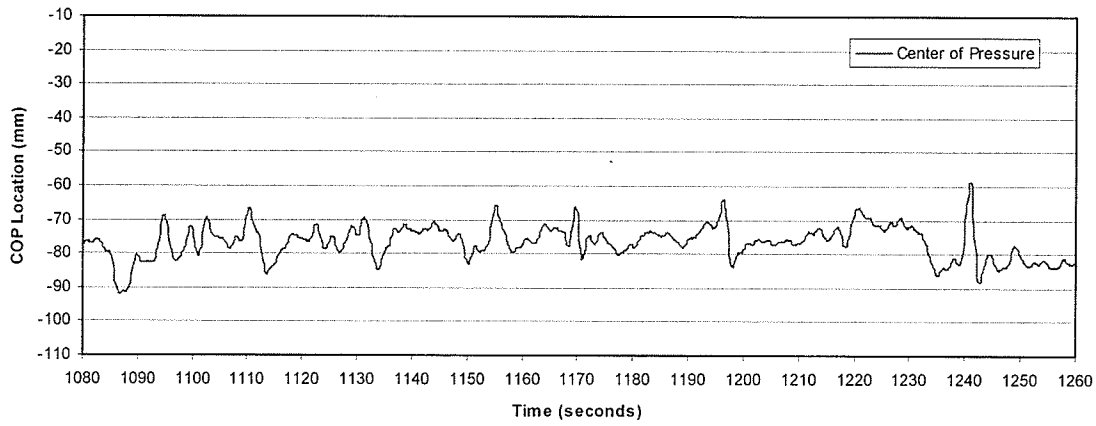

Location of center of pressure vs. Time for X axis movement

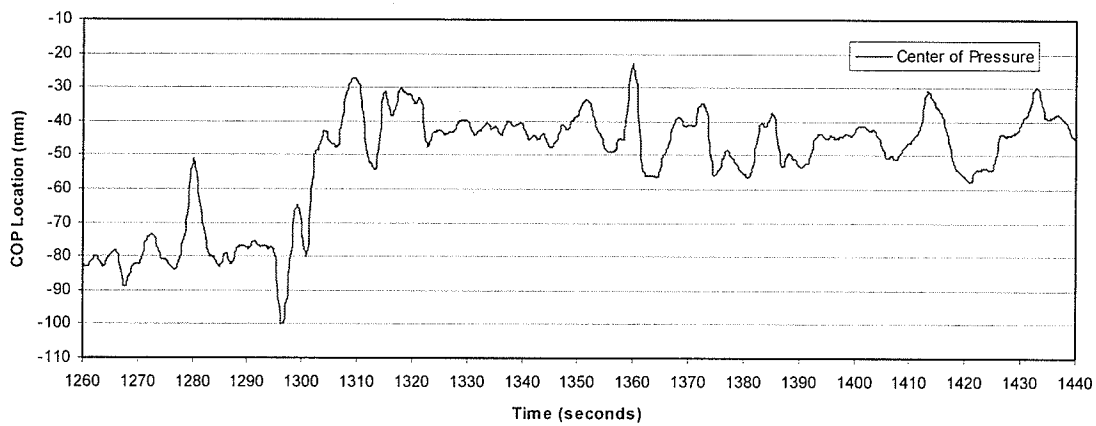

Location of center of pressure vs. Time for X axis movement

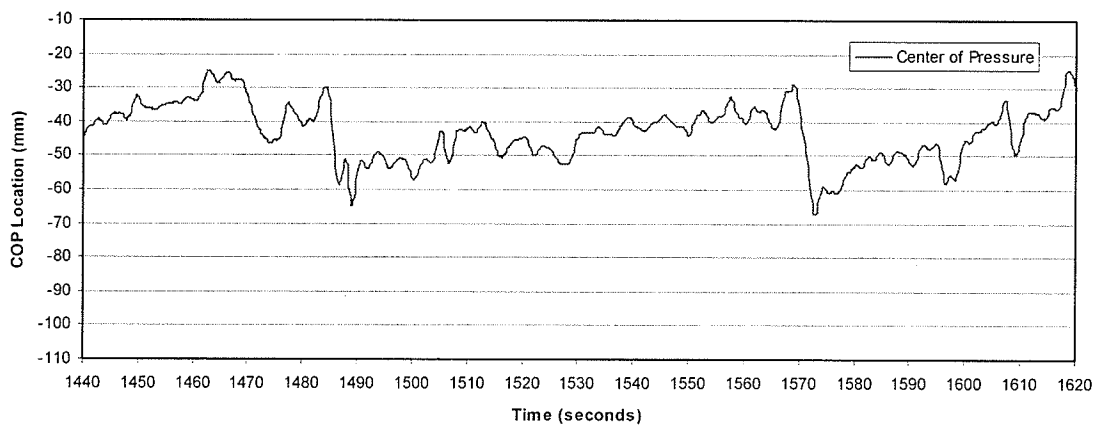

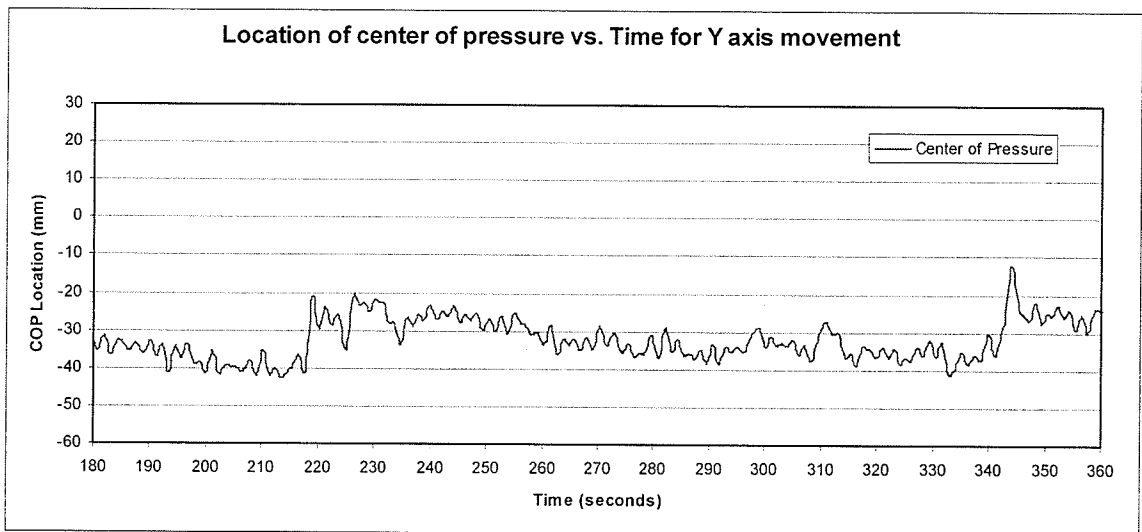
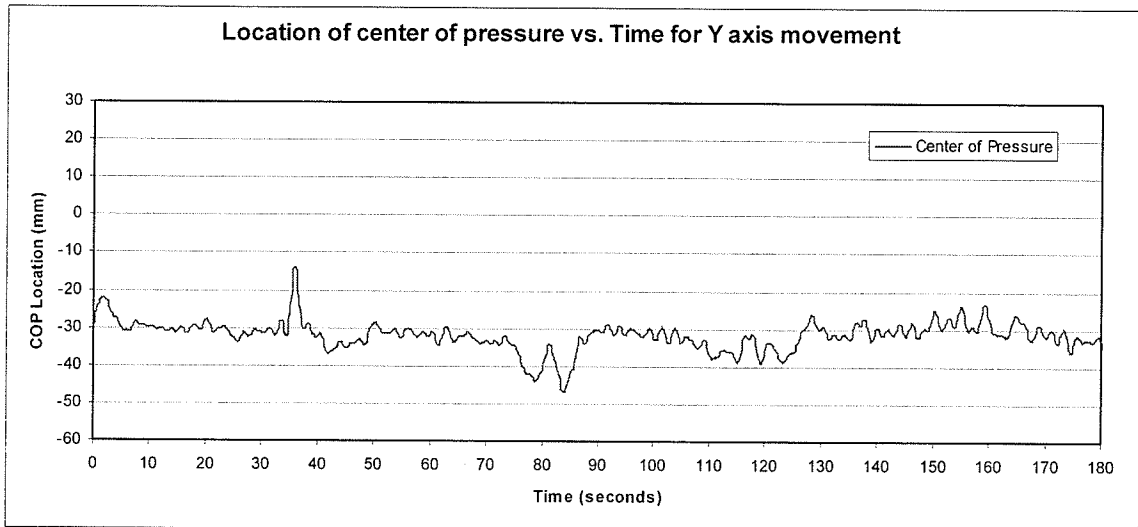
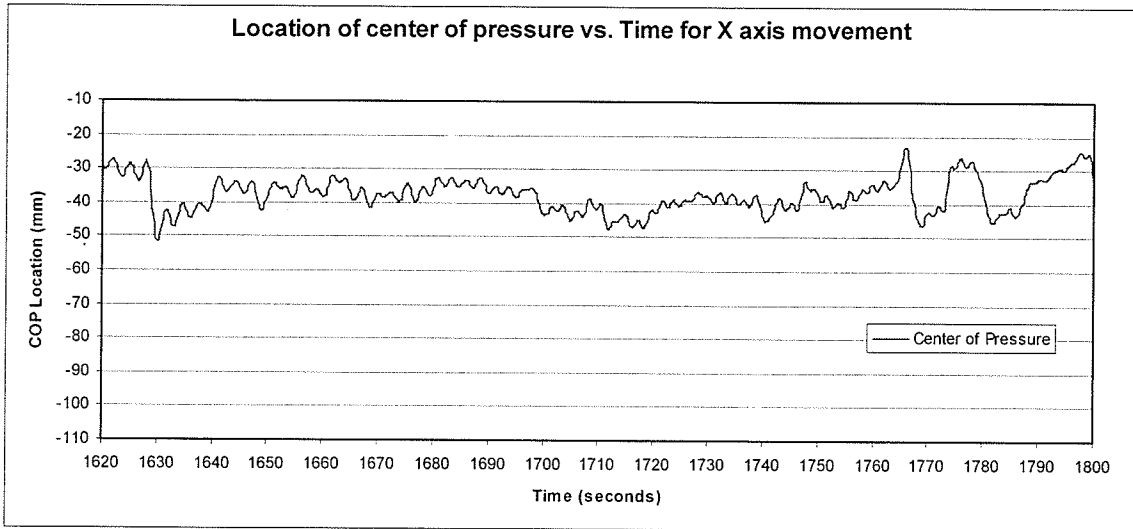

Location of center of pressure vs. Time for Y axis movement

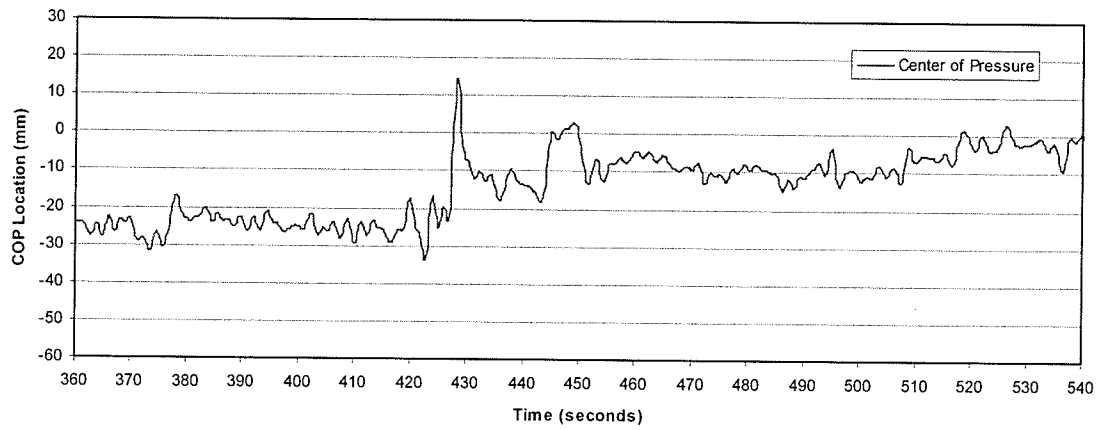

Location of center of pressure vs. Time for Y axis movement

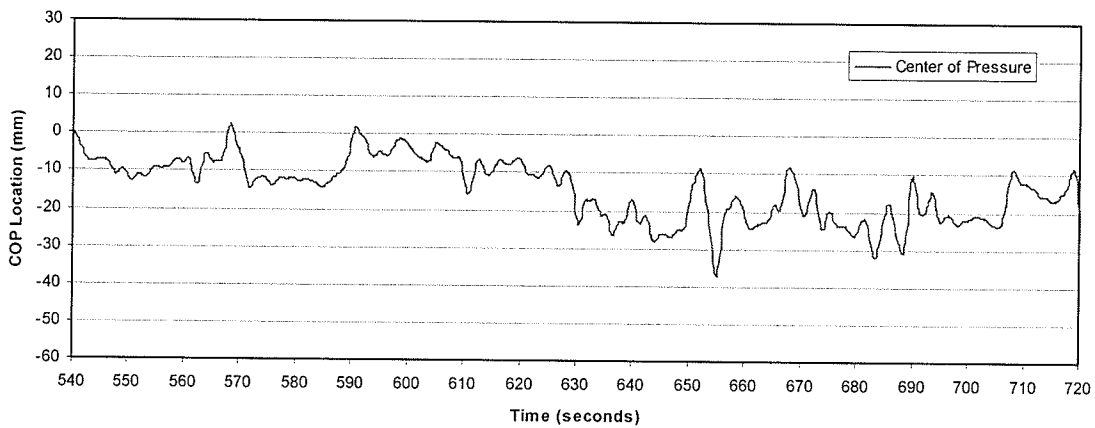

Location of center of pressure vs. Time for Y axis movement

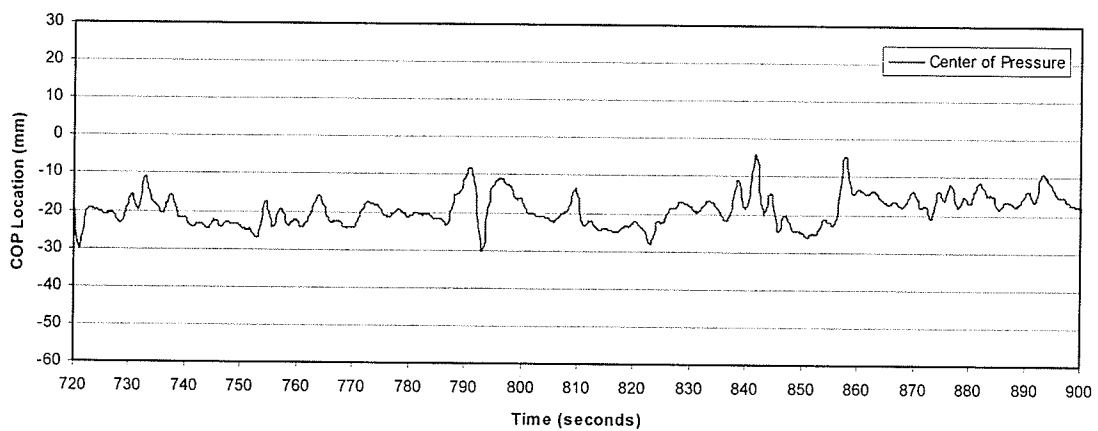

Location of center of pressure vs. Time for Y axis movement

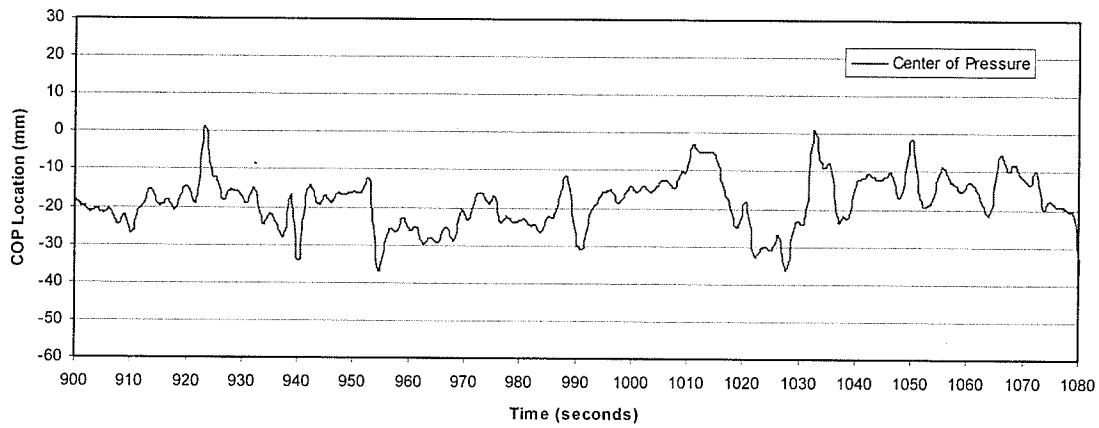

Location of center of pressure vs. Time for Y axis movement

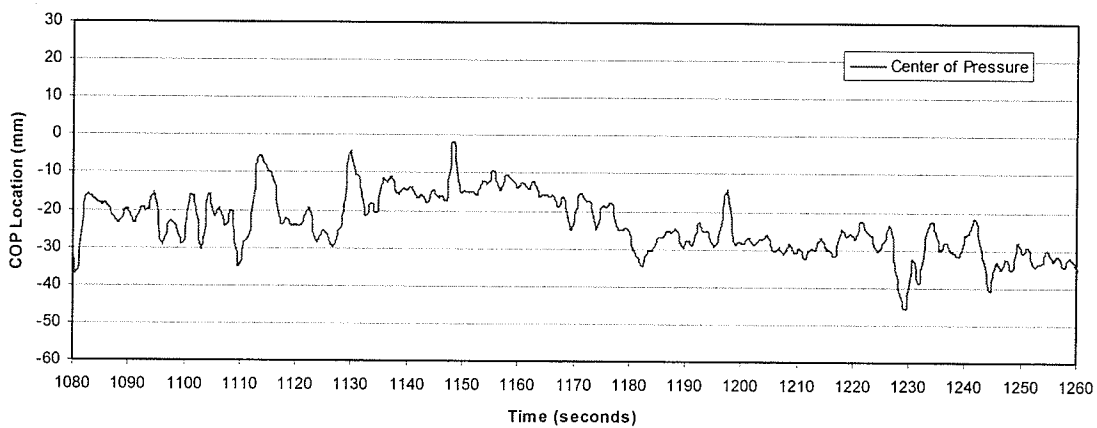

Location of center of pressure vs. Time for Y axis movement

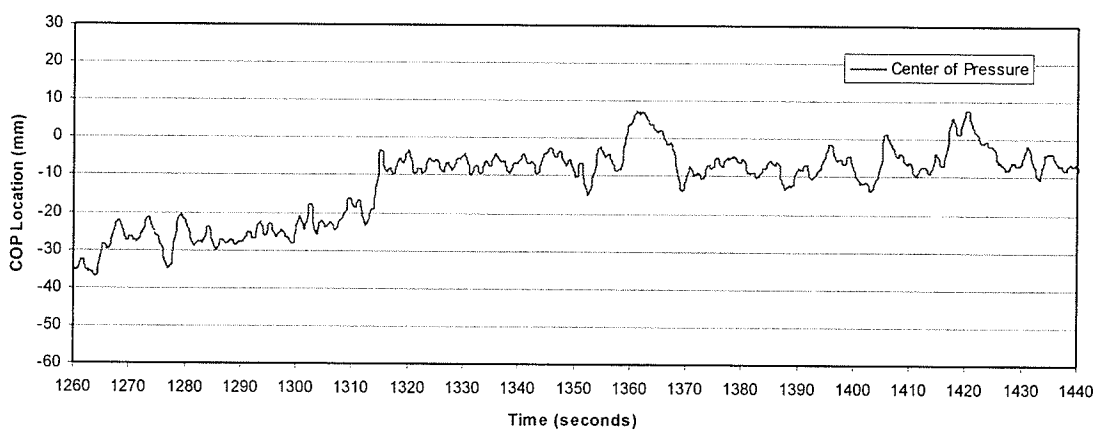

Location of center of pressure vs. Time for Y axis movement

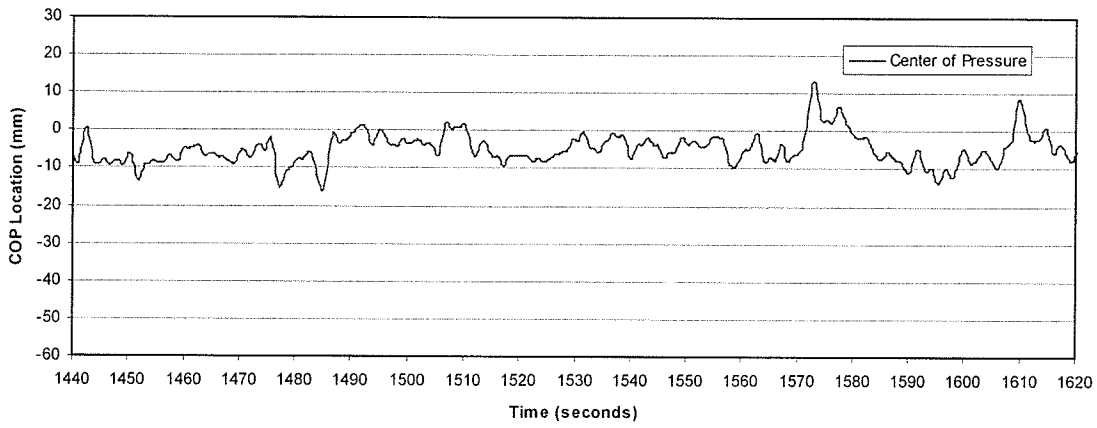

Location of center of pressure vs. Time for Y axis movement

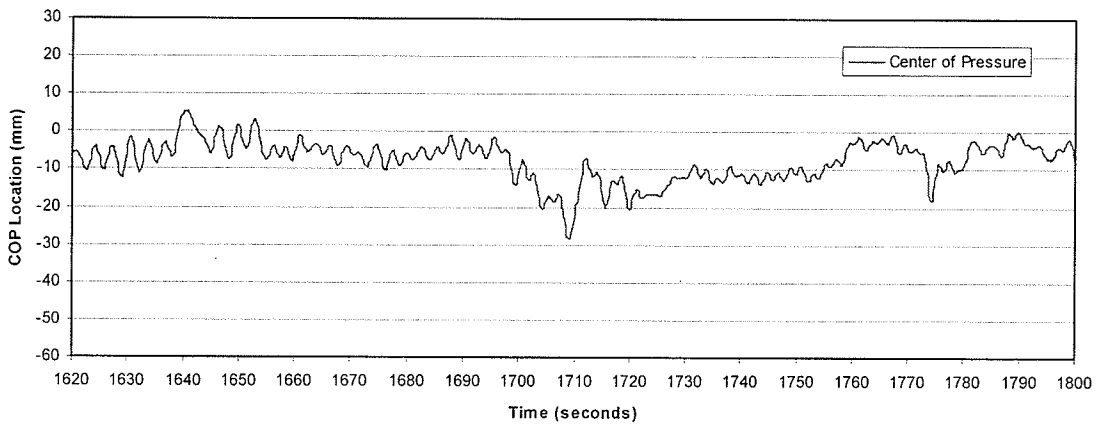

Subject - 7X	Manual Pattern Identification Chart
Approximate Time (seconds)	Pattern Description
1st order begins - 237	Shift - approximate amplitude of 25 mm (-68 to -43) COP shifts upward but then descends, rather than maintaining a value
424	Fidget - approximate amplitude of 35 mm (-66 to -31)
648	Fidget - approximate amplitude of 40 mm (-52 to -12)
1300	Shift - approximate amplitude of 36 mm (-80 to -44)
1482	Shift - approximate amplitude of 29 mm (-30 to -59)
1485 to 1568	Drift - approximate amplitude of 29 mm (-59 to -30)
1568	Shift - approximate amplitude of 30 mm (-30 to -60)
2nd order begins - 57 to 109	Drift - approximate amplitude of 9 mm (-79 to -70)
110 to 148	Drift - approximate amplitude of 10 mm (-80 to -70)
178	Shift - approximate amplitude of 15 mm (-73 to -88)
196	Shift - approximate amplitude of 13 mm (-80 to -67)
273 to 308	Drift - approximate amplitude of 15 mm (-63 to -78)
308	Shift - approximate amplitude of 12 mm (-78 to -66)
498	Shift - approximate amplitude of 11 mm (-60 to -49)
506	Shift - approximate amplitude of 10 mm (-49 to -59)
535	Fidget - approximate amplitude of 21 mm (-53 to -32)
625	Fidget - approximate amplitude of 15 mm (-47 to -32)
705	Shift - approximate amplitude of 20 mm (-70 to -50)
717	Shift - approximate amplitude of 19 mm (-53 to -72)
727	Shift - approximate amplitude of 20 mm (-73 to -53)
732	Shift - approximate amplitude of 17 mm (-50 to -67)
925	Shift - approximate amplitude of 14 mm (-40 to -54)
1070	Shift - approximate amplitude 20 mm (-60 to -80)
1085	Shift - approximate amplitude of 13 mm (-79 to -92)
1232	Shift - approximate amplitude of 13 mm (-73 to -86)
1239	Fidget - approximate amplitude of 24 mm (-83 to -59)
1276	Fidget - approximate amplitude of 29 mm (-80 to -51)
1294	Fidget - approximate amplitude of 22 mm (-78 to -100)
1357	Fidget - approximate amplitude of 23 mm (-45 to -22)
1572 to 1619	Drift - approximate amplitude of 43 mm (-68 to -25) may have two shifts that are located in the midst of the drift
1627	Shift - approximate amplitude of 20 mm (-30 to -50)
1680 to 1719	Drift - approximate amplitude of 16 mm (-32 to -48)
1772	Shift - approximate amplitude of 12 mm (-41 to -29)
1778	Shift - approximate amplitude of 16 mm (-29 to -45)
3rd order begins - 55	Shift - approximate amplitude of 8 mm (-71 to -79)
109	Shift - approximate amplitude of 7 mm (-71 to -78)

Approximate Time (seconds)	Pattern Description
192	Shift - approximate amplitude of 9 mm (-89 to -80)
217	Shift - approximate amplitude of 5 mm (-67 to -72)
223	Shift - approximate amplitude of 6 mm (-73 to -67)
370	Shift - approximate amplitude of 8 mm (-77 to -69)
435	Fidget - approximate amplitude of 11 mm (-60 to -49)
469	Shift - approximate amplitude of 9 mm (-57 to -66)
546	Fidget - approximate amplitude of 12 mm (-50 to -38)
560	Fidget - approximate amplitude of 14 mm (-50 to -36)
840	Fidget - approximate amplitude of 11 mm (-53 to -42)
855	Shift - approximate amplitude of 9 mm (-52 to -61)
930	Fidget - approximate amplitude of 12 mm (-52 to -40)
1088	Shift - approximate amplitude of 9 mm (-91 to -82)
1093	Fidget - approximate amplitude of 14 mm (-83 to -69)
1168	Fidget - approximate amplitude of 12 mm (-78 to -66)
1321	Shift - approximate amplitude of 9 mm (-34 to -43)
1391	Shift - approximate amplitude of 9 mm (-52 to -43)
1403	Shift - approximate amplitude of 9mm (-42 to -51)
1529	Shift - approximate amplitude of 9 mm (-52 to -43)
4th order begins - 418	Fidget - approximate amplitude of 28 mm (-67 to -39) appears attached to another fidget in filtered data
640	Fidget - approximate amplitude of 20 mm (-55 to -35) COP migrates quite a bit in this region, so fidget is slightly abnormal
665	Fidget - approximate amplitude of 18 mm (-47 to -65) appears to be fidget downward, if you consider the start and end of fidget to be at peaks
672	Fidget - approximate amplitude of 19 mm (-60 to -79) fidget appears at bottom of slope
933	Shift - approximate amplitude of 27 mm (-50 to -77)
937	Fidget - approximate amplitude of 36 mm (-77 to -41) follows previous shift
939	Fidget - approximate amplitude of 14 mm (-77 to -91)
1195	Shift - approximate amplitude of 14 mm (-70 to -84) shift may not be as big as stated due to fidget-like migration at beginning and end of pattern
1765	Shift - approximate amplitude of 15 mm (-32 to -47) shift includes fidget-like movement just prior to shift
Subject - 7Y	Manual Pattern Identification Chart
Approximate Time (seconds)	Pattern Description
1st order begins - 1720 to 1790	Drift - approximate amplitude of 17 mm (-17 to 0)
2nd order begins - 34	Fidget - approximate amplitude of 16 mm (-30 to -14)
158 to 214	Drift - approximate amplitude of 19 mm (-23 to -42)
218	Shift - approximate amplitude of 20 mm (-41 to -21)
243 to 292	Drift - approximate amplitude of 15 mm (-24 to -39)

341	Shift - approximate amplitude of 10 mm (-36 to -26) at beginning of shift there is a fidget-like migration of COP
442	Shift - approximate amplitude of 19 mm (-19 to 0)
448	Shift - approximate amplitude of 16 mm (3 to -13)
485 to 540	Drift - approximate amplitude of 15 mm (-15 to 0)
590 to 643	Drift - approximate amplitude of 30 mm (1 to -29)
648	Fidget - approximate amplitude of 16 mm (-25 to -9)
705	Shift - approximate amplitude of 15 mm (-24 to -9)
840	Fidget - approximate amplitude of 15 mm (-19 to -4)
921	Fidget - approximate amplitude of 19 mm (-18 to 1)
938	Fidget - approximate amplitude of 16 mm (-17 to -33)
1047	Fidget - approximate amplitude of 16 mm (-17 to -1)
1079	Fidget - approximate amplitude of 17 mm (-20 to -37)
1146	Fidget - approximate amplitude of 15 mm (-16 to -1)
1195	Fidget - approximate amplitude of 15 mm (-29 to -14)
1314	Shift - approximate amplitude of 16 mm (-19 to -3)
3rd order begins - 665	Fidget - approximate amplitude of 12 mm (-20 to -8)
683	Fidget - approximate amplitude of 13 mm (-31 to -18)
855	Shift - approximate amplitude of 9 mm (-23 to -14) shift begins with fidget-like migration
1100	Fidget - approximate amplitude of 13 mm (-29 to -16)
1505	Shift - approximate amplitude of 6 mm (-5 to 1)
1510	Shift - approximate amplitude of 8 mm (1 to -7)
1607	Fidget - approximate amplitude of 12 mm (-3 to 9)
4th order begins - 427	Shift - approximate amplitude of 14 mm (-24 to -10) fidget at beginning of shift
653	Fidget - approximate amplitude of 13 mm (-25 to -38)
790	Fidget - approximate amplitude of 20 mm (-10 to -30) unclear as to whether this is a fidget for sure, may be part of shift
952	Shift - approximate amplitude of 11 mm (-15 to -26) shift contains fidget-like migration in the middle of shift
983	Fidget - approximate amplitude of 15 mm (-26 to -11) may be too wide at base to be considered a fidget
1030	Fidget - approximate amplitude of 25 mm (-24 to 1) may be too wide at base to be considered a fidget
1107	Fidget - approximate amplitude of 15 mm (-20 to -35)
1112	Fidget - approximate amplitude of 17 mm (-22 to -5) connected to previous fidget, both bases may be too wide to characterize patterns as fidgets
1126	Shift - approximate amplitude of 9 mm (-30 to -21) contains a partial fidget during shift
1226	Fidget - approximate amplitude of 23 mm (-23 to -46) double-peaked fidget (2nd < 1st), base may be too wide
1358	Shift - approximate amplitude of 13 mm (-9 to 4)
1366	Shift - approximate amplitude of 9 mm (-1 to -10)

Subject 8

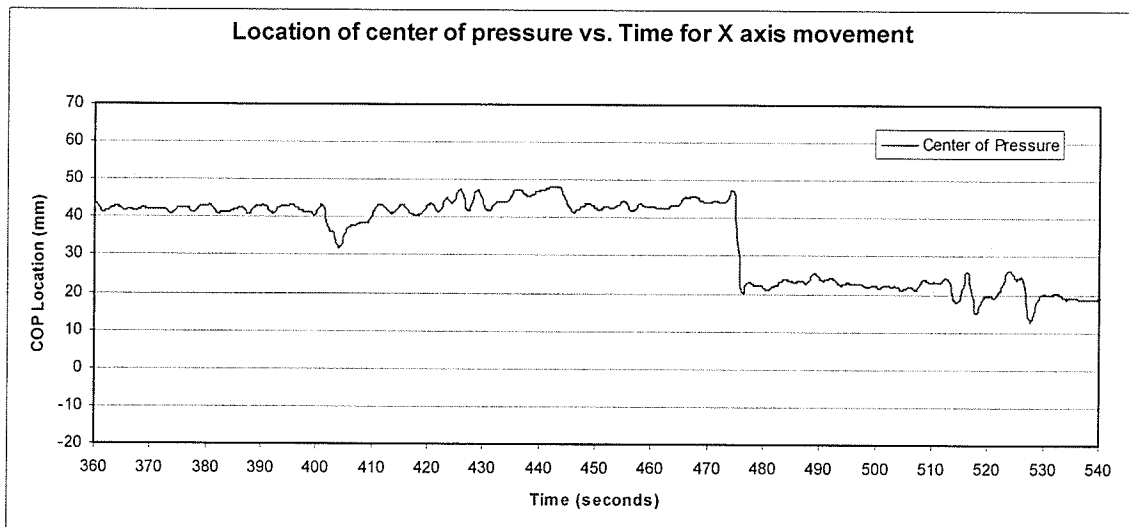
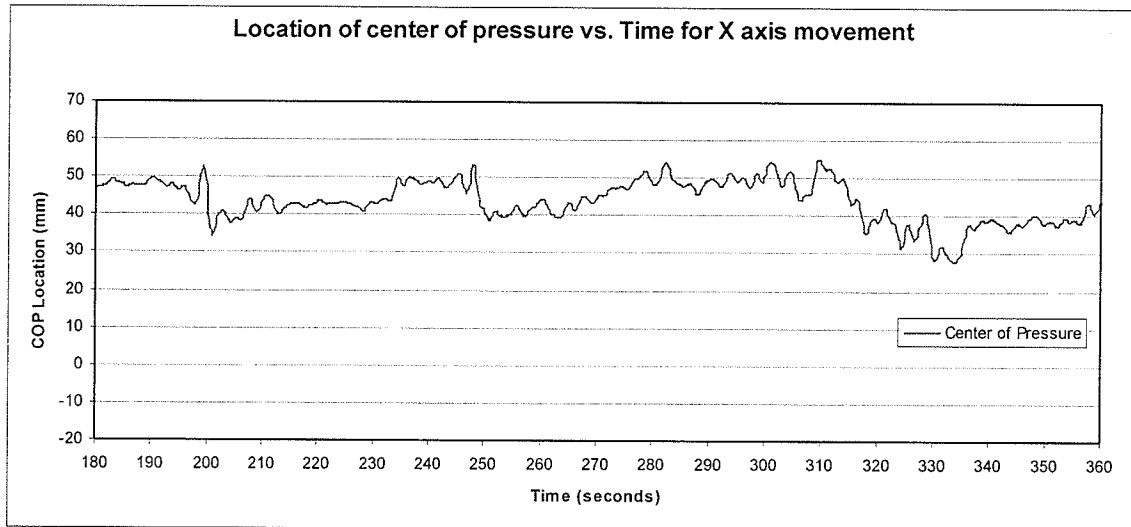
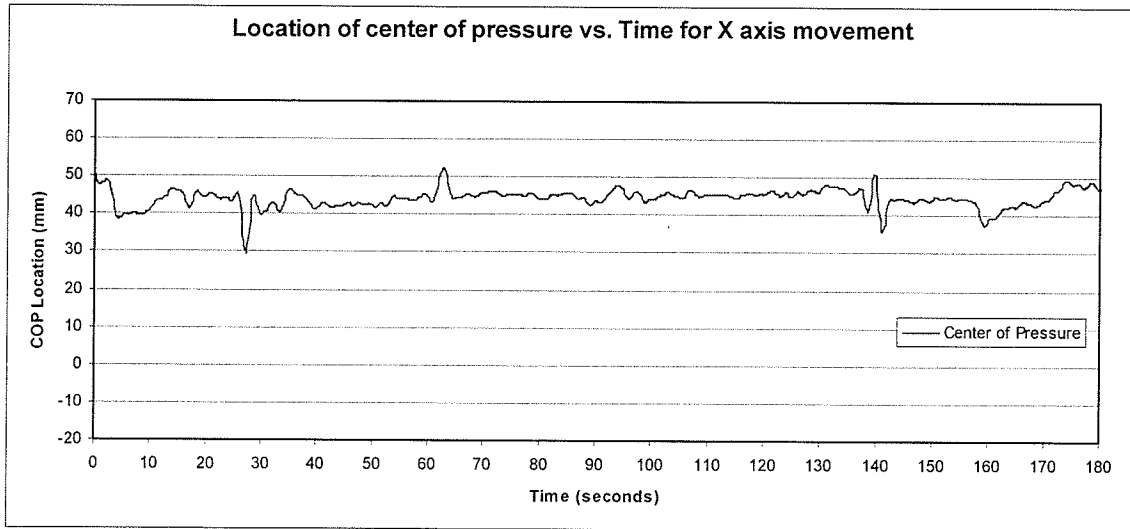

Location of center of pressure vs. Time for X axis movement

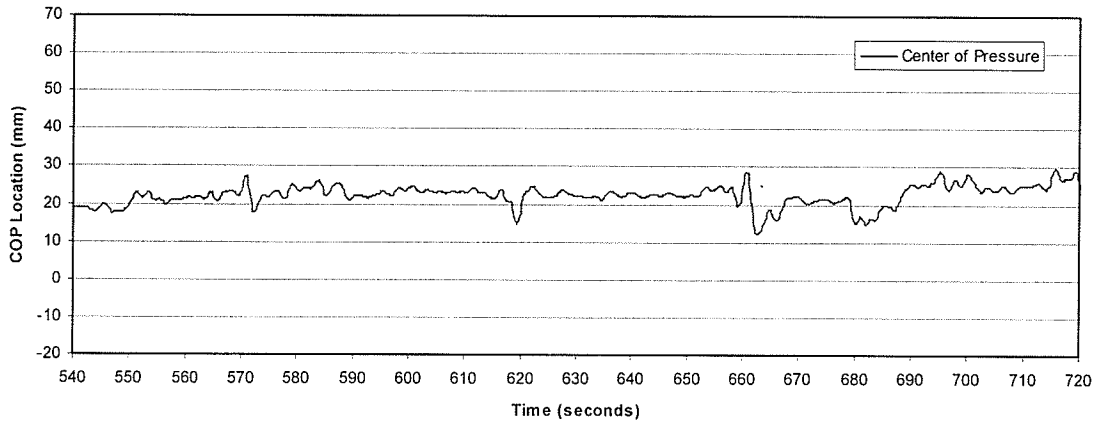

Location of center of pressure vs. Time for X axis movement

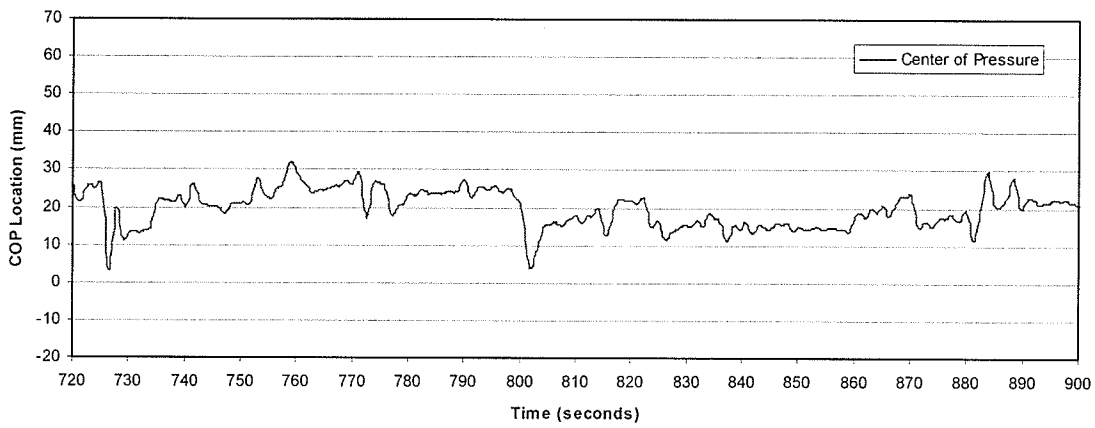

Location of center of pressure vs. Time for X axis movement

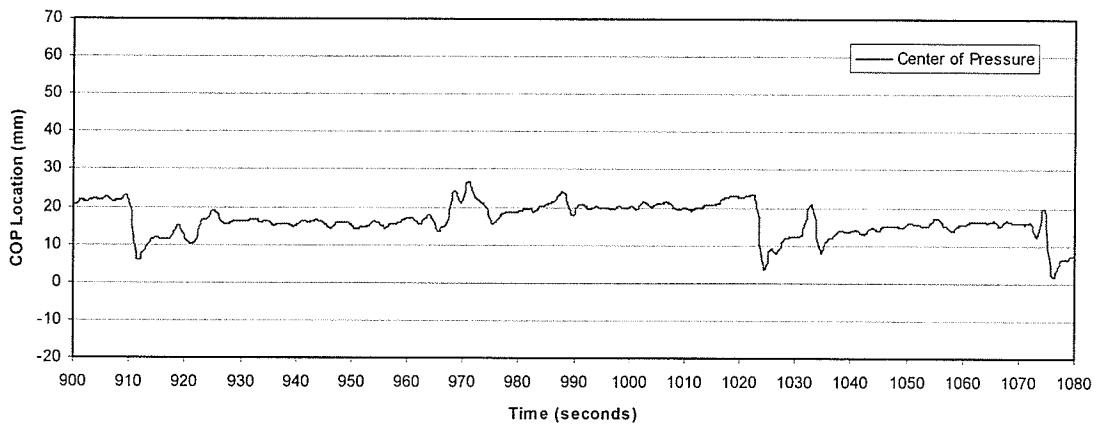

Location of center of pressure vs. Time for X axis movement

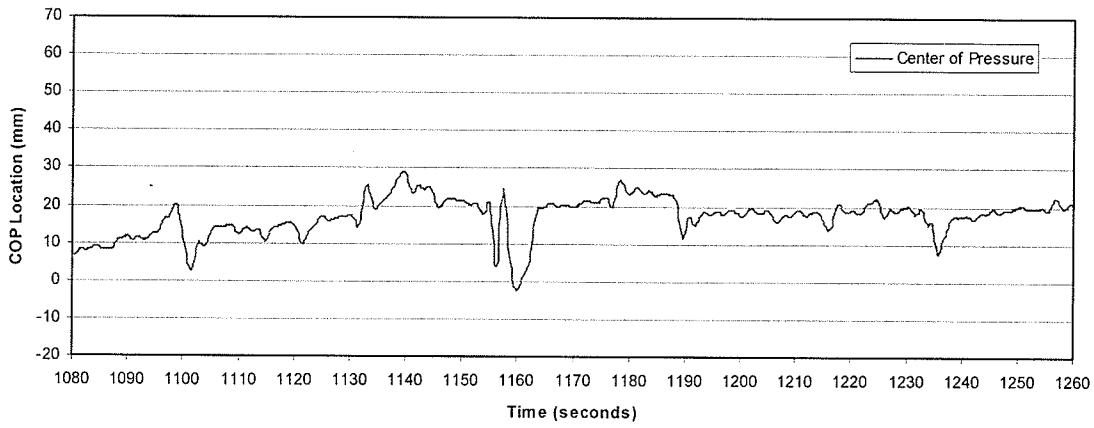

Location of center of pressure vs. Time for X axis movement

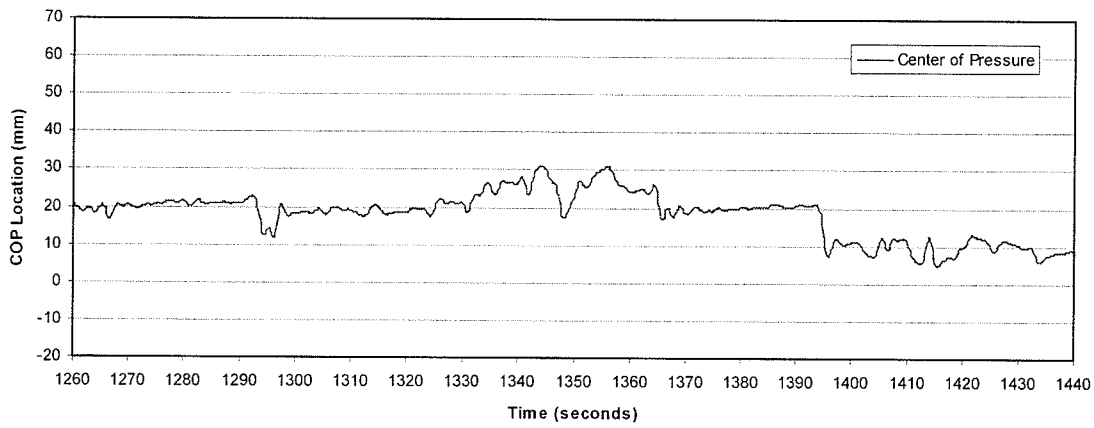

Location of center of pressure vs. Time for X axis movement

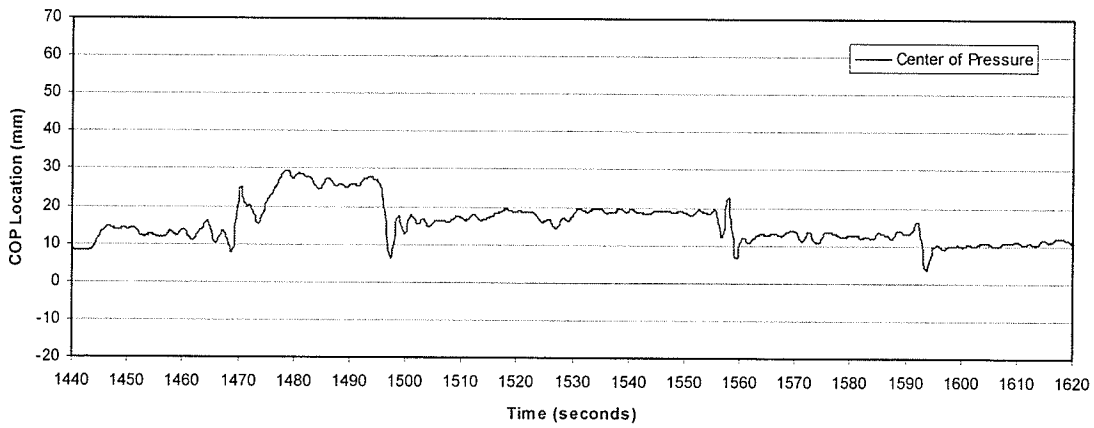

Location of center of pressure vs. Time for X axis movement

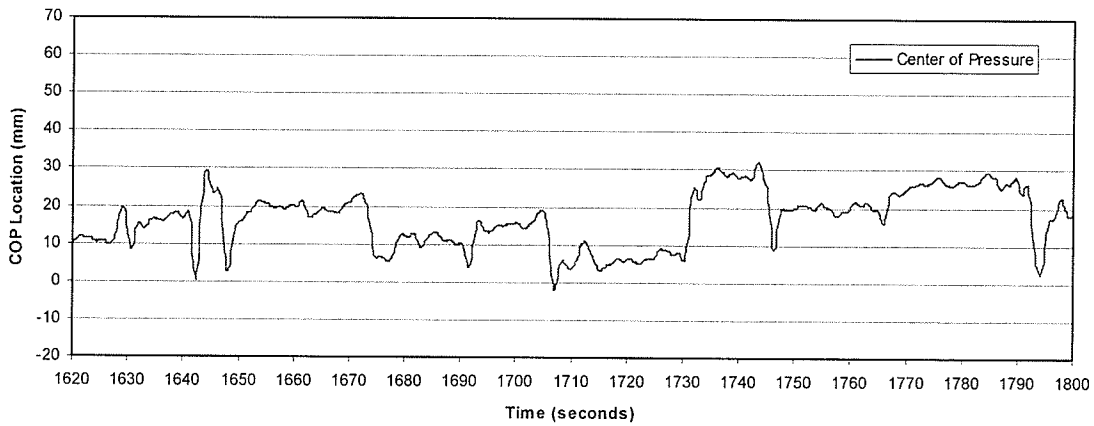

Location of center of pressure vs. Time for Y axis movement

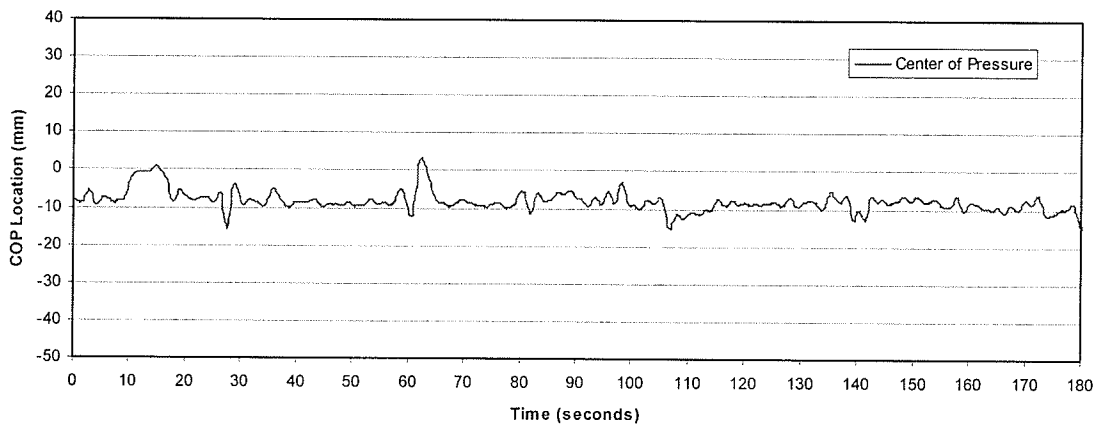

Location of center of pressure vs. Time for Y axis movement

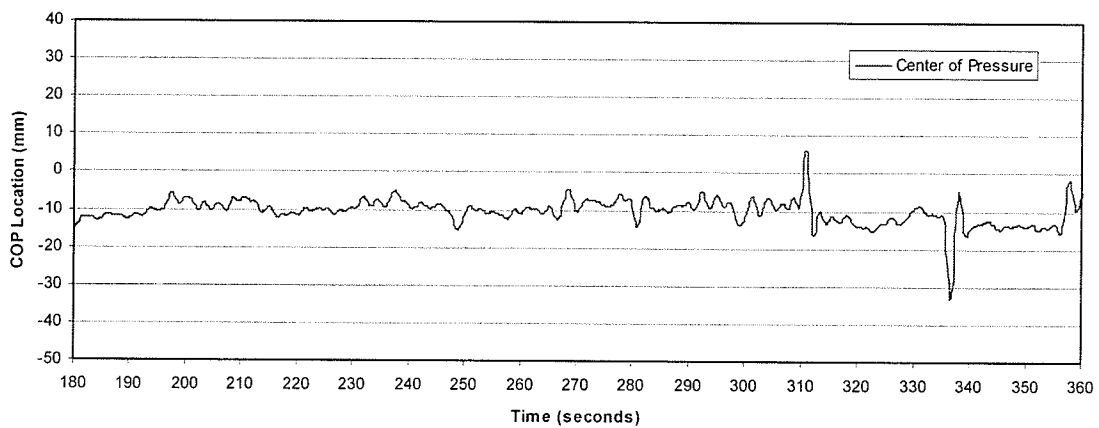

Location of center of pressure vs. Time for Y axis movement

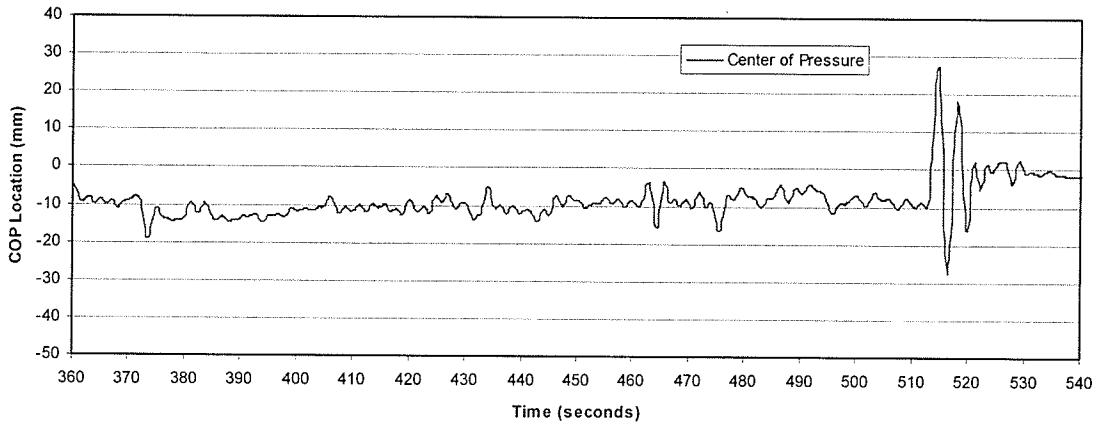

Location of center of pressure vs. Time for Y axis movement

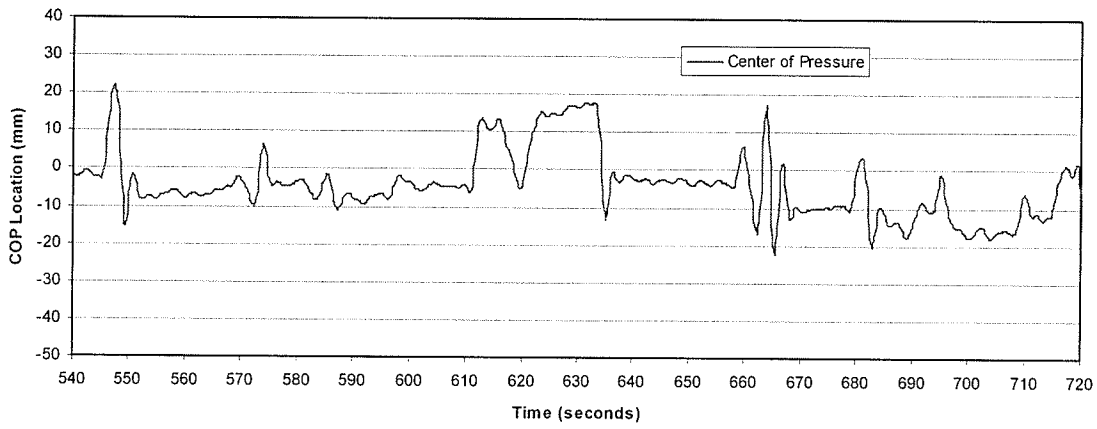

Location of center of pressure vs. Time for Y axis movement

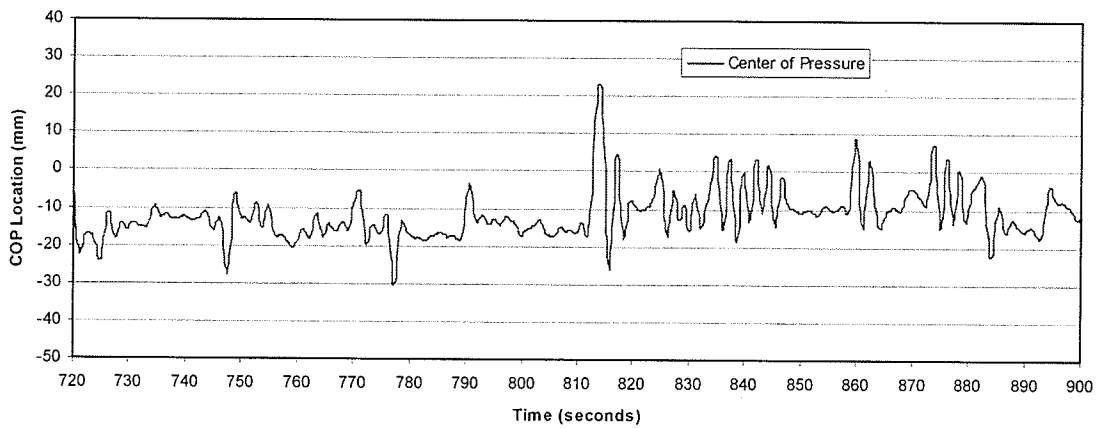

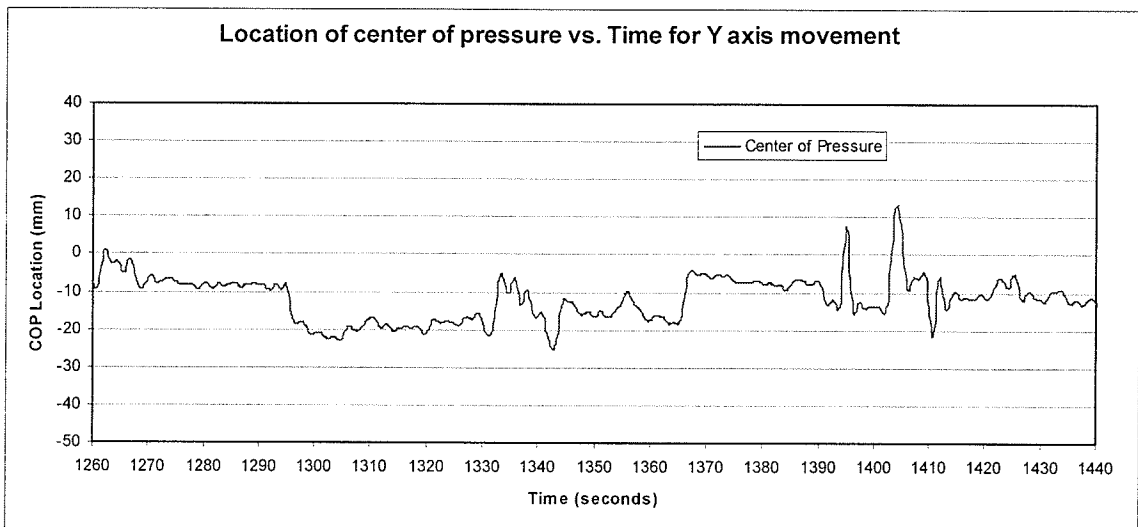
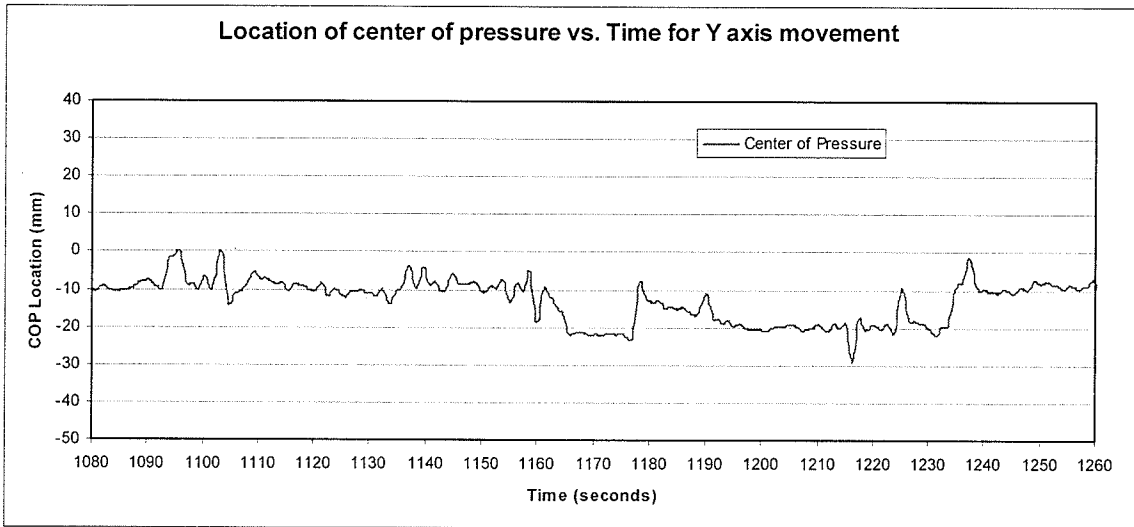
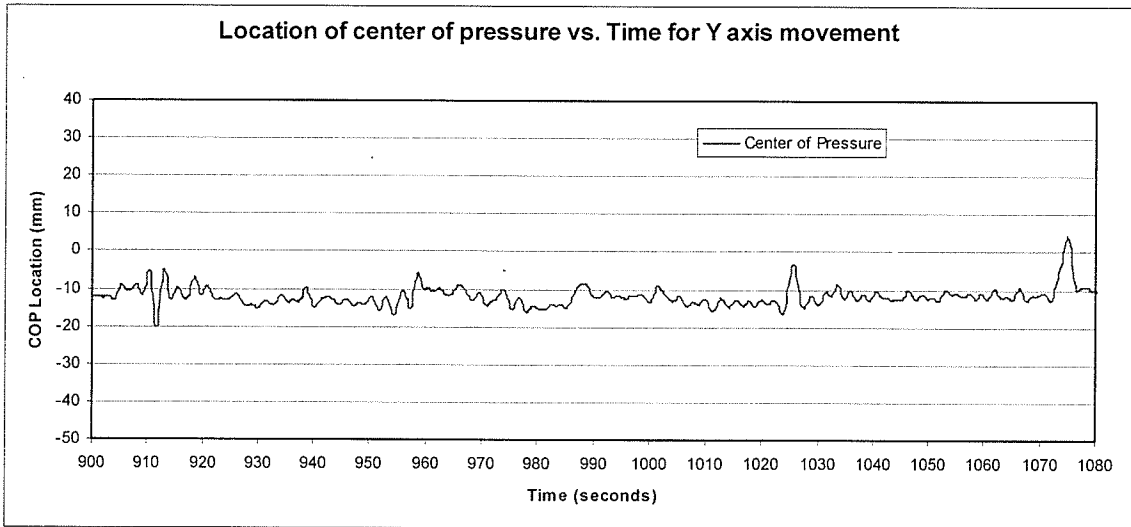

Location of center of pressure vs. Time for Y axis movement

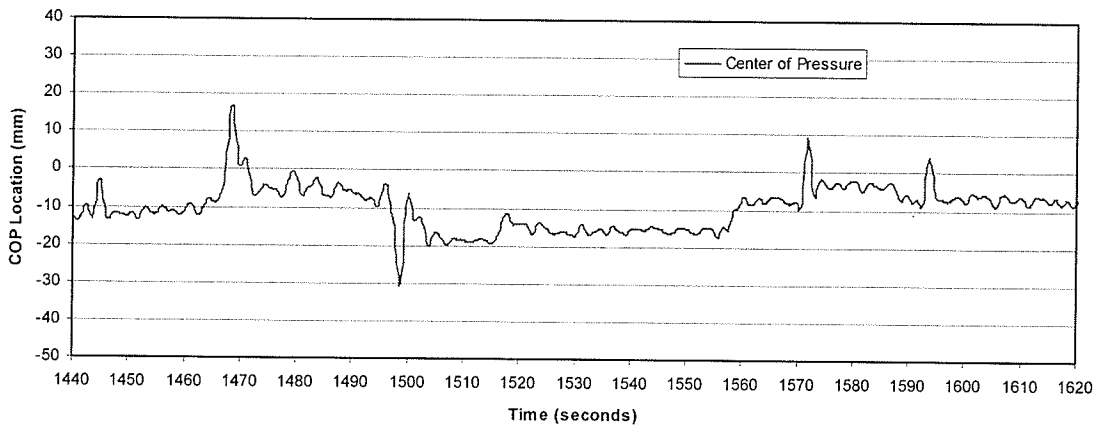

Location of center of pressure vs. Time for Y axis movement

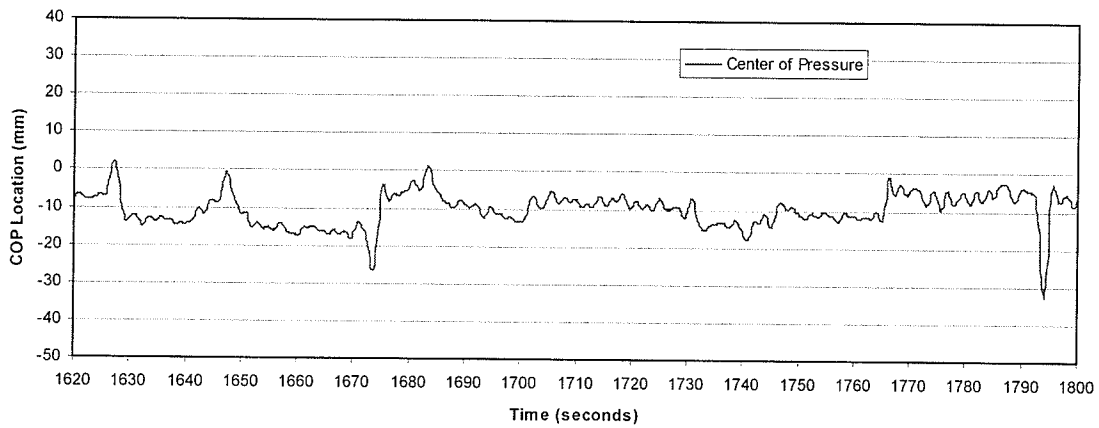

Subject - 8X	Manual Pattern Identification Chart
Approximate Time (seconds)	Pattern Description
1st order begins - 472	Shift - approximate amplitude of 23 mm (45 to 22)
911 to 1022	Drift - approximate amplitude of 17 mm (6 to 23)
1078 to 1140	Drift - approximate amplitude of 22 mm (7 to 29)
2nd order begins - 24	Fidget - approximate amplitude of 15 mm (45 to 30)
250 to 282	Drift - approximate amplitude of 15 mm (39 to 54)
1022	Shift - approximate amplitude of 20 mm (23 to 3)
1154	Fidget - approximate amplitude of 17 mm (21 to 4)
1297 to 1343	Drift - approximate amplitude of 13 mm (18 to 31)
1393	Shift - approximate amplitude of 13 mm (21 to 8)
1496	Shift - approximate amplitude of 11 mm (26 to 15) fidget-like migration before settling to shifted value
1671	Shift - approximate amplitude of 17 mm (23 to 6)
1705	Shift - approximate amplitude of 20 mm (19 to -1)
1730	Shift - approximate amplitude of 20 mm (6 to 26)
1748 to 1784	Drift - approximate amplitude of 10 mm (20 to 30)
3rd order begins - 157	Shift - approximate amplitude of 6 mm (44 to 38)
232	Shift - approximate amplitude of 6 mm (44 to 50)
440	Shift - approximate amplitude of 8 mm (49 to 41)
733	Shift - approximate amplitude of 8 mm (14 to 22)
822	Shift - approximate amplitude of 7 mm (22 to 15)
870	Shift - approximate amplitude of 9 mm (24 to 15)
883	Fidget - approximate amplitude of 10 mm (20 to 30)
921	Shift - approximate amplitude of 7 mm (10 to 17)
1073	Shift - approximate amplitude of 9 mm (15 to 6) with overshoot at beginning and end (fidget-like) migration
1363	Shift - approximate amplitude of 6 mm (24 to 18)
1743	Shift - approximate amplitude of 8 mm (28 to 20) fidget downward before settles at shift COP values
4th order begins - 138	Fidget - approximate amplitude of 10 mm (41 to 51) appears to be a fidget within two fidgets (but only one to meet pattern parameters)
197	Fidget - approximate amplitude of 10 mm (42 to 52) may be part of a shift, however shift does not meet pattern parameters
724	Shift - approximate amplitude of 16 mm (27 to 11) there appears to be a shift in the COP data, but it is preceded by a fidget which may be part of the shift or may be its own pattern
800	Shift - approximate amplitude of 7 mm (22 to 15) shift in data preceded immediately by fidget-like migration
1157	Fidget - approximate amplitude of 23 mm (20 to -3) may be too wide to be a fidget and not wide enough at its amplitude to be considered a shift

Approximate Time (seconds)	Pattern Description
1188	Shift - approximate amplitude of 5 mm (23 to 18) may not meet pattern parameters once settling, depends where shift ends
1473	Shift - approximate amplitude of 15 mm (15 to 30) may take too long to be considered a shift
1556	Shift - approximate amplitude of 8 mm (19 to 11) fidget in middle of shift
1640	Fidget - approximate amplitude of 19 mm (19 to 0)
1792	Fidget - approximate amplitude of 20 mm (22 to 2) may be too wide at base

Subject - 8Y	Manual Pattern Identification Chart
Approximate Time (seconds)	Pattern Description
1st order begins - 512	Fidget - approximate amplitude of 38 mm (-10 to 28) another fidget follows which does not fit pattern criteria, however it may all be due to a shift which follows
812	Fidget - approximate amplitude of 41 mm (-18 to 23)
2nd order begins - 309	Fidget - approximate amplitude of 17 mm (-10 to 7)
335	Fidget - approximate amplitude of 23 mm (-11 to -34)
610	Shift - approximate amplitude of 20 mm (-7 to 13)
632	Shift - approximate amplitude of 20 mm (18 to -2) fidget at bottom of shift before COP value settles to shifted value
746	Fidget - approximate amplitude of 15 mm (-13 to -28)
775	Fidget - approximate amplitude of 20 mm (-11 to -31)
816	Fidget - approximate amplitude of 23 mm (-15 to 8)
1177	Shift - approximate amplitude of 15 mm (-23 to -8)
1233	Shift - approximate amplitude of 11 mm (-20 to -9)
1295	Shift - approximate amplitude of 10 mm (-9 to -19)
1365	Shift - approximate amplitude of 15 mm (-19 to -4)
1393	Fidget - approximate amplitude of 23 mm (-15 to 8)
1402	Fidget - approximate amplitude of 23 mm (-10 to 13) more easily seen on non-filtered data
1409	Fidget - approximate amplitude of 15 mm (-6 to -21)
1496	Fidget - approximate amplitude of 24 mm (-7 to -31)
1570	Fidget - approximate amplitude of 19 mm (-9 to 10)
1792	Fidget - approximate amplitude of 28 mm (-5 to -33)
3rd order begins - 9	Shift - approximate amplitude of 8 mm (-9 to -1)
61	Fidget - approximate amplitude of 13 mm (-10 to 3)
679	Fidget - approximate amplitude of 14 mm (-11 to 3) may be too wide at base, followed by what may be another fidget of 10 mm (-11 to -21)
769	Fidget - approximate amplitude of 11 mm (-16 to -5)
1023	Fidget - approximate amplitude of 13 mm (-16 to -3)
1073	Fidget - approximate amplitude of 14 mm (-10 to 4)
1101	Fidget - approximate amplitude of 11 mm (-10 to 1)

Approximate Time (seconds)	Pattern Description
1164	Shift - approximate amplitude of 5 mm (-16 to -21)
1215	Fidget - approximate amplitude of 11 mm (-19 to -30)
1444	Fidget - approximate amplitude of 11 mm (-14 to -3)
1515	Shift - approximate amplitude of 6 mm (-20 to -14)
1557	Shift - approximate amplitude of 5 mm (-15 to -10)
1592	Fidget - approximate amplitude of 13 mm (-9 to 4)
1670	Shift - approximate amplitude of 7 mm (-16 to -9) preceded by fidget-like pattern
1764	Shift - approximate amplitude of 6 mm (-12 to -6)
4th order begins - 515	Fidget - approximate amplitude of 18 mm (-10 to -28)
517	Fidget - approximate amplitude of 28 mm (-10 to 18)
521	Shift - approximate amplitude of 10 mm (-10 to 0) these three patterns, along with one more fidget seem to run into one another
545	Shift - approximate amplitude of 6 mm (-3 to -9) preceded by a rather large fidget which may be "absorbed" into the shift
658 to 669	4 Fidgets and 1 Shift Shift - approximate amplitude of 6 mm (-4 to -10) preceded by potentially 4 fidgets, maybe less
832 to 845 858 to 863 871 to 879	10 Fidgets - various amplitudes, 10 mm a 20 mm number of occurrences may exclude patterns from being identifiable, they become the norm, not the exception
910	Fidget - approximate amplitude of 15 mm (5 to -10) in the middle of two smaller fidgets
1331	Shift - approximate amplitude of 17 mm (-22 to -5)
1465	Fidget - approximate amplitude of 26 mm (-9 to 17) double-peaked, base may be too wide
1626	Shift - approximate amplitude of 6 mm (-7 to -13) preceded by a fidget

Subject 9

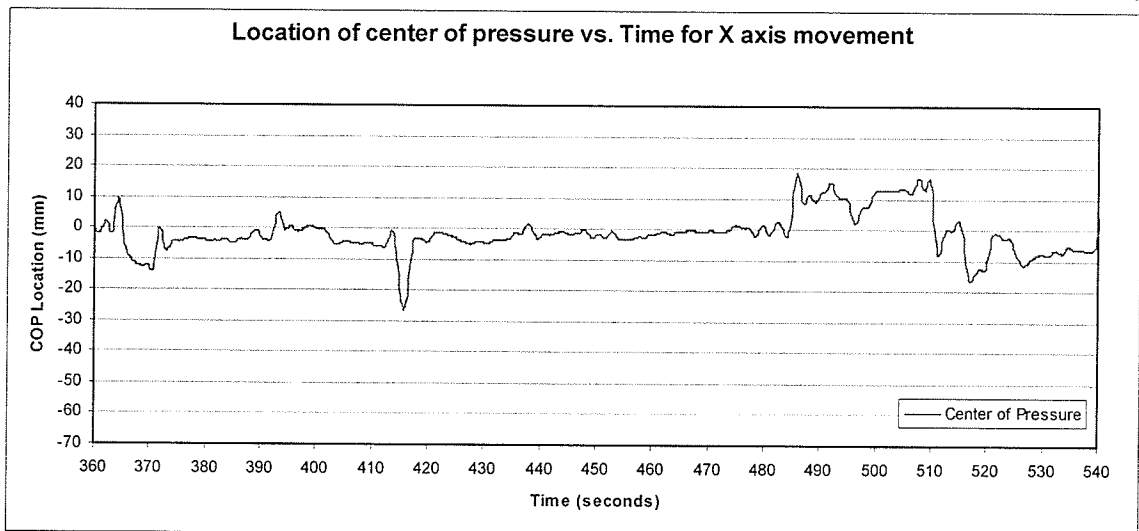
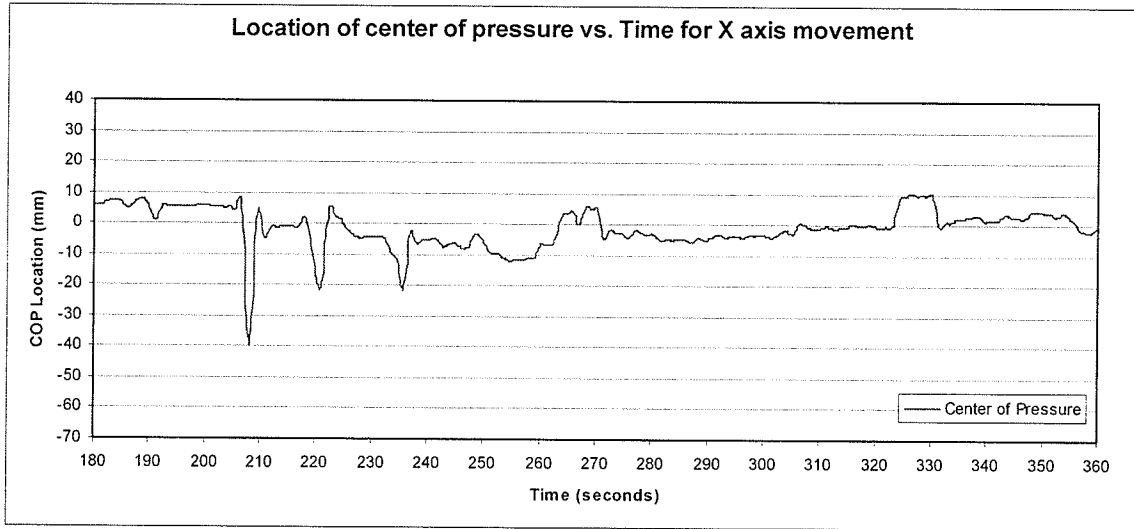
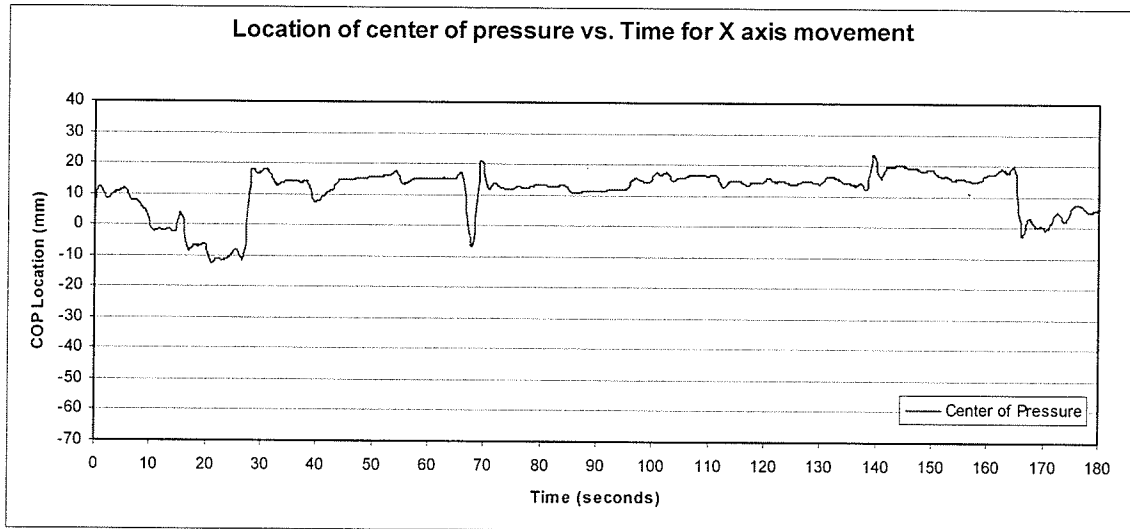

Location of center of pressure vs. Time for X axis movement

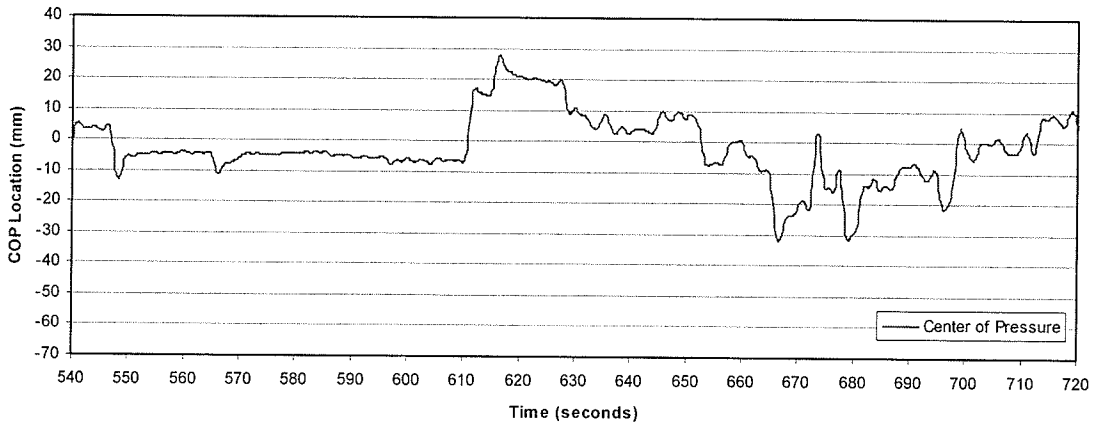

Location of center of pressure vs. Time for X axis movement

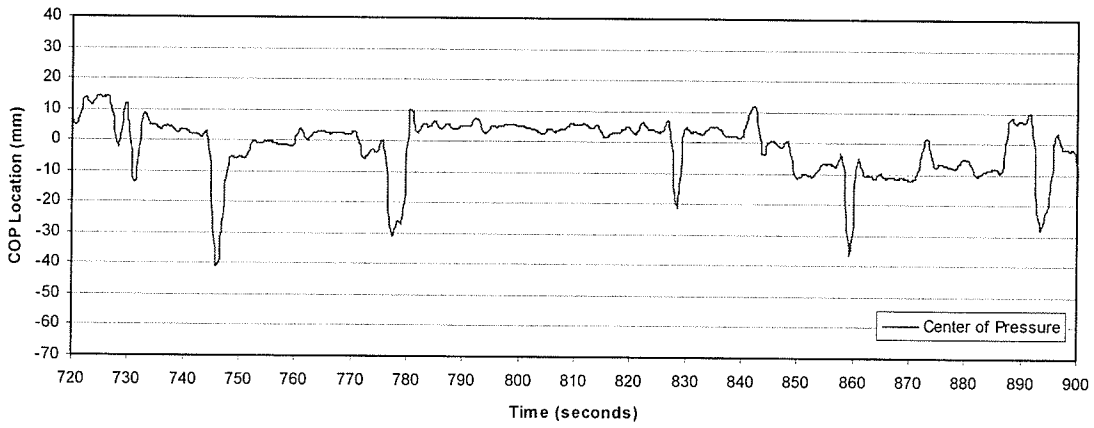

Location of center of pressure vs. Time for X axis movement

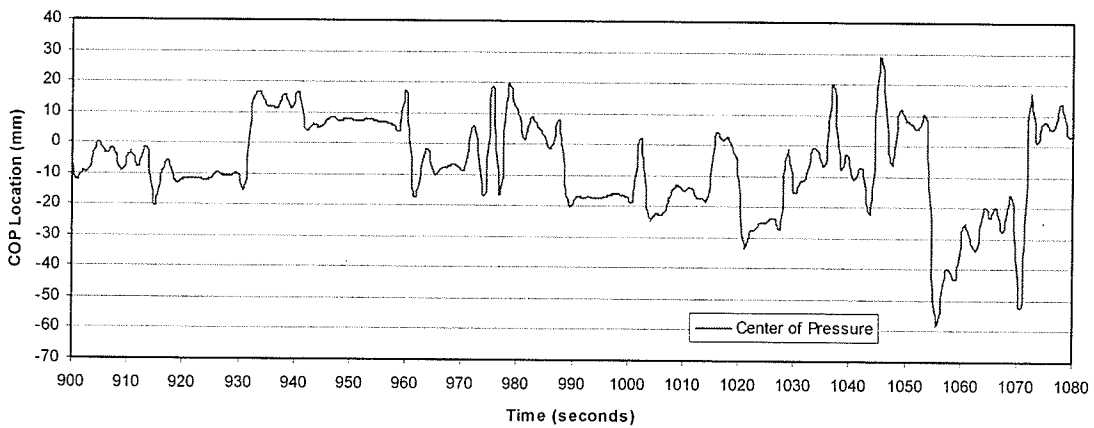

Location of center of pressure vs. Time for X axis movement

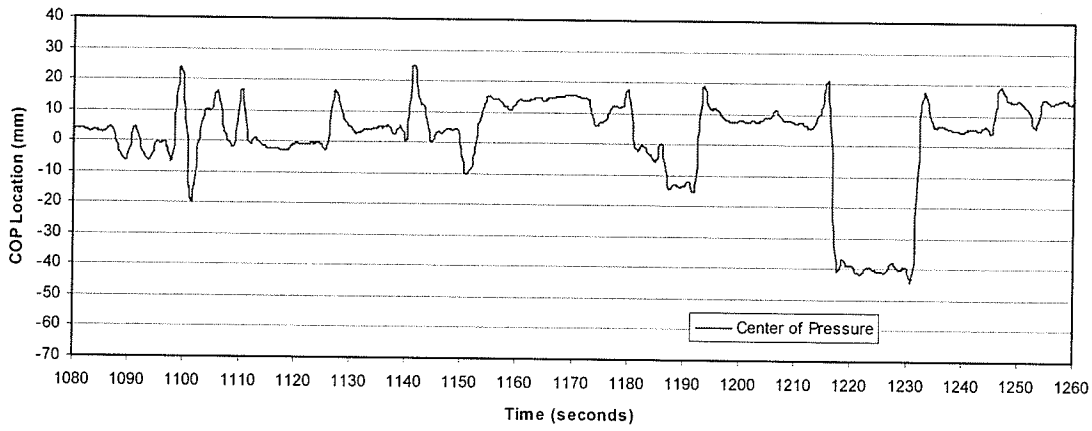

Location of center of pressure vs. Time for X axis movement

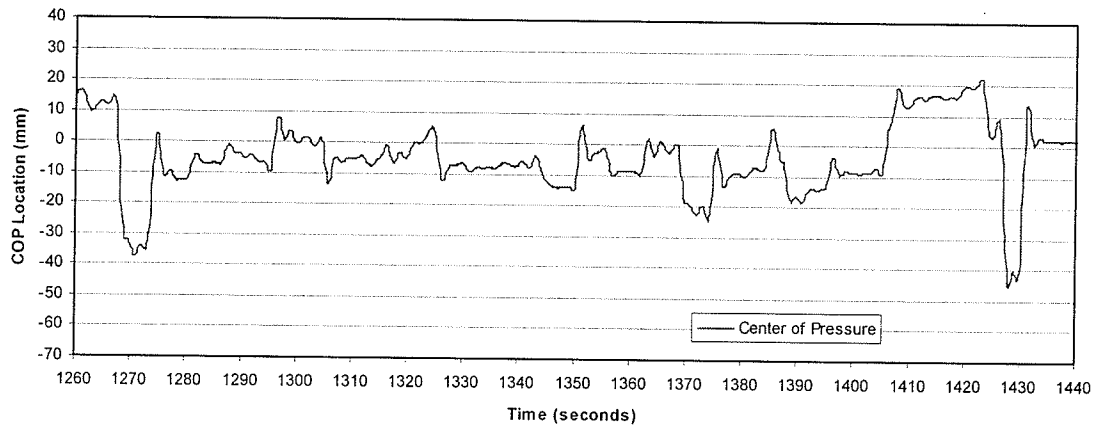

Location of center of pressure vs. Time for X axis movement

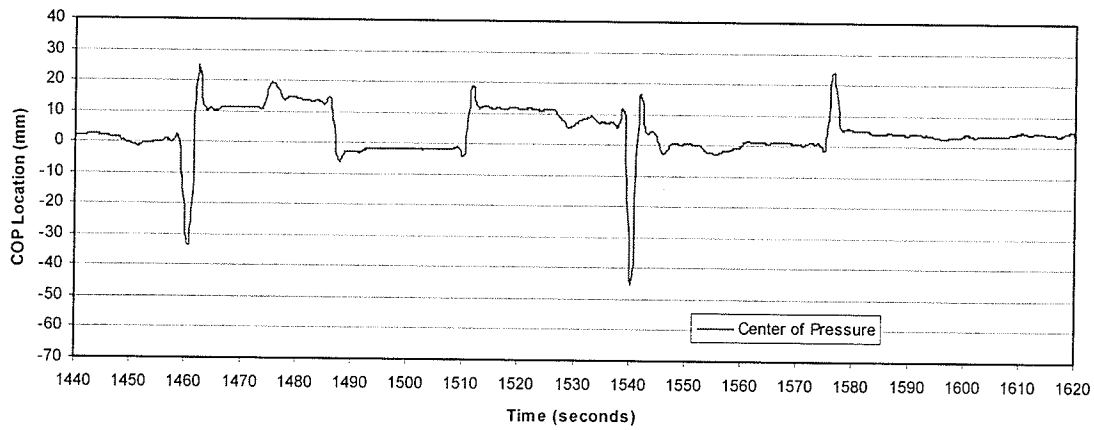

Location of center of pressure vs. Time for X axis movement

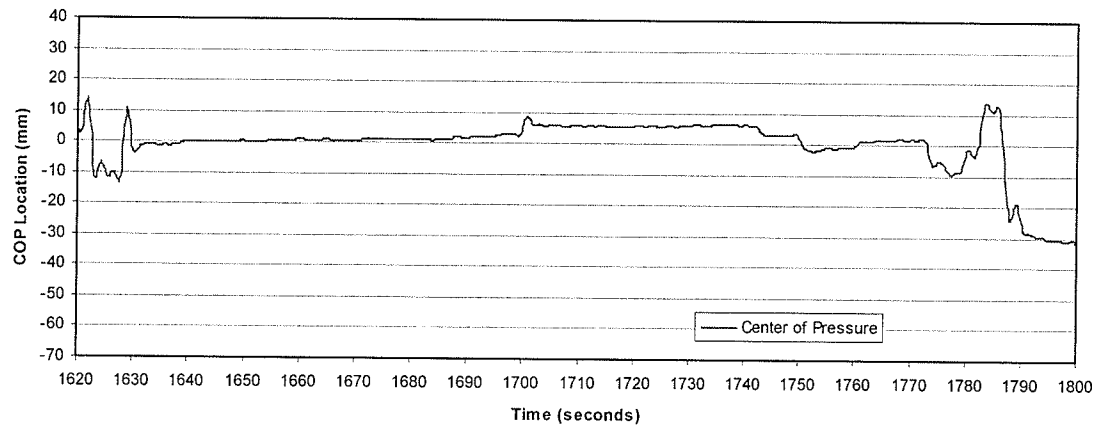

Location of center of pressure vs. Time for Y axis movement

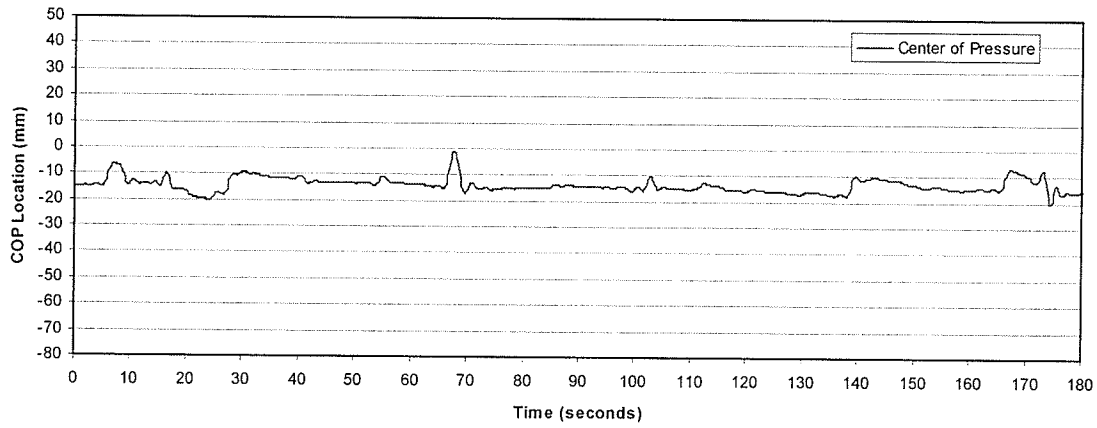

Location of center of pressure vs. Time for Y axis movement

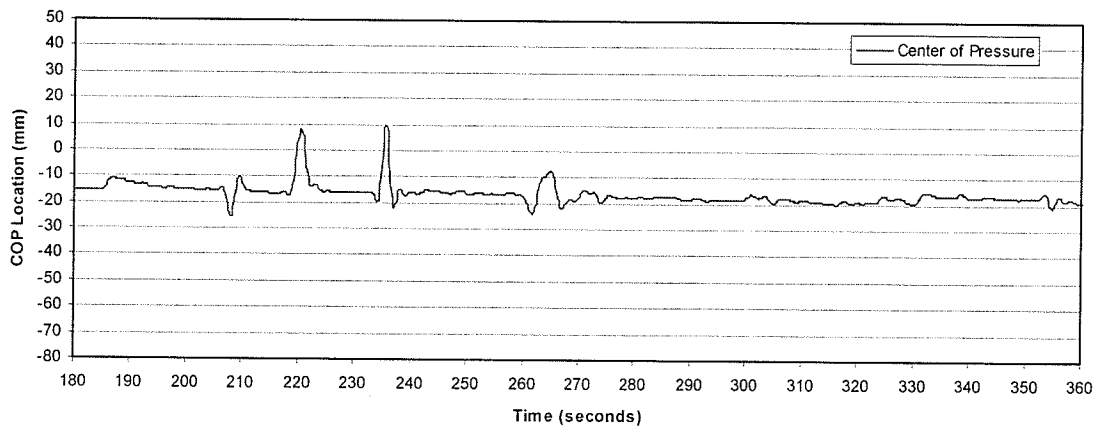

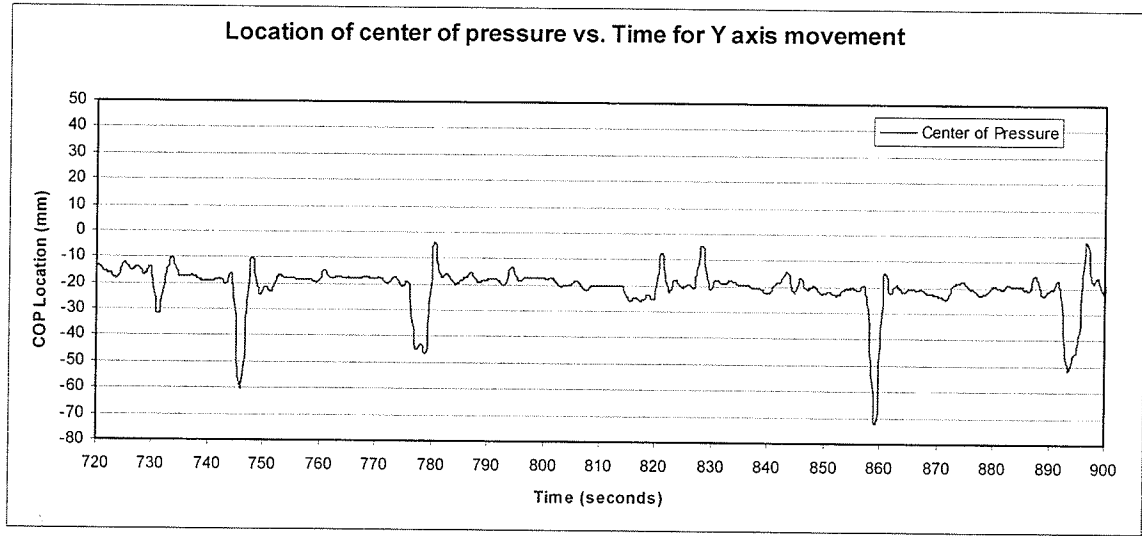
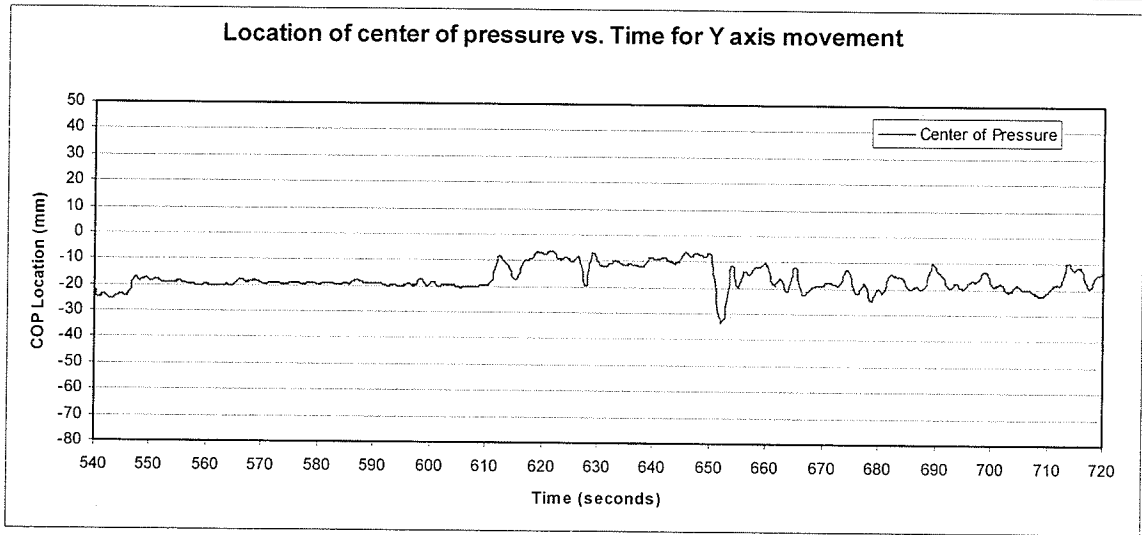
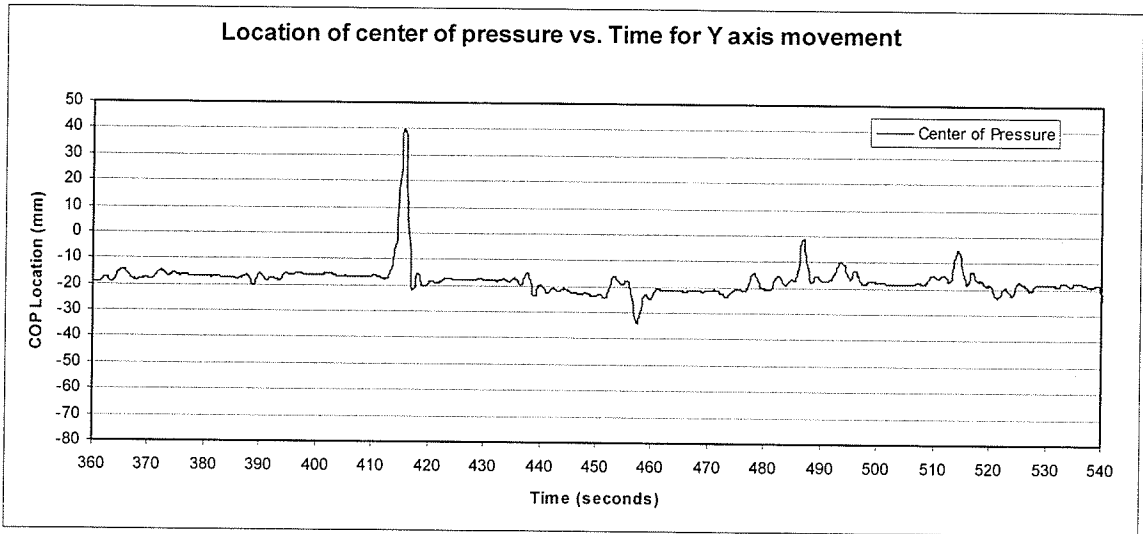

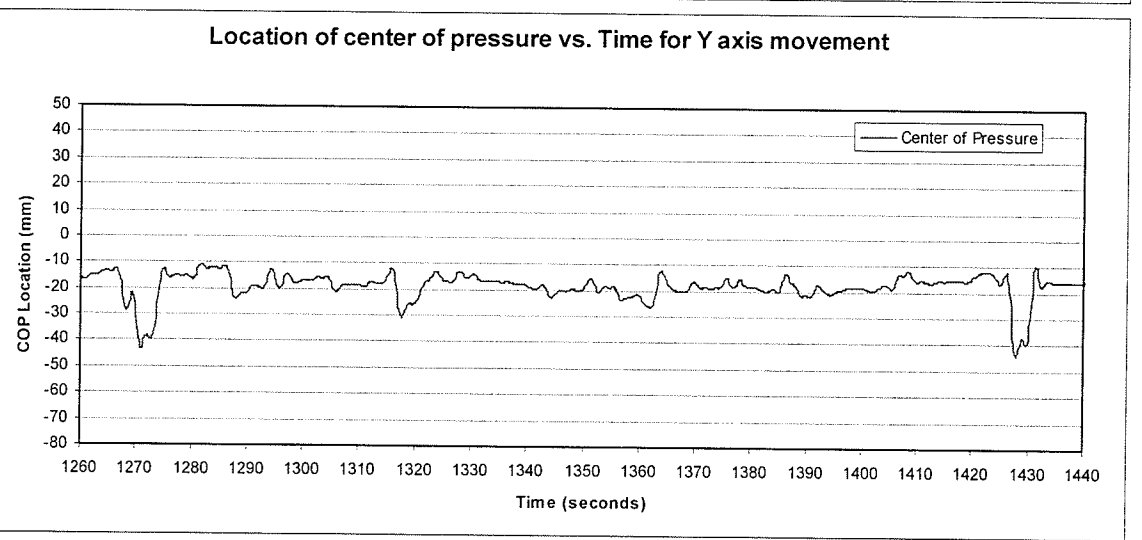
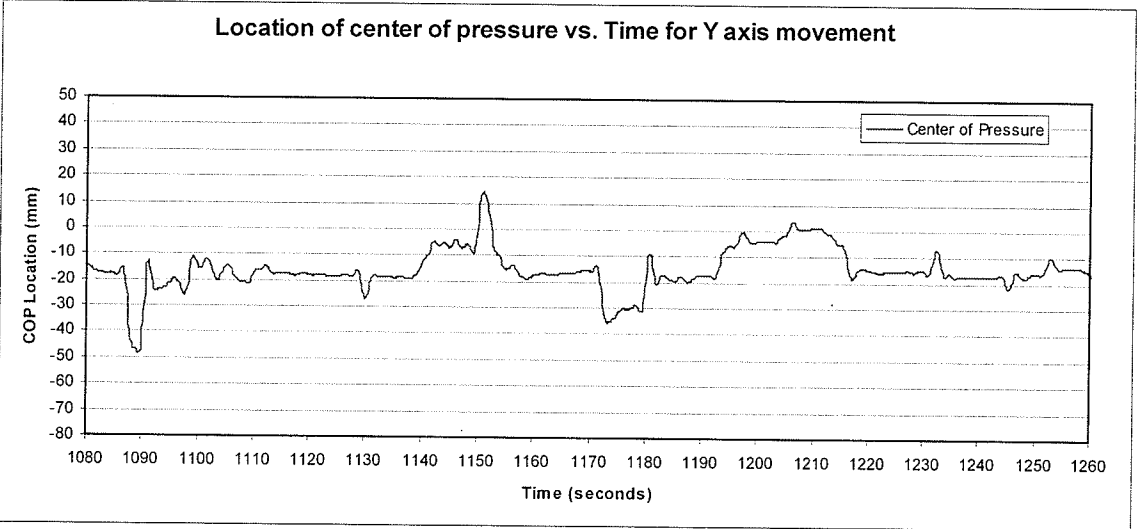
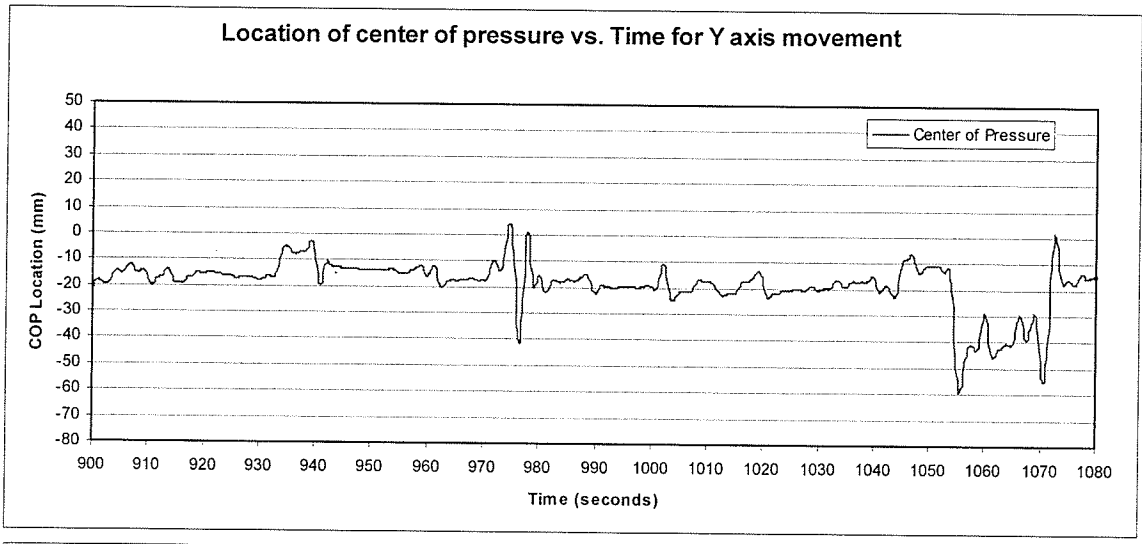

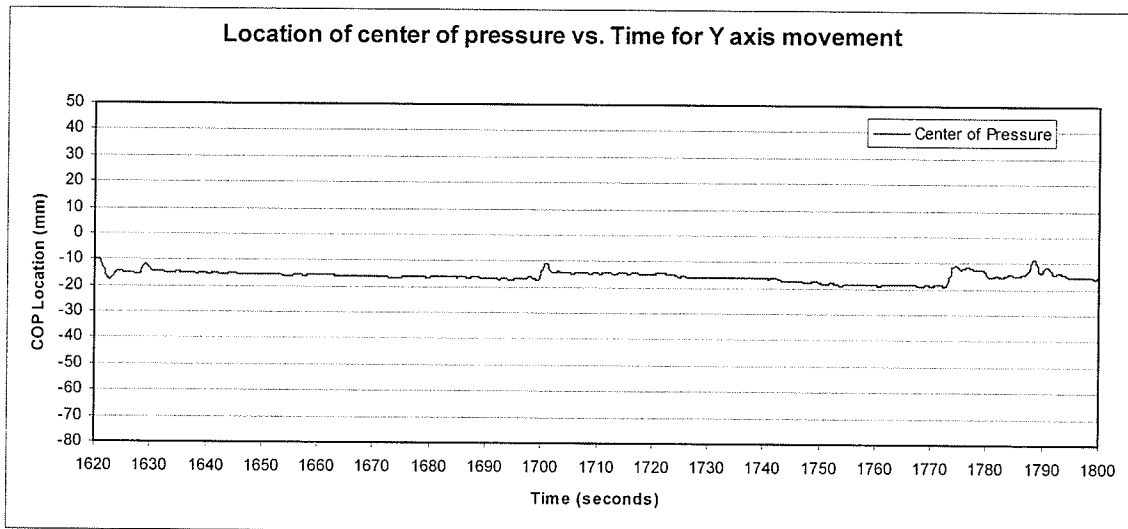
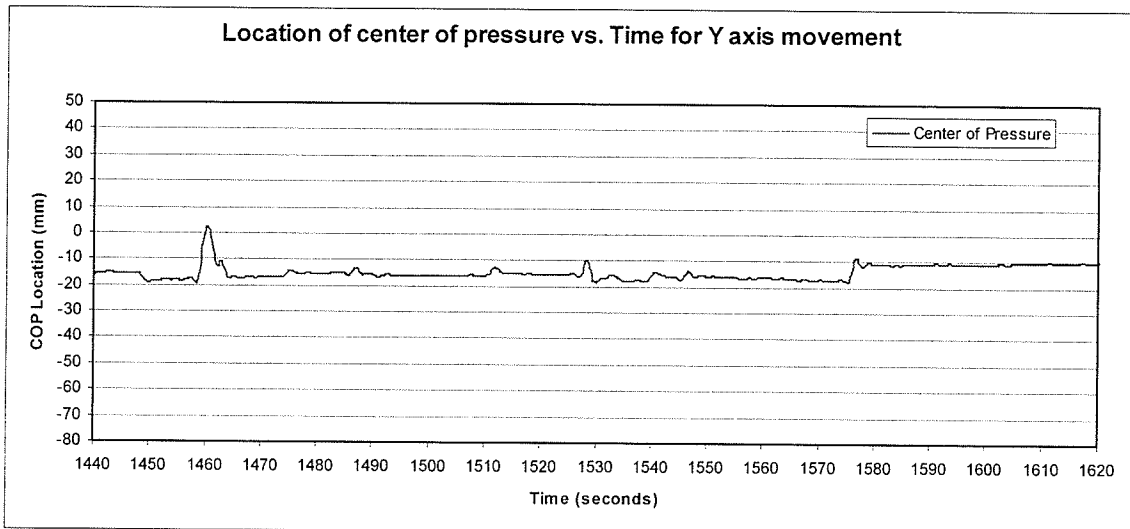

Subject - 9X	Manual Pattern Identification Chart
Approximate Time (seconds)	Pattern Description
1st order begins - 27	Shift - approximate amplitude of 28 mm (-10 to 18)
165	Shift - approximate amplitude of 21 mm (20 to -1)
205	Fidget - approximate amplitude of 45 mm (5 to -40)
	possible shift at conclusion of fidget, however shift amplitude
	is less than 10 mm
610	Shift - approximate amplitude of 23 mm (-7 to 16)
666 to 727	Drift - approximate amplitude of 46 mm (-32 to 14) not smooth, but drifting (ramp-like) appearance evident
743	Fidget - approximate amplitude of 35 mm (-6 to -41) occurs as part of smaller shift (see 4th order)
857	Fidget - approximate amplitude of 32 mm (-5 to -37)
930	Shift - approximate amplitude of 25 mm (-10 to 15)
974	Fidget - approximate amplitude of 37 mm (-18 to 19)
1014	Shift - approximate amplitude of 21 mm (-19 to 2)
1019	Shift - approximate amplitude of 28 mm (-4 to -32)
1053	Shift - approximate amplitude of 67 mm (8 to -59)
1192	Shift - approximate amplitude of 25 mm (-14 to 11)
1215	Shift - approximate amplitude of 48 mm (10 to -38)
1231	Shift - approximate amplitude of 47 mm (-40 to 7)
1265	Shift - approximate amplitude of 44 mm (12 to -32)
1273	Shift - approximate amplitude of 26 mm (-36 to -10) fidget-like overshoot before COP settles
1404	Shift - approximate amplitude of 22 mm (-9 to 13)
1456	Fidget - approximate amplitude of 33 mm (0 to -33)
1538	Fidget - approximate amplitude of 56 mm (10 to -46)
1629 to 1741	Drift - approximate amplitude of 8 mm (-1 to 7)
1786	Shift - approximate amplitude of 31 mm (11 to -20)
2nd order begins - 65	Fidget - approximate amplitude of 24 mm (17 to -7)
218	Fidget - approximate amplitude of 22 mm (1 to -21)
262	Shift - approximate amplitude of 11 mm (-8 to 3)
270	Shift - approximate amplitude of 10 mm (5 to -5)
280 to 323	Drift - approximate amplitude of 5 mm (-5 to 0) drift may continue after next two shifts until approx. 350 seconds
330	Shift - approximate amplitude of 11 mm (10 to -1)
413	Fidget - approximate amplitude of 25 mm (-2 to -27)
483	Shift - approximate amplitude of 12 mm (-2 to 10) overshoot on shift (fidget-like)
509	Shift - approximate amplitude of 18 mm (18 to 0) ampl. difficult to approximate because COP doesn't really settle
Subject - 9X cont'd	Manual Pattern Identification Chart
650	Shift - approximate amplitude of 17 mm (9 to -3)
672	Fidget - approximate amplitude of 20 mm (-17 to 3)

Approximate Time (seconds)	Pattern Description
729	Fidget - approximate amplitude of 23 mm (10 to -13)
825	Fidget - approximate amplitude of 26 mm (5 to -21)
886	Shift - approximate amplitude of 19 mm (-10 to 9)
985	Shift - approximate amplitude of 18 mm (0 to -18)
1000	Fidget - approximate amplitude of 21 mm (-20 to 1)
1035	Fidget - approximate amplitude of 27 mm (-7 to 20)
1097	Fidget - approximate amplitude of 30 mm (-7 to 23)
1107	Fidget - approximate amplitude of 18 mm (-1 to 17)
1138	Fidget - approximate amplitude of 25 mm (0 to 25) base width may be too large
1245	Shift - approximate amplitude of 16 mm (4 to 20)
1293	Shift - approximate amplitude of 18 mm (-10 to 8)
1323	Shift - approximate amplitude of 16 mm (5 to -11)
1360	Shift - approximate amplitude of 11 mm (-10 to 1)
1367	Shift - approximate amplitude of 19 mm (0 to -19)
1485	Shift - approximate amplitude of 19 mm (-5 to 14)
1509	Shift - approximate amplitude of 12 mm (-1 to 11)
1781	Shift - approximate amplitude of 16 mm (-3 to 13)
3rd order begins - 15	
547	Shift - approximate amplitude of 7 mm (-2 to -9) overshoot at end of shift
613	Shift - approximate amplitude of 9 mm (14 to 23) slight overshoot before settling
643	Shift - approximate amplitude of 7 mm (3 to 10)
656	Shift - approximate amplitude of 7 mm (-7 to 0)
726	Fidget - approximate amplitude of 14 mm (12 to -2)
751	Shift - approximate amplitude of 5 mm (-5 to 0)
769	Shift - approximate amplitude of 8 mm (2 to -6)
848	Shift - approximate amplitude of 9 mm (-1 to -10)
913	Fidget - approximate amplitude of 14 mm (-6 to -20)
938	Shift - approximate amplitude 6 mm (11 to 5)
4th order begins - 137	
205	Shift - approximate amplitude of 8 mm (12 to 20) preceded by a small fidget-like migration
370	Shift - approximate amplitude of 6 mm (5 to -1) preceded by a large fidget of approximately 45 mm (-5 to 40) which may be a pattern unto itself
514	Shift - approximate amplitude of 8 mm (-13 to -5) preceded by a fidget as part of the shift
519	Shift - approximate amplitude of 13 mm (0 to -13)
524	Shift - approximate amplitude of 11 mm (12 to -1)
524	Shift - approximate amplitude of 9 mm (-2 to -11) previous 3 shifts may not be pronounced enough to be shifts
743	Shift - approximate amplitude of 8 mm (2 to -6)

Approximate Time (seconds)	Pattern Description
774 to 781	Shift(s) - 2 possible shifts, first with approximate amplitude of 30 mm (0 to -30), second with approximate amplitude of 32 mm (-27 to 5)
891	Fidget - approximate amplitude of 36 mm (7 to -29) may be too wide at base, also appears to be slight shift which may supersede fidget
956	Shift - approximate amplitude of 14 mm (4 to -10) fidgets as part of shift
970	Fidget - approximate amplitude of 16 mm (-9 to 7)
1044	Fidget - approximate amplitude of 36 mm (-7 to 29)
1148	Shift - may be first of 2 shifts, filtered data smoothes to make it appear as one shift (with preceding downward dip) of approx. amplitude of 10 mm (5 to 15)
1180	Shift - approximate amplitude of 13 mm (12 to -1)
1185	Shift - approximate amplitude of 11 mm (-3 to -14)
1349	Shift - approximate amplitude of 10 mm (-15 to -5) fidget-like overshoot before COP settles
1425	Shift - approximate amplitude of 49 mm (5 to -44)
1430	Shift - approximate amplitude of 45 mm (-43 to 2) combined with previous shift, pattern appears like large fidget
1456	Shift - approximate amplitude of 10 mm (0 to 10) preceded by large fidget downward of approx. amplitude of 33 mm (0 to -33) and smaller overshoot
1574	Shift - approximate amplitude of 5 mm (0 to 5) includes larger fidget-like overshoot
1621	Shift - approximate amplitude of 14 mm (3 to -11) overshoot precedes shift
1627	Shift - approximate amplitude of 10 mm (-11 to -1) overshoot before COP settles to shifted value

Subject - 9Y	Manual Pattern Identification Chart
Approximate Time (seconds)	Pattern Description
1st order begins - 413	Fidget - approximate amplitude of 58 mm (-18 to 40)
745	Fidget - approximate amplitude of 40 mm (-20 to -60)
775	Shift - approximate amplitude of 25 mm (-20 to -45)
779	Shift - approximate amplitude of 28 mm (-46 to -18) slight overshoot before COP settles
856	Fidget - approximate amplitude of 53 mm (-20 to -73)
892	Fidget - approximate amplitude of 31 mm (-20 to -51) base may be too wide
1053	Shift - approximate amplitude of 30 mm (-12 to -42)
1071	Shift - approximate amplitude of 22 mm (-40 to -18) amplitude is difficult to approximate due to fidgets accompanying shift
1171	Shift - approximate amplitude of 22 mm (-14 to -26)
1273	Shift - approximate amplitude of 25 mm (-40 to -15)

Approximate Time (seconds)	Pattern Description
1425	Shift - approximate amplitude of 32 mm (-12 to -44) may be too narrow for shifts, too wide for fidget, along with next shift
1430	Shift - approximate amplitude of 24 mm (-40 to -16)
2nd order begins - 26 to 66	Drift - approximate amplitude of 6 mm (-10 to -16)
66	Fidget - approximate amplitude of 15 mm (-1 to -16)
218	Fidget - approximate amplitude of 27 mm (-18 to 9)
234	Fidget - approximate amplitude of 30 mm (-20 to 10)
261	Shift - approximate amplitude of 14 mm (-24 to -10)
266	Shift - approximate amplitude of 11 mm (-10 to -21)
485	Fidget - approximate amplitude of 17 mm (-18 to -1)
650	Fidget - approximate amplitude of 23 mm (-10 to -33)
729	Fidget - approximate amplitude of 16 mm (-15 to -31)
820	Fidget - approximate amplitude of 15 mm (-23 to -8)
827	Fidget - approximate amplitude of 16 mm (-20 to -4)
932	Shift - approximate amplitude of 12 mm (-17 to -5)
1043	Shift - approximate amplitude of 14 mm (-23 to -9)
1138	Shift - approximate amplitude of 14 mm (-20 to -6)
1149	Fidget - approximate amplitude of 24 mm (-10 to 14)
1179	Shift - approximate amplitude of 11 mm (-31 to -20) bit of a fidget at top of shift, although it is only about 10 mm
1192	Shift - approximate amplitude of 13 mm (-19 to -6)
1215	Shift - approximate amplitude of 14 mm (-5 to -19)
1284	Shift - approximate amplitude of 13 mm (-11 to -24)
1315	Shift - approximate amplitude of 18 mm (-12 to -30)
1323 to 1362	Drift - approximate amplitude of 13 mm (-13 to -26)
3rd order begins - 5	Shift - approximate amplitude of 8 mm (-15 to -7)
27	Shift - approximate amplitude of 9 mm (-19 to -10)
138	Shift - approximate amplitude of 9 mm (-19 to -10)
166	Shift - approximate amplitude of 7 mm (-15 to -8)
452	Shift - approximate amplitude of 6 mm (-23 to -17)
512	Fidget - approximate amplitude of 13 mm (-18 to -5)
546	Shift - approximate amplitude of 6 mm (-24 to -18)
626	Fidget - approximate amplitude of 11 mm (-9 to -20)
1000	Fidget - approximate amplitude of 10 mm (-20 to -10)
1058	Fidget - approximate amplitude of 13 mm (-42 to -29)
1575	Shift - approximate amplitude of 9 mm (-18 to -9)
1773	Shift - approximate amplitude of 8 mm (-19 to -11)
4th order begins - 896	Fidget - approximate amplitude of 18 mm (-19 to -1) a continuation of another potential fidget
973	Fidget - approximate amplitude of 42 mm (1 to -41) potentially middle of two smaller fidgets
1085	Shift - approximate amplitude of 29 mm (-18 to -47)

1090	Shift - approximate amplitude of 26 mm (-49 to -23)
	may be too narrow, along with previous shift, and yet too wide for a fidget, slight overshoot before COP settles
1268	Shift - approximate amplitude of 20 mm (-22 to -42)
1458	Fidget - approximate amplitude of 22 mm (-20 to 2) double-peaked, perhaps too wide to be a fidget

Subject 10

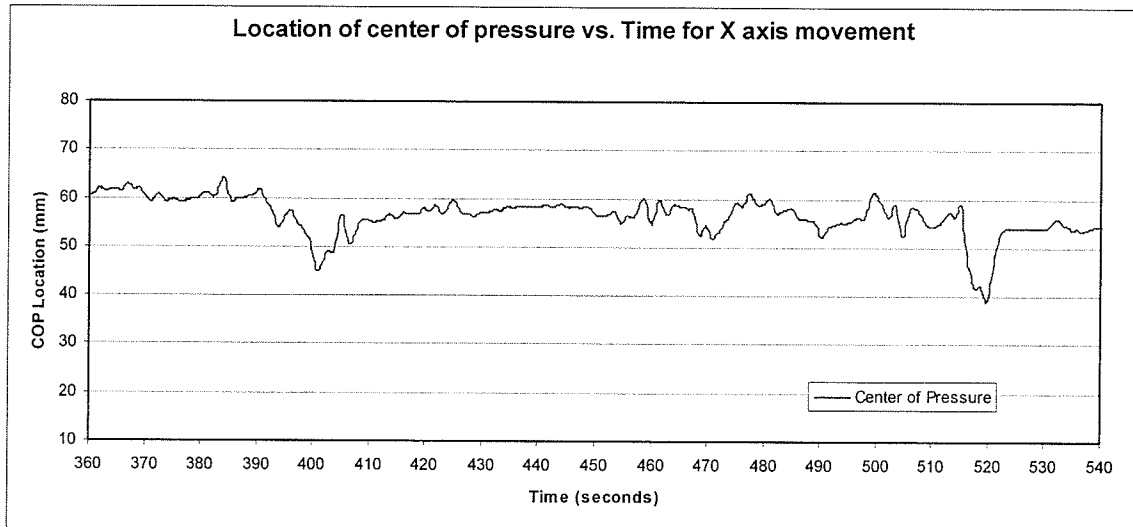
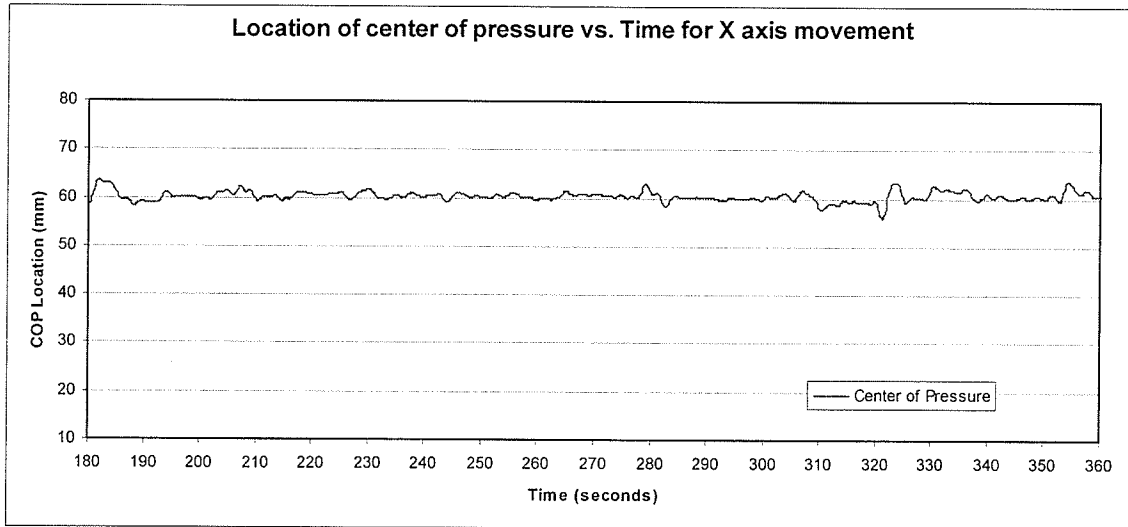
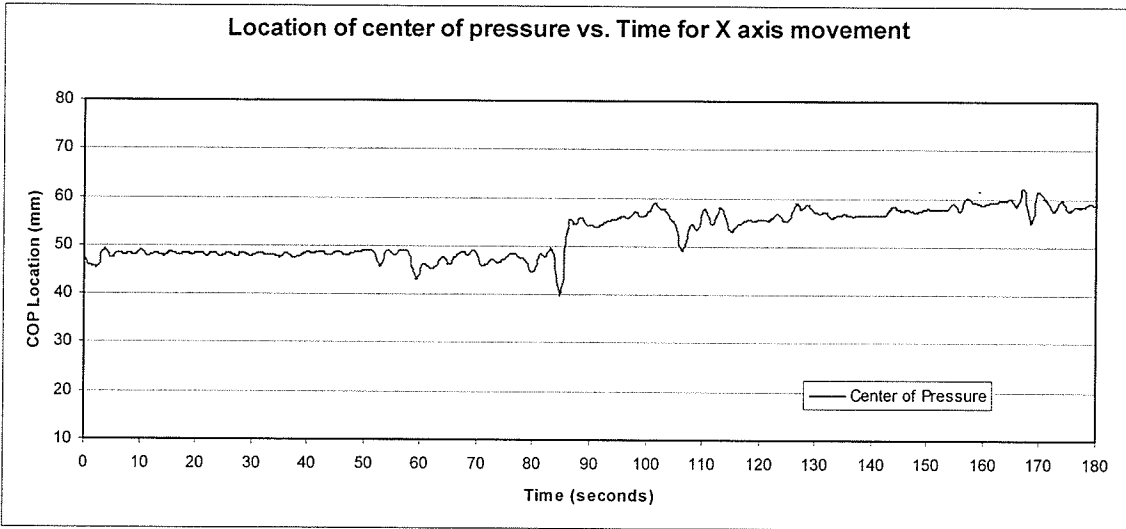

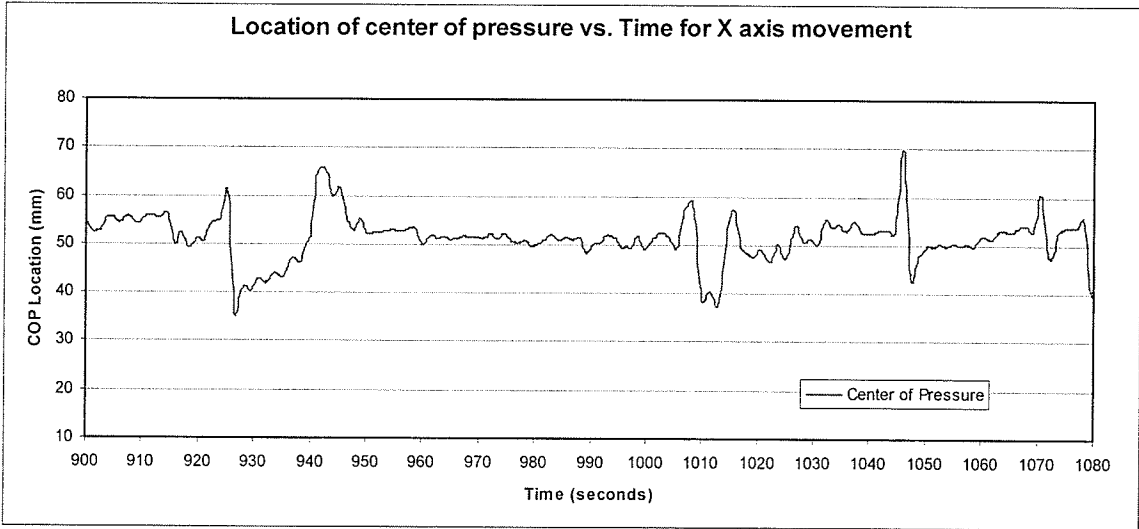
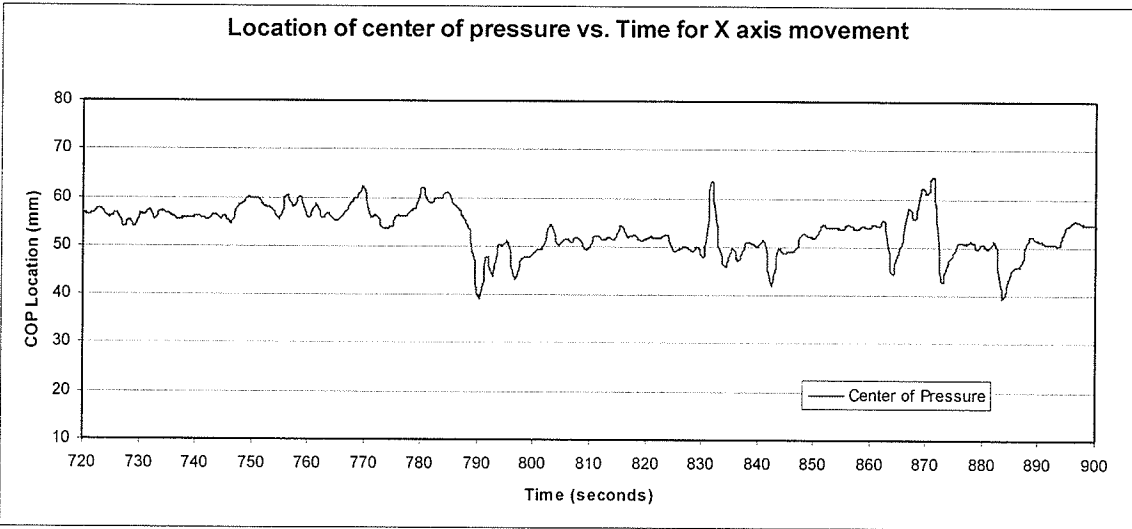
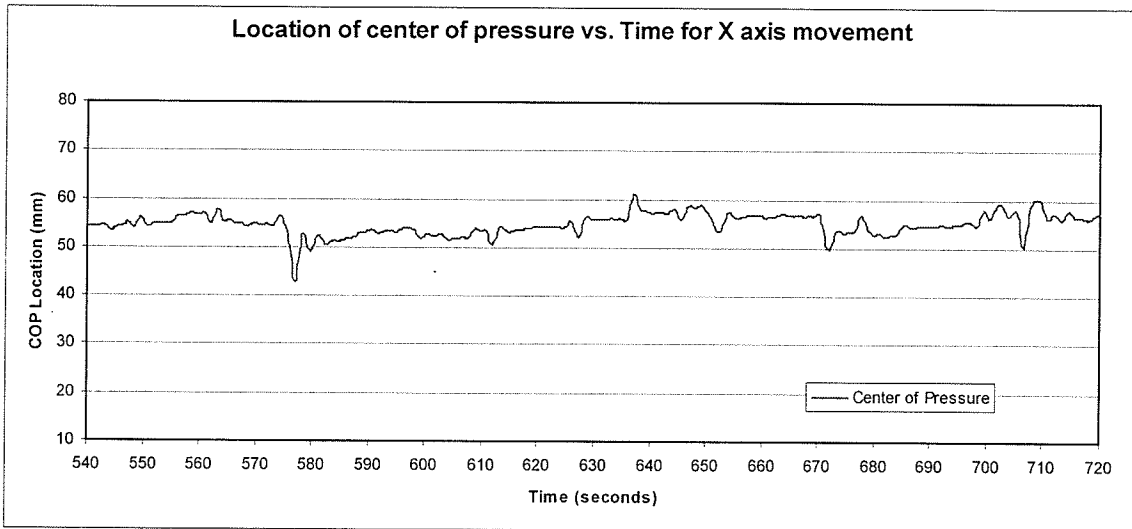

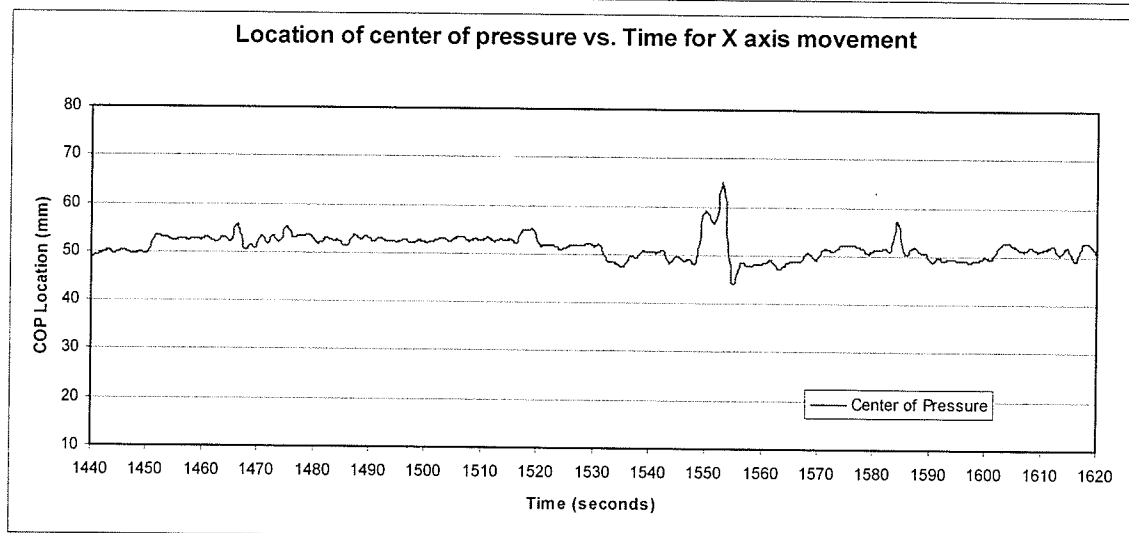
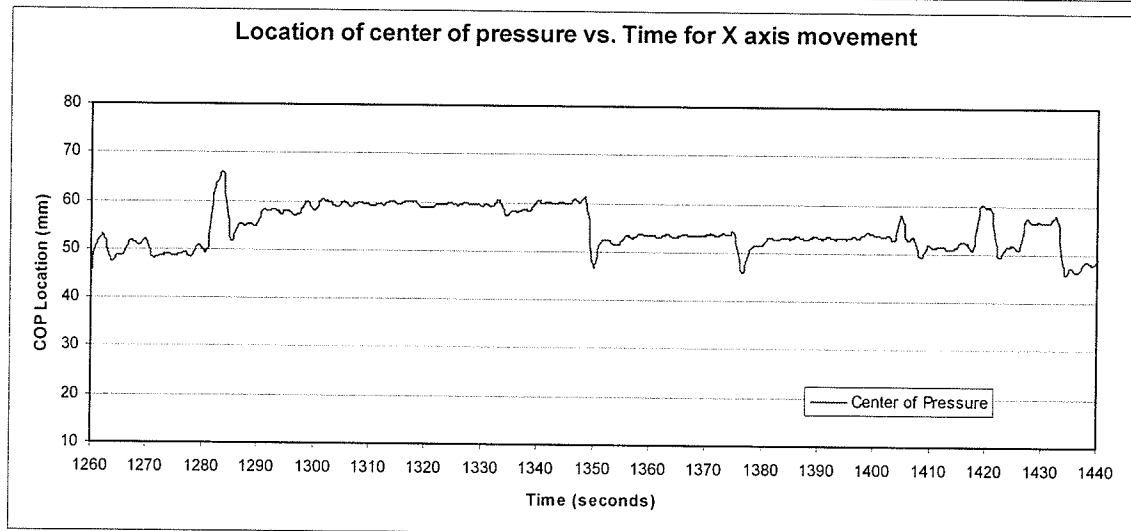
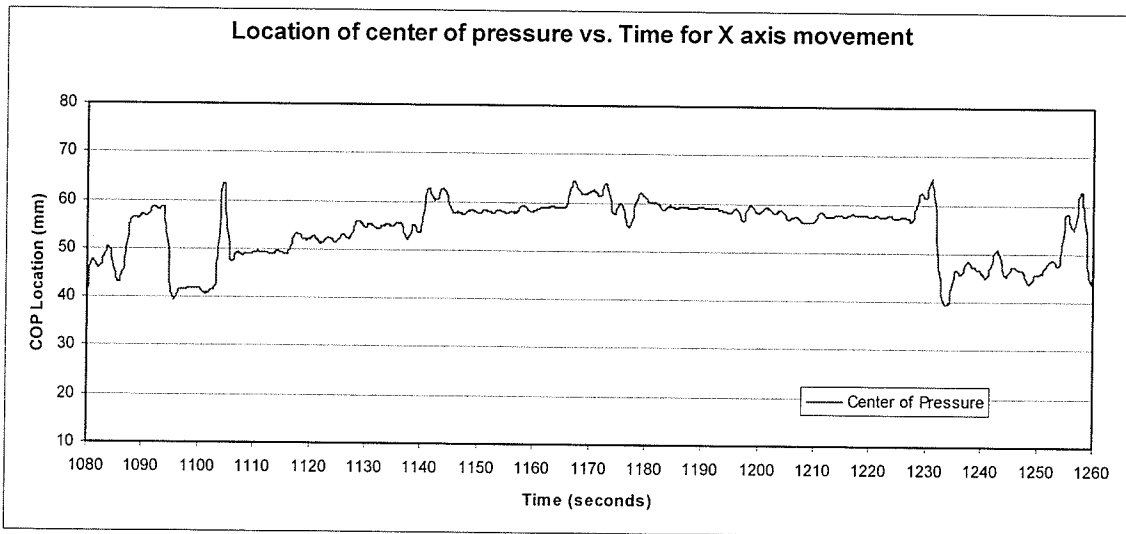

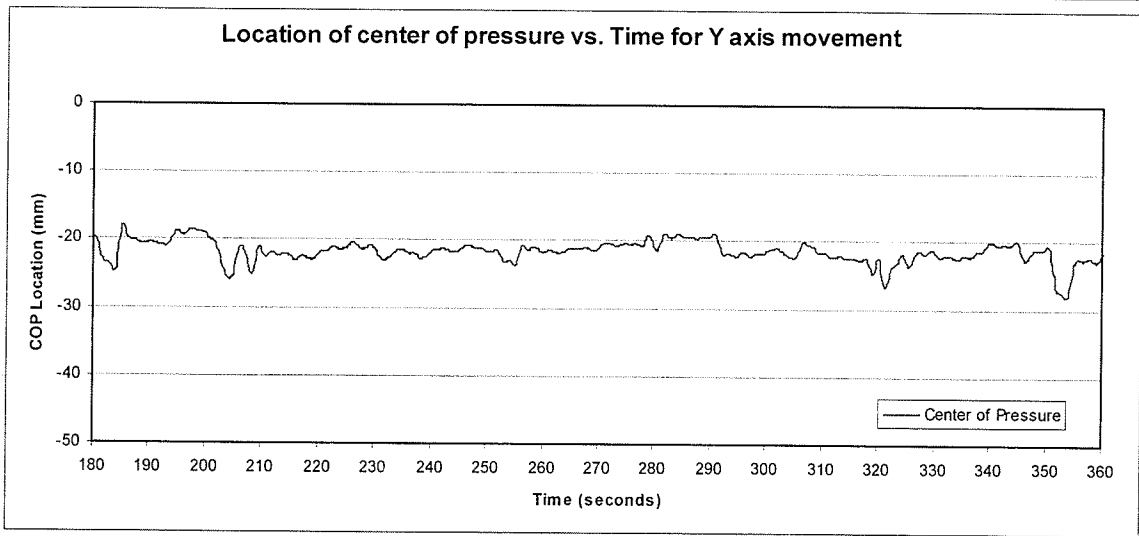
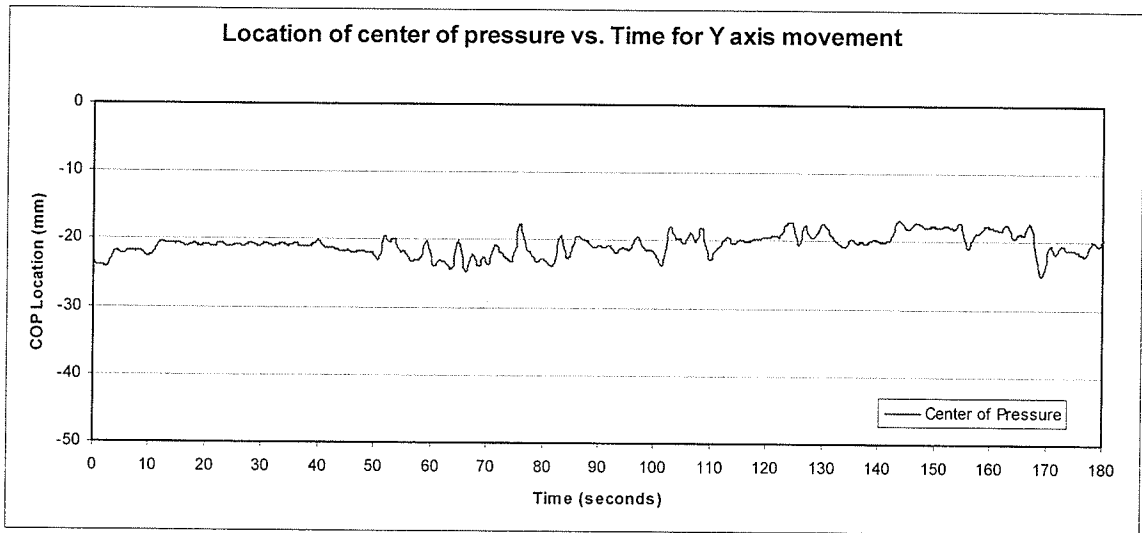
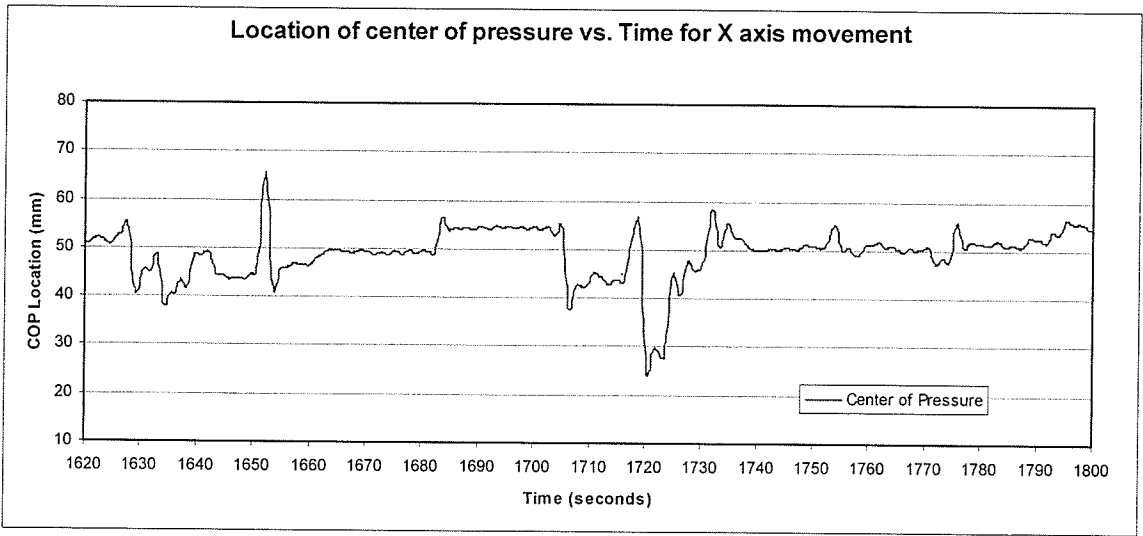

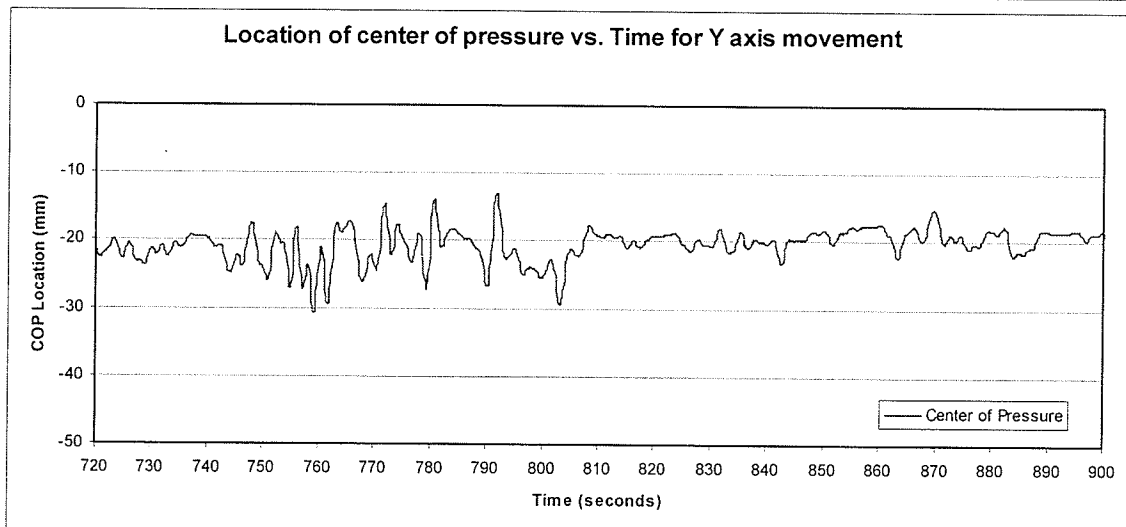
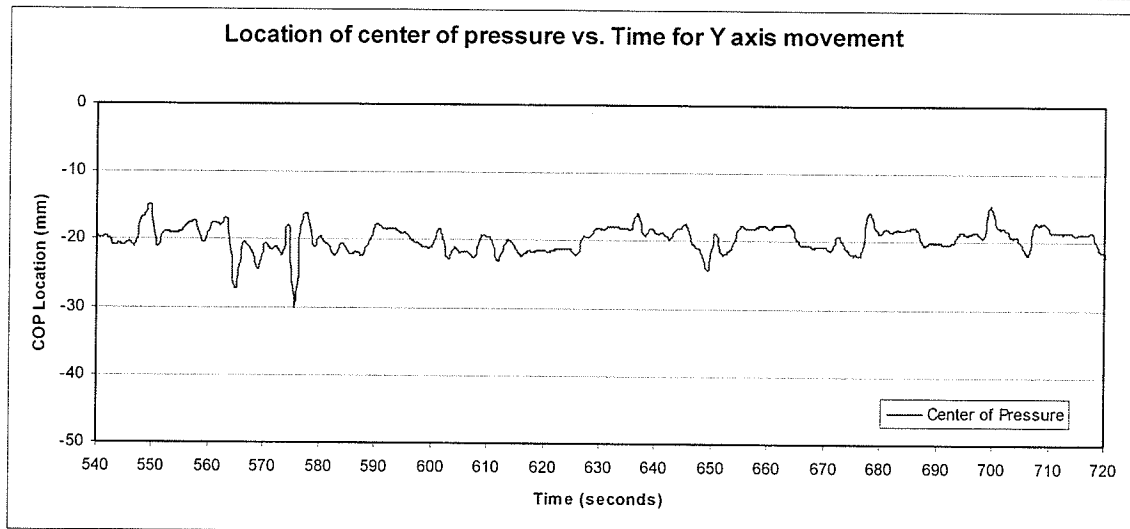
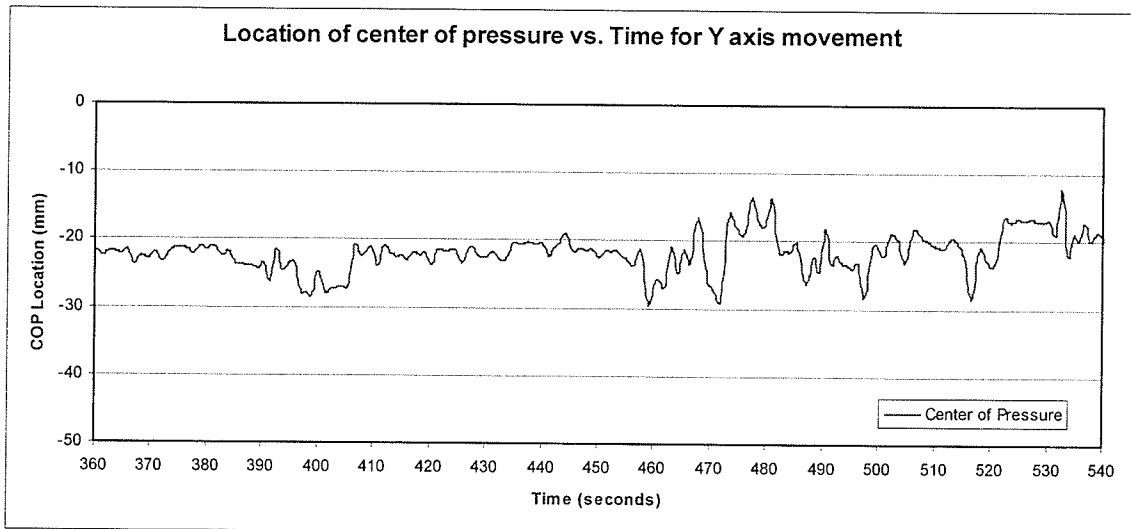

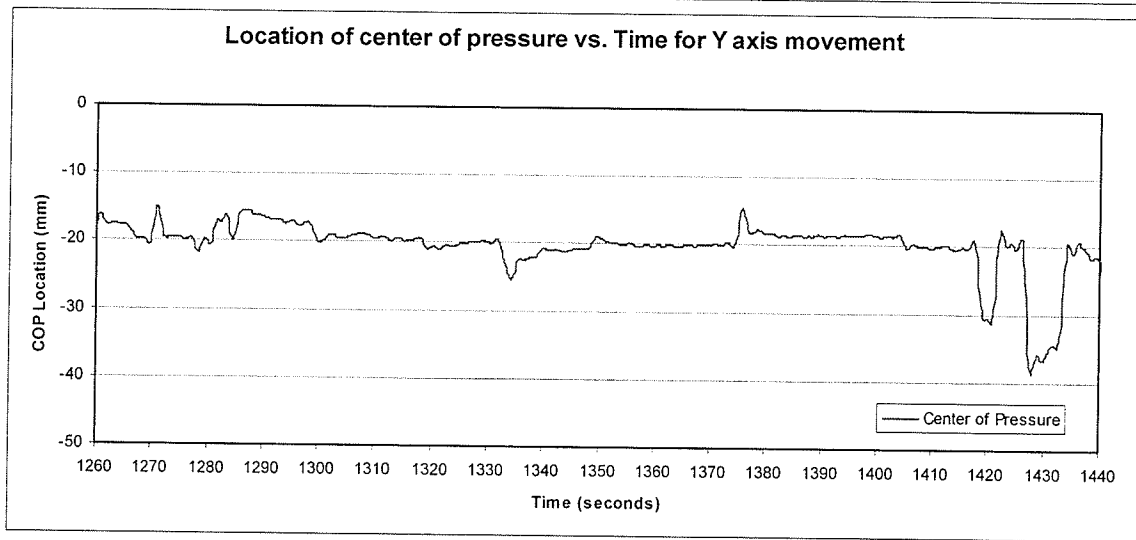
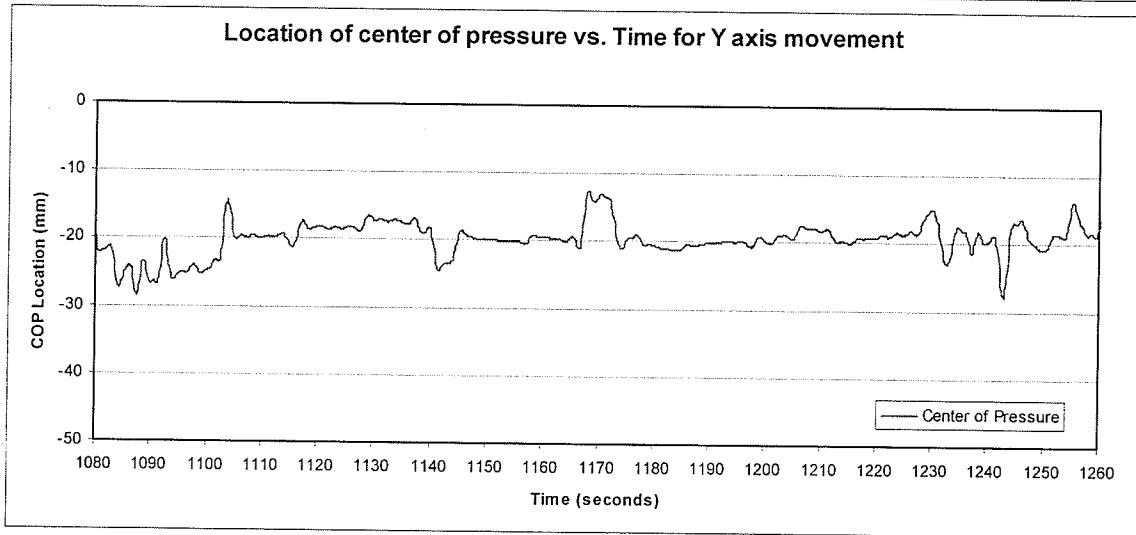
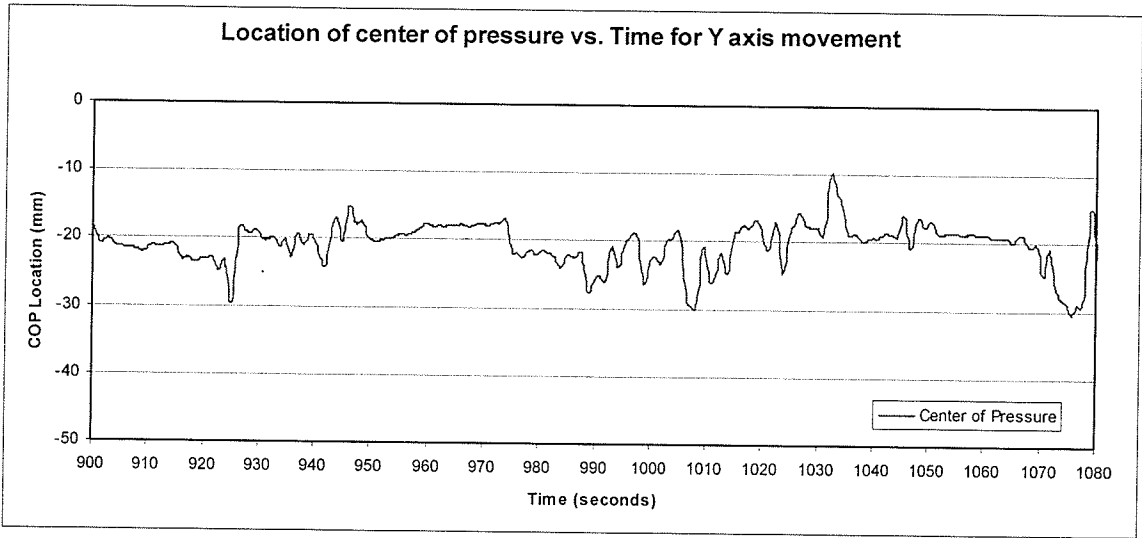

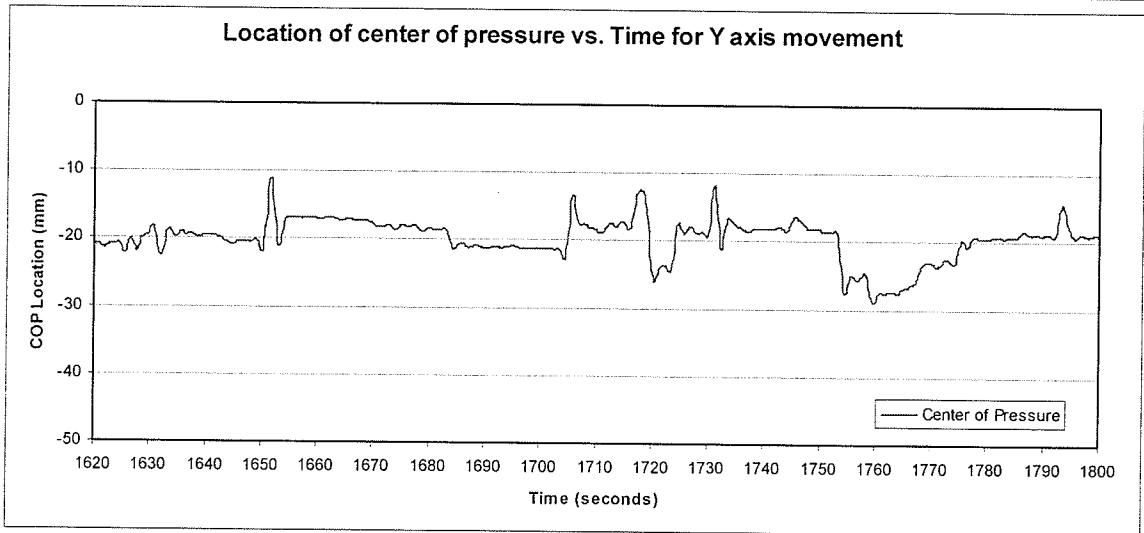
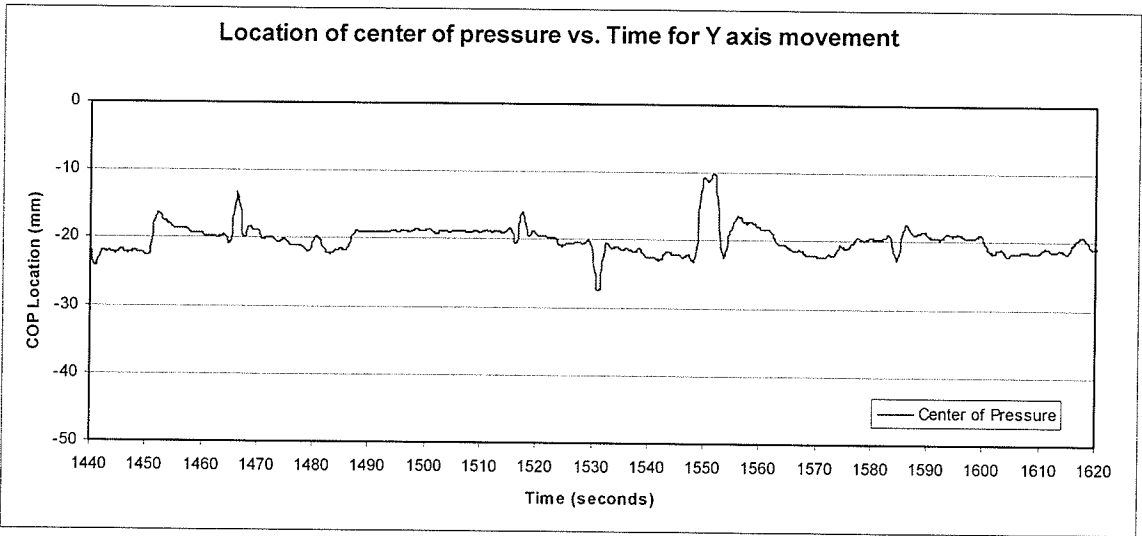

Subject - 10X	Manual Pattern Identification Chart
Approximate Time (seconds)	Pattern Description
1st order begins - 582 to 649	Drift - approximate amplitude of 9 mm (50 to 59)
2nd order begins - 113 to 163	Drift - approximate amplitude of 6 mm (54 to 60)
830	Fidget - approximate amplitude of 15 mm (48 to 63)
1044	Fidget - approximate amplitude of 18 mm (52 to 70)
1085	Shift - approximate amplitude of 14 mm (43 to 57)
1093	Shift - approximate amplitude of 19 mm (59 to 40)
1230	Shift - approximate amplitude of 16 mm (62 to 46) undershoot before settling
1280	Fidget - approximate amplitude of 16 mm (50 to 66) width may be a problem
1421	Shift - approximate amplitude of 11 mm (60 to 49)
1431	Shift - approximate amplitude of 12 mm (58 to 46)
1650	Fidget - approximate amplitude of 22 mm (44 to 66)
1703	Shift - approximate amplitude of 13 mm (55 to 42)
3rd order begins - 1138	Shift - approximate amplitude of 9 mm (53 to 62)
1349	Shift - approximate amplitude of 9 mm (61 to 52)
1417	Shift - approximate amplitude of 9 mm (60 to 51)
1425	Shift - approximate amplitude of 6 mm (51 to 57)
1681	Shift - approximate amplitude of 5 mm (49 to 54)
4th order begins - 82	Shift - approximate amplitude of 5 mm (50 to 55)
519	Shift - approximate amplitude of 15 mm (39 to 54)
575	Fidget - approximate amplitude of 11mm (53 to 42)
871	Shift - approximate amplitude of 11 mm (62 to 51)
924	Shift - approximate amplitude of 14 mm (55 to 41)
939	Shift - approximate amplitude of 9 mm (51 to 60)
1007	Shift - approximate amplitude of 12 mm (50 to 38) fidget or shift at beginning, not quite sure
1012	Shift - approximate amplitude of 10 mm (38 to 48) overshoot at end of shift
1102	Shift - approximate amplitude of 8 mm (14 to 49) overshoot of COP before settling (fidget-like), includes fidget of approximate amplitude of 15 mm (48 to 63)
1226	Shift - approximate amplitude of 5 mm (57 to 62)
1547	Shift - approximate amplitude of 11 mm (48 to 59)
1553	Shift - approximate amplitude of 11 mm (59 to 48) fidget-like migration at beginning of shift
1719	Shift - approximate amplitude of 14 mm (44 to 30) fidget-like migration at beginning of shift
1723	Shift - approximate amplitude of 11 mm (30 to 41)

Subject - 10Y	Manual Pattern Identification Chart
Approximate Time (seconds)	Pattern Description
1st order begins - None	
2nd order begins - 1426	
1432	Shift - approximate amplitude of 17 mm (-20 to -37)
	Shift - approximate amplitude of 15 mm (-35 to -20)
3rd order begins - 404	
520	Shift - approximate amplitude of 6 mm (-27 to -21)
573	Shift - approximate amplitude of 7 mm (-24 to -17)
923	Fidget - approximate amplitude of 12 mm (-18 to -30)
	Shift - approximate amplitude of 6 mm (-24 to -18)
	small fidget-like migration at beginning of shift
973	Shift - approximate amplitude of 5 mm (-17 to -22)
1137	Shift - approximate amplitude of 7 mm (-18 to -25)
1142	Shift - approximate amplitude of 5 mm (-24 to -19)
1166	Shift - approximate amplitude of 8 mm (-21 to -13)
1172	Shift - approximate amplitude of 7 mm (-14 to -21)
1450	Shift - approximate amplitude of 7 mm (-23 to -16)
1650	Fidget - approximate amplitude of 10 mm (-21 to -11)
1752	Shift - approximate amplitude of 8 mm (-18 to -26)
4th order begins - 350	
353	Shift - approximate amplitude of 6 mm (-21 to -27)
790	Shift - approximate amplitude of 5 mm (-23 to -28)
	Fidget - approximate amplitude of 10 mm (-23 to -13)
	may not be a fidget, dependant on starting point
1078	Shift - approximate amplitude of 6 mm (-29 to -23)
	has fidget-like overshoot
1416	Shift - approximate amplitude of 11 mm (-20 to -31)
1420	Shift - approximate amplitude of 11 mm (-31 to -20)
1548	Shift - approximate amplitude of 12 mm (-23 to -11)
1552	Shift - approximate amplitude of 13 mm (-23 to -10)
1719	Shift - approximate amplitude of 6 mm (-18 to -24)
1722	Shift - approximate amplitude of 7 mm (-25 to -18)

Subject 11

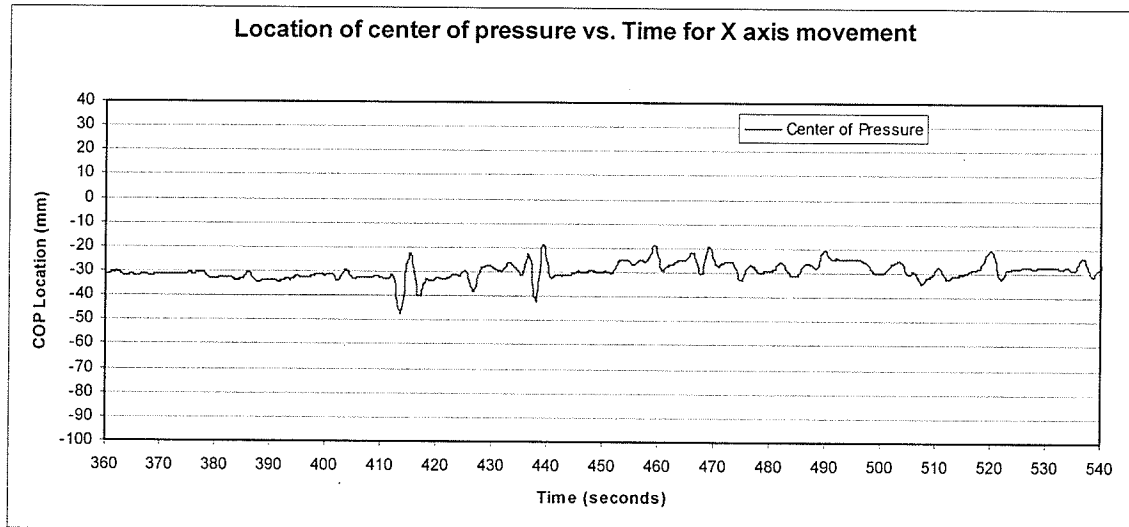
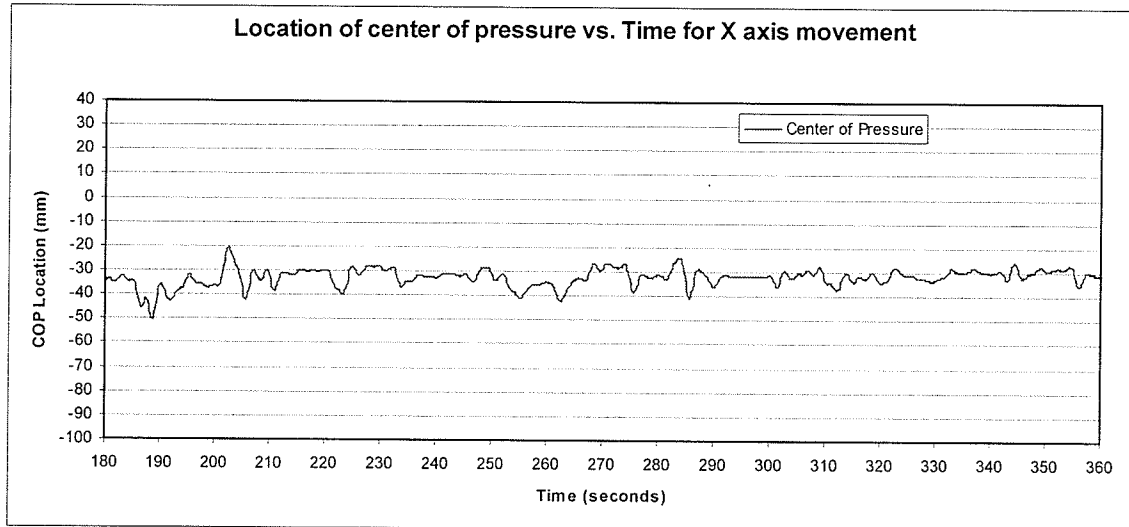
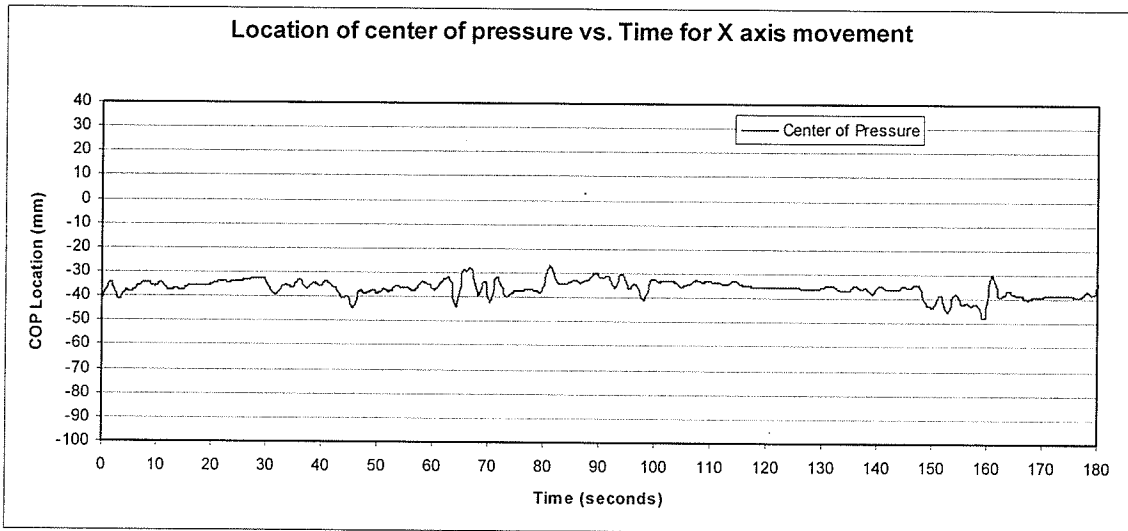

Location of center of pressure vs. Time for X axis movement

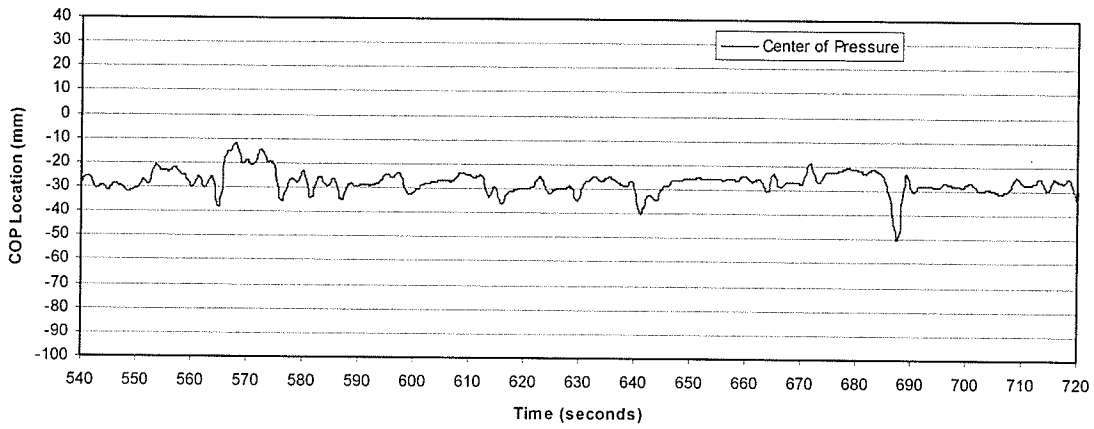

Location of center of pressure vs. Time for X axis movement

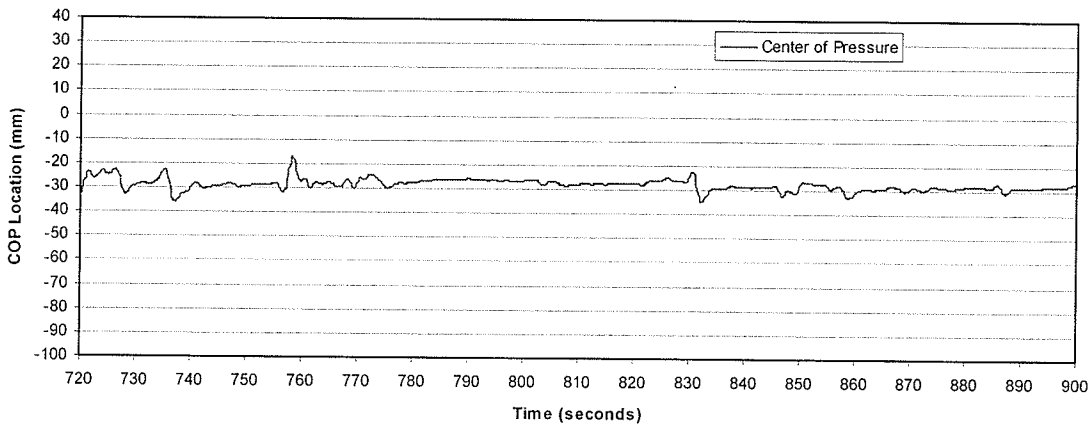

Location of center of pressure vs. Time for X axis movement

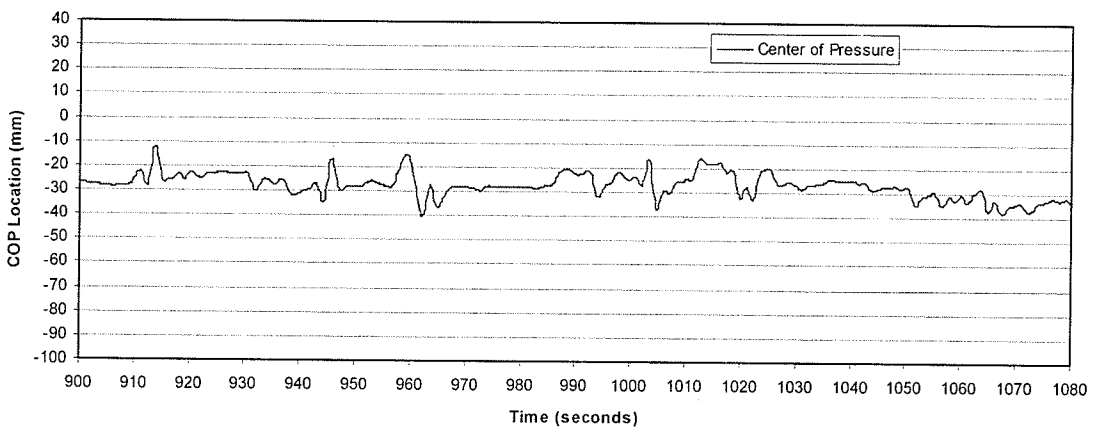

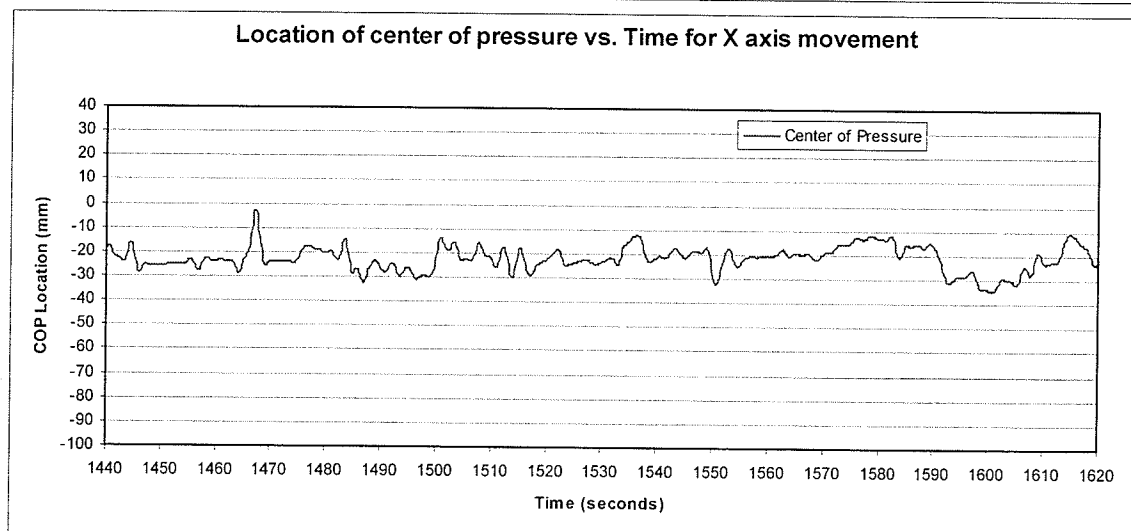
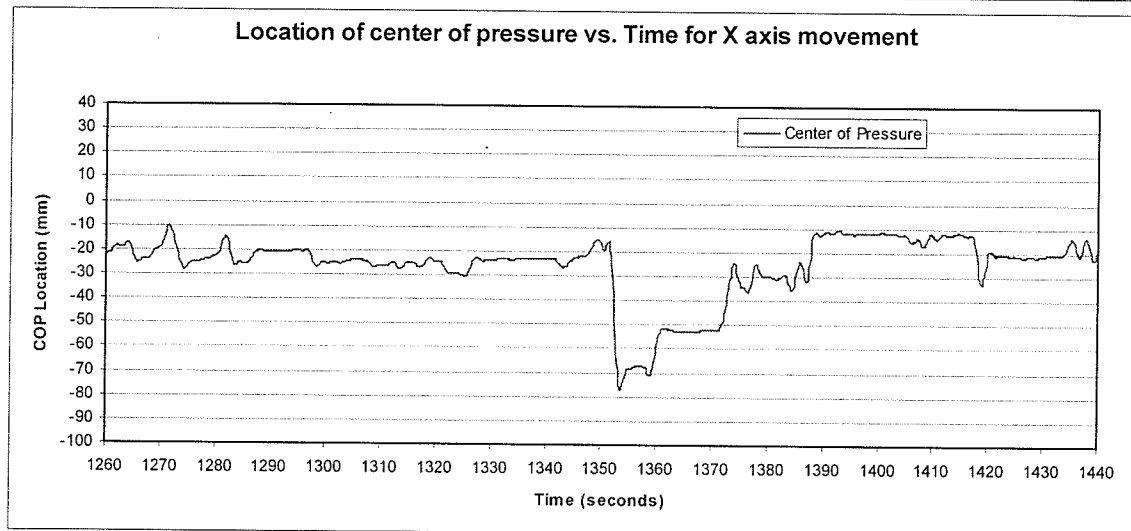
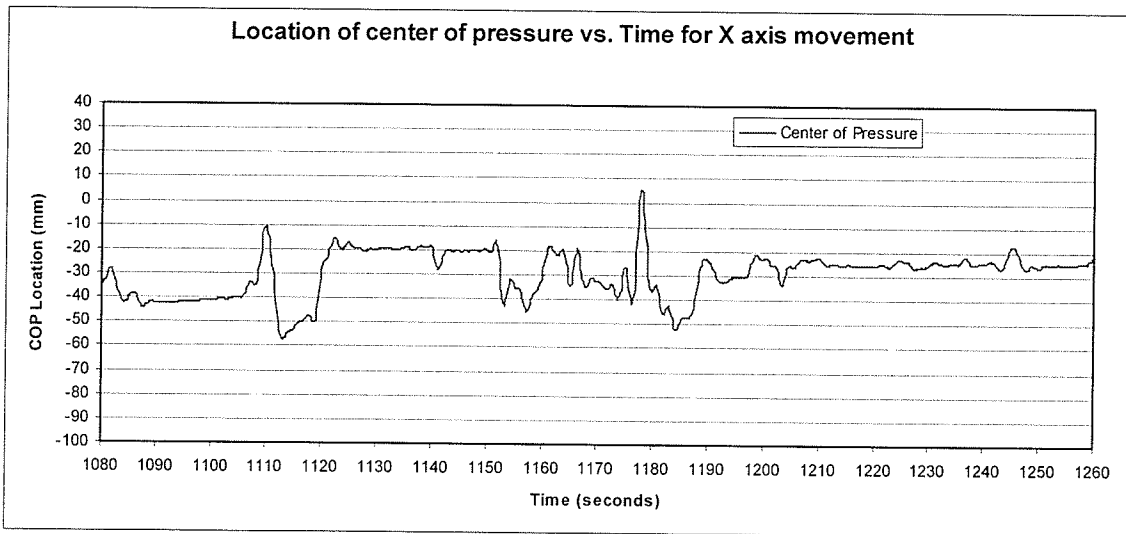

Location of center of pressure vs. Time for X axis movement

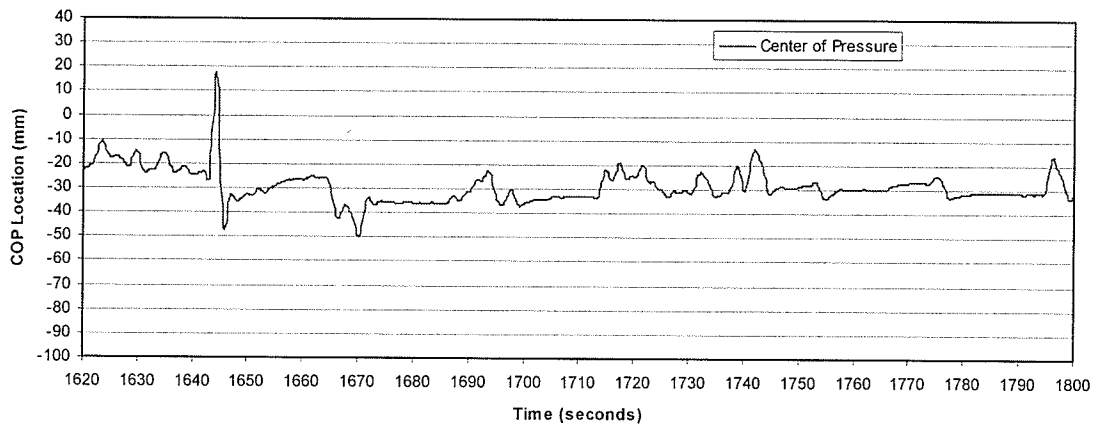

Location of center of pressure vs. Time for Y axis movement

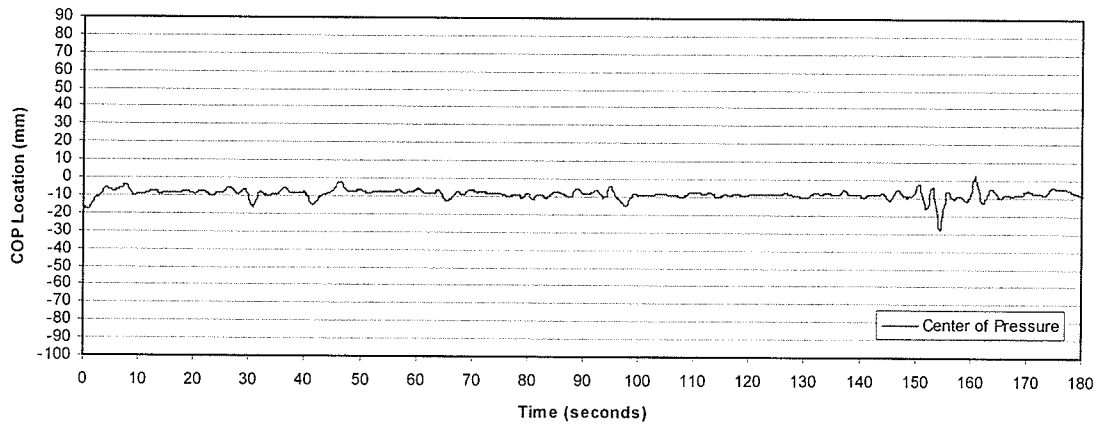

Location of center of pressure vs. Time for Y axis movement

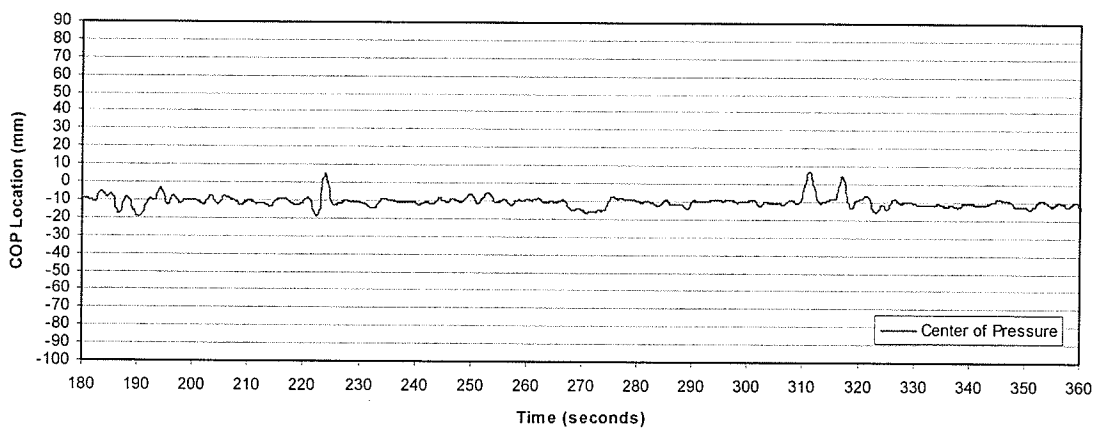

Location of center of pressure vs. Time for Y axis movement

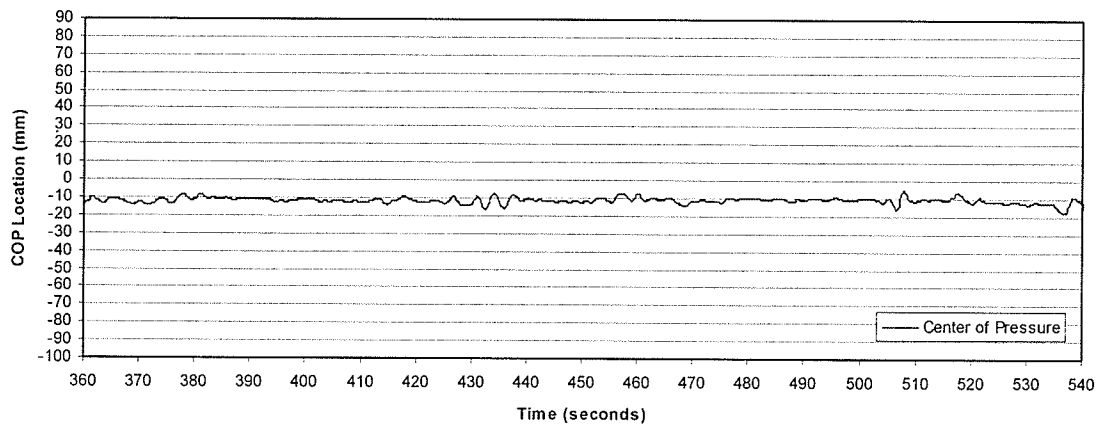

Location of center of pressure vs. Time for Y axis movement

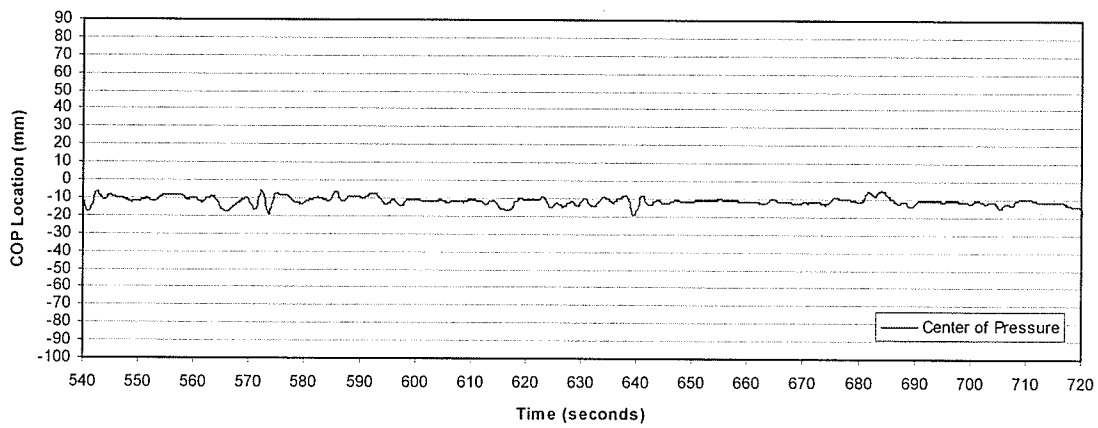

Location of center of pressure vs. Time for Y axis movement

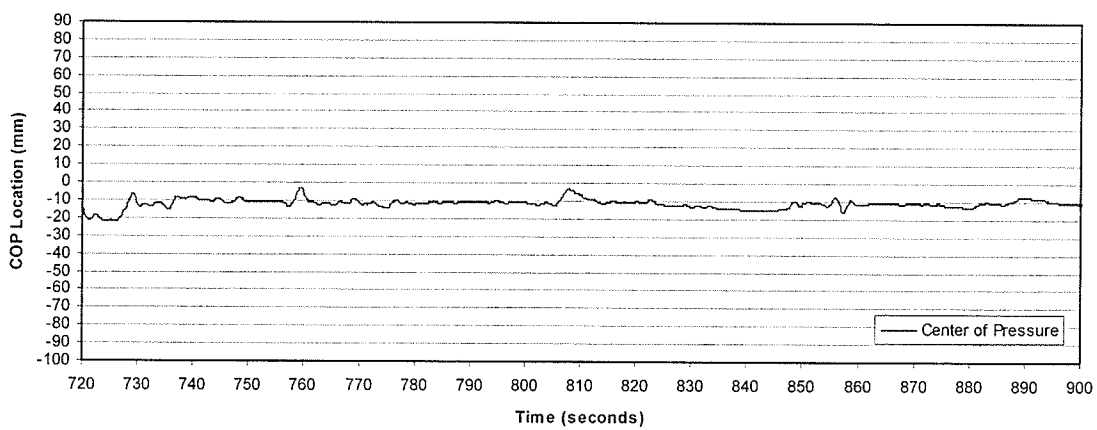

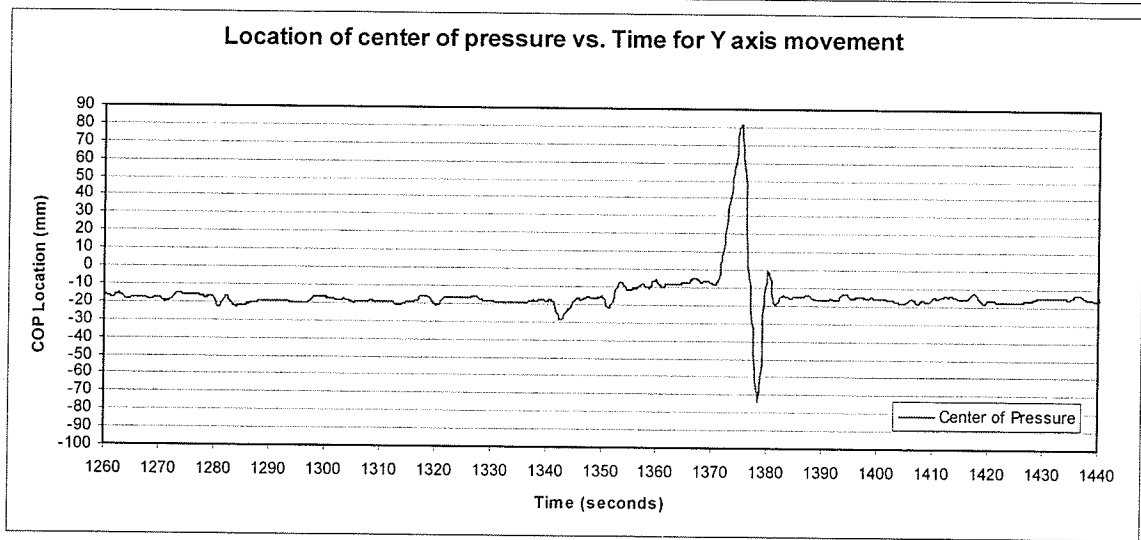
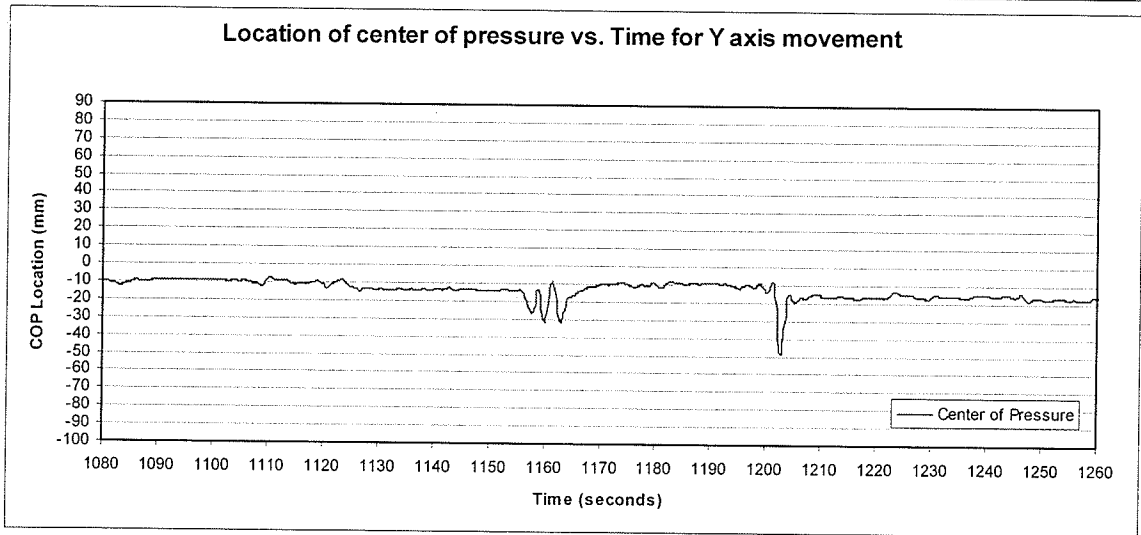
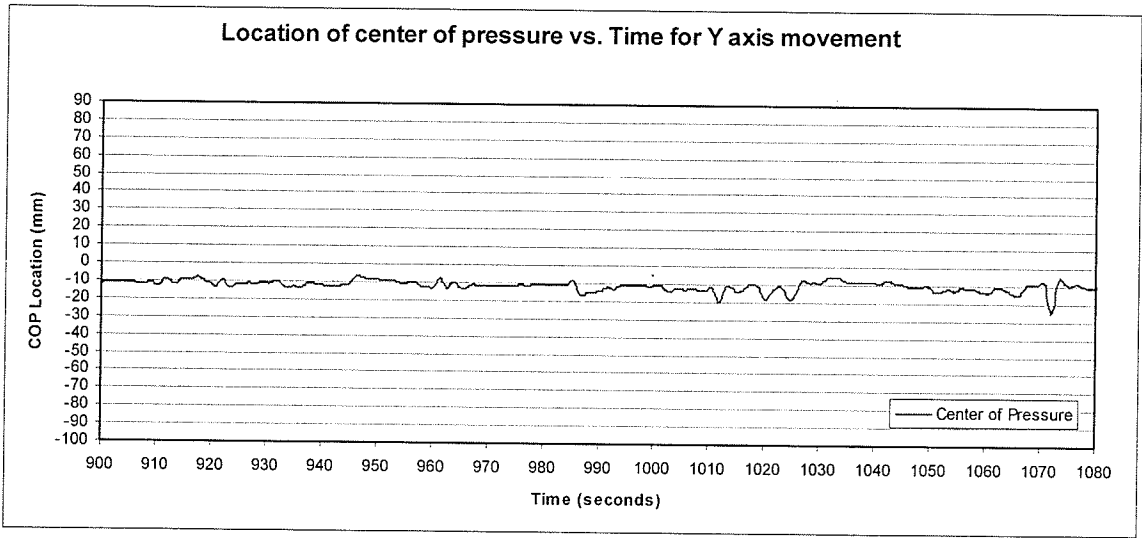

Location of center of pressure vs. Time for Y axis movement

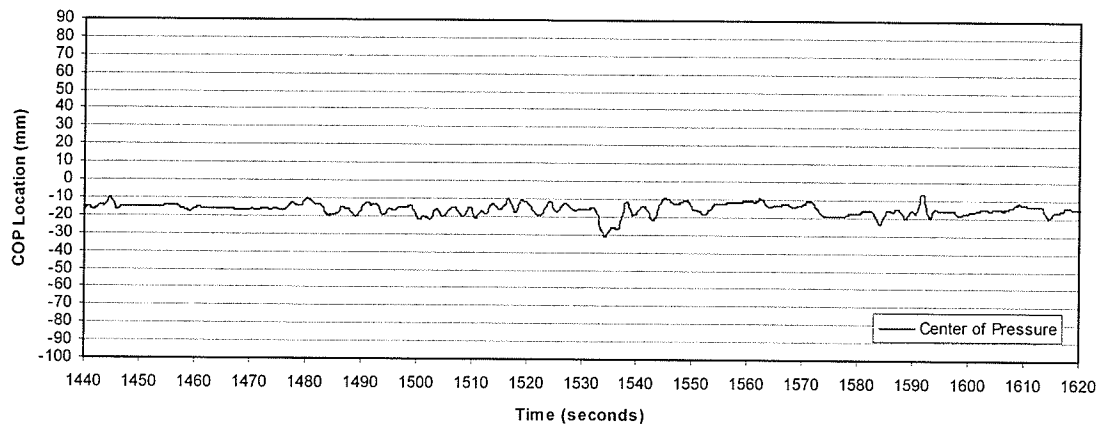

Location of center of pressure vs. Time for Y axis movement

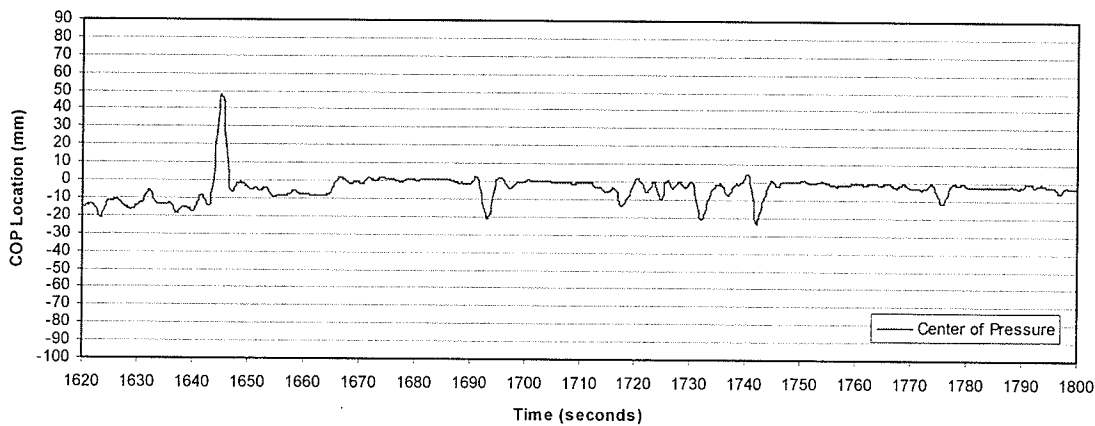

Subject - 11X	Manual Pattern Identification Chart
Approximate Time (seconds)	Pattern Description
1st order begins - 1117	
	Shift - approximate amplitude of 30 mm (-50 to -20)
1175	Fidget - approximate amplitude of 45 mm (-40 to 5)
1186	Shift - approximate amplitude of 26 mm (-48 to -22) shift amplitude may be less
1350	Shift - approximate amplitude of 50 mm (-20 to -70)
1371	Shift - approximate amplitude of 22 mm (-52 to -30)
1641	Fidget - approximate amplitude of 45 mm (-27 to 18) part of a shift
2nd order begins - 683	
	Fidget - approximate amplitude of 27 mm (-23 to -50)
912	Fidget - approximate amplitude of 18 mm (-29 to -11)
1026 to 1067	Drift - approximate amplitude of 11 mm (-28 to -39)
1358	Shift - approximate amplitude of 19 mm (-70 to -51)
1387	Shift - approximate amplitude of 20 mm (-31 to -11)
1463	Fidget - approximate amplitude of 25 mm (-28 to -3)
1499	Shift - approximate amplitude of 12 mm (-30 to -18)
1588	Shift - approximate amplitude of 15 mm (-16 to -31)
3rd order begins - 62	
	Fidget - approximate amplitude of 12 mm (-32 to -44)
147	Shift - approximate amplitude of 8 mm (-34 to -42)
451	Shift - approximate amplitude of 5 mm (-30 to -25)
597	Shift - approximate amplitude of 9 mm (-23 to -32)
726	Shift - approximate amplitude of 9 mm (-23 to -32)
757	Fidget - approximate amplitude of 10 mm (-28 to -18)
945	Fidget - approximate amplitude of 12 mm (-30 to -18)
1001	Fidget - approximate amplitude of 10 mm (-28 to -18)
1173	Fidget - approximate amplitude of 12 mm (-40 to -28)
1285	Shift - approximate amplitude of 6 mm (-26 to -20)
1296	Shift - approximate amplitude of 7 mm (-20 to -27)
1325	Shift - approximate amplitude of 7 mm (-30 to -23)
1513	Fidget - approximate amplitude of 12 mm (-30 to -18)
1548	Fidget - approximate amplitude of 13 mm (-19 to -32)
1712	Shift - approximate amplitude of 5 mm (-32 to -27)
1737	Fidget - approximate amplitude of 11 mm (-31 to -20)
1775	Shift - approximate amplitude of 7 mm (-26 to -33)
4th order begins - 160	
	Fidget - approximate amplitude of 10 mm (-40 to -30) part of a small shift which does not meet pattern parameters
232	Shift - approximate amplitude of 8 mm (-29 to -37)
284	Fidget - approximate amplitude of 11 mm (-30 to -41)
411	Fidget - approximate amplitude of 17 mm (-31 to -48)
565	Shift - approximate amplitude of 10 mm (-26 to -16) downward fidget-like migration at beginning of shift

Approximate Time (seconds)	Pattern Description
1103	2 patterns - Shift - approximate amplitude of 18 mm (-40 to -58) fidget occurs at beginning of shift - approximate amplitude of 29 mm (-40 to -11)
1164	Fidget - approximate amplitude of 15 mm (-35 to -20)
1416	2 patterns - Shift - approximate amplitude of 8 mm (-12 to -20) undershoot before COP settles, fidget with approximate amplitude of 12 mm (-20 to -32)
1642	Shift - approximate amplitude of 6 mm (-27 to -33) a large fidget is part of the shift, noted in 1st order
1794	Fidget - approximate amplitude of 14 mm (-31 to -17) base may be too wide for a fidget
Subject - 11Y	Manual Pattern Identification Chart
Approximate Time (seconds)	Pattern Description
1st order begins - 1201	Fidget - approximate amplitude of 35 mm (-15 to -50) shift is noted in 4th order patterns
1371	Fidget - approximate amplitude of 90 mm (-9 to 81) width at base may be an issue
1376	Fidget - approximate amplitude of 65 mm (-10 to -75)
1643	Fidget - approximate amplitude of 58 mm (-10 to 48)
2nd order begins - 152	Fidget - approximate amplitude of 25 mm (-3 to -28)
223	Fidget - approximate amplitude of 18 mm (-13 to 5)
310	Fidget - approximate amplitude of 17 mm (-10 to 7)
1070	Fidget - approximate amplitude of 17 mm (-8 to -25)
1532	Shift - approximate amplitude of 14 mm (-16 to -30)
1664	Shift - approximate amplitude of 10 mm (-9 to 1)
1691	Fidget - approximate amplitude of 21 mm (1 to -20)
1730	Fidget - approximate amplitude of 20 mm (0 to -20) trailing edge kind of slants away
1741	Fidget - approximate amplitude of 22 mm (0 to -22)
3rd order begins - 159	Fidget - approximate amplitude of 12 mm (-11 to 1)
266	Shift - approximate amplitude of 5 mm (-10 to -15)
273	Shift - approximate amplitude of 5 mm (-15 to -10)
316	Fidget - approximate amplitude of 13 mm (-9 to 4)
639	Fidget - approximate amplitude of 11 mm (-9 to -20)
726	Shift - approximate amplitude of 8 mm (-21 to -13)
985	Shift - approximate amplitude of 8 mm (-10 to -18)
1590	Fidget - approximate amplitude of 11 mm (-18 to -7)
4th order begins - 1158	Fidget - approximate amplitude of 18 mm (-13 to -31)
1161	Fidget - approximate amplitude of 21 mm (-10 to -31) trailing edge may fade too much, making base too wide
1201	Shift - approximate amplitude of 7 mm (-10 to -17) fidget noted in 1st order patterns
1722	Fidget - approximate amplitude of 10 mm (0 to -10)

Subject 12

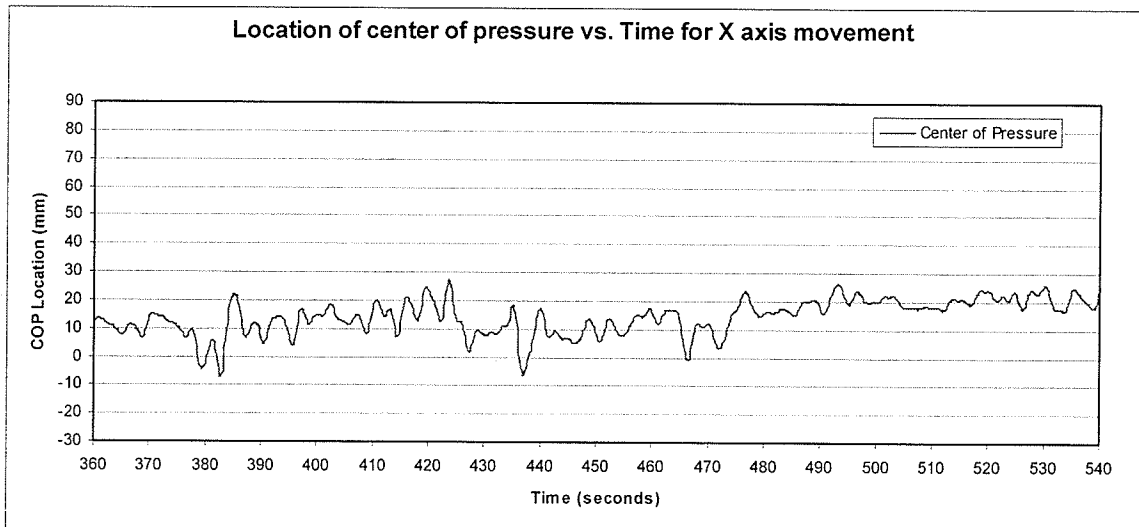
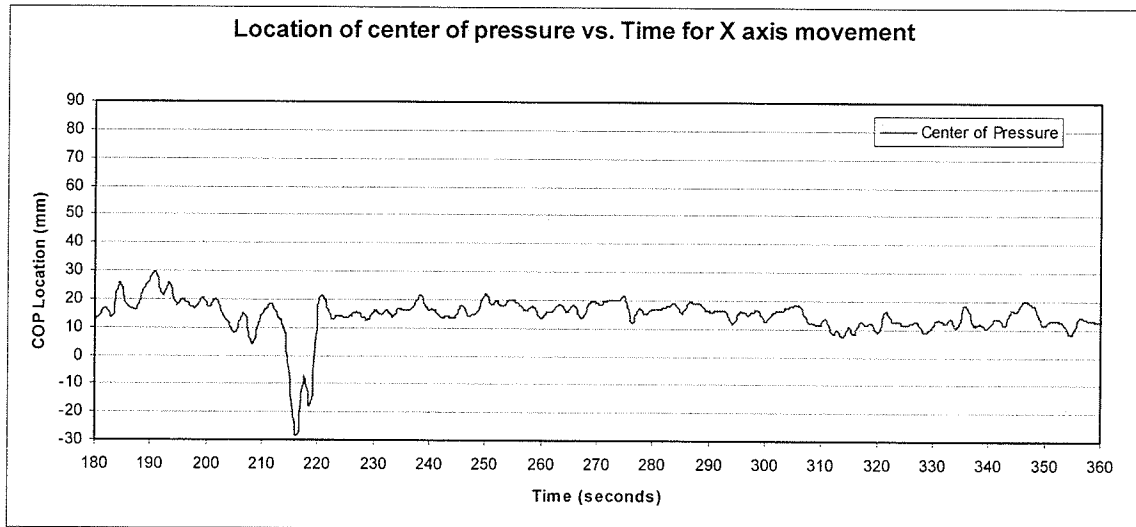
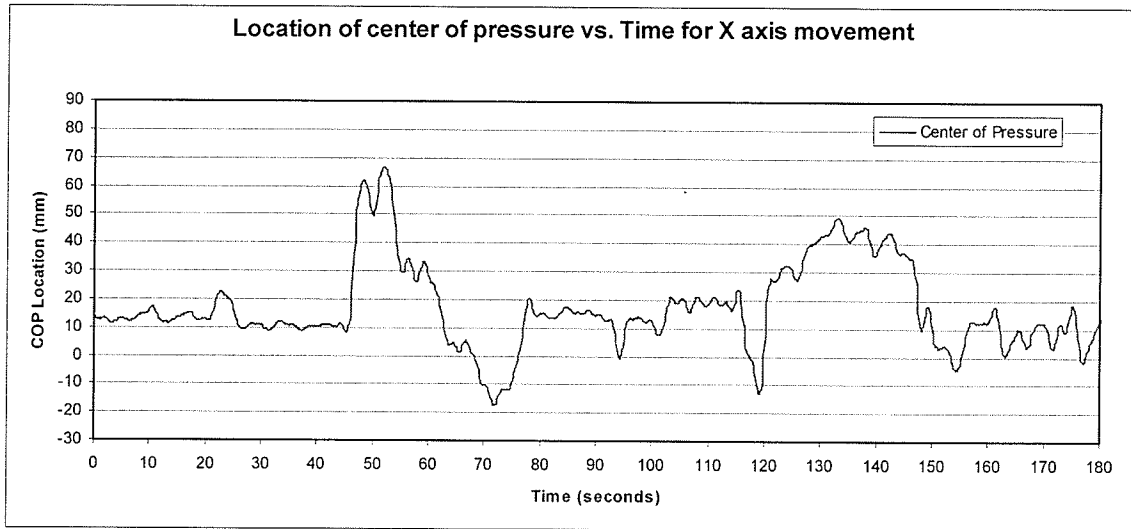

Location of center of pressure vs. Time for X axis movement

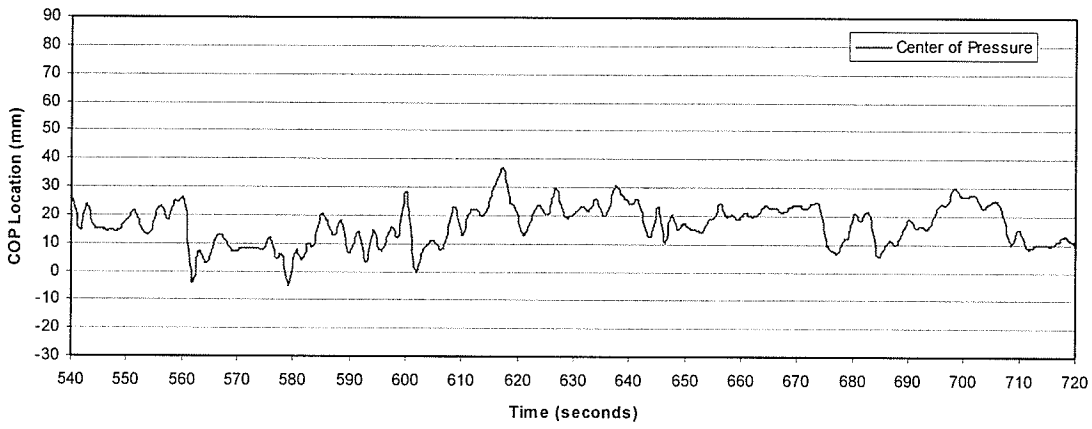

Location of center of pressure vs. Time for X axis movement

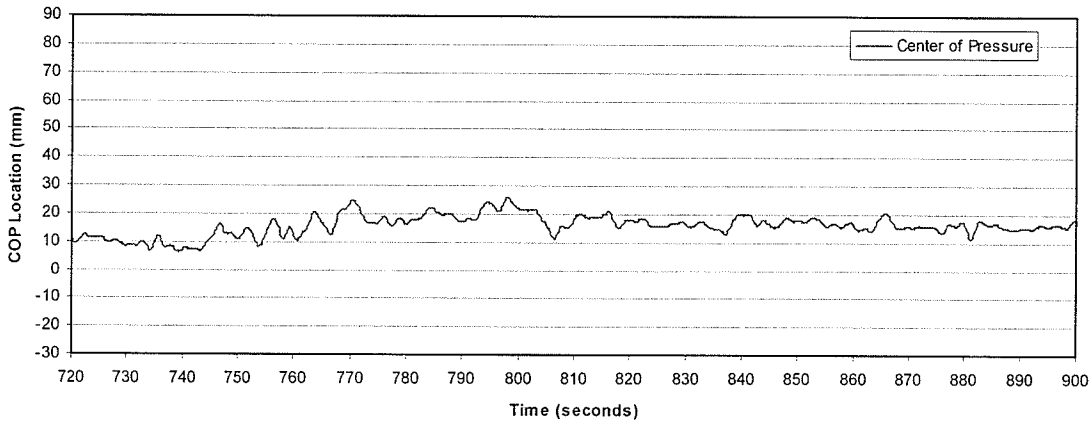

Location of center of pressure vs. Time for X axis movement

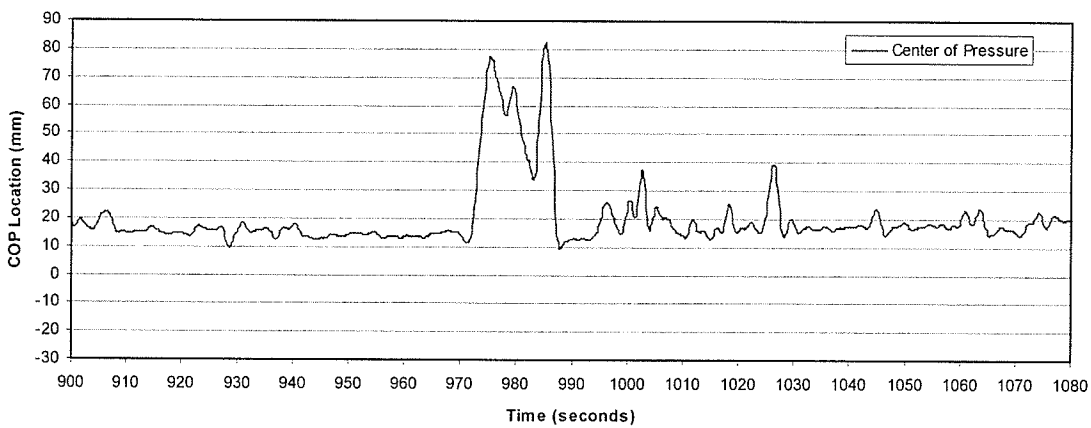

Location of center of pressure vs. Time for X axis movement

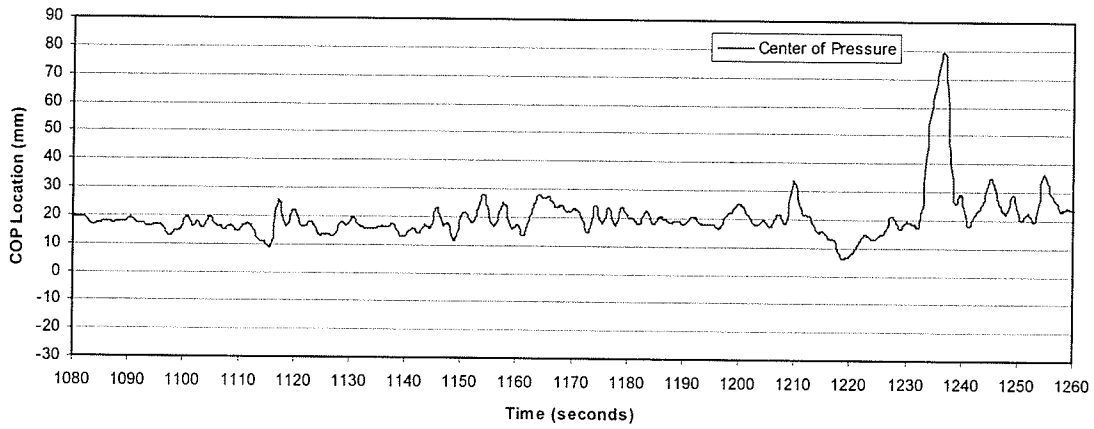

Location of center of pressure vs. Time for X axis movement

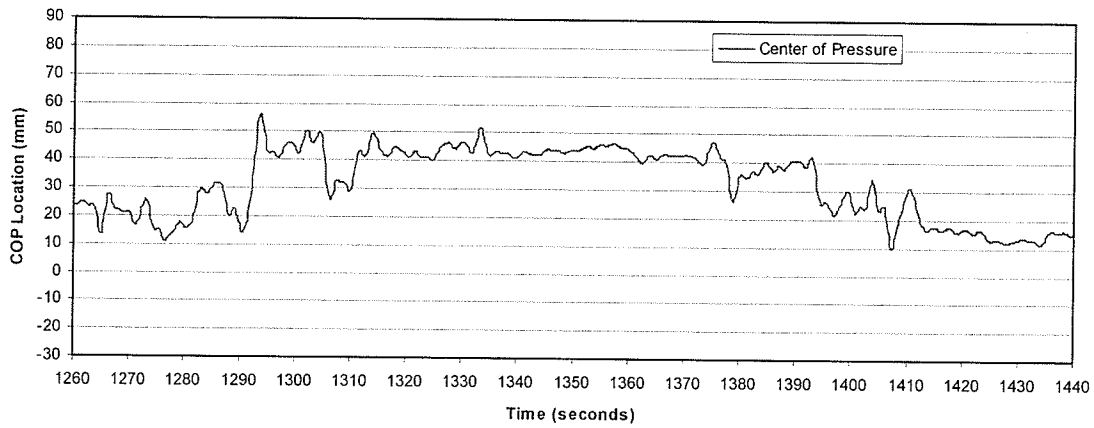

Location of center of pressure vs. Time for X axis movement

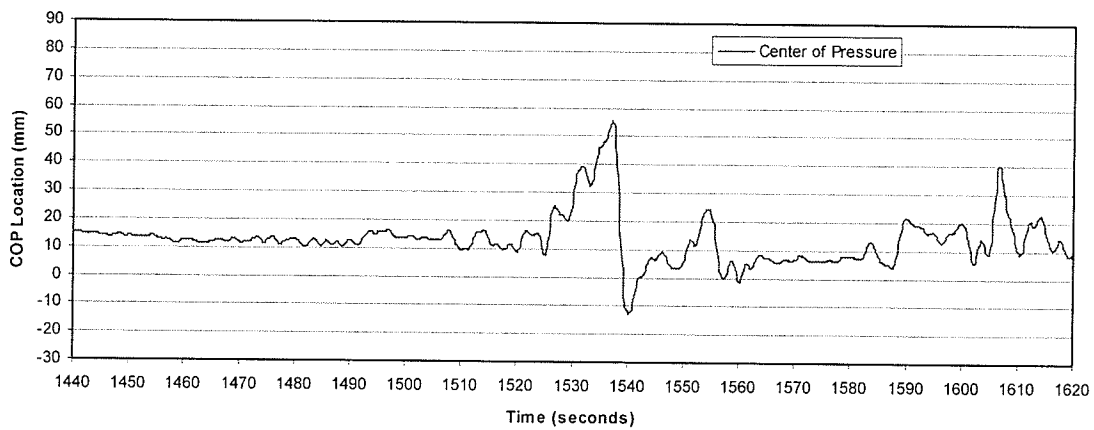

Location of center of pressure vs. Time for X axis movement

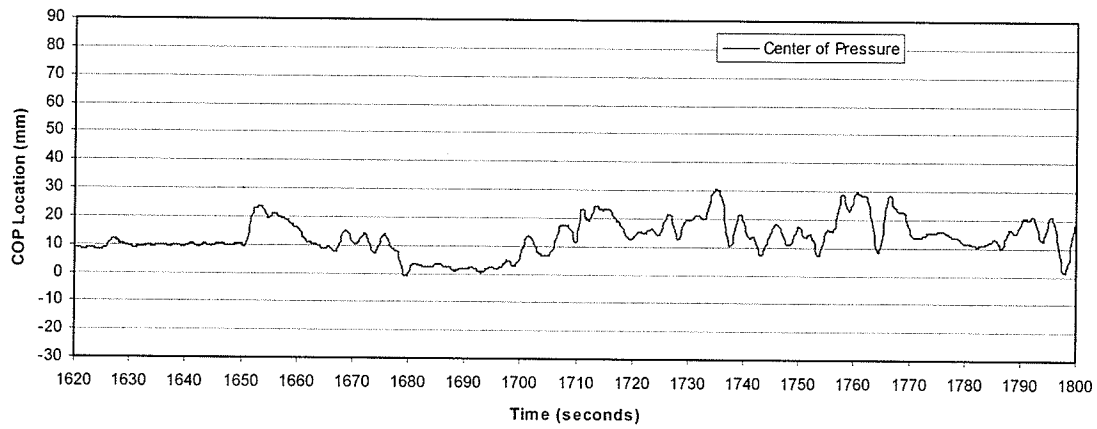

Location of center of pressure vs. Time for Y axis movement

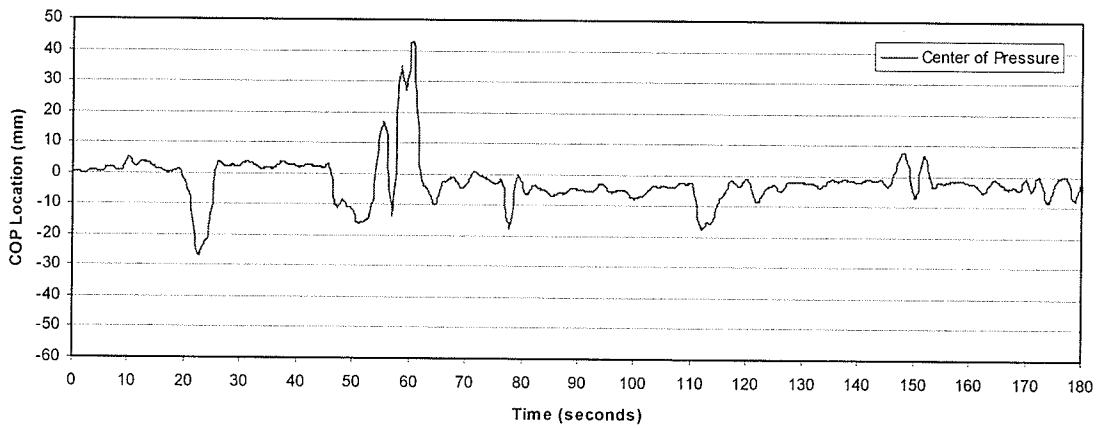

Location of center of pressure vs. Time for Y axis movement

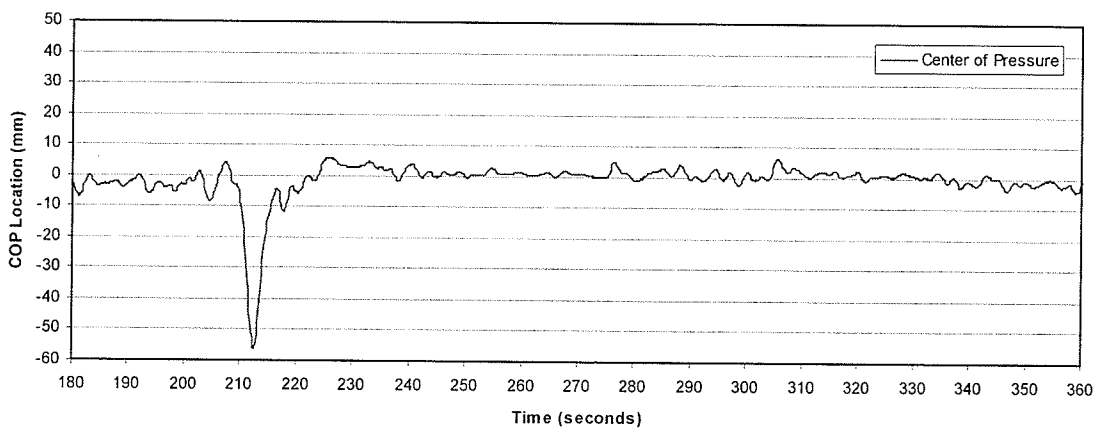

Location of center of pressure vs. Time for Y axis movement

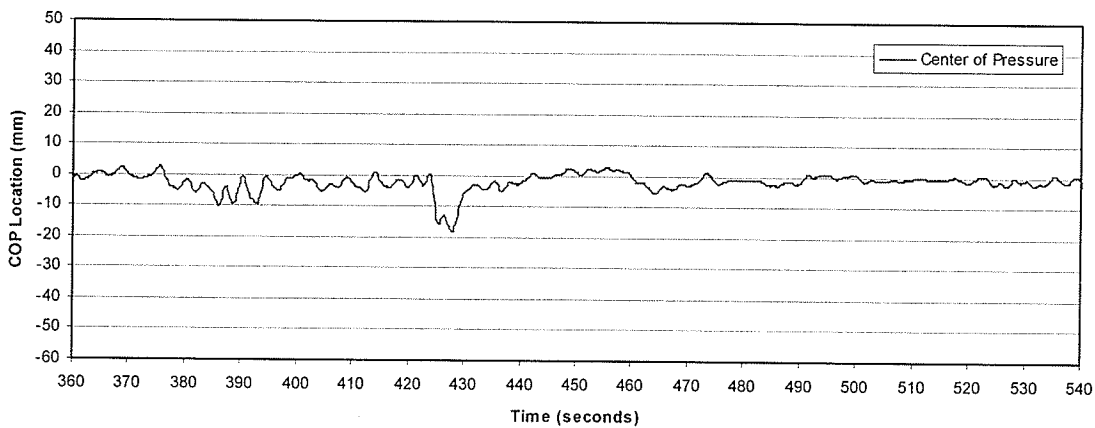

Location of center of pressure vs. Time for Y axis movement

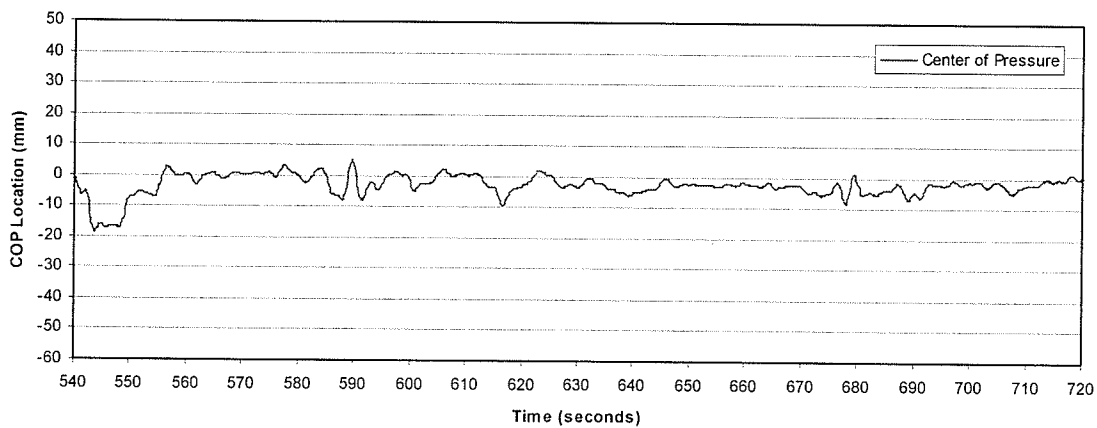

Location of center of pressure vs. Time for Y axis movement

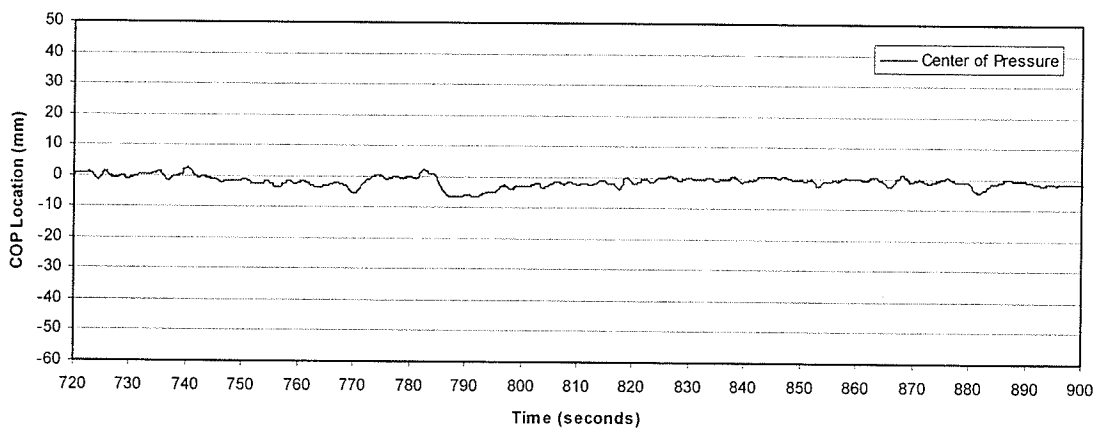

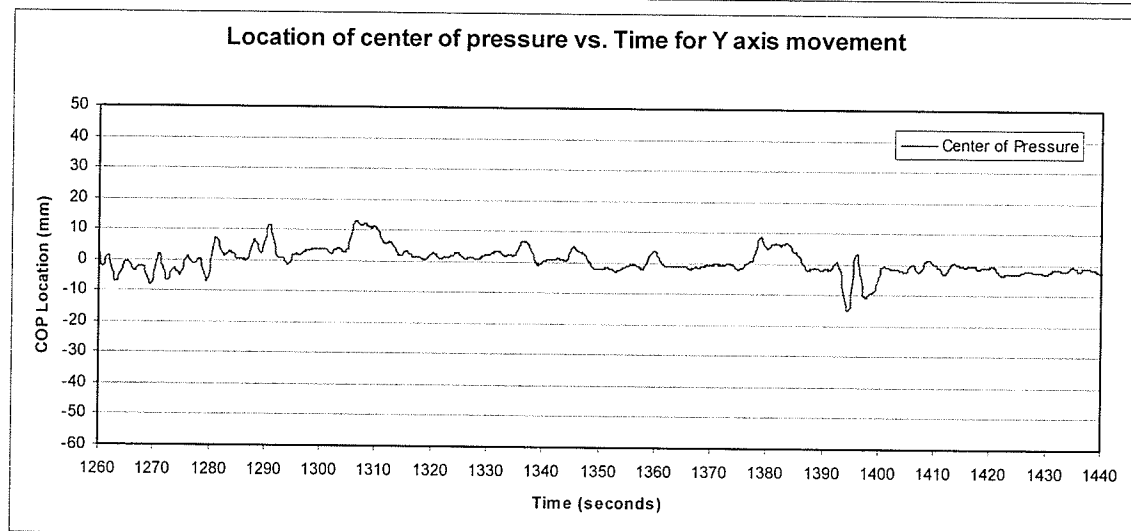
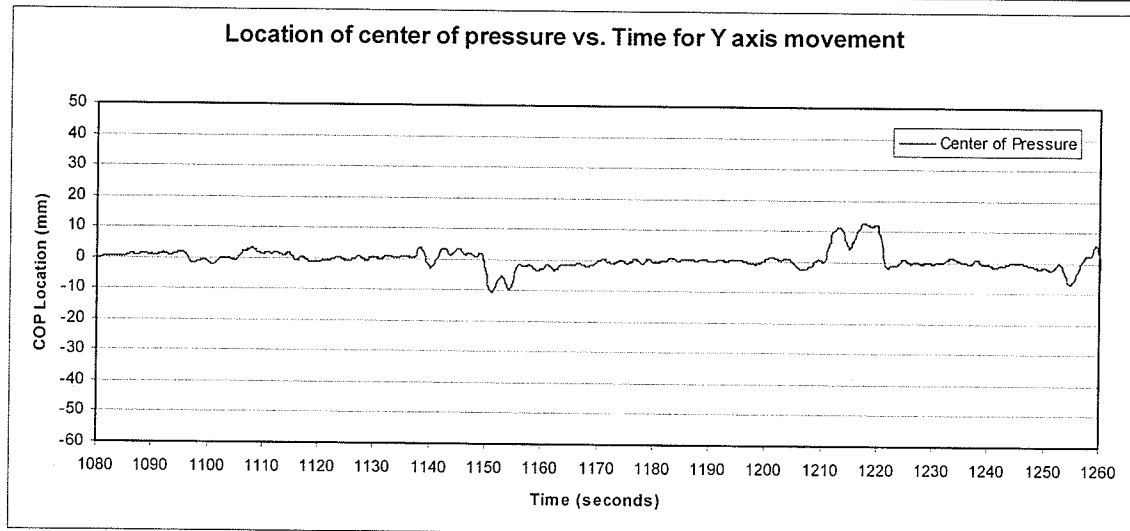
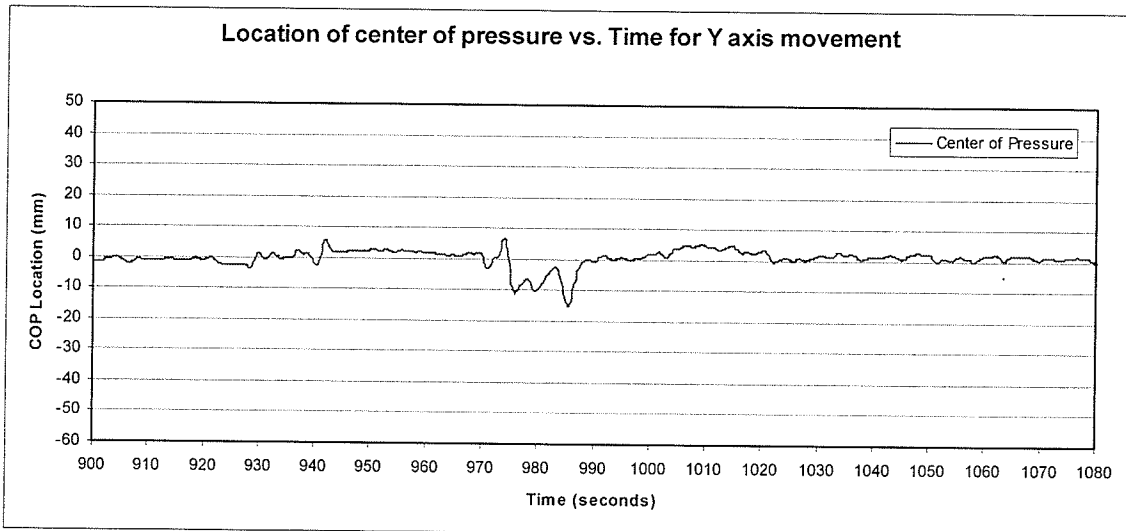

Location of center of pressure vs. Time for Y axis movement

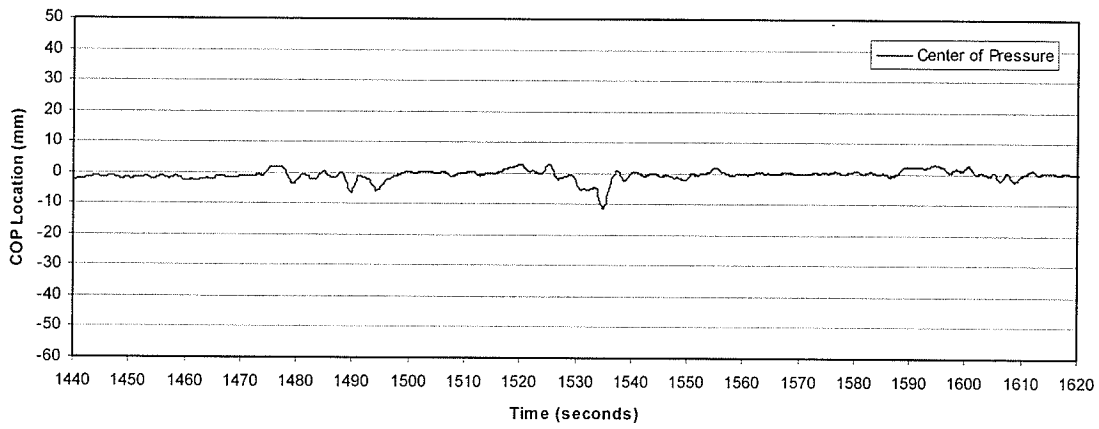

Location of center of pressure vs. Time for Y axis movement

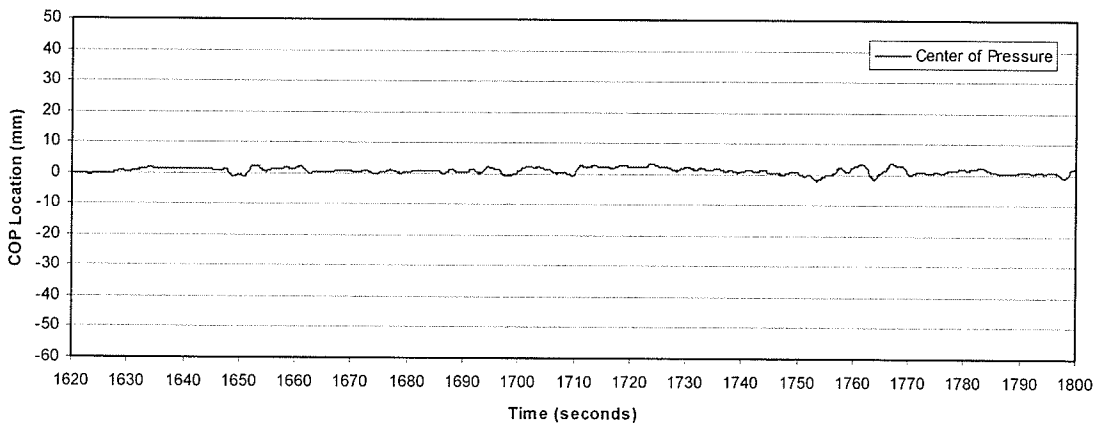

Subject - 12X	Manual Pattern Identification Chart
Approximate Time (seconds)	Pattern Description
1st order begins - 434	Fidget - approximate amplitude of 26 mm (19 to -7)
559	Shift - approximate amplitude of 19 mm (26 to 7) undershoot included
1023	Fidget - approximate amplitude of 25 mm (15 to 40)
1304	Shift - approximate amplitude of 18 mm (50 to 32)
1310	Shift - approximate amplitude of 13 mm (29 to 42) looking at non-filtered data, the previous 2 patterns may not exist
1392	Shift - approximate amplitude of 17 mm (42 to 25)
1587	Shift - approximate amplitude of 17 mm (4 to 21)
1651	Shift - approximate amplitude of 13 mm (10 to 23)
1762	Fidget - approximate amplitude of 20 mm (29 to 9)
1795	Fidget - approximate amplitude of 20 mm (21 to 1)
2nd order begins - 93	Fidget - approximate amplitude of 14 mm (13 to -1)
101	Shift - approximate amplitude of 9 mm (10 to 19)
577	Fidget - approximate amplitude of 12 mm (7 to -5)
1017	Fidget - approximate amplitude of 10 mm (26 to 16)
1151	Fidget - approximate amplitude of 10 mm (18 to 28)
1209	Fidget - approximate amplitude of 12 mm (21 to 33)
1403	Fidget - approximate amplitude of 11 mm (23 to 34)
3rd order begins - 146	Shift - approximate amplitude of 25 mm (35 to 10) COP after shift may not be consistent enough for this to qualify
1232	Fidget - approximate amplitude of 61 mm (19 to 80) width may cause problems in program identification
1290	Shift - approximate amplitude of 29 mm (13 to 42) overshoot of COP before settling
1536	Shift - approximate amplitude of 56 mm (56 to 0)
1605	Fidget - approximate amplitude of 31 mm (9 to 40) width may be an issue
4th order begins - 45	Shift - approximate amplitude of 52 mm (10 to 62)
53	Shift - approximate amplitude of 32 mm (62 to 30) while the previous two patterns are large, there may not be sufficient stability in the COP to call them shifts
115	Fidget - approximate amplitude of 36 mm (23 to -13) base may be too wide to be classified a fidget
211	Fidget - approximate amplitude of 48 mm (19 to -29) double-peaked fidget, wide base may prevent fidget classification
591	Fidget - approximate amplitude of 11 mm (14 to 3)
673	Shift - approximate amplitude of 17 mm (25 to 8)
678	Shift - approximate amplitude of 8 mm (12 to 20)
682	Shift - approximate amplitude of 17 mm (22 to 5)
706	Shift - approximate amplitude of 15 mm (25 to 10)

Approximate Time (seconds)	Pattern Description
971 to 987	Shift - approximate amplitude of 67 mm (11 to 78) see graph, may be either shift and/or fidget
1405	Fidget - approximate amplitude of 15 mm (25 to 10)
Subject - 12Y	Manual Pattern Identification Chart
Approximate Time (seconds)	Pattern Description
1st order begins - 209	Fidget - approximate amplitude of 54 mm (-3 to -57) base may be too wide
2nd order begins - 18	Fidget - approximate amplitude of 29 mm (1 to -28) base may be too wide
45	Shift - approximate amplitude of 12 mm (2 to -10)
53	Fidget - approximate amplitude of 30 mm (-13 to 17)
76	Fidget - approximate amplitude of 18 mm (-1 to -19)
423	Shift - approximate amplitude of 16 mm (0 to -16)
542	Shift - approximate amplitude of 14 mm (-5 to -19)
548	Shift - approximate amplitude of 10 mm (-18 to -8)
786 to 826	Drift - approximate amplitude of 7 mm (-7 to 0)
1149	Shift - approximate amplitude of 11 mm (1 to -10)
1211	Shift - approximate amplitude of 10 mm (0 to 10)
1220	Shift - approximate amplitude of 12 mm (1 to -11)
1303	Shift - approximate amplitude of 10 mm (2 to 12)
1392	Fidget - approximate amplitude of 15 mm (0 to -15)
3rd order begins - 587	Fidget - approximate amplitude of 14 mm (-8 to 6)
785	Shift - approximate amplitude of 8 mm (1 to -7)
982	Fidget - approximate amplitude of 14 mm (-2 to -16)
4th order begins - 55	Fidget - approximate amplitude of 53 mm (-10 to 43) double-peaked, base may be too wide
428	Shift - approximate amplitude of 13 mm (-19 to -6)

Subject 13

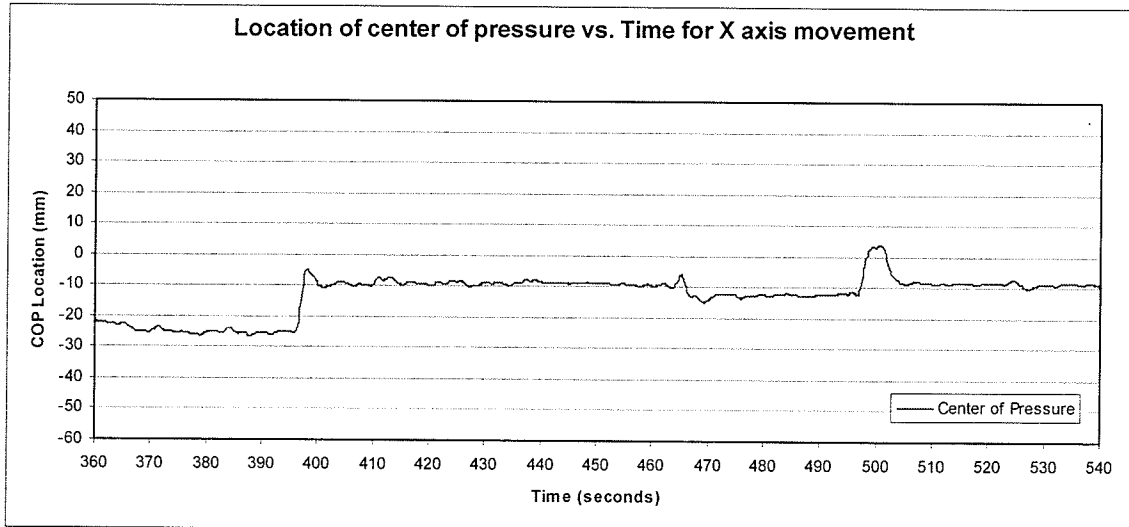
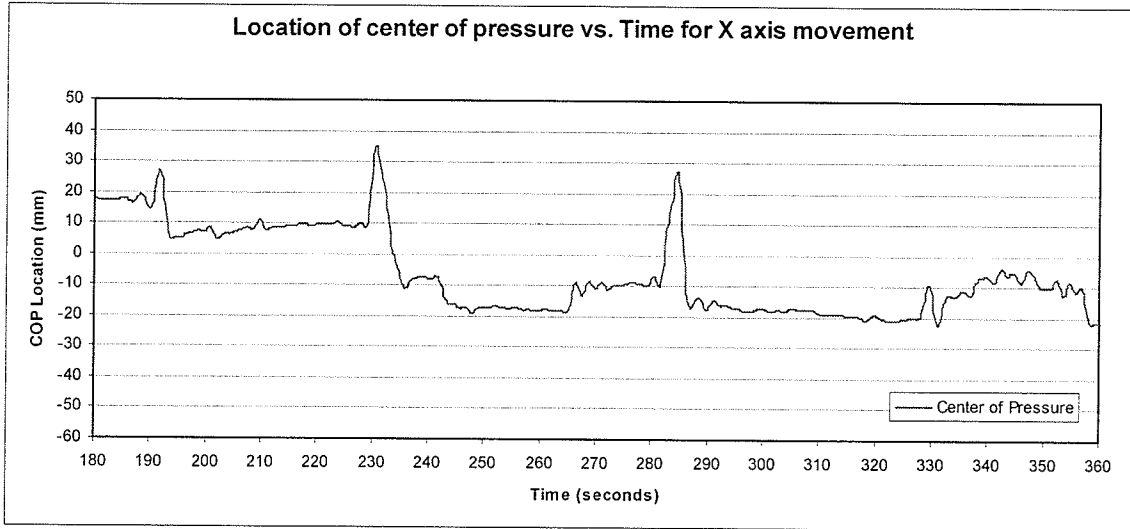
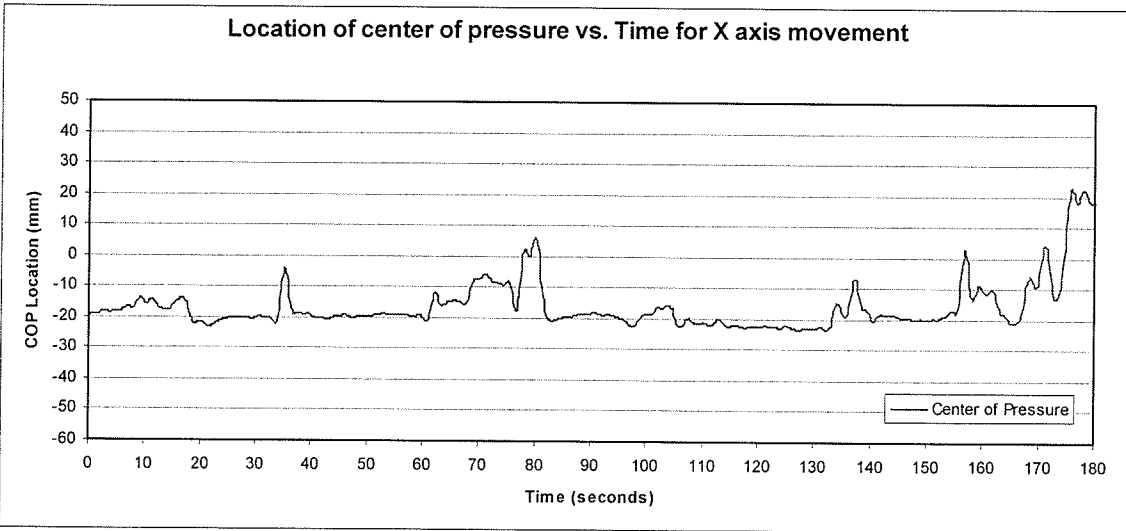

Location of center of pressure vs. Time for X axis movement

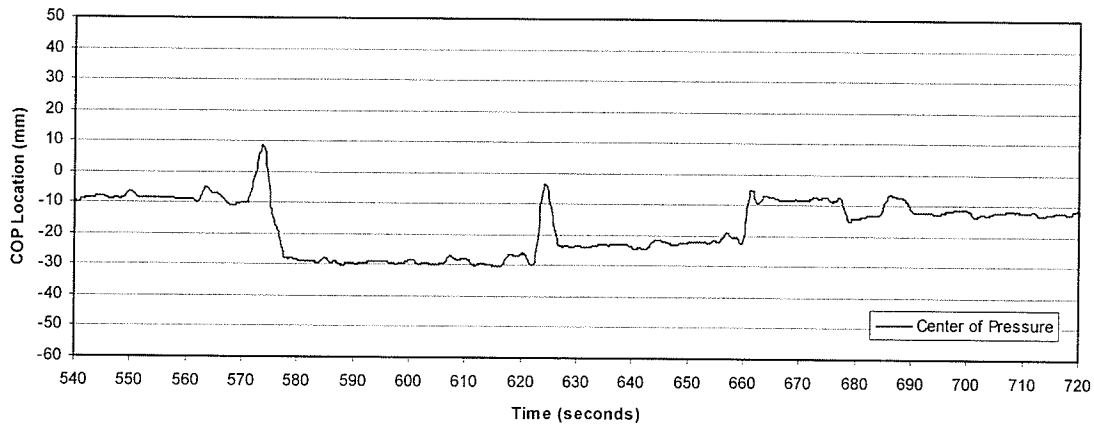

Location of center of pressure vs. Time for X axis movement

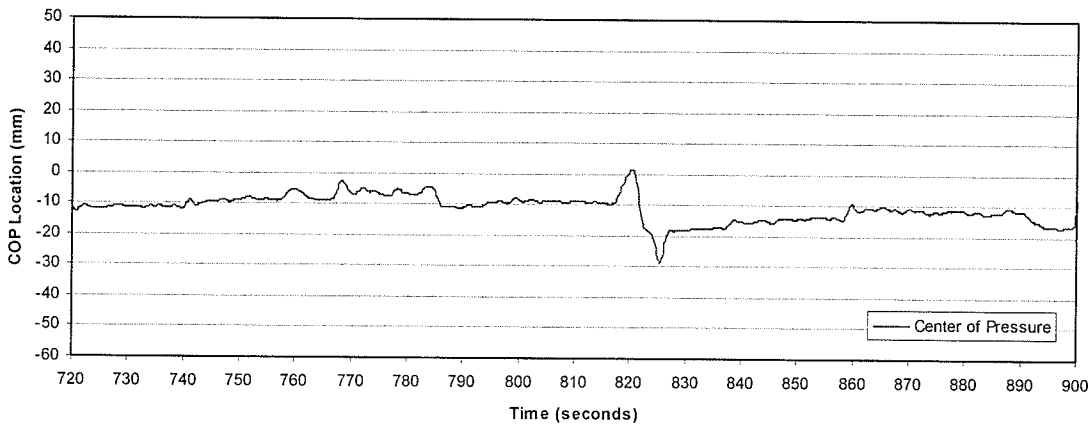

Location of center of pressure vs. Time for X axis movement

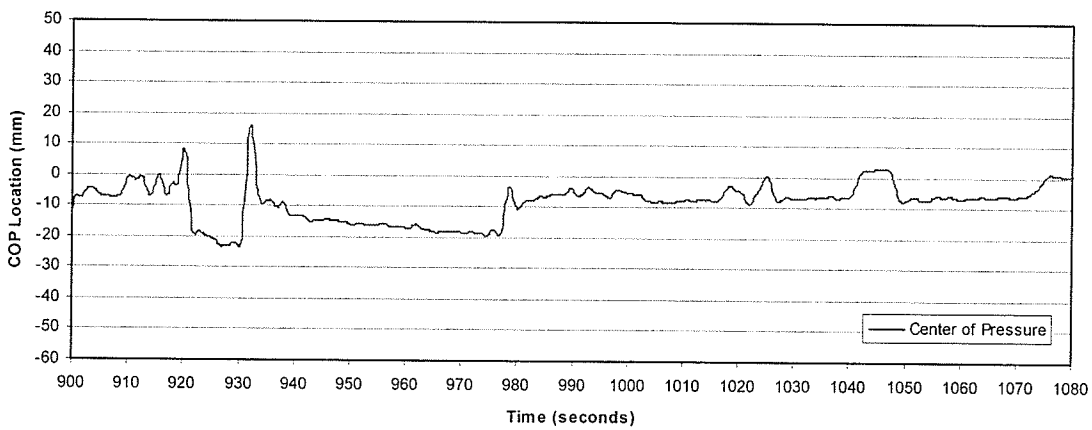

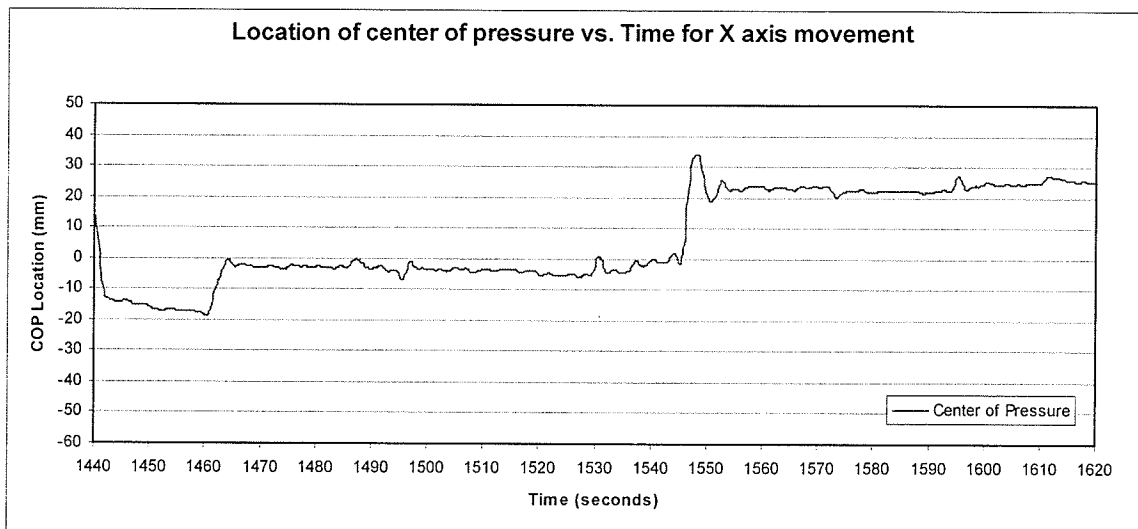
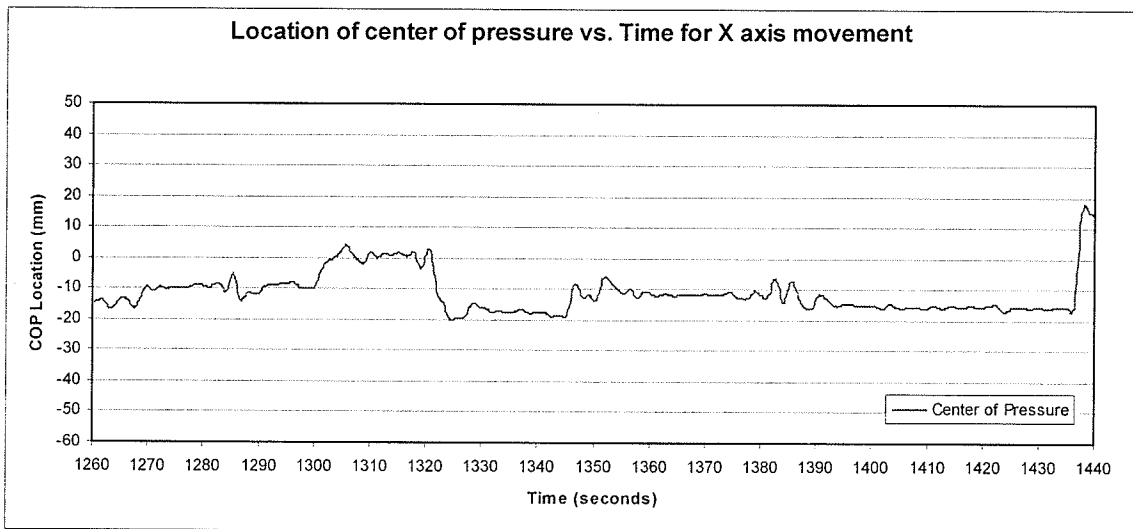
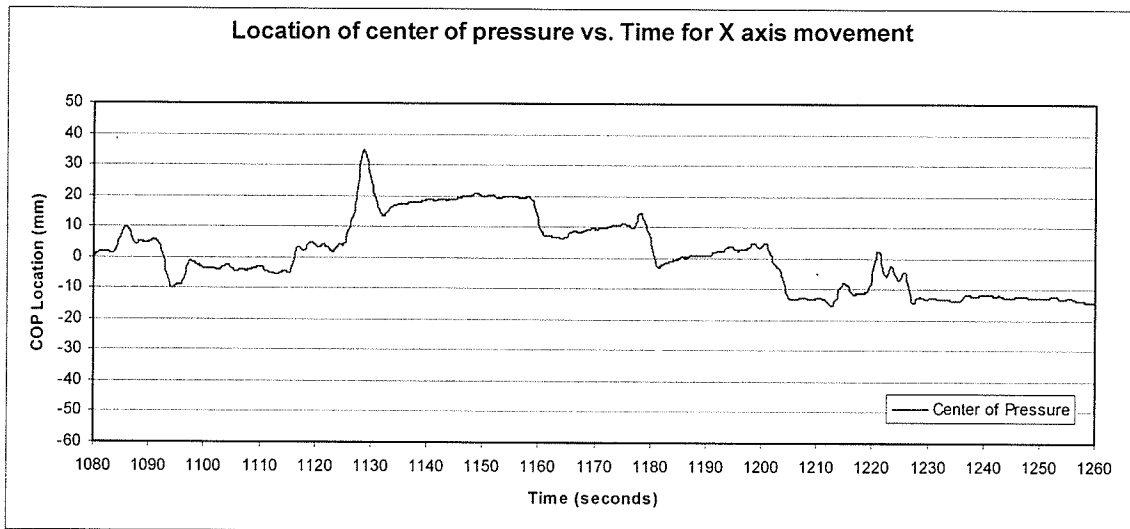

Location of center of pressure vs. Time for X axis movement

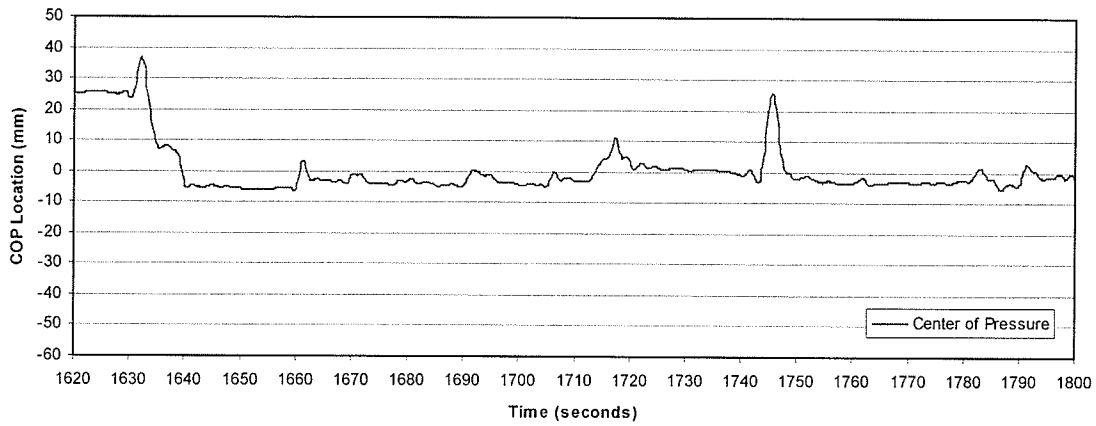

Location of center of pressure vs. Time for Y axis movement

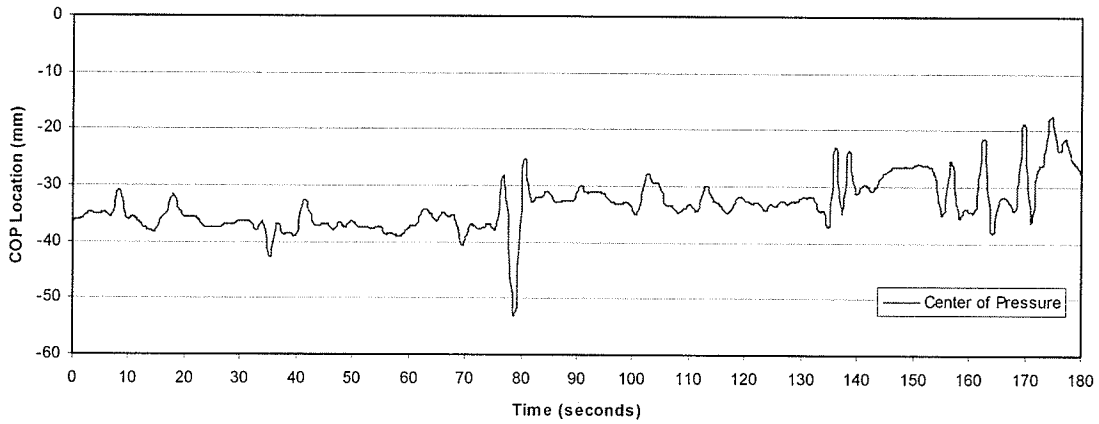

Location of center of pressure vs. Time for Y axis movement

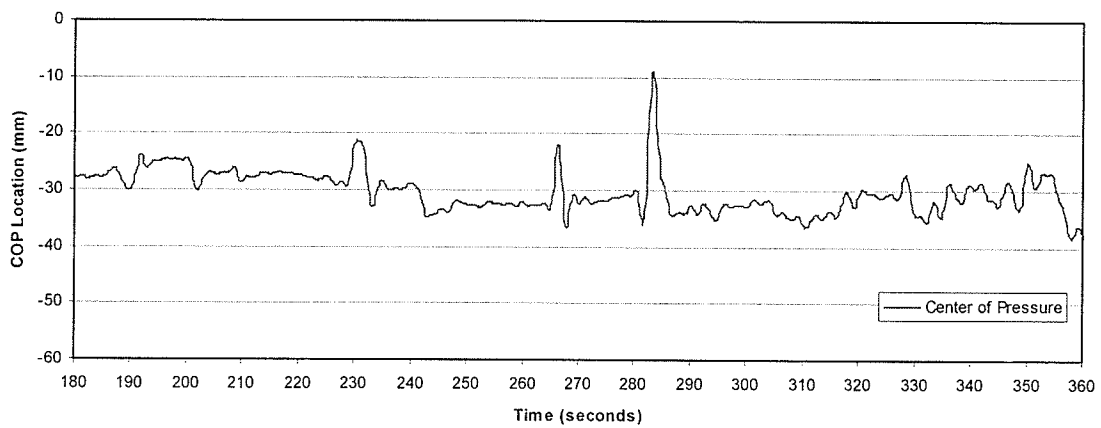

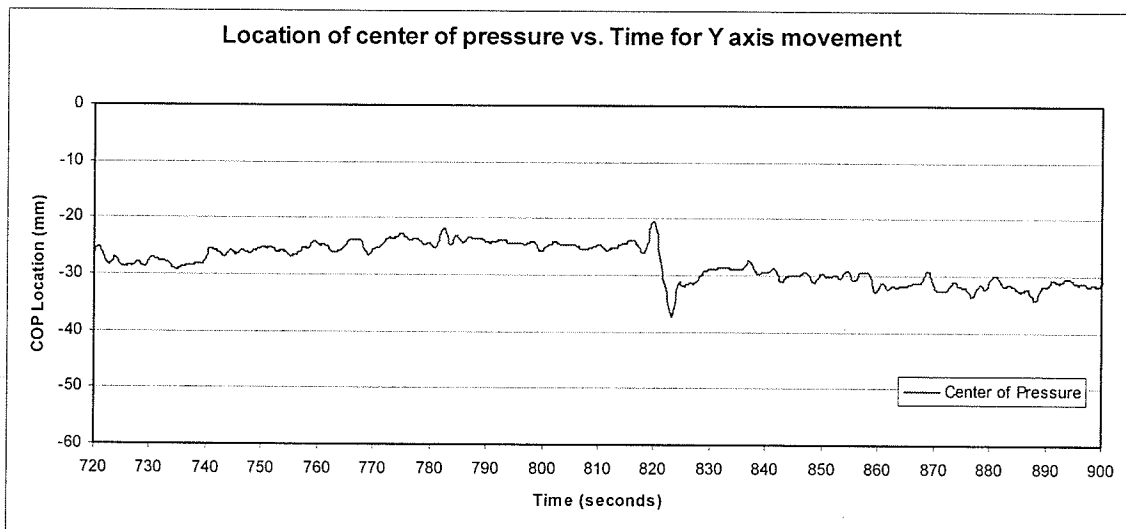
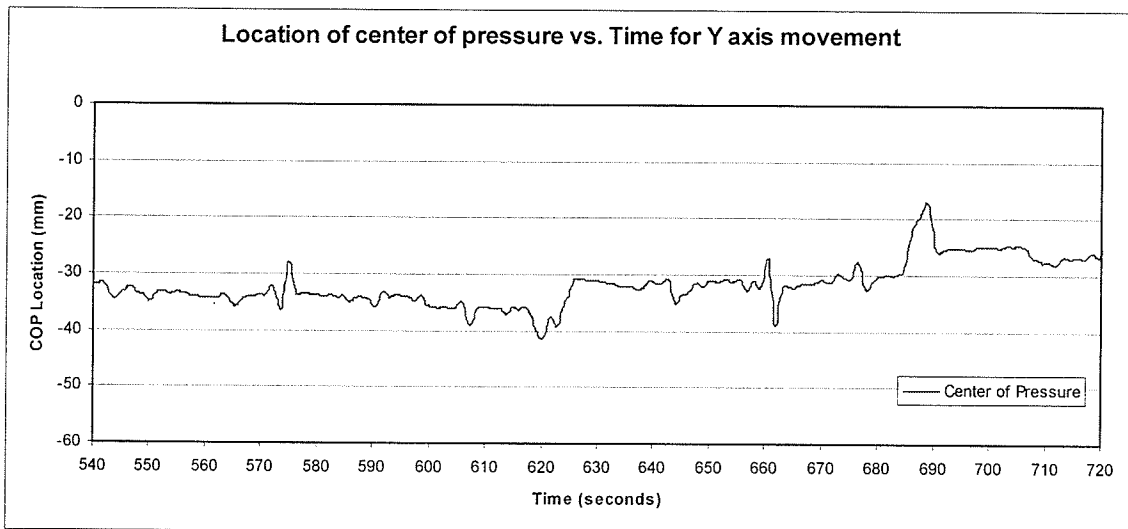
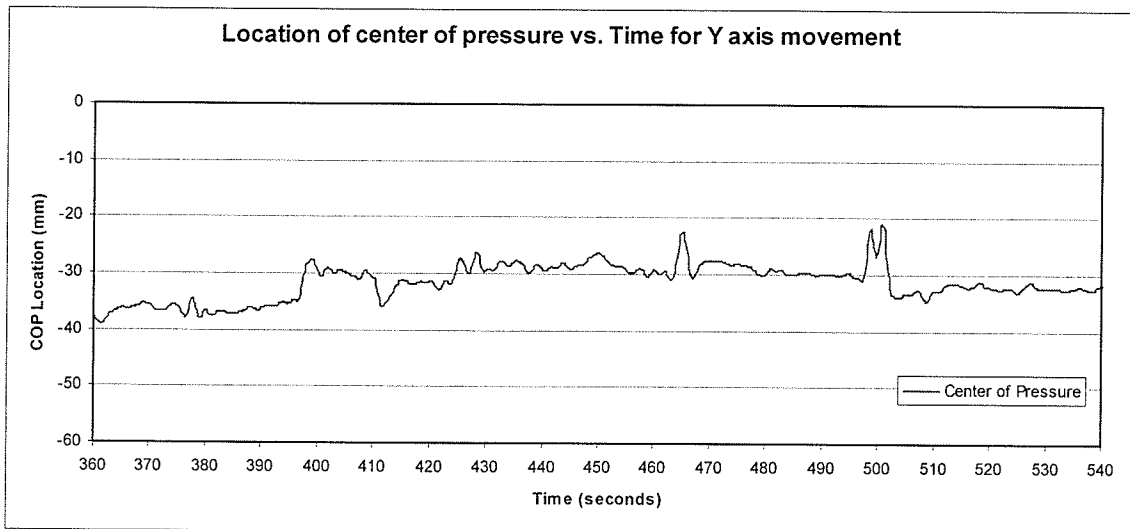

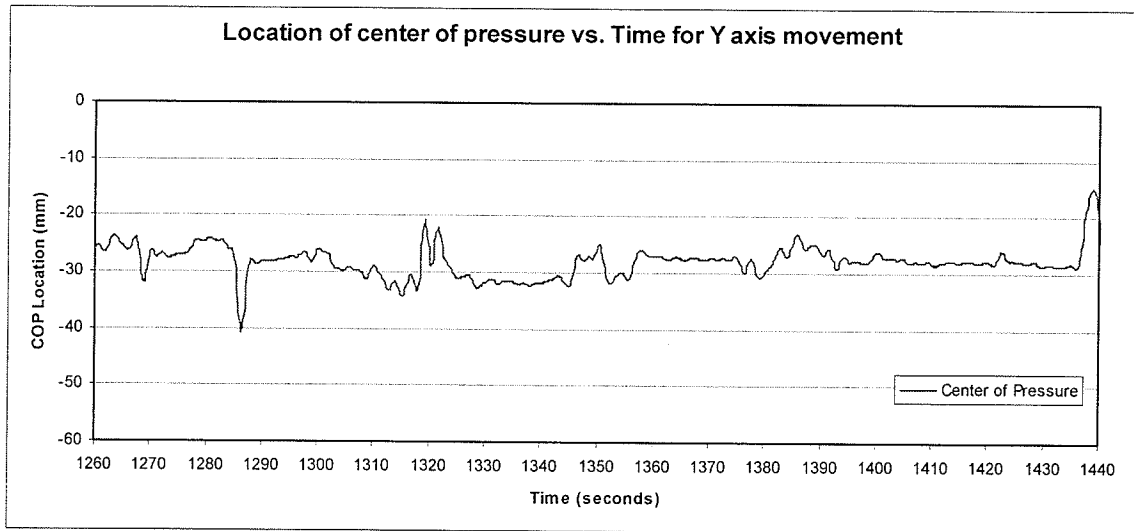
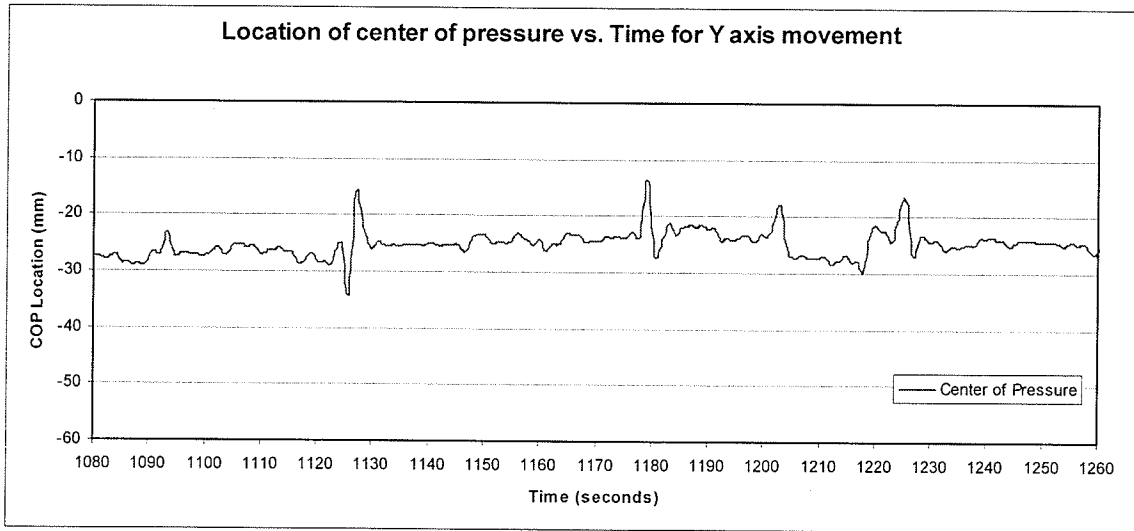
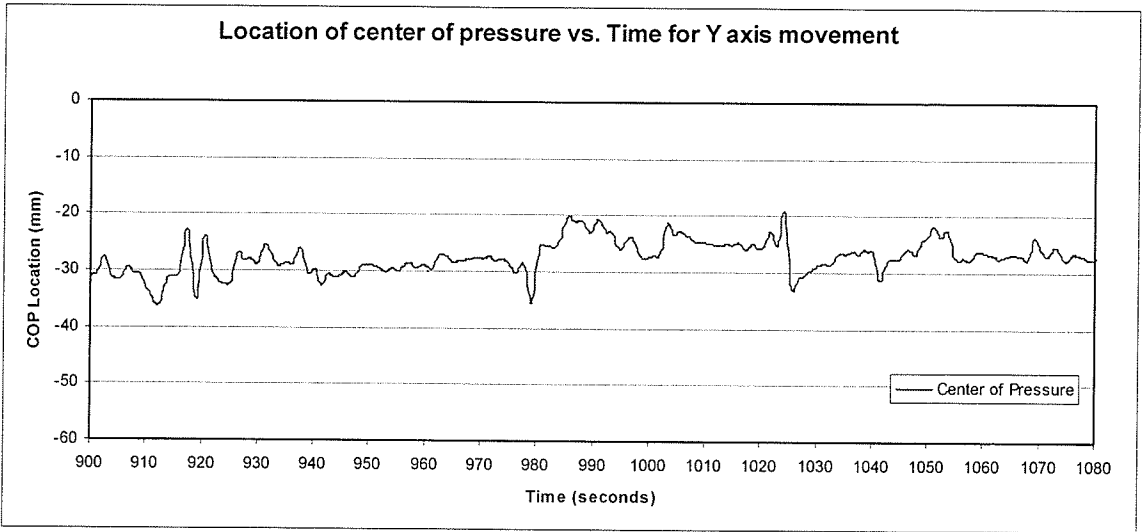

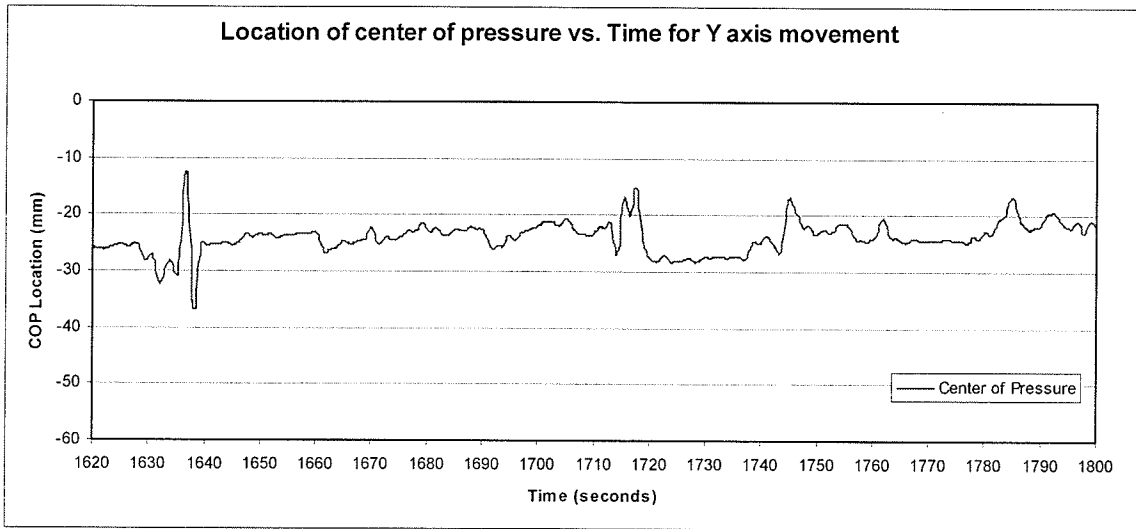
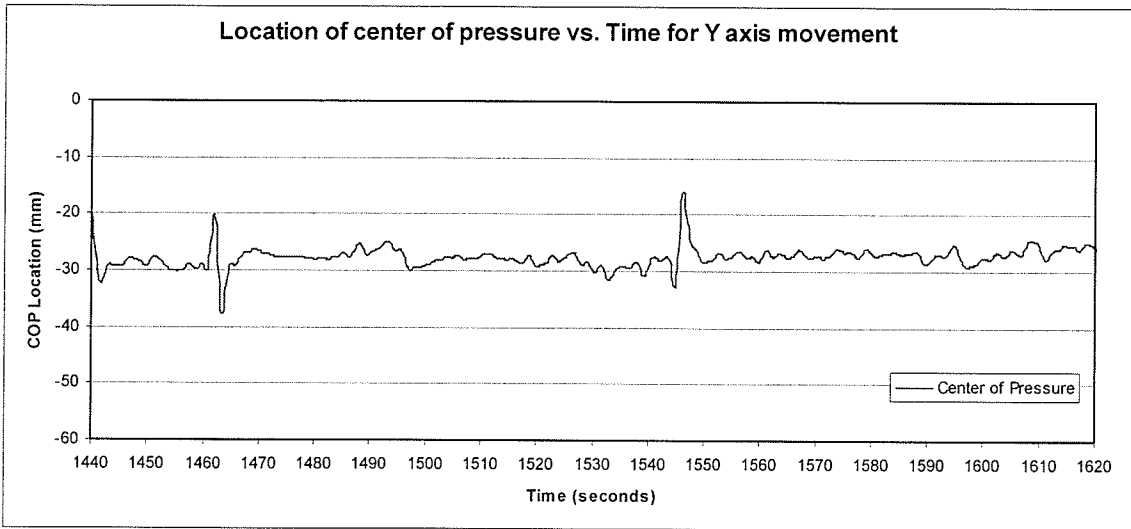

Subject - 13X	Manual Pattern Identification Chart
Approximate Time (seconds)	Pattern Description
1st order begins - 173	Shift - approximate amplitude of 29 mm (-10 to 19)
280	Fidget - approximate amplitude of 38 mm (-10 to 28) base may be too wide
1436	Fidget - approximate amplitude of 36 mm (-18 to 18) base may be too wide
1545	Shift - approximate amplitude of 22 mm (0 to 22) extends higher due to fidget-like pattern
2nd order begins - 34	Fidget - approximate amplitude of 16 mm (-20 to -4)
156	Fidget - approximate amplitude of 15 mm (-13 to 2)
227	Fidget - approximate amplitude of 26 mm (9 to 35)
231	Shift - approximate amplitude of 20 mm (9 to -11)
356	Shift - approximate amplitude of 11 mm (-10 to -21)
395	Shift - approximate amplitude of 16 mm (-25 to -9)
497	Shift - approximate amplitude of 14 mm (-12 to 2)
501	Shift - approximate amplitude of 12 mm (3 to -9)
569	Fidget - approximate amplitude of 19 mm (-10 to 9)
574	Shift - approximate amplitude of 19 mm (-10 to -29) previous fidget ties directly into this shift
660	Shift - approximate amplitude of 15 mm (-22 to -7)
826 to 865	Drift - approximate amplitude of 8 mm (-18 to -10)
977	Shift - approximate amplitude of 11mm (-20 to -9)
1040	Shift - approximate amplitude of 10 mm (-8 to 2)
1048	Shift - approximate amplitude of 11 mm (3 to -8)
1159	Shift - approximate amplitude of 12 mm (20 to 8)
1179	Shift - approximate amplitude of 16 mm (14 to -2)
1200	Shift - approximate amplitude of 17 mm (4 to -13)
1321	Shift - approximate amplitude of 20 mm (0 to -20) may actually be two smaller shifts
1460	Shift - approximate amplitude of 19 mm (-19 to 0)
1629	Fidget - approximate amplitude of 15 mm (23 to 38)
1632	Shift - approximate amplitude of 16 mm (23 to 7) previous fidget continues into this shift
1639	Shift - approximate amplitude of 12 mm (6 to -6)
1742	Fidget - approximate amplitude of 29 mm (-3 to 26)
3rd order begins - 67	Shift - approximate amplitude of 8 mm (-16 to -8)
135	Fidget - approximate amplitude of 12 mm (-19 to -7)
241	Shift - approximate amplitude of 9 mm (-8 to -17)
264	Shift - approximate amplitude of 9 mm (-19 to -10)
328	Fidget - approximate amplitude of 11 mm (-20 to -9)
677	Shift - approximate amplitude of 6 mm (-9 to -15)
1114	Shift - approximate amplitude of 7 mm (-5 to 2)
1345	Shift - approximate amplitude of 9 mm (-19 to -10)

Approximate Time (seconds)	Pattern Description
4th order begins - 76	Fidget - approximate amplitude of 26 mm (-19 to 7) base may be too wide to be considered a fidget
170	Fidget - approximate amplitude of 14 mm (-10 to 4)
284	Shift - approximate amplitude of 7 mm (-10 to -17) preceded by a fidget (see 1st order)
621	2 patterns - Shift - approximate amplitude of 6 mm (-30 to -24) preceded by a fidget of approx. amplitude of 21 mm (-24 to -3)
816	2 patterns - Shift - approximate amplitude of 9 mm (-10 to -19) preceded by a fidget of approx. amplitude of 11 mm (-10 to 1)
917	Shift - approximate amplitude of 17 mm (-3 to -20) preceded by a fidget
929	2 patterns - Shift - approximate amplitude of 13 mm (-23 to -10) preceded by a fidget of approx. amplitude of 26 mm (-10 to 16)
1123	2 patterns - Shift - approximate amplitude of 10 mm (3 to 13) preceded by a fidget of approx. amplitude of 22 mm (13 to 35)
Subject - 13Y	Manual Pattern Identification Chart
Approximate Time (seconds)	Pattern Description
1st order begins - 1530 to 1705	Drift - approximate amplitude of 9 mm (-30 to -21)
2nd order begins - 160	Fidget - approximate amplitude of 15 mm (-34 to -19)
168	Fidget - approximate amplitude of 15 mm (-34 to -19)
280	Fidget - approximate amplitude of 26 mm (-35 to -9)
410 to 450	Drift - approximate amplitude of 10 mm (-36 to -26)
1284	Fidget - approximate amplitude of 15 mm (-26 to -41)
1634	Fidget - approximate amplitude of 29 mm (-31 to -2)
3rd order begins - 134	Fidget - approximate amplitude of 14 mm (-37 to -23)
154	Fidget - approximate amplitude of 10 mm (-35 to -25)
241	Shift - approximate amplitude of 5 mm (-30 to -35)
265	Fidget - approximate amplitude of 12 mm (-34 to -22)
396	Shift - approximate amplitude of 6 mm (-35 to -29)
622	Shift - approximate amplitude of 8 mm (-39 to -31)
817	Shift - approximate amplitude of 7 mm (-25 to -32) overshoot and undershoot on either side of shift
1176	Fidget - approximate amplitude of 11 mm (-24 to -13)
1218	Shift - approximate amplitude of 8 mm (-30 to -22)
1436	Fidget - approximate amplitude of 14 mm (-29 to -15)
1459	Fidget - approximate amplitude of 10 mm (-30 to -20)
1545	Fidget - approximate amplitude of 12 mm (-28 to -16)
4th order begins - 75	Fidget - approximate amplitude of 25 mm (-28 to -53) begins in the middle of two smaller fidgets
917	Fidget - approximate amplitude of 12 mm (-23 to -35)
	begins in the middle of two smaller fidgets

Subject 14

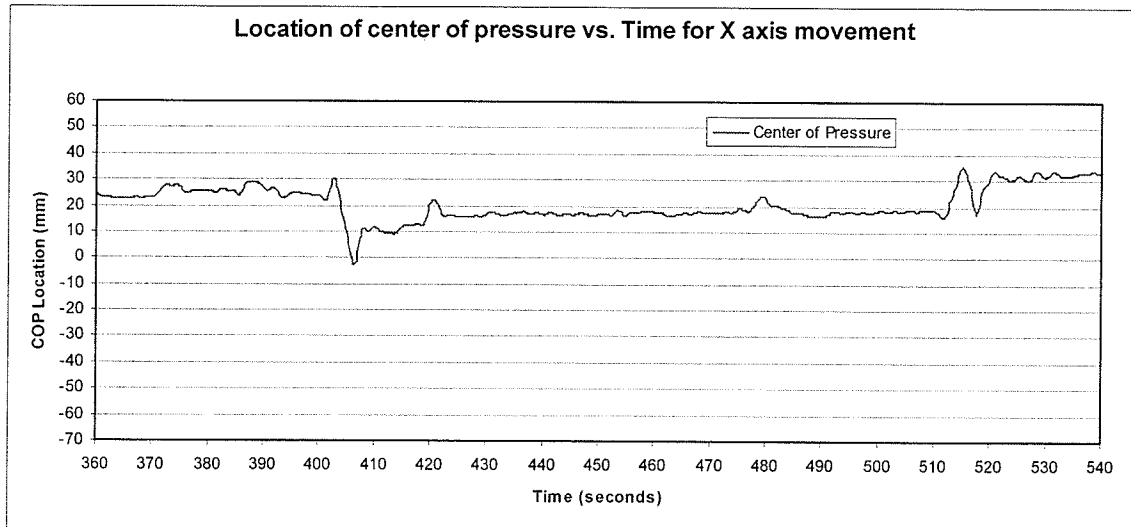
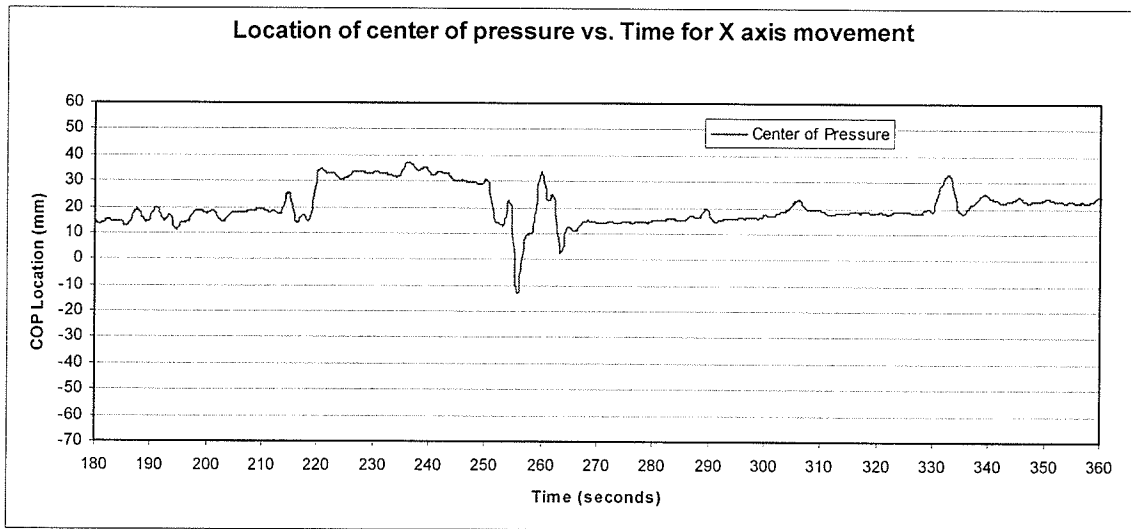
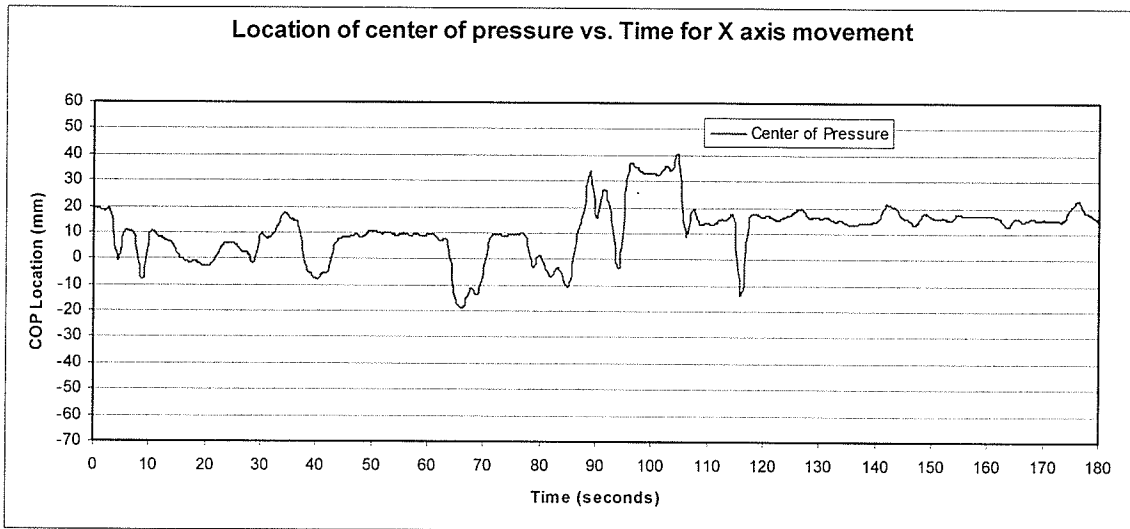

Location of center of pressure vs. Time for X axis movement

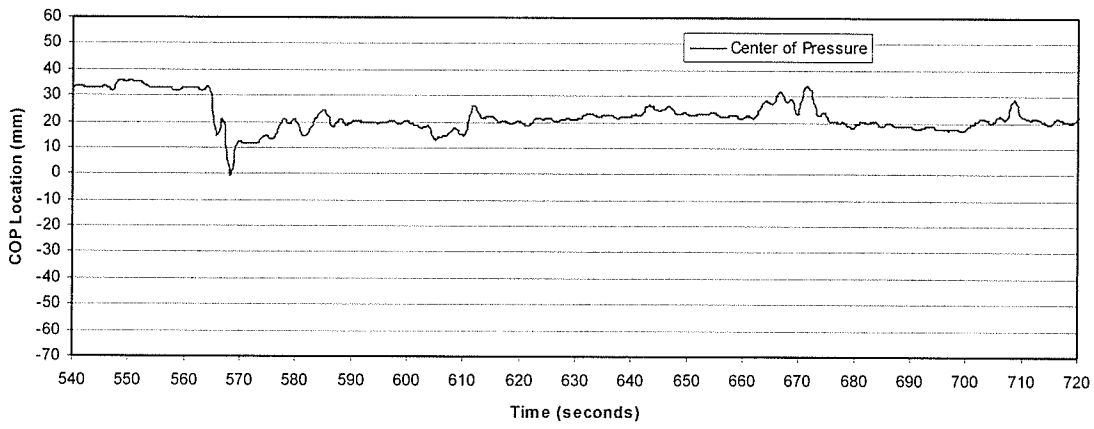

Location of center of pressure vs. Time for X axis movement

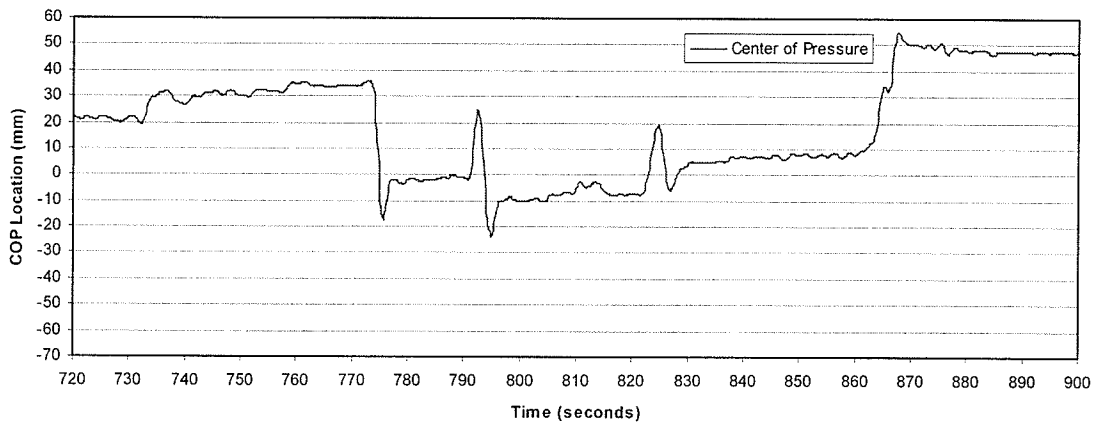

Location of center of pressure vs. Time for X axis movement

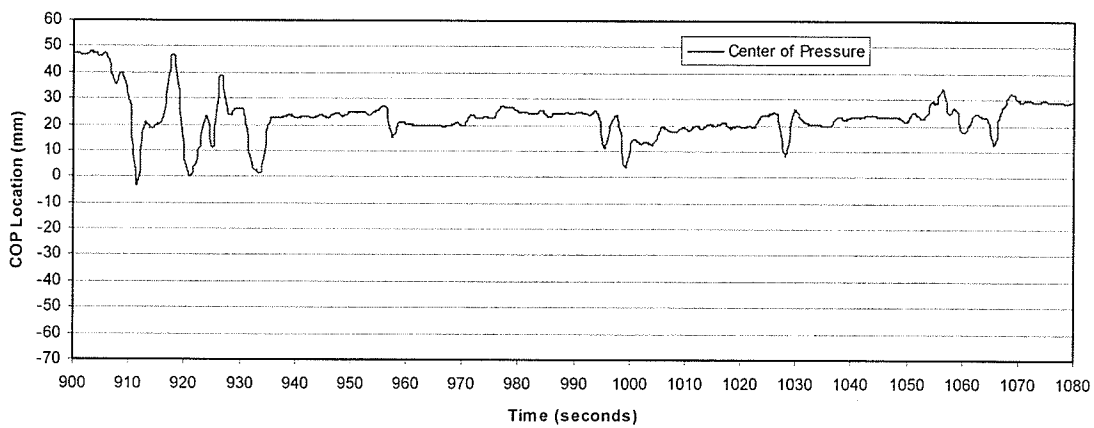

Location of center of pressure vs. Time for X axis movement

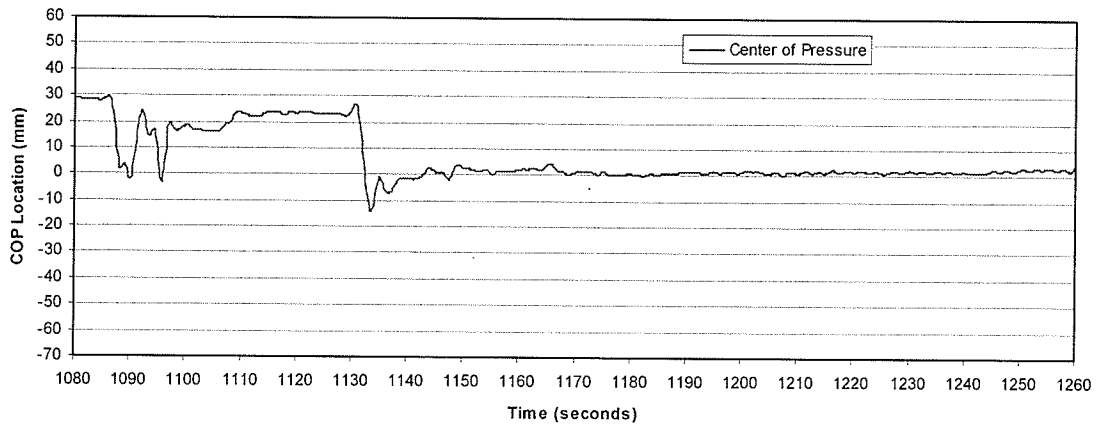

Location of center of pressure vs. Time for X axis movement

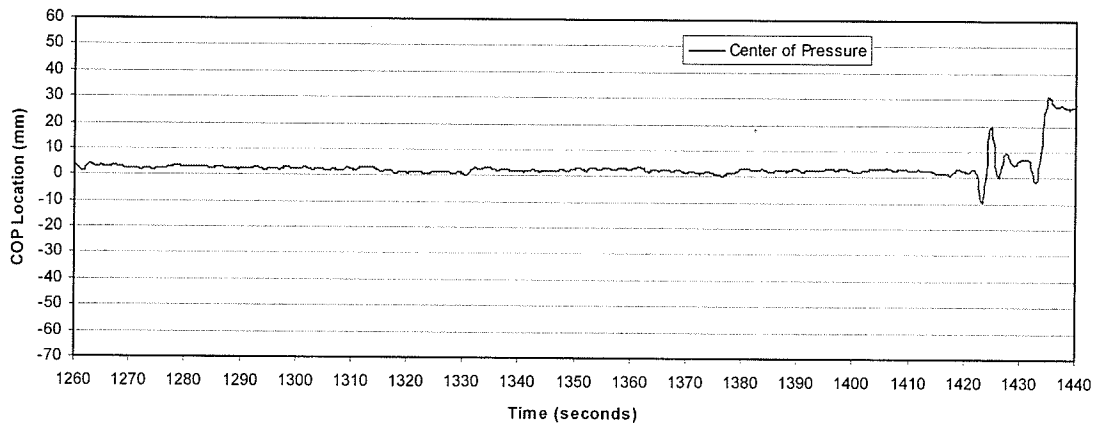

Location of center of pressure vs. Time for X axis movement

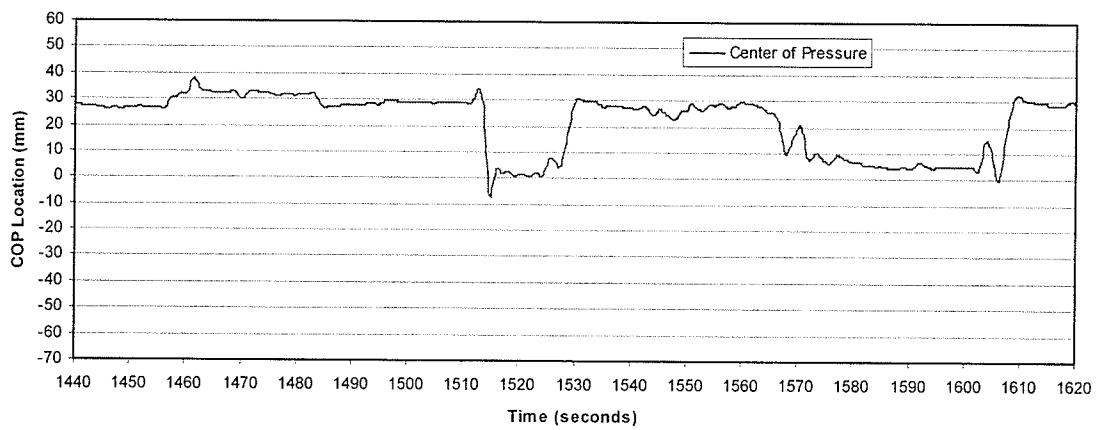

Location of center of pressure vs. Time for X axis movement

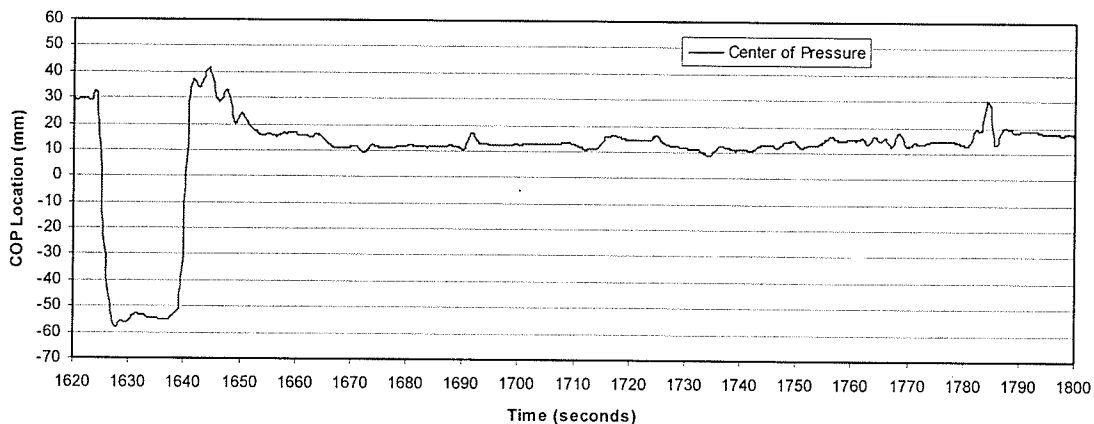

Location of center of pressure vs. Time for Y axis movement

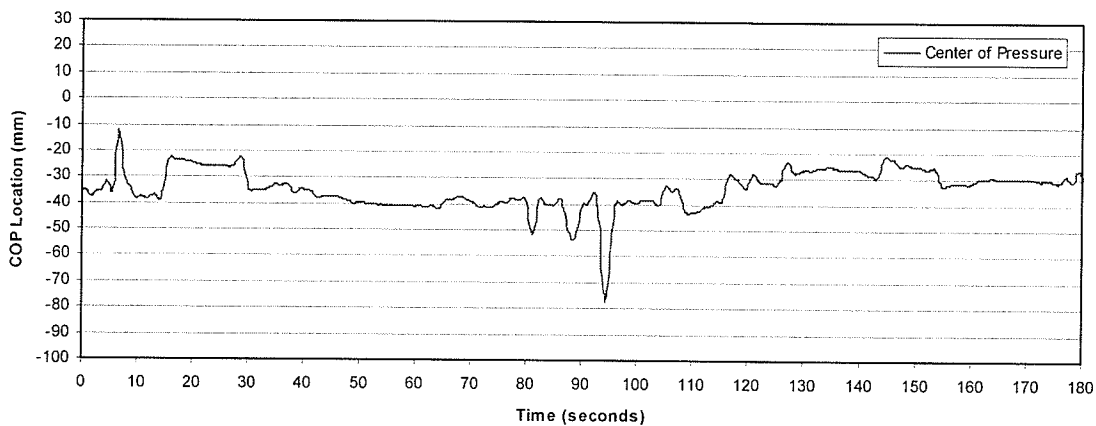

Location of center of pressure vs. Time for Y axis movement

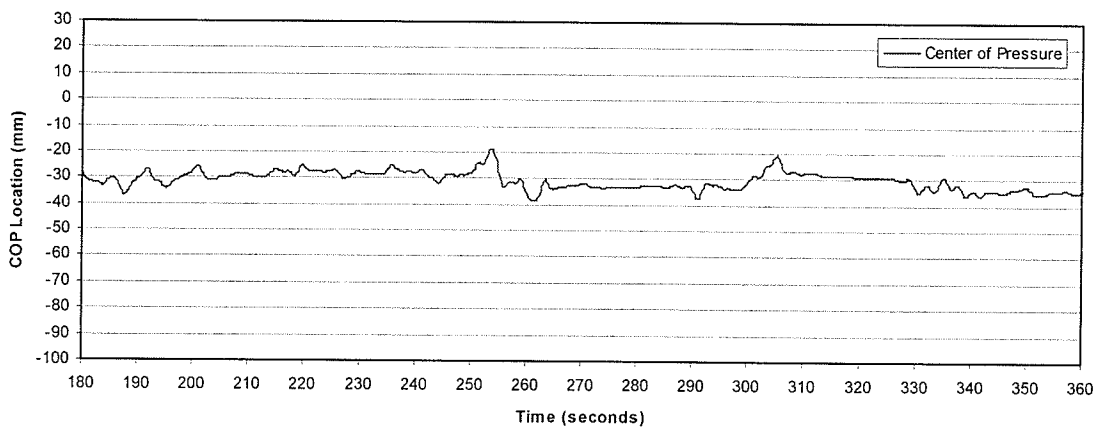

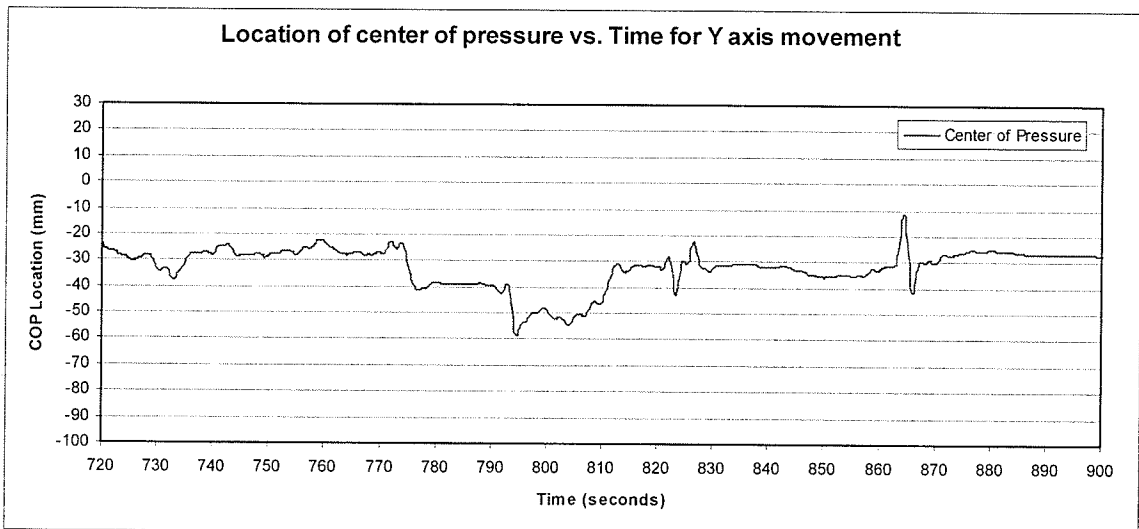
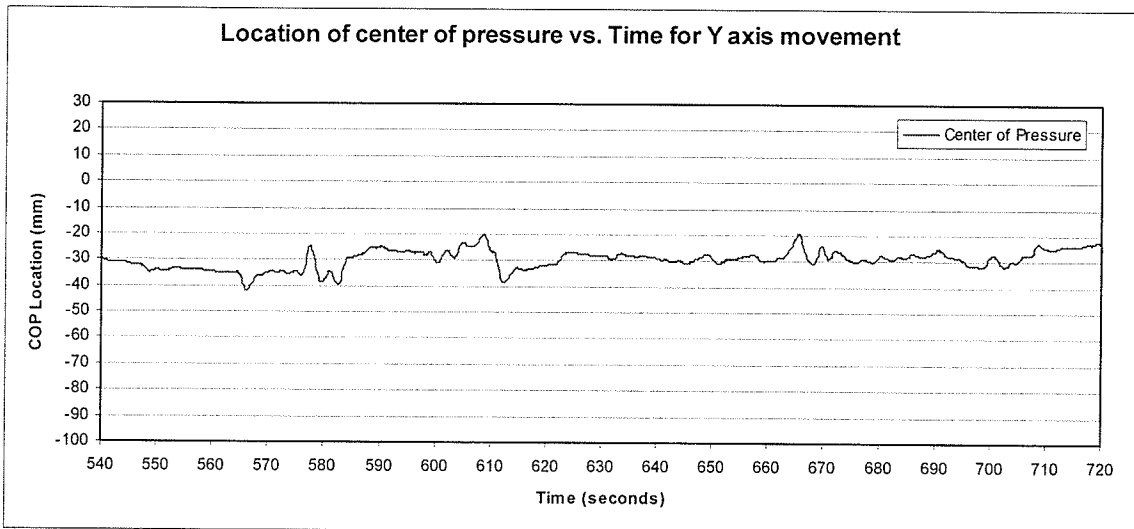
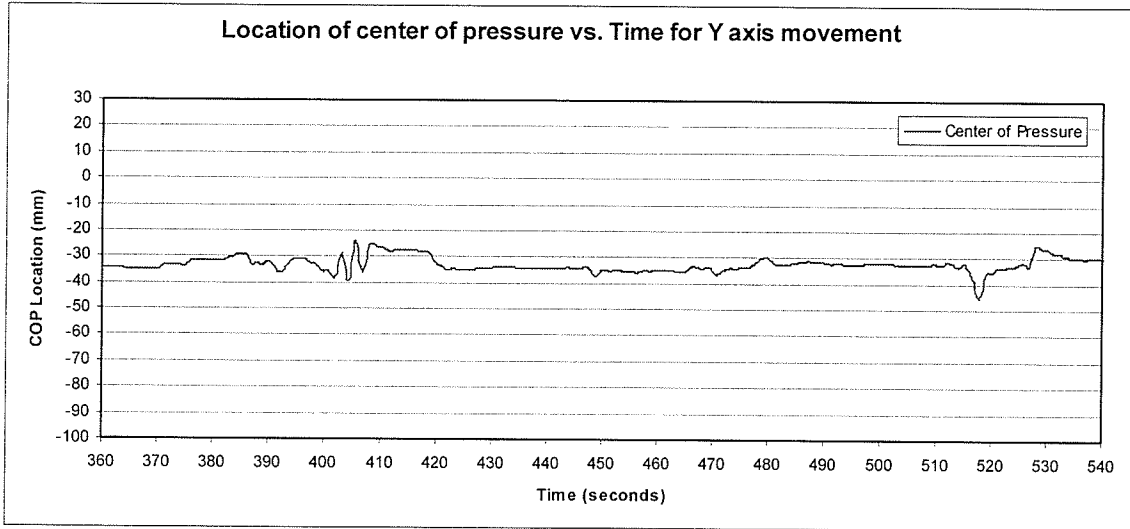

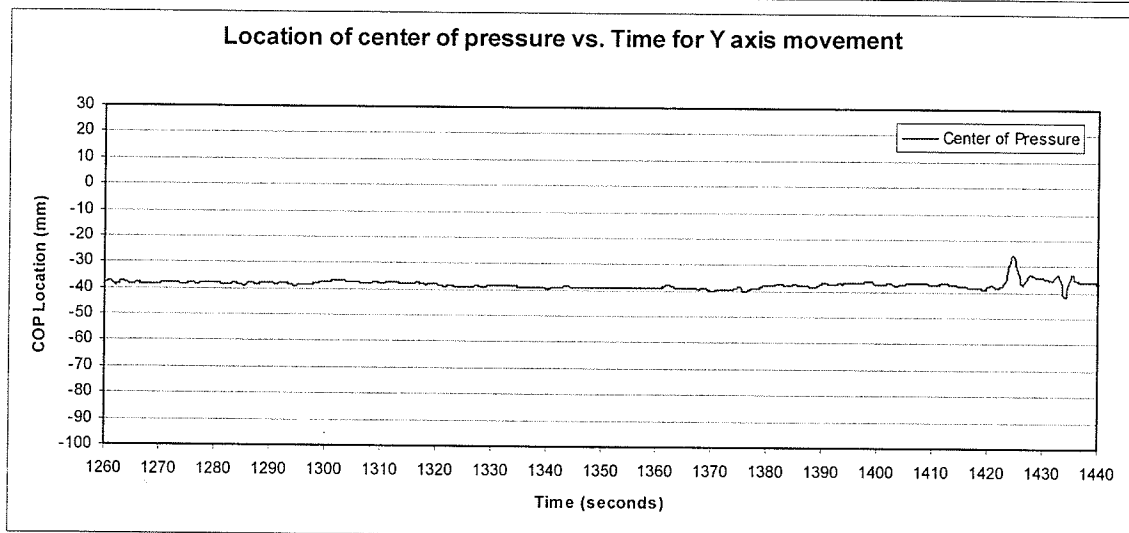
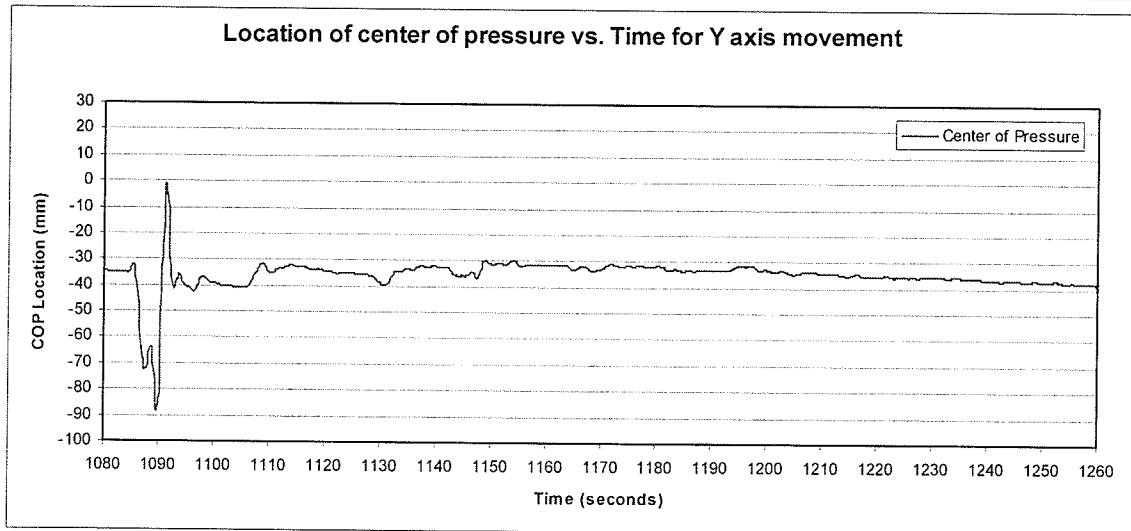
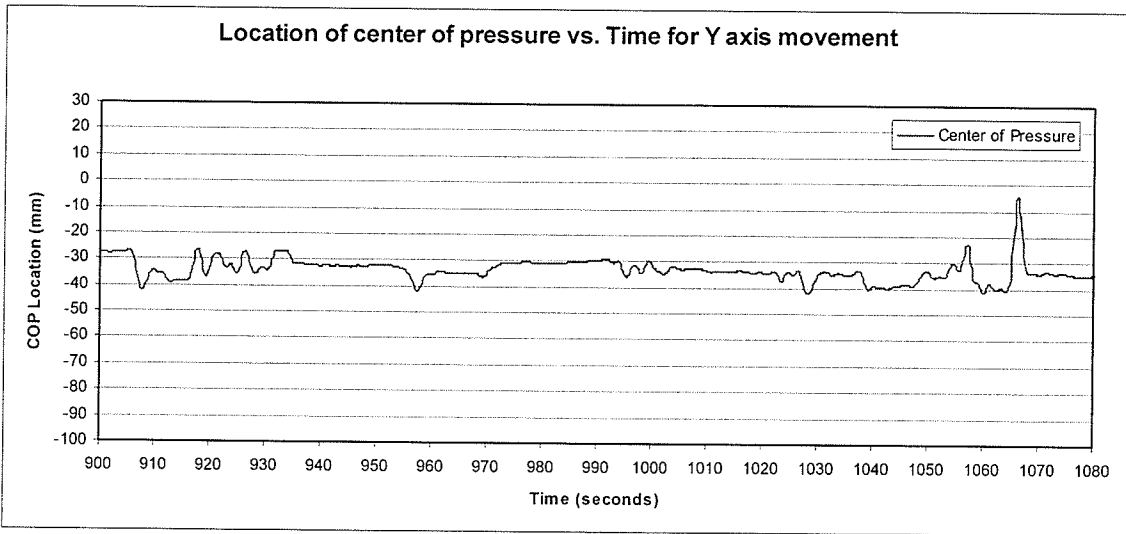

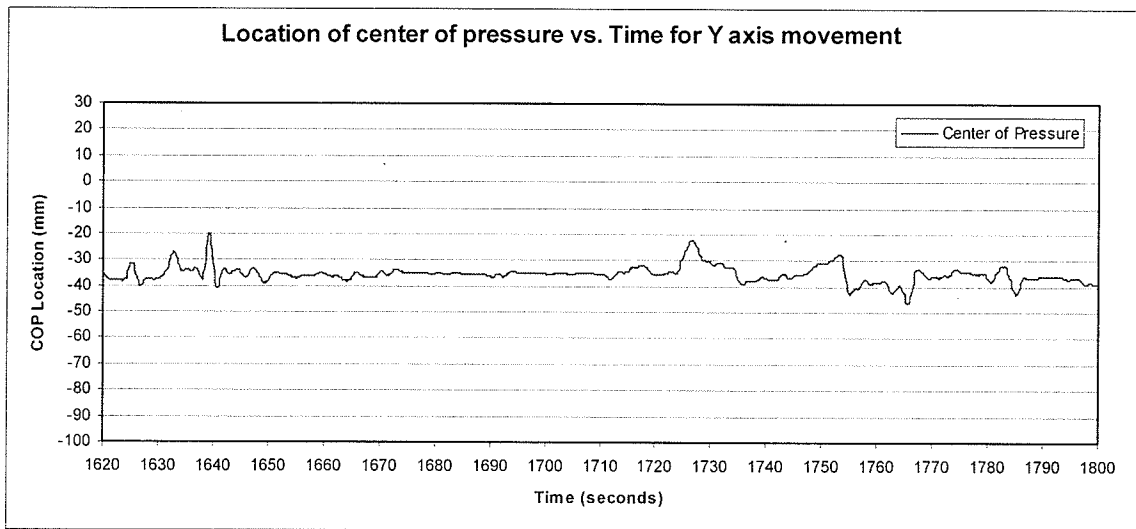
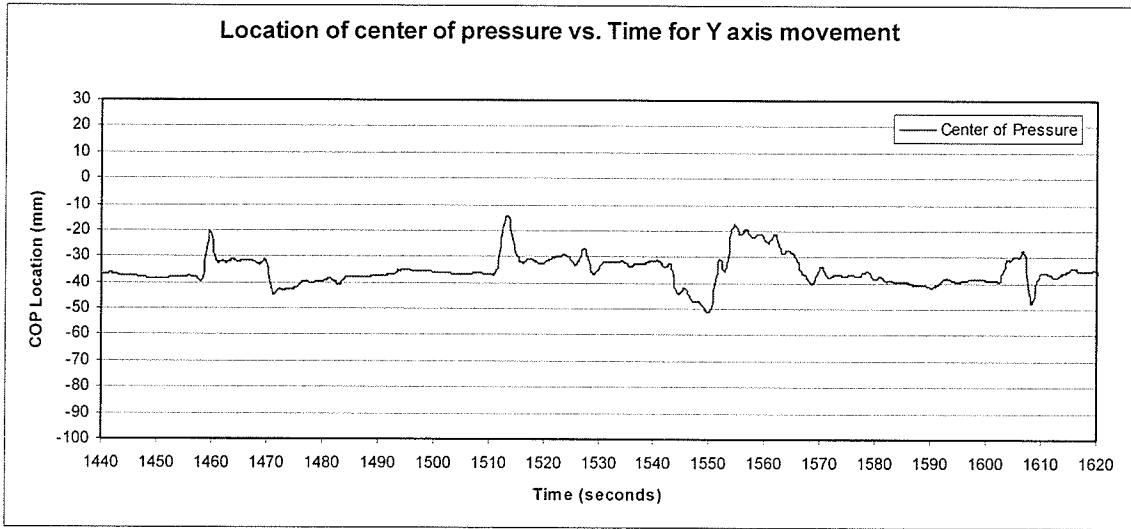

Subject - 14X	Manual Pattern Identification Chart
Approximate Time (seconds)	Pattern Description
1st order begins - 63	
	Shift - approximate amplitude of 26 mm (8 to -18)
68	Shift - approximate amplitude of 22 mm (-12 to 10)
114	Fidget - approximate amplitude of 32 mm (18 to -14)
265 to 329	Drift - approximate amplitude of 9 mm (11 to 20)
773	Shift - approximate amplitude of 38 mm (36 to -2)
862	Shift - approximate amplitude of 40 mm (10 to 50)
1130	Shift - approximate amplitude of 27 mm (22 to -5)
1433	Shift - approximate amplitude of 28 mm (0 to 28)
1512	Shift - approximate amplitude of 27 mm (29 to 2)
1527	Shift - approximate amplitude of 25 mm (5 to 30)
1605	Shift - approximate amplitude of 26 mm (5 to 31)
1624	Shift - approximate amplitude of 87 mm (30 to -57)
1639	Shift - approximate amplitude of 87 mm (-52 to 35)
2nd order begins - 7	
	Fidget - approximate amplitude of 19 mm (10 to -9)
37	Shift - approximate amplitude of 19 mm (14 to -5)
41	Shift - approximate amplitude of 15 mm (-7 to 8)
76	Shift - approximate amplitude of 13 mm (10 to -3)
103	Shift - approximate amplitude of 20 mm (35 to 15)
216	Shift - approximate amplitude of 20 mm (15 to 35)
250	Shift - approximate amplitude of 17 mm (30 to 13)
400	Shift - approximate amplitude of 12 mm (22 to 10) includes overshoot and undershoot
562	Shift - approximate amplitude of 20 mm (32 to 12)
790	Fidget - approximate amplitude of 26 mm (-1 to 25)
821	Fidget - approximate amplitude of 27 mm (-8 to 19)
828 to 861 (perhaps from 802)	Drift - approximate amplitude of 10 mm (0 to 10)
1026	Fidget - approximate amplitude of 16 mm (25 to 9)
1094	Fidget - approximate amplitude of 20 mm (18 to -2)
1423	Fidget - approximate amplitude of 20 mm (0 to 20)
1565	Shift - approximate amplitude of 15 mm (25 to 10)
3rd order begins - 567	
	Fidget - approximate amplitude of 13 mm (12 to -1)
731	Shift - approximate amplitude of 9 mm (21 to 30)
792	Shift - approximate amplitude of 9 mm (-1 to -10) includes undershoot which may be separate fidget
993	Fidget - approximate amplitude of 14 mm (25 to 11)
1602	Fidget - approximate amplitude of 12 mm (3 to 15)
1782	Fidget - approximate amplitude of 11 mm (19 to 30)
4th order begins - 93	
	Shift - approximate amplitude of 41 mm (-3 to 38) preceded by peaks
517	Shift - approximate amplitude of 11 mm (17 to 28)
908	Shift - approximate amplitude of 20 mm (40 to 20), with fidget-like undershoot
931	Shift - approximate amplitude of 24 mm (26 to 2)

Approximate Time (seconds)	Pattern Description
933	Shift - approximate amplitude of 21 mm (1 to 22) may not have enough points between to be considered shifts
997	Shift - approximate amplitude of 9 mm (23 to 14) includes undershoot
Subject - 14Y	Manual Pattern Identification Chart
Approximate Time (seconds)	Pattern Description
1st order begins - 92	Fidget - approximate amplitude of 38 mm (-40 to -78)
1148 to 1260	Drift - approximate amplitude of 8 mm (-30 to -38)
2nd order begins - 5	Fidget - approximate amplitude of 24 mm (-36 to -12)
13	Shift - approximate amplitude of 17 mm (-39 to -22)
27	Shift - approximate amplitude of 10 mm (-26 to -36)
85	Fidget - approximate amplitude of 15 mm (-38 to -53)
306 to 352	Drift - approximate amplitude of 7 mm (-28 to -35)
528 to 576	Drift - approximate amplitude of 10 mm (-25 to -35)
772	Shift - approximate amplitude of 16 mm (-25 to -41)
792	Shift - approximate amplitude of 19 mm (-40 to -59)
809	Shift - approximate amplitude of 16 mm (-47 to -31)
862	Fidget - approximate amplitude of 20 mm (-31 to -11)
1468	Shift - approximate amplitude of 13 mm (-31 to -44)
1637	Fidget - approximate amplitude of 18 mm (-38 to -20)
1751	Shift - approximate amplitude of 14 mm (-28 to -42)
3rd order begins - 80	Fidget - approximate amplitude of 14 mm (-38 to -52)
142	Shift - approximate amplitude of 9 mm (-30 to -21)
153	Shift - approximate amplitude of 7 mm (-26 to -33)
401	Fidget - approximate amplitude of 10 mm (-39 to -29)
403	Fidget - approximate amplitude of 12 mm (-36 to -24)
405	Shift - approximate amplitude of 12 mm (-37 to -25)
515	Fidget - approximate amplitude of 11 mm (-35 to -46)
575	Fidget - approximate amplitude of 12 mm (-37 to -25)
821	Fidget - approximate amplitude of 13 mm (-30 to -43)
916	Fidget - approximate amplitude of 11 mm (-38 to -27)
1037	Shift - approximate amplitude of 7 mm (-33 to -40)
1105	Shift - approximate amplitude of 6 mm (-41 to -35)
1422	Fidget - approximate amplitude of 12 mm (-38 to -26)
4th order begins - 906	Shift - approximate amplitude of 12 mm (-27 to -39) small undershoot and then increase before settling
1063	2 patterns - Shift - approximate amplitude of 7 mm (-40 to -33) includes fidget with approx. amplitude of 29 mm (-33 to -4)
1085 1091	Fidget - approximate amplitude of 54 mm (-35 to -89), base may be too wide Fidget - approximate amplitude of 36 mm (-37 to -1)
1457	2 patterns - Shift - approximate amplitude of 8 mm (-40 to -32) includes fidget with approx. amplitude of 12 mm (-32 to -20)
1510	2 patterns - Shift - approximate amplitude of 6 mm (-38 to -32) includes fidget with approx. amplitude of 18 mm (-32 to -14)

APPENDIX C – Identification Comparison Tables and Notes

In this appendix the tabulated results from the manual identification and computer identification program are presented and compared in table form. Patterns are labelled as being identified by the manual identification process, the computer identification process, or both. In some cases there are instances where patterns were not initially identified as being identified by both identification procedures. Upon further review, however, it was determined that these patterns were in fact the same. In these instances a superscript is attached to the identifying 'x', thus distinguishing which patterns are associated with each other.

Following the data tables is a Notes section in which some details are given for questionably identified patterns.

Subject	1Y
----------------	----

Approx. Time (s)	Pattern	Pattern Occur.		
		Man.	Comp.	Both
8(9)	Fidget			x
37(39)	Fidget			x
43	Fidget	x		
92	Shift		x	
93(95)	Fidget			x
125	Fidget	x ^A		
127	Fidget		x ^A	
128(129)	Fidget			x
144 - 174	Drift	x	< 60 seconds	
155	Shift		x	
205	Fidget		x	
226	Shift	x		
230	Shift	x		
246	Shift	x		
262	Shift	x		
266	Shift	x		
275	Shift	x		
304	Shift			x
357	Fidget		x	
481	Shift			x
851	Shift	x		
858	Shift	x		
919 - 1041	Drift		x	
1001	Fidget	x ^B		
1006	Fidget		x ^B	
1032	Fidget	x		
1041	Shift			x
1122	Shift	x		
1138 - 1228	Drift		x	
1183	Fidget	x		
1210	Shift	x		
1540	Shift	x		
1584	Fidget	x		
1628 - 1800	Drift			x ^C
1635 - 1800	Drift			x ^C

Approx. Time	Pattern	Pattern Occur.		
		Man.	Comp.	Both

Subject	2X
----------------	----

Approx. Time (s)	Pattern	Pattern Occur.		
		Man.	Comp.	Both
2	Fidget	x		
33	Shift		x	
60(58)	Shift			x
63 - 149	Drift	x		
64	Fidget		x	
83	Shift		x	
87	Fidget		x	
116 - 237	Drift		x	
150	Fidget		x	
153	Shift	x		
160	Shift	x		
236(237)	Shift			x
241	Shift	x		
286	Shift		x ^A	
290	Shift	x ^A		
319	Shift		x	
323	Fidget		x	
350	Shift	x		
422	Fidget		x	
429	Shift	x		
446 - 540	Drift			x ^B
462	Shift		x	
478 - 560	Drift			x ^B
620	Shift		x	
640	Shift		x	
671 - 803	Drift		x	
753	Fidget		x	
803	Shift		x ^C	
807	Shift	x ^C		
808 - 891	Drift		x	
864(865)	Fidget			x
891	Shift		x	
959	Shift		x ^D	
964	Shift	x ^D		
965 - 995	Drift	x	< 60 seconds	
966	Fidget		x	
1027	Shift		x ^E	

Approx. Time	Pattern	Pattern Occur.		
		Man.	Comp.	Both
1030	Shift	x ^E		
1032 - 1080	Drift	x	< 60 seconds	
1047	Shift		x	
1051 - 1122	Drift		x	
1122	Shift		x	
1202	Shift	x		
1230	Fidget	x ^F		
1232	Fidget		x ^F	
1263	Shift	x		
1268	Fidget		x	
1269	Shift	x		
1274 - 1462	Drift			x ^G
1327	Shift		x	
1331 - 1467	Drift			x ^G
1467	Shift		x	
1524	Shift	x ^H		
1529	Shift	x ^H		
1529	Fidget		x ^H	
1538	Shift	x		
1634(1632)	Shift			x
1640	Fidget		x	
1678	Shift		x	
1683 - 1778	Drift		x	
1687	Shift	x		
1692	Shift	x		
1697	Shift	x		
1719	Shift	x		
1726	Shift	x		
1731	Shift	x		
1778	Shift		x	

Subject	3X
---------	----

Approx. Time (s)	Pattern	Pattern Occur.		
		Man.	Comp.	Both
15 - 139	Drift		x	
31(33)	Fidget			x
50	Fidget	x		
60	Shift	x		
64	Shift	x		
87	Shift	x		
108	Fidget		x	
139	Fidget	x		
139	Shift		x	
173	Fidget	x		
179	Fidget	x		
183(182)	Fidget			x
186	Fidget	x		
233	Fidget	x		
238	Fidget	x		
250	Shift	x		
275	Fidget	x		
288	Shift	x		
291	Fidget		x	
306	Shift		x ^A	
311	Shift	x ^A		
314 - 360	Drift	x	< 60 seconds	
332(334)	Fidget			x
363	Fidget	x ^B		
367	Fidget		x ^B	
390	Fidget		x	
395	Shift	x		
447(445)	Shift			x
477	Shift		x	
519 - 675	Drift			x ^C
533	Fidget	x		
537	Fidget	x		
542 - 680	Drift			x ^C
555	Fidget	x		
579	Fidget	x ^D		
583	Fidget		x ^D	
587	Fidget	x		

Approx. Time	Pattern	Pattern Occur.		
		Man.	Comp.	Both
604	Fidget	x		
652	Fidget		x	
693	Shift		x	
749	Shift		x	
776(777)	Shift			x
782 - 889	Drift			x ^E
796	Shift	x		
800	Shift	x		
801 - 862	Drift			x ^E
863	Shift	x		
867	Shift	x		
893 - 1000	Drift		x	
1003	Shift	x		
1009	Shift	x		
1086	Shift	x		
1104	Shift		x	
1105	Fidget		x	
1256	Shift		x	
1280	Shift	x		
1285	Shift	x		
1362	Shift		x	
1367	Shift			x
1382(1383)	Shift			x
1404	Shift	x		
1431	Shift		x	
1457(1455)	Shift			x
1465	Fidget	x		
1562	Shift	x		
1580 - 1720	Drift		x	
1647	Fidget		x	
1658	Shift	x		
1660	Fidget		x	
1663	Shift	x		
1670	Shift	x		
1684	Shift	x		
1705	Shift	x		
1720	Shift			x
1767(1770)	Fidget			x

Subject	3Y
---------	----

Approx. Time (s)	Pattern	Pattern Occur.		
		Man.	Comp.	Both
4(6)	Fidget			x
31(34)	Fidget			x
80	Fidget	x		
80	Shift	x		
88	Shift	x		
92	Shift	x		
108	Fidget	x		
128	Shift	x		
134	Shift		x ^A	
142	Shift	x ^A		
157	Shift	x		
175	Fidget	x		
191	Fidget	x ^B		
195	Fidget		x ^B	
239	Shift	x		
260	Fidget			x
297	Shift	x		
311	Shift	x ^C		
313	Fidget		x ^C	
364	Shift	x ^D		
367	Fidget		x ^D	
394	Shift	x		
400 - 439	Drift	x		
420	Shift		x	
447(445)	Shift			x
449 - 530	Drift		x ^E	
481 - 520	Drift	x ^E		
533(530)	Shift			x
535 - 649	Drift		x	
582	Fidget		x	
613(615)	Fidget			x
649	Shift		x	
669	Shift		x	
697(700)	Shift			x
716 - 773	Drift	x		
749	Shift		x	
796	Shift	x ^F		

Approx. Time	Pattern	Pattern Occur.		
		Man.	Comp.	Both
800	Fidget		x ^F	
826	Shift		x ^G	
832	Shift	x ^G		
854	Shift		x	
900	Shift		x	
945 - 1034	Drift		x	
980	Shift	x		
1002	Shift	x		
1008	Shift	x		
1011 - 1067	Drift	x		
1034	Shift		x	
1067	Shift	x ^H		
1070	Fidget		x ^H	
1107	Shift	x ^I		
1110	Fidget		x ^I	
1111	Shift	x ^I		
1128	Shift		x	
1171	Shift		x ^J	
1176	Shift	x ^J		
1195	Shift			x
1204 - 1257	Drift	x		
1238	Shift		x	
1281	Shift	x ^K		
1285	Fidget		x ^K	
1285 - 1346	Drift	x		
1300	Shift		x	
1360	Fidget	x ^L		
1366	Fidget		x ^L	
1430	Shift		x	
1493 - 1525	Drift	x		
1510	Shift		x	
1562	Shift	x ^M		
1567	Fidget		x ^M	
1573	Shift	x		
1591	Shift		x	
1649	Shift		x	
1671	Shift	x		

Subject	3Y cont'd
---------	-----------

Approx.	Pattern	Pattern Occur.		
		Man.	Comp.	Both
1706	Shift	x		
1717	Shift	x		
1742	Shift	x ^N		
1745	Fidget		x ^N	
1768	Shift	x		

Approx.	Pattern	Pattern Occur.		
		Man.	Comp.	Both
Time				

Subject	6X
---------	----

Approx. Time (s)	Pattern	Pattern Occur.		
		Man.	Comp.	Both
235	Shift		x ^A	
240	Shift	x ^A		
255	Shift			x
273 - 386	Drift		x	
394(397)	Fidget			x
418	Shift	x		
426	Shift	x		
488 - 910	Drift			x ^B
503 - 897	Drift			x ^B
928	Shift		x	
932 - 1004	Drift		x	
1024	Shift		x	
1150	Shift		x	
1206	Shift		x	
1252	Shift		x	
1282	Shift		x	
1337 - 1447	Drift		x	
1448 - 1563	Drift		x	
1610	Shift		x	
1638	Shift		x	
1643	Fidget		x	
1643 - 1709	Drift		x	
1708(1709)	Shift			x
1721	Shift	x		

Approx. Time	Pattern	Pattern Occur.		
		Man.	Comp.	Both

Subject	7X
---------	----

Approx. Time (s)	Pattern	Pattern Occur.		
		Man.	Comp.	Both
0 - 96	Drift			x ^A
55	Shift	x		
57 - 109	Drift			x ^A
109	Shift	x		
110 - 148	Drift	x		
127	Shift		x	
172	Shift		x ^B	
178	Shift	x ^B		
192(193)	Shift			x
196	Shift	x		
217	Shift	x		
223	Shift	x		
237	Shift	x ^C		
241	Fidget		x ^C	
273 - 308	Drift	x	< 60 seconds	
308	Shift	x		
347 - 485	Drift		x	
370	Shift	x		
418	Fidget	x		
424(426)	Fidget			x
435	Fidget	x		
469	Shift	x		
485	Shift		x	
489 - 613	Drift		x	
498	Shift	x		
506	Shift	x		
535	Fidget	x		
546	Fidget	x		
560	Fidget	x		
613 - 745	Drift		x	
625	Fidget	x		
640	Fidget	x		
648	Fidget	x		
665	Fidget	x		
672	Fidget	x		
705	Shift	x		
717	Shift	x		

Approx. Time	Pattern	Pattern Occur.		
		Man.	Comp.	Both
727	Shift	x		
732	Shift	x		
772	Shift		x	
797	Shift		x	
826	Shift		x	
840	Fidget	x		
851	Shift		x ^D	
855	Shift	x ^D		
887	Shift		x	
925	Shift	x		
930	Fidget	x		
933(934)	Shift			x
937	Fidget	x		
939	Fidget	x		
1070(1072)	Shift			x
1085	Shift	x		
1088	Shift	x		
1093	Fidget	x		
1168	Fidget	x		
1195	Shift	x		
1232	Shift	x		
1239	Fidget	x		
1276	Fidget	x		
1294	Fidget	x		
1300(1301)	Shift			x
1321	Shift	x		
1357(1360)	Fidget			x
1390 - 1485	Drift		x	
1391	Shift	x		
1403	Shift	x		
1482(1485)	Shift			x
1485 - 1568	Drift	x		
1529	Shift	x		
1568(1567)	Shift			x
1571 - 1687	Drift			x ^E
1572 - 1619	Drift		< 60 seconds	x ^E
1627	Shift	x		

Subject	7X
---------	----

Approx. Time (s)	Pattern	Pattern Occur.		
		Man.	Comp.	Both
1680 - 1719	Drift	x	< 60 seconds	
1699	Shift		x	
1765	Shift	x		
1772	Shift	x		
1778	Shift	x		

Approx. Time	Pattern	Pattern Occur.		
		Man.	Comp.	Both

Subject	7Y
---------	----

Approx. Time (s)	Pattern	Pattern Occur.		
		Man.	Comp.	Both
34	Fidget	x		
158 - 214	Drift	x		
213	Shift		x ^A	
218	Shift	x ^A		
220 - 337	Drift			x ^B
243 - 292	Drift			x ^B
337	Shift		x ^C	
341	Shift	x ^C		
341 - 425	Drift		x	
427(425)	Shift			x
428	Fidget		x	
442	Shift	x		
448	Shift	x		
485 - 540	Drift	x		
511	Shift		x	
541	Shift		x	
586	Shift		x	
590 - 643	Drift	x		
630	Shift		x	
648	Fidget	x		
653	Fidget	x		
665	Fidget	x		
683	Fidget	x		
705	Shift	x		
790	Fidget	x		
840(842)	Fidget			x
855	Shift	x		
921	Fidget	x ^D		
925	Fidget		x ^D	
938	Fidget	x		
952	Shift	x		
983	Fidget	x		
1030	Fidget	x		
1047	Fidget	x		
1079	Fidget	x		
1100	Fidget	x		
1107	Fidget	x		

Approx. Time	Pattern	Pattern Occur.		
		Man.	Comp.	Both
1112	Fidget	x		
1126	Shift	x		
1146	Fidget	x		
1171	Shift		x	
1177 - 1240	Drift		x	
1195	Fidget	x		
1226(1229)	Fidget			x
1309	Shift		x	
1313 - 1374	Drift		x	
1314	Shift	x		
1358	Shift	x		
1366	Shift	x		
1505	Shift	x		
1510	Shift	x		
1607	Fidget	x		
1635 - 1723	Drift		x	
1709	Fidget		x	
1720 - 1790	Drift	x		

Subject	8X
---------	----

Approx. Time (s)	Pattern	Pattern Occur.		
		Man.	Comp.	Both
24	Fidget	x		
138	Fidget	x		
157	Shift	x		
194	Shift		x ^A	
197	Fidget	x ^A		
232	Shift	x		
250 - 282	Drift	x	< 60 seconds	
268	Shift		x	
316	Shift		x	
321 - 474	Drift		x	
440	Shift	x		
472(474)	Shift			x
619	Fidget		x	
724	Shift	x ^B		
727	Fidget		x ^B	
733	Shift	x		
795	Shift		x ^C	
800	Shift	x ^C		
801 - 907	Drift		x	
822	Shift	x		
870	Shift	x		
883	Fidget	x		
907	Shift		x	
910 - 1020	Drift			x ^D
911 - 1022	Drift			x ^D
921	Shift	x		
1022(1020)	Shift			x
1073(1071)	Shift			x
1078 - 1140	Drift	x		
1127	Shift		x	
1131 - 1203	Drift		x	
1154	Fidget	x		
1157	Fidget	x ^E		
1160	Fidget		x ^E	
1188	Shift	x		
1297 - 1343	Drift	x	< 60 seconds	
1327	Shift		x	

Approx. Time	Pattern	Pattern Occur.		
		Man.	Comp.	Both
1363	Shift	x		
1366	Shift		x	
1393(1392)	Shift			x
1473(1470)	Shift			x
1490	Shift		x ^F	
1496	Shift	x ^F		
1552	Shift		x ^G	
1556	Shift	x ^G		
1559 - 1672	Drift		x	
1640(1643)	Fidget			x
1671(1672)	Shift			x
1705	Shift	x		
1730(1727)	Shift			x
1743	Shift	x		
1748 - 1784	Drift	x	< 60 seconds	
1766	Shift		x	
1792(1793)	Fidget			x

Subject	8Y
---------	----

Approx. Time (s)	Pattern	Pattern Occur.		
		Man.	Comp.	Both
9	Shift	x		
61(63)	Fidget			x
107	Fidget		x	
141	Fidget		x	
249	Fidget		x	
309(311)	Fidget			x
335(337)	Fidget			x
475	Fidget		x	
512	Fidget	x		
515(514)	Fidget			x
517(516)	Fidget			x
521	Shift	x		
545(546)	Shift			x
548	Fidget		x	
610(610)	Shift			x
632(633)	Shift			x
639 - 760	Drift		x	
658 - 669	4F + 1S	x ^A		
665	Fidget		x ^A	
679	Fidget	x		
746	Fidget	x		
760 - 852	Drift		x	
769	Fidget	x		
775(777)	Fidget			x
812	Fidget			x
816	Fidget	x		
832 - 879	10F	x		
872	Fidget		x	
910	Fidget	x		
959	Fidget		x	
1023(1026)	Fidget			x
1073(1074)	Fidget			x
1101	Fidget	x		
1158	Shift		x	
1163 - 1231	Drift		x	
1164	Shift	x		
1177	Shift	x		

Approx. Time	Pattern	Pattern Occur.		
		Man.	Comp.	Both
1215	Fidget	x		
1233(1231)	Shift			x
1295(1294)	Shift			x
1331	Shift	x		
1361	Shift		x ^B	
1365	Shift	x ^B		
1393(1394)	Fidget			x
1402	Fidget	x ^C		
1406	Fidget		x ^C	
1409	Fidget	x		
1444	Fidget	x		
1465	Fidget	x ^D		
1469	Fidget		x ^D	
1495	Shift		x	
1496	Fidget	x		
1513 - 1594	Drift		x	
1515	Shift	x		
1557	Shift	x		
1570(1572)	Fidget			x
1592(1593)	Fidget			x
1626	Shift	x		
1670	Shift	x ^E		
1672	Fidget		x ^E	
1764	Shift	x		
1792	Fidget		x	

Subject	9X
---------	----

Approx. Time (s)	Pattern	Pattern Occur.		
		Man.	Comp.	Both
15	Shift	x		
27	Shift			x
65	Fidget	x		
91	Shift		x	
137	Shift	x		
160	Shift		x	
165	Shift	x		
166 - 252	Drift		x	
205(208)	Fidget			x
205	Shift	x		
218	Fidget	x		
262	Shift	x		
270	Shift	x		
280 - 323	Drift	x		
300	Shift		x	
323	Shift	x		
330	Shift	x		
370	Shift	x		
413(414)	Fidget			x
483(485)	Shift			x
509(510)	Shift			x
514	Shift	x		
519	Shift	x		
524	Shift	x		
547	Shift	x		
610(608)	Shift			x
613	Shift	x		
628	Shift		x	
643	Shift	x		
650	Shift	x		
656	Shift	x		
666 - 727	Drift	x		
672	Fidget	x		
698	Shift		x	
726	Fidget	x		
729	Fidget	x		
743	Fidget	x ^A		

Approx. Time	Pattern	Pattern Occur.		
		Man.	Comp.	Both
743	Shift	x		
746	Fidget		x ^A	
751	Shift	x		
769	Shift	x		
774 - 781	2 Shifts	x ^B		
777	Fidget		x ^B	
825	Fidget	x ^C		
829	Fidget		x ^C	
848	Shift	x		
857(859)	Fidget			x
886	Shift	x		
891(893)	Fidget			x
913	Fidget	x		
930(929)	Shift			x
938	Shift	x		
956	Shift	x		
970	Fidget	x		
974	Fidget	x		
985	Shift	x		
1000	Fidget	x		
1014	Shift	x		
1019	Shift	x		
1035	Fidget	x		
1044	Fidget	x		
1053	Shift	x		
1069	Shift		x	
1097	Fidget	x		
1101	Fidget		x	
1107	Fidget	x		
1138	Fidget	x		
1148	Shift	x		
1180	Shift	x		
1185	Shift	x		
1192	Shift	x		
1215(1211)	Shift			x
1231(1232)	Shift			x
1245	Shift	x		

Subject	9X cont'd
---------	-----------

Approx. Time (s)	Pattern	Pattern Occur.		
		Man.	Comp.	Both
1265(1263)	Shift			x
1273	Shift	x		
1293	Shift	x		
1323	Shift	x		
1349	Shift	x		
1360	Shift	x		
1367	Shift	x		
1404(1402)	Shift			x
1425(1427)	Shift			x
1429	Fidget		x ^D	
1430	Shift	x ^D		
1456	Fidget	x		
1456	Shift	x		
1460	Shift		x	
1461	Fidget		x	
1485(1487)	Shift			x
1509(1507)	Shift			x
1538	Fidget	x ^E		
1539	Shift		x	
1541	Fidget		x ^E	
1574(1572)	Shift			x
1576	Fidget		x	
1578 - 1663	Drift		x	
1621	Shift	x		
1627	Shift	x ^F		
1628	Fidget		x ^F	
1629 - 1741	Drift	x		
1694	Shift		x	
1743	Shift		x	
1781	Shift	x		
1786	Shift	x		

Approx. Time	Pattern	Pattern Occur.		
		Man.	Comp.	Both

Subject	9Y
---------	----

Approx. Time (s)	Pattern	Pattern Occur.		
		Man.	Comp.	Both
5	Shift	x		
27	Shift	x		
28 - 66	Drift	x	< 60 seconds	
66(68)	Fidget			x
103	Fidget		x	
134	Shift		x	
138	Shift	x		
140 - 314	Drift		x	
166	Shift	x		
218(220)	Fidget			x
234(235)	Fidget			x
261	Shift	x		
266	Shift	x		
355	Fidget		x	
413(414)	Fidget			x
452	Shift	x		
457	Fidget		x	
485(487)	Fidget			x
512(514)	Fidget			x
546	Shift	x		
610	Shift		x	
626	Fidget	x		
650(651)	Fidget			x
729	Fidget	x		
745(746)	Fidget			x
775	Shift	x ^A		
779	Shift	x ^A		
779	Fidget		x ^A	
820(821)	Fidget			x
827(828)	Fidget			x
856(859)	Fidget			x
863 - 948	Drift		x	
892(893)	Fidget			x
896	Fidget	x		
932	Shift	x		
973(974)	Fidget			x
976	Fidget		x	

Approx. Time	Pattern	Pattern Occur.		
		Man.	Comp.	Both
977	Fidget		x	
1000	Fidget	x		
1043	Shift	x		
1053(1050)	Shift			x
1054 - 1140	Drift		x	
1058	Fidget	x		
1071	Shift	x		
1085	Shift	x		
1090	Shift	x		
1138	Shift	x		
1149(1150)	Fidget			x
1171	Shift	x		
1179	Shift	x		
1187	Shift		x ^B	
1192	Shift	x ^B		
1215(1211)	Shift			x
1268	Shift	x ^C		
1270	Fidget		x ^C	
1273	Shift	x ^C		
1284	Shift	x		
1315	Shift	x ^D		
1317	Fidget		x ^D	
1323 - 1362	Drift	x	< 60 seconds	
1425	Shift	x ^E		
1428	Fidget		x ^E	
1430	Shift	x ^E		
1458(1460)	Fidget			x
1529	Fidget		x	
1575(1574)	Shift			x
1616	Shift		x	
1624 - 1692	Drift		x	
1694	Shift		x	
1701	Fidget		x	
1742	Shift		x	
1773(1770)	Shift			x

Subject	10Y
----------------	-----

Approx. Time (s)	Pattern	Pattern Occur.		
		Man.	Comp.	Both
53 - 143	Drift		x	
143 - 227	Drift		x	
321	Fidget		x	
350	Shift	x		
353	Shift	x		
354	Fidget		x	
390 - 545	Drift		x	
404	Shift	x		
520	Shift	x		
533	Fidget		x	
566	Fidget		x	
573(575)	Fidget			x
626	Shift		x	
630 - 770	Drift		x	
759	Fidget		x	
770 - 904	Drift		x	
790	Fidget	x		
803	Fidget		x	
904	Shift		x	
923	Shift	x ^A		
926	Fidget		x ^A	
973	Shift			x
1078	Shift	x		
1098	Shift		x	
1104 - 1173	Drift		x	
1137	Shift	x		
1142	Shift	x		
1166	Shift	x ^B		
1171	Fidget		x ^B	
1172	Shift	x ^B		
1243	Fidget		x	
1334	Fidget		x	
1362	Shift		x	
1375	Fidget		x	
1376 - 1443	Drift		x	
1416	Shift	x		
1420	Shift	x		

Approx. Time	Pattern	Pattern Occur.		
		Man.	Comp.	Both
1426	Shift	x		
1432	Shift	x		
1450	Shift	x		
1467	Fidget		x	
1486	Shift		x	
1548	Shift	x ^C		
1551	Fidget		x ^C	
1552	Shift	x ^C		
1650	Fidget	x ^D		
1650	Shift		x	
1652	Fidget		x ^D	
1678	Shift		x	
1719	Shift	x		
1722	Shift	x		
1748	Shift		x ^E	
1752	Shift	x ^E		
1769	Shift		x	

Subject	11X
----------------	-----

Approx.	Pattern	Pattern Occur.		
		Man.	Comp.	Both
62	Fidget	x		
147	Shift	x		
160	Fidget	x		
160 - 259	Drift		x	
232	Shift	x		
284	Fidget	x		
411(413)	Fidget			x
451	Shift	x		
565	Shift	x		
597	Shift	x		
641	Fidget		x	
683	Fidget	x ^A		
685	Shift		x	
687	Fidget		x ^A	
726	Shift	x		
757(759)	Fidget			x
800	Shift		x	
831	Fidget		x	
832	Fidget		x	
909	Shift		x	
912(913)	Fidget			x
945	Fidget	x		
959	Fidget		x	
962	Fidget		x	
1001	Fidget	x		
1026 - 1067	Drift	x	< 60 seconds	
1041	Shift		x	
1081	Shift		x	
1087 - 1151	Drift		x	
1103	Shift	x		
1103	Fidget	x		
1117	Shift	x		
1164	Fidget	x		
1173	Fidget	x		
1175(1178)	Fidget			x
1186	Shift	x		
1272	Fidget		x	

Approx.	Pattern	Pattern Occur.		
		Man.	Comp.	Both
1285	Shift	x		
1296	Shift	x		
1325	Shift	x		
1350(1347)	Shift			x
1358	Shift	x		
1371(1372)	Shift			x
1387	Shift	x		
1412	Shift		x ^B	
1416	Shift	x ^B		
1416	Fidget	x		
1463	Fidget	x ^C		
1467	Fidget		x ^C	
1499	Shift	x		
1513	Fidget	x		
1548	Fidget	x		
1588(1587)	Shift			x
1608	Shift		x	
1641	Fidget	x ^D		
1642(1641)	Shift			x
1645	Fidget		x ^D	
1665	Shift		x	
1670 - 1741	Drift		x	
1712	Shift	x		
1737	Fidget	x		
1742	Fidget		x	
1775	Shift	x		
1794	Fidget	x		

Subject	11Y
---------	-----

Approx. Time (s)	Pattern	Pattern Occur.		
		Man.	Comp.	Both
31	Fidget		x	
41	Fidget		x	
97	Fidget		x	
152(153)	Fidget			x
159	Fidget	x		
190	Fidget		x	
223(222)	Fidget			x
224	Fidget		x	
266	Shift	x		
273	Shift	x		
310(311)	Fidget			x
316(317)	Fidget			x
508	Fidget		x	
509	Fidget		x	
573	Fidget		x	
639(640)	Fidget			x
682	Fidget		x	
684	Fidget		x	
726	Shift	x		
759	Fidget		x	
808	Fidget		x	
824	Shift		x	
985	Shift	x		
1046	Shift		x	
1070(1072)	Fidget			x
1120	Shift		x	
1158	Fidget			x
1161(1160)	Fidget			x
1163	Fidget		x	
1201(1198)	Shift			x
1201(1203)	Fidget			x
1352	Shift		x	
1371(1375)	Fidget			x
1376(1378)	Fidget			x
1532	Shift	x ^A		
1533	Fidget		x ^A	
1564	Shift		x	

Approx. Time	Pattern	Pattern Occur.		
		Man.	Comp.	Both
1573 - 1666	Drift		x	
1590	Fidget	x		
1643(1646)	Fidget			x
1664(1666)	Shift			x
1691	Fidget	x		
1722	Fidget	x		
1730(1732)	Fidget			x
1741(1742)	Fidget			x

Subject	12X
---------	-----

Approx. Time (s)	Pattern	Pattern Occur.		
		Man.	Comp.	Both
45	Shift	x		
53	Shift	x		
61	Shift		x	
66 - 146	Drift		x	
93	Fidget	x		
101	Shift	x		
115	Fidget	x		
146	Shift			x
178	Shift		x	
211(215)	Fidget			x
427 - 513	Drift		x	
434(437)	Fidget			x
513 - 579	Drift		x	
559	Shift	x		
577	Fidget	x		
579 - 658	Drift		x	
591	Fidget	x		
673	Shift	x		
678	Shift	x		
682	Shift	x		
706(708)	Shift			x
803 - 967	Drift		x	
906	Fidget		x	
967	Shift		x ^A	
971	Shift	x ^A		
1017	Fidget	x		
1023	Fidget	x ^B		
1027	Fidget		x ^B	
1064	Fidget		x	
1115	Fidget		x	
1118	Fidget		x	
1151	Fidget	x		
1209	Fidget	x		
1232	Fidget	x ^C		
1237	Fidget		x ^C	
1286	Shift		x ^D	
1290	Shift	x ^D		

Approx. Time	Pattern	Pattern Occur.		
		Man.	Comp.	Both
1304	Shift	x		
1310	Shift	x		
1344 - 1460	Drift		x	
1392	Shift	x		
1403	Fidget	x		
1405	Fidget	x		
1536	Shift	x ^E		
1538	Fidget		x ^E	
1583	Shift		x ^F	
1587	Shift	x ^F		
1605(1607)	Fidget			x
1651	Shift	x		
1672	Shift		x	
1700	Shift		x	
1762	Fidget	x		
1795	Fidget	x		

Subject	12Y
---------	-----

Approx. Time (s)	Pattern	Pattern Occur.		
		Man.	Comp.	Both
18	Fidget	x		
23	Fidget		x	
45	Shift	x		
53	Fidget	x		
55	Fidget	x ^A		
61	Fidget		x ^A	
76	Fidget	x		
111	Fidget		x	
148	Fidget		x	
151	Fidget		x	
200 - 291	Drift		x	
209	Fidget	x ^B		
213	Fidget		x ^B	
291 - 406	Drift		x	
306	Fidget		x	
423	Shift	x ^C		
428	Shift	x ^C		
428	Fidget		x ^C	
542	Shift	x		
548	Shift	x		
587	Fidget	x		
679	Fidget		x	
785	Shift	x		
786 - 826	Drift	x	< 60 seconds	
881	Fidget		x	
982	Fidget	x ^D		
986	Fidget		x ^D	
1149	Shift	x ^E		
1150	Fidget		x ^E	
1211	Shift	x		
1220	Shift	x		
1303	Shift	x		
1392(1394)	Fidget			x
1490	Fidget		x	
1494	Fidget		x	
1534	Fidget		x	

Approx. Time	Pattern	Pattern Occur.		
		Man.	Comp.	Both

Subject	13X
---------	-----

Approx. Time (s)	Pattern	Pattern Occur.		
		Man.	Comp.	Both
34	Fidget	x		
67	Shift	x		
76	Fidget	x ^A		
80	Fidget		x ^A	
135	Fidget	x		
156	Fidget	x		
170	Fidget	x		
173(170)	Shift			x
190	Shift		x	
227	Fidget	x		
231(233)	Shift			x
241	Shift	x		
264(262)	Shift			x
280(285)	Fidget			x
284	Shift	x		
328	Fidget	x		
329	Shift		x	
356(357)	Shift			x
395(393)	Shift			x
398 - 462	Drift		x	
462	Shift		x	
497(498)	Shift			x
501	Shift	x ^B		
501	Fidget		x ^B	
569	Fidget	x		
574(575)	Shift			x
621(620)	Shift			x
621	Fidget	x		
656	Shift		x ^C	
660	Shift	x ^C		
661 - 739	Drift		x	
677	Shift	x		
739	Shift		x	
781	Shift		x	
816	Shift	x		
816	Fidget	x		
820	Shift		x	

Approx. Time	Pattern	Pattern Occur.		
		Man.	Comp.	Both
826 - 865	Drift	x	< 60 seconds	
852	Shift		x	
901	Shift		x	
917	Shift	x		
929	Shift	x		
929(932)	Fidget			x
977(978)	Shift			x
1040	Shift	x		
1048	Shift	x		
1072	Shift		x	
1093	Shift		x	
1114	Shift	x		
1123(1121)	Shift			x
1123	Fidget	x		
1154	Shift		x ^D	
1159	Shift	x ^D		
1175	Shift		x ^E	
1179	Shift	x ^E		
1200	Shift			x
1266	Shift		x	
1321(1318)	Shift			x
1345(1346)	Shift			x
1436(1438)	Fidget			x
1460(1461)	Shift			x
1545(1541)	Shift			x
1595	Shift		x	
1629	Fidget	x		
1632(1633)	Shift			x
1639	Shift	x		
1640 - 1713	Drift		x	
1713	Shift		x	
1718 - 1800	Drift		x	
1742(1746)	Fidget			x

Subject	14X
---------	-----

Approx. Time (s)	Pattern	Pattern Occur.		
		Man.	Comp.	Both
7	Fidget	x		
37	Shift	x		
41	Shift	x		
46 - 135	Drift		x	
63	Shift	x		
68	Shift	x		
76	Shift	x		
93	Shift	x		
103	Shift	x		
114(116)	Fidget			x
177	Fidget		x	
216(219)	Shift			x
224 - 291	Drift		x	
250	Shift	x		
255	Fidget		x	
265 - 329	Drift	x		
332	Fidget		x	
366	Shift		x	
400(399)	Shift			x
405 - 512	Drift		x	
407	Fidget		x	
512	Shift		x ^A	
517	Shift	x ^A		
562	Shift			x
567	Fidget	x		
587 - 661	Drift		x	
731(729)	Shift			x
738 - 772	Drift	x	< 60 seconds	
773(770)	Shift			x
790	Fidget	x		
792(791)	Shift			x
821	Fidget	x		
822	Shift		x	
828 - 861	Drift	x	< 60 seconds	
862(860)	Shift			x
908(906)	Shift			x
931	Shift	x		

Approx. Time	Pattern	Pattern Occur.		
		Man.	Comp.	Both
933	Shift	x		
971	Shift		x	
993	Fidget	x		
993	Shift		x ^B	
997	Shift	x ^B		
1000	Fidget		x	
1026	Fidget	x		
1086	Shift		x	
1090	Fidget		x	
1094(1095)	Fidget			x
1130(1127)	Shift			x
1132 - 1279	Drift		x	
1423	Fidget	x		
1433(1430)	Shift			x
1454	Shift		x	
1479	Shift		x	
1512(1509)	Shift			x
1527(1529)	Shift			x
1565(1566)	Shift			x
1602	Fidget	x		
1605	Shift	x		
1624(1621)	Shift			x
1639(1641)	Shift			x
1664	Shift		x	
1782(1785)	Fidget			x

Subject	14Y
---------	-----

Approx. Time (s)	Pattern	Pattern Occur.		
		Man.	Comp.	Both
5	Fidget	x		
13	Shift	x		
27(30)	Shift			x
80	Fidget	x		
85	Fidget	x		
92(94)	Fidget			x
115	Shift		x	
142	Shift	x		
153	Shift	x		
253	Fidget		x	
299	Shift		x	
306 - 352	Drift	x		
325	Shift		x	
370	Shift		x	
401	Fidget	x		
403	Fidget	x		
405	Shift	x		
420	Shift		x	
472	Shift		x	
515(518)	Fidget			x
528 - 576	Drift	x		
542	Shift		x	
575	Fidget	x		
772(775)	Shift			x
792	Shift	x		
809(808)	Shift			x
821	Fidget	x		
862(865)	Fidget			x
862	Shift		x	
878 - 971	Drift		x	
906	Shift	x		
916	Fidget	x		
957	Fidget		x	
971	Shift		x	
993	Shift		x	
1037	Shift	x		
1063	Shift	x		

Approx. Time	Pattern	Pattern Occur.		
		Man.	Comp.	Both
1063	Fidget	x		
1085(1087)	Fidget			x ^A
1090	Fidget		x ^A	
1091(1092)	Fidget			x
1105(1107)	Shift			x
1148 - 1260	Drift	x		
1204	Shift		x	
1239	Shift		x	
1314	Shift		x	
1378	Shift		x	
1422(1425)	Fidget			x
1457(1460)	Fidget			x
1457	Shift	x		
1468	Shift	x		
1486	Shift		x	
1510	Shift	x		
1510(1513)	Fidget			x
1567	Shift		x	
1571 - 1714	Drift		x	
1609	Fidget		x	
1637(1639)	Fidget			x
1727	Fidget		x	
1751	Shift	x		
1766	Fidget		x	

Notes: Comparison of Manual/Computer Pattern Findings

Patterns identified by times.

1X

75 – Questionable pattern identification

126 – Easily identifiable manually but wasn't included in manual identification

153 – Both patterns (fidget and shift) are present, manually the fidget was identified, the program identified the shift

720 – Computer identifies a shift and none can be seen on the plot

774 – Computer identifies a shift and none can be seen on the plot

968 – Computer identifies a shift and none can be seen on the plot

1203 – Computer identifies a shift and none can be seen on the plot

1446 – Computer identifies a shift and none can be seen on the plot

1694 – Computer identifies a shift and none can be seen on the plot

1Y

43 – Questionable pattern identification

155 – Computer identifies a shift and none can be seen on the plot

2X

33 – Computer identifies a shift and none can be seen on the plot

83 – Computer identifies a shift and none can be seen on the plot

472 – Computer identifies a shift and none can be seen on the plot

640 – Computer identifies a shift and none can be seen on the plot

1524 and 1529 – What I have identified as two shifts, has been identified by the program as a fidget

1778 – Computer identifies a shift and none can be seen on the plot

2Y

31 – Computer identifies a shift and none can be seen on the plot

483 – Computer identifies a shift and none can be seen on the plot

3X

139 – Computer identifies a shift but none can be seen on the plot

233 and 238 – May be the same pattern as identified manually, perhaps a mistake on my part

288 and 291 – Identified as different pattern types, manual and computer, but it is the same pattern

693 – No shift at this time, but there is a fidget 698 which may be a factor

1256 – Computer identifies a shift but none can be seen on the plot

3Y

311 and 313 – Essentially the same pattern, although classified differently
364 and 367 – Essentially the same pattern, although classified differently
420 – Computer identifies a shift but none can be seen on the plot
649 – Computer identifies a shift but none can be seen on the plot
669 – Computer identifies a shift but none can be seen on the plot
796 and 800 – Essentially the same pattern, although classified differently
1034 – Not much of a shift seen
1067 and 1070 – Essentially the same pattern, although classified differently
1107, 1110, and 1111 – Essentially the same pattern, although classified differently
1128 – Computer identifies a shift but none can be seen on the plot
1238 – Computer identifies a shift but none can be seen on the plot
1281 and 1285 – Essentially the same pattern, although classified differently
1300 – Computer identifies a shift but none can be seen on the plot
1430 – Not much of a shift seen
1510 – Computer identifies a shift but none can be seen on the plot
1562 and 1567 – Essentially the same pattern, although classified differently
1591 – Computer identifies a shift but none can be seen on the plot
1742 and 1745 – Essentially the same pattern, although identified differently

6X

1252 – Computer identifies a shift but none can be seen on the plot

6Y

596 – Filtered data does not show a fidget as was identified by the computer program
817 and 820 – Essentially the same pattern, although classified differently
1030 – Computer identifies a fidget but none can be seen on the plot
1254 – Computer identifies a shift but none can be seen on the plot
192 + 196 = 193 – Program probably only recognizes this as one shift

7X

237 and 241 – Essentially the same pattern although classified differently.

7Y

Nothing to report

8X

194 and 197 – Essentially the same pattern, although classified differently
268 – Not much of a shift visible on the plot (computer)

724 and 727 – Essentially the same pattern, although classified differently
1327 – Not much of a shift visible on the plot (computer)

8Y

658 to 669 + 665 – Predominant fidget is at 665 (which computer identified as did I)
832 to 879 + 872 – I picked out 10 fidgets, one of which the computer identified at 872
1670 and 1628 – Essentially the same pattern, although classified differently

9X

300 – Computer identifies a shift but none can be seen on the plot
774, 777, and 781 – Essentially the same pattern, although classified differently
1429 and 1430 – Essentially the same pattern, although classified differently
1627 and 1628 – Essentially the same pattern, although classified differently

9Y

775, 779 and 779 – Essentially the same pattern, although classified differently
1268, 1270 and 1273 – Essentially the same pattern, although classified differently
1315 and 1317 – Essentially the same pattern, although classified differently
1425, 1428 and 1430 – Essentially the same pattern, although classified differently
1616 – Computer identifies a shift but none can be seen on the plot
1742 – Computer identifies a shift but none can be seen on the plot

10X

519 and 520 – Essentially the same pattern, although classified differently
1007, 1010, and 1012 – Essentially the same pattern, although classified differently
1547 and 1553 – Essentially the same pattern, although classified differently
1719, 1720 and 1723 – Essentially the same pattern, although classified differently

10Y

904 – Computer identifies a shift but none can be seen on the plot
923 and 926 – Essentially the same pattern, although classified differently
1166, 1171, and 1172 – Essentially the same pattern although classified differently
1362 – Computer identifies a shift, but none can be seen on the plot
1548, 1551 and 1552 – Essentially the same pattern, although classified differently

11X

800 – Computer identifies a shift but none can be seen on the plot
909 – Computer identifies a shift but none can be seen on the plot

11Y

31, 41 and 97 – Computer identifies 3 separate fidgets, however filtered data does not show them to a great extent (this could be due to scaling of the plot)
682 and 684 – Computer identifies 2 fidgets, but they cannot be seen on the plot
824 – Computer identifies a shift but none can be seen on the plot
1046 – Computer identifies a shift but none can be seen on the plot
1120 – Computer identifies a shift but none can be seen on the plot
1532 and 1533 – Essentially the same pattern, although classified differently

12X

1536 and 1538 – Essentially the same pattern, although classified differently

12Y

881 – Computer identifies a fidget but none can be seen on the plot
423, 428, and 428 – Essentially the same pattern, although classified differently
1149 and 1150 – Essentially the same pattern although classified differently

13X

501 – Essentially the same pattern, although classified differently
739 – Computer identifies a shift but none can be seen on the plot
852 – Computer identifies a shift but none can be seen on the plot
1595 – Computer identifies a shift but none can be seen on the plot

13Y

None

14X

1086 and 1090 – Essentially the same pattern, although classified differently

14Y

542 – Computer identifies a shift but none can be seen on the plot
862 – Computer identifies a shift but none can be seen on the plot
993 – Computer identifies a shift but none can be seen on the plot
1085, 1087, and 1090 – Classified manually as 1 fidget, as 2 fidgets by computer
1204, 1239, 1314 and 1375 – Computer identifies shifts, but none are seen on the plot

APPENDIX D – Identified Pattern Totals

The following appendix contains tables with tabulated results of the patterns found in both the manual and computer identification processes.

Subject 1							
Direction: X	Pattern Occurrences			Direction: Y	Pattern Occurrences		
	Shifts	Fidgets	Drifts		Shifts	Fidgets	Drifts
Manual - 1st order	3	1	3	Manual - 1st order	1	4	1
Manual - 2nd order	14	6	3	Manual - 2nd order	5	7	2
Manual - 3rd order	17	7	3	Manual - 3rd order	13	8	2
Manual - 4th order	25	13	3	Manual - 4th order	14	10	2
Computer - inclusive	12	6	10	Computer - inclusive	6	8	3

Subject 2							
Direction: X	Pattern Occurrences			Direction: Y	Pattern Occurrences		
	Shifts	Fidgets	Drifts		Shifts	Fidgets	Drifts
Manual - 1st order	1	0	3	Manual - 1st order	0	0	2
Manual - 2nd order	6	1	5	Manual - 2nd order	0	0	4
Manual - 3rd order	23	3	5	Manual - 3rd order	10	3	4
Manual - 4th order	23	3	5	Manual - 4th order	10	4	4
Computer - inclusive	20	12	7	Computer - inclusive	13	12	5

Subject 3							
Direction: X	Pattern Occurrences			Direction: Y	Pattern Occurrences		
	Shifts	Fidgets	Drifts		Shifts	Fidgets	Drifts
Manual - 1st order	1	1	2	Manual - 1st order	0	2	1
Manual - 2nd order	6	6	3	Manual - 2nd order	9	5	7
Manual - 3rd order	23	15	3	Manual - 3rd order	19	8	7
Manual - 4th order	30	19	3	Manual - 4th order	32	17	7
Computer - inclusive	15	14	5	Computer - inclusive	22	15	3

Subject 6				Subject 6			
Direction: X	Pattern Occurrences			Direction: Y	Pattern Occurrences		
	Shifts	Fidgets	Drifts		Shifts	Fidgets	Drifts
Manual - 1st order	0	0	1	Manual - 1st order	0	0	0
Manual - 2nd order	0	0	1	Manual - 2nd order	2	1	1
Manual - 3rd order	3	1	1	Manual - 3rd order	8	2	1
Manual - 4th order	6	1	1	Manual - 4th order	9	3	1
Computer - inclusive	11	2	6	Computer - inclusive	1	18	3

Subject 7				Subject 7			
Direction: X	Pattern Occurrences			Direction: Y	Pattern Occurrences		
	Shifts	Fidgets	Drifts		Shifts	Fidgets	Drifts
Manual - 1st order	4	2	1	Manual - 1st order	0	0	1
Manual - 2nd order	21	8	6	Manual - 2nd order	6	9	5
Manual - 3rd order	34	15	6	Manual - 3rd order	9	13	5
Manual - 4th order	38	22	6	Manual - 4th order	14	20	5
Computer - inclusive	15	3	6	Computer - inclusive	9	5	5

Subject 8				Subject 8			
Direction: X	Pattern Occurrences			Direction: Y	Pattern Occurrences		
	Shifts	Fidgets	Drifts		Shifts	Fidgets	Drifts
Manual - 1st order	1	0	2	Manual - 1st order	0	2	0
Manual - 2nd order	7	2	5	Manual - 2nd order	6	13	0
Manual - 3rd order	17	3	5	Manual - 3rd order	12	22	0
Manual - 4th order	22	8	5	Manual - 4th order	17	40	0
Computer - inclusive	18	5	5	Computer - inclusive	9	24	4

Subject 9				Subject 9			
Direction: X	Occurrences			Direction: Y	Pattern Occurrences		
	Shifts	Fidgets	Drifts		Shifts	Fidgets	Drifts
Manual - 1st order	14	6	2	Manual - 1st order	8	4	0
Manual - 2nd order	31	17	3	Manual - 2nd order	18	13	2
Manual - 3rd order	40	19	3	Manual - 3rd order	26	17	2
Manual - 4th order	60	23	3	Manual - 4th order	31	20	2
Computer - inclusive	23	13	2	Computer - inclusive	10	26	4

Subject 10				Subject 10			
Direction: X	Pattern Occurrences			Direction: Y	Pattern Occurrences		
	Shifts	Fidgets	Drifts		Shifts	Fidgets	Drifts
Manual - 1st order	0	0	1	Manual - 1st order	0	0	0
Manual - 2nd order	6	4	2	Manual - 2nd order	2	0	0
Manual - 3rd order	11	4	2	Manual - 3rd order	12	2	0
Manual - 4th order	24	5	2	Manual - 4th order	21	3	0
Computer - inclusive	7	14	3	Computer - inclusive	10	15	7

Subject 11				Subject 11			
Direction: X	Pattern Occurrences			Direction: Y	Pattern Occurrences		
	Shifts	Fidgets	Drifts		Shifts	Fidgets	Drifts
Manual - 1st order	4	2	0	Manual - 1st order	0	4	0
Manual - 2nd order	8	5	1	Manual - 2nd order	2	11	0
Manual - 3rd order	17	13	1	Manual - 3rd order	6	15	0
Manual - 4th order	22	21	1	Manual - 4th order	7	18	0
Computer - inclusive	12	14	3	Computer - inclusive	7	28	1

Subject 12				Subject 12			
Direction: X	Pattern Occurrences			Direction: Y	Pattern Occurrences		
	Shifts	Fidgets	Drifts		Shifts	Fidgets	Drifts
Manual - 1st order	6	4	0	Manual - 1st order	0	1	0
Manual - 2nd order	7	10	0	Manual - 2nd order	8	5	1
Manual - 3rd order	10	12	0	Manual - 3rd order	9	7	1
Manual - 4th order	17	16	0	Manual - 4th order	10	8	1
Computer - inclusive	9	10	7	Computer - inclusive	0	16	3

Subject 13				Subject 13			
Direction: X	Pattern Occurrences			Direction: Y	Pattern Occurrences		
	Shifts	Fidgets	Drifts		Shifts	Fidgets	Drifts
Manual - 1st order	2	2	0	Manual - 1st order	0	0	1
Manual - 2nd order	19	8	1	Manual - 2nd order	0	5	2
Manual - 3rd order	25	10	1	Manual - 3rd order	5	12	2
Manual - 4th order	31	16	1	Manual - 4th order	5	14	2
Computer - inclusive	32	6	4	Computer - inclusive	13	18	7

Subject 14				Subject 14			
Direction: X	Pattern Occurrences			Direction: Y	Pattern Occurrences		
	Shifts	Fidgets	Drifts		Shifts	Fidgets	Drifts
Manual - 1st order	11	1	1	Manual - 1st order	0	1	1
Manual - 2nd order	20	7	3	Manual - 2nd order	7	5	3
Manual - 3rd order	22	11	3	Manual - 3rd order	12	13	3
Manual - 4th order	28	11	3	Manual - 4th order	16	18	3
Computer - inclusive	24	9	5	Computer - inclusive	20	15	2

APPENDIX E – Parameter Tuning Data

The following appendix contains example tables that contain the results of the parameter tuning for the computer identification software. The numerical values underneath the shift height and to the right of the window length are the number of identified patterns for the given parameters.

Subject 1	COP X	Pattern: Shift				
		Shift Height in SD				
Window Length (s)		1.0	1.5	2.0	2.5	3.0
15		33	20	12	6	3
30		16	12	9	3	1
60		10	4	3	3	2
Subject 1	COP Y	Pattern: Shift				
		Shift Height in SD				
Window Length (s)		1.0	1.5	2.0	2.5	3.0
15		27	16	6	4	4
30		11	5	3	3	2
60		4	3	2	2	1

Subject 7	COP X	Pattern: Shift				
		Shift Height in SD				
Window Length (s)		1.0	1.5	2.0	2.5	3.0
15		33	22	15	9	5
30		15	6	4	2	1
60		9	2	2	2	1
Subject 7	COP Y	Pattern: Shift				
		Shift Height in SD				
Window Length (s)		1.0	1.5	2.0	2.5	3.0
15		26	12	9	3	2
30		14	8	4	1	0
60		5	5	3	2	0

Subject 10	COP X	Pattern: Shift				
			Shift Height in SD			
Window Length (s)	1.0	1.5	2.0	2.5	3.0	
15	31	19	7	6	5	
30	14	9	3	2	1	
60	7	4	2	2	2	
Subject 10	COP Y	Pattern: Shift				
			Shift Height in SD			
Window Length (s)	1.0	1.5	2.0	2.5	3.0	
15	31	16	10	5	5	
30	9	3	0	0	0	
60	2	0	0	0	0	

Subject 13	COP X	Pattern: Shift				
			Shift Height in SD			
Window Length (s)	1.0	1.5	2.0	2.5	3.0	
15	42	40	32	28	22	
30	21	18	18	11	9	
60	10	8	7	6	4	
Subject 13	COP Y	Pattern: Shift				
			Shift Height in SD			
Window Length (s)	1.0	1.5	2.0	2.5	3.0	
15	30	22	13	6	2	
30	15	10	7	2	1	
60	10	5	3	1	1	

Subject 1	COP X	Pattern: Fidgets				
		Fidget Height in SD				
Window Length (s)	1.0	2.0	2.5	3.0	3.5	4.0
30	10	7	7	4	0	0
60	9	6	6	6	5	3
120	10	6	6	6	5	5
180	10	6	6	6	5	5
Subject 1	COP Y	Pattern: Fidgets				
		Fidget Height in SD				
Window Length (s)	1.0	2.0	2.5	3.0	3.5	4.0
30	18	11	9	7	6	3
60	17	10	9	8	7	6
120	20	11	10	7	6	5
180	19	10	10	6	6	4

Subject 7	COP X	Pattern: Fidgets				
		Fidget Height in SD				
Window Length (s)	1.0	2.0	2.5	3.0	3.5	4.0
30	43	14	8	1	1	0
60	46	14	6	3	2	0
120	34	10	7	5	2	1
180	35	11	7	4	4	1
Subject 7	COP Y	Pattern: Fidgets				
		Fidget Height in SD				
Window Length (s)	1.0	2.0	2.5	3.0	3.5	4.0
30	55	29	14	5	1	0
60	51	25	12	5	2	0
120	69	28	16	6	2	0
180	60	22	12	4	1	0

Subject 10	COP X	Pattern: Fidgets				
		Fidget Height in SD				
Window Length (s)	1.0	2.0	2.5	3.0	3.5	4.0
30	71	37	19	10	5	4
60	67	37	24	14	6	5
120	72	35	25	17	11	5
180	68	32	18	12	8	6
Subject 10	COP Y	Pattern: Fidgets				
		Fidget Height in SD				
Window Length (s)	1.0	2.0	2.5	3.0	3.5	4.0
30	153	60	32	18	7	1
60	158	56	34	15	10	8
120	171	64	33	14	6	5
180	167	57	33	14	8	5

Subject 13	COP X	Pattern: Fidgets				
		Fidget Height in SD				
Window Length (s)	1.0	2.0	2.5	3.0	3.5	4.0
30	34	13	10	5	3	0
60	28	12	9	6	4	2
120	22	13	9	7	6	4
180	21	14	11	5	4	4
Subject 13	COP Y	Pattern: Fidgets				
		Fidget Height in SD				
Window Length (s)	1.0	2.0	2.5	3.0	3.5	4.0
30	87	38	28	20	12	6
60	85	44	29	18	13	11
120	82	42	31	20	14	10
180	78	41	25	19	13	10

APPENDIX F – Volunteer Consent Form

I, _____, hereby agree, freely and voluntarily, to participate in the research project entitled “Center of Pressure Migration During Prolonged Unconstrained Sitting” to be directed by Jason Lusk. The research will be conducted at the University of Manitoba.

I understand that participation is entirely voluntary and that there will be no compensation provided to those who volunteer. I have also been informed of any potential risks associated with participation in this research.

I have been assured by the investigator that all records will be kept confidential and access to this information will be limited to only those researchers who are involved with this study. Any release of information that would reveal my identity will only be done after written consent has been provided by me.

Participant Date

Witness Date

I have explained in detail the study procedures which have been consented to by the above participant.

Researcher Date