

THE UNIVERSITY OF MANITOBA

**STUDIES ON THE SORPTION
OF COBALT THIOCYANATE
BY POLYURETHANE**

by

Richard Frank Hamon

A thesis submitted to the Faculty of Graduate Studies in
partial fulfillment of the requirements for the degree of

Doctor of Philosophy

Chemistry Department

Winnipeg, Manitoba

October, 1980

STUDIES ON THE SORPTION
OF COBALT THIOCYANATE
BY POLYURETHANE

BY

RICHARD FRANK HAMON

A thesis submitted to the Faculty of Graduate Studies of
the University of Manitoba in partial fulfillment of the requirements
of the degree of

DOCTOR OF PHILOSOPHY

© 1980

Permission has been granted to the LIBRARY OF THE UNIVER-
SITY OF MANITOBA to lend or sell copies of this thesis, to
the NATIONAL LIBRARY OF CANADA to microfilm this
thesis and to lend or sell copies of the film, and UNIVERSITY
MICROFILMS to publish an abstract of this thesis.

The author reserves other publication rights, and neither the
thesis nor extensive extracts from it may be printed or other-
wise reproduced without the author's written permission.

Dedicated to
Tracy and Scott

The Thesis

There is a thing which people write
Which fills them all with awful fright
And keeps them up for half the night
For years and years and years.

They stuff themselves into a nook
And put it all into a book
So only five will come and look
For years and years and years.

R. Hamon

ACKNOWLEDGEMENTS

In both the investigation and reporting phases of this work, a long list of people were instrumental in helping to make it a reality. Collectively, their contributions to the effort rival my own in the final analysis and I would like now to express my sincere thanks to to them all.

At the head of the list, I must place my wife, Connie, who had to tolerate my frequent absences and endure my often erratic behaviour during the endless time it took to complete. In addition, she unflinchingly accepted the mammoth and usually thankless task of typing and retyping this volume. Clearly, without her help and support it could never have reached conclusion and I cannot express in words my unending gratitude to her.

Included also prominently in the list of people to whom I am indebted is my supervisor, Dr. Art Chow, whose guidance, frequent encouragement, kindness and infinite patience have been inspiring. Special thanks are also due to Dr. H. D. Gesser whose interest, freely given suggestions and frequently loaned materials have been of incalculable value. I would also like to acknowledge the unquestionable contributions of my current labmates, Anjum S. Khan and Sargon J. Al-Bazi, with whom many stimulating discussions have helped me to formulate a number of important concepts, chemical and otherwise.

Many others within and without of the University community have also made both direct and indirect contributions to the completion of this work. Regretfully, they are far too numerous to name but are no less appreciated. Of these many, however, I would like especially to thank the glassblowers, Howard Griffiths and Bryn Easterbrook, and the staff of the Central Instrument Service whose mastery produced much of the necessary equipment.

Many thanks are also due to the National Research Council of Canada and to the University of Manitoba for financial assistance. I am also indebted to the Office of Industrial Research for very generously allowing me to take the necessary time from my work to complete this volume.

Rich Hamon

TABLE OF CONTENTS

ACKNOWLEDGEMENTS	vi
LIST OF TABLES	xii
LIST OF FIGURES	xiv
ABSTRACT	xvi

CHAPTER I. GENERAL INTRODUCTION

A. POLYURETHANES -- CHEMISTRY AND USES	1
1. Historical Development	1
2. Definition of Polyurethane	2
3. Isocyanates	3
4. Major Ingredients in Polyurethanes	5
a. Diisocyanates	5
b. Polyols	6
5. Polyurethane Production	8
6. Types and Applications of Polyurethanes	10
a. Foams	10
b. Elastomers	14
c. Coatings	15
d. Adhesives	15
e. Fibers	16
B. APPLICATIONS OF POLYURETHANES TO CHEMICAL EXTRACTION AND SEPARATION - A REVIEW	18
1. Flexible Foams	19
a. Unmodified Flexible Foams	19
1) Sorption from Gases	
2) Sorption from Liquids	
b. Loaded Flexible Foams	40
1) Sorption from Gases	
2) Sorption from Liquids	
c. Chemically Modified Flexible Foams	58

2.	Polyurethane Membranes	62
	a. Sorption from Gases	62
	b. Sorption from Liquids	63
3.	Open-Pore Polyurethane	65

CHAPTER II. THE EXTRACTION OF COBALT FROM
AQUEOUS THIOCYANATE SOLUTIONS
BY POLYURETHANE FOAM

	A. INTRODUCTION	72
1.	The Discovery	72
2.	The Chemistry of the Thiocyanate Ion	74
	a. Occurrence and Preparation	74
	b. Structure	75
	c. Reaction of the Thiocyanate Ion	76
	1) Protonation	
	2) Hydrolysis and Polymerization	
	3) Oxidation of SCN^-	
	4) Coordination with Metal Ions	
	d. Analysis of SCN^-	80
	e. Properties and Uses	82
3.	The Chemistry of Cobalt	84
	a. Occurrence	84
	b. Properties and Uses	84
	c. Simple Compounds	86
	1) Acetates	
	2) Carbonates	
	3) Carbonyls	
	4) Halides	
	5) Hydroxides	
	6) Nitrates	
	7) Oxalates	
	8) Oxides	
	9) Phosphates	
	10) Sulfates	
	11) Sulfides	
	d. Color Changes of Cobalt Compounds	90
	e. Complexes of Co(II) , d^7	91
	1) Complex Halides	
	2) Complex thiocyanates and isothiocyanates	
	3) Complex cyanide	
	4) Complex nitrates	
	5) Complexes with oxygen and sulphur ligands	
	6) Complexes with nitrogen, phosphorus and arsenic ligands	
	7) Cationic complexes	

f. Complexes of Cobalt(III), d^6	95
1) Complex Ammines	
2) Complex Cyanides	
3) Carbonato Complexes	
4) Carboxylato Complexes	
4. Possible Mechanisms of Polyurethane Foam Extraction	99
a. Solvent Extraction	100
b. Metal Ion Complexation or Ligand Exchange	101
c. Strong and Weak Base Anion Exchange	103
d. Cation Chelation Mechanism (CCM)	104
B. EXPERIMENTAL	
1. Apparatus and Reagents	108
a. Commercially Obtained Apparatus	108
b. Custom Made Apparatus	110
1) Glass Distribution Cells	
2) Mechanical Squeezer	
3) Temperature Regulation System	
4) Cabinet	
5) Single Thermostatted Distribution Cell and Squeezer	
6) Other glassware	
c. Reagents	126
2. Procedure and Calculations	134
a. General Procedure	134
1) Foam cleaning, cutting and weighing	
2) Distribution Cell Assembly and Installation in Squeezing Cabinet	
3) Solution Preparation and Handling	
4) Experimental Sequence, Sample Taking and Counting	
b. Calculations	144
1) Mean and Standard Deviation	
2) Data Rejection	
3) 95% Confidence Interval	
4) Background Subtraction and Spectrometer Drift Correction	
5) Percent Extraction of Cobalt, %E	
6) Distribution Ratio, D	
7) Uncertainties	
8) Significant Figures	
9) Graphical Presentations	
C. RESULTS AND DISCUSSION	
1. Preliminary Results	160
a. Relationship Between Measured Count Rate and Volume of Solution in Counting Tubes	160
b. Determination of Gamma Counter Linearity and Dead Time	164

2.	Time Dependence of Cobalt Sorption from Aqueous Thiocyanate Solutions by Polyurethane Foam	170
3.	Effect of Solution pH on Cobalt Sorption from Aqueous Thiocyanate Solutions	181
4.	Effect of Thiocyanate Concentration on Cobalt Sorption from Solution by Polyurethane Foam	198
5.	Effect of Cobalt Concentration on Sorption From Thiocyanate Solution by Polyurethane Foam and Determination of Sorption Capacity	217
6.	Effect of Aqueous/Foam Phase Ratio on Cobalt Sorption From Thiocyanate Solution	244
7.	Effect of Temperature on Cobalt Sorption from Thiocyanate Solution	258
8.	Effect of Ionic Strength on Cobalt Sorption from Thiocyanate Solution	300
9.	Effect of Polyurethane Foam Type on Cobalt Sorption from Thiocyanate Solution	318
10.	Effect of Various Foam Pretreatment Procedures on Cobalt Sorption	334
11.	Effect of Various Anions, Metal Ions and Nitrogen-Containing Substances on Cobalt Sorption by Polyurethane Foam	350
12.	Polyurethane Film Sorption and Membrane Diffusion of Cobalt	423
	D. INTERPRETATION	445
1.	The Chemical and Physical Properties of Cyclic and Noncyclic Polyethers	445
	a. Cyclic Polyethers	446
	b. Noncyclic Polyethers	453
2.	The Cation Chelation Mechanism (CCM) for Polyurethane Foam	474
3.	CCM Applied to Cobalt-Thiocyanate Sorptions	493
4.	Comparison of Some Experimental Results with CCM	509
	E. CONCLUSIONS	516
	REFERENCES	523

LIST OF TABLES

	page
II-1	Infrequently Used Reagents 130
II-2	Sample Data and Calculations 145
II-3	Chauvenet's Criterion for Rejecting a Reading 150
II-4	Critical Points of the "t" distribution (for 95% confidence) 150
II-5	Relationship Between Measured Count and Volume of Solution in Test-tubes 162
II-6	Linearity Check and Dead Time Evaluation of Gamma Spectrometer 167
II-7	Time Dependence of Cobalt Sorption by Polyurethane Foam . . 173
II-8	Effect of Solution pH on Cobalt Extraction 186
II-9	Effect of SCN^- Concentration on Cobalt Extraction 202
II-10	Effect of Cobalt Concentration on Extraction 220
II-11	Sorption of Cobalt Near Saturation of Foam 225
II-12	Effect of Phase Ratio on Distribution Coefficient for Cobalt Extraction 247
II-13	Effect of Temperature on Cobalt Extraction 263
II-14	Expected Approximate Relative Abundances of Various Cobalt-containing Ions in Aqueous Solutions Near Room Temperature with Various Concentrations of SCN^- , Cl^- and CH_3COO^- 285
II-15	Thermodynamic Data Calculated From Temperature Effect on Cobalt Extraction (Log D Versus 1/T) 290
II-16	Effect of Several Sodium Salts on Cobalt Extraction - Preliminary Results 302
II-17	Effect of Solution Ionic Strength on Cobalt Extraction . . . 306
II-18	Absorption of Cobalt by Various Polyurethane Foam Types . . 326

	page
II-19 Effect of Foam Pretreatment on Cobalt Absorption	342
II-20 Effect of Various Anions on Cobalt Absorption by Polyurethane Foam	356
II-21 Effect of Various Metal Ions on Cobalt Absorption by Polyurethane Foam	373
II-22 Effect of Various Nitrogen-containing Compounds and Cations on Cobalt Absorption by Polyurethane Foam	400
II-23 Spectrophotometric Study of the Effects of Added Substances on Cobalt-Thiocyanate Formation in Aqueous Solution	413
II-24 Comparison of Various Polyurethane Membrane Types for Absorption of Cobalt From Aqueous Thiocyanate Solutions	426
II-25 Diffusion of Cobalt Through Polyurethane Membranes	434

LIST OF FIGURES

	page
2-1 Pyrex glass distribution cell (assembled)	111
2-2 Pyrex glass distribution cell (disassembled).	112
2-3 Essential parts of foam squeezing mechanism	115
2-4 Essential parts of squeezing cabinet temperature control system	116
2-5 Assembled foam squeezing cabinet	120
2-6 Pyrex glass water-jacketed distribution cell (assembled) . .	123
2-7 Pyrex glass water-jacketed distribution cell (disassembled) .	124
2-8 Relationship between measured count rate and volume of solution in counting tubes	163
2-9 Response curve for Baird-Atomic NaI(Tl) crystal and gamma counter	169
2-10 Short-term time dependence of cobalt sorption	177
2-11 Long-term time dependence of cobalt sorption	178
2-12 Effect of pH on cobalt sorption	190
2-13 Effect of thiocyanate concentration on cobalt sorption . . .	203
2-14 Effect of equilibrium solution cobalt concentration on distribution ratio for extraction	223
2-15 Effect of equilibrium solution cobalt concentration on distribution ratio for extraction	224
2-16 Effect of ratio $\frac{V}{W}$ of phases (aqueous:foam) on cobalt sorption	248
2-17 Mathematical simulation of the expected effect of solvent evaporation on the determination of D as a function of the aqueous:foam phase ratio	253
2-18 Effect of temperature on extraction of cobalt	267

	page
2-19 Relationship between logarithm of distribution ratio and inverse of absolute temperature for the extraction of cobalt	269
2-20 Effect of ionic strength on the sorption of cobalt using two different "inert" salts	308
2-21 Relationship between the aqueous perchlorate concentration and the quotient of cobalt distribution ratios for two different "inert" salts	312
2-22 Infrared absorption spectrum of #1338 BFG (polyether) polyurethane foam	322
2-23 Infrared absorption spectrum of A (polyether) polyurethane foam	323
2-24 Infrared absorption spectrum of diSPo (polyester) polyurethane foam	324
2-25 Interference/concentration profiles for several strongly interfering anions in the sorption of cobalt	370
2-26 Interference/concentration profiles for several interfering metal ions in the sorption of cobalt - part 1	384
2-27 Interference/concentration profiles for several interfering metal ions in the sorption of cobalt - part 2	385
2-28 Summary of the results of cobalt sorption interference studies performed with various metal ions	398
2-29 Development of blue colour by three different polyurethane film types exposed to cobalt-thiocyanate solution	427
2-30 Electronic absorption spectrum of cobalt-thiocyanate complex sorbed by three polyurethane film types	428
2-31 Infrared spectrum of Tuftane 312 polyurethane film containing cobalt species	430
2-32 Pyrex glass cell used in membrane diffusion experiments.	432
2-33 Concentration/time profile of cobalt-thiocyanate diffusion through Tuftane 410 polyurethane membrane	440
2-34 Structure of cobalt-thiocyanate-polyether complex proposed by the Cation Chelation Mechanism	499

ABSTRACT

A detailed investigation has been made of the extraction of Co(II) from aqueous thiocyanate (SCN^-) solutions by polyether-based polyurethanes (mostly in the form of flexible open-celled foam). From batch equilibration measurements, using ^{60}Co radioactive tracer, the extraction was observed to be a reversible absorption phenomenon similar to solvent extraction or ion exchange.

The influence of such factors as equilibration time, solution pH, thiocyanate concentration, temperature, ionic strength, polymer composition and aqueous:organic phase ratio were all investigated. High thiocyanate concentration, high ionic strength, low temperature and $1.0 < \text{pH} < 9.0$ were all found to favour efficient cobalt extraction. The effects of a large number of additional anions, cations and organic nitrogen-containing substances were also tested with both enhancements and interferences being observed. Under suitable conditions, cobalt distribution ratios, D , up to $3 \times 10^6 \text{ L kg}^{-1}$ and a maximum capacity of about 0.47 mol kg^{-1} were noted for the polymer studied. The diffusion of cobalt across a thin polyurethane membrane was also demonstrated. Possible industrial and analytical applications were discussed.

Evidence obtained indicates that the cobalt is extracted as the blue $\text{Co}(\text{NCS})_4^{2-}$ anion in association with various possible cations. Several extraction mechanisms were considered. However, based on the experimental results and a consideration of the relevant literature, a new variation termed the "Cation Chelation Mechanism" has been proposed with the suggestion that it may also be applicable to the sorption of many metals besides cobalt. In this proposal, the cations accompanying metal anionic complexes are helically complexed (chelated) by the polyether portions of the polyurethane and thus expedite the sorption of suitable hydrophobic anions (such as metal thiocyanate complexes).

An extensive review covering much of the published literature regarding the various chemical sorption applications of polyurethanes was also presented.

KEY WORDS: Cobalt; Thiocyanate; Extraction, Absorption, Sorption, Distribution, Preconcentration; Urethane polymer, Polyurethane, Polyether

CHAPTER I. GENERAL INTRODUCTION

A. POLYURETHANES -- CHEMISTRY AND USES ⁽¹⁻⁵⁾

The ability to mimic some of the naturally-occurring polymers in the world has been one of the greatest triumphs of synthetic chemistry. The list of man-made polymers available has expanded continually through a curious mixture of both empirical and predictive science pushed along by occasional shortages or shortcoming of Nature's products and by tremendous economic gain. Owing to the wide range of applications found for these materials, the achievement may well have been one of the most widely appreciated technological advances since the turn of the century.

1. Historical Development

The development of polyurethanes was not by accident but largely by the conscious and concerted efforts of Otto Bayer, a German chemist, to prepare a material which did not fall under the patent rights held by the E.I. DuPont de Nemours company for nylon and related polymers. In 1937 and the years following, Bayer successfully produced a series of polymers whose ease of production and desirable properties were to make a lasting contribution to the commercial use of macromolecules. While his product did not come to replace nylon in its applications, a whole new range of uses developed around it. After World War II, the

technologies of the German nation were unveiled to the rest of the world and so production and development of polyurethanes spread over the globe. Today, it would be difficult to find a modern household which does not contain polyurethane in some form.

2. Definition of Polyurethane

Due to the extensive use of common and proprietary names in the field of polymer chemistry, the novice is often genuinely confused by the terminology in general use today. Such is perhaps true in the case of the nomenclature of polyurethanes.

Although there has long been known a compound with the trivial name of "urethane" ($\text{H}_2\text{N}-\overset{\text{O}}{\parallel}{\text{C}}-\text{OC}_2\text{H}_5$), neither is it possible to polymerize this to yield polyurethane (as analogy with many other polymers such as polyethylene might suggest), nor does depolymerization of a polyurethane give anything resembling the expected urethane. The term "polyurethane" is, in fact, intended to indicate any polymer in which there are large numbers of the urethane group (defined as $-\text{NH}-\overset{\text{O}}{\parallel}{\text{C}}-\text{O}-$ and derived actually from carbamic acid). As we shall see, many polymers in which the urethane group represents a very minor fraction of the total are also called polyurethanes by virtue of the fact that the final step in polymerization produces some number of urethane ($-\text{NH}-\overset{\text{O}}{\parallel}{\text{C}}-\text{O}-$) links. Thus, owing partly to a bit of generality in the naming, this group of polymers is a large one with widely-varying chemical make-up and properties. The unifying feature of polyurethane production, however, is its association with organic isocyanates which we will now discuss.

3. Isocyanates

To a large extent, the chemistry of polyurethane preparation is the chemistry of the isocyanate ($-N=C=O$) group and it was Otto Bayer's genius which foresaw the great flexibility of reactions which organic isocyanates offered.

a. Preparation

As long ago as 1849, Wurtz had prepared the first organic isocyanates by reacting dialkyl sulfates with an inorganic cyanate as in equation (1) below:

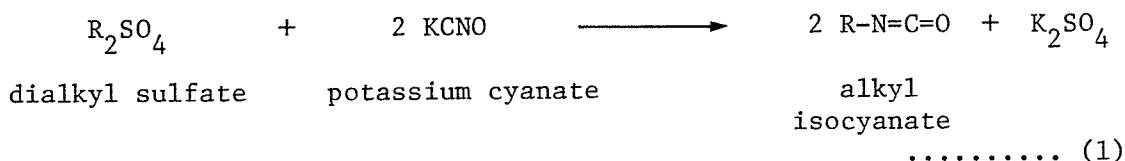

This method of preparation, although quite simple, proved not to be very commercially useful. Among the many other synthetic methods available, the one invariably preferred on an industrial scale is that involving the phosgenation of primary amines:

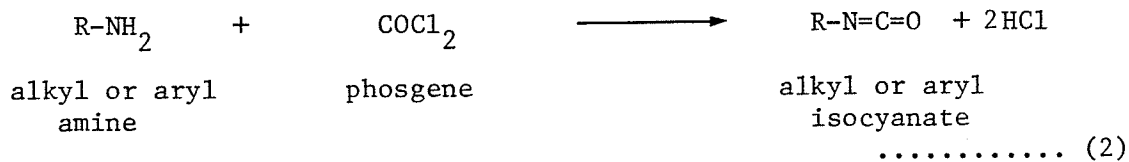

b. Reactions

The isocyanates, as a group, were soon found to be very reactive towards many compounds containing active hydrogen atoms (most notably

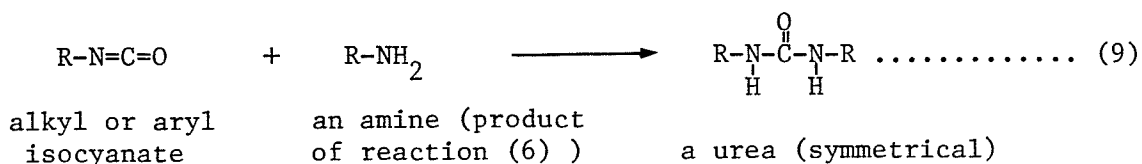

This set of seven reactions of isocyanates describes nearly the whole of polyurethane chemistry. We shall consider them further in their various roles as we discuss the basic ingredients of polymer production.

4. Major Ingredients in Polyurethanes

a. Diisocyanates

The preparation of man-made polymers requires that the reactants be polyfunctional; that is, they must contain two or more reactive groups per molecule. In this respect, polyurethane production is no exception and diisocyanate compounds are prepared for this purpose. Chief among these, for various reasons, is the compound toluene diisocyanate (TDI) which is produced as two major isomers (2,4 and 2,6 TDI). In North

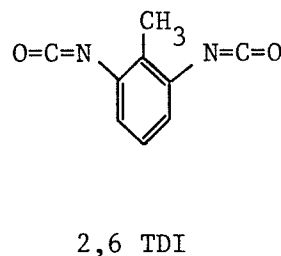
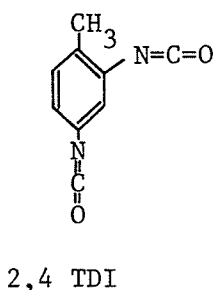

America the commercial product consists of an 80:20 ratio while most European producers supply a 65:35 mixture of these two compounds.

Several other diisocyanates based on hexane, naphthalene, biphenyl and many other root compounds are also in use for various applications. Each exhibits somewhat different reactivities and will impart slightly different physical properties to the polymer. All, however, are severe lung and skin irritants with the more volatile ones being the most problematic.

b. Polyols

Another group of key ingredients in the preparation of polyurethanes are the "polyols" or polyfunctional alcohols. All of these are compounds containing more than one hydroxyl (-OH) group per molecule, but here the similarity ends. Indeed, to prepare the wide variety of polyurethanes in use today, the range of chemical structures employed in polyols is staggering. In addition to carbon, hydrogen and oxygen they may contain nitrogen, sulfur, halides or other elements and may stretch from the simplest possible compounds like ethylene glycol ($\text{HOCH}_2\text{CH}_2\text{OH}$) or glycerine ($\text{HOCH}_2\text{CH}(\text{OH})\text{CH}_2\text{OH}$) through complex natural mixtures such as castor oil to compounds which are themselves high molecular weight polymers. In addition, several different types of polyol are frequently employed together in the same formulation and in a variety of proportions. Thus, by far the greatest amount of control over the physical properties of the polymer is exercised simply by the choice of polyols used in its preparation.

In the category of polyol compounds which are themselves polymers, two basically different types have emerged and are worth consideration here. First are the "polyesters". As the name suggests, these contain numerous repetitions of the ester ($-\overset{\text{O}}{\parallel}{\text{C}}-\text{O}-$) group and can be prepared by repeated esterification reactions between a diol (di-functional alcohol) and a diacid (di-functional carboxylic acid). For example, a typical

polyester material is poly(ethylene adipate):

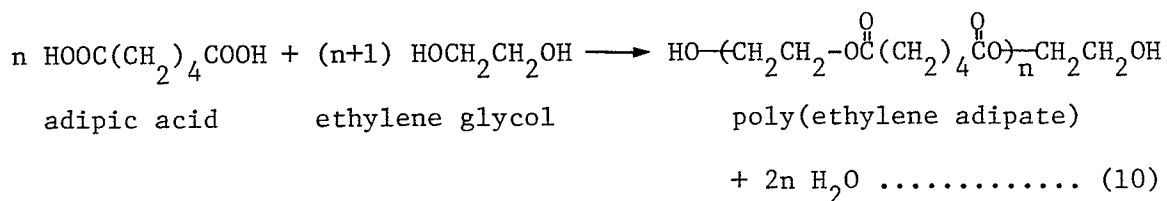

where n can be anything from only 2 or 3 up to 100 or more. The list of possible polymers available through assorted combinations of acids and alcohols in this way is quite long. These compounds are very old friends to the polymer chemist (who has been making textile fibers from them for many years) but were first employed in polyurethane manufacture by Farbenfabriken Bayer in 1950. However, the rather low resistance to hydrolysis and restricted flexibility of the ester linkage in these materials has caused them to be largely replaced in certain uses by a second type of polymer polyol - the "polyethers". These compounds contain repeating ether (-O-) linkages and are most often prepared from small alcohol initiators by chain extension with epoxides. For example, polyethylene oxide polyol (PEO) may be produced by reaction of a small amount of ethylene glycol with a larger quantity of ethylene oxide:

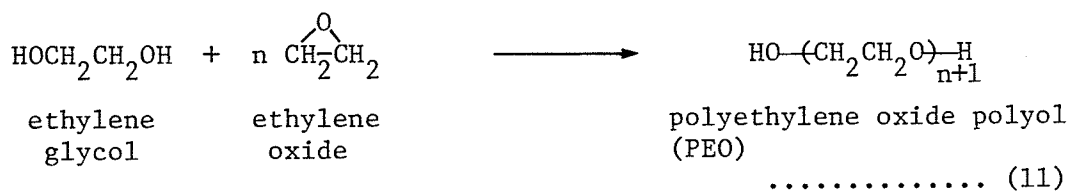

where, again, n can have values up to several hundred or even more. The Du Pont company first introduced polyurethane prepared from this polyol in 1953 and since then its use has become very widespread. Similar polyether polyols can also be prepared from propylene oxide, butylene oxide,

etc. and from decyclization of cyclic ethers such as tetrahydrofuran. A number of mixtures of these, either within individual molecules (known then as copolymers) or as physical combinations of distinctly different molecules, are also in common use today. All of these substances combine the properties of chemical inertness and high flexibility to great advantage while allowing some differences for tailoring of the resulting polymer to suit specific needs.

5. Polyurethane Production

As is evident from equation (3), it is the reaction between isocyanates and alcohols which produces urethanes. Similarly, it is the reaction between polyisocyanates and polyols which results in polyurethanes. In the case where difunctional reactants are involved in each case, the reaction may be written as:

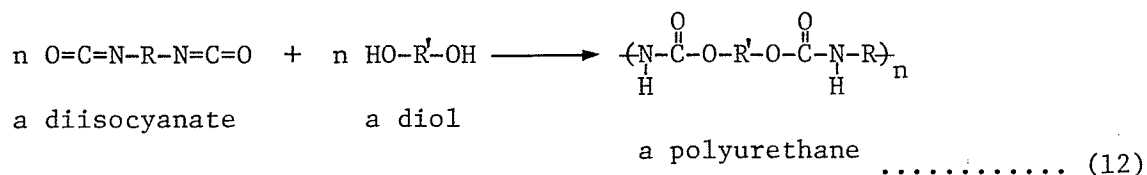

Reaction (12), as written above, would theoretically generate nearly infinite straight chains with endless repetitions of the urethane group to give a one-dimensional polymer. In most applications, a certain amount of two- and three- dimensionality is desirable to adjust the flexibility of the polymer and to render it insoluble so chemical attachments from one chain to another (known as "crosslinks") are encouraged. To a small extent, the natural reactions between isocyanates and urea links

ment of the degree of crosslinking can provide polymers ranging in flexibility from nearly limp to very brittle and this accounts for the wide usage of polyurethanes.

6. Types and Applications of Polyurethanes

Polyurethanes have now been produced in a myriad of forms most of which fall loosely under the headings of foams, elastomers, coatings, adhesives and fibers. Each has its own special chemical considerations and, of course, applications. Although it is not possible here to discuss each one fully, a brief overview is in order with more detail on those parts which will be most important to us later.

a. Foams

By far the largest utilizations of polyurethanes is in the form of flexible and rigid foamed plastic. This material contains small voids throughout its bulk to reduce the density and, in the case of flexible foams, to allow for three-dimensional compression. The voids can be generated in the bulk by the removal of solid fillers originally added for that purpose but are more often achieved by the evolution of a gas within the polymer mixture while it is solidifying. Nearly all types of polymers may thus be prepared in the form of a foam by the addition of materials which evolve a gas on heating or on reducing the pressure. Polyurethane, however, is one of very few polymers for which an extremely simple method exists to accomplish this effect.

Two of the characteristic reactions of isocyanates which we have

not yet discussed are those with carboxylic acids (reaction (5)) and water (reaction (6)). Both of these evolve carbon dioxide gas and can be used in the formation of foamed product. In the case of carboxylic acids, a monofunctional acid would result in an amide link ($\text{-N}-\overset{\text{O}}{\parallel}{\text{C}}-\text{-}$) being produced but growth of the polymer chains would be halted by this reaction. However, a difunctional acid could be used both to generate carbon dioxide and to continue polymer growth. In practice, though, water is more suitable for this purpose since it can be seen from equations (6) and (9) that the product, an amine, is also reactive towards further isocyanate to yield a urea link ($\text{-N}-\overset{\text{O}}{\parallel}{\text{C}}-\text{N-}$) and so polymer growth continues. The simplicity of this approach has long been one of the attractive features of polyurethane chemistry and it should be remembered, therefore, that nearly all polyurethane foams contain very significant numbers of urea ($\text{-N}-\overset{\text{O}}{\parallel}{\text{C}}-\text{N-}$) as well as urethane ($\text{-N}-\overset{\text{O}}{\parallel}{\text{C}}-\text{O-}$) linkages.

As already noted, choice of the polyols used and control of the degree of crosslinking achieved determines the flexibility of the resulting polymer. So it is with polyurethane foams. When tough, rigid foamed product is desired, short chain polyols are used along with a large amount of tri- or higher functionality polyol. On the other hand, when highly flexible, elastic foams are required, long chain polyols of the polyester or polyether type are employed along with only small amounts of polyfunctional polyol. Of course, owing to the multitude of possible choices, no real dividing line exists between rigid and flexible foams and nearly the same physical characteristics can often be achieved by

several quite different combinations of polyol type and degree of crosslinking.

The actual production of polyurethane foam is as much an art as it is a science. Very accurate control of the amounts of polyols, diisocyanates, and water is required to give nearly stoichiometric reactions with adequate gas evolution. Moreover, since a large number of reactions are required to proceed simultaneously and competitively, the rates of these reactions must be carefully adjusted and orchestrated to ensure, for example, that gas bubbles are fully developed only at the instant at which the polymer is sufficiently viscous to hold the bubbles without collapse. Two groups of minor constituents are added to the polymer mixture to aid in this task. First, are the catalysts (most often combinations of heavy metal organometallic compounds and one or two amines) whose job it is to speed up those reactions which are otherwise too slow. Second, are the surfactants which may or may not be required to alter the surface tension of the reactants so that bubbles of small enough size and adequate strength are formed.

Some other additives are often present in polyurethane foam for reasons besides the control functions listed above. In some cases, inorganic materials (salts, carbon black, etc.) are added as "fillers" to the polymer to impart additional strength, weight or colour at low cost. Also, some organic phosphate compounds can be incorporated in the formulation as flame retardants while other compounds present in small amounts can inhibit air oxidation ("aging") of the polymer. The presence or absence of all of these substances must be kept in mind when considering

the chemistry of polyurethane foams.

The broad scope of applications for which foamed polymer is useful requires that several types of foam be fabricated. Some terminology descriptive of these different types is worth considering. The individual bubbles in the foam are termed "cells" and these normally have the shape of distorted polyhedra. The very thin faces of these polyhedra are called the "walls" or "windows" of the cells while the comparatively thick edges are known as "strands". A foam which has nearly all windows unbroken is a "closed-cell" foam while one with at least two broken windows per cell is an "open-cell" foam. In the extreme, a foam in which all of the windows are broken and even entirely absent so that only strands remain is termed a "reticulated" foam. Obviously, liquids and gases may enter into or escape from open-cell and reticulated foams but not from closed-cell foams.

A host of applications have been developed for both flexible and rigid polyurethane foams. The flexible materials in closed-cell form have been employed extensively as carpet underlay, acoustical insulation, thermal insulation on moving parts and hoses, packaging and shock protection for delicate equipment, protective pads for sports use, golf club and tennis racket grips and soles for shoes and slippers. The open-cell type of flexible foam is even more common as the supporting material in bedding, furniture, home and transportation seating, automobile sunvisors, instrument panels, arm rests, air filters, sponges, caulking, weather stripping, bonded fabrics, toy stuffings, loud-speaker covers, etc. Meanwhile, the rigid types of polyurethane foam are most used as insulation in refrigerators, trucks, trailers, ships, airplanes, wall

panels and stationary pipes or are sprayed directly onto ceilings and walls of large buildings for this purpose. Other uses include void filling in boats and ships, packaging and even the solid support for various types of rocket fuels. This last application, incidentally, calls attention to the fact that exposed foamed polymer can burn almost explosively, a fact which has caused a reduction in its use in building insulation in spite of attempts to incorporate flame retardants in it.

b. Elastomers

The chemistry of the preparation of elastomers (elastic polymers) is also described by that of flexible polyurethane foam with the exclusion of bubble formation. In its preparation, polyols of the polyether or polyester type are mixed with a small excess of diisocyanate and then the resulting "prepolymer" (relatively short chains bearing isocyanate groups at either end) is extended and crosslinked. The chain extension can be accomplished by the addition of further diols, diamines, amino-alcohols or even water to give urethane or urea links as in reactions (3), (4), (6) and (9). In the case of water, exposure to atmospheric moisture for hours or days is often sufficient and the carbon dioxide gas generated has time to diffuse away without appreciable bubble formation. Crosslinking is achieved usually by triols, triamines, etc. but can also be based on the formation of allophanate or biuret links (reactions (7) and (8)) at elevated temperatures and pressures.

Polyurethane elastomers can be cast or molded into numerous parts, sheets or thin films. Applications are not as numerous as for their foamed counterparts but include gaskets, drive belts, electrical cable insulation, gears, small high-load wheels and rollers, tires for slow-

moving vehicles as well as heels and soles for shoes. Most of these uses take advantage of the high resistance characteristics of polyurethane elastomers to oil and to abrasion.

c. Coatings

The introduction of polyurethanes into the field of paints and lacquers provided coatings of strength, adhesion and solvent resistance previously not available. Basically, the preparation of these polymers is similar to that of the elastomers except that shorter, less flexible polyols are employed and solvents are also included to aid in spreading the material. Some formulations achieve chain extension and crosslinking by baking the applied prepolymer while others require mixture of the polyol and diisocyanate components immediately before use. However, most types depend on the absorption of moisture from the air for this final polymerization.

Many applications of urethane paints such as in ships' holds, railroad cars, and in oil, gasoline, wine, beer, fruit juice, syrup and many other storage tanks exploit the inertness and corrosion resistance of the polymer. Other uses as a varnish for wood and concrete floors take advantage of good strength and abrasion resistance. Polyurethane now has a near monopoly as the thin coating on magnet and other similar wires and newer applications as a permanent waterproofing for leather and textiles have developed.

d. Adhesives

The polyurethane skeleton contains several atoms and groups capable of acting as electron donors (N and O) and others able to serve as hydrogen donors (N-H groups in urethane or urea links). Together with the polar carbonyl ($-\overset{\text{O}}{\underset{\text{||}}{\text{C}}}-$) groups, these provide ample means of interaction

between itself and other polar materials such as metals, glass, wood, leather, rubber and some fabrics. Thus, polyurethanes often find use as adhesives and sealers on a number of surfaces. Polyols of all types are employed in various applications depending on the substrate and the degree of flexibility required while several methods of forming the polymeric adhesive are used. Generally, some degree of crosslinking is ensured by inclusion of polyfunctional polyols or isocyanates.

e. Fibers

As already noted, the combination of a diisocyanate with a diol can produce a nearly infinite one-dimensional polymer with very few crosslinks. Such structures are ideal for the production of fibers and this, to be sure, was Otto Bayer's original goal.

Secondary valence forces (van der Waals, dipole-dipole and hydrogen bonding) primarily between urethane links serve to anchor the individual polymer chains to each other and thus restrict bending and sliding motions to some extent. When short diols are used, the large number of closely-spaced urethane links produced gives rise to tough and stiff fibers well adapted for use as bristles in paint brushes or strands in heavy ropes. Longer diols give more flexible fibers useful in producing drive belts, insulation for large electrical cables and parachute fabric during World War II. More recent and widespread application has been found for the fibers prepared from diisocyanates and high molecular weight polyether and polyester diols. Such polymers are flexible and excellent elastomers capable of outperforming natural rubber in most functions. Numerous bras, girdles, swim wear, waist bands and stocking bands are based on these materials (e.g. "Lycra") and they

will likely replace rubber entirely in sport and foundation wear.

As should now be apparent, even from this brief overview, polyurethane products are indeed familiar, if unrecognized, friends in the world's households. Continued expansion of uses in the manufacturing industry will undoubtedly continue as more and more consumer needs arise and are satisfied by polyurethanes.

B. APPLICATIONS OF POLYURETHANES TO CHEMICAL
EXTRACTION AND SEPARATION - A REVIEW

When Otto Bayer originated the production of polyurethanes in 1937 it is possible that he may have envisaged some of the uses to which it might eventually be put. However, even if he anticipated the plethora of manufactured goods to follow over the years, he may well have missed the possible applications to chemistry itself. But he would not have been alone in this shortsightedness, for although over 40 years of polyurethane production have passed, only slightly more than ten of them have seen any suggestions for chemical applications at all. Indeed, man is still nearly entirely preoccupied with the physical and not the chemical characteristics of polyurethanes. However, what chemical uses have been offered thus far promise to be of significant importance to industrial processing, resource recovery, waste control, pollution monitoring, medicine, and, of course, analysis. What follows, then, is an attempt to present much of the work which has been reported on the uses of polyurethanes chiefly as extractants and chromatography supports.

Some very good reviews but with slightly less scope have already appeared in the literature. Braun and Farag, prolific workers in the field, presented a summary⁽⁶⁾ of their own early work as a chapter of a book on chromatography. At nearly the same time, they also published a more general treatment⁽⁷⁾ in the chemical literature which included the work of others, while quite a thorough update⁽⁸⁾ of this has appeared recently. Moody and Thomas have produced another excellent and general

review⁽⁹⁾ on the topic in the most recent past. A less complete offering⁽¹⁰⁾ by Lee has also appeared but in the Korean language. As well as these, two publications have appeared summarizing the preparation and chromatographic uses of the product known as "OPP" (open-pore polyurethane). The earlier one by Ross⁽¹¹⁾ includes a good review of the original gas and liquid chromatographic work with flexible polymer as well. The later one by Navratil and Sievers⁽¹²⁾ contains a few more recent developments in its use. Taken together, all of these reviews provide the novice with a reasonably accurate overview of the developments in the field.

Basically, studies into the sorption abilities of polyurethanes for various chemical substances have been confined to three forms of the polymer - flexible foams, OPP, and elastomers in the form of membranes. The results reported are most conveniently considered within these separate categories and are further subdivided into those describing extraction from gaseous and from liquid phases.

1. Flexible Foams

By far the most extensive and varied studies to date have been undertaken on flexible polyurethane foams. These materials, so common in such a diversity of consumer goods, have been used by chemists as sorbents in unmodified form, loaded with many substances, or after chemical modification to alter their makeup. Each approach will be dealt with individually.

a. Unmodified Flexible Foams

1) Sorption from Gases

The first report of a chemistry-related application for unmodified polyurethane foam appears to have been made by Van Venrooy⁽¹³⁾ in a patent applied for in 1965 and granted in 1967. In it, the inventor suggested the use of the polymer as an uncoated packing material for gas chromatographic columns. He noted that several features of polyurethane foam, such as its self-support strength, high thermal stability and low pressure drop, were all desirable characteristics for chromatography. Sample chromatograms for water, free fatty acids, aromatic hydrocarbons and o-ethylphenol showed that it could function very well as a separational medium in the gas phase.

Following this lead, in 1971 Schnecko and Bieber⁽¹⁴⁾ reported comparative tests on gas chromatographic columns prepared from foamed polyurethanes of both polyether and polyester type as well as from several other polymers. Polyurethane columns were prepared from foamed in situ material and from finely ground up foam packed in the usual way. Both methods were said to give quite acceptable gas chromatographic separations, but the ground up material was favoured. Polyurethanes compared favourably with all other fillings tested on separations of various polar as well as non-polar mixtures.

Although the results of these workers appeared encouraging, no publications utilizing foamed polyurethanes in gas chromatographic columns have been offered since.

A more commercially useful suggestion was made by Strickman⁽¹⁵⁾ in a patent of 1971 for cigarette filter manufacture. Strickman showed

that finely granulated foam in a filter tip was able to remove large amounts of nicotine, tar, water, aldehydes, sulfides, HCN, phenols and acid materials from cigarette smoke with from 40 to 70 percent efficiency. Both polyether and polyester polyol types were effective.

The use of polyurethane foam as an air filter for removing unwanted gases, particularly those containing sulfur or nitrogen, has also been proposed in a patent by Maroni and Kalbow.⁽¹⁶⁾

Duce, Quinn and Wade⁽¹⁷⁾ found that the usual high volume methods of collecting long chain hydrocarbons (14 to 32 carbon atoms) from air onto glass fiber filters lead to very significant losses. In oceanic air samples taken in Bermuda, much better collection efficiencies were noted when polyurethane foam was included with the glass filter. Recovery of the sorbed hydrocarbons for analysis was by organic solvent wash. The results were used to evaluate the extent to which hydrocarbons are transported through the atmosphere.

In the same vein, Bidleman and Olney⁽¹⁸⁾ used this procedure to collect samples of polychlorinated biphenyls (PCBs), DDT and chlordane from air at the same location. They reported 90 percent collection efficiency and recovered the materials from the foam for analysis by reflux or Soxhlet extraction using petroleum ether. A later paper⁽¹⁹⁾ examined the collection efficiency for PCB vapours more thoroughly under laboratory conditions and found the method to be superior to the Greenburg-Smith impinger. Further use was reported⁽²⁰⁾ in the collection of toxaphene insecticide (a mixture of polychlorinated camphenes) from the Bermuda sampling station and from a cruising vessel. More experi-

mental details and some interpretation later appeared⁽²¹⁾. The authors pointed out that the fraction of PCBs and insecticides collected on the glass fiber filter appeared to depend upon the source of the air sampled and concluded that some must be strongly adsorbed onto particulate matter when present. Mention was also made of the ability of polyurethane foam to collect organophosphate insecticides in addition to the chlorinated ones.

Yamasaki, Kuwata and Miyamoto⁽²²⁾ applied the high volume air sampling method using a glass fiber filter and polyether polyurethane foam to the collection of polynuclear aromatic hydrocarbons (PAHs). All of the PAHs tested, except phenanthrene, were collected very efficiently (>90%) on the glass filter or polyurethane foam. Phenanthrene was collected with 79.2 percent efficiency. The PAHs were eluted for analysis by Soxhlet with cyclohexane.

An attempt was reported by Gough⁽²³⁾ to use a polyester polyurethane foam for the collection of phthalic acid esters (PAEs) and vinyl chloride monomer from air. Some success was noted with the PAEs but experimental conditions allowed only the smallest esters to be tested. Vinyl chloride monomer, moreover, was not absorbed.

Yamasaki and Kuwata⁽²⁴⁾ studied PAE absorption from air in more detail using the glass fiber and polyurethane foam system. They found high efficiency (>90%) collection and noted that the less volatile phthalates were found primarily on the glass filter while the more volatile ones favoured the polyurethane. Recovery for analysis was by Soxhlet with petroleum ether in hexane.

A publication by Turner and Glotfelty⁽²⁵⁾ described the design of a simple apparatus using polyurethane foam for the simultaneous collection of pesticides from air samples at various heights above the ground. It was reported that better than 98 percent trapping efficiency was achieved with no subsequent losses when fresh air was drawn through the polymer. After elution of the pesticides and washing, the foams were reused. Mention was also made that Gypsy Moth pheromone was collected efficiently on polyurethane foam.

Lewis, Brown and Jackson⁽²⁶⁾ extended the study of PCB and pesticide collection to include organophosphate insecticides and polychlorinated naphthalenes (PCNs) as well. The apparatus used was a modified commercial high-volume sampler with the usual glass beads coated with cottonseed oil replaced by polyether polyurethane foam. The authors judged the modification to be a significant improvement and reported excellent collection efficiencies for most of these substances. However they warned that the more volatile compounds are lost in part on 24 hour sampling.

All of the aforementioned uses of polyurethane foam to preconcentrate components from air prior to recovery and analysis share common advantages over other methods of sample collection. These have been variously stated by the authors as low cost, high collection efficiency, high preconcentration factors, high throughput (due to low backpressure) and consequent improved sensitivity or decreased sampling time, ease of sample storage and transport, simplicity of recovery and reusability. There is little doubt that further applications will be found in the near future.

2) Sorption from Liquids

The concept of using polyurethane foam for the removal of substances from the liquid phase developed only after a lag period of several years following its use on the gas phase.

Interestingly enough, it was in the field of biochemistry that perhaps the first report was made by Evans, Mage and Peterson⁽²⁷⁾ in 1969. These authors showed that erythrocytes could be bound to reticulated polyester polyurethane foam and that this binding could be influenced by the presence of other substances. For example, polyanionic materials were found to reduce erythrocyte binding greatly while polycations enhanced the phenomenon. This effect was attributed to the sorption of some amount of the interferents to the polymer and to electrostatic interactions between them and the erythrocyte membrane (negatively charged at the pH of study).

However, activity began in earnest with the release by Bowen⁽²⁸⁾ in 1970 of his observations that a large number of compounds are sorbed from water and various solutions by polyether polyurethane foam. Listed among the extractable compounds were those which are known to exist in aqueous solution as free molecules with high polarizability (e.g. Cl_2 , Br_2 , I_2 , benzene, chloroform, carbon tetrachloride, phenol, bromobenzene, iodobenzene, divinylbenzene, Hg-diphenylcarbazone, and the dithizonates of Cu, Cd, Pb and Zn). Also extractable were some metal complexes existing as anions (e.g. FeCl_4^- , AuCl_4^- , AuBr_4^- , AuI_4^- , TlCl_4^- , HgCl_4^{2-} , ReCl_4^- , etc.). Bowen found capacities of sorption to vary with both the foam type and sorbed compound but to be typically of the order of 0.5 to 1.5

moles per kilogram of foam. From measurement of the surface area of polyurethane foam⁽²⁹⁾, this was calculated to be far too large to be attributable to adsorption alone and was thus concluded to be a true absorption directly into the bulk of the polymer⁽²⁸⁾. Comments were made by the author that the list of substances absorbed by the polyether polyurethane closely paralleled that of compounds extractable by diethyl ether. It was also pointed out that some weak base anion exchange capability might be expected on the basis of urea and urethane nitrogen atoms or, alternatively, that polyether oxygen atoms may be protonated in acid and then would require accompanying anions to maintain electrical neutrality. Whatever the method, Bowen demonstrated that polyurethane could be a new chemical tool for the removal from aqueous solution of inorganic and organic substances alike and was later granted a patent⁽³⁰⁾ (through Dunlop Holdings Ltd.) on its use. It is convenient for us to consider, in turn, these two major groups of compounds and the work which has followed over the years.

Following from Bowen's original paper⁽²⁸⁾ with an inorganic application, Schiller and Cook⁽³¹⁾ tested polyurethane foam for the preconcentration of a mixture of ionized, colloidal and finely precipitated gold from tap water. Batch sorption from HCl solution was successful and compared very favourably to coprecipitation by $\text{Fe}(\text{OH})_3$ and $\text{Al}(\text{OH})_3$ or to anion exchange on Dowex 1-X8. Coprecipitation with PbS was marginally more effective and a bit faster though less convenient. Gold-bearing polyurethane foam was then suitable for irradiation and analysis for gold by the neutron activation method. No attempts at recovery of the gold from polyurethane were reported.

Bowen⁽³²⁾ also tested polyurethane foam for precious metals recovery and detoxification of a mineral processing waste containing gold, silver and cyanide. Moderate success was noted in gold sorption (38% of Au removed) but since no Ag or CN⁻ removal seemed possible, coprecipitation with FeS was to be preferred.

A contribution to the study of gold sorption was made by Braun and Farag⁽³³⁾ who observed that gold is extracted into polyether polyurethane foam in the presence of thiourea and dilute perchloric acid. They suggested that this might be of industrial use as a replacement for adsorption by activated carbon but concluded that 10 grams of foam would be required in place of 0.2 grams of carbon. Again, no data on recovery were given.

A further study of gold sorption was offered by Sukiman⁽³⁴⁾ who reported that the element was removed rapidly and nearly quantitatively from acidic chloride solutions. The rapid uptake of gold was attributed to a larger surface area for polyurethane foam compared to ordinary resins in bead form. The author also claimed quantitative recovery of the sorbed gold by elution with acetone or with hot acidic thiourea solution. However, due to the easy reduction of gold to the metallic state by contact with organic substances such as polyurethane⁽³⁵⁾, this recovery must surely follow the sorption almost immediately to be successful.

In a brief survey, Mazurski⁽³⁶⁾ noted that polyester polyurethane was able to absorb measurable amounts of Au, Ag, Pt and Cr ions from acidic or slightly basic solution but these results were not pursued further. Apparent sorptions were also noted where precipitates of metals

would be expected to form indicating some filtering capacity to the foam structure. The ability of polyurethane foam to absorb mercuric chloride and methyl mercuric chloride from slightly acidic solutions was also reported but the capacity was apparently very low. These observations were confirmed by Chow and Buksak⁽³⁷⁾ who also pointed out that the mercury was only weakly held and could be eluted by distilled water.

In another survey, Lypka⁽³⁸⁾ found that polyether polyurethane foam absorbed copper(II), cadmium, iron(III), aluminum and zinc ions from aqueous solutions containing acetylacetone. Copper and cadmium were singled out for further study⁽³⁹⁾. Cadmium was seen to be sorbed from basic solutions in the presence or absence of acetylacetone and so apparently did not involve complex formation. On the other hand, it was concluded that the copper-acetylacetone extraction system paralleled solvent extraction of that complex in pH dependence. Copper was also tested for absorption from acetone and acetone/water solutions containing benzoylacetone. Absorption was measured to be low from pure acetone but much higher from the mixed solvent.

Gesser et al.⁽⁴⁰⁾ described the ability of polyether polyurethane to remove both gallium and iron(III) from acidic chloride solutions. Rigid polyurethane material was also effective but much slower indicating that absorption was the mode of action. The efficiency of extraction was noted to be greatest from solutions at higher temperature. Capacities for gallium were said to be as high as about 1.4 moles per kilogram but lower for iron. Both metals could be recovered by water or more effectively by sodium hydroxide for gallium. A patent⁽⁴¹⁾ covering these

metals as well as Be, U, Pu, transition metals and elements of groups IIIa, IVa and Va has also appeared.

The subject of gallium absorption into polyether polyurethane foam from acid chloride solutions was considered in more detail by Horsfall (42) and reported in the literature by Gesser and Horsfall (43). The conclusion reached on the basis of the dependence of extraction on H^+ , Cl^- and Ga concentrations was that the species $HGaCl_4$ was the absorbed complex. Some suggestion was made that the absorption from acid chloride and desorption with dilute base differed considerably in rates perhaps due to $Ga(OH)_3$ formation in the absence of acid.

A similar mechanistic study (44) of iron(III) absorption from acid chloride solutions was also undertaken recently. It was suggested that the various dependencies of extraction on H^+ , Cl^- and Fe concentrations were consistent with a solvent extraction type of mechanism involving both $FeCl_3$ and $HFeCl_4$ species. The polyether polyurethane was regarded as a "liquid" solvent of moderate dielectric constant in which some dissociation of sorbed species was possible.

Valente and Bowen (45) have studied the removal by polyether foam of antimony(III) and its separation from antimony(V) in mildly basic aqueous solutions. The method makes use of an excess of sodium diethyldithiocarbamate added to the solution to complex and extract Sb(III) in the presence of many other ions. The uptake of Sb(III) from distilled, lake or sea water and sewage effluent as well as its recovery with acetone were reported to be quantitative. Diethyldithiocarbamates of Ag(I), Cd(II), Fe(III) and Hg(II) were also said to be absorbed by foam while those of As(III), Sn(II) and Zn(II) were not. The authors sug-

gested this method of preconcentration as a convenient and compatible preliminary step to either atomic absorption or neutron activation analysis.

The sorption of Sn(II), Sn(IV), Sb(III), and Sb(V) by polyether and polyester polyurethane foam from acidic chloride solutions has been studied by Lo⁽⁴⁶⁾ and a portion of the work published by Lo and Chow⁽⁴⁷⁾. Nearly quantitative extractions and recoveries into water, dilute base or acetone were said to be possible with capacities up to 0.7 moles of tin per kilogram of polyurethane. Again, the phenomenon was described as an absorption of acid-containing chloro species akin to solvent extraction.

Uranyl nitrate sorption by polyether foam has recently been described by Gupta⁽⁴⁸⁾. The distribution of uranyl ions to the polymer was noted to be independent of pH below 3 though it fell sharply at values above this. Extraction was decreased with a rise in temperature or a drop in nitrate concentration. The polyurethane material was said to be more effective than diethyl ether extraction but required the addition of large amounts of a salting-out agent to achieve highest efficiency. A capacity of up to 0.67 moles of uranium per kilogram of foam was measured. Similar application to the extraction of uranium from a phosphate mineral dissolved in hydrochloric acid was also tested and found to be feasible when aluminum chloride was present.

Braun and coworkers⁽⁴⁹⁾, in a study on the sorption of several metals onto loaded polyurethane foams, observed that plain polyether foam was apparently capable of removing cobalt(II) from aqueous thiocyanate but not from oxalate, phthalate, bromide, iodide or nitrate solutions.

It was concluded that an interaction must exist between the thiocyanate complex of cobalt and the polyether foam since polyester foam was ineffective.

Maloney, Moody and Thomas⁽⁵⁰⁾ later described the extraction of Cd(II), Co(II), Fe(III), Zn(II) and Hg(II) from aqueous thiocyanate solutions into polyether polyurethane foam. A capacity for cobalt of about 0.17 moles per kilogram and about 0.39 moles per kilogram for iron thiocyanates was reported. Maximum distribution ratios of 10^4 and 10^3 , respectively, were noted at low metal concentrations. Although not much specificity was noted, the authors suggested that this would be a suitable technique for preconcentration of several metals simultaneously. Quantitative recoveries were said to be achieved by hot dilute nitric acid.

Similar data for Co(II) and Fe(III) removal from aqueous acidic thiocyanate solutions by polyether polyurethane foam were given by Braun and Farag⁽⁵¹⁾. Sorption was noted to be relatively rapid and suitable, therefore, for column preconcentrations of the metals from large solution volumes. The phenomenon was interpreted in terms of a true solubility of the thiocyanate complexes into the polyether foam moieties since polyester polyurethane foam did not absorb the complexes measurably. No data were given for the recovery of absorbed complexes from foam or their identification. Brief mention was also made of the sorption of gold from cyanide solution onto polyether polyurethane foam.

Recently, Moore⁽⁵²⁾ has reported the extraction of iridium(IV) from organic solvents (acetone and ethyl acetate) by polyether polyurethane

foam. Many other solvents were not suitable due to low solubility of the Na_2IrCl_6 complex or due to reduction of the Ir(IV) to non-extractable Ir(III). The capacity of foam for extraction of Ir(IV) was noted to be about 0.83 moles per kilogram of foam from ethyl acetate but only 0.12 moles per kilogram from acetone. This was said to suggest that the extractable species (likely H_2IrCl_6 or Na_2IrCl_6) was also highly solvated. Complete recovery of the sorbed metal with hydrochloric acid was found to be difficult but was improved by the addition of reducing agents. Some results were also presented for the similar extraction of Na_2PtCl_6 from acetone, though in less detail.

On the side of organic compound extraction by unmodified polyurethane foam, a great deal of interest has been expressed (mostly in the patent literature) in its use for the removal of petroleum hydrocarbons from contaminated waters. Much of this interest⁽⁵³⁻⁷⁶⁾ has centered on the problem of removing large amounts of spilled oil directly from the surface in cleanup operations. In some cases,^(60,63,64,76) this involves setting down larger pieces of foam on the surface and recovering them after they have soaked up the oil. In others, shredded foam is cast onto the surface^(53-55,57,59,61,65,73,74) and retrieved with nets^(54,53), herded up by water sprays⁽⁵⁵⁾ or can even be picked up magnetically⁽⁷⁰⁾ when ferromagnetic materials have been included in the polymer mixture. Still other schemes make use of long continuous belts⁽⁵³⁾ which are constantly reeled out and rolled in on specially-designed ships. Often, surfactants^(64,72,74) are included in the polyurethane or spread separately on the spill to increase the speed of wetting of the foam. The ease of production of polyurethane foam allows it to be produced from

components on the ship immediately before use^(59,61) or even directly on the surface of the water⁽⁵⁸⁾. Usually, the foam is reused several times; the oil almost always being removed simply by squeezing the polymer although solvent washing is also possible.

This type of chemical application for polyurethane foam could probably be viewed in a different light from the preceding ones since it primarily involves the physical entrapment of material in the spaces of the cells rather than true sorption. Nevertheless, it appears that the compounds which are preferentially sorbed by the polymer dictate to a large degree what may then occupy the cell volume. Thus, different polyurethane formulations achieve different successes of separation between water and oil. Use of this fact for an apparatus able to separate oil from water (but not necessarily for oil spills) has been reported by Schaus⁽⁷⁷⁾.

The removal of petroleum from wastewaters for the purpose of purifying them appears to have attracted less attention than oil spill recovery. Nevertheless, polyurethane foam has been suggested⁽⁷⁸⁻⁸⁰⁾ as a final oil-absorbing filter in conjunction with the conventional sand trap. Normally, these filters are changed or cleaned at the point at which the polyurethane is nearly saturated with oil since further accumulation would reduce efficiency and restrict water flow.

However, of more interest to us is the use of polyurethane foam in the preconcentration of hydrocarbons from water for the purpose of analysis and pollutant monitoring. In 1973, Schatzberg and Jackson⁽⁸¹⁾ reported a survey of several potential oil sorbents (polyethylene, poly-

propylene, polyurethane, activated carbon, diatomaceous earth and silicized glass) for this purpose. Tests on water bearing an artificially-produced oil film demonstrated that polyurethane foam was a very efficient absorber of oil passed through it and that the oil was equally well recovered for infrared analysis by Soxhlet extraction with carbon tetrachloride. Other sorbents, although similarly effective at oil removal, were rejected because of high blanks, incomplete recoveries or difficult handling and column packing. No systematic differences were found between results obtained by the polyurethane foam absorption method and simple solvent extraction with carbon tetrachloride.

On the other hand, Webb⁽⁸²⁾ made a comparative study of polyurethane foam, Amberlite XAD resins and solvent extraction for the removal of fuel oil from water. This work showed that polyurethane foam performed rather poorly when compared to the other two choices and solvent extraction was said to be the preferred method. Similar comparisons were also made on simulated pulp mill and textile dyeing effluents with the same conclusions being reached.

The poor performance of polyurethane foam compared to solvent extraction for hydrocarbon preconcentration was also noted by Ahmed et al.⁽⁸³⁾ These workers found only about 20 percent of the hydrocarbons were removed from Boston Harbour water by polyurethane foam and added that a problem existed with reproducibility (likely due to non-homogeneous distribution on particulates in the water).

In spite of these difficulties, many other applications to organic compound sorption have been described. One such interesting use has been in the field of medicinal chemistry. While searching for a polymer which could be used to control the level of dietary fat and cholesterol

assimilation, Marsh⁽⁸⁴⁾ found that the model compound chosen, oleic acid, was better absorbed by polyurethane manufactured from polypropylene oxide (polyether) polyol than from polyols based on polybutadiene (partly unsaturated hydrocarbon) or on polyethylene-polypropylene mixture (completely saturated hydrocarbon). In a more direct test⁽⁸⁵⁾ of bile acid and cholesterol uptake, polyurethanes manufactured from a 75/25 mixture of polyethylene oxide and polybutadiene polyols were found to be much more effective than polymers containing only one or the other polyol. Moreover, this mixture was noted⁽⁸⁶⁾ to perform much better than polyurethane prepared solely from polypropylene oxide polyol having the same solubility parameter. It was concluded⁽⁸⁷⁾, then, that the successful polymer formulation required both polar and non-polar domains on a microscopic scale to match the similar micellar structure of the absorbed molecules in solution and not simply an average polarity matching that of the average over the molecule. The author now holds a patent⁽⁸⁸⁾ on the manufacture and use of these polymers in the treatment of hypercholesterolemia and other lipid-related disorders.

Another active field of study has been the sorption from water of chlorinated hydrocarbons, particularly polychlorinated biphenyls (PCBs) and organochlorine pesticides, by polyurethane foam. Gesser et al.⁽⁸⁹⁾, using both polyether- and polyester-based foams, were the first to report the quantitative sorption of PCBs and their recovery with acetone and hexane for gas chromatographic analysis. The authors suggested that when used as a preconcentration medium both sampling of large water volumes and sample transport were greatly facilitated compared to solvent extraction procedures. The method was later tested⁽⁹⁰⁾ on

river water and municipal drinking water with the polyurethane foam replacing activated carbon in a standard adsorption metering apparatus. Many organic compounds were noted to be retained by the polyurethane aside from PCBs but were not specifically identified.

Using polyester foam, Uthe et al.⁽⁹¹⁾ extended the experiment to a large number of organochlorine pesticides in distilled water. However, only moderate sorptions were measured for each and it was found necessary to coat these foams with a silicone grease to produce quantitative extractions.

Bidleman and Olney⁽¹⁸⁾ applied the method to the collection of PCBs and DDT from the waters of the Sargasso Sea. The sorbed compounds were recovered by Soxhlet extraction with petroleum ether. It was discovered that these compounds reside in much higher concentrations in the surface layer of ocean than at greater depths.

A study by Bedford⁽⁹²⁾ indicated that only in relatively clear water did polyester polyurethane foam collect PCBs as efficiently as did Soxhlet extraction with hexane. Apparently, PCBs must be associated with particulate matter when present and thus pass through the foam largely untouched. They suggested that many fresh water lakes and open ocean would likely be sufficiently clean, however, to meet the requirements.

A more thorough study of PCB and pesticide retention by polyurethane foam was undertaken by Musty and Nickless^(93, 94). Quantitative (better than 90%) removal of thirteen organochlorine insecticides was reported but the efficiency of PCB retention was discovered to depend upon the particular PCB mixture involved. Recovery in both cases was with acetone and n-hexane and was stated to be much easier than desorption from

activated carbon. For different polyurethane foams, a correlation between their sorption of insecticides and of methylene blue appeared to exist although the authors perhaps incorrectly inferred that the latter involved strictly adsorption onto the surface⁽²³⁾. A test of the method on river water revealed the presence of several PCBs and insecticides in the River Avon.

A later study by Musty and Nickless⁽⁹⁵⁾ compared the PCB- and organochlorine insecticide-removing abilities of Amberlite XAD-4 resin, polyurethane foam, and a reversed phase liquid-liquid partition system based on Chromosorb W/n-undecane/Carbowax 4000 monostearate to that of solvent extraction. The comparison, made on tap and river water samples, showed similar results in all cases except for the absorption of one PCB (Aroclor 1260) which was substantially low for all methods but solvent extraction.

Lawrence and Tosine⁽⁹⁶⁾ tested both polyether- and polyester- based polyurethane foams along with activated carbon, polyvinylchloride and Amberlite XAD-2 and XAD-4 macroreticular resins for the sorption of PCBs from water and sewage. Although the polyurethane foams were said to be good sorbents, especially from aqueous solution, polyvinylchloride was the choice for removal of PCBs from sewage.

Some interest has also been expressed in the application of polyurethanes to the removal of phthalic acid esters (PAEs) from water. Gough⁽²³⁾ studied the sorption of an homologous series of PAEs onto one polyester and a variety of polyether polyurethane foams and the results were later reported by Gough and Gesser⁽⁹⁷⁾. Although the sorption was probably not universal enough to be of general use in preconcentration or cleanup, some interesting trends were noted resulting

from different polyurethane formulations or phthalate sidechain lengths. The authors surmised that two mechanisms of sorption were indicated by the data. Apparently, PAEs were first quickly adsorbed to the surface where the smaller ones especially were also susceptible to equally rapid desorption. However, for smaller PAEs diffusion into the bulk of the polymer to escape desorption was possible at a reasonable rate. The result gave maximum sorption for di-n-butyl phthalate under flow conditions with considerably poorer results for much longer and shorter sidechains. Some control over sorption was said to be possible with judicious choice of the polyurethane polyol. Recovery of PAEs was accomplished by acetone and hexane washes.

Carmignani and Bennett⁽⁹⁸⁾ later reported an apparent application of PAE removal to closed aquaculture systems. Experiments were conducted with di-2-ethylhexyl phthalate and a polyether polyurethane foam. Up to 98.6 percent removal of the phthalate was achieved at a single pass. However, no data with actual recirculating systems were presented. The contaminated foam bed was said to be rejuvenated by acetone and hexane washes.

The use of polyurethane foams to remove polynuclear aromatic hydrocarbons (PAHs) from water was first reported by Saxena et al.⁽⁹⁹⁾ who studied benzo(α)pyrene as a model compound. Very strong sorption from distilled water onto both polyester and polyether foams of various densities was found but sorption from tap and raw lake water was less complete. This was interpreted as indicative of adsorption taking place on particulates in these waters. Complete recovery of the benzo(α)pyrene was achieved by elution with acetone followed by benzene.

This study was later expanded to include six representative PAHs by Basu and Saxena⁽¹⁰⁰⁾. By heating the water prior to contact with the polyurethane, good retentions of all six PAHs were obtained but were still measured to be lower from raw lake water than from finished tap water. After elution from the foam and cleanup on Florisil columns, the materials were determined by gas chromatography or separated by thin-layer chromatography and detected fluorometrically. Using a portable sampler, the method was applied⁽¹⁰¹⁾ to ten city water supplies before and/or after treatment and the effectiveness of water treatment evaluated.

An interesting use for polyether polyurethane foam was reported by Tanaka et al.⁽¹⁰²⁾ who noted that alkylbenzene sulfonates (ABSs) were removed from slightly acidic water in the presence of excess crystal violet or methylene blue. The resulting blue complex on the foam could be used directly as a semi-quantitative measure of original ABS concentration or could be conveniently extracted into methanol for colorimetric measurement. Tests on several other polymers, including polyester polyurethane, were unsuccessful. The method was tested on river water samples and was said to be fairly rapid and sensitive but suffered slightly from some interferences.

A number of industrial applications of polyurethanes have also appeared in the patent literature. For example, Arkell et al.⁽¹⁰³⁾ described the use of polyurethane foam for the isolation of cyclohexylbenzene hydroperoxide from its reaction precursors and by-products in a hydrocarbon solvent. In finely powdered form, its use as a biologically compatible flotation agent in waste water purification was suggested by

Gubela⁽¹⁰⁴⁾. In addition, according to Matsuda and Masuda⁽¹⁰⁵⁾, poly-nitrodiphenylamines (used in the isolation of potassium from seawater) were said to be recovered very efficiently after use by sorption with polyurethane foam. Schlicht and McCoy⁽¹⁰⁶⁾ outlined the use of polyurethane foam for the extraction of phenols from various hydrocarbons and reported⁽¹⁰⁷⁾ that lubricating oils could be similarly upgraded by the selective removal of high viscosity components from less viscous ones. They also later reported⁽¹⁰⁸⁾ the removal of unwanted reactants and by-products from the production of amine-based oil additives and dispersants by the same method. Finally, Washburn et al.⁽¹⁰⁹⁾ demonstrated the ability of granular polyurethane to absorb many weak acids from dilute aqueous acidic solutions.

The list of chemical applications for simple, unmodified polyurethane foams (particularly in the patent literature) continues to grow almost daily and it is doubtful that anyone would be able to catch up or even keep up with it completely. However, the large scope of uses should be apparent even from this limited sampling.

b. Loaded Flexible Foams

One might logically predict that as the strengths and weaknesses of plain polyurethanes as sorbents became apparent to researchers, they would then seek methods of modifying the existing properties to extend the range of possible uses. Discovery, however, is seldom logical and much of the early work on the subject followed a more-or-less reverse order. As suggested earlier, there has been a general preoccupation with the physical rather than chemical properties of polyurethanes, particularly with polyurethane foam. Consequently, many of the initial experiments were performed with polyurethane in the role of an expectedly inert support possessing good flow properties on which other reagents could be physically positioned to do the work. Such uses, of course, continue to be popular today even though it is now apparent that interactions with the polymer cannot always be ignored.

Let us examine these uses, then, grouped again on the basis of the mobile phase. Before doing so, however, it is well to mention some of the methods by which it is possible to produce foams which include substances not normally present in polyurethanes.

First of all, one is occasionally able to include inert reagents directly in the polymer formulation prior to polymerization. This is not often feasible, though, since isocyanates are sensitive to so many functional groups and even small alterations in the surface tension of the prepolymer can seriously affect foam formation. Quite often, liquids can be included in or on the foam simply by soaking the polyurethane directly in them and removing the excess by squeezing. Finely powdered solids could be similarly applied as a slurry. Another method

which can accommodate many liquids and solids is to allow the polymer to swell in a solvent (such as acetone) in which the substance is soluble and then to remove the solvent by evaporation. This enables the deposition of smaller but reproducible amounts of the substance to take place. Likewise, small amounts of a few substances may also be acquired by true absorption from a solvent in which they are less soluble than in polyurethane. Finally, fine precipitates can often be generated on the foam material by reactions between substances already absorbed there and solutions brought in contact with the polymer. Thus, by careful choice of one or another of these methods, the immobilization of nearly all substances on polyurethane foam is possible and its scope of uses can be broadened considerably.

1) Sorption from Gases

Strangely, although the application of unmodified foams to chemistry had its roots in the gas phase, not a great deal of interest has been expressed in the use of loaded polyurethane foams for the removal of substances from gases.

Only two such genuine reports were encountered in this survey. One of these is the patent granted to Moroni and Kalbow⁽¹⁶⁾ in which mention is made of the possibility of including substances to react with sulfur- and nitrogen-containing gases in a polyurethane air filter. The second is the patent of Imanaka and Yoshida⁽¹¹⁰⁾ who prepared a polyurethane foam air filter containing Ag_2O and CuO precipitates and tested it on ammonia removal. The scarcity of work in this area compared to plain polyurethane foam is somewhat baffling but presumably more will follow in the future.

2) Sorption from Liquids

In contrast to its use for gases, loaded polyurethane foam has been very well exploited for the sorption of substances from liquids. For convenience, discussion of the field will be divided into applications first to organic and then to inorganic compounds.

The first report of any kind was made in 1965 by Bauman et al.⁽¹¹¹⁾ In it, the authors described the preparation of polyurethane foam pads bearing horse serum cholinesterase in starch and glycerine gel which was physically immobilized onto the surface. Their use in an electrochemical monitoring device (later called the Continuous Aqueous Monitor or CAM-1) for the enzymatic detection of various cholinesterase inhibitors in water or air was outlined. Some modifications^(112, 113) of the immobilizing method to eliminate glycerine and to include aluminum hydroxide in the gel substantially improved the lifetime of the pads. Basically, the system operates by first exposing the pads for a fixed period of time to an aqueous stream suspected of containing substances which inhibit the enzyme cholinesterase. In the case of water monitoring, the sampled water is used directly while air monitoring requires a preliminary scrubbing step to obtain the inhibitors concentrated in an aqueous stream. During this period of time, inhibitors are sorbed from solution and a portion of the enzyme is inactivated. In the second step, a substrate solution is pumped over the enzyme-coated foam pad where the substrate is hydrolyzed to an electroactive species in proportion to the amount of active enzyme remaining. Electrodes placed in contact with the pad respond to the amount of electroactive species produced and thus inversely to the cholinesterase inhibitors. The CAM-1 monitor repeats



these two steps cyclically to give nearly continuous analysis and provisions are made for automatic alarm signals and periodic changing of the foam pads. Tests of response to various substances^(114, 115) showed high sensitivity to organophosphate and carbamate insecticides but very little to chlorinated hydrocarbons, herbicides, fungicides or rodenticides. Two patents^(116, 117) have been issued for the air-monitoring aspects of the device and Goodson and Jacobs⁽¹¹⁸⁾ have provided a good general summary of the work.

In the area of oil recovery from water, Cadron and Jourquin⁽⁵⁴⁾ obtained a patent in 1971 which included the pretreatment of polyurethane foams with fatty acids, amines, cationic agents or silicones to upgrade their performance. Later, Sumida and Kataoka⁽⁶⁷⁾ were granted a patent for the use of soft paraffin on polyurethanes for the same purpose and reported quite substantial improvement. In both of these cases, as mentioned earlier, use is made of the fact that the contents of the foam cells are strongly influenced by the material absorbed into the cell walls and strands.

Uthe et al.⁽⁹¹⁾ were the first to apply a column of polyester polyurethane foams coated by the solvent swelling method with various chromatographic grade greases to extracting several organochlorine pesticides from water. Foam performance was said to be improved considerably by the addition of the grease. The sorbed insecticides were eluted from the foam with acetone followed by hexane for gas chromatographic analysis. The method was proposed as an alternative to biological monitors wherever they may be impractical or unreliable and was tested on both river water and soil leachates in the laboratory.

A later publication⁽¹¹⁹⁾ described the use of such foam plugs coated with Dow Corning DC-200 silicone grease as indwelling monitors for both polychlorinated biphenyls (PCBs) and organochlorine insecticides in surface waters of industrial or agricultural origin. The individual polyurethane foam plugs were left anchored in the flowing waters for many hours suspended from a float and then extracted and analyzed in the usual way. Although the method seemed very useful, it was noted that the interior of the cylindrical foam pieces did not appear to be participating fully in the sorption process. Reconsideration of the geometry of the foam pieces would probably improve this greatly.

A further study on this topic was undertaken by Musty and Nickless⁽⁹³⁾ with several foam types and various gas chromatography greases deposited by the solvent swelling method. Again, PCBs and organochlorine insecticides were sorbed from river water. It was discovered that while the various greases aided the sorption when flow rates were high, they merely inhibited the ability of plain polyurethane foam at low rates of flow. This difference apparently reflects an increased rate of diffusion of materials away from the surface in the presence of the greases but with an accompanying decrease in the actual affinity of the loaded polymer for them.

Both polyether and polyester foams bearing DC-200 were similarly tested by Gough⁽²³⁾ and reported by Gough and Gesser⁽⁹⁷⁾ for the sorption of phthalic acid esters (PAEs) from water. However, the coated foams did not operate appreciably better than without treatment and, in agreement with the previous results⁽⁹³⁾, were slightly inferior at low rates of water flow.

In his comparison of polyurethane foam, Amberlite XAD resins and solvent extraction for isolating fuel oil, paper mill wastes and textile dyes from water, Webb⁽⁸²⁾ concluded that polyurethane foams with or without various chromatographic grade grease coatings were not very effective. Solvent extraction was said to be the most reliable method of absorption.

Saxena et al.⁽⁹⁹⁾ also made a comparison between uncoated polyurethane and that coated by solvent swelling with DC-200, SE-30 or a nematic liquid crystal for the preconcentration of benzo(α)pyrene from water. The authors noted marginal improvements due to the coatings but they also found large amounts of these substances to be co-eluted by the organic solvent used to recover benzo(α)pyrene. This was thought to be sufficiently objectionable to preclude their use where further concentration of the eluate for analysis was to be attempted.

An interesting application of polyurethane foam loaded with a solid coating material has been reported by Huckins and coworkers⁽¹²⁰⁾. The authors found that powdered charcoal adhered very strongly to the surface of finely chopped polyether polyurethane foam and in this form could be packed easily into columns having good flow properties. These columns proved to be useful for the selective adsorption of the highly toxic polychlorinated dibenzodioxins and dibenzofurans from Herbicide Orange (a mixture of 2,4-dichlorophenoxyacetic acid and 2,4,5-trichlorophenoxyacetic acid for military use as a defoliant). The adsorbed compounds could then be recovered by a toluene/benzene solvent mixture for gas chromatographic analysis after some additional sample clean-up. This method was said to make very efficient and convenient use of very small amounts of powdered charcoal.

We can begin our consideration of the inorganic side of things by mention of the fact that Bowen⁽²⁸⁾, in the initial work which led to his discovery of the sorption properties of polyurethane foam, tested it first as a solid support for diethyl ether in extractions. Since the results were never published, it can probably be assumed that no particular advantages of this combination over plain polyurethane foam were noted, however.

A much later publication by Sukiman⁽³⁴⁾ confirmed this general lack of improvement when polyurethane treated with methyl isobutyl ketone, diethyl ether, ethyl acetate or isopropyl ether was compared with untreated foam for the sorption of gold from aqueous solution.

A more positive application was disclosed by Higashi and Miyake⁽¹²¹⁾ in a patent for the extraction of metal ions by fibers or foams impregnated with liquid ion-exchangers. In it, polyurethane foam loaded with di-2-ethyl-hexyl phosphoric acid was employed for the quantitative removal of Cd(II) ions from water with suggestions of possible uses in wastewater treatment.

The practice of including a liquid ion exchanger in polyurethane was also tested by Braun and coworkers⁽¹²²⁾ who deposited tri-n-octyl amine (TNOA) on polyether foam by the solvent swelling method with benzene. The product was found to be able to extract Co(II), Fe(III) and Cu(II) from aqueous hydrochloric acid solutions and could be used in columns to separate these three metals from one another and from Ni(II) (which was not retained). The cobalt/nickel separation was studied in some detail; its success was found to be somewhat dependent on the amount of TNOA loading the foam.

At a later date, a similar approach was again used by Braun and Farag⁽¹²³⁾. Small bits of polyether foams soaked in a mixture of Amberlite LA-1 (N-dodecyl-(trialkylmethyl)amine) and α -dinonylphthalate (as plasticizer) were shown to be very effective as qualitative and semi-quantitative colorimetric reagents for Co(II) when shaken with aqueous thiocyanate solutions. The performance in cobalt identification was said to be superior in sensitivity and speed to existing spot and other tests but no trials of foam in the absence of the liquid anion exchanger and plasticizer were reported. Likewise, foams bearing α -dinonylphthalate solutions of dithizone were said to give specific colour reactions with Zn(II) and Pb(II) while rubeanic acid was suitable for Cu(II) identification. The name "chromofoams" was coined by the authors to describe the concept of colour-forming reagent-loaded foams.

The liquid anion exchanger Amberlite LA-2 soaked into polyether polyurethane foam was utilized by Maloney et al.⁽⁵⁰⁾ for the removal of Cd(II), Fe(III), Hg(II), Sn(IV) and Zn(II) from hydrochloric acid solutions while excluding Ni(II), Co(II), Cu(II) and Pb. Comparisons with various solid resin anion exchangers revealed extraction rates intermediate between those of coarse and fine mesh resins with nearly the same capacities.

A report by Vernon⁽¹²⁴⁾ has described the usefulness of Kelex 100 (7-dodeceny1-8-hydroxyquinoline) and LIX 65N (an alkyl β -hydroxybenzophenone oxime in kerosene) incorporated into polyurethane foam by the solvent swelling method for the sorption and separation of Cu, Zn, Al, Cd, Co, Cr, Hg, Mn, Ni, Pb and U ions from mildly acidic solutions. With these two chelating liquid ion exchangers, equilibrium was said to be reached rapidly so that column operation was feasible. All elements

except mercury were quantitatively recoverable. Comparison of the two complexants showed Kelex 100 to be the more efficient at collection but LIX 65N was said to be more selective.

The liquid anion exchanger tri-n-octylamine (TNOA) was also used to very good advantage in an isotope exchange system developed by Palagyi and Bila⁽¹²⁵⁾. These workers found that $^{131}\text{I}^-$ could be effectively preconcentrated for analysis from aqueous solution by polyurethane foam bearing I_2 in toluene with or without TNOA included. Fairly high efficiency exchanges resulted, particularly with TNOA in column operation, due to the rapidity of the reactions involved and the outstanding hydrodynamic and mass-transfer properties of the polymer. The method was tested on drinking water and found to be free of most interferences. Successful application to the monitoring of milk was also reported⁽¹²⁶⁾ and it was said to be a very rapid and inexpensive technique for this purpose.

A modification was later described by Palagyi and Braun⁽¹²⁷⁾ which also made use of the flexible nature of polyurethanes. Polyether foam coated with I_2 and Alamine 336 (a commercial tri-n-alkylamine formulation) in toluene was packed into a plastic syringe and alternately expanded and compressed with the plunger while simultaneously drawing up and expelling the solution in a pulsed mode to exchange radioactive iodine. This method was said to be faster, simpler and more efficient than the column method and allowed even greater pre-concentration factors to be achieved. The technique was tested on tap water with final radiometric counting of the compressed foam directly in the syringe.

The production of foams possessing ion exchange properties has also been achieved by the incorporation of solid ion exchange resins

into the polymer. Braun et al. (128) reported the preparation of a heterogeneous cation-exchange foam from finely powdered Varion KS (sulphonated polystyrene) which had been included in the polyurethane polymer formulation prior to foaming. Problems with the foaming process were said to be encountered when the resin was in the H^+ ion form but not when in the Na^+ ion form. A product having good speed of equilibration and reasonable exchange capacity resulted. Later, an extensive evaluation of the column performance of this polymer in comparison with several resins in bead form was undertaken by Braun and Farag (129). Tests with solutions containing Cu, Cd, Zn, Fe(III) and Ca ions in various ethanol/water/hydrochloric acid mixtures showed slightly lower distribution ratios but superior kinetic and flow behaviour for the packed foam bed.

Some interesting applications of the heterogeneous cation exchange foam have also been described. Braun and Farag (130), by converting the exchanger to the Ag^+ ion form and then treating it with sodium sulfide solution, produced a foam containing finely-divided Ag_2S precipitate. This was used very successfully for the isotope exchange separation of ^{111}Ag from dilute nitric acid solutions. The method was said to be applicable, in principle, to many other metals as well. In a slightly different twist to the process, the authors also reported (131) the use of foam containing finely-divided copper (prepared by placing the exchanger in the Cu^{2+} ion form followed by reduction with sodium hydrosulfite to the metal). This foam was also suitable for the exchange of radiosilver but this time by a redox mechanism.

As with other support media, polyurethane foam has also seen

extensive application coated with a variety of specific complexing agents. By soaking the foams in basic aqueous acetone solutions of the complexants, Mazurski⁽³⁶⁾ prepared polyester foams containing sym-diphenylcarbazine, dithizone, diphenylcarbazone and dimethylaminoazobenzene. Each of these, after washing, was tested for sorption of mercuric chloride and methylmercuric chloride. Considerable improvement was noted over plain polyurethane foam but the study was not pursued further. Brief tests with Cr, Cd, Mo, Cu and Ni ions revealed no sorption of these metals by any of the treated foams.

Later, more detailed work by Chow and Buksak⁽³⁷⁾ was reported on polyester foams loaded with dithizone by the solvent swelling method for mercury(II) and methylmercury(II) removal. Nearly quantitative extractions were possible and the metal was said to be firmly held by the foam. Several metals also present in solution did not interfere and recovery with acetone was said to be quantitative. The method was applied to tap, river and sewage waters with acceptable results.

Polyether foams carrying dithizone or zinc dithizonate in chloroform, di-n-octylphthalate (DnOP), tri-n-butylphosphate (TBP), or α -dionylphthalate (α DNP) were prepared by Braun and Farag⁽¹³²⁾ by means of simple soaking. These foams were tested for the collection of trace silver from aqueous solution and found to be effective. Because of improved storage life, the zinc salt was said to be the more desirable form of the complexing agent. The presence of the various phthalates was shown to improve the rate of silver uptake dramatically, apparently as a result of a plasticization effect on the polymer.

Braun and Farag⁽¹³³⁾ also applied the zinc dithizonate as well as

zinc diethyldithiocarbamate polyether foam to the successful removal of mercury(II) from water. Again, comparisons were made of the effectiveness of the zinc dithizonate foam with and without a plasticizer, TBP, added. In addition to speeding up sorption, the recovery by sodium thiosulfate solution was also found to be faster with the TBP present on the foam. Quantitative removal and recovery were said to be possible with both complexing agents.

In a later paper, Braun and Farag⁽¹³⁴⁾ described radioisotope exchanges based on polyether foam bearing I_2 or silver dithizonate with TBP as a plasticizer. These foams, again produced by simple soaking, were able to remove, respectively, $^{131}I^-$ or $^{111}Ag^+$ quickly and quantitatively from aqueous solutions with very little interference from other ions present.

The use of dithizone-treated (by solvent swelling in chloroform) foam was also reported by Musty and Nickless⁽⁹⁴⁾ for the removal of Zn, Cu, Cd, Co, Ni and Pb ions from aqueous solutions followed by elution with nitric acid. Very few details were given, however. Suggestions for the possible use of sodium diethyldithiocarbamate or 8-quinolinol for metal ion sorption were made.

Diethyldithiocarbamate and 1-nitroso-2-naphthol polyether foams have also been prepared⁽¹³⁵⁾ with or without TBP as a plasticizer. Collection of cobalt(II) from nearly neutral or basic aqueous solutions by these foams was said to be quantitative for either complexing agent. In both cases, the presence of the plasticizer was noted to increase the rate at which equilibrium was achieved.

Lypka^(38,39) studied the sorption of copper(II) and cadmium(II)

on polyether and polyester foams loaded by solvent swelling with benzoyl-acetone. Reasonably efficient removal was noted and was said generally to parallel solvent extraction in behaviour. Less detailed observations were made also on beryllium(II), silver(I) and gallium(III) sorption by this foam.

Polyether foam loaded with dimethylglyoxime(DMG) has been prepared by Lee and Halmann⁽¹³⁶⁾ (again by solvent swelling) and studied extensively for nickel(II) sorption from slightly basic solutions. The efficiency of sorption was noted to decline considerably at low concentrations of nickel(II), as with conventional precipitation methods. However, the authors noted that while this complex, Ni(II)-salicyldioxime and Cu(II)-salicyldioxime colloids were all removed from solution by foam, others such as AgCl and Fe(OH)₂, were not. This suggests specific interactions with the foam material rather than a simple filtering process is involved. Cobalt(II) was said to interfere strongly with the nickel(II) sorption but Cu(II), Fe(II), Fe(III), Zn(II) and Cd(II) were without effect.

The preconcentration of antimony(III) and (V) from distilled, river and seawater by polyether foam soaked in a benzene solution of 1,2-ethanedithiol has been reported by Valente and Bowen⁽¹³⁷⁾. Rapid and nearly complete extraction of the metal and its subsequent recovery by acetone were achieved regardless of the water type. This foam was also found to retain mercury and arsenic ions but excluded many others. A subsequent report⁽⁴⁵⁾ by these authors described the use of polyether foam bearing sodium diethyldithiocarbamate in carbon tetrachloride for the nearly quantitative and selective extraction of Sb(III) in the pre-

sence of Sb(V) as well as Sn and Zn ions. Any Ag, Cd, Fe(III) or Hg ions present were also extracted, however. Elution of the sorbed complexes was accomplished by acetone wash. The method was tested on lake water, seawater and sewage effluent with similar results in all cases.

Polyether and polyester foams bearing the complexing agent pyridylazonaphthol (PAN) with and without α -dinonylphthalate as plasticizer have been tested for extraction of cobalt, iron and manganese ions by Braun, Farag and Maloney⁽⁴⁹⁾. The 2:1 complexes of PAN:metal ion were apparently extracted in each case and quantitative uptake was possible for cobalt and manganese. The rate of extraction for the Co-PAN complex was found to be slightly higher for the plasticized than for the unplasticized foam. A number of anions were checked for their possible effects as selective masking agents for or interferents of the extractions. Separations of the three elements were said to be possible.

A polyester-type foam bearing PAN without any plasticizer has also been used in an indwelling sampler described more recently by Srikameswaran and Gesser⁽¹³⁸⁾. By use of a small battery-operated foam squeezing device containing the treated foam plug, it was found possible to preconcentrate low levels of Cu, Zn and Hg ions from a large volume of water in which the squeezer sits. The uptake of each metal from solution appeared to be quantitative on every squeeze made. The complexed metals were eluted from the foam with chloroform after a fixed period of time for atomic absorption or even spectrophotometric analysis.

Although serving in many instances as an efficient plasticizer of polyurethane foam in conjunction with other complexing agents, tri-n-butylphosphate (TBP) has also found much use alone for metal complex

sorption. In 1972, Braun and Farag⁽¹³⁹⁾ described the application of polyurethane foam loaded by soaking in TBP to the extraction of palladium(II) and its separation from nickel(II) in solutions containing thiourea and perchloric acid. The polyether foam was found to accommodate higher loadings of TBP and allowed much greater flow rates than other stationary supports used for this purpose. This study was later extended⁽¹⁴⁰⁾ to include bismuth(III) as well in a column separational method. The results of these more detailed investigations suggested that the TBP-loaded foam had a very high mass transfer rate both to the surface and within the bulk of the polymer. At the same time, the authors described a new method of column packing by vacuum which was particularly well-suited to use on loaded polyurethane foam. In a subsequent publication⁽¹⁴¹⁾, the Pd(II)-Bi(III) thiourea separation was also used as a demonstration of the improved bed homogeneity to be had by application of this method to a regular reversed-phase column, TBP-loaded Voltalef (polytrifluorochloroethylene) powder.

TBP-loaded polyether foam columns were also found to be useful in the enrichment and separation of gold(III) from acidic aqueous solutions containing various amounts of thiourea and perchlorate. In a detailed study of the phenomenon by Braun and Farag⁽¹⁴²⁾, it was surmised that the extracted species was probably $[\text{Au}(\text{H}_2\text{NCSNH}_2)]\text{ClO}_4 \cdot 4\text{TBP}$ when thiourea was present and apparently AuCl_4^- when it was not. In the former case, the Au-thiourea complex could not be removed from the foam by aqueous ammonia while in the latter case, on the other hand, the gold was said to be stripped by this treatment. The authors found that small amounts of Au(III) could be quantitatively separated from large amounts

of Zn(II), Co(II), Ni(II), Fe(III), Cu(II), Sb(III), Bi(III) and Pd(II) taken several at a time but not from silver(I). Removal of the sorbed gold, however, was very difficult and quantitative recovery required dissolving the foam. In a sequel publication⁽³³⁾, comparisons were made between TBP-loaded polyurethane, TBP-loaded Voltalef powder and active carbon for gold sorption. It was concluded that polyurethane foam outperformed the Voltalef material and was similar to carbon in rate of sorption but somewhat lower in efficiency. At the same time, measurements of the amount of TBP absorbed by polyether and polyester type polyurethanes showed the polyether variety to be superior.

The TBP-loaded polyether foam column was also employed by Braun et al.⁽¹⁴³⁾ for the separation of Fe(III) from Co(II), Cu(II) and Ni(II) in hydrochloric acid solutions. Resolution of these last three from each other was not possible but Fe(III) was easily separated from them individually.

An application of loaded polyurethane foams to analysis which does not strictly involve the sorption of metals from solution was also devised by Braun et al.⁽¹⁴⁴⁾. The authors prepared polyether foams carrying tetrachloro-p-benzoquinone (chloranil) as a redox reagent by solvent swelling in methyl isobutyl ketone or in chlorobenzene. Such foams contained finely-divided chloranil on the surface and were able to reduce various metal ions on contact while passing through a column of the material. The redox reagent could subsequently be regenerated with ascorbic acid and used for the analysis of oxidizing agents indirectly. The method was applied successfully to Ce(IV), V(V) and Fe(III) and also compared to a similar one using Kel-F (polytrifluoro-

chloroethylene) powder instead as the solid support. The polyurethane foam column was said to be preferable owing to its faster flow rates. In later work, Braun and Farag⁽¹⁴⁵⁾ modified the procedure somewhat to use a pulsed column technique in which the solution is alternately drawn up into and expelled from a syringe packed with the loaded foam. Further improvements were also achieved with foams still retaining some of the swelling solvent and with solutions heated to 80°C prior to reduction.

In addition to the foregoing publications, a patent⁽¹⁴⁶⁾ has been granted to Szabo, Braun and Haklits for the fixation of organic chelating agents and inorganic complex-forming substances in open cell polymer foams for purposes of detection, separation or enrichment of elements. This would seem to cover a great deal of the loaded polyurethane foam applications presented here.

As a final note in the discussion of loaded polyurethane foams employed as sorbents, some mention should perhaps be made of the closely related topic of silicone rubber foams used in the same way. Although no conscious effort was made to seek information published on uses of silicone rubber foams, a few interesting articles became apparent while searching authors who have published papers dealing with polyurethane foams.

For example, Mazurski⁽³⁶⁾ described the preparation of silicone rubber foams containing either dithizone or sym-diphenylcarbazine by mixing a small volume of their acetone solutions into the prepolymer prior to foaming. The resulting foams were tested briefly for sorption of mercury(II) and methylmercury(II) from aqueous solutions but were

found to work only marginally better than pure foam.

Later, Grégoire^(147, 148) studied silicone rubber foams onto which dimethylglyoxime (DMG) had been deposited by the solvent swelling method. This foam was tested extensively for palladium(II) sorption and less thoroughly for nickel(II) as well. Both metals were found to be retained well and a separation of palladium from platinum was possible. Other foams prepared by including α -benzoinoxime or Srafion NMRR chelating ion exchange resin in the prepolymer prior to foaming were not successful in removing palladium.

Baghai and Bowen⁽¹⁴⁹⁾ later applied silicone rubber foams soaked in tri-n-octylamine (TNOA) to the separation of iridium(IV) from rhodium(III). The separation required quite drastic solution conditions (strong acid, perchlorate ion and chlorine) but was achieved, nonetheless. The sorbed iridium(IV) was eluted by ethanol and the TNOA recovered for potential recycling.

In summary, then, it can easily be said that although many good uses of loaded polyurethane (and other) foams have already been developed, many more employing different reagents or more ingenious applications will undoubtedly follow in the future.

c. Chemically Modified Flexible Foams

Although many needs as a sorbent material are adequately satisfied by the excellent properties of plain polyurethane foam and many more by the large variety of loadings possible, occasionally there are advantages to preparing foams which themselves carry chemical groups not normally found in a polyurethane. This can be accomplished either by careful meddling with the prepolymer formulation prior to foaming or by chemical attack in some way on the already-formed polymer. Thus, it is possible to prepare polyurethanes which contain many complexing or other groups chemically bonded directly to the skeleton. However, this generally involves a good deal of time-consuming preparative work and it is thus not surprising that few workers have seen a need urgent enough to attempt the production of modified polyurethanes.

In classifying reports of polyurethane uses into this category, the criterion used is whether or not covalent chemical bonds have been broken and/or formed in the process of foam modification. This is often difficult since many authors either do not state their intention to achieve a chemical change by the foam treatment they describe (but may have unwittingly accomplished one) or, having declared this intention, fail to test the resulting polymer adequately to see if they were successful. Thus, the dividing line between chemically modified and merely physically loaded foam is at least a little fuzzy. The following is a presentation of the known uses of chemically modified foams as sorbents. All reports to date have been for sorption from the liquid phase only.

Certainly the first application of chemically modified polyurethane

foam was claimed in 1969 by Evans, Mage and Peterson⁽²⁷⁾. Using reticulated polyester foam, the surface was treated with a variety of biomolecules and polymers in an attempt to decrease its ability to bind guinea pig erythrocytes non-specifically. The surface was then treated with antibodies to effect specific binding of erythrocytes bearing particular haptens. The experiments were moderately successful in enabling enrichment (but not complete isolation) of certain cell types. Another paper⁽¹⁵⁰⁾ advanced this one step further by using an erythrocyte-containing foam to bind specifically spleen cells produced in another animal in immunologic response to these same erythrocytes. Again, reasonable enrichment was obtained and the various bound cells were easily removed simply by squeezing the foam. Judging from the difficulty experienced in removing some of the substances used to treat the surface, the authors concluded that those substances carrying amino, carboxylic acid or phosphoric acid groups must be covalently bonded to the polyurethane. Acid-exchange and amide-forming reactions were suggested as possible mechanisms for this attachment but the conditions used seemed too mild to effect appreciable reaction in this way. No further chemical evidence for covalent attachment was presented and it would seem, in hindsight, that perhaps other strong but less permanent modes of interaction were probably involved instead.

Another chemical modification of polyester polyurethane foam was described by Mazurski and coworkers^(36, 151). Foams bearing thiol(-SH) groups were said to be produced when polyurethane was exposed to an electrical discharge in a hydrogen sulfide atmosphere. The product, after extensive washing with water, was very proficient at accumulating

mercury(II) and methylmercury(II) ions from aqueous solution and could be stored for at least one month without noticeable loss of ability. The capacity, however, was not very high and no other confirmation of chemical bond formation was offered. Tests carried out with other metal ions (Cr(VI), Co(II), Mo(VI), Cu(II) and Ni(II)) indicated that they were not extracted appreciably. Any mercury ions sorbed were quantitatively recovered from foam by 2 M hydrochloric acid.

In his thesis, Mazurski⁽³⁶⁾ also reported the testing of polyester foam which had been pretreated by soaking in 2 M sodium hydroxide for thirty minutes. This action may possibly have hydrolyzed some of the ester linkages to produce pendant carboxylic acid and hydroxyl groups although no intention to do so was mentioned. These foams were said to extract mercury(II) and methylmercury(II) slightly better than untreated ones. In addition, several complexing agents (sym-diphenylcarbazide, dithizone and diphenylcarbazone) were brought into contact with polyester foam while soaking in sodium hydroxide solution. This treatment introduces the possibility of chemical attachment to any pendant carboxylate groups present but most probably with subsequent loss of complexing properties. In any event, if such attachment occurred, it can probably be ignored since a large excess of complexing agent was left coated on the foam in all cases.

Several techniques for the preparation of homogeneous ion exchangers in the form of foams were also described by Braun et al.⁽¹²⁸⁾ One method involved the deposition of styrene-divinylbenzene copolymer on polyether polyurethane by soaking the foam in an acetone solution of styrene, divinylbenzene and an initiator followed by polymerization in an oven. Anion exchange groups were then introduced by chloromethylation and

amination reactions. A second method relied on radiation grafting using methacrylic acid. Polyether foam was first exposed to ionizing radiation (generated by a Van de Graaff accelerator or by a ^{60}Co γ -ray source) in the presence of oxygen and then to a hot aqueous solution of methacrylic acid to attach carboxylic acid groups as weak cation exchangers. The capacities of these two types of foam ion exchanger were found to be up to 2.2 and 4.02 milliequivalents per gram, respectively, depending on the conditions of preparation. Both methods appeared to be entirely successful but were not favoured over heterogeneous ion exchange foam containing finely ground bead-type resin since this was more easily produced.

Although these few offerings appear to represent the whole of modified polyurethane foam use to date, it would be wrong to leave the reader with the impression that this avenue of attack has reached a dead end. Rather, this is simply a trail which is as yet largely unexplored but will likely become well-trodden as synthetic chemists become more involved.

To prove this point, it should be noted that tailor-made polymers of many types are already available for specific metal ion or other binding. An illustration of this has been reported by Nyssen and Jones⁽¹⁵²⁾ who have prepared many complexing polymers for the purpose of mercury detoxification in humans. Some of these polymers are polyurethanes containing large numbers of thiol groups but have not been produced in the form of foams. The possibility surely exists, by very careful synthesis, of preparing polyurethane foams which combine coordinative and steric factors such that many other specific metal ion or organic complexations can be achieved and use can also be made of the outstanding hydrodynamic properties of foam.

2. Polyurethane Membranes

Polyurethane in the form of elastomeric membrane can be thought of as a much larger and usually thicker (from less than 0.1 up to several millimeters in thickness) piece of cell window from a foam. Indeed, the two forms of polymer are chemically quite similar and can be nearly identical except for the presence or absence of bubbles. Thus, where the foamed material is successful in sorbing substances from a fluid phase, a chemically-related membrane can also be expected to do the same. Where the process is adsorption, of course, relatively little uptake could be expected due to the relatively low surface area of the membrane. However, with absorption phenomena, passage into the polymer bulk and diffusion right through to the opposite side is possible.

In spite of the obvious utility of such a system for purifications, not many applications of polyurethane membranes seem to have been reported thus far. We will, nevertheless, distinguish between those involving gaseous and liquid phases.

a. Sorption from Gases

One very important application of polyurethane and other membranes was reported recently in a patent granted to the United States Institute of Gas Technology⁽¹⁵³⁾. In it, use was made of the permeability of the membranes to both hydrogen sulfide and carbon monoxide but not to methane in order to remove the first two components from natural gas.

In addition, a more recent patent to Elfert and coworkers⁽¹⁵⁴⁾ has described the separation by selective permeation through a polyurethane membrane of benzene and alkylbenzene vapours in preference to those of cycloaliphatics, esters, alcohols and other classes of compounds.

b. Sorption from Liquids

For use in the liquid phase, Davis and Stevens⁽¹⁵⁵⁾ described a separatory device consisting of an array of polyurethane membranes cast into the form of hollow fibers. With one liquid phase confined to the insides of the fibers while the other contacts the outside surfaces, the device was said to be suitable for reverse osmosis separations but no specific application was named in the abstract. Of course, many uses other than reverse osmosis should also be possible.

Following this, Horsfall⁽⁴²⁾ described the ability of a polyurethane membrane of polyether type to transport gallium(III) ions from aqueous solutions containing acid and chloride on one side into distilled water on the other. Gallium was found to be quantitatively transferred in this fashion, apparently as the HGaCl_4 complex which is soluble in the polymer. Other solution constituents (HCl , LiCl , etc.) apparently diffused much more slowly and thus a partial separation from them was achieved. These results were later published by Gesser et al.⁽¹⁵⁶⁾ and expanded to include similar diffusion experiments with iron(III) as well. It was observed that Fe(III) , but not Fe(II) , could be transported quantitatively across a polyether membrane from acidic chloride or bromide solutions apparently as the HFeX_4 complex ($X = \text{Cl}, \text{Br}$). Physical changes in the membrane were also said to take place as a result of the metal complex diffusion which rendered the polymer permeable to water. A preliminary remark was included which described the transport of uranyl ions (UO_2^{2+}) from aluminum nitrate solutions in a similar manner. Gupta⁽⁴⁸⁾ has elaborated on this most recently.

Another distinctly different type of employment reported recently

by Zentner and coworkers⁽¹⁵⁷⁾ has been as the encapsulating material for proposed controlled-release drug delivery devices. The authors suggested a variety of membrane types, including polyether polyurethanes, and tested their permeability to progesterone (as a model hydrophobic drug).

A few other reports⁽¹⁵⁸⁻⁶¹⁾ have also appeared dealing primarily with the mechanism of diffusion of small molecules (water, methanol, dioxane) through polyurethanes but we will not elaborate further on them.

As may be seen from the minute handful of publications, the application of polyurethane membranes to chemical separations has not yet blossomed. However, it would seem that the tremendous technical and industrial potential which exists in their use cannot go untapped for long.

3. Open-Pore Polyurethane

The two polyurethane products discussed thus far (foam and membrane) have in common the general use of rather long polymer polyols and low degrees of cross-linking in their preparation. These characteristics impart high flexibility and elasticity to the resulting polymers and, in turn, such traits undoubtedly account also for their remarkable fluid-like absorptive properties. On the other hand, of course, it is possible to produce more dense, less flexible polyurethanes from short polyols and with high degrees of cross-linking. These products are not expected to exhibit the same degree of fluidity in either a physical or a chemical sense as their elastomeric counterparts but might be anticipated to have more intense surface interactions owing to the high urethane group concentration. Although such products in solid form have been available for many years (and actually preceded foams and membranes), they have not found much use on the chemical scene.

At the 1968 meeting of the American Chemical Society, however, Ivan Salyer⁽¹⁶²⁾ was the first to announce the novel preparation of this material in a new porous ("open-pore") form by in situ polymerization. Basically, he prepared a polymer by combining at room temperature organic solutions of the reactants, a polyisocyanate (Mondur MR) and a polyol (LA-475) possessing its own self-contained tertiary amine catalyst. Under these conditions, the first bits of polymer precipitated act as nucleation sites where continued growth takes place only by diffusion to the catalytic surfaces of the sites. The result,

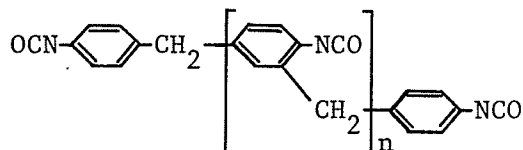

$$n = 0, 1, 2, 3$$

Mondur MR (Mobay Chemical Company)

or NCO-10 (Kaiser Chemical Company)

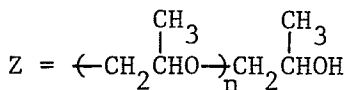
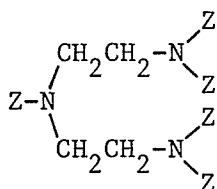

$$n \sim 3.4$$

LA-475 (Union Carbide Chemical Company)

open-pore polyurethane (OPP), is an agglomeration of tiny spheres (about 1 to 5 microns in diameter) which eventually grow to touch one another and to covalently bond at the points of contact. The intervening space (some 75 to 90 percent of the total volume) is filled only with solvent and unreacted materials, both of which can then be removed to leave a very porous solid. A patent⁽¹⁶³⁾ for the use of OPP as cigarette filters or oil absorbents was issued much later but Salyer also suggested that this product might be a suitable medium for chromatography.

Ross and Jefferson^(164,165), who were colleagues of Salyer at the Monsanto Research Corporation, pursued this suggestion and two years later reported details of column preparation as well as some applications to gas and liquid chromatography. They listed among the many advantages of the product its ability to be produced in columns of all sizes and shapes, its strong adherence to the column walls, high resistance to

chemical attack, chemically adjustable density, porosity and surface characteristics and the ability to accept large amounts of liquid phases either added directly to the reaction mixture or applied by coating after polymerization. The suggestion was also made that other functional groups could be covalently bonded to the polymer by reaction of suitable compounds with either isocyanate or hydroxyl groups present there. Separations of various aliphatic and aromatic hydrocarbons by gas-solid or gas-liquid chromatography were demonstrated and the separation of Cu(II), Co(II) and Co(III) heptafluorodimethyloctanedioates by liquid chromatography was shown. A patent⁽¹⁶⁶⁾ was subsequently obtained for the chromatographic uses of OPP.

Salyer et al.⁽¹⁶⁷⁾ later described their earlier infrared and other physical characterization studies carried out on OPP produced with various polyols and isocyanates, differing stoichiometries, catalysts, concentrations, reaction times, temperatures and solvent polarities. The LA-475/Mondur MR product was apparently the most desirable and was described as being highly compressible with considerable resiliency. Alteration of the other reaction parameters allowed reasonable control of the particle size, porosity and density to be achieved. Other possible applications to filtering, thermal, sound and shock insulation, or as binders for fibers or metal foams were also advocated.

Hileman and coworkers⁽¹⁶⁸⁾ similarly described the preparation and gas chromatographic properties of several LA-475/NCO-10 products of different densities. An optimum range was found outside of which polymers having either insufficient mechanical strength or restricted flow were obtained. Tests with various organic solvent and metal trifluoro-

acetylacetonate separations demonstrated that typical gas-solid behaviour was displayed by the uncoated polymer making separations based on polarity or hydrogen-bonding differences possible. On the other hand, OPP coated with Carbowax 400 or DC-550 silicone fluid lost all apparent polar characteristics. The authors also commented that if liquid phases were added which contained hydroxyl or other reactive moieties, columns bearing a bonded liquid phase might be produced by reaction with any free isocyanate groups remaining.

More recently, Chen, Hess and Sievers⁽¹⁶⁹⁾ have reported some improvements to the preparation of OPP columns for gas chromatographic use. A considerable reduction in peak tailing of polar molecules was said to be achieved when LA-475/Mondur MR OPP was produced with a 2:1 excess of polyol -OH to polyisocyanate -NCO groups. In this way, symmetrical peaks for alcohols or even acids were said to be produced. In addition, problems with the very limited thermal stability of the usual OPP product were also said to be greatly reduced by the substitution of a new polyol based on bisphenol, Epon 1001 (Shell Chemical Company), in place of LA-475. Column temperatures up to 300°C were then said to be tolerated without excessive decomposition.

The application of LA-475/Mondur MR OPP columns to liquid chromatography was described in 1974 by Lynn, Rushneck and Cooper⁽¹⁷⁰⁾. The authors found that stoichiometries ranging from 2:1 to 1:2 OH/NCO all produced useful columns with differing chromatographic properties. The OPP support was said to provide the advantage of a very wide dynamic loading range as well as a high tolerance to a great many solvents. In addition, the combination of very low back-pressure, good self-support and excellent adhesion to the column walls permitted low-pressure use

without the need for column inlet or outlet filters. Thus, injection directly onto the column was possible. The separation of dichloroaniline isomers was used as a demonstration of the column performance.

A similar liquid chromatographic study by Hansen and Sievers⁽¹⁷¹⁾ shortly thereafter showed many comparable results although only two different OH/NCO ratio polymers were tested. In addition, comparisons with the permeabilities of a variety of other liquid chromatographic packing materials showed OPP to be much superior to all of them in spite of some decreases in permeability resulting from swelling in a few solvents. Interestingly, the authors noted that solvent swelling of the polymer was apparently necessary in order to achieve sorption of many polar materials. A semi-preparative scale separation of phenol and chlorophenols was reported as a demonstration of the high capacities observed, particularly for the polymer containing excess hydroxyl groups. This was interpreted to mean that the excess polyol was acting as a bonded stationary phase although perhaps a more reasonable interpretation would be that the resulting decreased degree of cross-linking produces a more permeable polymer with consequently higher stationary phase utilization.

The unique capabilities of OPP packing to adhere tightly to column walls and to compress without breaking was used by Cooper and Lynn⁽¹⁷²⁾ to prepare high-efficiency coiled liquid chromatography columns. It was found that even though the OPP could be prepared in situ in a coiled configuration, this was unnecessary in practice since solvent-filled columns could be bent without any loss of separation efficiency. This is in sharp contrast to the behaviour of other types of column packing

material which undergo particle crushing and disruption of the packing geometry on such treatment.

A detailed investigation of the relative capabilities of alumina, silica gel, bonded phase and OPP columns for the liquid chromatographic separation of metal chelates has recently been reported by Tollinche and Risby⁽¹⁷³⁾. Using a number of β -diketonate and β -ketoamine metal complexes as well as numerous columns prepared in various ways, the authors found that a separation of the acetylacetonates of chromium and manganese was possible on OPP columns only if they had been coated with a second layer of the polymer. It was concluded that the OPP and OPP-coated silica gel columns had very poor efficiencies when compared to the other types.

Navratil, Sievers and Walton⁽¹⁷⁴⁾ have also studied the OPP prepared from LA-475/Mondur MR for the collection and preconcentration of polynuclear aromatic hydrocarbons (PAHs) from water. The six PAHs tested were said to be effectively removed from solution and quantitatively recovered into a small volume of methanol. Comparison of the breakthrough capacities of OPP formulations having 1:1 and 2.2:1 OH/NCO stoichiometries with those of Amberlite XAD-2 and Bio Rad AG MP-50 resins showed the 2.2:1 OPP polymer to be superior to the others while the 1:1 product was not. Elution from the OPP columns was also said to be more rapid than from the other sorbents and interferences from humic substances also present in water were said to be absent. At the same time, the authors tested the solvent resistance and ion-exchange properties of OPP. The polymer was found to be resistant to most solvents and dilute acids but detached itself from the column walls when exposed to bases.

No appreciable cation exchange capacity was noted but anion exchange capability of about 1.2 milliequivalents per gram was measured.

Most recently, Smith and Navratil⁽¹⁷⁵⁾ have described the use of LA-475/Mondur MR OPP for removing or preconcentrating linear alkylate sulfonates (LASs) from wastewaters. The polymer (OH/NCO = 2.2) was shown to have a high capacity for LASs and to be more effective than either active carbon or Amberlite XAD-4 resin at removing them from a synthetically prepared wastewater. The sorbed substances were easily recovered by methanol for either disposal or analysis. Since the uptake of other organic substances from wastewaters was found to be relatively low, the authors suggested that a separation of LASs from total organic carbon (TOC) might be possible.

In summary, then, it should be evident that OPP offers many interesting properties for use as a chromatographic support, as a purifier, and as a preconcentrator prior to analysis. Chromatographic columns containing OPP have been commercially available for several years. However, the apparent low efficiency of OPP compared to other available materials will likely limit its use to preparative applications or to situations where column cost is preeminent. The widespread replacement of existing treatment methods by OPP columns for industrial purification processes seems, somehow, unlikely but use in specific instances on relatively clean feeds may be possible. On the other hand, the use of OPP for preconcentration or sample clean-up prior to analysis is just beginning and cannot fail to see more pronounced growth in the years to come.

CHAPTER II. THE EXTRACTION OF COBALT FROM AQUEOUS THIOCYANATE SOLUTIONS BY POLYURETHANE FOAM

A. INTRODUCTION

1. The Discovery

The observation that cobalt could be extracted from aqueous thiocyanate solutions by polyurethane foam was made in a typically accidental fashion on June 16, 1976. Prior to that time, a great deal of well-planned effort had been expended to produce from prepolymer a chemically modified polyurethane foam bearing covalently attached complexing groups. It was hoped that this product might be useful in the extraction separation of rhodium and iridium but it was also tested on a number of other metals which were known to be efficiently bound by the parent complexing agent. When it was discovered that the polymer almost immediately developed a very appealing brilliant blue-green colour when brought in contact with aqueous ammonium thiocyanate solutions of cobalt(II), this was at first taken to signify the success of the complexing agent-bearing foam preparation. However, when it was then noted that a blank foam piece containing no such complexant yielded the same result, it was apparent that a new phenomenon was at hand.

Some quick tests were immediately made on a number of polyurethane foam types at hand and these showed that the sorption process was applic-

able to almost all of them. Also, preliminary measurements shortly thereafter indicated that cobalt was removed from solution both rapidly and almost quantitatively to produce the blue-green colour on polyurethane in proportion to the cobalt removed.

Since the cobalt-thiocyanate sorption process seemed to offer much promise in a number of potential applications and since no reports had hitherto appeared in the literature, a major and careful investigation of the phenomenon was launched at that time. The similar observations of others⁽⁴⁹⁻⁵¹⁾ subsequently appeared some one to two years later but did not discuss the topic very thoroughly. In particular, no systematic studies to try to elucidate the probable mechanism of this striking process were reported as we will be doing here. A portion of this work (most of which is referred to as "preliminary experiments" in the text following) has been presented at the second joint conference of the Chemical Institute of Canada and the American Chemical Society held in Montreal, May 29 to June 2, 1977.

Before beginning to present the results of our experiments, some background information on the chemistries of the two major constituents -cobalt and thiocyanate ion- will be offered as well as a brief discussion of possible extraction mechanisms to be considered.

2. The Chemistry of the Thiocyanate Ion (176)

Since the thiocyanate ion, SCN^- , plays an important role in the sorption of cobalt by polyurethane foam, we will consider some aspects of its solution chemistry which are pertinent to understanding its behaviour in this capacity.

a. Occurrence and Preparation

Both organic and inorganic thiocyanates are quite widespread in nature, occurring as flavour volatiles in a variety of plant products (e.g. mustard oils) and as a normal constituent of many animal body fluids (saliva, blood, urine and gastric juices).

Ionic thiocyanates may be prepared quite readily through the reaction between the cyanide ion and sulfur in some form (e.g. S_8 and a number of other sulfur compounds):



In the case of KCN as a starting material, for instance, the reaction with sulfur is both rapid and quantitative. Other sulfur-containing species such as the thiosulfate ion, $\text{S}_2\text{O}_3^{2-}$, also react in a similar manner:

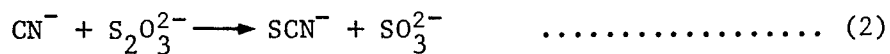

and this reaction has, in fact, been used in detoxification treatment in

cases of cyanide poisoning. On an industrial scale, however, technical grades of thiocyanate are produced chiefly as a by-product from coke-oven flue gases (as the source of sulfur) while the higher purity material comes in the form of the ammonium salt via the reaction between carbon disulfide and ammonia at elevated temperature and pressure:

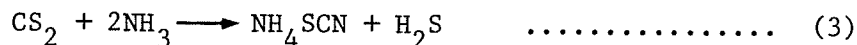

b. Structure

The thiocyanate ion is linear and has two tautomeric forms bearing the negative charge at either end of the ion. These forms are in equilibrium with one another and are represented in terms of the three major resonance structures:

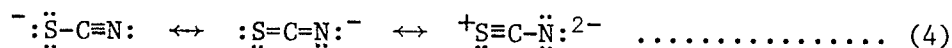

with the first two, of course, making major contributions to the overall electronic structure. The ion which formally bears a negative charge on the sulfur atom has been given the name "thiocyanate" (although this name is also used when no structural implications are intended) while the isomeric form carrying it on the nitrogen atom is given the special name of "isothiocyanate". In its compounds and complexes or even in solution, the actual formal placement of the charge in the ion depends upon the chemical environment in which it finds itself and thus it possesses an "ambident" character. This ability to bind to other species either

through its sulfur or nitrogen atoms (or, in fact, to act as a bridge in some complexes) makes SCN^- a particularly good ligand for a number of metal ions.

The thiocyanate ion has characteristic stretching frequencies in the infrared⁽¹⁷⁷⁾ at $2040\text{--}2050\text{ cm}^{-1}$ ($\nu_{\text{C-N}}$) and $740\text{--}750\text{ cm}^{-1}$ ($\nu_{\text{C-S}}$) and intense electronic absorptions at $220\text{--}240\text{ nm}$ ($\epsilon \sim 10^3\text{ mol}^{-1}\text{ L cm}^{-1}$) with a much weaker band at 340 nm .

c. Reactions of the Thiocyanate Ion

Along with CN^- , N_3^- , SeCN^- and TeCN^- , the thiocyanate ion has been termed a "pseudohalide" by virtue of its similarity in both chemical and physical properties to the halides. Thiocyanate is in many ways most similar to iodide in behaviour. We will outline some of its more important chemical reactions.

1) Protonation

In sufficiently acidic solutions, the thiocyanate ion forms either of two conjugate acids; thiocyanic acid ($\text{H-S-C}\equiv\text{N}$) or isothiocyanic acid (H-N=C=S). The H-N=C=S form normally predominates and has been variously assigned pK_a values ranging anywhere from 1.0 to -2.0 . In very acidic solutions, some possibility also exists of a second protonation to give HNCSH^+ .

Thiocyanic (or isothiocyanic) acid is a colourless gas at room temperature or a white solid at -110°C . Through hydrogen bonding, it is known to form addition compounds with many organic solvents such as ethers and alcohols (e.g. $\text{HNCS}\cdot\text{O}(\text{C}_2\text{H}_5)_2$ and $\text{HNCS}\cdot 2\text{CH}_3\text{OH}$). Dilute aqueous solutions of the acid are fairly stable when kept cold; however, they are

subject to decomposition by hydrolysis and/or polymerization at higher temperatures and concentrations to yield yellow then orange-red solutions. These modes of decomposition have been studied quite thoroughly and will be discussed next.

2) Hydrolysis and Polymerization

Owing to the formation of isothiocyanic acid, the thiocyanate ion is unstable in mineral acid solutions. The reaction pathway of decomposition depends both on the solution acidity and on the thiocyanate concentration. At high acidity and low thiocyanate concentration, the hydrolysis reaction predominates:

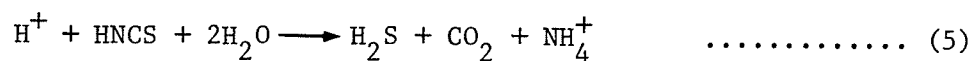

On the other hand, lower acidity and higher thiocyanate concentrations favour the polymerization reaction which leads (among other things) to the formation of yellow isoperthiocyanic acid, $(SCN)_2 \cdot H_2S$, with the elimination of hydrocyanic acid:

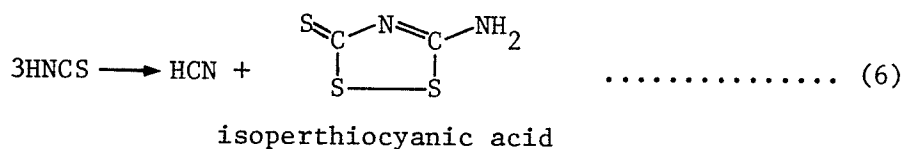

Other similar products of the same basic structure but replacing C=S with CCl_2 , CBr_2 or C=O groups may be obtained under specific conditions. Also, a variety of mixed polymers may occur in the presence of some other substances (such as isonitriles).

3) Oxidation of SCN^-

The thiocyanate ion is sensitive to attack by a number of common oxidants. In general, the products of reaction are sulfate and either cyanide or cyanate ions, depending on the solution pH. Sulfur dicyanide, $\text{S}(\text{CN})_2$, is also a product in some cases. The intermediate formation of thiocyanogen ($\text{N}=\text{C}-\text{S}-\text{S}-\text{C}=\text{N}$) has been suggested to occur in most instances.

Hydrogen peroxide, for example, destroys the thiocyanate ion by the reaction:

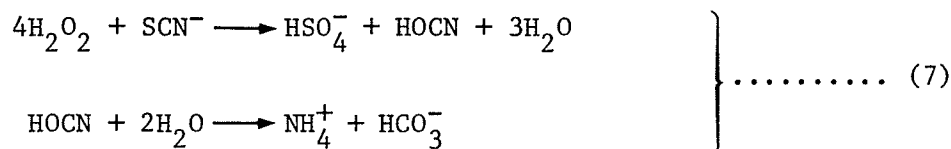

Either nitric or nitrous acids are also quite effective in oxidizing SCN^- by a rather involved mechanism but again to produce sulfate, cyanide and sulfur dicyanide. Iodine, on the other hand, yields only sulfate and iodine cyanide, ICN , as products.

A number of oxidations by metal ions have also been studied. Among these, the bleaching of the FeSCN^{2+} ion due to oxidation of SCN^- by $\text{Fe}(\text{III})$ is well known. The net reaction for this process is:

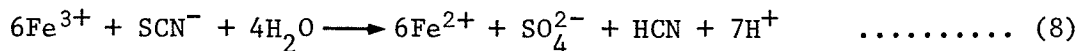

and it is speeded up by the presence of heat or light due to the formation of the SCN radical, an intermediate in the reaction. Chromium(VI), as CrO_4^{2-} , also oxidizes SCN^- in acidic solution according to the relation:

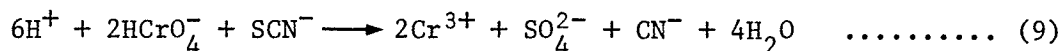

In addition, a number of Co(III) complexes have been observed to oxidize thiocyanate spontaneously to yield thiocyanogen and its polymeric products according to:



Thus, cobalt(III) complexes are somewhat less likely to occur in solution in the presence of thiocyanate ligands.

4) Coordination with Metal Ions

The thiocyanate ion can coordinate with a wide variety of metal ions and at least one homogeneous complex (i.e. containing only SCN^- ligands) has been isolated for each of the 30 elements in the d-block of the periodic table, most of the p-block, all of the lanthanides (except Pm(III) and Lu(III)) and many others, as well. Coordination numbers of 1, 2, 3, 4, 6 and 8 are all represented among these. In addition, a very large number of mixed complexes with a host of other ligands are also known to exist.

As already mentioned, thiocyanate exhibits linkage isomerism (i.e. it can coordinate either through the sulfur atom to give thiocyanate complexes, through the nitrogen atom to give isothiocyanates or can even act as a bridge between two different or similar metal atoms). Which of these modes is actually adopted depends on a large number of factors including the electronic configuration and size of the metal ion,

the solvent, the presence of other ligands accompanying counterions, crystal lattice requirements and even pressure. Consequently, the determination of which geometry is assumed in the large number of known thiocyanate complexes has occupied the attentions of many researchers (171, 178-89) using x-ray diffraction, infrared, Raman, NMR, electronic spectra and a variety of other techniques. It is found that all of the first transition series, the lanthanides, the actinides and the first half of the second and third transition series prefer N-coordination in homogeneous complexes whereas at Rh(III) and Ir(III) a reversal to prefer S-bonded complexes occurs. These preference trends follow the predictions of the theory of Hard and Soft Acids and Bases proposed by Pearson (190-91) in which the N and S ends of the thiocyanate ligand are regarded as being "hard" and "soft" bases, respectively.

A variety of coordination geometries including octahedral, tetrahedral, square planar and distortions of these are exhibited by the homogeneous complexes. Of special interest to us, of course, is the tetraisothiocyanato complex with cobalt(II), $\text{Co}(\text{NCS})_4^{2-}$, which has been determined to be tetrahedral in shape. Both thiocyanate and isothiocyanate complexes with a metal, M, are generally non-linear with the M-N-C or M-S-C angle ranging from just over 90° to nearly 180° .

d. Analysis of SCN^-

Thiocyanate ion is determined generally either by conversion to difficultly soluble and/or coloured complexes (e.g. AgSCN) or through oxidation of SCN^- followed by analysis of the products or measurement of the disappearance of reactants. There are a large number of examples

of each type of method; however, of most interest to us are only those colorimetric procedures based on the tetrakisothiocyanato complex of cobalt(II) which have been used both for the detection of SCN^- and of Co(II) for some time.

For thiocyanate detection, a number of simple spot tests have been reported. Although the characteristic blue colour had undoubtedly been observed before this time, in 1930 Kolthoff⁽¹⁹²⁾ described perhaps the first such test for SCN^- making use of the fact that 1% cobalt(II) sulfate would produce a complex with SCN^- which gave a blue-green colour with 40-50% aqueous acetone. A more sensitive spot test method was later described by Martini⁽¹⁹³⁾ using Co(II) , liquid vaseline and 1% acridine in 3M HNO_3 to form characteristic clumps of crystals with SCN^- . Zhivopistsev⁽¹⁹⁴⁾ and Zharovs'kii⁽¹⁹⁵⁾ also detected SCN^- by formation and extraction into chloroform of the blue Co(SCN)_4^{2-} complex in acid solution in the presence of diantipyrylmethane. Later, Hashi et al.⁽¹⁹⁶⁾ described a detection method based on spraying a test strip suspected of containing SCN^- with Co(II) sulfate then adding a few drops of acetone to the strip. If the blue colour in acetone disappeared in the presence of NH_3 , this was taken as positive identification. A method of quantitation was also developed by Senise and Perrier⁽¹⁹⁷⁾ who treated the sample with Co(II) perchlorate and perchloric acid and then measured the formation of the Co(SCN)^+ ion at 273 nm. Many more methods developed primarily for cobalt determination should also be applicable, in principle, to the analysis of thiocyanate and some of these will be mentioned later.

e. Properties and Uses

The thiocyanate ion and its salts possess several unique properties which have made them of some use in a number of different fields. For example, plants, algae, fungi and some marine life have a very low tolerance to many thiocyanates whereas they are of quite low toxicity to man and most animals (which, in fact, shun the taste of it). These facts render thiocyanate particularly useful in agriculture as a herbicide, defoliant, soil sterilizer, fungicide and insecticide. Also, the interesting property of acrylic polymers of being readily soluble in concentrated but not dilute aqueous thiocyanate solutions results in their use in the textile industry for the spinning of acrylic fibers. Thiocyanates have also been found to improve the uptake of dyes by various fibers and also to render the product more colourfast. In the photographic industry, as well, thiocyanates are used as stabilizers which retard fading and aging processes. In addition, the property of strong adsorption to metal surfaces has invited a number of applications in the field of corrosion inhibition and in improving performance in electrolysis and electroplating.

Of some interest is also the ability of thiocyanate to serve as a starting point for the synthesis of thiourea and many heterocyclic compounds. However, of prime importance to the majority of chemists is the combined ability of thiocyanate salts to be highly soluble in both aqueous and many organic solvents as well as forming complexes having similar solubility characteristics with a wide variety of metal ions. As a result, many liquid-liquid extraction and ion exchange separational methods have been developed based on these complexes. It has

generally been found that the relative extractabilities of these are sensitively dependent on many parameters including the metal and thiocyanate concentrations, the solvents used, the pH and temperature. Thus, slight differences between two metals in solution can be magnified by proper choice of extraction conditions to allow a good separation to be achieved. A very good review of the solvent extraction methods based on the use of thiocyanate has been published by Sultanova⁽¹⁹⁸⁾ and a less complete treatment for ion exchange by Singh and Tandon⁽¹⁹⁹⁾.

We will now consider the general chemistry of cobalt with some emphasis on its formation of complexes with the thiocyanate ligand.

3. The Chemistry of Cobalt (200-203)

a. Occurrence

Cobalt (atomic number 27; atomic weight 58.9332) is a bluish-white transition metal which was first recognized and isolated in about 1735 by Brandt. The element makes up only 0.001% of the earth's crust and is found in rocks, soils and ocean nodules. Cobalt ore is almost always found in association with those of other elements, especially Ni and As. Thus, more than 200 minerals contain cobalt and it is consequently a by-product of the extraction of many metals (e.g. Cu, Ni, As, Fe, Mn and Ag). Cobalt ore is usually of a very low concentration and so must be treated by any of a number of concentration processes in order to be made suitable for metal extraction. The exact treatment required varies considerably according to the type of ore used. Thus, cobalt is chiefly a coproduct of Ni mining in Canada, of copper in Zaire and of iron pyrite in Germany and each requires a separate concentration procedure. Although still essentially untouched, future recovery may be made from manganese-rich nodules containing Co, Ni and Cu found on plateaus some 10,000 feet deep in the ocean.

b. Properties and Uses

Cobalt itself is a brittle, hard metal with a very high melting point (1495°C), closely resembling both iron and nickel in appearance. The only naturally-occurring stable isotope is ^{59}Co . However, in 1937, ^{59}Co was first converted to ^{60}Co and $^{60\text{m}}\text{Co}$ by neutron irradiation. Both isomers decay to a non-radioactive isotope of nickel, ^{60}Ni , by emission of β - and γ -rays. ^{60}Co ($t_{1/2} = 5.26$ years) has numerous uses as a concen-

trated source of γ rays. Applications have developed, for example, in radiation chemistry research, radiography, cancer radiation therapy and various manufacturing process control devices.

The metal in its compact state is neither attacked by oxygen nor by water at temperatures below about 300°C. Above this, however, it is oxidized in air and finely divided Co is actually pyrophoric. The metal is readily dissolved by sulfuric, hydrochloric and nitric acids and more slowly by hydrofluoric acid to form cobaltous (Co(II)) salts ($\text{Co} \rightarrow \text{Co}^{2+} + 2\text{e}^-$; $E^\circ = +0.277 \text{ V}$). Cobalt also forms a nitrite after slowly dissolving in ammonium hydroxide and forms halides when combined with halogens. Cobalt will combine with most non-metals when heated or molten.

Cobalt is used in the production of numerous alloys, among them being superalloys, high temperature alloys, hard-facing materials, dental prostheses, osteosyntheses and tube-filament alloys. Also, in several ancient civilizations, the characteristic blue colours of its salts were used frequently in the colouring of glazes and glasses.

Since Co is ferromagnetic, it is also used in a wide variety of magnetic materials such as steels for permanent and soft magnets, the Alnicos (Al, Ni and Co) and ferrites. The fact that cobalt has the highest Curie Temperature (1121°C) makes it particularly important in high-temperature magnetic applications.

In biological systems cobalt is commonly found as derivatives of vitamin B₁₂ which serve as coenzymes for the oxidation of fatty acids. The absence of these coenzymes in sufficient quantities leads to pernicious anemia.

Cobalt has a valency of +2 or +3. The bivalent form is the stable state for the simple ion when it is coordinated to water ligands only since it is not subject to appreciable hydrolysis in aqueous solutions and the oxidation to Co(III) is very unfavourable ($\text{Co}(\text{H}_2\text{O})_6^{2+} \rightarrow \text{Co}(\text{H}_2\text{O})_6^{3+} + e^-$; $E^\circ = -1.84 \text{ V}$). The Co^{2+} ion in the complex state, however, is unstable and may be readily oxidized to Co^{3+} by ordinary oxidants (e.g. $\text{Co}(\text{NH}_3)_6^{2+} \rightarrow \text{Co}(\text{NH}_3)_6^{3+} + e^-$; $E^\circ = -0.1 \text{ V}$). Tetravalent Co exists only in fluoride complexes and in a series of binuclear peroxo compounds. Co(I) is equally uncommon.

c. Simple Compounds

Cobalt(II) forms a large number of simple compounds and hydrated salts; however, simple cobaltic (Co(III)) salts are confined to oxides, sulfides, sulfates, fluorides and acetates. Although only some of the more common ones are listed here, cobalt(II) forms hydrated salts with all common anions. So far as is known, all such hydrated salts are red or pink and contain octahedrally coordinated Co(II) with $\text{Co}(\text{H}_2\text{O})_6^{2+}$ being present in many of them.

1) Acetates

Both cobaltous acetate, $\text{Co}(\text{C}_2\text{H}_3\text{O}_2)_2$, and cobaltic acetate, $\text{Co}(\text{C}_2\text{H}_3\text{O}_2)_3$, are known. The Co(II) compound is easily soluble in water and forms monoclinic red-violet deliquescent crystals in both the anhydrous and tetrahydrate condition. The Co(III) salt forms green octahedral crystals and is readily hydrated in hot and cold water.

2) Carbonates

Cobaltous carbonate, CoCO_3 , occurs naturally in almost pure form as sphaerocobaltite. Its solubility in water is quite low. Cobaltic carb-

onate can be obtained as a green solution by oxidizing a cobaltous salt in the presence of sodium bicarbonate.

3) Carbonyls

Cobalt tetracarbonyl, $\text{Co}_2(\text{CO})_8$, is obtained as orange crystals which decompose above 51°C . Decomposition between $52-60^\circ\text{C}$ gives black crystals of cobalt tricarbonyl $\text{Co}_4(\text{CO})_{12}$. Both carbonyls are readily oxidized in air, insoluble in water but soluble in benzene and have very low vapour pressures.

4) Halides

Anhydrous compounds of Co(II) with each of the halides are known. All have structures in which the Co(II) ion is octahedrally coordinated. Only the fluoride of Co(III) has been produced, though.

Cobaltous bromide, CoBr_2 , can be prepared as a green anhydrous salt and as a red hexahydrate. Both are readily soluble in water and many organic solvents.

Cobalt(II) chloride is formed readily by dissolving the metal, oxide, hydroxide or carbonate in HCl. Evaporation of the solution gives the pink hexahydrate, $\text{CoCl}_2 \cdot 6\text{H}_2\text{O}$. Dehydration gives the blue anhydrous salt. The hexahydrate forms monoclinic crystals in which each Co atom is surrounded by four water molecules at the corners of a distorted square and by two chlorine atoms to form a distorted octahedron. The other two water molecules are not directly bonded to cobalt.

Cobaltous chloride is readily soluble in water and a number of organic solvents. The remarkable colour changes of the salts are put to many

uses. The pink colour of cobaltous chloride is favored by such factors as dilution, use of water as the solvent, absence of other salts such as those of the alkali metals and by low temperature. The blue form is favored by the opposite conditions. This phenomenon has been used in humidity and moisture indicators, temperature limit indicators in grinding pastes, etc.

Cobaltous fluoride, CoF_2 , is only moderately soluble in water while the corresponding Co(III) salt exists in both hydrated and anhydrous states.

Cobaltous iodide, CoI_2 , gives a pink solution when dissolved in water. However, on sublimation, the CoI_2 condenses partly as the yellow beta modification giving a colourless aqueous solution.

5) Hydroxides

When an alkali metal hydroxide is added to a solution of a cobaltous salt, cobalt hydroxide, Co(OH)_2 , is formed. The compound may appear blue, green or red depending on the conditions of formation but only the pink form is permanently stable. Cobalt(II) hydroxide has a very low solubility ($K_{sp} = 2.5 \times 10^{-16}$) but is amphoteric, dissolving in alkalis to form blue solutions of Co(OH)_4^{2-} ions. Co(OH)_2 is oxidized slowly by air and rapidly by strong oxidizing agents to a hydrated form of cobaltic oxide, $\text{Co}_2\text{O}_3 \cdot \text{H}_2\text{O}$. Because it has a high cobalt content, excellent storage stability and good handling properties, this is a convenient source for driers used in the paint industry.

6) Nitrates

When aqueous cobaltous nitrate is evaporated it yields red crystals of the hexahydrate, $\text{Co(NO}_3)_2 \cdot 6\text{H}_2\text{O}$. This compound is very hygroscopic and is readily soluble in many organic solvents. Cobaltic nitrate is unstable

and known only in solution.

7) Oxalates

Cobalt(II) oxalate, $\text{CoC}_2\text{O}_4 \cdot 4\text{H}_2\text{O}$, is readily soluble in aqueous ammonia while almost insoluble in water. It is used in the preparation of catalysts.

8) Oxides

Cobalt has three well-known oxides; cobaltous oxide, CoO , cobaltic oxide, Co_2O_3 , and cobaltosic oxide, Co_3O_4 . The cobalt oxides readily form solid solutions with one another and CoO reacts or forms a solution with numerous metals such as aluminum, tin, chromium and vanadium. It seems that Co_2O_3 may also exist only in a hydrated form whereas Co_3O_4 absorbs water but no definite hydrate has been identified.

9) Phosphates

Cobaltous phosphates are produced by heating cobaltous carbonate or hydroxide with phosphoric acid or alkaline phosphates to give anhydrous $\text{Co}_3(\text{PO}_4)_2$. The octahydrate $\text{Co}_3(\text{PO}_4)_2 \cdot 8\text{H}_2\text{O}$ is precipitated when aqueous solutions of cobalt(II) chloride and potassium hydrogen phosphate are mixed.

10) Sulfates

A pink heptahydrate, $\text{CoSO}_4 \cdot 7\text{H}_2\text{O}$, crystallizes from an aqueous solution when cobalt oxide, hydroxide or carbonate is dissolved in dilute sulfuric acid. This heptahydrate is found in nature as the mineral bieberite.

Oxidation of a solution of cobaltous sulfate in dilute sulfuric acid yields hydrated cobaltic sulfate, $\text{Co}_2(\text{SO}_4)_3 \cdot 18\text{H}_2\text{O}$. The solution is stable in dilute sulfuric acid but on addition of water it changes to cobaltous sulfate.

NaOH added to cobaltous sulfate precipitates a basic blue salt, $\text{CoSO}_4 \cdot 5\text{Co}(\text{OH})_2 \cdot x\text{H}_2\text{O}$. This is stable in its mother liquor or pure water but in the presence of NaOH the precipitated basic salt turns to pink cobaltous hydroxide.

11) Sulfides

Cobalt combines with sulfur to form ordinary cobaltous sulfide, CoS , two other cobaltous compounds, CoS_2 and Co_3S_4 , and a cobaltic compound, Co_2S_3 . The black precipitate which first forms on the addition of sulfide ions or H_2S to cobalt(II) solutions is usually taken to be CoS ($K_{\text{sp}} \approx 10^{-22}$). However, after storage for a short while, this oxidizes in air to give the much less soluble $\text{Co}(\text{OH})\text{S}$.

d. Color Changes of Cobalt Compounds

The colour phenomena of cobaltous salts both in the solid state and in solution have long been remarked on and studied. For example, aqueous solutions of cobalt chloride may be pink, red or blue depending on temperature, concentration and the presence of other ions. Red is favored by low temperature, dilution and the absence of alkali chlorides while blue is favored by the opposite conditions. Chlorides of zinc and mercury have been noted to change the blue of cobaltous chloride in alcohol to red.

Concentrated solutions in some organic solvents, like ethyl alcohol, are blue, but dilution with water yields the red form. Also, in the solid state, cobaltous chloride hexahydrate is pink while the anhydrous salt is blue. The blue is much more intense than the red (by about an order of magnitude) and can often mask the latter form.

Many hypotheses for these changes have been advanced but none is

completely satisfactory. Some of these theories include changes due to hydration or solvation, the state of coordination of the cobalt atoms (whether octahedral or tetrahedral), the presence of specific complexes and the ionic state of the ion. However, there seem to be a few exceptions for every rule proposed, although the octahedral/tetrahedral coordination change is most widely held to be the chief cause.

e. Complexes of Co(II), d^7

The Co(II) complexes are very numerous. Most have a basically octahedral or tetrahedral structure with an orange-pink or blue-violet colour (but a few square planar ones are also known). The compounds of Co(II) tend to react rapidly, reaching equilibrium in the time of measurement. Cobalt(II) is the only d^7 ion of common occurrence and, as such, forms tetrahedral complexes more readily than does any other transition metal ion. In fact, octahedral and tetrahedral complexes are so nearly equal in energy in some cases that both geometries can be found in equilibrium with one another. A few important examples of Co(II) complexes are given below:

1) Complex halides

The halogen complexes of cobalt, CoX_4^{2-} ($X = \text{F}, \text{Cl}, \text{Br}, \text{I}$), are all tetrahedral in structure. They are readily prepared by evaporation of aqueous solutions containing stoichiometric proportions of the alkali metal and cobalt(II) chlorides. When prepared in aqueous solution, the salts are sometimes isolated as hydrates, e.g. $(\text{NH}_4)_2\text{CoCl}_4 \cdot 2\text{H}_2\text{O}$.

2) Complex thiocyanates and isothiocyanates

Cobalt(II) forms several complexes with thiocyanate. Since these are of considerable importance to us, we will discuss them in some extra

detail.

The stepwise replacement of water molecules in $\text{Co}(\text{H}_2\text{O})_6^{2+}$ by SCN^- ligands leads to a series of cationic, neutral and anionic complexes in solution of the form $\text{Co}(\text{H}_2\text{O})_a(\text{SCN})_b^{2-b}$. This series (along with the halides, which they closely resemble) has actually been studied over quite some time but with results which often seemed to be discordant. The solution chemistry has been investigated by spectrophotometric⁽²⁰⁴⁻⁸⁾ infrared^(181-83, 186, 209), magnetic⁽²¹⁰⁻¹¹⁾ and various electrochemical^(188, 213-14) means in an effort to identify the species involved and to measure their stability constants. Varying degrees of success have been achieved by each of these techniques but taken together they have presented an acceptable picture.

By spectrophotometric means, it was concluded⁽²⁰⁴⁾ long ago that the progression from low to high thiocyanate concentration produced, sequentially, the ions $\text{Co}(\text{H}_2\text{O})_6^{2+}$, $\text{Co}(\text{H}_2\text{O})_5(\text{SCN})^+$, $\text{Co}(\text{H}_2\text{O})_3(\text{SCN})^+$ and finally $\text{Co}(\text{SCN})_4^{2-}$ in aqueous solution. Here, a change from octahedral 6-coordinate to tetrahedral 4-coordinate symmetry was interpreted to take place somewhere at the point of introduction of only one thiocyanate ligand and was said to coincide with the switch from pink to blue solution colours. Later, such measurements in aqueous solution by others^(208, 215) demonstrated the existence of other thiocyanate-containing species (with from 1 to 4 thiocyanates) and concluded rather that the change in coordination geometry occurs with two or more SCN^- ligands in the complex. Similar spectrophotometric studies in non-aqueous and mixed solvents^(205-8, 215) showed that the formation of complexes containing larger numbers (up to 4) of thiocyanate ligands was greatly favoured in all organic solvents and

that the $\text{Co}(\text{SCN})_4^{2-}$ ion was reasonably soluble in a number of these. Infrared, magnetic, electrochemical and other physical measurements have generally confirmed these observations with some further disagreements as to the number of thiocyanate ligands required to achieve tetrahedral coordination (one study suggested that three is actually the minimum number). From this, it appears likely that the formation of the various thiocyanate complexes depends quite sensitively on many solution parameters including the solvent chosen, temperature, ligand concentration and even the ionic strength and this is evidently a consequence of the very similar energies of a number of octahedral and corresponding tetrahedral complexes. However, all methods now appear to concur that complexes containing from one to four thiocyanate ligands exist in equilibrium with one another but that penta- or hexathiocyanato species are not commonly formed.

A further complication comes from the fact that the thiocyanate ligand (SCN^-) is ambidentate - being able to coordinate to metal ions either through the sulfur or nitrogen atoms (or both as a bridge in a few complexes). Where the structure is known exactly, those complexes which are bonded through the S atom are those correctly termed "thiocyanates" whereas those joined to the metal through the N atom have been given the name "isothiocyanates". Considerable academic interest has arisen out of a desire to distinguish one from the other and this has included the complexes of cobalt. It has been found chiefly by infrared (181-84, 186, 209) and to a lesser extent by spectrophotometric (179) studies that cobalt bonds chiefly to the N atom of SCN^- (particularly where H_2O and SCN^- are the only ligands) and thus gives rise to a

series of isothiocyanates. However, it is also possible to prepare thiocyanate complexes of cobalt as well in certain cases.

The x-ray crystal structures of several thiocyanate complexes have been determined including that of the $\text{Co}(\text{NCS})_4^{2-}$ complex⁽¹⁸⁵⁾ which has been shown to be tetrahedral with a Co-N-C bond angle of approximately 120° . In preparation, the alkali metal salts crystallize as hydrates (e.g. $\text{K}_2[\text{Co}(\text{NCS})_4] \cdot 4\text{H}_2\text{O}$ and $\text{Na}_2[\text{Co}(\text{NCS})_4] \cdot 8\text{H}_2\text{O}$) which give blue solutions in many organic solvents but turn pink on decomposition in dilute aqueous solution.

3) Complex cyanide

The addition of KCN to a Co(II) solution produces a dark green colour from which the purple solid, $\text{K}_2\text{Co}_2(\text{CN})_{10}$, can be precipitated. The solid has been shown to contain the $(\text{NC})_5\text{Co}-\text{Co}(\text{CN})_5^{6-}$ ion. The green solution has been shown to react slowly with water in the following manner: $2\text{Co}(\text{CN})_5^{3-} + \text{H}_2\text{O} \rightleftharpoons \text{Co}(\text{CN})_5\text{H}^{3-} + \text{Co}(\text{CN})_5\text{OH}^{3-}$.

4) Complex nitrates

Tetranitratocobaltates(II) are formed by reaction of Co(II) salts with tetramethylammonium nitrate in nitromethane or with methyltriphenylarsonium iodide and silver nitrate in acetonitrile.

5) Complexes with oxygen and sulphur ligands

Cobalt(II) salts form a large number of complexes with alcohols, thioalcohols, ethers, ketones and various thio compounds. The stereochemistry of the complex frequently varies with only minor changes in the ligands.

6) Complexes with nitrogen, phosphorus and arsenic ligands

The Co(II) halides and other simple salts form a large number of

complexes with ligands having these donor atoms. Complexes can usually be prepared by direct reaction of aqueous or ethanolic solutions of the cobalt salt with the ligand. The complexes are generally of the type CoX_2L , CoX_2L_2 and CoX_2L_4 (where X = univalent anion and L = ligand). Nitrogen donors form the largest number of complexes of this group.

7) Cationic complexes

The pink hexa-aquo ion, $\text{Co}(\text{H}_2\text{O})_6^{2+}$, is present in the crystal structures of $\text{Co}(\text{ClO}_4)_2 \cdot 6\text{H}_2\text{O}$, $\text{Co}(\text{NO}_3)_2 \cdot 6\text{H}_2\text{O}$, $\text{CoSO}_3 \cdot 6\text{H}_2\text{O}$ and $\text{CoSO}_4 \cdot 7\text{H}_2\text{O}$. It is also present in aqueous solutions of Co(II) salts of non-complexing anions together with small amounts of the tetrahedral $\text{Co}(\text{H}_2\text{O})_4^{2+}$ ion. Solutions of the hexa-aquo ion are largely acidic: the carbonate, CoCO_3 , is precipitated by alkali metal carbonate solutions as long as a pressure of CO_2 is maintained over the solution.

f. Complexes of Cobalt(III), d^6

The coordination compounds of Co(III) are numerous and have a great variety in both nature and behaviour. They are diverse in coordination number, geometric structure and stability and in many aspects of their chemistry. To date, however, all known discrete Co(III) complexes have been found to be octahedral.

The important donor atoms (in order of decreasing tendency to complex) are nitrogen, carbon (in the cyanides), oxygen, sulfur and the halogens. We will concern ourselves only with the first few here.

1) Complex Ammines

Historically, the ammines of cobalt(III) have dominated the chemistry of cobalt complexes and their influence on the entire field of

chemistry has been substantial. The parent of many cobaltamines is the hexamminecobalt(III) ion, $\text{Co}(\text{NH}_3)_6^{3+}$, in which six ammonia molecules are bonded to the central Co atom. When excess ammonia is added to a cobalt salt and exposed to air, oxidation results and brown solutions occur which become pink on boiling. These solutions contain complex cobaltamines e.g. $[\text{Co}(\text{NH}_3)_6]\text{Cl}_3$, $[\text{Co}(\text{NH}_3)_5\text{Cl}]\text{Cl}_2$, and $[\text{Co}(\text{NH}_3)_5\text{H}_2\text{O}]\text{Cl}_3$.

In their reactions the cobaltamines are inert, i.e. their reactions with other ligands are slow - taking hours, days or weeks to reach equilibrium. The most important substitution reaction is that of aquation (e.g. $\text{Co}(\text{NH}_3)_5\text{X}^{2+} + \text{H}_2\text{O} \rightleftharpoons \text{Co}(\text{NH}_3)_5(\text{H}_2\text{O})^{3+} + \text{X}^-$).

The chelates with salicylaldehyde (or its derivatives) and diamines of the type of ethylenediamine have very interesting oxygen-carrying properties. For example, some of these compounds absorb and release oxygen so readily that they have been used in oxygen purification and have even been proposed for its production.

2) Complex Cyanides

If KCN is added to a solution of a cobalt salt, red-brown cobaltous cyanide, $\text{Co}(\text{CN})_2 \cdot 3\text{H}_2\text{O}$ precipitates. However, if excess cyanide is added, this redissolves forming a red solution of potassium cobaltocyanide (potassium hexacyanocobaltate, $\text{K}_4\text{Co}(\text{CN})_6$). A little HCl or acetic acid added to this solution which is then boiled in the presence of oxygen causes oxidation forming potassium cobalticyanide, $\text{K}_3\text{Co}(\text{CN})_6$, as yellow crystals. The $\text{Co}(\text{CN})_6^{3-}$ ion is inert to attack by chlorine, hydrogen peroxide, alkalis and hydrochloric acid. Concentrated sulphuric acid, however, liberates CO.

3) Carbonato Complexes

There are a large number of carbonato complexes of the substituted cobaltamine type. Some involve the unidentate carbonate ion (e.g. $\text{Co}(\text{NH}_3)_5(\text{CO}_3)^+$) while others contain the bidentate ion (such as $\text{Co}(\text{NH}_3)_4(\text{CO}_3)^+$). Many different formulas have been proposed for the host of anionic carbonate complexes.

4) Carboxylato Complexes

As with the carbonato ammine complexes, carboxylate anions form cobaltamines in which they are either unidentate or bidentate (e.g. $\text{Co}(\text{NH}_3)_5(\text{ox})^+$ and $\text{Co}(\text{NH}_3)_4(\text{ox})^+$ where ox = oxalate). Such complexes are often prepared by oxidation of the corresponding Co(II) complexes.

Apart from the large number of inorganic complexes, cobalt has a fairly extensive organometallic chemistry in several oxidation states in which it coordinates chiefly with π bonds (although some compounds containing σ bonds are also known). Among these are a large number of di-olefin, allyl, cyclopentadienyl, arene, and similar complexes.

From this brief overview of the chemistry of cobalt, it will be apparent that the element has quite a rich solution chemistry in both of its common oxidation states. The chief importance of cobalt comes from its inclusion in a large number of technologically vital alloys used in a wide range of applications and its requirement as a micronutrient by both plants and animals.

The reasonably large neutron capture cross-section (37 barns) of the

element (to form ^{60}Co and $^{60\text{m}}\text{Co}$ which emit high energy gamma radiation) together with the fact that it commonly leaches from the stainless steel tubes of reactor cooling circuits, makes its efficient removal in that environment of some practical concern. Also, since cobalt is present as a minor constituent in most ores and is required biologically in small amounts, methods of both separation and preconcentration are usually very necessary for either recovery or analysis. We shall address ourselves largely to these goals in the pages to follow but we will first briefly review some of the possible mechanisms of polyurethane foam extraction.

4. Possible Mechanisms of Polyurethane Foam Extraction

Perusal of the Review in Chapter I will show that an amazingly wide variety of substances ranging from non-polar compounds (such as oil, benzene, I_2 , PAHs etc.) through moderately polar ones (eg. organochlorine pesticides, PCBs, phenol, etc.) to ions (eg. $FeCl_4^-$, $AuCl_4^-$, $IrCl_6^{2-}$, etc.) have been reported to be removed from air, water, various solutions and other solvents by plain polyurethane foam. The list of varied substances sorbed by untreated polyurethane continues to grow yet not much activity has really been devoted to the mechanism by which this may occur.

Bowen⁽²⁸⁾, in describing his findings in 1970, pointed out that the capacity of sorption was too large to be attributable to a surface adsorption process and also called attention to the similarity between the list of substances which he discovered to be sorbed by polyether based polyurethane foam and those which could be extracted by diethyl ether. It was thus implied that the polyether portion of the foam acted as a polymeric analogue of diethyl ether in "solvent extracting" the host of substances tested. Very few authors in presenting their interpretation of new results have contributed further to expand or to alter this view of the process and most have not offered any interpretation of the mechanism whatsoever. Even though it has hardly been tested, the simple description of the phenomenon as "an ether-like extraction" would thus seem to be quite widely and perhaps tacitly accepted by most workers in the field. Although this would appear to be entirely adequate in describing the sorption of non-polar and even moderately polar substances, sever-

all other mechanistic possibilities should also be considered when dealing with the extraction of metal ions. To clarify the approach to be taken later we will briefly outline each of the possibilities now but without a great deal of detail.

a. Solvent Extraction

The notion of polyurethane foam behaving as a conveniently insoluble and self-supporting ether-like or ester-like solvent extractor seems both intuitively reasonable and attractive from the point of view of simplicity. According to this view, the long-chain portion of the polymer acts much as if it were the analogous liquid monomer in solvating the sorbed species while the urethane, urea and other links joining the chains together at their ends are largely inactive in the process. Thus, polyether-based polyurethane is expected to sorb readily those substances which are extracted by solvents such as dimethyl, diethyl or diisopropyl ether while polyester-based polyurethane should sorb those which are extracted by solvents similar to perhaps propylpropionate or hexylhexanoate. Considering, then, the general case in which some cation, M^{P+} (which may be H^+), accompanies the extraction of a metal-containing complex anion, MeX_n^{m-} , the extraction process may be written as:

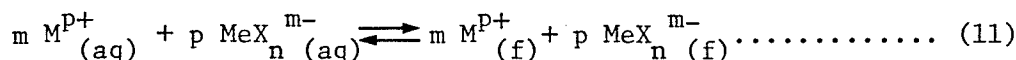

if the extracted species are unassociated in the foam phase, or as:

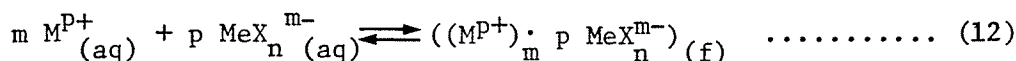

if they are essentially all paired (the subscripts aq and f denote substances present in the aqueous and foam phases, respectively).

Use of this model in the past has correctly predicted the sorption by polyether-based polyurethane foam of a number of known ether-extractable inorganic metal complexes of this type (e.g. GaCl_4^- , FeCl_4^-) from acid solutions. Most work thus far points to the conjugate acids of anionic metal complexes (i.e. HGaCl_4 , HFeCl_4) or the ion pairs (i.e. $\text{H}^+\text{GaCl}_4^-$, $\text{H}^+\text{FeCl}_4^-$) as the actual sorbed species when carried out under appreciably acidic conditions.

b. Metal Ion Complexation or Ligand Exchange

Since a number of lone pair-containing atoms (N, O) are available in polyurethanes $\left(\begin{array}{c} \text{:O:} \\ \parallel \\ \text{-}\ddot{\text{N}}\text{-C-}\ddot{\text{O}}\text{-} \\ | \\ \text{H} \end{array} \right)$, $\left(\begin{array}{c} \text{:O:} \\ \parallel \\ \text{-}\ddot{\text{N}}\text{-C-}\ddot{\text{N}}\text{-} \\ | \quad | \\ \text{H} \quad \text{H} \end{array} \right)$ and in polyethers ($\text{-}\ddot{\text{O}}\text{-}$)

or polyesters ($\begin{array}{c} \text{:O:} \\ \parallel \\ \text{-C-}\ddot{\text{O}}\text{-} \end{array}$), the possibility of complex formation between these and metal ions should not be neglected. Considering reasonably typical foam types produced by the prepolymer method in which the polyol (either polyether or polyester) has a molecular weight of about 1000, one kilogram of the product will contain very roughly 4 moles of oxygen atoms and 2 moles of nitrogen atoms from urea links, and either 4 moles of oxygen atoms for a polyester or 20 moles of oxygen atoms for a polyether polyol. Of course, all of these will differ in their abilities to serve as possible ligands but the point should be noted that they are, in fact, available in more than sufficient numbers to account for observed sorption capacities (about 1 mol kg^{-1} maximum). If this

does take place, it can conceivably occur either by exchange of existing ligands in the metal complex as for example, in the case of an anion of the type MeX_6^{m-} :

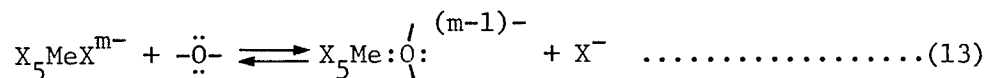

or by addition to increase the total number of ligands in the case, perhaps, of an originally four-coordinate ion, MeX_4^{m-} :

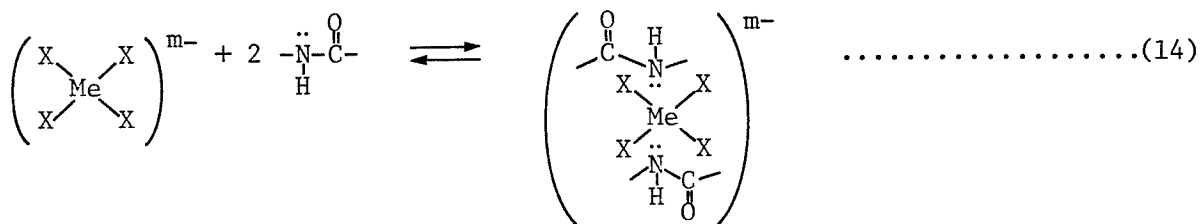

In the first instance, the coordination number of the metal atom remains unchanged but a change in symmetry will usually result. In the second case, however, an increase in the number of coordinated ligands will result in changes to both the symmetry and bonding of the complex. To date, no evidence has been presented for the existence of either of these possible reactions occurring on polyurethane foam and evidently they also do not apply to the system studied in this work but instances may be observed in the future.

c. Strong and Weak Base Anion Exchange

The observation that nearly all of the metal complexes known to be sorbed by polyurethane foam do so in anionic rather than neutral or cationic form suggests that some anion exchange sites may be permanently present (strong base anion exchange) or temporarily formed in the presence of acid (weak base anion exchange). The existence of strong base (such as quaternary ammonium) sites is not normally a part of polyurethane foam chemistry and so need not be considered too seriously but the large number and variety of nitrogen and oxygen atoms present makes the formation of many protonated weak base sites feasible in sufficiently strong acid, HA, perhaps as follows:

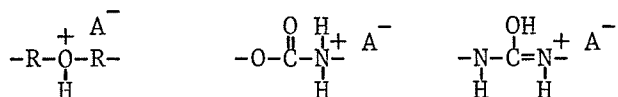

plus a number of other possible forms.

As for conventional ion exchange, extraction of the metal complex, MeX_n^{m-} by polyurethane foam would occur by exchange for the equivalent number of original A^- ions at these sites and the extraction equilibria would then be:

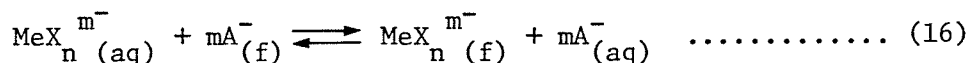
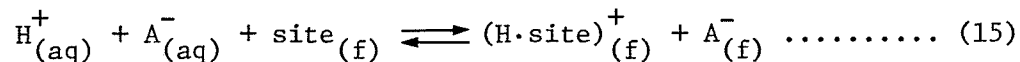

where the protonated site at which exchange occurs is denoted by $(H \cdot site)_{(f)}^+$ without identifying it further.

There is a great deal of similarity between the final result of the

actual exchange of anions (MeX_n^{m-} for $m \text{A}^-$) at protonated sites already established in the polyurethane and that resulting from the sorption of an ion pair or multiple, $m\text{H}^+ \cdot \text{MeX}_n^{m-}$, by solvent extraction followed by association of the hydrogen ions with basic sites such as pictured above. The functional difference between these two possibilities is really whether or not large amounts of $\text{H}^+ + \text{A}^-$ have already been or even are concurrently being sorbed so that a larger number of equivalents of protonated sites and counter ions exist on foam than there are equivalents of complex ions to exchange with them. Obviously, the dividing line between these two possibilities is not a very sharp one.

d. Cation Chelation Mechanism (CCM)

Another possible mechanism by which anionic metal complexes may be sorbed which does not necessarily require protonation of polyurethane foam sites but which is nevertheless closely related to the weak base anion exchange concept is what we will call the Cation Chelation Mechanism. According to this view many cations, $\text{M}^{\text{P}+}$, such as Na^+ , K^+ , NH_4^+ , Ag^+ , Pb^{2+} , Ba^{2+} , etc. and including H_3O^+ are capable of being specially and effectively (but not necessarily equally) solvated as a result of chelation by a portion of the polyurethane polymer. In other words, the sorbed cation, $\text{M}^{\text{P}+}$, will be complexed by the polymer at some sites according to some stable association:

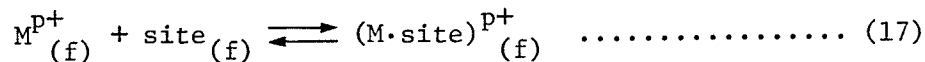

where, of course, these sites may be entirely different from those in-

volved in any ion exchange mechanism.

The extraction of ion pairs including these cations will then be greatly facilitated owing to the stability of the chelated cation. However, which anions will accompany the cations in largest numbers will be determined by a variety of factors including the anion's individual hydrophobic nature, its charge and perhaps its ability to interact in some other way with the polymer.

In the case where little or no sorption of ion pairs other than $m M^{p+} + p MeX_n^{m-}$ occurs (either due to the nearly unextractable nature of all other available anions, A^- , or due to a lack of sufficient excess of either cations or these anions being present), the extraction of the cation-complex anion pair or multiple may be regarded to take place by a solvent extraction process in which the cation happens to be more effectively solvated than usual. The extraction sequence of the complex anion, MeX_n^{m-} , could then be summarized by:

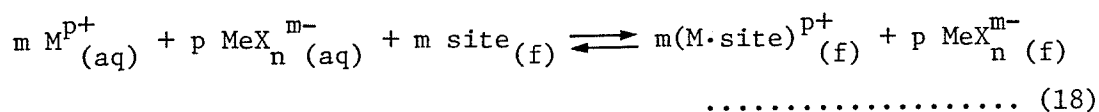

where the chelated cation and anion are written separately but may, in fact, be ion paired within the polyurethane.

On the other hand, if considerable sorption of another ion pair or multiple containing the cation M^{p+} and some moderately extracted anion, A^- , occurs either prior to or concurrently with the sorption of MeX_n^{m-} , then the sorption of the latter may be regarded to take place by an anion exchange process in which the positive sites on the polymer re-

sult from the chelated cations, M^{P+} , bound there. The extraction sequence of MeX_n^{m-} may then be summarized by:

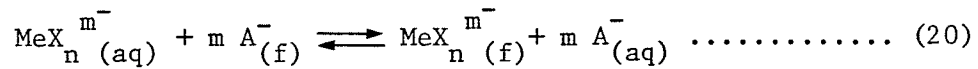
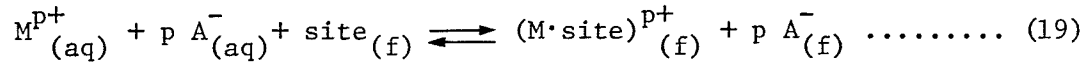

The Cation Chelation Mechanism thus bears resemblance to both solvent extraction and ion exchange phenomena, depending to some extent on solution conditions. A method whereby chelation of the cation may occur will be considered later.

These four extraction mechanisms (which, in some cases, differ from one another only in subtle details) probably represent most of the possible methods by which polyurethane foam might be expected to sorb complex metal ions. Each may play some role under specific circumstances and more than one mode of extraction may certainly be at work at any one time. However, some are plainly more likely to apply to a wide variety of metals under a wide variety of conditions than are others and so will be more generally observed.

The existence of a number of possible mechanisms for the extraction of metal ions and the incomplete consideration given to them thus far in the literature prompted a great deal of interest in the topic. In addition, several apparent anomalies existing in the generally espoused "ether-like solvent extraction" picture as it applied to metal ions suggested that some of the other mechanisms definitely needed to be considered to completely describe the phenomenon. It has, for example, been observed many times that polyester-based polyurethanes show very much

less extraction ability for metal ion complexes than do their polyether counterparts in spite of the fact that many of the ion complexes are solvent extractable to nearly the same extent by both esters and ethers. Similarly, extending to other polymers the concept of a "poly-solvent" as likely being successful in sorbing materials which are extracted well by the corresponding monomeric solvent, one is then disappointed to find that, for example, polyvinylchloride is not at all able to sorb those inorganic complexes which methylene chloride or chloroethane are able to extract moderately well. Finally, it should be pointed out that although a number of metal species are sorbed both by ether and by polyether polyurethane foam, no satisfactory explanation has yet been given of how the distribution ratios in the latter case can be greater by many orders of magnitude if these are really analogous extractions.

Based on these and several other observations which cast doubt on the completeness of the "ether-like solvent extraction" description, an effort was made to apply the data obtained for the sorption of cobalt from thiocyanate solutions to the problem to see whether or not some light could be shed on the subject. It was felt that this might be possible particularly since the availability of a good tracer for cobalt (^{60}Co) made analysis both relatively easy and much more accurate than could be hoped for by other methods.

B. EXPERIMENTAL

1. Apparatus and Reagents

a. Commercially Obtained Apparatus

Radiometric counting was performed on a Baird-Atomic model 530A single channel gamma spectrometer (Baird-Atomic, Bedford, Massachusetts) with a model 810C well-type detector. The detector was fitted with a Harshaw NaI(Tl) scintillation crystal of 50 mm diameter, 55 mm height and having a well 17 mm in diameter and 39 mm in depth. For some of the later experiments, a Baird-Atomic model 620 printer and model 708 automatic sample carousel were also available. Whenever used, the spectrometer was adjusted to record all gamma rays having energies in excess of the detector noise level. On a few occasions, the NaI(Tl) detector was used in conjunction with a Tracor Northern model 1705 multichannel analyzer (Tracor Northern, Middleton, Wisconsin) which allowed tuning to the 1.173 MeV and 1.333 MeV photopeaks of ^{60}Co when the background magnitude was especially critical. Use of the Tracor Northern spectrometer with a Ge(Li) semiconductor detector also proved periodically useful in checking the identity and purity of the tracer solutions used.

A Unicam model SP 800B double-beam recording ultraviolet and visible spectrophotometer (Unicam, Cambridge, England) with 10 mm or 40 mm quartz cuvetts was used for obtaining electronic solution spectra.

Infrared measurements were made on a Perkin-Elmer model 337 grating infrared spectrophotometer (Perkin-Elmer Corp., Norwalk, Connecticut). On occasion, a Wilks model 9 attenuated total reflectance (ATR) accessory

with KRS-5 crystal (Wilks Scientific Corp., South Norwalk, Connecticut) was also used.

Measurements of pH were accomplished with a Fisher Accumet model 520 digital meter using universal glass and standard saturated calomel reference electrodes (Fisher Scientific, Fair Lawn, New Jersey). Calibration buffers of pH 4.0, 7.0 and 10.0 were prepared by dilution of standard concentrates obtained also from Fisher Scientific. A 0.05 molal potassium tetroxalate buffer (pH 1.675) was also prepared and used on occasion to calibrate more acidic measurements.

Most weighings were made on a Mettler type H6 substitution type milligram balance (E. Mettler, Zurich, Switzerland). A Sartorius model 1802 microgram balance (Sartorius-Werke AG, Gottingen, Germany) was used when very small (less than 10 milligram) quantities of polyurethane foam or reagents were needed.

A Haake model FJ recirculating pump and thermostatic bath (Haake, Berlin, Germany) was used to provide controlled temperature water when needed to supply certain water-jacketed apparatus.

A large mercury thermoregulator (model 81631 but of unknown German manufacture) coupled to a Waco model 90800 electronic relay (Wilkens-Anderson Co., Chicago, Illinois) were used to control an air bath temperature regulating system to be described later.

Other common pieces of apparatus used were standard laboratory glassware and will not be described. All glassware was cleaned thoroughly with soap and water, rinsed with distilled water and dried in an oven. Chromic acid was used on volumetric flasks and pipets followed by copious rinsings.

b. Custom Made Apparatus

1) Glass Distribution Cells

An apparatus was required in which to bring pieces of polyurethane foam to equilibrium with a variety of solutions. To fill this requirement, a Pyrex glass distribution cell was designed. The design of the cell was based on the need for an inert reaction vessel in which a piece of polyurethane foam could be frequently compressed and allowed to expand beneath the surface of a solution so that the entire volume of foam would come to equilibrium with it. Two further requirements were that this action of squeezing would result both in reasonably efficient solution stirring and in "tumbling" of the foam through the solution so that it would be squeezed successively from random directions. In addition, it was considered to be essential that the cell be sealed sufficiently from the atmosphere so as to prevent excessive evaporative losses of water but that it also be possible to withdraw and return samples of the solution easily from time to time.

The apparatus shown assembled in Figure 2-1 and disassembled in Figure 2-2 was designed to meet these requirements. The dimensions were chosen so as to give the cell a capacity of about 150 mL of solution. The cell bottom (A, Figure 2-2) and top (C) were constructed entirely of Pyrex glass and fit together at a hand-ground glass flange. A ground glass Pyrex stopper (B) was used to seal the solution sampling neck of the cell bottom. A small amount of Dow Corning high vacuum silicone grease was used to seal the ground glass flange and stopper. Compression of the foam and mixing of the solution were both accomplished by a Pyrex glass plunger (D) which was sealed shut at its base, ground to be flat,

Figure 2-1

Pyrex Glass distribution cell (assembled)
for equilibrating polyurethane foam with
various solutions.

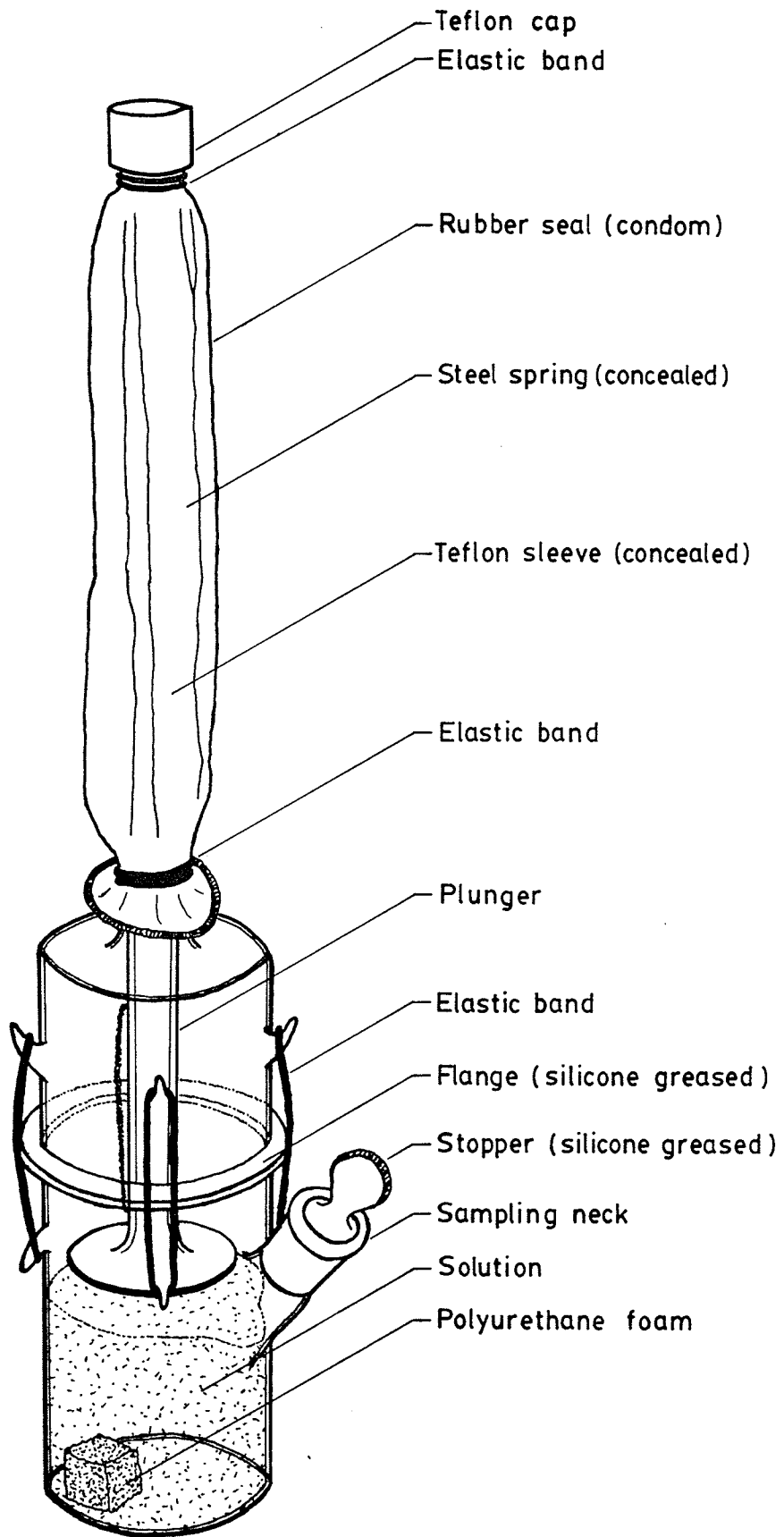
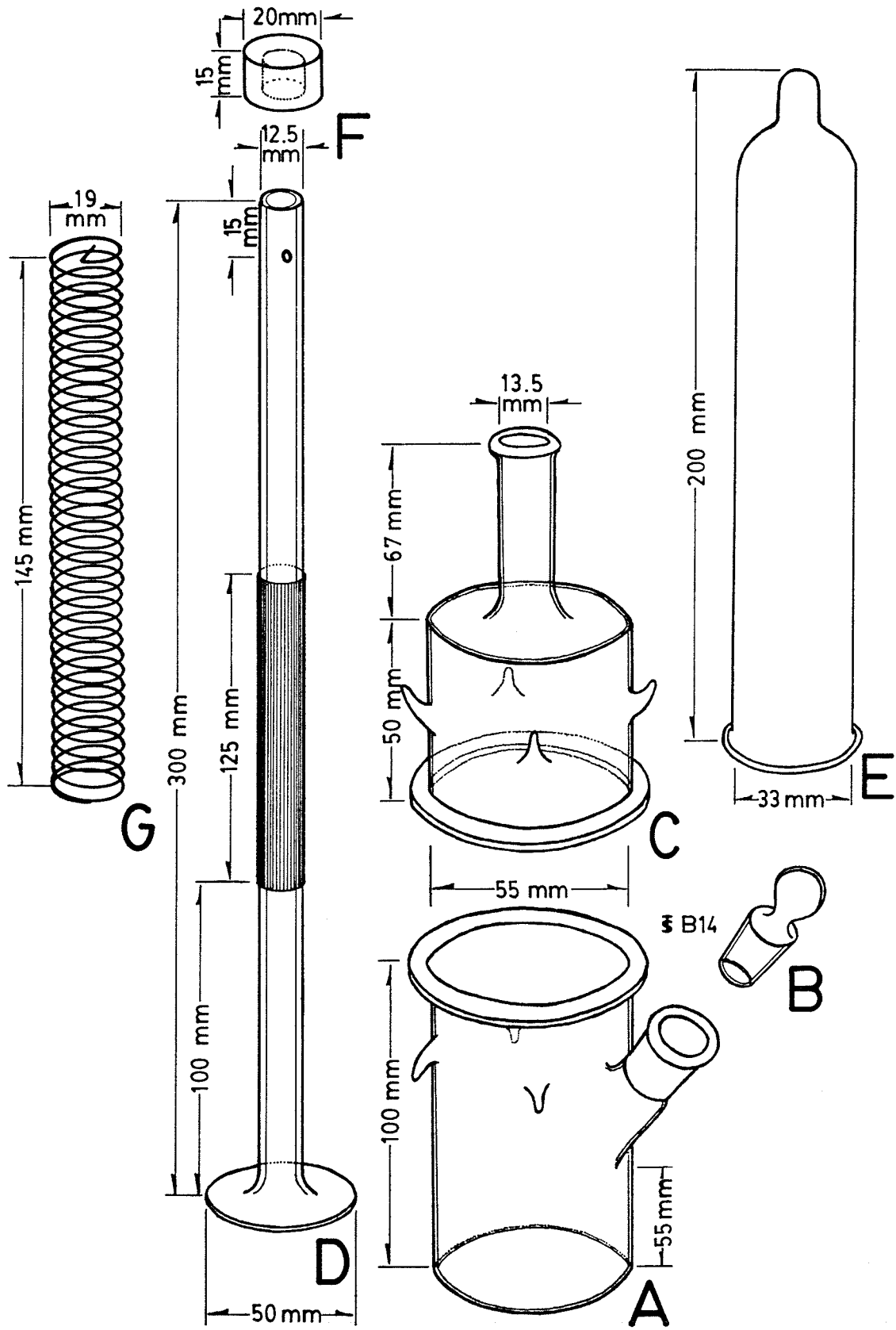

Figure 2-2

Pyrex Glass distribution cell (disassembled)
for equilibrating polyurethane foam with
various solutions.

- A - cell bottom
- B - ground glass stopper
- C - cell top
- D - cell plunger with Teflon sleeve
- E - rubber seal (condom)
- F - Teflon cap
- G - steel spring



then fire polished. The outside diameter of the plunger base was chosen to be near enough to the inside diameter of the cell bottom so that turbulence would mix the solution at the normal speed of operation. A piece of Teflon film of 0.13 mm (0.005 inch) thickness etched on one side was glued to the shaft of the plunger with silicone rubber cement to act as the slippery surface of contact between it and the neck of the cell top (C) in which it fits. A small hole was blown in the top end of the plunger to accommodate the upper end of a spring (G) wound from 1.6 mm (1/16 inch) diameter piano wire and later spray painted to prevent rusting. The opposite end of the spring was of such a diameter as to fit tightly around and grip the rolled upper lip on the neck of the cell top (C). The purpose of the spring was to return the base of the plunger to a position just under the surface of the solution after each squeezing motion. A simple latex rubber condom (E) attached by rubber bands to the plunger and cell neck was found to be an adequate and inexpensive seal to prevent most solvent evaporation. Preliminary experiments showed that evaporation of water from the cells over a 24 hour period was reduced from 1.8% to 0.3% by its use. When increased dependability from developing holes during use was desired, a second condom was placed over the first. Finally, a Teflon cap (F) was machined to fit snugly over the condom(s) and plunger and served as a contact with the mechanical squeezing equipment described below.

2) Mechanical Squeezer

A device was required which would impart an even, reciprocating motion to the plungers of the glass distribution cells over long periods of time. In addition, it was desired that such a device should be able to operate a number of cells simultaneously both to speed experimentation and to ensure identical conditions for each. To fulfill these requirements, the apparatus shown in Figure 2-3 was designed. The device (upper drawing, Figure 2-3) consisted of a long steel drive rod to which were brazed four identical brass cams. Fitting snugly as a sheath to the cams and attached to the two end ones by epoxy cement was a large glass tube whose outside surfaces thereby formed a single large cam. The steel drive rod was mounted near each end of the cam in ball-type bearings and received power through a large pulley attached at one end. The direction of rotation of the cam was arranged to be clockwise as viewed from the pulley end. Overall dimensions of the cam were chosen so as to yield a stroke (maximum vertical displacement on one revolution) of 51 mm (2.0 inches).

An integral part of the mechanical squeezer was the torque-reducing harness (lower part of Figure 2-3) which was fabricated from ten strips of high density polyethylene 0.51 mm (0.020 inch) in thickness joined together at the rear by a strip of galvanized steel and at the front by flexible wire. The use of individual strips of polyethylene rather than a single solid sheet was necessitated by the need to ensure good air circulation (to be discussed later) through the harness. The rear of the harness was fixed to the back wall of a cabinet (described below) in a position immediately behind the cam while the front was suspended from the ceiling of the cabinet by six shock-cord straps. The cam,

Figure 2-3

Essential parts of foam squeezing mechanism

Upper drawing - large rotating cam (steel shaft, brass cams, glass outer tube)

Lower drawing - torque reducing harness (polyethylene strips, shock cord support straps, galvanized steel anchor at back)

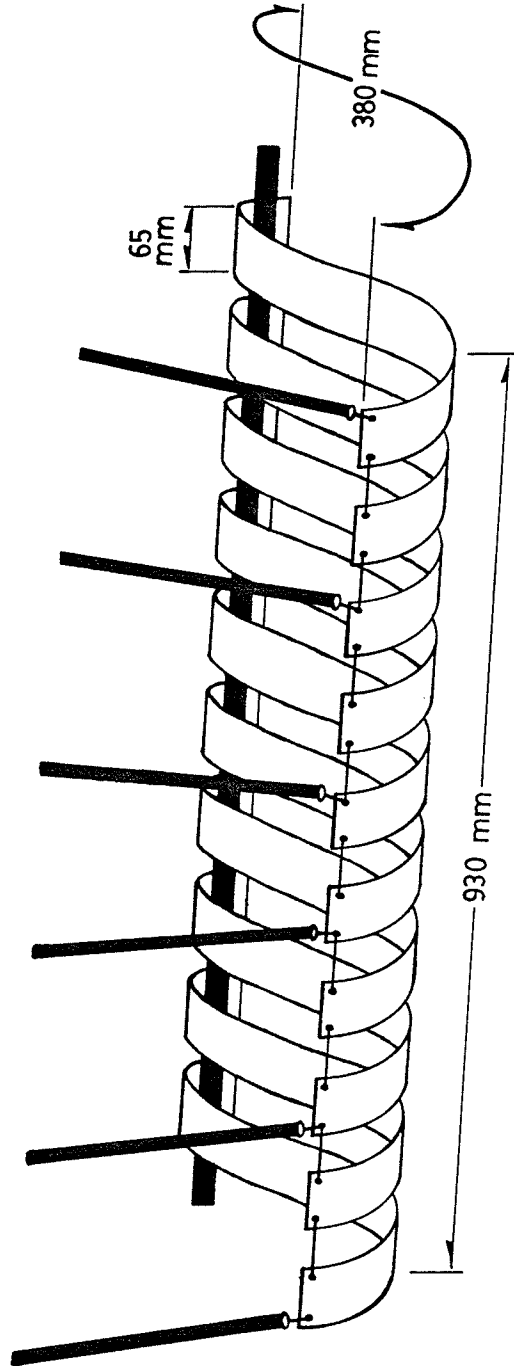
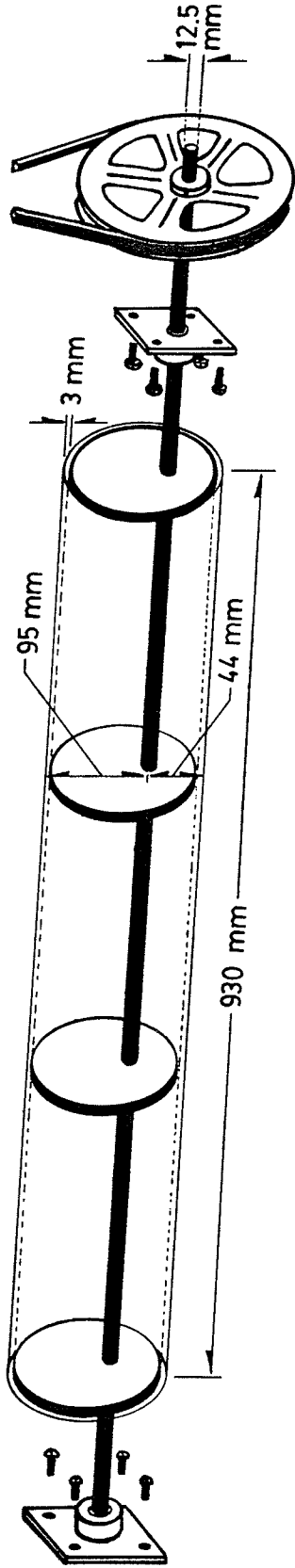
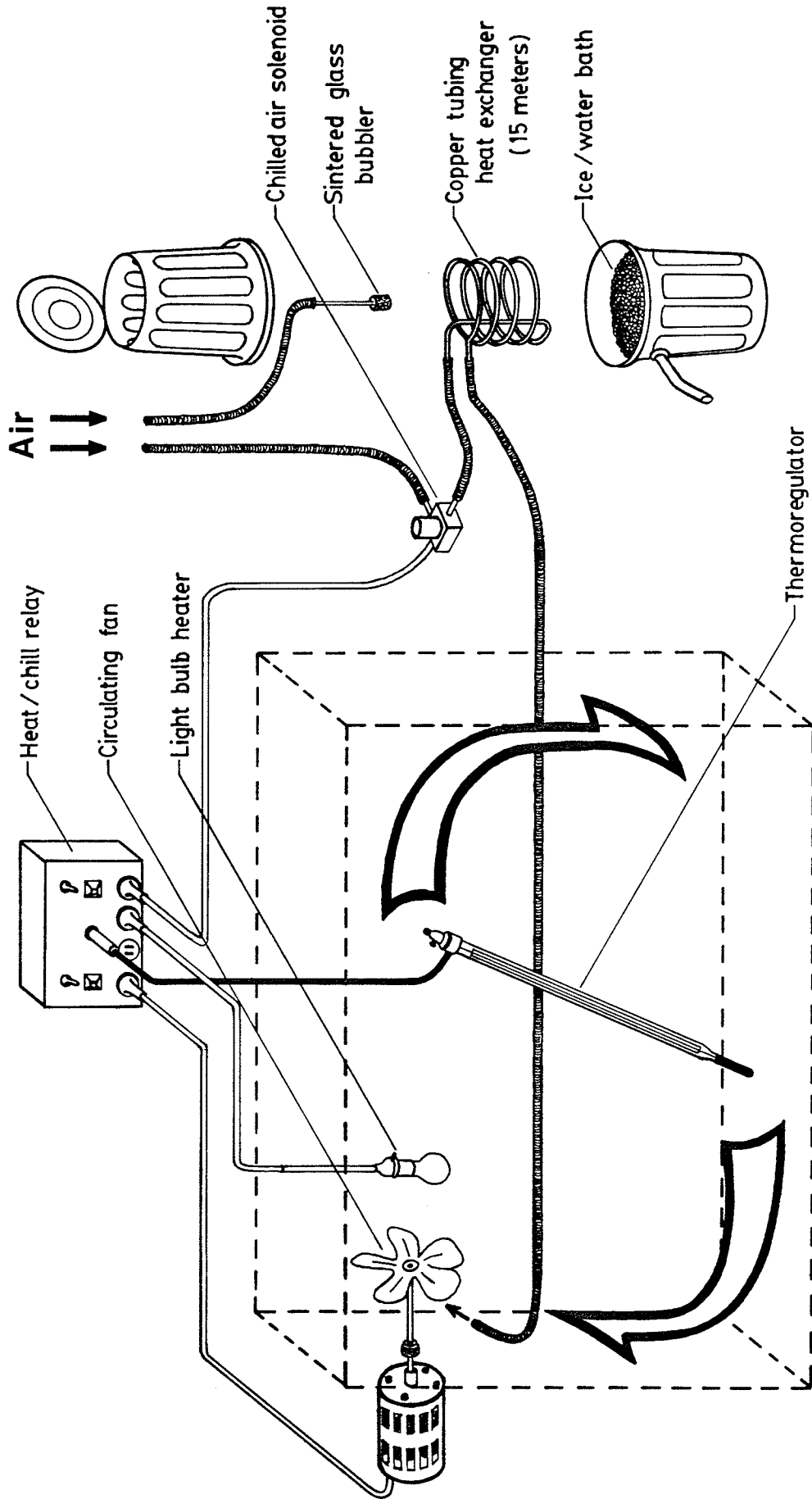

Figure 2-4

Essential parts of squeezing cabinet temperature control system. The outlines of the cabinet are shown by broken lines.



cradled by the harness, was liberally lubricated with a low viscosity grease so that little friction existed between the two. Under these conditions, nearly all torque resulting from the rotation of the cam is lost in sliding between the lubricated glass and upper plastic surfaces leaving the lower surface of the harness describing essentially vertical motions only.

3) Temperature Regulation System

Early experiments had indicated that close control of temperature was essential in distribution studies so arrangements were made for the entire distribution cell and squeezing mechanisms to be contained within a constant temperature cabinet. For clarity, a diagram detailing the features of the temperature regulation system alone appears in Figure 2-4 with only the outline of the cabinet being shown. Available equipment and resources made the construction of a simple alternating heat/cool type of system most convenient. In this system, a large thermoregulating mercury thermometer mounted with its bulb near the location of the cells maintains control by alternately activating heating and cooling mechanisms through an electronic relay. Uniformity of temperature throughout the cabinet was maintained by means of an efficient circulating fan mounted near the top of the cabinet and approximately 17 cm from one side wall. The general direction of air flow thus obtained is indicated by the large arrows in Figure 2-4. Heating of the air was provided by means of a 40 watt electric light bulb placed in the air stream following the fan. The act of cooling was accomplished by injecting chilled (about 15°C) air into the circulated air stream at a position immediately preceding the fan. Chilled air for this purpose was obtained simply by passing compressed air through a 15 meter length coil of 9.5 mm (3/8 inch)

diameter copper tubing immersed in an ice-water bath. Control of the air flow into the copper tubing and thus into the cabinet was effected by means of a small solenoid operated by the electronic relay. Vigorous stirring of the ice bath (and thus efficient air cooling) was obtained by the use of a small sintered glass bubbler also immersed into it. The bath was constructed from two 25 L plastic garbage receptacles attached with one upside down over the other. The bottom of the uppermost one was cut open to serve as a lid through which ice could be added. The lower receptacle was fitted near its top with a plastic pipe to serve as an overflow for water to a nearby sink. The lower half of the finished bath and the rubber tubing connecting the heat exchanger to the cabinet were shrouded in polystyrene (not shown) to insulate them from the room. The interior walls of the cabinet were similarly lined with polystyrene sheeting to reduce heat transfer. Under normal conditions of room temperature a single filling of the entire 50 L bath with ice was sufficient to maintain constant temperature in the cabinet for at least 12 hours.

4) Cabinet

The squeezing cam, torque-reducing harness and temperature regulating devices were all mounted within a wooden cabinet as shown detailed in Figure 2-5. Attached to a movable wooden shelf was an adjustable two-tiered clamp rack carrying ten clamps on each tier to allow for positioning of ten glass distribution cells immediately beneath the shaft of the cam (one is shown in position in Figure 2-5). The teflon cap at the top of each cell contacted the middle of a particular polyethylene strip of the harness with a small amount of low viscosity grease being applied between them. Small adjustments to the height of the cells above the shelf to compensate for small variations in their manufactured size were made by placing one or more paper shims beneath each cell bottom so that the plunger would be driven by the cam to a point just 1 mm above the cell bottom, Attached to the outside of the cabinet was a small motor with a two stage belt-and-pulley speed reduction system designed to drive the cam at a constant rate of 25 revolutions per minute in a clockwise direction as seen from the pulley side.

As mentioned earlier, the walls and doors of the cabinet were covered on the inside with polystyrene foam (shown lightly stippled in Figure 2-5) to reduce heat transfer with the room. In addition to this, another sheet of polystyrene was attached to the cabinet inside the doors so that their opening would not immediately flood the cabinet with room air. A piece of laboratory bench cover ("Labmat") draped to cover a gap deliberately left at the bottom of this sheet served as a curtain which could be lifted immediately in front of any desired cell. In this way, it was possible to greatly limit the loss of thermostatted air during sample taking or observation and thus temperature control during use was much

Figure 2-5

Completely assembled foam squeezing cabinet showing one distribution cell (#8) clamped in position. The cabinet material was wood. A layer of polystyrene insulation (shown stippled) covers the inside surfaces.

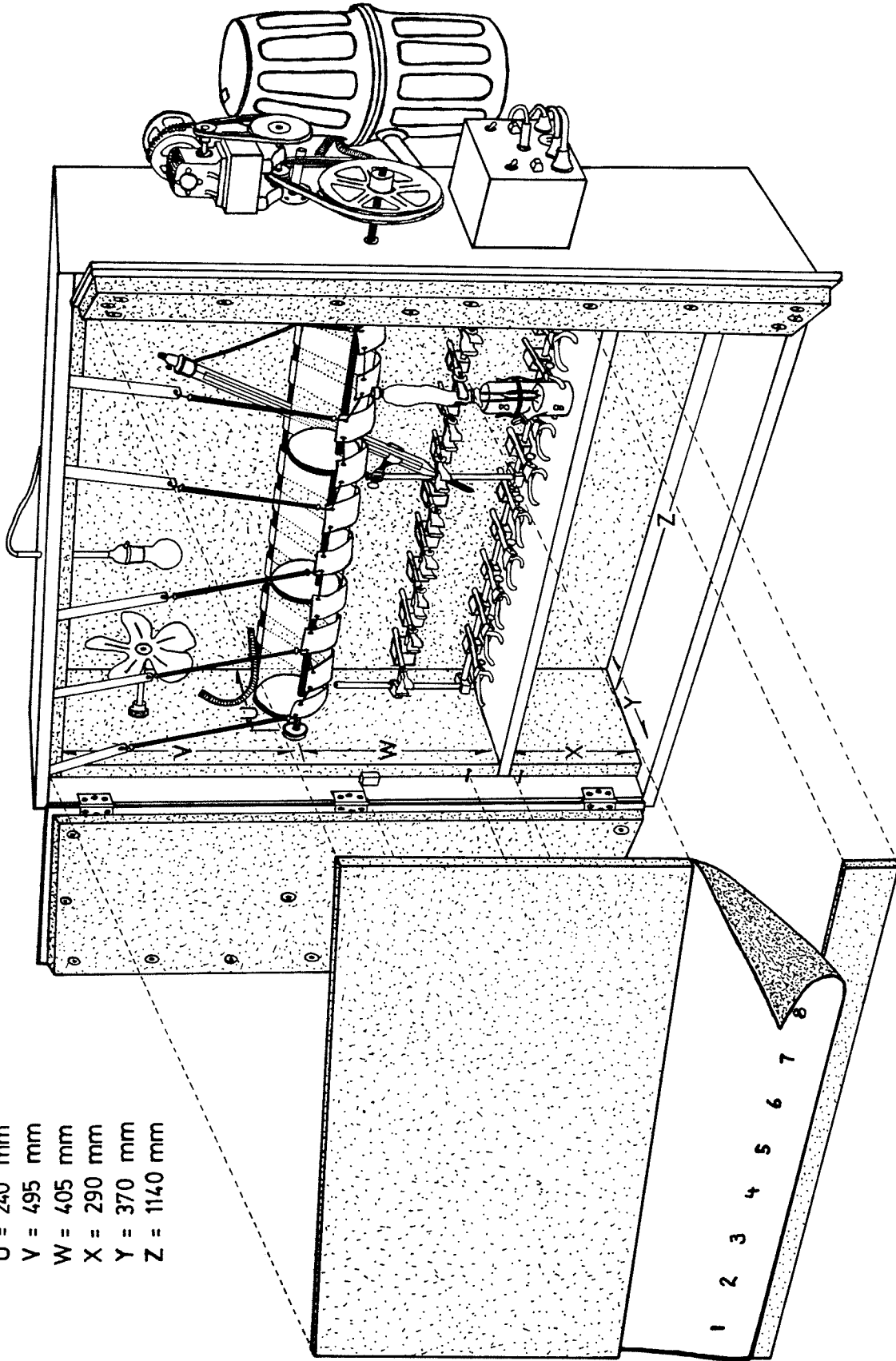

- U = 240 mm
- V = 495 mm
- W = 405 mm
- X = 290 mm
- Y = 370 mm
- Z = 1140 mm

improved. A temperature of 25.00°C was found to be the lowest which could be accurately maintained by the equipment under the room temperature fluctuations suffered in our laboratory. Consequently, this temperature was chosen as the one at which to carry out all constant-temperature experiments. The cabinet temperature was monitored on a routine basis by a short range mercury thermometer (not shown) which penetrated the middle of the back wall of the cabinet at solution height. Measurements of temperature gradients inside the cabinet made with thermistors showed a maximum of only 0.005°C difference between the two end cell positions at solution height while all other cell positions were at temperatures within this range. Similarly, comparisons of the temperatures at the heights of the upper and lower sets of clamps showed less than 0.01°C difference to exist between them. Many routine observations of temperature fluctuation behaviour over extended periods of time showed that the cabinet as a whole was able to maintain temperature to within $\pm 0.05^{\circ}\text{C}$ or better of the preset value while maintaining much closer tolerances between individual cells in the cabinet.

5) Single Thermostatted Distribution Cell and Squeezer

When thermostatic control at a number of individual temperatures spread over a wide range was required (as for studies of temperature effects on equilibrium), a system other than the one already described was necessary. In this case, the all-glass apparatus shown assembled in Figure 2-6 and disassembled in Figure 2-7 was used. The design of this apparatus was nearly identical to the regular glass distribution cells described earlier except for the addition of a water jacket to the cell bottom (A, Figure 2-7) and the absence of a spring and Teflon cap. Addition of the water jacket made it possible to maintain solution temperatures ranging from nearly 0°C to 95°C by means of a Haake recirculating thermostatic pump attached by tubing to the jacket. On those occasions on which temperatures below that of the room were desired, a small copper tubing heat exchanger immersed in flowing tap water or an ice bath was inserted in the line returning to the thermostat. The use of a spring to lift the plunger to the top of the solution was found to be undesirable since even at slightly elevated temperatures condensation of water in the condom caused the spring to corrode rapidly with subsequent contamination of the solution. This problem was avoided by the use of a mechanical hedge trimmer mechanism (not shown) mounted above the cell assembly and whose moving blade was clamped directly to the upper end of the plunger. Thus, the plunger was both pushed down and lifted up by the mechanism and neither spring nor Teflon cap were required. The stroke of the hedge trimmer was 1.7 cm (3/4 inch) and was adjusted to give about 150 strokes per minute. The faster squeezing rate was deemed necessary to create stirring through additional turbulence in the solution to make up for the reduced stroke length. To reduce

Figure 2-6

Pyrex glass water-jacketed distribution
cell (assembled) for equilibrating
polyurethane foam with various solutions
at selected temperatures.

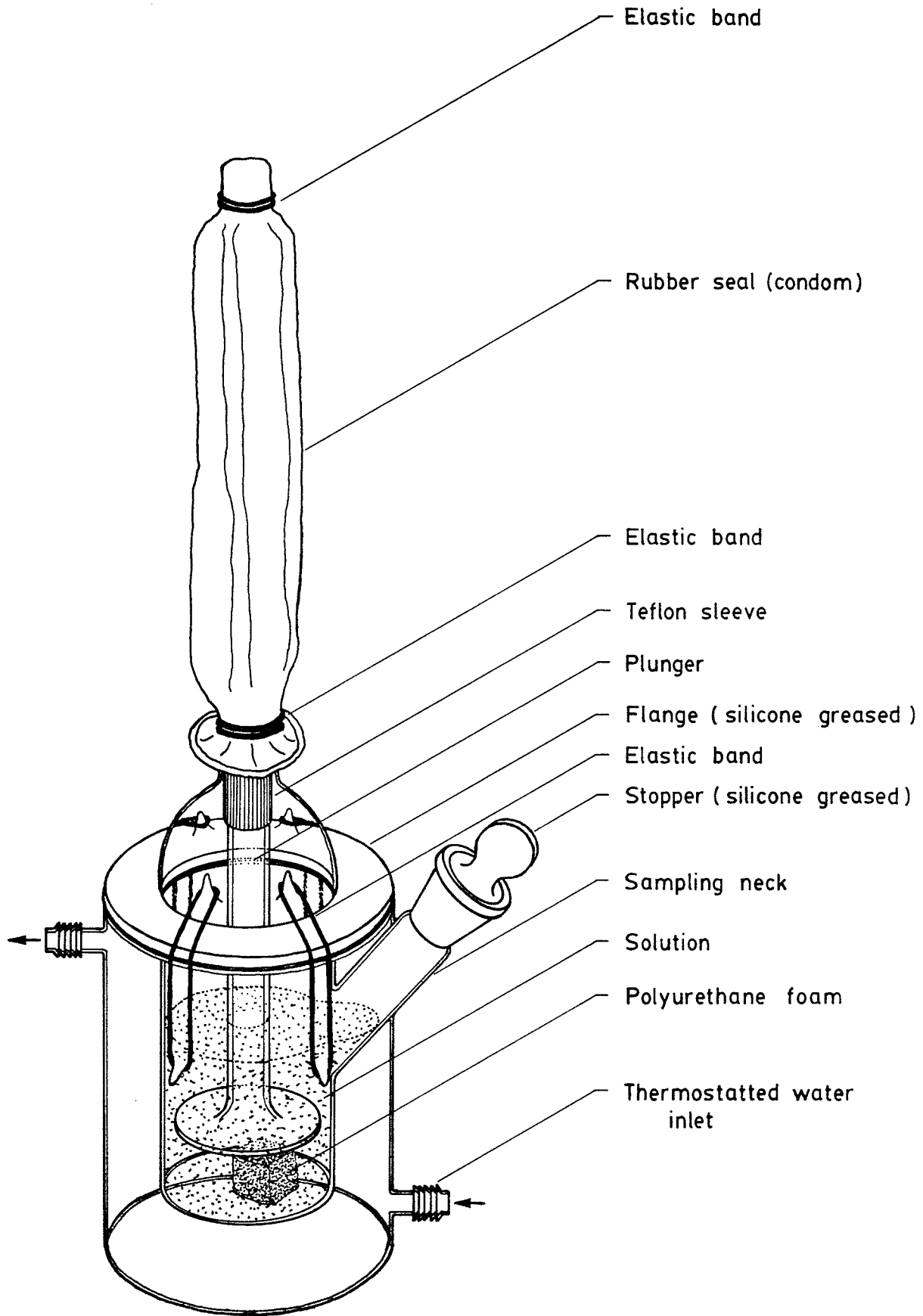
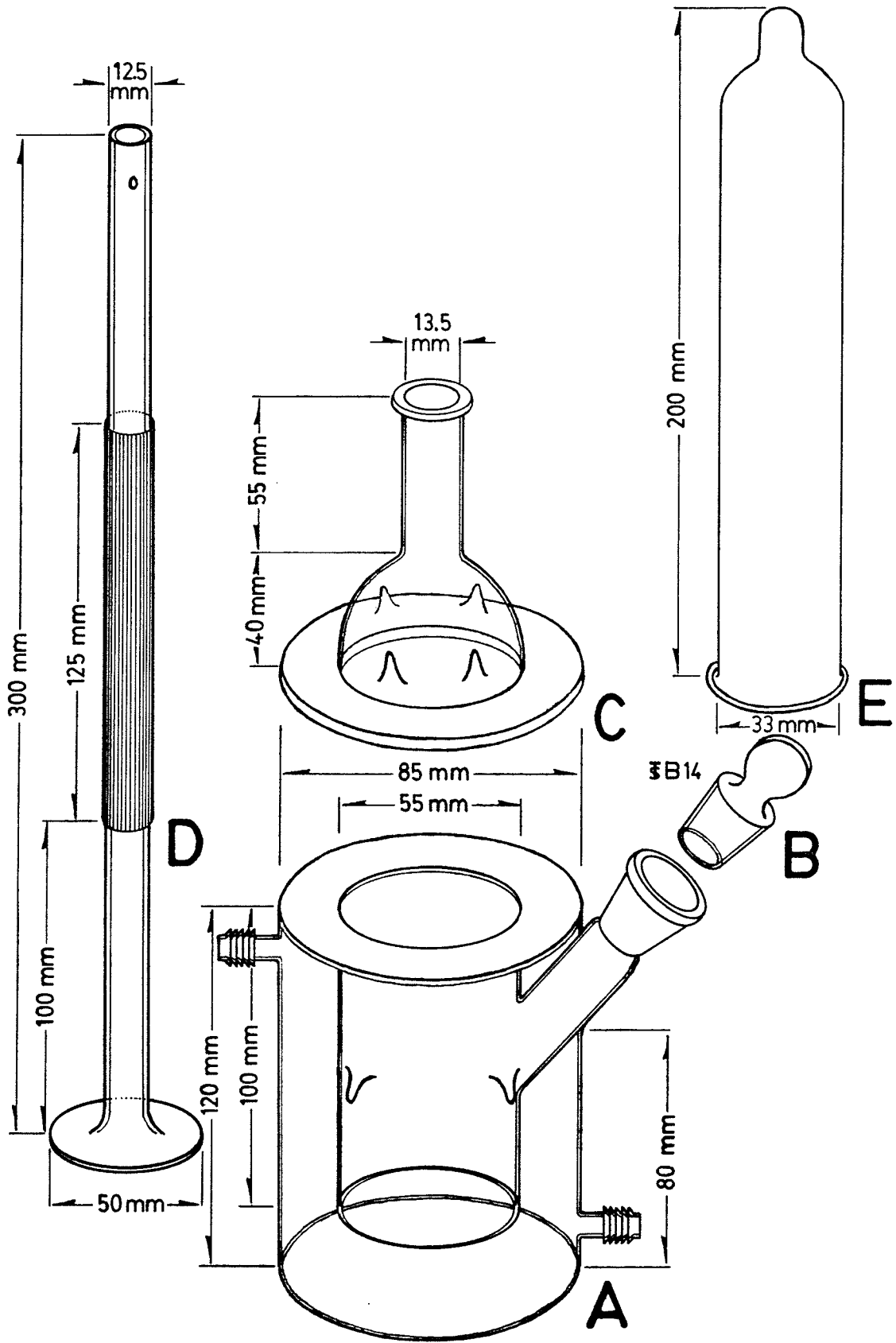

Figure 2-7

Pyrex glass water-jacketed distribution cell
(disassembled) for equilibrating polyurethane
foam with various solutions at selected
temperatures.

- A - cell bottom
- B - ground glass stopper
- C - cell top
- D - cell plunger with Teflon sleeve
- E - rubber seal (condom)



thermal contact with the surroundings, the outside of the water bath was covered with polystyrene pieces (not shown). Several small gaps still allowed periodic observations of the cell contents to be made. Control of the solution temperature by the system was observed to be better than $\pm 0.05^{\circ}\text{C}$ when above that of the room but was slightly less reliable and required frequent attention when below.

6) Other Glassware

To allow for the preparation of solutions for the 150 mL glass distribution cells without unnecessary wastage of either reagents or tracer, volumetric flasks were hand blown and permanently numbered from 1 to 10. Calibration of the flasks to contain exactly 150.0 mL was performed first by pipetting three 50.00 mL aliquots of distilled water into the flasks whereupon the necks were marked and later scribed. Following this, the flasks were each filled to the mark once more with distilled water and the contents determined gravimetrically. Results showed that all flasks fell within the range 149.82 to 150.02 mL which represents a $\pm 0.06\%$ variation amongst them.

A set of 27 Pyrex glass test-tubes of 16 mm outside diameter, 1.25 mm wall and 125 mm overall length were prepared to fit snugly within the crystal well of the gamma counter. The tubes were permanently numbered from 1 to 27 and calibrated by pipet to contain 15.0 mL when filled to a scribed mark. Reasons for the selection of this volume will be described later. In order to allow comparisons to be made between count rates measured in different tubes when necessary, they were also calibrated to correct for slight differences in geometry. This was accomplished by filling each tube to the mark with a stock ^{192}Ir

radioactive tracer solution followed by repeated radiometric counting to calculate a correction factor relative to one of the tubes (number 1). Maximum differences between pairs of tubes were thus determined to be approximately 2 percent. These tubes, usually in sets of ten, were used extensively in the distribution experiments.

c. Reagents

Polyurethane foam used in the majority of experiments was of polyether type originally supplied as a single 1.2 x 2.4 meter (4 x 8 feet) sheet 5.1 cm (2 inches) thick by G. N. Jackson Ltd. (Winnipeg, Manitoba). The designation given to the material by the supplier is #1338 which, however, is based solely on the physical properties (density 1.3 pounds per cubic foot, compression strength 38 pounds per 16 square inches) and not at all directly traceable to chemical composition. To distinguish this foam material from others later supplied by the same company with similar physical properties (and therefore also designated as #1338) but with completely different chemical origins, the initials of the prepolymer producer are also included in the designation used in this work. Thus, since the prepolymer used in the manufacture of the foam chiefly used in the experiment was produced by the B. F. Goodrich Company (Cleveland, Ohio), it will be referred to as #1338 BFG. This particular foam was chosen for extensive study since earlier experiments by others^(40, 42, 43) had already demonstrated it to be particularly effective in sorbing gallium from aqueous chloride solutions and my own preliminary observations suggested it also to be effective for cobalt in the presence of thiocyanate ions.

Several other foam types from a variety of sources were also used much less frequently for the purpose of comparison. All except one was known to be of polyether type. A number of foam types were obtained from G. N. Jackson Ltd. (Winnipeg, Manitoba). Many of them (#1122 BFG, #1538 BFG, #1831 BFG, #2331 BFG) were prepared from B. F. Goodrich prepolymer materials while another (#1338 M) was a product of the Monsanto Company (St. Louis, Missouri) and still another (Qualux) was of unknown origin. A series of six different "Hypol" foams were obtained from W. R. Grace and Company (Baltimore, Maryland) as samples. A further set of polyurethane foams of known composition (A, B, 27CGS-44-1, 27CGS-44-2A, 27CGS-44-3, D2931A) was obtained as a very generous gift through liaison with Dr. C. G. Seefried of the Union Carbide Corporation (South Charleston, West Virginia). Another foam containing carbon black as pigment (and therefore simply designated "Black") was also used but was of unknown source. Finally, the only polyester foam tested (diSPo) was the product of Scientific Products (McGraw Park, Illinois) and was distributed through Canadian Laboratory Supply (Winnipeg, Manitoba). All foams were cleaned before use first with 1 M HCl and then with acetone as outlined in the Procedure.

Ammonium thiocyanate (NH_4SCN), potassium thiocyanate (KSCN) and sodium thiocyanate (NaSCN) were all reagent grade salts produced respectively by the Allied Chemical Company (Pointe Claire, Quebec), BDH Chemicals Ltd. (Poole, England) and Shawinigan Chemicals (Shawinigan, Quebec). A 5 M stock solution of each salt was prepared for use in the experiments. The solutions were standardized gravimetrically with silver nitrate according to standard⁽²¹⁶⁾ procedure and stored in dark glass bottles protected from light.

Ammonium chloride (NH_4Cl), potassium chloride (KCl) and sodium chloride (NaCl) were all of reagent grade as supplied by Fisher Scientific Company (Fair Lawn, New Jersey). Sodium perchlorate ($\text{NaClO}_4 \cdot \text{H}_2\text{O}$) was also a product of Fisher Scientific but was labelled "purified". Each of these salts was used to increase or control the solution ionic strength and to supply ammonium, potassium or sodium ions.

Sodium acetate ($\text{NaC}_2\text{H}_3\text{O}_2 \cdot 3\text{H}_2\text{O}$) was of reagent grade as supplied by Shawinigan Chemicals (Shawinigan, Quebec). Glacial acetic acid (CH_3COOH) was also of reagent quality and was the product of the Allied Chemical Company (Pointe Claire, Quebec). Stock 2.5 M buffer mixtures of 1:1 molar ratio (pH 4.7) were prepared from these for use in most experiments.

Sodium hydroxide (NaOH) and concentrated hydrochloric acid (37% w/w HCl) were Fisher Scientific reagent grade products. A stock 10.0 M concentrated solution of the NaOH was prepared from the solid. Dilutions of the concentrates to yield 1.0 M and 0.1 M stock solutions of each were also prepared.

Potassium tetroxalate ($\text{KH}_3(\text{C}_2\text{O}_4)_2 \cdot 2\text{H}_2\text{O}$), used in preparing a calibration buffer, was obtained from BDH Chemicals (Poole, England) as an analytical reagent grade salt.

Cobalt chloride ($\text{CoCl}_2 \cdot 6\text{H}_2\text{O}$), a Fisher Scientific reagent, was used to prepare a stock 1.70×10^{-2} M (1000 ppm) solution in 10^{-3} M hydrochloric acid (to prevent hydrolysis). The stock solution was stored in glass out of the light.

A 1 mCi tracer of ^{60}Co was obtained commercially from ICN Nuclear Science (Pittsburgh, Pennsylvania). The tracer was reported to be

prepared in the Co(II)Cl_2 form but, since it was several years old, it was evaporated to dryness with concentrated hydrochloric acid before use to ensure conversion to that form. The tracer was then stored in 10^{-3} M HCl to prevent hydrolysis and small aliquots were withdrawn when needed. Experiments based on successive extractions of this tracer from thiocyanate solutions by polyurethane foam later demonstrated that better than 99.99% of the solution activity was extractable. The identity and purity of the tracer was confirmed by gamma spectrometry using a Ge(Li) semiconductor detector and multichannel analyzer system. The ^{60}Co isotope decays with a half-life of 5.26 years principally by beta decay accompanied by several gamma rays. The product, ^{60}Ni , is stable.

Acetone used in the experiments primarily for foam cleaning purposes was of certified quality as obtained from Fisher Scientific (Fair Lawn, New Jersey). Similarly, diethyl ether was also a certified product of the same company.

Water which had been double-distilled (first in stainless steel and then in glass) followed by double deionization (Illinois Water Treatment, Rockford, Illinois: Research model II and Puritan cartridges) was used for all solution preparation.

A number of other materials were used on occasion throughout the work, especially during evaluations of various interferences. The important information on these is gathered together into Table II-1.

Table II-1 - Infrequently Used Reagents

Supplier Code:

- 0 - unknown
- 1 - Fisher Scientific Company, Pittsburgh, Pennsylvania
- 2 - British Drug House (BDH), Poole, England
- 3 - J.T. Baker Chemical Company, Phillipsburg, New Jersey
- 4 - McArthur Chemical Company, Montreal, Quebec
- 5 - Matheson, Coleman and Bell, Norwood, Ohio
- 6 - Alfa Inorganics, Ventron, Beverly, Massachusetts
- 7 - Chem Service, Inc., West Chester, Pennsylvania
- 8 - May and Baker Limited, Dagenham, England
- 9 - Eastman Organic Chemicals, Rochester, New York
- 10 - D.F. Goldsmith Chemical and Metal, Evanston, Illinois
- 11 - Shawinigan Chemical Co., supplied through #4
- 12 - Harleco, Philedelphia, Pennsylvania
- 13 - Anachemia Chemicals, Inc., Champlain, New York
- 14 - Electronic Space Products, Los Angeles, California

Name	Formula	Supplier (see code above)	Grade
sodium fluoride	NaF	1	reagent
sodium bromide	NaBr	1	reagent
sodium iodide	NaI	13	reagent
sodium cyanide	NaCN	1	reagent (98.0%)
sodium nitrate	NaNO ₃	11	reagent
sodium sulfate	Na ₂ SO ₄	2	reagent
sodium bicarbonate	NaHCO ₃	1	certified
sodium oxalate	Na ₂ C ₂ O ₄	2	reagent (>99.5%)
sodium citrate	Na ₃ C ₆ H ₅ O ₇ ·2H ₂ O	1	certified
sodium tartrate	Na ₂ C ₄ H ₄ O ₆ ·2H ₂ O	12	-
sodium sulfide	Na ₂ S·9H ₂ O	1	certified
sodium dihydrogen phosphate	NaH ₂ PO ₄ ·H ₂ O	4	reagent
sodium sulfite	Na ₂ SO ₃	3	reagent (99.3%)
sodium chromate	Na ₂ CrO ₄	2	reagent (>99.5%)
sodium nitrite	NaNO ₂	1	certified (96.6%)
ammonium chloride	NH ₄ Cl	1	certified
sodium chlorate	NaClO ₃	1	reagent
sodium thiosulfate	Na ₂ S ₂ O ₃ ·5H ₂ O	2	reagent
sodium hexachlororhodate	Na ₃ RhCl ₆ ·12H ₂ O	6	-

Table II-1 continued

Name	Formula	Supplier (see code above)	Grade
sodium hexachloroplatinate	$\text{Na}_2\text{PtCl}_6 \cdot 6\text{H}_2\text{O}$	10	-
ammonium hexachloroosmate	$(\text{NH}_4)_2\text{OsCl}_6$	0	44.02% Os
potassium hexachlororuthenate	K_2RuCl_6	3	-
palladium dichloride	PdCl_2	5	59% Pd
potassium tetrachloroplatinate	K_2PtCl_4	6	-
sodium tungstate	$\text{Na}_2\text{WO}_4 \cdot 2\text{H}_2\text{O}$	1	certified
sodium molybdate	$\text{Na}_2\text{MoO}_4 \cdot 2\text{H}_2\text{O}$	5	reagent
ammonium metavanadate	NH_4VO_3	5	reagent
chromium trichloride	$\text{CrCl}_3 \cdot 6\text{H}_2\text{O}$	3	reagent
ferrous ammonium sulfate	$\text{Fe}(\text{NH}_4)_2(\text{SO}_4)_2 \cdot 6\text{H}_2\text{O}$	13	reagent
ferric chloride	$\text{FeCl}_3 \cdot 6\text{H}_2\text{O}$	1	certified
nickel chloride	$\text{NiCl}_2 \cdot 6\text{H}_2\text{O}$	1	certified
cupric chloride	$\text{CuCl}_2 \cdot 2\text{H}_2\text{O}$	1	certified
zinc chloride	ZnCl_2	1	certified
magnesium chloride	$\text{MgCl}_2 \cdot 6\text{H}_2\text{O}$	4	reagent
calcium nitrate	$\text{Ca}(\text{NO}_3)_2 \cdot 4\text{H}_2\text{O}$	3	reagent
barium nitrate	$\text{Ba}(\text{NO}_3)_2$	1	reagent
titanium trichloride	TiCl_3 , 20% solution	3	technical
manganese dichloride	$\text{MnCl}_2 \cdot 4\text{H}_2\text{O}$	4	reagent
molybdenum trioxide	MoO_3	1	certified
cadmium chloride	$\text{CdCl}_2 \cdot 2\frac{1}{2}\text{H}_2\text{O}$	1	certified
mercuric chloride	HgCl_2	2	reagent (>99.5%)
lead chloride	PbCl_2	1	certified (99.3%)
beryllium sulfate	$\text{BeSO}_4 \cdot 4\text{H}_2\text{O}$	2	reagent
tetrachloroauric(III) acid	$\text{HAuCl}_4 \cdot 3\text{H}_2\text{O}$	3	reagent
vanadium pentoxide	V_2O_5	3	reagent (100.0%)
strontium chloride	$\text{SrCl}_2 \cdot 6\text{H}_2\text{O}$	8	(>98%)

Table II-1 continued

Name	Formula	Supplier (see code above)	Grade
sodium hexachloroiridate	$\text{Na}_3\text{IrCl}_6 \cdot 12\text{H}_2\text{O}$	10	-
bismuth trichloride	BiCl_3	4	reagent
aluminum nitrate	$\text{Al}(\text{NO}_3)_3 \cdot 9\text{H}_2\text{O}$	4	reagent
stannic chloride	$\text{SnCl}_4 \cdot 5\text{H}_2\text{O}$	3	reagent (100.0%)
antimony trichloride	SbCl_3	1	certified
titanium sulfate	$\text{Ti}(\text{SO}_4)_2 \cdot 9\text{H}_2\text{O}$	1	purified
stannous chloride	$\text{SnCl}_2 \cdot 2\text{H}_2\text{O}$	3	reagent
lanthanum chloride	$\text{LaCl}_3 \cdot 6\text{H}_2\text{O}$	1	certified
scandium nitrate	$\text{Sc}(\text{NO}_3)_3$	14	-
uranyl acetate	$\text{UO}_2(\text{C}_2\text{H}_3\text{O}_2)_2 \cdot 2\text{H}_2\text{O}$	2	reagent
gallium nitrate	$\text{Ga}(\text{NO}_3)_3 \cdot 9\text{H}_2\text{O}$	6	99.99%
indium	In	1	99.95%
zirconium oxychloride	$\text{ZrOCl}_2 \cdot x\text{H}_2\text{O}$	5	practical
thallium chloride	TlCl	1	purified
sodium tetraphenylborate	$\text{NaB}(\text{C}_6\text{H}_5)_4$	1	reagent
silicon tetrachloride	SiCl_4	5	99.8%
hexafluorophosphoric acid	HPF_6	5	practical (65%)
boron trifluoride (45%)	$\text{BF}_3/\text{C}_2\text{H}_5\text{OC}_2\text{H}_5$	9	-
disodium EDTA	$\text{Na}_2\text{C}_{10}\text{H}_{14}\text{O}_8\text{N}_2 \cdot 2\text{H}_2\text{O}$	1	certified
ethylenediamine	$\text{C}_2\text{H}_8\text{N}_2$	1	certified
pyridine	$\text{C}_5\text{H}_5\text{N}$	1	certified
hydroxylamine hydrochloride	$\text{NH}_2\text{OH} \cdot \text{HCl}$	1	certified
hydrazine	H_2NNH_2	1	purified (85%)
n-butylamine	$\text{C}_4\text{H}_9\text{NH}_2$	1	certified (97.8%)
di-n-butylamine	$(\text{C}_4\text{H}_9)_2\text{NH}$	7	-
tri-n-butylamine	$(\text{C}_4\text{H}_9)_3\text{N}$	7	-
methylamine hydrochloride	$\text{CH}_3\text{NH}_2 \cdot \text{HCl}$	7	-

Table II-1 - continued

Name	Formula	Supplier (see code above)	Grade
dimethylamine hydrochloride	$(\text{CH}_3)_2\text{NH}\cdot\text{HCl}$	7	-
trimethylamine hydrochloride	$(\text{CH}_3)_3\text{N}\cdot\text{HCl}$	7	-
sec-butylamine	$\text{CH}_3\text{CHNH}_2\text{CH}_2\text{CH}_3$	7	-
tert-butylamine	$(\text{CH}_3)_3\text{CNH}_2$	7	-
ethylamine hydrochloride	$\text{CH}_3\text{CH}_2\text{NH}_2\cdot\text{HCl}$	7	-
n-hexylamine hydrochloride	$\text{C}_6\text{H}_{13}\text{NH}_2\cdot\text{HCl}$	7	-
tetramethylammonium bromide	$(\text{CH}_3)_4\text{NBr}\cdot\text{H}_2\text{O}$	9	-
tetra-n-butylammonium bromide	$(\text{C}_4\text{H}_9)_4\text{NBr}$	3	Baker grade
aniline	$\text{C}_6\text{H}_5\text{NH}_2$	7	-
acetamide	H_3CCONH_2	7	-
N-methyl acetamide	$\text{H}_3\text{CCONHCH}_3$	7	-
1,3-dimethylurea	$\text{H}_3\text{CNHCONHCH}_3$	7	-
ethyl carbamate	$\text{H}_2\text{NCOOC}_2\text{H}_5$	7	-
hydrogen peroxide (30%)	H_2O_2	1	-
dimethoxytetraethylene glycol	$\text{CH}_3(\text{OCH}_2\text{CH}_2)_4\text{OCH}_3$	5	practical

2. Procedure and Calculations

a. General Procedure

The following is a description of the sequence of operations which was followed in most typical experiments. Variations from the procedure existed in many instances but these exceptions will be outlined later.

1) Foam Cleaning, Cutting and Weighing

Cubes of foam were cut with a razor-sharp knife usually from cylinders 4.1 cm in diameter and 5.3 cm in height (but sometimes from various sizes of sheet stock for different foam types) to be approximately 1.3 cm on edge. Occasionally, larger pieces were cut for specific purposes but any smaller pieces were later cut from 1.3 cm cubes.

Metal ions which may have remained from their manufacture were removed by placing the cubes, in batches of 100, into a 1 liter Pyrex beaker filled with 1 M HCl. The foam pieces were squeezed vigorously and repeatedly using the base of a measuring cylinder to expel air bubbles and to cause the foam pieces to imbibe the acid wash. The surface of the beaker was then covered with polyvinylchloride film to exclude dust and the whole was left to leach for one hour. At the end of this time, the beaker was uncovered and the squeezing process repeated to flush fresh wash liquid into the foam pieces after which it was again covered to leach for a further one hour. This process of periodic squeezing was continued for 12 hours then the acid was squeezed from the foam pieces and replaced several times with distilled water accompanied by squeezing of the foams. This rinsing process was continued until 10 minutes squeezing of the foams with a fresh batch of distilled water

failed to produce a visible precipitate when the rinse water was added to a one percent AgNO_3 solution. As much water as possible was then squeezed from the foam pieces and they were next transferred for further washing to the upper chamber of a Soxhlet extractor (no thimble installed) of approximately 1 liter capacity. The lower receiving flask of the Soxhlet apparatus was filled with reagent grade acetone sitting over type 5A molecular sieves to aid in removing water. Extraction of the foams with acetone in this manner was continued for 6 hours (during which the Soxhlet filled and emptied about 20 times) in order to remove any unpolymerized organic materials, water, soluble metal complexes or traces of HCl still present. At the end of this time, the excess acetone was squeezed thoroughly from the foam pieces which were then laid out to dry in air for about 30 minutes. The foam pieces were next transferred to a vacuum desiccator (containing no desiccant) attached to a good mechanical pump where traces of acetone were removed overnight.

The roughly cut and washed foam pieces were next individually trimmed with the knife to weigh 50 ± 2 mg (except where other weights were specifically required). Foam pieces falling outside this range were not used. The cleaned and trimmed foams were stored sealed in polyethylene bags sheltered from light until needed.

In preparation for an experiment, a number of foam pieces (usually 10) were removed from storage and placed in an electrically grounded aluminum cavity for several hours prior to weighing. This was done in order to dissipate static charges which tended to develop on the foam and which caused serious weighing errors when unremedied. The exact weight of each foam piece was determined to the nearest hundredth of a milligram shortly before it was placed in a distribution cell for experi-

mentation.

2) Distribution Cell Assembly and
Installation in Squeezing Cabinet

The pieces of the glass distribution cell shown in Figure 2-2 were assembled as shown in Figure 2-1 according to the following sequence. First, the lower end of the spring (G, Figure 2-2) was stretched over the lip on the upper neck of the cell top (C) and the plunger (D) was then inserted from the bottom through the neck and spring as far as possible. The top end of the spring was then spread slightly using pliers so as to allow its insertion into the hole in the side of the plunger stem. High vacuum silicone grease was applied to the glass flange on both the cell top (C) and bottom (D) as well as to the penny-head stopper (B) which was inserted into the sampling arm.

A light film of this grease was also applied during some experiments to the shaft of the plunger (D) in the area between the broad base and Teflon film. Grease thus applied in the region of the plunger stem, which was repeatedly pushed through the solution surface during operation, was found to be very useful in scavenging bits of polyurethane foam which on occasion were broken off during squeezing. This proved to be of considerable importance since such bits generally represented a large analytical problem in trying to assess equilibrium solution metal concentration if left floating freely in solution (usually considerable ^{60}Co was in these bits).

The bottom cell section (containing a dry weighed foam piece) as well as the top were then fitted together and fastened with four elastic bands. One or two condoms were slipped over the spring and sealed snugly to the plunger stem and cell top neck with additional elastic

bands. Finally, the Teflon cap was pushed onto the top of the condoms and plunger shaft then the entire assembly was placed in its appropriate location in the squeezing cabinet as shown in Figure 2-5. The two clamps holding the cell top and bottom in place were tightened and adjusted so as to center the plunger base radially in the cell bottom so it would not rub the sides when in operation.

When all ten cells had been inserted in this way, final adjustments were made and paper shims were placed under each cell so as to compress the foam to 1 mm thickness when the cam was in its lowest position of travel. The cam was adjusted to its uppermost position, the cabinet was closed with all pieces of polystyrene insulation in position and the temperature regulating system was activated overnight to bring the entire cabinet to stable operating temperature (25.00°C).

3) Solution Preparation and Handling

A series of ten solutions was prepared in separate numbered 150 mL volumetric flasks for each experiment. The choice of which numbered volumetric flask (and consequently which numbered distribution cell) would receive a particular solution in the series was made deliberately at random by consulting a random number generator in planning the experiment. In this way, it was hoped to reduce effects of any unknown biases in the squeezing cells, mechanism or temperature profile to simple scatter in the results which could eventually be detected and would not be confused with legitimate experimental trends.

Usually, the list of reagents to be added to each flask included a thiocyanate salt, cobalt chloride, sodium acetate/acetic acid buffer, an inert salt to adjust ionic strength and ^{60}Co tracer. The contents of each flask most often differed from that of the other nine by only one key parameter (e.g. pH, thiocyanate concentration, cobalt concentration, ionic strength, etc.) but in some cases all ten flasks contained identical solutions (for instance, where the effect of various foam types or weight of foam used were being compared).

For each type of experiment, slight differences in procedure were necessary or convenient in order to prepare the ten solutions. In some cases, individual weights or aliquots of stock solutions of each necessary reagent were added separately to each of the ten volumetric flasks while in other cases it was possible to include many or all of the reagents in a single stock solution from which only one aliquot needed to be measured into each flask. Since each experiment type represented a different circumstance to deal with, no truly general procedure for the

solution preparation can be described.

Once prepared, however, the various solutions were handled in nearly identical fashion. In all cases, the last component to be added to the solution was the aliquot (30 or 40 microliters) of ^{60}Co tracer solution. This quantity of tracer was sufficient to give an initial solution count rate of from 100 to 2000 disintegrations per second when measured by the procedure described later. Following this, the solution was brought to somewhat below the etched mark on the volumetric flask, stoppered, and mixed thoroughly. The solutions were then allowed to sit at room temperature overnight before final volume adjustments and mixing were performed. This procedure was necessary since temperature changes (usually cooling) often accompanied mixing of the solutions and this resulted in noticeable volume changes. In addition to allowing thermal equilibrium to be regained, the overnight period also allowed ample time for tracer/carrier cobalt randomizations and also establishment of some other solution equilibria to occur.

Generally speaking, it soon became apparent that when dealing with cobalt extraction from thiocyanate solution, the use of near optimum solution conditions in experiments to determine the effect of one parameter on equilibrium would be fruitless. This arose from the extraordinarily high values of extraction which were found to exist under such conditions thereby making it analytically very difficult to distinguish any differences on top of inherent experimental scatter. Thus, a decision was made to deoptimize one or more parameters to bring extraction into an accurate and comfortable measuring range. Usually, the thiocyanate concentration was kept deliberately low for this reason except in a few instances.

4) Experimental Sequence, Sample Taking and Counting

Once diluted to the mark and vigorously mixed, a sample of solution was withdrawn from the first volumetric flask and used to fill a numbered calibrated 15 mL counting tube just to the etched mark. A dry 15 mL pipet from which the tip had been cut to speed filling and delivery was used to perform this operation. The tube was then placed in the well of the Baird-Atomic gamma spectrometer (which had been left on overnight to reach stable temperature) and counted for ten consecutive 100 second periods. At the conclusion of ten counting periods, it was withdrawn and replaced by the next tube filled in a similar fashion from the next volumetric flask. The entire contents of the first tube were then carefully returned to the original volumetric flask. The flask was then completely emptied into the first distribution cell through its sampling arm by means of a funnel and the squeezing cam was started in motion to begin equilibration with the foam. Tests to establish what volume of solution was actually transferred to the distribution cell in this way indicated that between 99.70 and 99.75 percent of the 150.0 mL reached its destination. During the brief process of filling the cell and in later sample withdrawals, the cabinet air circulation fan was always turned off while the doors were open in order to reduce losses of thermostatted air. The pipet and funnel were carefully washed and dried in preparation for the next solution to be sampled and transferred. Similarly, the numbered counting tubes (a single tube was reserved for each of the ten cells) were cleaned to prepare them for later sample withdrawals.

Once all ten solutions had thus been counted in turn and transferred to the distribution cells (about three hours) it was possible at any time

to begin removing solution samples from the first cells for counting to assess the degree of equilibrium attainment. During this procedure, a sample was withdrawn through the sampling arm of the first cell using the 15 mL pipet while manually holding the cell plunger out of the way in the down position. This sample was used to fill to the mark the same numbered counting tube as was used originally before counting again for ten consecutive 100 second periods. After counting, the tube contents were returned to the first distribution cell via the sampling arm then the process was repeated with the next and other cells until all had been counted. During these manoeuvres, visual observations of both the solutions and foam pieces were also recorded.

In early experiments, samples were removed for counting immediately after 3 hours equilibration and then again at 6, 12 and 24 hours. However, the 3 hour sample proved to give no important information so was dropped in favour of the 6, 12 and 24 hour samples alone (and occasionally 36 and 48 hour samples when the experiment was continued that long). Although creating considerable additional work, the practice of sampling the solutions on three or more occasions during equilibration made it possible to assess when the experiment could be halted due to equilibrium attainment, sometimes allowed a qualitative comparison between rates of equilibration under different conditions and also pointed up several instances in which equilibrium was never attained due to certain chemical changes occurring in solution. For these reasons, this practice was continued for all experiments except one which will be described later.

After equilibrium had been judged to be attained, the foam pieces were finally examined and discarded. However, in many instances the solutions were retained long enough to measure their final pH by glass

electrode. This was especially true for solutions to which interferences had been added or when the usual acetate buffer was not present.

When time became available during the sampling regimen outlined above, an evaluation of the background on the gamma counter was made by counting for 100 periods of 100 seconds duration while no samples or standards were in the detector. Counting tubes and distribution cells were routinely checked for any contamination as part of the washing procedure between experiments. Contamination of the tubes by ^{60}Co was not usually found to occur unless cracks developed in the walls whereupon they had to be discarded.

A necessary modification to the procedure which became apparent only in the later experiments performed was prompted by the discovered sensitivity of the gamma counter response to fluctuations in room temperature even after a lengthy warmup period. Although the resulting errors generally applied equally to all ten solutions in a series so did not alter the relative order of results obtained, differences as high as three percent of the measured count rate were observed on one occasion when severe room temperature fluctuations occurred. The problem was rectified by preparing a counting tube containing a fixed quantity of ^{60}Co in solid form at its bottom and by its inclusion as an eleventh tube in each sample counting sequence. The sensitivity of the gamma counter was thus checked repeatedly against the standard and corrections for drift could be applied.

It should be pointed out at this point that the procedure followed, on the whole, proved to be most satisfactory and produced very reliable data. In particular, the practice of counting all samples taken from an individual distribution cell before, during and after equilibrium

attainment in the same calibrated tube removed all problems relating to differing wall thicknesses and geometries. In addition, as will be discussed in more detail later, the ability to fill the counting tubes to a mark situated well above the active volume of the scintillation crystal reduced to negligible values the counting errors resulting from variations in adjusting to the mark. Further, since more than ample time was usually given for the attainment of equilibrium between foam and solution, differences arising out of distribution cell squeezing efficiencies or foam geometry tended to disappear.

b. Calculations

The mass of numbers which were generated by the experimental procedure was converted into chemically useful information by the following data treatment procedures. To clarify the description a complete typical set of data is presented in Table II-2 to which frequent reference will be made. Extra figures have often been carried through the calculations to avoid cumulative round-off errors and to aid in illustration but the question of significant figures will be dealt with later.

1) Mean and Standard Deviation⁽²¹⁷⁾

As a first step in data treatment, it was necessary to obtain the best possible estimate of the true mean, μ , from the many individual values, x_i , measured. To do this, the mean, \bar{x} , and standard deviation, σ_x , were calculated for each set of n replicate radiometric counts belonging to a single sample or background as follows:

$$\mu \approx \bar{x} = \frac{\sum_{i=1}^n x_i}{n} \dots\dots\dots (21)$$

$$\sigma_x = \sqrt{\frac{\sum_{i=1}^n (\bar{x} - x_i)^2}{(n-1)}} \dots\dots\dots (22)$$

For example, in Table II-2 Part A the mean value and standard deviation of A_0 (solution activity prior to foam contact; subscripts denote contact time in hours) are found to be 36195 ± 217 disintegrations per 100 seconds (d/100s) by applying equations (21) and (22) to the ten (n=10) values measured. Other data in Table II-2 were treated similarly to obtain the results shown there. For considerations of space, the

TABLE II-2 - SAMPLE DATA AND CALCULATIONS

Part A: Data and Observations

Initial Conditions: [Co] 1.7 x 10⁻⁶ M (0.10 ppm) Foam Weight 0.050 g
 [SCN⁻] 0.50 M (NaSCN) Type #1338 BFG
 pH 4.8 (0.10 M Na acetate buffer) Temperature 25.00°C
 Solution Volume (V) ... 150.0 ml

Data:

Symbol	Description	Untreated Data (d/100s)	Mean ± σ _x		95% Confidence Interval	
			All Data (d/100s)	After Rejections (d/100s)	Uncorrected (d/100s)	Corrected for Background and Drift (d/100s)
B	Background	-	225 ±14	225 ±14	225 ±3	0
A ₀	Solution activity prior to foam contact	36221, 35902, 36683 36303, 36024, 36124 36007, 36326, 36208 36154	36195 ±217	36141 ±142	36141 ±108	(A ₀ [']) 35916 ±108
A ₆	Solution activity after 6 hours foam contact	6989, 6895, 6946, 7069 7028, 7077, 6975, 7029 6951, 7054	7001 ±60	7001 ±60	7001 ±43	(A ₆ [']) 6776 ±43
A ₁₂	Solution activity after 12 hours foam contact	6799, 6966, 6948, 6985 7081, 6877, 7006, 6971 6915, 6898	6945 ±77	6945 ±77	6945 ±55	(A ₁₂ [']) 6720 ±55
A ₂₄	Solution activity after 24 hours foam contact	6851, 6904, 6915, 6970 6937, 6960, 6922, 6973 6727, 6916	6908 ±73	6928 ±38	6928 ±29	(A ₂₄ [']) 6703 ±29

TABLE II-2 - continued

Symbol	Description	Untreated Data (d/100s)	Mean $\pm \sigma_x$		95% Confidence Interval	
			All Data (d/100s)	After Rejections (d/100s)	Uncorrected (d/100s)	Corrected for Background (d/100s)
Y ₀	Spectrometer calibration at beginning	103016, 102050, 101786	102384 ±376	102384 ±367	102384 ±269	(Y ₀) 102159 ±269
		102687, 102578, 102441				
		102216, 102559, 102551				
		101957				
Y ₆	Spectrometer calibration after 6 hours	101836, 102847, 102393	102554 ±439	102554 ±439	102554 ±314	(Y ₆) 102329 ±314
		101810, 102667, 102714				
		102441, 103041, 103021				
		102766				
Y ₁₂	Spectrometer calibration after 12 hours	102376, 102602, 102384	102479 ±220	102534 ±143	102534 ±104	(Y ₁₂) 102309 ±104
		102415, 101986, 102748				
		102657, 102408, 102679				
		102534				
Y ₂₄	Spectrometer calibration after 24 hours	102316, 102583, 102887	102421 ±418	102421 ±418	102421 ±299	(Y ₂₄) 102196 ±299
		102970, 102162, 101833				
		101940, 102829, 102659				
		102032				

Notes: 1. Values underlined are rejected according to Chauvenet's Criterion.

2. Some apparent disregard for significant figures is displayed solely for the purpose of clarity of illustration here.

TABLE II-2 - continued

Observations:

Exact foam weight (w)	0.05053 g
pH measured after 24 hours	4.63
Distribution cell number	6
Counting tube number	6
calibration factor	0.9932 ± 0.0015
Foam colour after several minutes	pale blue-grey
6 hours	blue-green
12 hours	blue-green
24 hours	blue-green

TABLE II-2 - continued

Part B: Calculations

Foam Contact Time (hours)	95% Confidence Interval		
	%E	D (L kg ⁻¹)	log D
6.0	(%E ₆)	(D ₆)	(log D ₆)
	81.16 ±0.15	12790 ±110	4.107 ±0.004
12.0	(%E ₁₂)	(D ₁₂)	(log D ₁₂)
	81.32 ±0.17	12920 ±120	4.111 ±0.004
24.0	(%E ₂₄)	(D ₂₄)	(log D ₂₄)
	81.34 ±0.12	12940 ±90	4.1120 ±0.0029

untreated data for B (background) are not included but yielded a mean and standard deviation of 225 ± 14 d/100s when equations (21) and (22) were applied using $n=100$.

2) Data Rejection

The individual numbers, x_i , from which the averages were determined were then scanned for discordant ones to be rejected. Any suspect numbers were subjected to Chauvenet's criterion⁽²¹⁸⁾ of rejection. According to this criterion, widely applied to radiometric data, a value is to be discarded if it "has a deviation from the mean greater than that corresponding to the $1/2n$ probability limit". Put into more easily understood terms, this means that values which are more than a certain number, r , of standard deviations from the mean, \bar{x} , are to be rejected (i.e. beyond $\bar{x} \pm r\sigma_x$). The value of r (see Table II-3) depends upon the number, n , of data points. Applying this principle to the B (background) data of Table II-2, we see that any values which would lie outside the range $225 \pm (2.80)(14) = 225 \pm 39$ d/100s (since $\bar{x} = 225$ d/100s, $\sigma_x = 14$ d/100s, and $r = 2.80$ for $n = 100$) would have to be discarded. However, as none such existed, all 100 data values were used. On the other hand, in similar consideration of the A_0 (solution activity prior to foam contact) data, one value (36683 d/100s) lies outside the interval $36195 \pm (1.96) \cdot (217) = 36195 \pm 425$ d/100s (since $\bar{x} = 36195$ d/100s, $\sigma_x = 217$ d/100s and $r = 1.96$ for $n = 10$) and is thus rejected. Like treatment of the remaining data in Table II-2 yields the results shown. Having thus performed any necessary data rejection, a new mean and standard deviation were then calculated according to equations (21) and (22) omitting the rejected data and are included in Table II-2 where appropriate.

Table II-3 - Chauvenet's Criterion for Rejecting a Reading ⁽²¹⁸⁾

Number of Readings, n	Ratio, r, of maximum acceptable deviation to standard deviation, σ_x
5	1.68
6	1.73
7	1.79
8	1.86
9	1.92
10	1.96
20	2.24
30	2.39
40	2.50
50	2.58
100	2.80

Table II-4 - Critical Points of the "t" Distribution ⁽²¹⁷⁾
(for 95% confidence)

Number of Degrees of Freedom (n-1)	t
1	12.706
2	4.303
3	3.182
4	2.776
5	2.571
6	2.447
7	2.365
8	2.306
9	2.262
10	2.228
15	2.131
20	2.086
25	2.060
30	2.042
∞	1.960

3) 95% Confidence Interval

A 95% confidence interval of the true mean, μ , was then determined for use in all further calculations as :

$$\mu = \bar{x} \pm \frac{t\sigma_x}{\sqrt{n}} \dots\dots\dots (23)$$

where \bar{x} , σ and n are the parameters pertaining to the set of numbers excluding rejected data. The value of t is obtained from a Student's t Distribution table⁽²¹⁷⁾ (part of which is reproduced in Table II-4) selecting the entry for $(n-1)$ degrees of freedom and a 95% probability level. When so calculated, the true mean, μ , will lie within the interval given by equation (23) 95 out of 100 times.

For example, applying this calculation to the data for B (background) in Table II-2 where we have $\bar{x} = 225$ d/100s, $\sigma_x = 14$ d/100s, $n = 100$ and $t = 1.960$ (from Table II-4 taking $n-1 = 99 \approx \infty$), we arrive at a 95% confidence interval of $225 \pm \frac{(1.96)(14)}{\sqrt{100}} = 225 \pm 2.7 \approx 225 \pm 3$ d/100s.

Similarly, for A_0 , where $\bar{x} = 36141$ d/100s, $\sigma_x = 142$ d/100s, $n = 9$ and $t = 2.306$ (from Table II-4), we obtain a 95% confidence interval of $36141 \pm \frac{(2.306)(142)}{\sqrt{9}} = 36141 \pm 108$ d/100s. Other entries in Table II-2

have been calculated in the same manner.

4) Background Subtraction and Spectrometer Drift Correction

Each of the means calculated above was next corrected for the background, B, by simple subtraction. The resulting background corrected values are distinguished by primes (').

$$A'_i = A_i - B \dots\dots\dots (24)$$

For example,

$$\begin{aligned} A'_{24} &= A_{24} - B = (6928 \pm 29) - (225 \pm 3) \\ &= (6703 \pm 29) \text{ d/100s} \end{aligned}$$

where A'_{24} is the solution activity after 24 hours of foam contact corrected for background. The uncertainty in the result is determined according to standard error propagation rules⁽²¹⁷⁾ as the square root of the sum of the squares of the uncertainties in the individual values (i.e. $\sqrt{(29)^2 + (3)^2} = 29$). Similarly, values for $A'_0, A'_6, A'_{12}, Y'_0, Y'_6, Y'_{12}$ and Y'_{24} were also calculated and included in Table II-2 as well.

For those experiments in which periodic calibration checks were made of the sensitivity of the spectrometer to allow for drift (i.e. the Y values), corrections were made to the solution activity data. These corrections had the effect of simulating all of the samples having been counted at the same time at the beginning of the experiment rather than at several times over its duration. The data are corrected for spectrometer drift as follows and are distinguished by double primes ('')

$$A''_i = A'_i \frac{Y'_0}{Y'_i} \dots\dots\dots (25)$$

For example:

$$\begin{aligned} A''_{24} &= A'_{24} \frac{Y'_0}{Y'_{24}} \\ &= (6703 \pm 29) \frac{(102159 \pm 269)}{(102196 \pm 299)} \\ &= (6701 \pm 39) \text{ d/100s} \end{aligned}$$

where A''_{24} is now the solution activity after 24 hours of foam contact corrected for both background and spectrometer drift. According to rules of standard error propagation, the uncertainty in the result is given by the product of the result with the square root of the sum of the squares of the individual fractional errors (i.e. $6701 \cdot \sqrt{(29/6703)^2 + (269/102159)^2 + (299/102196)^2} = 39$). Likewise, the values of A_6 , A_{12} and their uncertainties were also determined and appear in Table II-2.

5) Percent Extraction of Cobalt, %E

The percent of cobalt extracted by polyurethane foam was determined indirectly by measurements of the disappearances of ⁶⁰Co from solution. This method inherently assumes that all cobalt leaving solution is transferred only to polyurethane foam. The correctness of this assumption was assured by the use of chemically inert substances in the construction of the distribution cells and finally tested in blank experiments which showed no measurable disappearance of ⁶⁰Co from solution in the absence of foam. Assuming exactly linear spectrometer response to tracer concentration (which will be demonstrated later), the percent extracted was thus calculated as:

$$%E_i = \left(1 - \frac{A''_i}{A''_0} \right) \times 100\% \quad \dots\dots\dots (26)$$

For example, the percent extraction of cobalt after 24 hours contact is given by:

$$\begin{aligned} %E_{24} &= \left(1 - \frac{A''_{24}}{A''_0} \right) \times 100\% = \left(1 - \frac{(6701 \pm 39)}{(35916 \pm 108)} \right) \times 100\% \\ &= 81.34 \pm 0.12\% \end{aligned}$$

Again, the uncertainty is given by the square root of the sum of the squares of uncertainties of the individual values all multiplied by the constant, 100 (i.e. $\sqrt{(39/6701)^2 + (108/35916)^2} \times 100 = 0.12$). Values for %E₆, %E₁₂ and their uncertainties were similarly calculated and presented in Table II-2 Part B.

6) Distribution Ratio, D

It is common practice⁽²¹⁹⁾ in describing the distribution of a substance, M, between two phases (1 and 2) to define a distribution ratio, D, as:

$$D = \frac{\text{Concentration of M (in all forms) in Phase 2}}{\text{Concentration of M (in all forms) in Phase 1}} \dots\dots\dots (27)$$

D will approach an equilibrium value with time but is not strictly an equilibrium constant since it potentially involves a multiplicity of individual species in each phase and therefore can be dependent on the concentration of M or on a variety of other variables. However, although the extent of extraction of M from Phase 1 to Phase 2 will vary widely according to the relative volumes of the two phases, D calculated in each case should remain constant and herein lies the utility of the distribution ratio. Applying the concept to the extraction of cobalt by polyurethane foam, we have:

$$D = \frac{\text{Concentration of Co (in all forms) in foam}}{\text{Concentration of Co (in all forms) in solution}} \dots\dots\dots (28)$$

Since it is neither convenient to measure the volume of foam accurately (excluding air spaces) nor to weigh all volumetrically prepared solutions, it was considered desirable to express the cobalt concentration of the solution in moles per liter while expressing that in the foam in moles per kilogram. Thus, D has the units L kg⁻¹. Furthermore, since the number of moles of Co in the foam phase is proportional to the percentage extraction, %E, while that remaining in solution is proportional to (100-%E), we may immediately simplify equation (28) for

computational purposes to:

$$D_i = \frac{\%E_i}{(100 - \%E_i)} \frac{V}{W} \dots\dots\dots (29)$$

where V is the solution volume, in liters, and W is the weight of foam, in kilograms. Equation (29) was used to calculate D after 6, 12 and 24 hours of contact between the two phases. For example, after 24 hours:

$$D_{24} = \frac{\%E_{24}}{(100 - \%E_{24})} \frac{V}{W} = \frac{(81.34 \pm 0.12)}{(18.66 \pm 0.12)} \frac{(150.0 \times 10^{-3} \text{ L})}{(0.05053 \times 10^{-3} \text{ kg})}$$

$$= 12942 \pm 87 \text{ L kg}^{-1}$$

and $\log D_{24} = \log (12942 \pm 87) = 4.1120 \pm 0.0029$

In calculating the uncertainty in D, errors in both V and in W have been neglected. This arises from the fact that the estimated indeterminate relative errors in V and W are about $\pm 0.07\%$ and $\pm 0.02\%$ or less respectively while that in %E is at least about $\pm 0.15\%$ and is most often much larger. The uncertainty in D is calculated, therefore, simply as the product of D and the square root of the sum of the squares of the fractional errors in %E and (100 - %E) (i.e. $\sqrt{(0.12/81.34)^2 + (0.12/18.66)^2} \times 12942 = 87 \text{ L kg}^{-1}$). The uncertainty in log D is most properly given by evaluating log D for each of the extremes defined by the range 12942 ± 87 . Since the logarithmic function is non-linear, this generates noticeably asymmetrical bounds for the range of log D if the error is quite large. However, for small errors it is approximately symmetrical. Values of D_6 , D_{12} and their logarithms have similarly been calculated and appear in Table II-2, Part B.

Generally speaking, only the $\%E_{24}$ and D_{24} values were used in

comparisons between members in an experimental series although, on rare occasions, when mechanical problems made this value less than reliable the $\%E_{12}$ and D_{12} values could be used instead without large error.

7) Uncertainties

At this point, it is perhaps worth considering the importance of the uncertainty calculations in the experiment. When available, reliable uncertainties provide a reasonable basis on which to assign significant figures to the data. All determinations of uncertainty have been based only on radiometric counting errors which are both important and significant but which nevertheless do not account for all scatter observed in experimental data. In addition to counting errors, there are definite (and likely important) effects resulting from uncertainties in reagent volume and weight measurements, temperature fluctuations, etc. which should ideally be assessed for each experiment by its repetition several times. Although desirable, this is not generally feasible unless one is prepared to sacrifice large amounts of well-resolved experimental data in favour of many fewer but repeated experiments. Of course, for all experiments in which data are presented graphically, a visual assessment of total variability is usually available anyway if sufficient data points are presented throughout the range. In practice, while at least placing a lower limit on the actual total uncertainty and also providing a check on the performance of the gamma counter, uncertainties calculated from counting statistics alone provide the ability to distinguish when changes in D with time are within experimental error and thus when equilibrium is functionally reached for a given solution in a distribution cell since all other variables are then fixed.

8) Significant Figures

In reporting data in Part B of Table II-2 and in the remainder of this work, the practice has been adopted of retaining two significant figures in the calculated uncertainties when the two most significant digits are between 10 and 34 while only one is retained when they are from 35 to 99. This is a very slight modification (toward conservation of data) of the procedure as suggested by Shoemaker and Garland⁽²²⁰⁾ (who suggest limits of 10 to 30 and 31 to 99 respectively). The data to which these uncertainties belong, then, are rounded to give the same number of decimal places as are present in the uncertainty. Thus, for example, 15.0966 ± 0.0326 is rounded and reported as 15.097 ± 0.033 while 13.1561 ± 0.0429 becomes 13.16 ± 0.04 .

9) Graphical Presentations

The important results of many experiments are displayed in graphical form. Error bars representing the 95% confidence intervals calculated from radiometric counting statistics have been included in the presentations wherever the uncertainty is larger than the size of symbol used marking the position of each point.

Often, apparently linear relationships are represented by portions of the graphs. For these portions, the slope, m , of the best straight line passing through the points has been calculated by the least squares method of linear regression⁽²¹⁷⁾ (which minimizes the sum of the squares of the differences between the calculated and measured quantities at each point) and included on the graph. In addition, as an assessment of the degree to which the calculated line fits the data, the correlation coefficient, r , has also been determined⁽²¹⁷⁾ as:

$$r = m \frac{\sigma_x}{\sigma_y} \dots\dots\dots (30)$$

where σ_x and σ_y are the standard deviations of the values plotted on the x-axis and y-axis respectively for those points included in determining the line. Defined in this way, perfect correlation between the experimental data and the line yields $r = \pm 1.000$ (the sign depending on that of m) while no correlation would give $r = 0.000$. Values of correlation coefficient, r , have been included where appropriate with those of slope, m , on the graphs to allow numerical assessment of the linearity of the relationship displayed.

C. RESULTS AND DISCUSSION

1. Preliminary Experiments

a. Relationship Between Measured Count Rate and Volume of Solution in Counting Tubes

When first considering the use of Pyrex test-tubes as receptacles for radioactive solutions to be counted, the question arose of how much solution should be used to obtain optimum performance.

To establish the relationship between the filling volume and measured count rate, a single tube was counted for five 100 second intervals when empty (to establish the background) and then again with successive 1.00 mL additions of an ^{192}Ir tracer solution up to the capacity of the tube (about 17 mL). After subtracting the background in each case, the resulting measured count rates for each filling volume were used to calculate the approximate relative error which would result if a ± 0.1 mL error in volume were to occur (about the largest conceivable volume misjudgement).

The results are gathered into Table II-5 and displayed graphically in Figure 2-8. We see from this that beyond about 5 mL, added volumes of radioactive solution have less and less influence on the measured count rate. This arises out of the fact that the crystal well has a depth of only 39 mm whereas the counting tubes extend above this by about 85 mm. To take advantage of the precision thus made possible by using tubes filled to near capacity, each tube was subsequently calibrated by pipet and scribed at 15.0 mL. At this position, relative errors in measurement of no more than $\pm 0.07\%$ are expected assuming ± 0.1 mL

measuring error. Although added precision could be attained by still greater filling volumes, the increased risks of solution spillage were not considered to be desirable. Once calibrated, this set of tubes was used extensively in the experiments to follow.

TABLE II-5 RELATIONSHIP BETWEEN MEASURED COUNT AND VOLUME OF SOLUTION IN TEST-TUBES

Conditions:

NaI(Tl) crystal diameter 50 mm
 length 55 mm
 Counting well diameter 17 mm
 depth 39 mm
 Test-tube diameter 16 mm
 length 125 mm
 Isotope ¹⁹²Ir

Volume of Solution in Test-tube (mL)	Average* Count Rate (sec ⁻¹)	Approximate Relative Error in Count Rate Resulting from ±0.1 mL Error in Volume (%)
1.0	405	±10.0
2.0	811	±4.9
3.0	1201	±3.1
4.0	1564	±2.1
5.0	1870	±1.4
6.0	2094	±0.90
7.0	2246	±0.57
8.0	2351	±0.39
9.0	2430	±0.29
10.0	2490	±0.20
11.0	2530	±0.16
12.0	2569	±0.13
13.0	2597	±0.10
14.0	2621	±0.083
15.0	2641	±0.074
16.0	2660	±0.051
17.0	2668	±0.027

* Average of five 100 second counting periods

Figure 2-8

Relationship between measured count
rate and volume of solution in
counting tubes.

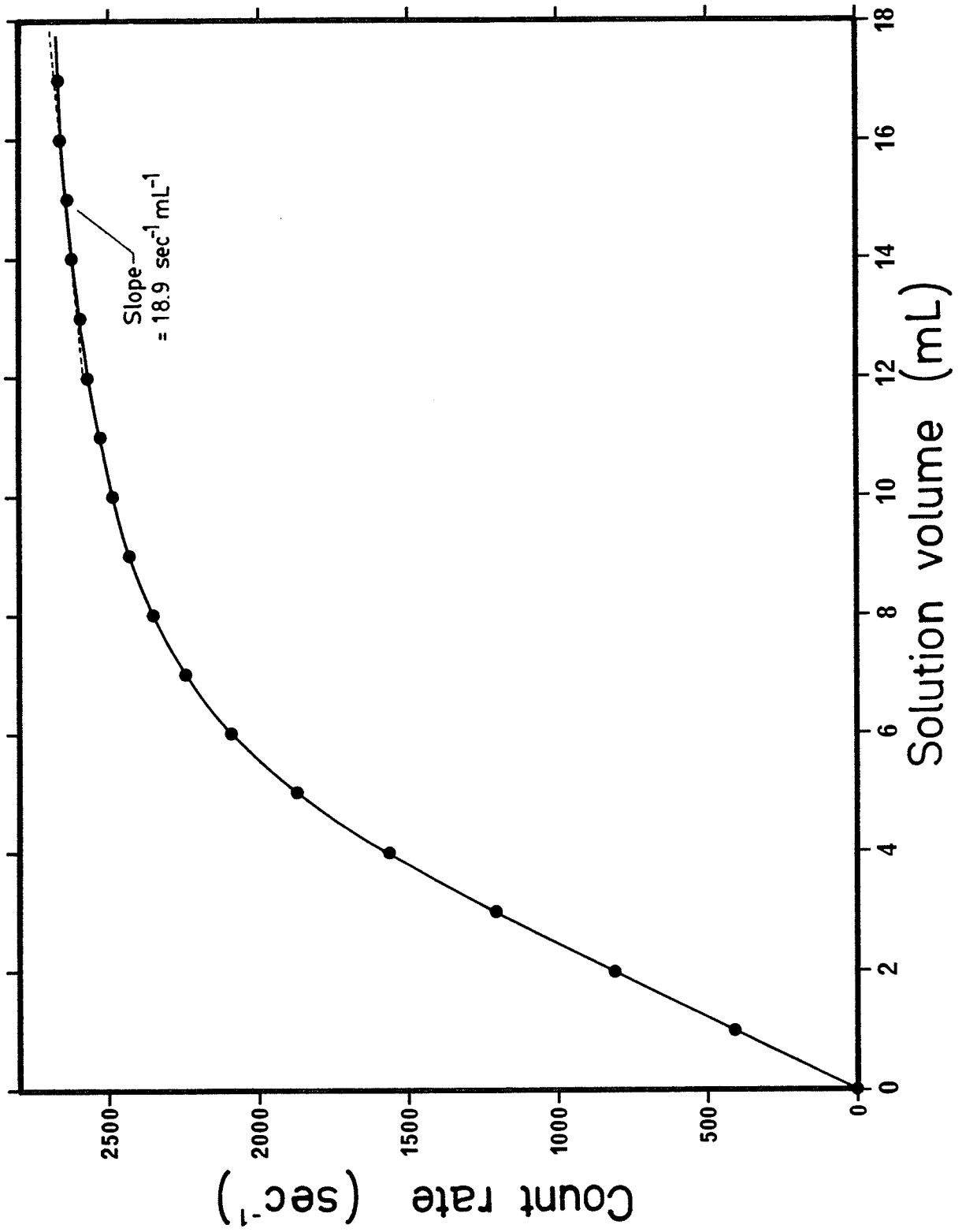

b. Determination of Gamma Counter
Linearity and Dead Time

In order to make direct comparisons between the concentrations of radioactive tracer present in solution both before and after contact with polyurethane foam, it was necessary to determine a calibration curve for the gamma counter.

To accomplish this, a large volume of ^{192}Ir stock tracer solution was first prepared in 20% (w/w) hydrochloric acid. Various amounts, w, of this solution ranging from a few milligrams to many grams were then weighed directly into individual calibrated Pyrex counting tubes. Additional 20% hydrochloric acid was added to each tube to bring it exactly to the 15.0 mL mark, the contents were mixed very carefully with a glass rod and the top of the tube was sealed with polyvinylchloride film to retard evaporation. Each tube was then counted a total of 15 times, in groups of five, for various periods of time (from 10 to 500 seconds each) in order to accurately establish the count rate measured by the spectrometer. Owing to the length of time required to complete the counting operation and also to the moderate half-life of the radioisotope used (^{192}Ir , $t_{1/2} = 74.4$ days), it was necessary to apply decay corrections⁽²²¹⁾ to the data obtained as follows:

$$N_0 = N e^{\frac{\ln 2}{t_{1/2}} \cdot t} \dots\dots\dots (31)$$

where N is the measured count after some time, t, has elapsed, N_0 is the count expected at time zero and $t_{1/2}$ is the half-life of the radioisotope expressed in the same units as t. Values for the background as measured in each of the empty tubes had been determined prior to filling

them by ten consecutive periods of the same duration (from 10 to 500 seconds) as was used when full. Using these determinations, the above data were corrected for the background by simple subtraction. These results were then corrected for the geometry differences of the various tubes by multiplying each of them by the calibration factors previously determined for each tube to yield, finally, the corrected net count rate, n , in seconds⁻¹.

The results of these calculations appear in Table II-6 and are displayed graphically on a logarithmic scale in Figure 2-9. It will be seen from the data that no significant deviation from linearity occurs below about 20 000 seconds⁻¹. Since in all cases no experiment exceeded an initial solution activity of 2000 seconds⁻¹, it is evident that the assumption of strictly linear detector response is a valid one.

The data of Table II-6 were also used to obtain an evaluation of the spectrometer dead time to check its performance. The relationship between measured and actual count rate is⁽²²¹⁾:

$$\frac{1}{n} = \frac{1}{N} + t_d \quad \dots\dots\dots (32)$$

where n is the measured count rate, N is the expected count rate and t_d is the dead time of the spectrometer. Since we anticipate the expected count rate, N , to be directly proportional to the weight, w , of tracer solution taken, we may write:

$$\frac{1}{n} = \frac{1}{kw} + t_d \quad \dots\dots\dots (33)$$

where k is some constant such that $N = kw$. Thus, t_d is obtained as the y-intercept of the line resulting from a plot of $1/n$ against $1/w$ (not shown). The results of the calculation using linear regression to fit the best line to the data give $t_d = 4.5 \pm 0.3$ microseconds which is a typical value for a NaI(Tl) crystal detector.

TABLE II-6 LINEARITY CHECK AND DEAD TIME
EVALUATION OF GAMMA SPECTROMETER

Conditions:

Spectrometer Baird-Atomic model 530A
 Detector NaI(Tl) well-type
 Radioisotope ^{192}Ir

Tube Number	Counting Interval (sec)	Tracer Solution Weight, w (mg) ± 0.3	$\frac{1}{w}$ (mg^{-1})	Corrected* Net Count Rate, n (sec^{-1})	$\frac{1}{n}$ (sec)
1	500.0	9.2	1.09×10^{-1} ± 0.04	32.46 ± 0.15	3.081×10^{-2} ± 0.014
2	500.0	52.8	1.894×10^{-2} ± 0.018	175.6 ± 0.4	5.695×10^{-3} ± 0.013
3	500.0	109.4	9.141×10^{-3} ± 0.025	365.4 ± 0.7	2.737×10^{-3} ± 0.005
4	100.0	165.1	6.057×10^{-3} ± 0.011	550.0 ± 1.3	1.818×10^{-3} ± 0.004
5	100.0	220.4	4.537×10^{-3} ± 0.006	734.7 ± 1.8	1.3611×10^{-3} ± 0.0033
6	100.0	275.6	3.628×10^{-3} ± 0.004	913.3 ± 2.1	1.0949×10^{-3} ± 0.0025
7	100.0	330.2	3.0285×10^{-3} ± 0.0028	1096.5 ± 2.4	9.120×10^{-4} ± 0.020
8	100.0	443.0	2.2573×10^{-3} ± 0.0015	1468.3 ± 3.3	6.811×10^{-4} ± 0.015
9	100.0	555.9	1.7989×10^{-3} ± 0.0010	1835 ± 4	5.450×10^{-4} ± 0.012
10	100.0	669.7	1.4932×10^{-3} ± 0.0007	2208 ± 4	4.529×10^{-4} ± 0.008
11	100.0	889.6	1.1241×10^{-3} ± 0.0004	2924 ± 6	3.420×10^{-4} ± 0.007
12	100.0	1122.5	8.9087×10^{-4} ± 0.0024	3692 ± 6	2.709×10^{-4} ± 0.004
13	100.0	1661.4	6.0190×10^{-4} ± 0.0011	5408 ± 9	1.8491×10^{-4} ± 0.0031
14	100.0	2156.5	4.6371×10^{-4} ± 0.0006	6946 ± 14	1.4397×10^{-4} ± 0.0029

TABLE II-6 - Continued

Tube Number	Counting Interval (sec)	Tracer Solution Weight, w (mg) ± 0.3	$\frac{1}{w}$ (mg^{-1})	Corrected* Net Count Rate, n (sec^{-1})	$\frac{1}{n}$ (sec)
15	100.0	2654.2	3.7676×10^{-4} ± 0.0004	8535 ± 15	1.1716×10^{-4} ± 0.0021
16	100.0	2841.4	3.5194×10^{-4} ± 0.0004	9100 ± 15	1.0989×10^{-4} ± 0.0018
17	50.0	3825.6	2.61397×10^{-4} ± 0.00020	12088 ± 22	8.2731×10^{-5} ± 0.015
18	50.0	4003.5	2.49781×10^{-4} ± 0.00019	12605 ± 21	7.933×10^{-5} ± 0.013
19	50.0	4841.8	2.06535×10^{-4} ± 0.00013	15108 ± 29	6.619×10^{-5} ± 0.013
20	50.0	4985.8	2.00570×10^{-4} ± 0.00012	15504 ± 26	6.450×10^{-5} ± 0.011
21	50.0	6182.1	1.61757×10^{-4} ± 0.00008	18923 ± 32	5.285×10^{-5} ± 0.009
22	10.0	7285.1	1.37266×10^{-4} ± 0.00006	22020 ± 40	4.541×10^{-5} ± 0.008
23	10.0	8926.0	1.12032×10^{-4} ± 0.00004	28760 ± 60	3.477×10^{-5} ± 0.007
24	10.0	9913.3	1.008741×10^{-4} ± 0.000030	30210 ± 50	3.310×10^{-5} ± 0.005
25	10.0	11018.1	9.07598×10^{-5} ± 0.00025	33230 ± 60	3.009×10^{-5} ± 0.005
26	10.0	13320.7	7.50711×10^{-5} ± 0.00017	37540 ± 70	2.664×10^{-5} ± 0.005
27	10.0	15555.6	6.42855×10^{-5} ± 0.00012	42750 ± 80	2.339×10^{-5} ± 0.004

- NOTES: 1. Tracer count rates are the average of 15 measurements. Background count rates are the average of 10 measurements made on each individual tube.
2. Uncertainties quoted are 95% confidence intervals of the mean based on the counting statistics only.

* values of net count rate (background subtracted) corrected for individual tube calibrations

Figure 2-9

Response curve for Baird-Atomic
NaI(Tl) crystal and gamma counter.

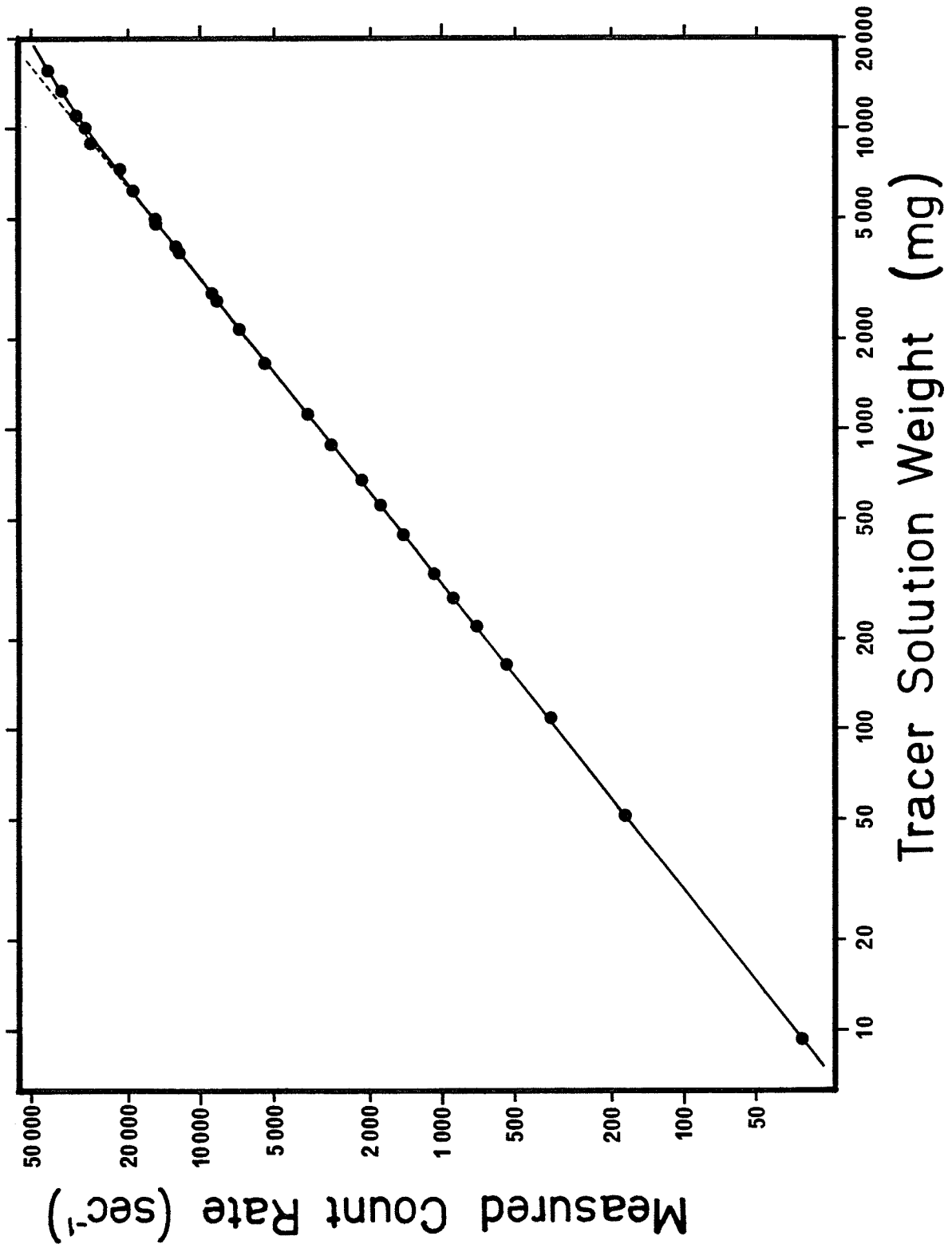

2. Time Dependence of Cobalt Sorption from Aqueous Thiocyanate Solutions by Polyurethane Foam

To establish at what rate cobalt could be removed from aqueous thiocyanate solutions by polyurethane foam and to ascertain approximately what length of time would be sufficient to attain equilibrium in later work, an experiment was devised to measure the time dependence of cobalt sorption under typical conditions.

In planning the experiment, it was intended to prevent as many other factors as possible from adding to the effects of time on the measured sorption. The desired experimental solution conditions are listed at the top of Table II-7. In order to eliminate possible differences arising from solution preparation, a single 1.00 liter stock solution containing each of the necessary ingredients in the appropriate amounts (0.10 ppm Co^{2+} , 0.10 M NaSCN, 1.90 M NaCl, 1.00 M sodium acetate/ acetic acid buffer and sufficient ^{60}Co tracer to give about 700 seconds⁻¹ initial activity) was prepared from individual stock solutions or by weighing in the case of NaCl. Aliquots of 150.0 mL of this solution were withdrawn for use in each experiment.

Distribution cells containing 50 mg #1338 BFG foam pieces were assembled as outlined in the General Procedure with double condom seals to protect against evaporation.

Considerable advantage was taken of the fact that the radiometric method of analysis is completely non-destructive and therefore makes feasible the use of a single distribution cell, foam and solution to provide an entire sorption profile with time. Thus, 15.0 mL samples could be removed quickly from the total 150.0 mL by pipet, counted for

one or more 100 second intervals and returned immediately without halting the equilibration of the remaining 135.0 mL of solution. Of course, the missing 15.0 mL would be unable to participate in equilibration while removed but this was an unavoidable consequence of the procedure and was judged to have a relatively small effect on the result. Although one obtains a good approximation to the sorption time dependence of a single piece of foam within a particular distribution cell in this way, it was still considered desirable to repeat each experiment at least once in order to observe what influence such things as foam squeezing or mixing efficiency may have on the sorption rate.

Since it was feared that cumulative losses of solvent (during sampling and counting) and of solution (chiefly to the pipet and counting tube) could become significant over many sampling periods, steps were taken to reduce both. To retard losses of solvent during counting, the mouths of the counting tubes were covered with polyvinylchloride film at all times except when being filled or emptied. Losses of solution during sampling were reduced by not rinsing the counting tubes between successive samples (when they were taken very close together in time) so that only losses to the pipet walls occurred. The deleterious effect this procedure would have on the actual count rate measured was expected to be reasonably minor since the carryover between samples is not large (about 0.1 mL).

In spite of these precautions, it became apparent that two separate time studies - one over a short period of time and another over a long period - were needed since many small cumulative losses in early sampling could have a bearing on long-term results. Thus, two pairs of distribu-

tion cells were set up. Samples were withdrawn frequently during the first hour of equilibration from the first pair of cells and continued very infrequently up to 18 hours (Experiments 1A and 1B). On the other hand, no samples at all were removed from the second pair during the first hour but sampling continued regularly thereafter for 48 hours (Experiments 2A and 2B). No periodic standardization of the spectrometer was carried out so no corrections for drift could be applied to the data.

During the course of the experiment, all foam pieces were observed to acquire a faint green colouration with only a few minutes of squeezing. This colour darkened slowly to a pale green with additional time.

The results obtained from these investigations are collected in Table II-7 which shows the time of contact between solution and foam before a particular sample was withdrawn, the number of 100 second counting periods made in each case (as dictated, usually, by the amount of time available between successive samples taken), the percentage of cobalt extracted and the calculated distribution ratio.

The data for the first pair of experiments (1A and 1B), showing the short-term equilibration of cobalt with foam, are displayed graphically in Figure 2-10. From this, it will be seen that equilibrium is approached fairly slowly and evidently is not sensibly achieved until well beyond two hours has elapsed. Part of this apparent slowness is attributable simply to the small size of foam pieces used. Since 50 mg of foam represents only about 2 cm³ and the apparatus operates at 25 squeezes per minute, it would require at least 3 minutes (assuming completely fresh solution were drawn in on each return to normal size) for the foam to contact all of the solution once. In practice, of course, a somewhat

TABLE II-7 TIME DEPENDENCE OF COBALT SORPTION BY POLYURETHANE FOAM

Initial Conditions:

[Co] 1.7 x 10⁻⁶ M (0.10 ppm)
 [SCN] 0.10 M (NaSCN)
 Ionic Strength (I) 3.00 M (NaCl)
 pH 4.8 (1.0 M Na acetate buffer)
 Solution Volume (V) 150.0 mL
 Foam Weight (W) 0.050 grams
 Type #1338 BFG
 Temperature 25.00°C

Experiment IA

W 50.73 mg

Sample Number	Contact time (min) ±0.3	Contact time (hours) ±0.005	Number of Measurements Made	Cobalt Extracted (%)	D (L kg ⁻¹)
1	0.0	0.000	10	0	0
2	3.0	0.050	1	14 ±4	480 ±120
3	7.0	0.117	1	24 ±4	940 ±140
4	12.0	0.200	2	34 ±4	1500 ±200
5	18.0	0.300	3	40.6 ±1.5	2020 ±90
6	25.0	0.417	4	45.6 ±0.4	2483 ±26
7	35.0	0.583	5	50.4 ±0.4	2999 ±30
8	50.0	0.833	5	53.81 ±0.30	3444 ±29
9	70.0	1.107	5	56.7 ±0.4	3880 ±50
10	110.0	1.833	5	58.8 ±0.4	4220 ±50
11	1080.0	18.000	10	60.96 ±0.20	4566 ±27

Experiment IB

W 50.95 mg

Sample Number	Contact Time (min) ±0.3	Time (hours) ±0.005	Number of Measurements Made	Cobalt Extracted (%)	D (L kg ⁻¹)
1	0.0	0.000	10	0	0
2	3.0	0.050	1	13 ±4	450 ±120
3	7.0	0.117	1	23.8 ±3.4	920 ±140
4	12.0	0.200	2	33.2 ±2.9	1470 ±140
5	18.0	0.300	3	41.0 ±0.4	2044 ±26
6	25.0	0.417	4	46.5 ±0.4	2557 ±27
7	35.0	0.583	5	51.10 ±0.19	3076 ±16
8	50.0	0.833	5	54.90 ±0.21	3584 ±22
9	70.0	1.167	5	57.7 ±0.5	4010 ±60
10	110.0	1.833	5	59.59 ±0.18	4341 ±24
11	1080.0	18.000	10	61.12 ±0.24	4629 ±33

Experiment IIA

W 51.11 mg

Sample Number	Contact Time (hours) ±0.01	Number of Measurements Made	Cobalt Extracted (%)	D (L kg ⁻¹)
1	0.00	10	0	0
2	1.00	10	55.65 ±0.21	3682 ±22
3	2.00	10	58.53 ±0.27	4141 ±33
4	3.00	10	59.55 ±0.12	4320 ±15

Experiment IIA - continued

Sample Number	Contact Time (hours) ±0.01	Number of Measurements Made	Cobalt Extracted (%)	D (L kg ⁻¹)
5	4.00	10	59.76 ±0.15	4359 ±20
6	5.00	10	60.03 ±0.18	4407 ±24
7	6.00	10	60.00 ±0.20	4402 ±27
8	9.00	10	60.06 ±0.16	4412 ±21
9	12.00	10	59.97 ±0.18	4396 ±24
10	24.00	10	60.40 ±0.24	4476 ±32
11	36.00	10	60.45 ±0.14	4485 ±19
12	48.00	10	60.66 ±0.22	4524 ±29

Experiment IIB

W 50.91

Sample Number	Contact Time (hours) ±0.01	Number of Measurements Made	Cobalt Extracted (%)	D (L kg ⁻¹)
1	0.00	10	0	0
2	1.00	10	54.31 ±0.20	3502 ±20
3	2.00	10	56.84 ±0.22	3880 ±24
4	3.00	10	57.87 ±0.19	4047 ±23
5	4.00	10	58.61 ±0.21	4173 ±25
6	5.00	10	58.97 ±0.21	4235 ±27
7	6.00	10	59.15 ±0.19	4266 ±24

Experiment IIB - continued

Sample Number	Contact Time (hours) ± 0.01	Number of Measurements Made	Cobalt Extracted (%)	D (L kg ⁻¹)
8	9.00	10	59.42 ± 0.26	4315 ± 33
9	12.00	10	59.76 ± 0.24	4376 ± 32
10	24.00	10	60.34 ± 0.19	4483 ± 26
11	36.00	10	60.57 ± 0.21	4526 ± 29
12	48.00	10	60.62 ± 0.18	4536 ± 24

Note: Errors quoted are generally 95% confidence intervals based on the uncertainties measured through repetitive radioactive counting. Where only one measurement was possible, a rough estimate of the uncertainty has been calculated based on the square root of the counting rate.

Figure 2-10

Short-term time dependence of cobalt sorption from 150.0 mL of thiocyanate solution by 0.050 gram pieces of #1338 BFG polyurethane foam as measured in two separate experiments, A and B.

The initial solution conditions were as follows:

1.7 x 10⁻⁶ M (0.10 ppm) Co(II)

0.10 M NaSCN

1.90 M NaCl

1.00 M NaOOCCH₃/HOOCCH₃ buffer, pH 4.7

3.00 M total ionic strength

25.00°C

NOTE: This and all succeeding graphs in this chapter are plotted accurately with respect to D but approximately with respect to % Co Extracted. The latter scale will be accurate also for a foam weight of exactly 50.00 mg.

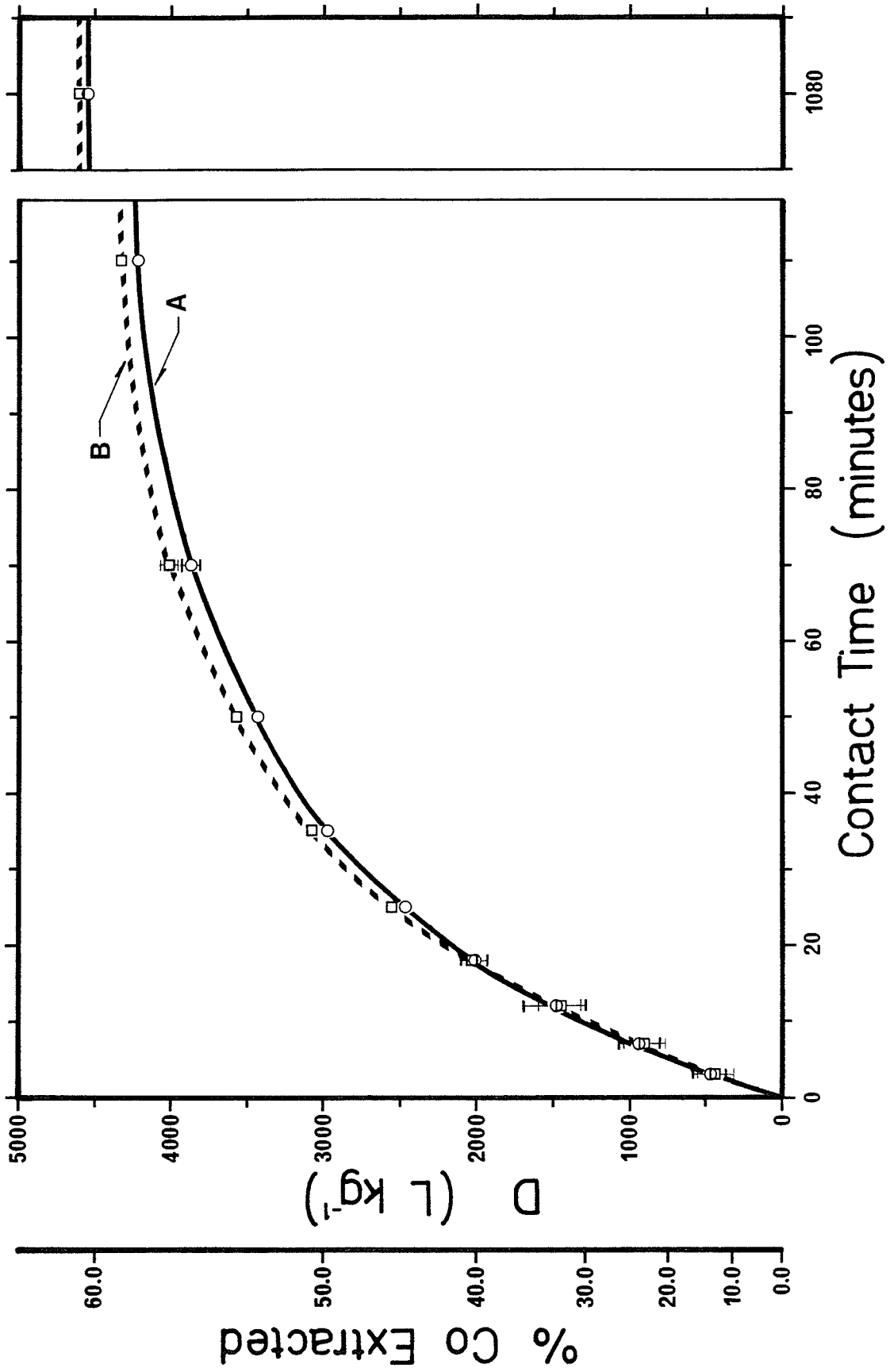
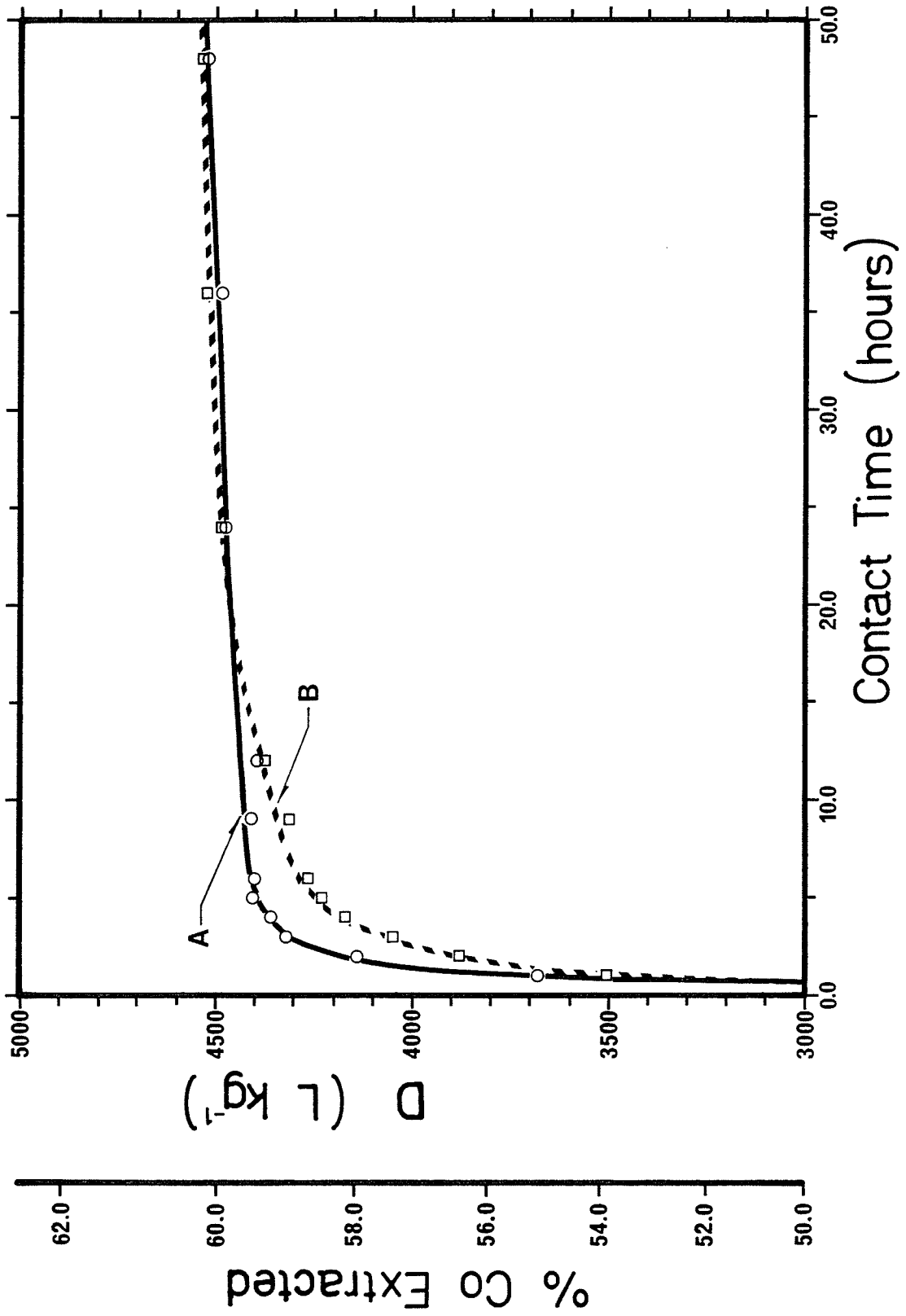

Figure 2-11

Long-term time dependence of cobalt sorption
from 150.0 mL of thiocyanate solution by 0.050
gram pieces of #1338 polyurethane foam as
measured in two separate experiments, A and B.

The initial solution conditions were as follows:

- 1.7 x 10⁻⁶ M (0.10 ppm) Co(II)
- 0.10 M NaSCN
- 1.90 M NaCl
- 1.00 M NaOOCCH₃/HOOCCH₃ buffer, pH 4.7
- 3.00 M total ionic strength
- 25.00°C



longer time is actually required since entirely fresh solution is not expected in the vicinity of the foam.

A further observation to be made in Figure 2-10 is that the two experiments, A and B, show very similar sorption rates throughout and differ from one another by only about 1.4% after 1080 minutes (18 hours). This would tend to indicate that both distribution cells used were nearly identical in mixing and squeezing characteristics.

The data for the second pair of experiments (2A and 2B) showing the long-term equilibration of cobalt with foam are displayed graphically in Figure 2-11. In this, the discrepancies between rates of equilibrium attainment in individual distribution cells will be more apparent. Here, differences in D up to about 6% existed between A and B for the first 9 hours but diminished to less than 0.2% after 24 hours. The results obtained here proved to be illustrative of nearly the largest possible difference between two cells in attainment of equilibrium as judged from many observations made at 6, 12 and 24 hours in later experiments.

Another feature of note in Figure 2-11 is the fact that even after 24 hours, sorption of additional cobalt apparently takes place but at a very slow rate to increase D by about 2.7% over 48 hours. This could conceivably represent a slow diffusion of material into the distant bulk of the polymer or even conformational changes in its structure to accommodate more metal ions. However, as will be demonstrated later, a loss of solvent (water) of as little as 1.0 mL (out of 150 mL) is sufficient to account for the entire increase observed owing to the resulting increases in both $[\text{SCN}^-]$ and solution ionic strength. A total loss of approximately 4 mL was actually measured at the end of 48 hours.

This amount is considerably greater than would be expected from losses of solution resulting from removing and returning samples alone and thus tends to suggest that a part of this loss likely results from evaporation through small leaks in cell joints and seals. Thus, to avoid at least a part of this problem while at the same time allowing sufficient time to compensate for differences in distribution cell or foam performance, an equilibrium time of 24 hours was adopted as standard in most later experiments.

From an analytical usage standpoint, such long equilibration times are neither desirable nor necessary. In this experiment, conditions have been deliberately chosen (0.050 gram foam, 150.0 mL solution, 0.10 M SCN^- , 25.00°C) so that only a moderate percentage extraction (about 60%) results. Even so, approximately 80% of the total cobalt sorption is complete after only 1 hour of squeezing while about 90% had taken place after 2 hours. Under more optimum conditions (0.4 gram foam, 100 mL solution, 1.0 M SCN^- , 22°C), in which perhaps 99.99% of cobalt is removed from solution at equilibrium, the time to reach 90% extraction was found in preliminary experiments to be less than 2 minutes. Thus, although equilibration times may appear to be prohibitively long and percentages of extraction not spectacularly large, these limitations are completely self-imposed only so that more information can be obtained from the results and should not discourage the analyst from applying the foam sorption method to such things as column chromatography, batch extractions, radioactive cleanup, preconcentration prior to qualitative or quantitative analysis or other similar uses. More will be said about this later.

3. Effect of Solution pH on Cobalt Sorption from Aqueous Thiocyanate Solutions

To determine over what range of pH the sorption of cobalt from thiocyanate solutions by polyurethane foam was optimum, an experiment was designed to span the pH range from less than 0 up to 14.

In planning the experiment, account was taken of some preliminary investigations using buffers to fix the pH which appeared to show optimum performance from about pH 2 to 8 but with rather poor reproducibility. Since it was felt that the buffers were at least partly to blame for this, it was decided to attempt the experiment once more in the absence of buffers in order to avoid the possible interferences while hoping that large-scale drift in pH would not occur during the equilibration period.

The desired initial solution conditions for the experiment are listed at the top of Table II-8. Necessary solutions were prepared individually in 150 mL volumetric flasks to contain 1.10 ppm Co^{2+} , 0.10 M NaSCN, a total ionic strength of 3.00 M and sufficient ^{60}Co tracer to yield an initial count rate near 700 seconds⁻¹ while spanning the entire pH range from less than 0 out to 14. To accomplish this, calculations were first made of the volume of 12 M HCl, 1 M HCl, 0.1 M HCl, 10 M NaOH, 1 M NaOH, or 0.1 M NaOH which might be required to reach each desired pH making some allowances for the buffering abilities of the other constituents to be added. An amount of sodium chloride calculated in each case to give a total solution ionic strength of 3.00 M was then weighed into each 150 mL volumetric flask followed by pipetted aliquots of NaSCN, Co^{2+} , and ^{60}Co tracer to give their desired concentrations.

After mixing to dissolve the NaCl, the calculated quantity of acid or base was next added by buret or pipet with continual mixing, the flask diluted almost to the mark and the solution left to equilibrate overnight as outlined in the General Procedure.

Distribution cells containing weighed 50 mg #1338 BFG foam pieces were assembled as usual with double condom seals to retard evaporation and with a light silicone grease film on the plunger stems to catch broken foam bits. However, the cells were removed from the squeezing apparatus and partially disassembled just prior to use so that the contents of the volumetric flask could be poured directly into the cell bottom. The initial solution pH was then measured in this container by means of glass and calomel electrodes calibrated against buffers spanning the range from 1.67 to 10.0. A 15 mL aliquot of the solution was also withdrawn for counting at this time and was returned to the cell bottom when completed. The cell was then reassembled and installed in the thermostatted cabinet to begin equilibration at 25.00°C with periodic sampling after 6, 12 and 24 hours in the usual manner. Corrections to the measured count rate to allow for spectrometer drift over this time were not made in this experiment, however. At the completion, the final solution pH was again measured directly in the cell bottom to determine what change had occurred. This final or equilibrium pH was used in all later calculations. Adjustments were made to each value of pH recorded to correct for the sodium ion error of the glass electrode as determined in a separate experiment.

Several interesting observations were made during the course of the investigation. First, it was noted that many of those foams which were

in contact with somewhat acidic solutions (pH less than 4 but not greater than 0.5 M acid) developed colours ranging from pale red to deep red-brown on squeezing while most others adopted the usual pale green colour assumed to be associated with the sorbed cobalt species. At acid strengths higher than 0.5 M, the red colour was seen to be superceded by a very pale green colour once more which also disappeared at the highest acid strengths (2 to 3 M). Moreover, the intensities of the reddish colours did not seem to parallel the strength of acid in solution in each case and so was attributed to the presence of another substance existing as a contaminant in solution rather than to the hydrogen ion. A very likely candidate for the contaminant is iron(III) which is known⁽²²²⁾ to form ether-extractable thiocyanato complexes in mildly acidic media and has also been reported to be extracted by polyurethane foam^(50, 51). Separate experiments with foam squeezed briefly with various combinations of NaSCN, HCl, NaCl and FeCl₃ showed that reddish colours developed on foam only when the solution contained NaSCN, HCl and iron from some source. The chief source of iron in the experiment was found to be the NaCl used (reported to contain 0.4 ppm Fe) but it was inhomogeneously distributed in the salt as tiny dark specks. On one occasion, no red colour developed at pH 3.8 evidently reflecting the fortuitous absence of these specks in the salt weighed out whereas solutions with pH values on either side of this developed the colour. No particular relationship appeared to exist between the measured extraction of cobalt and the appearance of red or brown colours on the foam. Evidently, the extractable iron thiocyanate species form over a comparatively narrow pH range and are easily displaced by the cobalt species under the conditions studied.

A second observation made during the experiment was that in strongly acid solutions (greater than 1 M HCl) a yellow colour developed fairly quickly in solution on mixing and was accompanied by the smell of H₂S. The most acidic of these solutions later developed a small amount of fine yellow precipitate on standing overnight. Furthermore, when sampled after 6, 12 and 24 hours of contact with foam, it was found that some ⁶⁰Co originally sorbed was slowly being returned to solution as time passed (in contrast to sorptions at higher pH which show small continual increases instead). All of these observations were taken to indicate that some steady decomposition of SCN⁻ was occurring in the presence of strong acid. This is consistent with the known unstable behaviour of HNCS⁽¹⁷⁶⁾ which in acid solution can undergo either hydrolysis to give hydrogen cyanide, carbon dioxide and ammonium ion:

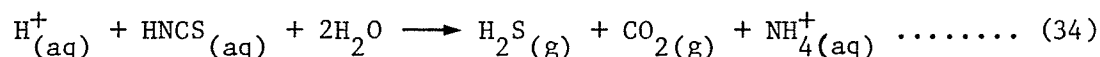

or polymerization if more concentrated to give hydrogen cyanide and isoperthiocyanic acid (a yellow solution or solid):

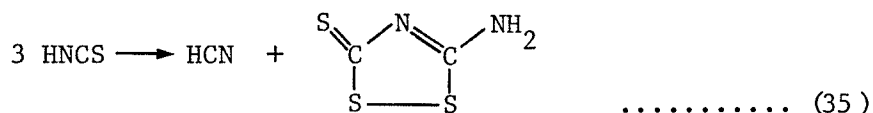

Another phenomenon noted while performing the experiment occurred with some moderately to strongly basic (pH greater than 11) solutions. In most, but not all of these cases, repetitive counting of the samples taken after contact with foam yielded slightly increasing numbers over

the ten measurements made and this was taken to be indicative of a ⁶⁰Co-containing precipitate settling toward the detector on standing. The precipitate was assumed most likely to be cobalt hydroxide Co(OH)₂ formed as follows:

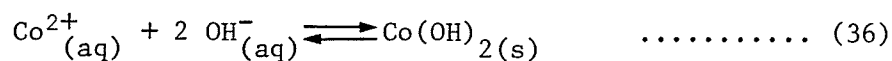

$$K_{\text{sp}} = 2 \times 10^{-16} (223)$$

Interestingly, the precipitate did not become at all apparent until after contact with the squeezing apparatus containing foam. Furthermore, there was not a hard and fast relationship between increasing solution pH and the appearance of precipitate for any but the most strongly basic solutions. The differences noted likely reflect slight variation in nucleation conditions experienced while the precipitate was forming or "digesting" in the squeezing apparatus thus regulating the size and settling rates of particles formed. Whatever the cause, this problem necessitated the mixing of solution in the counting tubes between each measurement in some cases in order to try to keep the precipitate uniformly suspended. Since this was not possible during the individual 100 second counting periods themselves, some modest error will have resulted. In addition, the possibility of depositing some of the precipitate formed on the cell walls, plunger stem or foam must also be considered since all ⁶⁰Co disappearing from solution was taken to be sorbed by the foam piece.

The results of the experiment are collected in Table II-8 and are displayed graphically in Figure 2-12 as the dependence of log D on the

TABLE II-8 EFFECT OF SOLUTION pH ON COBALT EXTRACTION

Initial Conditions:

[SCN⁻] 0.100 M (NaSCN) Foam Weight (W) 0.050 grams
 [Co] 1.7 x 10⁻⁶ M (0.10 ppm) Type #1338 BFG
 Ionic Strength (I) 3.00 M (NaCl) Squeezing Time 24.0 hours
 pH -0.5 to 13.6 (no buffers) Temperature 25.00°C
 Solution Volume (V) 150.0 mL

Sample Number	Measured pH		Calculated		Foam Weight (mg) ±0.01	Cobalt Extracted (%)	D (L kg ⁻¹)	log D
	Initial ±0.01	Final ±0.01	[H ⁺] (M)	pH ±0.01				
1	-	-	2.9	-0.46	50.31	11.6 ±0.4	3.92 ±0.14 x 10 ²	2.593 ±0.016
2	-	-	2.5	-0.40	49.18	19.7 ±0.4	7.49 ±0.14 x 10 ²	2.875 ±0.008
3	-	-	2.0	-0.30	50.37	27.92 ±0.34	1.154 ±0.015 x 10 ³	3.062 ±0.006
4	-	-	1.5	-0.18	49.79	39.2 ±0.4	1.946 ±0.025 x 10 ³	3.289 ±0.006
5	0.00	0.02	1.0	0.00	50.53	54.6 ±0.4	3.57 ±0.04 x 10 ³	3.552 ±0.004
6	0.08	0.12	0.80	0.10	50.01	61.7 ±0.4	4.82 ±0.06 x 10 ³	3.684 ±0.005
7	0.27	0.28	0.48	0.32	49.14	73.6 ±0.4	8.50 ±0.14 x 10 ³	3.929 ±0.007
8	0.59	0.61	0.24	0.62	50.20	83.6 ±0.6	1.52 ±0.05 x 10 ⁴	4.183 ±0.015
9	1.11	1.15	0.089	1.05	50.32	88.1 ±0.5	2.18 ±0.09 x 10 ⁴	4.338 ±0.017

TABLE II-8-- continued

Sample Number	Measured pH		Calculated		Foam Weight (mg) ± 0.01	Cobalt Extracted (%)	D (L kg ⁻¹)	log D
	Initial ± 0.01	Final ± 0.01	[H ⁺] (M)	pH ± 0.01				
10	1.16	1.18	0.080	1.10	48.82	88.2 ± 0.4	2.29 $\times 10^4$ ± 0.08	4.360 ± 0.014
11	2.30	2.35	-	-	50.29	88.69 ± 0.30	2.34 $\times 10^4$ ± 0.06	4.369 ± 0.012
12	2.35	2.42	-	-	49.98	88.4 ± 0.5	2.30 $\times 10^4$ ± 0.10	4.361 ± 0.019
13	2.50	2.53	-	-	48.39	87.7 ± 0.5	2.20 $\times 10^4$ ± 0.08	4.343 ± 0.016
14	3.70	3.77	-	-	49.52	87.1 ± 0.4	2.04 $\times 10^4$ ± 0.06	4.310 ± 0.012
15	3.73	3.81	-	-	50.11	87.7 ± 0.4	2.13 $\times 10^4$ ± 0.06	4.328 ± 0.012
16	5.51	5.48	-	-	49.12	86.4 ± 0.4	1.94 $\times 10^4$ ± 0.06	4.288 ± 0.014
17	5.77	5.76	-	-	50.02	87.4 ± 0.5	2.08 $\times 10^4$ ± 0.09	4.318 ± 0.019
18	5.77	5.77	-	-	49.88	87.1 ± 0.4	2.03 $\times 10^4$ ± 0.06	4.307 ± 0.012
19	5.82	5.83	-	-	49.86	86.47 ± 0.34	1.92 $\times 10^4$ ± 0.05	4.284 ± 0.011
20	5.83	5.84	-	-	49.00	87.9 ± 0.4	2.22 $\times 10^4$ ± 0.07	4.346 ± 0.014
21	5.88	5.88	-	-	48.98	88.4 ± 0.5	2.35 $\times 10^4$ ± 0.10	4.370 ± 0.018

TABLE II-8 - continued

Sample Number	Measured pH		Calculated		Foam Weight (mg) ± 0.01	Cobalt Extracted (%)	D (L kg ⁻¹)	log D
	Initial ± 0.01	Final ± 0.01	[H ⁺] (M)	pH ± 0.01				
22	5.99	5.95	-	-	48.69	86.6 ± 0.5	1.98 $\times 10^4$ ± 0.07	4.297 ± 0.016
23	6.08	5.98	-	-	50.39	83.3 ± 0.4	1.49 $\times 10^4$ ± 0.04	4.173 ± 0.010
24	9.85	7.76	-	-	49.26	85.6 ± 0.5	1.81 $\times 10^4$ ± 0.06	4.257 ± 0.015
25	10.62	9.14	-	-	50.33	83.8 ± 0.6	1.55 $\times 10^4$ ± 0.06	4.190 ± 0.016
26	10.93	10.10	-	-	49.84	69.2 ± 0.4	6.77 $\times 10^3$ ± 0.10	3.830 ± 0.006
27	11.13	10.48	-	-	49.66	78.5 ± 0.5	1.103 $\times 10^4$ ± 0.026	4.042 ± 0.010
28	11.29	10.61	-	-	50.00	62.8 ± 0.4	5.06 $\times 10^3$ ± 0.06	3.704 ± 0.005
29	11.86	11.65	-	-	50.32	45.69 ± 0.33	2.508 $\times 10^3$ ± 0.023	3.399 ± 0.004
30	12.01	11.92	-	-	50.68	54.3 ± 0.5	3.52 $\times 10^3$ ± 0.05	3.546 ± 0.006
31	12.20	12.10	-	-	50.34	27.4 ± 0.5	1.124 $\times 10^3$ ± 0.021	3.051 ± 0.008
32	12.15	12.11	-	-	50.38	32.3 ± 0.6	1.421 $\times 10^3$ ± 0.027	3.152 ± 0.008
33	13.12	13.07	-	-	50.38	35.7 ± 0.6	1.655 $\times 10^3$ ± 0.030	3.219 ± 0.008

TABLE II-8 - continued

Sample Number	Measured pH		Calculated		Foam Weight (mg) ± 0.01	Cobalt Extracted (%)	D (L kg ⁻¹)	log D
	Initial ± 0.01	Final ± 0.01	[H ⁺] (M)	pH ± 0.01				
34	13.29	13.13	-	-	50.04	27.0 ± 0.4	1.107 $\times 10^3$ ± 0.019	3.044 ± 0.008
35	13.38	13.25	-	-	49.85	20.3 ± 0.7	7.65 $\times 10^2$ ± 0.26	2.884 ± 0.015
36	13.53	13.40	-	-	50.98	14.2 ± 0.6	4.86 $\times 10^2$ ± 0.22	2.686 ± 0.019
37	13.69	13.60	-	-	49.33	10.9 ± 0.4	3.73 $\times 10^2$ ± 0.13	2.571 ± 0.015

Figure 2-12

Effect of pH on cobalt sorption from 150.0 mL of aqueous thiocyanate solution by 0.050 gram pieces of #1338 BFG polyurethane foam. Equilibrium values of pH were measured by glass electrode (open circles, O) or estimated by calculation (filled circles, ●).

Initial solution conditions were as follows:

1.7 x 10⁻⁶ M (0.10 ppm) Co(II)

0.10 M NaSCN

pH adjustments made by HCl or NaOH addition

3.00 M total ionic strength (maintained by NaCl)

25.00°C

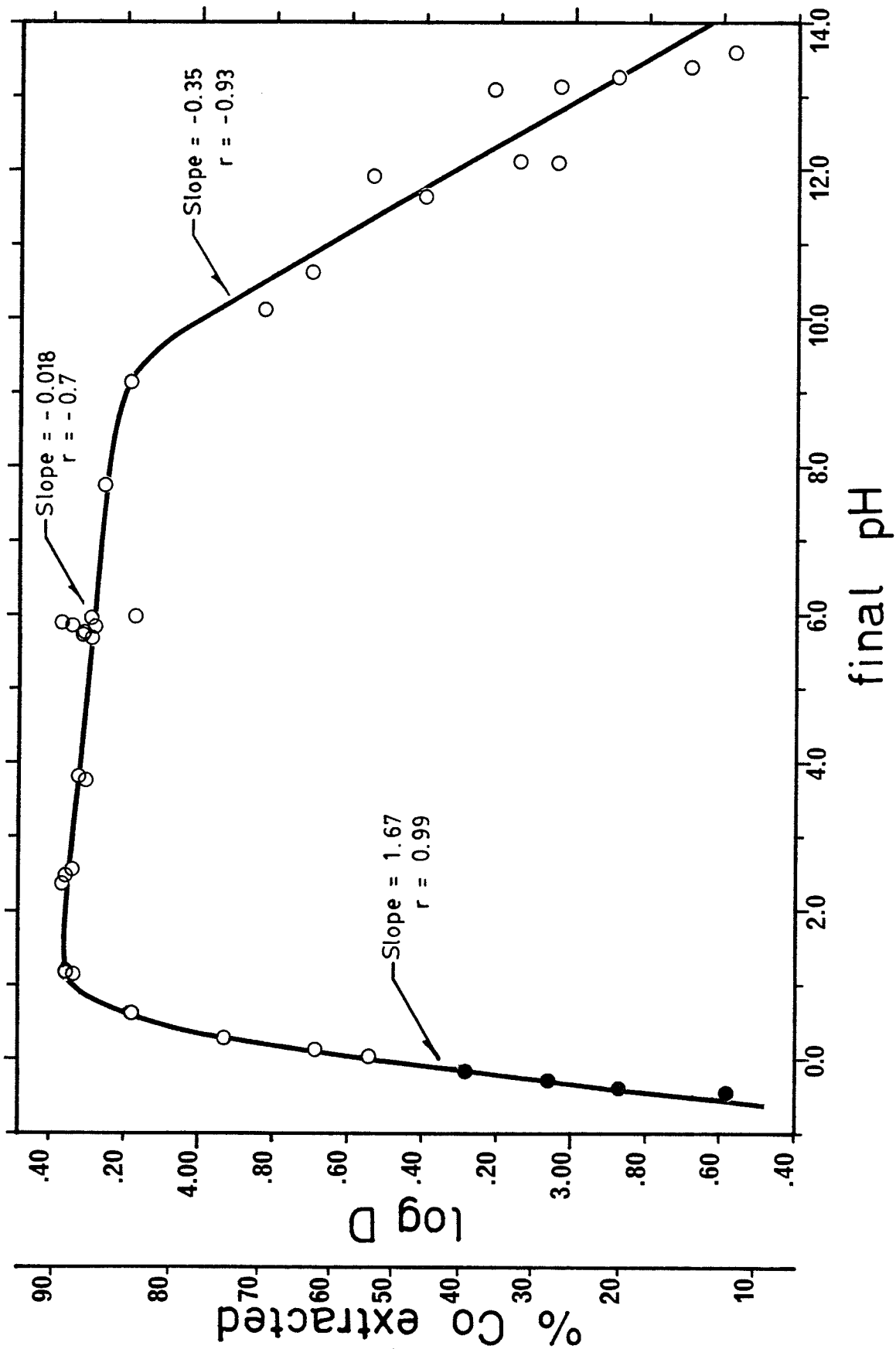

final measured solution pH.

From the Table, we see that a comparison between the solution pH as measured by glass electrode with that calculated simply from the amount of acid added shows reasonably good agreement particularly at the more acid end. In plotting the data in Figure 2-12, the final measured pH has been used down to pH = 0 (data plotted with open circles) since it best represents the equilibrium condition but it was necessary to use calculated values (plotted as filled circles) below this where the glass electrode response is expected to be unreliable.

From a comparison of the pH values measured before and after the experiment (Table II-8), it can be seen that very minor changes usually occurred over the 24 hour period especially in acidic solutions. This was less true when the initial pH fell in the range from approximately 7 to 11.5 where changes as large as 2 units were suffered. The sensitivity in this region was not unexpected, of course, since very small hydrogen ion concentration changes here produce quite large pH alterations and the buffering capacity of the HSCN/SCN^- system is only active at low pH. Nearly always, any drift in pH which occurred was in a direction toward a value of about 5.8, that of the solution with neither HCl nor NaOH added to it (sample #19, Table II-8). The changes in pH which were observed may have arisen from a number of physical and chemical processes including volatilization or foam sorption of HCl and/or HSCN, HSCN decomposition and H_2S evolution, $\text{Co}(\text{OH})_{2(s)}$ formation, CO_2 sorption from air or possibly desorption of traces of HCl remaining on foam from the washing procedure. This last possibility is of some interest from a mechanistic point of view and will be discussed more fully later.

From Figure 2-12 we see that the sorption of cobalt from thiocyanate solution is quite insensitive to pH over a wide range extending from less than 1 to greater than 9 but drops off fairly rapidly at lower values and less rapidly at higher ones. This lack of sensitivity to hydrogen ion concentration under conditions of optimum extraction is important in formulating a mechanism for the process and we will consider it again later.

It is apparent from Figure 2-12 that concentrations of hydrogen ion in excess of about 0.1 M begin to have deleterious effects on cobalt sorption. This is readily understood in terms of the acid dissociation behaviour of the semi-strong thiocyanic acid:

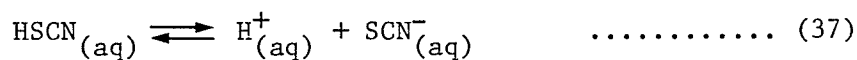

$$\text{pKa} \approx -2.0 \text{ to } -2.3^{(224)}$$

The reverse of equation (37) would occur in reasonably acidic solutions and would deprive cobalt of the thiocyanate ligand necessary for extraction. In addition, as already noted, the HSCN formed is known to be unstable and its decomposition further shifts equilibrium to consume more SCN^- thus resulting in the observed additional decreases in cobalt extraction with time. This problem of decomposition was visibly most pronounced in the strongest acid solution (2.9 M HCl) and it can be seen that the distribution ratio, D, for this solution falls noticeably below the value expected by extrapolation from the other data.

On the alkaline side of Figure 2-12, it will be noted that sorption of cobalt drops gradually as the pH is increased but that a great deal

more scatter occurs here than in any other portion of the graph. As already suggested, the largely insoluble hydroxide of cobalt, $\text{Co}(\text{OH})_2$, is expected to form in basic solution thus interfering with the formation of the foam-extractable thiocyanate species. The high degree of scatter exhibited by the data undoubtedly results partly from the problems associated with counting of a settling radioactive precipitate. In addition, since the precipitate may be removed from solution by depositing on the glass walls, coprecipitating with variable amounts of iron present, lodging in the silicone grease used to scavenge foam bits or simply by being physically filtered by the polyurethane foam piece, a number of false "sorptions" can occur. For these reasons, the data at this end of the graph are much less reliable than elsewhere but nevertheless demonstrate the trend to decreasing sorption with increasing pH.

As a result of the experiment on the effect of pH on cobalt sorption, most later experiments were fixed in the middle of the optimum range by use of a 1:1 sodium acetate/acetic acid buffer (pH = 4.8).

There are a number of inferences which can be made from the data regarding possible mechanisms for the phenomenon. For example, it has been proposed by others⁽²²⁵⁾ that the observed sorption of cobalt may require the protonation of sites in the polyurethane and the foam washing procedure (which uses 1 M HCl) was suggested as a source of the hydrogen ions even when cobalt sorption was achieved from mildly basic solutions. If one assumes that some hydrogen (or hydronium) ions are, in fact contained within the foam to form weak base anion exchange sites, then by analogy with weak base anion exchangers, they should likely be removed by prolonged contact (24 hours) with basic aqueous solutions of some pH less

than 14. The resulting change in solution pH allows calculation, then, of the number of hydrogen ions released to solution. When applied to the data of Table II-8, by far the largest apparent release of hydrogen ions is observed for Sample Number 23 which shows a total change of only 3.2×10^{-8} moles while still displaying optimum cobalt sorption. In addition, at the highest pHs (about 13.5) where we expect that displacement of any hydrogen ions from weak base foam sites must surely occur, apparent releases of H^+ to solution are only of the order of 10^{-15} moles (and most of this may actually be due to loss of OH^- by $Co(OH)_2$ formation). If these apparent releases of hydrogen ions were to have originated entirely from the foam, then the ions would have been originally present there at a concentration of only 6.5×10^{-4} m in one case and about 10^{-11} m in the other. Either of these values seems very small when compared to the 4.2×10^{-3} m and 1.5×10^{-3} m concentrations respectively of cobalt sorbed onto foam under these conditions. Also, as we shall see later, even the largest amount of hydrogen ions is far too little (by about 1400-fold) to account for the measured capacity of foam for cobalt sorption and so prior protonation of foam during its pretreatment should logically be ruled out as a possible mechanism.

We pointed out earlier the insensitivity of cobalt sorption to solution pH over a wide range extending from less than 1 to greater than 9 which is shown in Figure 2-12. This lack of sensitivity to hydrogen ion concentration under conditions of optimum extraction indicates either that the hydrogen ion is present or available in vast excess, or that it is not involved in the extractable species nor in forming weak base anion exchange sites on the foam by protonation.

Let us take the first of these possibilities into consideration and suppose, therefore, that the extractable species is of the general formula $H_x Co_y (SCN)_z$. Cobalt is initially present in solution at a concentration of 1.7×10^{-6} M so that hydrogen ions must be furnished in this or some multiple, x, of this amount. Sufficient water is obviously available to do so by simple dissociation:

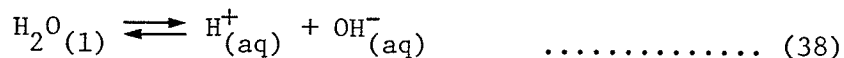

$$K_w \approx 10^{-14} \text{ mol}^2 \text{ L}^{-2} \text{ (229)}$$

but formation of $H_x Co_y (SCN)_z$ in pH = 9 solution requires that about 10^{-6} M $Co_y (SCN)_z^{x-}$ compete effectively with 10^{-5} M $OH^-_{(aq)}$ for available hydrogen ions. For this to happen, $Co_y (SCN)_z^{x-}$ would have to be a very strong base and the species $H_x Co_y (SCN)_z$ should therefore be well known, characterized and probably isolated. This is not the case, however, and no compounds of this type have ever been reported which would fit these criteria. Thus, it would seem much more likely that under the conditions of the experiment hydrogen ions are not at all involved in any species sorbed by a solvent extraction-like mechanism.

On the other hand, if the extraction is taking place instead at protonated foam sites by a weak base anion exchange type of mechanism, then the maximum number of sites must be protonated under all conditions in which optimum extraction is observed (otherwise D would decrease proportionally as the number of sites was decreased). Later, we shall demonstrate from capacity measurements that the maximum concentration of sites on the foam must be just under 1 mol kg^{-1} under conditions nearly

identical to those used in this experiment. Thus, since D does not decrease appreciably below pH = 9, we are certain that any weak base foam sites must still be protonated under these conditions. Furthermore, since we did not observe the release of any appreciable hydrogen ions to solution all the way up to pH = 13.5, the sites must also be fully protonated under these conditions as well. Hence, at the very most, $10^{-13.5}$ M hydrogen ions in solution are in equilibrium with 1 m hydrogen ion present in foam. The equilibrium, $(\text{hydrogen ion})_{\text{aq}} \rightleftharpoons (\text{hydrogen ion})_{\text{f}}$ thus has an equilibrium constant of greater than $10^{13.5}$ L kg⁻¹. This indicates that the protonated sites, if they exist, must be extremely stable (especially considering how stable hydrogen ions in aqueous solution are already) so the term "weak base anion exchange" is inappropriate and should really be replaced by "strong base anion exchange" in describing the mechanism. Although we are not able to categorically rule out the formation of such sites as a remote possibility, there are no groups known to be present in polyurethane foam (especially at a concentration near 1 m) which would be sufficiently basic to accomplish this feat. The groups typical of polyurethanes (urea, urethane, allophanate and biuret) are not as basic as, for example, amines and these would not be nearly basic enough to account for the stability noted above. Ethers and esters are even weaker bases. On this basis, we conclude that formation of protonated anion exchange sites in the foam is extremely unlikely as a mechanistic possibility and we will exclude it from further consideration.

To complete the discussion of the mechanistic implications of the experimental results, we may note that the Cation Chelation Mechanism

(CCM) would be consistent with the very low dependence of extraction on pH since it proposes that cations other than H^+ (or H_3O^+) may precede or accompany the extractable species. It does not, however, rule out the possibility that H_3O^+ may become important as one of these cations when it is greatly abundant. In this experiment, Na^+ is available in amounts of 3.00 M at high pH and is replaced by equal amounts of H_3O^+ at low ones. We expect, therefore that if CCM is the correct mechanism, Na^+ will be the cation nearly always accompanying the cobalt-containing species whether before or concurrent with sorption of the latter. We are as yet unable to distinguish between these possibilities and are equally unable to distinguish these two from a solvent extraction-like mechanism which does not involve hydrogen ions.

From an analytical viewpoint, it is apparent that the use of thiocyanate solutions and polyurethane foam for the extraction and determination of cobalt or even for its separation from other metals would be equally applicable to matrices of widely differing pH. It will be noted, moreover, that even though both foam size and thiocyanate concentration have been deliberately kept low, nearly 90% of the cobalt is extracted without interference from iron present over the range from pH 1 to 9.

4. Effect of Thiocyanate Concentration on Cobalt Sorption From Solution By Polyurethane Foam

An experiment was devised to establish the dependence of cobalt sorption by foam on the concentration of thiocyanate, SCN^- , ion in aqueous solution.

Preliminary experiments to determine the dependence using NH_4SCN had shown that cobalt sorption was very sensitive to thiocyanate concentration up to about 0.5 M SCN^- but remained essentially unchanged with 1 M, 2 M, 3 M or 4 M SCN^- . However, these experiments were performed before an adequate temperature control mechanism was in place and so were repeated to improve the precision.

In formulating plans for the experiment, a range of thiocyanate concentrations extending from 0.01 M to 2.0 M was chosen since it represented approximately the lowest measurable (0.1%) and highest attainable (99.9%) cobalt extractions, respectively.

The initial solution conditions used in the experiment are shown at the top of Table II-9. Although a 1.00 M sodium acetate/acetic acid buffer was intended to be used, an error in the preparation of stock buffer concentrate gave a 0.88 M sodium acetate/1.00 M acetic acid mixture instead which shifted the solution pH marginally and lowered the ionic strength slightly for all solutions. The necessary solutions were prepared individually in 150 mL volumetric flasks to contain 0.10 ppm Co, 0.88 M NaOOCCH_3 /1.00 M HOOCCH_3 buffer, a variety of NaSCN concentrations, a total ionic strength of 2.88 M (adjusted by NaCl addition) and sufficient ^{60}Co tracer to give an initial count rate of about 1000 seconds⁻¹. The calculated amount of NaCl was weighed directly into the

flasks while all other reagents were delivered as aliquots of their stock solutions. Dilutions of the stock 5.0 M NaSCN to give 2.5 M and 0.25 M solutions were made to provide conveniently large aliquots of this reagent to be added in each case. After all necessary reagents had been transferred to the flasks, they were diluted to near the mark, mixed and left to equilibrate overnight as usual.

Distribution cells containing 50 mg #1338 BFG foam pieces were assembled and mounted in the 25.00°C thermostatted cabinet as described in the General Procedure. Samples were withdrawn for counting after 6, 12 and 24 hours after which most of the experiments were halted. One exception to this was Sample # 7 (0.5 M NaSCN) which was continued for an additional 6 hours since poor squeezing efficiency in that cell had failed to bring it to equilibrium after 24 hours. In addition, three other solutions #8 (0.75 M NaSCN), #9 (1.00 M NaSCN) and #10 (2.00 M NaSCN) were retained for reasons to be described later. Before discarding them, the volume of solution left in the remaining six cells was measured by squeezing the foam piece as dry as possible and transferring the solution back into the original wet 150.0 mL volumetric flasks. The volume of water which was required to bring them back to the mark was then measured and found to be 1.3 mL with a standard deviation of ± 0.19 mL. This deficit would represent the typical total losses incurred in removing samples for counting, in evaporation and in retrieving the solution from the distribution cell and foam for measurement. Most likely, the last of these constitutes about half of the total so losses of perhaps 0.2 mL or less are indicated for each sample taken.

As usual, values of the percentage of cobalt extracted and D were calculated. The results appear in Table II-9 and graphically in Figure 2-13. Since no periodic calibrations of the spectrometer sensitivity were made, no corrections for possible drift were applied to any of the data.

Some interesting observations were made during the experiment. First of all, it was noted that foam pieces in dilute thiocyanate solutions remained white on squeezing while those in more concentrated solutions eventually became pale green, appearing to parallel the measured sorptions of cobalt. However, the most concentrated solutions (0.5, 0.75, 1.00 and 2.00 M NaSCN) were all observed to turn a salmon colour after brief squeezing but this colour was slowly replaced by the green colouration over a period of 24 hours. As for the previous experiment, the salmon or reddish brown colour was identified with the presence of iron(III) as a contaminant present in solution originating probably from the NaCl or NaSCN used. The fact that the iron colouration develops quickly and then apparently fades with time indicates that it is rapidly sorbed and then is substantially replaced by the cobalt species or alters form (perhaps to an Fe(II) species) on the foam. It is not known which of these is definitely the case but evidently the cobalt thiocyanate species is largely unaffected by the iron and therefore must be retained much more strongly. Whatever the case, it was observed that when the foam piece containing cobalt and presumably iron was removed from three of these solutions (0.75, 1.00 and 2.00 M SCN^-) and replaced with a fresh white one, squeezing for an additional 3 hours in 0.75 M SCN^- once again produced a salmon coloured foam, in 1.00 M SCN^-

the foam turned slightly off-white and in 2.00 M SCN^- the foam remained completely white. This apparently indicates that the first foam exposed to the 0.75 M SCN^- solution left a substantial amount of iron unextracted to be removed in part by a second foam piece while from 2.00 M SCN^- solution essentially all iron was removed by the first piece indicating a much higher distribution ratio resulted from the increase in thiocyanate concentration. Thus, under the conditions of the experiment, the extractable iron species apparently requires a larger excess of SCN^- than does the cobalt one in order to be efficiently formed and extracted.

While observing the extraction behaviour of the iron complex onto a second foam piece, measurements were also made of the amount of ^{60}Co removed in these three solutions. Since 99.8 to 99.9% of the ^{60}Co was removed by a single foam piece, the same proportion of the remaining activity should be removed by a second piece. This would leave approximately 0.0001% of the original activity in solution unless there are forms of ^{60}Co present which cannot be converted to the extractable species. Although one is unable to measure as little as 0.0001% of the original activity, it was possible to place a lower limit on the percentage of the original activity which is extracted by two foams as at least 99.99%. Thus, if there is any non-extractable cobalt present in the tracer, it is very slight and the tracer was considered to be more than satisfactory for our purposes.

The results of the experiment are collected in Table II-9 and displayed in Figure 2-13 as the logarithm of the distribution ratio as a function of the logarithm of the initial solution thiocyanate con-

TABLE II-9 EFFECT OF SCN^- CONCENTRATION ON COBALT EXTRACTION

Initial Conditions:

[Co] 1.7×10^{-6} M (0.10 ppm)
 Ionic Strength (I) 2.88 M (NaCl)
 pH 4.7 (0.88 M Na acetate buffer)
 Solution Volume (V) 150.0 mL
 Foam Weight (W) 0.050 grams
 Type #1338 BFG
 Squeezing Time 24.0 hours
 Temperature 25.00°C

Sample Number	[SCN^-] (M)	Foam Weight (mg)	Co Extracted (%)	D (L kg^{-1})	log D
1	0.010	50.39	0.1 ± 0.3	2 ± 9 $\times 10^0$	0.3 ± 1.8
2	0.025	50.84	0.8 ± 0.4	2.4 ± 1.2 $\times 10^1$	1.38 ± 0.22
3	0.050	51.26	9.71 ± 0.30	3.15 ± 0.10 $\times 10^2$	2.498 ± 0.014
4	0.075	49.80	33.96 ± 0.23	1.549 ± 0.012 $\times 10^3$	3.1900 ± 0.0032
5	0.10	50.92	60.45 ± 0.15	4.502 ± 0.020 $\times 10^3$	3.6534 ± 0.0019
6	0.25	50.59	97.44 ± 0.05	1.128 ± 0.021 $\times 10^5$	5.052 ± 0.008
7	0.50	50.38	99.622 ± 0.028	7.8 ± 0.6 $\times 10^5$	5.895 ± 0.031
8	0.75	51.54	99.848 ± 0.015	1.91 ± 0.19 $\times 10^6$	6.28 ± 0.04
9	1.00	50.53	99.894 ± 0.022	2.8 ± 0.6 $\times 10^6$	6.45 ± 0.09
10	2.00	50.10	99.909 ± 0.019	3.3 ± 0.7 $\times 10^6$	6.52 ± 0.09

Figure 2-13

Effect of thiocyanate concentration on cobalt sorption from 150.0 mL of aqueous solution by 0.050 gram pieces of #1338 BFG polyurethane foam. Initial solution conditions were as follows:

1.7 x 10⁻⁶ M (0.10 ppm) Co(II)

0.88 M NaOOCCH₃/1.00 M HOOCCH₃ buffer, pH 4.7

2.88 M total ionic strength (maintained by NaCl addition)

25.00°C

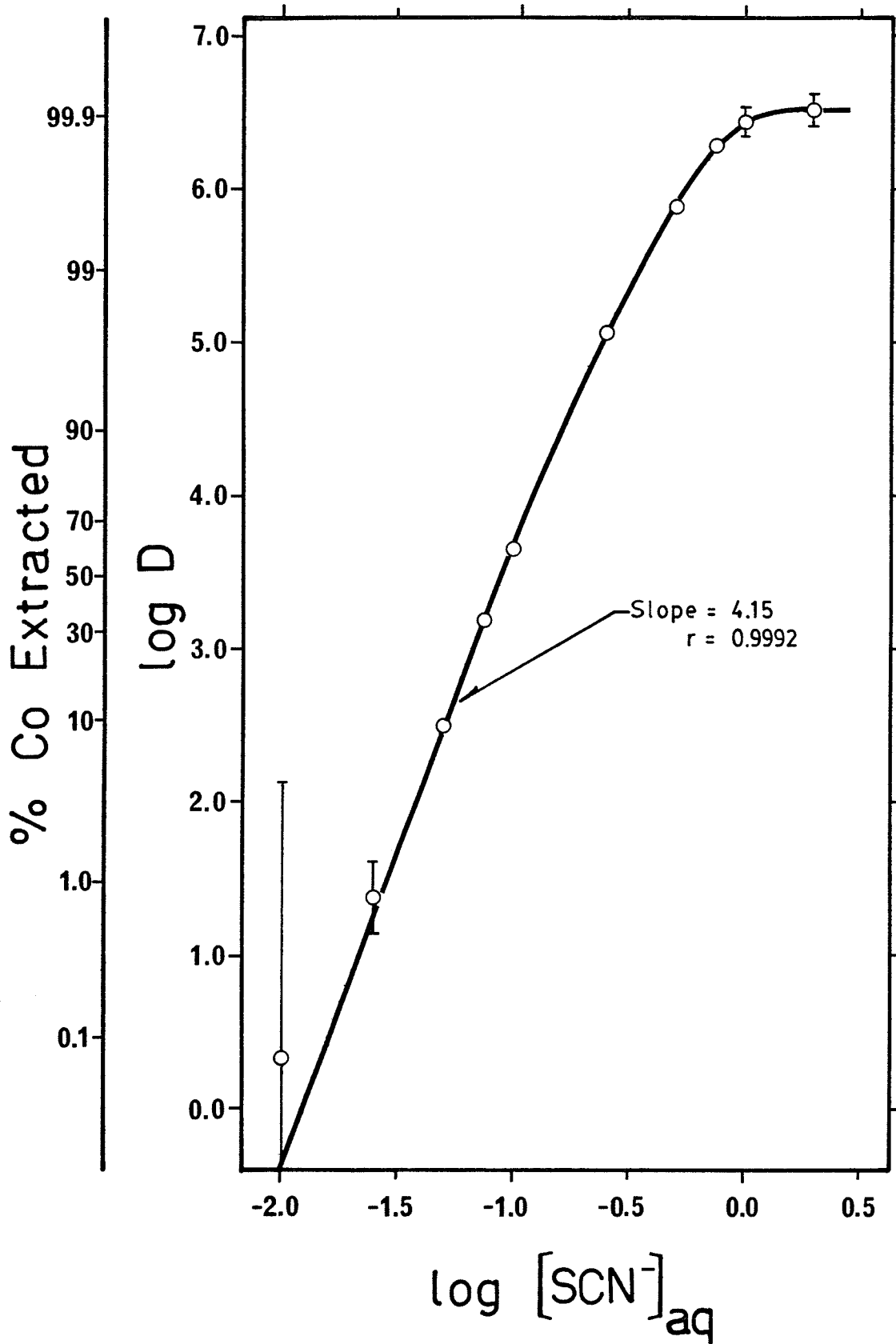

centration. Although equilibrium values of thiocyanate concentration are really desired here (which may be different by virtue of SCN^- sorption by foam or complexation by cobalt), the initial concentrations were determined to be good approximations. To illustrate this, on another occasion a comparison was made of the weight increases of 50 mg foam pieces after sorption of cobalt from 150 mL of either 0.10 M NaSCN or 2.90 M NaSCN solutions (containing also 0.10 M $\text{NaOOCCH}_3/\text{HOOCCH}_3$ buffer and NaCl in one case to bring the ionic strength to 3.00 M). The results showed that weight increases in excess of that attributable to the extractable cobalt species itself would account for only 3.5×10^{-6} moles and 2.7×10^{-5} moles of NaSCN respectively if they were totally attributed to NaSCN. Since even the least concentrated solution in this experiment contains 1.5×10^{-3} moles of SCN^- , we see that only negligible losses can occur by sorption onto foam. In addition, thiocyanate ion accompanying cobalt in the various complexes of the two can be calculated to be less than 1×10^{-6} moles in this experiment so that only negligible losses are again possible. Thus, the use of initial concentrations of thiocyanate to represent equilibrium values is justified.

From the data of Table II-9 and Figure 2-13 we see that large counting uncertainties result when very little cobalt (less than 1%) is extracted. When compounded with further very significant errors caused simply by evaporation of small amounts of solvent in this range, we see that measurements here are very difficult indeed. However, much better quantitation is possible in the rest of the working range. It is apparent from the Figure that the sorption of cobalt is very sensitive

to the concentration of SCN^- over the range from 0.01 M to about 0.5 M SCN^- and that it becomes much less sensitive at values above about 1 M SCN^- .

Another very important point to note in Figure 2-13 is that the curve joining the points becomes nearly linear at low thiocyanate concentration and has a slope given by linear regression to be very near to 4. Since under these conditions formation of the extractable cobalt species is controlled by the availability of the relatively scarce SCN^- ions, the plot of $\log D$ against $\log [\text{SCN}^-]$ is expected to be related to the number of SCN^- ligands involved in the extractable species.

To see that this is so, we will assume first that the sorption mechanism is similar to solvent extraction (and this includes CCM in the event of very little prior filling of sites with ion pairs) and surmise that the extracted species is of the general form $\text{M}_x \text{Co}_y (\text{SCN})_z$ where M^+ is any singly-charged cation which may be required to maintain electrical neutrality. In assuming this, we do not rule out the possibility that $x = 0$ and that a neutral species is therefore extracted. In deducing the identity of M^+ , we may be guided by the results of the previous experiment showing the effects of pH on cobalt extraction which indicated that if a cation is involved, it does not appear to be either the hydrogen (H^+) or hydronium (H_3O^+) ions. In this experiment, where the only other cation present in significant numbers is Na^+ , we infer that M^+ will be the sodium ion but we will nevertheless leave the extractable species in its more general form, $\text{M}_x \text{Co}_y (\text{SCN})_z$.

We may now develop the mathematical expressions which describe the

expected sorption process of this species but a few important explanations should precede this. Here, and in later treatments, square brackets will be used to denote concentrations of species in either phase (aqueous or foam). In the aqueous phase, molar (mol L⁻¹) concentration units will be used whereas all concentrations in the foam phase will be expressed in molal (mol kg⁻¹) units for convenience. In addition, we will consistently use equilibrium constants derived directly from these concentrations rather than activities (as would be preferable if the many appropriate activity coefficients were known). In so doing, we make an approximation to simplify the treatment and it should, therefore, be borne in mind that the "constants" thus expressed are not strictly constants. Any important errors which arise out of this approximation will be treated in a qualitative manner only.

The formation of the extractable $M_x Co_y (SCN)_z$ species in the aqueous phase (assumed to be completely dissociated there if charged) may then be represented by an equation and a formation constant, K_f :

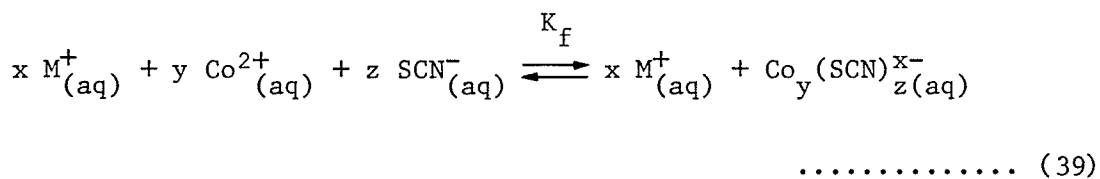

$$K_f = \frac{[Co_y (SCN)_z^{x-}]_{aq}}{[Co^{2+}]_{aq}^y [SCN^-]_{aq}^z} \dots\dots\dots (40)$$

The extractable species would distribute itself between the two phases (foam and water) according to the equilibrium:

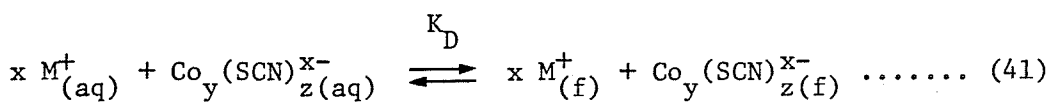

$$K_D = \frac{[M^+]_f^x [Co_y(SCN)_z^{x-}]_f}{[M^+]_{aq}^x [Co_y(SCN)_z^{x-}]_{aq}} \dots\dots\dots (42)$$

where the subscripts "aq" and "f" distinguish species in the aqueous and foam phases, respectively and K_D is the equilibrium distribution constant. In equation (41) we have not called attention to any special association the cation or anion may have with the foam structure and it is not important to do so unless sites become scarce. Also, we have assumed the extracted species to be completely unassociated with one another in the foam phase as separate $M^+_{(f)}$ and $Co_y(SCN)_z^{x-}_{(f)}$ moieties but, depending on the dielectric constant and other specific factors pertaining to polyurethane, they may actually be partly or completely associated or "paired" as follows:

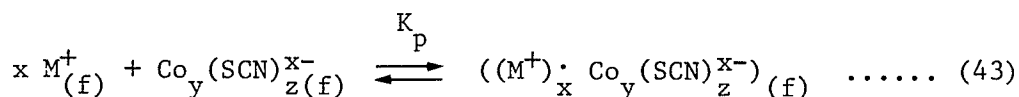

$$K_p = \frac{[(M^+)_x Co_y(SCN)_z^{x-}]_f}{[M^+]_f^x [Co_y(SCN)_z^{x-}]_f} \dots\dots\dots (44)$$

where K_p is a constant describing the extent of pairing. Our reason for writing the paired species as $((M^+)_x Co_y(SCN)_z^{x-})_{(f)}$ rather than simply $M_x Co_y(SCN)_z^{x-}_{(f)}$ will become apparent later.

Combining equations (40) and (42) and solving for $[Co_y(SCN)_z^{x-}]_f$ we get:

$$[Co_y(SCN)_z^{x-}]_f = K_f K_D [M^+]_{aq}^x [Co^{2+}]_{aq}^y [SCN^-]_{aq}^z [M^+]_f^{-x} \dots\dots\dots (45)$$

Similarly, combining equations (44) and (45) and solving for $[(M^+) \cdot Co_y(SCN)_z^{x-}]_f$ we get:

$$[(M^+) \cdot Co_y(SCN)_z^{x-}]_f = K_f K_D K_p [M^+]_{aq}^x [Co^{2+}]_{aq}^y [SCN^-]_{aq}^z \dots\dots (46)$$

Now, we are calculating the distribution ratio, D, as

$$D = \frac{[\text{cobalt in all forms}]_f}{[\text{cobalt in all forms}]_{aq}} = \frac{[Co]_f}{[Co]_{aq}} \dots\dots\dots (47)$$

In evaluating the total concentration of cobalt species in the aqueous phase, $[Co]_{aq}$, we are faced with the problem that several ligands, including SCN^- , Cl^- and CH_3COO^- are present and therefore a multitude of solution complexes are possible. However, if the concentration of SCN^- in the aqueous phase is kept low enough, then very little of the cobalt present initially as $Co^{2+}_{(aq)}$ will be present as thiocyanate-containing complexes. In addition, if the concentrations of ligands other than SCN^- remain sensibly constant (and this is certainly true when $[SCN^-]_{aq}$ is low) and if no aqueous cobalt polynuclear species are formed (as will be true at the low $[Co]_{aq}$ present here) then the proportion

$$C = \frac{[\text{Co in all non-SCN}^- \text{ containing forms}]_{aq}}{[Co^{2+}]_{aq}} \dots\dots\dots (48)$$

where the form $Co^{2+}_{(aq)}$ is not included in the numerator, will be a constant. Thus, ignoring the thiocyanate-containing species in the special case of sufficiently low thiocyanate concentration gives:

$$\begin{aligned}
 [\text{Co}]_{\text{aq}} &\approx [\text{Co}^{2+}]_{\text{aq}} + [\text{Co in all non-SCN}^- \text{ containing forms}]_{\text{aq}} \\
 &= (1 + C) \cdot [\text{Co}^{2+}]_{\text{aq}}
 \end{aligned}$$

so

$$[\text{Co}^{2+}]_{\text{aq}} = [\text{Co}]_{\text{aq}} (1 + C)^{-1} \dots\dots\dots (49)$$

Barring the formation of substantial amounts of other cobalt-containing species in the foam phase, then, we have:

$$\begin{aligned}
 D &\approx \frac{[\text{Co}_y (\text{SCN})_z^{x-}]_f + [(M^+)_x \cdot \text{Co}_y (\text{SCN})_z^{x-}]_f}{[\text{Co}]_{\text{aq}}} \\
 &= \frac{K_f K_D [M^+]_{\text{aq}}^x (C + 1)^{-y} [\text{Co}]_{\text{aq}}^y [\text{SCN}^-]_{\text{aq}}^z ([M^+]_f^{-x} + K_p)}{[\text{Co}]_{\text{aq}}} \\
 &= K_f K_D (1 + C)^{-y} [M^+]_{\text{aq}}^x [\text{Co}]_{\text{aq}}^{(y-1)} [\text{SCN}^-]_{\text{aq}}^z ([M^+]_f^{-x} + K_p) \\
 &\dots\dots\dots (50)
 \end{aligned}$$

This expression for D now contains a summation term, $([M^+]_f^{-x} + K_p)$, whose value will depend upon the relative amounts of cobalt present in the foam phase as the paired $((M^+)_x \text{Co}_y (\text{SCN})_z^{x-})_f$ or unassociated $(\text{Co}_y (\text{SCN})_z^{x-})_f$ species. If the paired form predominates, K_p will be relatively large and D will only be directly dependent on the solution $M^+_{(\text{aq})}$, $\text{Co}_{(\text{aq})}$ and $\text{SCN}^-_{(\text{aq})}$ concentrations. On the other hand, if the unassociated form predominates, then D will additionally depend inversely on the x^{th} power of the foam $M^+_{(\text{f})}$ concentration which will be indirectly dependent on the extent of extraction of a number of other possible species (such as $M^+_{(\text{f})} + \text{SCN}^-_{(\text{f})}$) containing this cation also.

Let us consider first as correct the situation in which ion pairs predominate in the foam. There is some logical expectation that this may be so since polyether-based polyurethane is not greatly polar and the crosslinked polymer can be imagined as a severely viscous liquid in which any solvated ions would be unable to carry their solvent shells along with them if they migrate apart by thermal motions and must therefore continually break old and make new associations with the polymer to do so. If this expectation is correct, we can ignore the $[M^+]_f^{-x}$ term in equation (50) which pertains only to the unassociated species. This being done, we may then notice that K_D , K_f , K_p and $(1+C)^{-y}$ are constants by definition (subject to changes in activity coefficients) and are thus not dependent on $[SCN^-]_{aq}$. Also, $[M^+]_{aq}$ is deliberately large (2.88 M) and identical for each solution so it is likewise independent of $[SCN^-]_{aq}$. In addition, if we are considering a situation in which $[SCN^-]_{aq}$ is sufficiently low, then little (say, less than 20%) of the original $Co^{2+}_{(aq)}$ is consumed by either complexation by that ligand or extraction so $[Co]_{aq}$ is nearly insensitive to $[SCN^-]_{aq}$ also. Under these special circumstances, several quantities can be grouped together into a single constant, $K = K_f K_D K_p (1+C)^{-y} [M^+]_{aq}^x [Co]_{aq}^{(y-1)}$ and equation (50) can be rewritten as:

$$D \approx K [SCN^-]_{aq}^z \dots\dots\dots (51)$$

and

$$\log D \approx \log K + z \log [SCN^-]_{aq} \dots\dots\dots (52)$$

Thus, we predict that a plot of $\log D$ versus $\log [SCN^-]_{aq}$ will be

linear at low $[\text{SCN}^-]_{\text{aq}}$ with a slope of z if all of the above assumptions are correct. This is what is observed in Figure 2-13 where the curve apparently tends to a line of slope equal to 4.15 at low $[\text{SCN}^-]_{\text{aq}}$. We infer, therefore, that if the paired cobalt species predominate, $z = 4$ and that the species extracted by foam will be $(\text{M}^+)_x \text{Co}_y (\text{SCN})_4^{x-}$.

However, if the assumption of large-scale ion pairing in the polymer is not correct and unassociated forms $(\text{Co}_y (\text{SCN})_z^{x-})_{(f)}$ predominate instead, then the situation is more complicated. In this instance, K_p will be small relative to $[\text{M}^+]_f^{-x}$ and equation (50) approximates to:

$$D \approx K_f K_D (1+C)^{-y} [\text{M}^+]_{\text{aq}}^x [\text{Co}]_{\text{aq}}^{(y-1)} [\text{SCN}^-]_{\text{aq}}^z [\text{M}^+]_f^{-x} \dots \dots \dots (53)$$

Again, grouping together those things which we expect to be independent of $[\text{SCN}^-]_{\text{aq}}$ with the usual restriction that it is very low, we get a new constant, K' , given by:

$$K' = K_f K_D (1+C)^{-y} [\text{M}^+]_{\text{aq}}^x [\text{Co}]_{\text{aq}}^{(y-1)} \dots \dots \dots (54)$$

so,

$$D \approx K' [\text{SCN}^-]_{\text{aq}}^z [\text{M}^+]_f^{-x} \dots \dots \dots (55)$$

$$\log D \approx \log K' - x \log [\text{M}^+]_f + z \log [\text{SCN}^-]_{\text{aq}} \dots \dots \dots (56)$$

The $\log D$ versus $\log \text{SCN}^-_{\text{aq}}$ plot will yield a straight line in this case only if $[\text{M}^+]_f$ is either essentially constant over the range specified by the above restrictions or if it is directly proportional to some power,

p, of the thiocyanate concentration itself (i.e. $[M^+]_f = k[SCN^-]_{aq}^p$). The first possibility could be true if there are comparatively large amounts of other ionic species which contain M^+ but not SCN^- (such as $M^+ + OOCCH_3^-$ or $M^+ + Cl^-$) also sorbed. In this case, $x \log[M^+]_f$ will simply be another constant and equation (56) again predicts a line of slope z will result at low $[SCN^-]_{aq}$. On the other hand, the second possibility may be correct if $M^+_{(f)} + SCN^-_{(f)}$ and/or $xM^+_{(f)} + Co_y(SCN)_z^{x-}$ are the only sources of $M^+_{(f)}$ (which assumes, of course, negligible extraction of anything else containing M^+). In this instance, equation (56) can be rewritten as:

$$\begin{aligned} \log D &\approx \log K' + z \log[SCN^-]_{aq} - x \log(k[SCN^-]_{aq}) \\ &= \log K' - x \log k + z \log[SCN^-]_{aq} - px \log[SCN^-]_{aq} \\ &= \log K'' + (z - px) \log[SCN^-]_{aq} \dots\dots\dots (57) \end{aligned}$$

where K'' is a new constant incorporating K' and k^x . The value of p would be expected to fall somewhere between 1 (if essentially all $M^+_{(f)}$ were from $M^+ + SCN^-$) and z (if the only source of $M^+_{(f)}$ were from $xM^+ + Co_y(SCN)_z^{x-}$). Thus, the slope of a $\log D$ versus $\log[SCN^-]_{aq}$ line expected in this instance would lie somewhere between $(z-x)$ and $(z-zx)$ depending on the relative importances of $(M^+ + SCN^-)$ and $(xM^+ + Co_y(SCN)_z^{x-})$ as sources of $M^+_{(f)}$. However, if no oxidation or reduction of M^+ , $Co(II)$ or SCN^- occurs during formation of the extractable complex and its subsequent extraction (this will later be shown to be very unlikely) then the values x, y and z are all related by the expression of electrical neut-

rality:

$$x + 2y - z = 0 \quad \dots\dots\dots (58)$$

Taking this and the expressions equating the measured and predicted boundary slopes, $(z-x) = 4$ or $(z-zx) = 4$, it can be shown that we must have $y=2$ (i.e. two cobalt atoms per extractable species) for these requirements to be fulfilled. We will see later that this is apparently not the case so we conclude that the observed slope of 4 does not arise out of a proportionality between $[M^+]_f$ and $[SCN^-]_{aq}$. The measured slope, therefore, does give $z = 4$ regardless of whether the extracted cobalt-containing species exists in unassociated or in paired form. If the extraction mechanism is a solvent extraction-like one, the sorbed species is, therefore, evidently $(M^+)_x \cdot Co_y (SCN)_4^{x-}$ or $(xM^+ + Co_y (SCN)_4^{x-})$ where the values of x and y are not yet entirely deduced.

Similarly, we may consider an anion exchange type of mechanism (e.g. the Cation Chelation Mechanism in which many exchange sites are formed by sorption of $M^+_{(aq)} + A^-_{(aq)}$ pairs of ions where A^- may be any of Cl^- , CH_3COO^- or SCN^-). The solution equilibria to form the extractable cobalt species, $Co_y (SCN)_z^{x-}_{(aq)}$, will be essentially the same as before; that is:

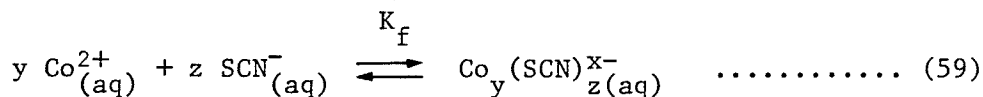

$$K_f = \frac{[Co_y (SCN)_z^{x-}]_{aq}}{[Co^{2+}]^y_{aq} [SCN^-]^z_{aq}} \quad \dots\dots\dots (60)$$

The distribution between the two phases will then be given by the exchange equation:

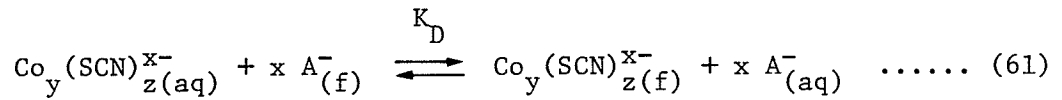

$$K_D = \frac{[\text{Co}_y(\text{SCN})_z^{x-}]_{\text{f}} [\text{A}^-]_{\text{aq}}^x}{[\text{Co}_y(\text{SCN})_z^{x-}]_{\text{aq}} [\text{A}^-]_{\text{f}}^x} \quad \dots\dots\dots (62)$$

Thus, combining equations (60) and (62) to solve for $[\text{Co}_y(\text{SCN})_z^{x-}]_{\text{f}}$ gives:

$$[\text{Co}_y(\text{SCN})_z^{x-}]_{\text{f}} = K_f K_D [\text{Co}^{2+}]_{\text{aq}}^y [\text{SCN}^-]_{\text{aq}}^z [\text{A}^-]_{\text{f}}^x [\text{A}^-]_{\text{aq}}^{-x} \quad \dots\dots\dots (63)$$

We will not worry about whether or not the extracted species will be strongly paired with the exchange site but write the expression for the distribution ratio directly:

$$\begin{aligned} D &= \frac{[\text{Co}]_{\text{f}}}{[\text{Co}]_{\text{aq}}} = \frac{[\text{Co}_y(\text{SCN})_z^{x-}]_{\text{f}}}{[\text{Co}]_{\text{aq}}} \\ &= \frac{K_f K_D [\text{Co}^{2+}]_{\text{aq}}^y [\text{SCN}^-]_{\text{aq}}^z [\text{A}^-]_{\text{f}}^x}{[\text{Co}]_{\text{aq}} [\text{A}^-]_{\text{aq}}^x} \quad \dots\dots\dots (64) \end{aligned}$$

Again placing the same restrictions on solution conditions (i.e. $[\text{SCN}^-]_{\text{aq}}$ sufficiently low and other ligand concentrations constant), we may use equation (49) in (64) to get:

$$D \approx K_f K_D (1+C)^{-y} [\text{Co}]_{\text{aq}}^{(y-1)} [\text{SCN}^-]_{\text{aq}}^z [\text{A}^-]_{\text{f}}^x [\text{A}^-]_{\text{aq}}^{-x} \quad \dots\dots\dots (65)$$

Assuming that A^- will be mostly Cl^- or CH_3COO^- under conditions in which $[SCN^-]_{aq}$ is very low and also assuming that not much A^- is exchanged from foam (i.e. we are well beneath the capacity), then the terms $[A^-]_f^x$ and $[A^-]_{aq}^{-x}$ are both constants independent of thiocyanate concentration. Also, making the assumption that at sufficiently low thiocyanate concentration only a small percentage of cobalt is being extracted and so $[Co]_{aq}$ is nearly independent of thiocyanate concentration, we may group a number of constants or near constants to give:

$$K = K_f K_D (1+C)^{-y} [Co]_{aq}^{(y-1)} [A^-]_f^x [A^-]_{aq}^{-x} \dots\dots\dots (66)$$

Thus, $D \approx K [SCN^-]_{aq}^z$

and $\log D \approx \log K + z \log [SCN^-]_{aq} \dots\dots\dots (67)$

This brings us to the same conclusion as before that the limiting value of the slope of the $\log D$ versus $\log [SCN^-]_{aq}$ curve at low $[SCN^-]_{aq}$ gives $z = 4$ and the exchanged species will be $Co_y (SCN)_4^{x-}$ if an ion exchange-like mechanism is involved.

Forgetting for the moment the implications about the form of the extractable species and the extraction mechanism but viewing instead results in Figure 2-13 strictly from an extraction point of view, we see that control of the solution thiocyanate concentration provides very wide flexibility in the sorption and likely desorption of cobalt. Thus, as applied to column chromatographic or batch extraction separations, some

degree of selectivity is expected to be possible by careful choice of the thiocyanate concentration in conjunction with other solution parameters. It will also be noted that from 1.0 M thiocyanate solutions very efficient sorptions of cobalt (~99.9%) can be achieved in the presence of iron under conditions for which there are 3000 liters of solution for each kilogram of foam. Such extraordinarily high extraction efficiencies may possibly prove useful in sample preconcentration prior to analysis or in the cleanup of radioactive wastes where large volumes must be handled and high efficiency is required. On the other hand, it will be noted that the use of only 0.1 M SCN^- would yield quite acceptable extraction (about 60%) for an industrial application where the costs of providing a higher level of thiocyanate might be prohibitive.

5. Effect of Cobalt Concentration on Sorption From Thiocyanate Solution by Polyurethane Foam and Determination of Sorption Capacity

An experiment was devised to observe the effect of cobalt concentration on its sorption from thiocyanate solutions both to establish the value of "y" in the extractable species, $M_x Co_y (SCN)_z$, and to determine the capacity to which #1338 BFG polyurethane could sorb cobalt.

Initial experiments aimed at achieving this goal using 1.0 M NH_4SCN as the source of thiocyanate ion had given a capacity of about 0.53 moles of cobalt per kilogram of foam and had demonstrated very little change in extraction behaviour at low concentrations of cobalt. In addition, it was noted that those foam pieces which were loaded most nearly to capacity required longer times to approach equilibrium with the solution. Based on these preliminary results, plans were made to equilibrate pieces of foam with solutions having a wide range of cobalt concentrations and to measure the resulting sorption behaviour. In order to compare the behaviour at high and moderate extraction efficiencies, similar experiments were planned having two different solution thiocyanate concentrations while still assuring that thiocyanate would always be available in substantial excess.

The initial solution conditions chosen for the experiment are shown at the top of Table II-10. The investigation was carried out in two parts (Experiments 1 and 2) corresponding to the different thiocyanate concentrations used (0.10 M and 0.25 M, respectively). Slightly different solution preparation and counting methods were used for each.

In Experiment 1, a stock solution containing $NaOOCCH_3/HOOCCH_3$ buffer, $NaSCN$ and $NaCl$ was prepared so that 100.0 mL aliquots of this

solution would give 1.00 M buffer, 0.10 M NaSCN and 1.90 M NaCl when diluted to 150.0 mL. After delivering this aliquot into each of the volumetric flasks, various volumes of 150, 1.5 or 0.015 ppm Co^{2+} stock solution (prepared by successive dilution of the original 1000 ppm stock solution) were added along with the usual portion of ^{60}Co tracer to give the desired very wide range of initial cobalt concentrations extending from tracer only ($\sim 10^{-5}$ ppm) to 100 ppm. The flasks were then diluted to near the mark and mixed before leaving them overnight to equilibrate. The remainder of the experiment was then carried out as described in the General Procedure using single condom seals and applying a light film of silicone grease to the stems of the plungers. On this occasion, the Procedure was modified a little to count the empty individual counting tubes ten times each to obtain slightly better background evaluation but no corrections for spectrometer drift were made. After the usual 24 hour equilibration period had passed, moreover, it was noted that those solutions which contained high concentrations of cobalt still showed significant increases in sorption so squeezing was continued for an additional 24 hours.

In Experiment 2 (0.25 M NaSCN), on the other hand, separate aliquots of stock 2.5 M NaSCN, 2.5 M $\text{NaOOCCH}_3/\text{HOOCCH}_3$ buffer and ^{60}Co tracer were delivered into the volumetric flasks along with the weight of NaCl salt requisite to maintain the ionic strength at 3.00 M. In addition, radiometric analyses were performed using a NaI(Tl) crystal in conjunction with the Tracor Northern multichannel analyzer adjusted to integrate only the ^{60}Co photopeaks at 1.173 and 1.332 MeV rather than the usual Baird-Atomic single channel spectrometer. This change was necessitated

by modifications being made to the regular equipment at that time. Aside from these two alterations, the same procedure as was carried out in Experiment 1 was used.

During the course of the experiments, several important observations were made. First, the colours which developed on the foam pieces during squeezing in the solutions ranged from off-white through various shades of green to a dark blue-green in exact parallel to the amount of cobalt which was measured by counting to be sorbed. This progression confirms earlier comments which linked the intensity of green foam colour to the extent of cobalt sorption from solutions containing identical cobalt concentrations but differing in some other aspect which alters the extent of sorption. In this case, of course, all parameters but cobalt concentration have been kept constant.

A second observation of note was that those foam pieces which sorbed the largest amounts of cobalt (and which therefore turned the deepest blue-green colours) also became brittle. Consequently, many small bits of foam broke off during squeezing and were trapped by the silicone grease coated on the distribution cell plunger stem. In the most severe cases, after some period of equilibration the foam failed to return to its expanded form after being squeezed flat by the plunger. This fact is likely one of the reasons for the increased length of time required to reach equilibrium in high cobalt solutions. However, the greater significance of these observations will be considered later.

Results of the experiment are collected in Tables II-10 and II-11. Table II-10 contains the sorption data measured only after the standard 24 hour equilibration period for each cobalt concentration while Table

TABLE II-10 - EFFECT OF COBALT CONCENTRATION ON EXTRACTION

Initial Conditions:

Ionic Strength (I) 3.00 M (NaCl) Foam Weight (W) 0.050 grams
 pH 4.8 (1.0 M Na acetate buffer) Type #1338 BFG
 Solution Volume (V) 150.0 mL Squeezing Time 24.0 hours
 Temperature 25.00°C

EXPERIMENT 1: [SCN⁻] 0.10 M (NaSCN)

Sample Number	Initial [Co] (M)	Foam Weight (mg) ±0.01	Cobalt Extracted (%)	D (L kg ⁻¹)	log D	Equilibrium					
						Solution [Co] _{aq} (M)	log[Co] _{aq}	Foam [Co] _f (mol kg ⁻¹) log[Co] _f			
1	~1.7 x 10 ^{-10*}	49.82	63.79 ±0.14	5.304 ±0.024	3.7246 ±0.0020	6.144 ±0.024	x 10 ⁻¹¹	-10.2115 ±0.0017	3.259 ±0.007	x 10 ⁻⁷	-6.4869 ±0.0010
2	1.866 x 10 ⁻⁹	49.14	61.98 ±0.20	4.977 ±0.031	3.6970 ±0.0027	7.10 ±0.04	x 10 ⁻¹⁰	-9.1490 ±0.0023	3.532 ±0.012	x 10 ⁻⁶	-5.4520 ±0.0014
3	3.563 x 10 ⁻⁹	50.42	62.79 ±0.15	5.021 ±0.023	3.7008 ±0.0020	1.326 ±0.005	x 10 ⁻⁹	-8.8775 ±0.0017	6.657 ±0.016	x 10 ⁻⁶	-5.1767 ±0.0010
4	6.957 x 10 ⁻⁹	49.86	62.77 ±0.13	5.072 ±0.020	3.7052 ±0.0017	2.590 ±0.009	x 10 ⁻⁹	-8.5867 ±0.0015	1.3138 ±0.0027	x 10 ⁻⁵	-4.8815 ±0.0009
5	1.714 x 10 ⁻⁸	48.08	62.71 ±0.11	5.248 ±0.018	3.7199 ±0.0015	6.390 ±0.019	x 10 ⁻⁹	-8.1945 ±0.0013	3.353 ±0.006	x 10 ⁻⁵	-4.4745 ±0.0008
6	3.411 x 10 ⁻⁸	49.71	62.51 ±0.16	5.031 ±0.025	3.7071 ±0.0021	1.279 ±0.005	x 10 ⁻⁸	-7.8933 ±0.0018	6.433 ±0.016	x 10 ⁻⁵	-4.1916 ±0.0011
7	6.804 x 10 ⁻⁸	50.30	62.79 ±0.12	5.059 ±0.019	3.7040 ±0.0017	2.532 ±0.008	x 10 ⁻⁸	-7.5965 ±0.0014	1.274 ±0.002	x 10 ⁻⁴	-3.8948 ±0.0009
8	1.698 x 10 ⁻⁷	49.44	62.22 ±0.14	4.998 ±0.021	3.6988 ±0.0019	6.416 ±0.024	x 10 ⁻⁸	-7.1927 ±0.0016	3.207 ±0.007	x 10 ⁻⁴	-3.4939 ±0.0010
9	3.394 x 10 ⁻⁷	50.51	64.18 ±0.17	5.322 ±0.029	3.7261 ±0.0024	1.215 ±0.006	x 10 ⁻⁷	-6.9153 ±0.0021	6.468 ±0.017	x 10 ⁻⁴	-3.1892 ±0.0011

TABLE II-10 - continued

Sample Number	Initial [Co] (M)	Foam Weight (mg) ± 0.01	Cobalt Extracted (%)	D (L kg ⁻¹)	Log D	Solution [Co] _{aq} (M)		Equilibrium			
						[Co] _{aq}	log[Co] _{aq}	[Co] _f (mol kg ⁻¹)	log[Co] _f		
10	6.787 x 10 ⁻⁷	50.56	64.13 ± 0.14	5.305 x 10 ³	3.7247 ± 0.0020	2.434 x 10 ⁻⁷	2.434 x 10 ⁻⁷	1.292 ± 0.003	-6.6136 ± 0.0018	1.292 x 10 ⁻³	-2.8889 ± 0.0010
11	1.697 x 10 ⁻⁶	49.18	63.01 ± 0.19	5.195 x 10 ³	3.7156 ± 0.0025	6.277 x 10 ⁻⁷	6.277 x 10 ⁻⁷	3.261 ± 0.010	-6.2023 ± 0.0022	3.261 x 10 ⁻³	-2.4867 ± 0.0013
12	3.394 x 10 ⁻⁶	50.01	63.44 ± 0.21	5.204 x 10 ³	3.7163 ± 0.0028	1.241 x 10 ⁻⁶	1.241 x 10 ⁻⁶	6.46 ± 0.07	-5.9063 ± 0.0027	6.46 x 10 ⁻³	-2.190 ± 0.005
13	6.787 x 10 ⁻⁶	50.53	64.80 ± 0.21	5.47 x 10 ³	3.7376 ± 0.0029	2.389 x 10 ⁻⁶	2.389 x 10 ⁻⁶	1.306 ± 0.004	-5.6218 ± 0.0025	1.306 x 10 ⁻²	-1.8840 ± 0.0014
14	1.697 x 10 ⁻⁵	50.78	66.98 ± 0.18	5.99 x 10 ³	3.7775 ± 0.0026	5.604 x 10 ⁻⁶	5.604 x 10 ⁻⁶	3.357 ± 0.009	-5.2515 ± 0.0023	3.357 x 10 ⁻²	-1.4740 ± 0.0011
15	3.394 x 10 ⁻⁵	48.48	67.70 ± 0.09	6.484 x 10 ³	3.8118 ± 0.0013	1.096 x 10 ⁻⁵	1.096 x 10 ⁻⁵	7.108 ± 0.009	-4.9601 ± 0.0012	7.108 x 10 ⁻²	-1.1483 ± 0.0006
16	6.787 x 10 ⁻⁵	50.29	67.15 ± 0.17	6.10 x 10 ³	3.7852 ± 0.0025	2.229 x 10 ⁻⁵	2.229 x 10 ⁻⁵	1.359 ± 0.003	-4.6518 ± 0.0023	1.359 x 10 ⁻¹	-0.8666 ± 0.0011
17	1.697 x 10 ⁻⁴	49.13	50.88 ± 0.21	3.162 x 10 ³	3.4999 ± 0.0026	8.34 x 10 ⁻⁵	8.34 x 10 ⁻⁵	2.636 ± 0.011	-4.0791 ± 0.0018	2.636 x 10 ⁻¹	-0.5791 ± 0.0018
18	3.394 x 10 ⁻⁴	48.62	32.53 ± 0.23	1.487 x 10 ³	3.172 ± 0.003	2.290 x 10 ⁻⁴	2.290 x 10 ⁻⁴	3.406 ± 0.024	-3.6420 ± 0.0015	3.406 x 10 ⁻¹	-0.4678 ± 0.0031
19	6.787 x 10 ⁻⁴	50.67	18.96 ± 0.33	6.926 x 10 ²	2.840 ± 0.008	5.500 x 10 ⁻⁴	5.500 x 10 ⁻⁴	3.81 ± 0.07	-3.2596 ± 0.0018	3.81 x 10 ⁻¹	-0.419 ± 0.008
20	1.697 x 10 ⁻³	50.99	8.58 ± 0.25	2.76 x 10 ²	2.441 ± 0.012	1.551 x 10 ⁻³	1.551 x 10 ⁻³	4.28 ± 0.12	-2.8093 ± 0.0012	4.28 x 10 ⁻¹	-0.368 ± 0.012

* Tracer only. Concentration estimated by calculation.

TABLE II-10 - continued
 EXPERIMENT 2: [SCN⁻] 0.25 M (NaSCN)

Sample Number	Initial [Co] (M)	Foam Weight (mg) ±0.01	Cobalt Extracted (%)	D (L kg ⁻¹)	log D	Equilibrium				
						Solution [Co] _{aq} (M)	log[Co] _{aq}	Foam [Co] _f (mol kg ⁻¹) log[Co] _f		
1	1.697 x 10 ⁻⁶	49.89	97.85 ±0.11	1.37 ±0.07	5.136 ±0.022	3.65 ±0.18	7.437 ±0.022	4.992 ±0.005	x 10 ⁻³	-2.3018 ±0.0005
2	3.394 x 10 ⁻⁶	50.07	97.80 ±0.09	1.33 ±0.05	5.125 ±0.018	7.45 ±0.30	-7.128 ±0.018	9.944 ±0.009	x 10 ⁻³	-2.0025 ±0.0004
3	6.787 x 10 ⁻⁶	50.07	97.94 ±0.08	1.42 ±0.06	5.153 ±0.018	1.399 ±0.058	-6.854 ±0.018	1.9913 ±0.0016	x 10 ⁻²	-1.7008 ±0.0004
4	1.697 x 10 ⁻⁵	49.30	97.86 ±0.09	1.39 ±0.06	5.142 ±0.019	3.64 ±0.16	-6.439 ±0.019	5.052 ±0.005	x 10 ⁻²	-1.2965 ±0.0004
5	3.394 x 10 ⁻⁵	49.81	97.77 ±0.09	1.32 ±0.05	5.120 ±0.018	7.57 ±0.31	-6.121 ±0.018	9.992 ±0.009	x 10 ⁻²	-1.0004 ±0.0004
6	6.787 x 10 ⁻⁵	50.26	97.08 ±0.09	9.90 ±0.29	4.996 ±0.013	1.99 ±0.06	-5.702 ±0.013	1.9664 ±0.0018	x 10 ⁻¹	-0.7063 ±0.0004
7	1.697 x 10 ⁻⁴	49.60	78.4 ±0.5	1.096 ±0.024	4.040 ±0.009	3.67 ±0.08	-4.435 ±0.009	4.022 ±0.023	x 10 ⁻¹	-0.3956 ±0.0025
8	3.394 x 10 ⁻⁴	49.67	45.0 ±0.8	2.47 ±0.06	3.393 ±0.011	1.866 ±0.029	-3.729 ±0.007	4.62 ±0.09	x 10 ⁻¹	-0.336 ±0.008
9	6.787 x 10 ⁻⁴	49.95	22.9 ±1.1	8.9 ±0.4	2.950 ±0.021	5.23 ±0.07	-3.281 ±0.006	4.67 ±0.22	x 10 ⁻¹	-0.331 ±0.020
10	1.697 x 10 ⁻³	50.39	8.0 ±1.2	2.6 ±0.4	2.41 ±0.07	1.561 ±0.021	-2.807 ±0.006	4.0 ±0.6	x 10 ⁻¹	-0.39 ±0.07

Figure 2-14

Effect of equilibrium solution cobalt concentration on distribution ratio, D, for extraction from 150.0 mL of aqueous thiocyanate solutions by 0.050 gram pieces of #1338 BFG polyurethane foam.

Initial solution conditions were:

1.00 M NaOOCCH₃/HOOCCH₃ buffer, pH 4.8

3.00 M total ionic strength (maintained by NaCl addition)

25.00°C

Notes:

—○— 0.10 M NaSCN

---□--- 0.25 M NaSCN

—△— ⁶⁰Co tracer only - initial concentration estimated

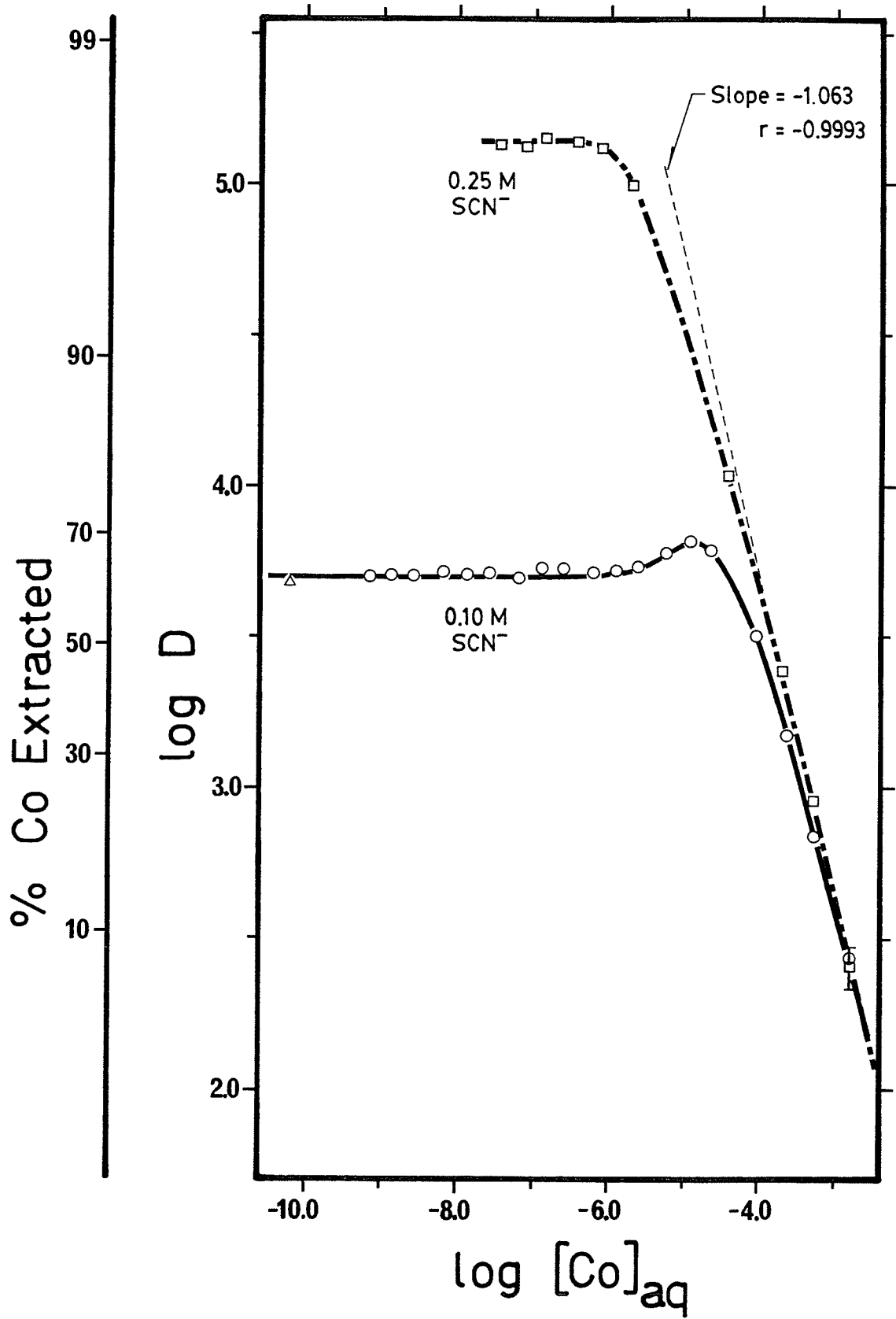

Figure 2-15

Effect of equilibrium solution cobalt concentration on extraction of cobalt from 150.0 mL of aqueous thiocyanate solutions by 0.050 gram pieces of #1338 BFG polyurethane foam.

Initial solution conditions were:

1.00 M NaOOCCH₃/HOOCCH₃ buffer, pH 4.8

3.00 M total ionic strength (maintained by NaCl addition)

25.00°C

Notes:

—○— 0.10 M NaSCN

—□— 0.25 M NaSCN

—△— ⁶⁰Co tracer only - initial concentration estimated

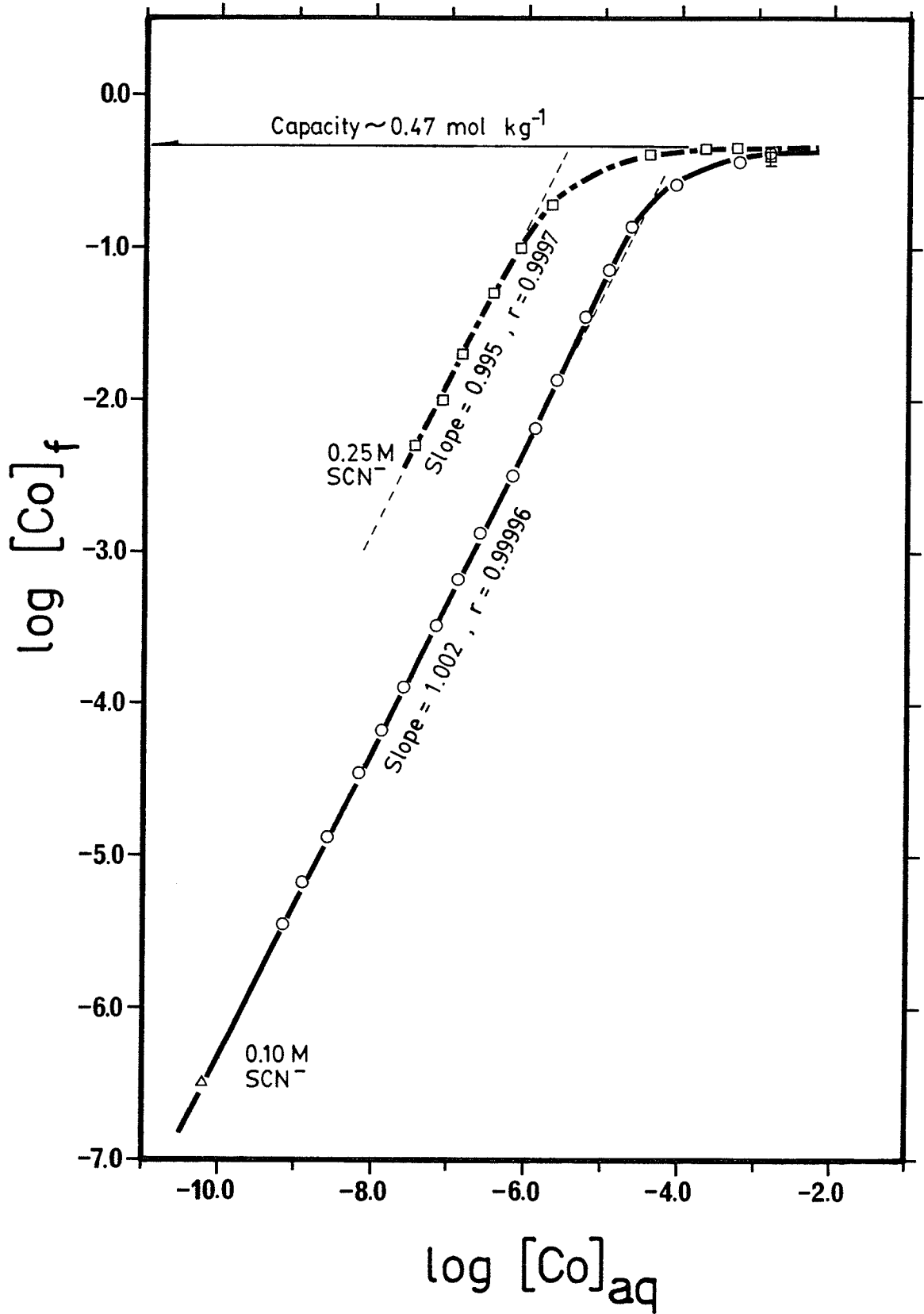

TABLE II-11 - SORPTION OF COBALT NEAR SATURATION OF FOAM

Initial Conditions:

Ionic Strength (I) 3.00 M (NaCl)
 pH 4.8 (1.0 M Na acetate buffer)
 Solution Volume (V) 150.0 mL
 Foam Weight (W) 0.050 grams
 Type #1338 BFG
 Temperature 25.00°C

Initial [Co]	Concentration of Cobalt on Foam, [Co] _f (mol kg ⁻¹)				
	after various contact times				
	6 hours	12 hours	24 hours	36 hours	48 hours
<u>EXPERIMENT 1:</u> [SCN ⁻] 0.10 M (NaSCN)					
6.787 x 10 ⁻⁵	0.13475 ±0.00030	0.13526 ±0.00030	0.13594 ±0.00035	0.13582 ±0.00025	0.13616 ±0.00031
1.697 x 10 ⁻⁴	0.2582 ±0.0013	0.2620 ±0.0010	0.2636 ±0.0011	0.2628 ±0.0011	0.2637 ±0.0010
3.394 x 10 ⁻⁴	0.3225 ±0.0029	0.3345 ±0.0026	0.3406 ±0.0024	0.3377 ±0.0026	0.3388 ±0.0028
6.787 x 10 ⁻⁴	0.348 ±0.006	0.372 ±0.005	0.381 ±0.007	0.386 ±0.006	0.388 ±0.005
1.697 x 10 ⁻³	0.390 ±0.009	0.417 ±0.011	0.428 ±0.012	0.434 ±0.011	0.441 ±0.013
<u>EXPERIMENT 2:</u> [SCN ⁻] 0.25 M (NaSCN)					
6.787 x 10 ⁻⁵	0.19581 ±0.00026	0.19638 ±0.00016	0.19664 ±0.00018	0.19649 ±0.00019	0.19652 ±0.00018
1.697 x 10 ⁻⁴	0.361 ±0.004	0.388 ±0.004	0.4022 ±0.0023	0.4071 ±0.0025	0.4079 ±0.0020
3.394 x 10 ⁻⁴	0.404 ±0.013	0.433 ±0.009	0.462 ±0.009	0.470 ±0.007	0.474 ±0.007
6.787 x 10 ⁻⁴	0.409 ±0.017	0.422 ±0.021	0.467 ±0.022	0.474 ±0.014	0.473 ±0.017
1.697 x 10 ⁻³	0.43 ±0.08	0.39 ±0.06	0.40 ±0.12	0.40 ±0.06	0.43 ±0.07

II-11 displays data measured after 6, 12, 24, 36 and 48 hour periods but only for those foams which approached saturation by cobalt. In compiling the Tables, knowledge of the weight of foam used, the initial solution cobalt concentration and radiometric measurement of the fraction of cobalt removed by foam were used to determine the equilibrium cobalt concentration in foam ($[\text{Co}]_f$) and in solution ($[\text{Co}]_{aq}$).

In order to test the lowest possible cobalt concentration in Experiment 1, the distribution of ^{60}Co tracer alone was followed. The exact quantity of cobalt contained in the tracer was not known but calculations based on its approximate original specific activity (as given by the supplier), its age and the fraction of it remaining gave a value in the neighbourhood of 1.5 nanograms of metal in the 40 μL aliquot normally used. This would give a solution cobalt concentration of 1.7×10^{-10} M when diluted to 150 mL in the experiment. Although this represents a rough figure at best, it is important in this experiment to know that the cobalt originating from the tracer is not large in comparison to the other inactive cobalt added. Consequently, an upper limit was set on the concentration by observing the colours developed on a 100 μg foam piece which was placed into a 3.0 mL solution containing 1.7 M KSCN, 0.8 M $\text{NaOOCCH}_3/\text{HOOCCH}_3$ buffer and 40 μL ^{60}Co tracer solution and kept mixing at 5°C for ten days. Approximately 99% of the ^{60}Co was measured to be extracted by the foam under these conditions but no visible blue or green colour developed. Comparison with the colours developed by other 100 μg foam pieces placed in solutions containing known quantities of inactive cobalt and treated in an identical manner placed the cobalt content in the tracer at definitely less than 30 ng which would give at

most a 3.4×10^{-9} M solution when diluted to 150 mL. The estimated value of 1.7×10^{-10} M is therefore not unreasonable and this value has been used in all calculations.

The data of Table II-10 appear graphically in Figure 2-14 ($\log D$ versus $\log [\text{Co}]_{\text{aq}}$) and again in a slightly different form in Figure 2-15 ($\log [\text{Co}]_{\text{f}}$ versus $\log [\text{Co}]_{\text{aq}}$). Both presentations are, in fact, equivalent but each makes easier the portrayal of a particular property of the results. The latter form is more traditional in the solvent extraction literature.

From Figure 2-14 we see that the distribution ratio, D , is markedly affected by thiocyanate concentration (as expected from the previous investigation) but the fraction of cobalt extracted is essentially independent (slope = 0) of the amount of cobalt present at low concentrations. Moreover, at the other extreme, where the concentration of cobalt is high, a line of slope near to -1.0 is approached indicating that nearly all additional cobalt added is remaining in the aqueous phase. In Figure 2-15, these same two features translate respectively into a long linear stretch in which the slope is very near to 1.0 and another for which the slope tends to zero as a maximum concentration of cobalt in foam is approached. Further interpretation of these results will be made later.

To determine the capacity of #1338 BFG polyurethane foam for cobalt extraction, the sorption data presented in Table II-11 were used. Here, we see that in many cases measurable increases in the amount of cobalt held by the polyurethane were still recorded between 12 and 36 hours after initial contact with the solution. For this reason, the values for 48 hours equilibration are likely the most reliable for the determina-

tion of the actual foam capacity. It will be noted from consideration of these values alone that even at the highest cobalt concentrations used in Experiment 1, the resulting concentration of cobalt on foam continues to increase as that in solution increases. It is apparent, therefore, that the capacity of the foam has not yet been reached in this instance. On the other hand, in Experiment 2 we have identical (within experimental uncertainty) values of $[Co]_f$ for three successively higher $[Co]_{aq}$ and so we conclude that the foam capacity under these conditions is about 0.47 moles of cobalt per kilogram of foam. This value is far in excess of what one would expect for an adsorption (surface) phenomenon. The surface area of a typical polyurethane foam (type "A", supplied by Union Carbide) has been measured by the B.E.T. method using krypton gas and reported by Horsfall⁽⁴²⁾ to be $81 \text{ m}^2 \text{ kg}^{-1}$. If this value is somewhat representative of #1338 BFG polyurethane as well, this would leave an area of only $(81 \text{ m}^2 \text{ kg}^{-1}) / (0.47 \text{ mol kg}^{-1}) (6.02 \times 10^{23} \text{ ions mol}^{-1}) = 2.9 \times 10^{-22} \text{ m}^2$ for each of the cobalt-containing species whereas the cross-sectional area of a Co^{2+} ion alone is about $1.63 \times 10^{-20} \text{ m}^2$.⁽²²⁶⁾ This clearly demonstrates that the entire bulk of the polymer must be involved in the sorption of cobalt much as for a conventional solvent extraction or ion exchange process.

Now, we may infer the value of the subscript, y, in the supposed general extractable species, $M_x Co_y (SCN)_z$, by returning to the results of Table II-10 and Figures 2-14 and 2-15.

As in previous treatments, if a solvent extraction-like mechanism is assumed, one may envision the extracted species as being initially formed in the aqueous phase and then transferred to the foam phase as

unassociated ions which may subsequently become associated or "paired":

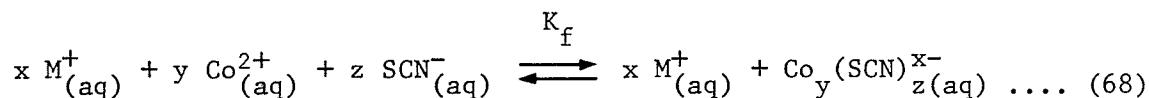

$$K_f = \frac{[Co_y(SCN)_z^{x-}]_{aq}}{[Co^{2+}]^y_{aq} [SCN^-]^z_{aq}} \dots (69)$$

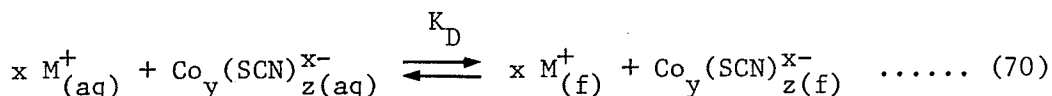

$$K_D = \frac{[M^+]^x_f [Co_y(SCN)_z^{x-}]_f}{[M^+]^x_{aq} [Co_y(SCN)_z^{x-}]_{aq}} \dots (71)$$

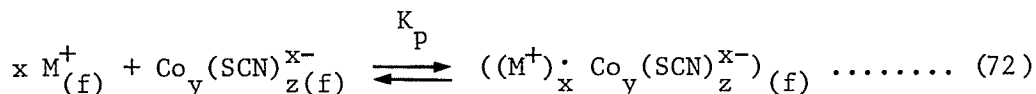

$$K_p = \frac{[(M^+)_x Co_y(SCN)_z^{x-}]_f}{[M^+]^x_f [Co_y(SCN)_z^{x-}]_f} \dots (73)$$

As before, the concentrations of the two possible foam cobalt species, $Co_y(SCN)_z^{x-}_{(f)}$ and $((M^+)_x Co_y(SCN)_z^{x-})_{(f)}$, are then given by:

$$[Co_y(SCN)_z^{x-}]_f = K_f K_D [M^+]^x_{aq} [Co^{2+}]^y_{aq} [SCN^-]^z_{aq} [M^+]^{-x}_f \dots (74)$$

$$[(M^+)_x Co_y(SCN)_z^{x-}]_f = K_f K_D K_p [M^+]^x_{aq} [Co^{2+}]^y_{aq} [SCN^-]^z_{aq} \dots (75)$$

where M^+ is assumed to be any of a number of available cations. As usual,

species identified with the subscripts "aq" and "f" belong to the aqueous or foam phases, respectively, and K_f , K_D and K_p are the equilibrium constants for the formation, distribution and ion pairing of the extractable species. It should be recalled also that all such equilibrium constants are being approximated by the use of concentrations rather than activities for convenience since several of the necessary activity coefficients will not be known.

The distribution ratio, D, is defined to be

$$D = \frac{[\text{cobalt in all forms}]_f}{[\text{cobalt in all forms}]_{aq}} = \frac{[\text{Co}]_f}{[\text{Co}]_{aq}} \dots\dots\dots (76)$$

Now, assuming the only two cobalt-containing species in the foam phase to be $(\text{Co}_y(\text{SCN})_z^{x-})_f$ and $((\text{M}^+)_x \text{Co}_y(\text{SCN})_z^{x-})_f$, then we have:

$$D = \frac{[\text{Co}_y(\text{SCN})_z^{x-}]_f + [(\text{M}^+)_x \text{Co}_y(\text{SCN})_z^{x-}]_f}{[\text{Co}]_{aq}} \dots\dots\dots (77)$$

$$= \frac{K_f K_D [\text{M}^+]_{aq}^x [\text{Co}^{2+}]_{aq}^y [\text{SCN}^-]_{aq}^z ([\text{M}^+]_f^{-x} + K_p)}{[\text{Co}]_{aq}} \dots\dots\dots (78)$$

In producing an expression for the total concentration of cobalt species in the aqueous phase, $[\text{Co}]_{aq}$, we are faced with the problem that several ligands are present (SCN^- , Cl^- , CH_3COO^- and, of course, H_2O but we will omit it from our treatment knowing that it will generally fill any coordination vacancies). A multitude of solution complexes are thus possible containing various numbers of each available ligand, however, we

may write the general equation for the formation of each of the species as:

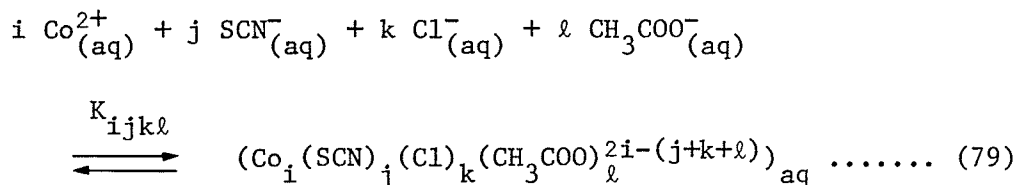

$$K_{ijkl} = \frac{[\text{Co}_i(\text{SCN})_j(\text{Cl})_k(\text{CH}_3\text{COO})_{\ell}^{2i-(j+k+\ell)}]_{\text{aq}}}{[\text{Co}^{2+}]_{\text{aq}}^i [\text{SCN}^{-}]_{\text{aq}}^j [\text{Cl}^{-}]_{\text{aq}}^k [\text{CH}_3\text{COO}^{-}]_{\text{aq}}^{\ell}} \dots\dots (80)$$

The integers j, k and ℓ may theoretically assume any whole number values including zero but we insist that i be greater than zero since we are concerned with cobalt-containing species. In the event that the cobalt concentration in solution is very low (e.g. 10⁻¹⁰ to 10⁻⁵ M as it is in most of this experiment), then polynuclear cobalt species (i.e. those with i = 2, 3, etc.) are expected to be extremely rare and can likely be neglected entirely. If this is done, we are left with a series of mononuclear cobalt complexes (with i = 1) of the form (Co(SCN)_j(Cl)_k(CH₃COO)_ℓ^{2-(j+k+ℓ)})_{aq} and with overall formation constants, K_{jkℓ}, given according to equation (80). Thus, we may describe the total concentration of cobalt in the aqueous phase as:

$$[\text{Co}]_{\text{aq}} = \sum_{jk\ell} K_{jk\ell} [\text{Co}^{2+}]_{\text{aq}} [\text{SCN}^{-}]_{\text{aq}}^j [\text{Cl}^{-}]_{\text{aq}}^k [\text{CH}_3\text{COO}^{-}]_{\text{aq}}^{\ell} \\ = [\text{Co}^{2+}]_{\text{aq}} \sum_{jk\ell} K_{jk\ell} [\text{SCN}^{-}]_{\text{aq}}^j [\text{Cl}^{-}]_{\text{aq}}^k [\text{CH}_3\text{COO}^{-}]_{\text{aq}}^{\ell} \dots\dots (81)$$

Equation (81) can be solved instead for $[\text{Co}^{2+}]_{\text{aq}}$ to give:

$$[\text{Co}^{2+}]_{\text{aq}} = [\text{Co}]_{\text{aq}} \left(\sum_{jkl} K_{jkl} [\text{SCN}^-]_{\text{aq}}^j [\text{Cl}^-]_{\text{aq}}^k [\text{CH}_3\text{COO}^-]_{\text{aq}}^l \right)^{-1} \dots\dots (82)$$

We may now substitute this result into expression (78) describing the distribution ratio, D:

$$D = \frac{K_f K_D [\text{M}^+]_{\text{aq}}^x [\text{Co}]_{\text{aq}}^{(y-1)} [\text{SCN}^-]_{\text{aq}}^z ([\text{M}^+]_{\text{f}}^{-x} + K_p)}{\left(\sum_{jkl} K_{jkl} [\text{SCN}^-]_{\text{aq}}^j [\text{Cl}^-]_{\text{aq}}^k [\text{CH}_3\text{COO}^-]_{\text{aq}}^l \right)^y} \dots\dots (83)$$

Now, if we effectively keep $[\text{M}^+]_{\text{aq}}$, $[\text{SCN}^-]_{\text{aq}}$, $[\text{Cl}^-]_{\text{aq}}$ and $[\text{CH}_3\text{COO}^-]_{\text{aq}}$ constant as we do in this experiment (the concentration of cobalt present is always less than 1.7×10^{-3} M whereas $[\text{SCN}^-]_{\text{aq}} = 0.10$ M and other concentrations are all much larger), then the term in the denominator in equation (83) is also a constant and we may combine a number of constants into a single one, K:

$$K = K_f K_D [\text{M}^+]_{\text{aq}}^x [\text{SCN}^-]_{\text{aq}}^z \left(\sum_{jkl} K_{jkl} [\text{SCN}^-]_{\text{aq}}^j [\text{Cl}^-]_{\text{aq}}^k [\text{CH}_3\text{COO}^-]_{\text{aq}}^l \right)^{-y} \dots\dots\dots (84)$$

Thus, the distribution ratio will be given by:

$$D = K [\text{Co}]_{\text{aq}}^{(y-1)} ([\text{M}^+]_{\text{f}}^{-x} + K_p) \dots\dots\dots (85)$$

As discussed in an earlier experiment, the value of D will depend upon the relative abundances of unassociated (governed by $[\text{M}^+]_{\text{f}}^{-x}$) and

paired (governed by K_p) species in the foam. Considering first the situation in which paired $((M^+)_x Co_y (SCN)_z^{x-})_f$ species predominate, the $[M^+]_f^{-x}$ term in equation (85) may be neglected and D then becomes:

$$D \approx K [Co]_{aq}^{(y-1)} K_p = K' [Co]_{aq}^{(y-1)} \dots\dots\dots (86)$$

where the two constants, K and K_p , have been combined into a single constant, K' . Taking logs, we get:

$$\log D = \log K' + (y-1) \log [Co]_{aq} \dots\dots\dots (87)$$

from which it is apparent that a plot of log D versus log $[Co]_{aq}$ would give a straight line of slope (y-1) if all of the assumptions were correct. Consideration of Figure 2-14 shows that at low aqueous cobalt concentrations the experimental slope is zero so that we deduce that (y-1) = 0 or y = 1 under these conditions. Combining this result with the previous discovery that z = 4 and the supposition that no oxidation or reduction takes place on extraction, we may then identify the major extracted species as $((M^+)_2 Co(SCN)_4^{2-})_f$ if it is largely paired.

On the other hand, if the cobalt species in the polyurethane is largely unassociated and exists, therefore, primarily as $(xM^+_{(f)} + Co_y (SCN)_{z(f)}^{x-})$ then the K_p term in equation (85) may be neglected and we have:

$$D \approx K [Co]_{aq}^{(y-1)} [M^+]_f^{-x} \dots\dots\dots (88)$$

so,

$$\log D \approx \log K + (y-1) \log [\text{Co}]_{\text{aq}} - x \log [\text{M}^+]_{\text{f}} \dots\dots\dots (89)$$

This equation can only yield a straight line if $[\text{M}^+]_{\text{f}}$ is essentially constant and independent of $[\text{Co}]_{\text{aq}}$ (e.g. if other sources of $\text{M}^+_{(\text{f})}$ such as $\text{M}^+_{(\text{f})} + \text{SCN}^-_{(\text{f})}$ or $\text{M}^+_{(\text{f})} + \text{OOCCH}_3^-_{(\text{f})}$ account for nearly all $\text{M}^+_{(\text{f})}$) or if $[\text{M}^+]_{\text{f}}$ is directly proportional to some power, p, of $[\text{Co}]_{\text{aq}}$. In the first instance, the term $x \log [\text{M}^+]_{\text{f}}$ in equation (89) is another constant and again a line of slope (y-1) is expected (which leads to the conclusion that $y = 1$). In the second instance, we have a relation between $[\text{M}^+]_{\text{f}}$ and $[\text{Co}]_{\text{aq}}$ of the type:

$$[\text{M}^+]_{\text{f}} = k [\text{Co}]_{\text{aq}}^p \dots\dots\dots (90)$$

where k is some constant. Thus:

$$\begin{aligned} \log D &\approx \log K + (y-1) \log [\text{Co}]_{\text{aq}} - px \log [\text{Co}]_{\text{aq}} - x \log k \\ &= \log K'' + (y-1-px) \log [\text{Co}]_{\text{aq}} \dots\dots\dots (91) \end{aligned}$$

where we have grouped together several constants into K'' . The value of p can then be determined by use of information already available. Since experimentally we observe from Figure 2-14 that the plot of log D versus $\log [\text{Co}]_{\text{aq}}$ has a slope of zero at low $[\text{Co}]_{\text{aq}}$, we may write:

$$(y-1-px) = 0 \dots\dots\dots (92)$$

Also, if we assume that no oxidation or reduction takes place on extraction (to be demonstrated later), then the requirement of electroneutrality of the extracted species dicates that:

$$x + 2y - z = 0 \quad \dots\dots\dots (93)$$

and we may now include in this the previous result that $z = 4$ to give:

$$x + 2y - 4 = 0 \quad \dots\dots\dots (94)$$

Both x and y must have positive integral values but from equation (94) we see that this will be possible only if $y = 1$ and $x = 2$ or if $y = 2$ and $x = 0$. Taking these two possibilities in turn and solving for p from equation (92) we obtain in the first case $p = 0$ and in the second there is no value of p for which the equation is true. Thus, we must have $p = 0$ and so we conclude that $[M^+]_f$ is not dependent on $[Co]_{aq}$ when the chief sorbed species are unassociated ions of the form $x M_{(f)}^+ + Co_y(SCN)_{z(f)}^{x-}$. Equation (91) then reduces to:

$$\begin{aligned} \log D &= \log K'' + (y-1-px) \log [Co]_{aq} \\ &= \log K'' + (y-1) \log [Co]_{aq} \quad \dots\dots\dots (95) \end{aligned}$$

and again we deduce that $(y-1) = 0$ and therefore that $y = 1$. Thus, consistent with later observations, if extraction takes place by a solvent extraction-like mechanism, the extractable species appears to have the form $M_2Co(SCN)_4$. In deriving this result we have assumed

that neither oxidation nor reduction takes place on extraction and apparently we cannot distinguish between unassociated and paired species in the foam.

However, if an anion exchange-like extraction mechanism is supposed, then we have slightly different relations. The solution equilibria, of course, are identical with those already presented but the distribution equilibrium is represented as:

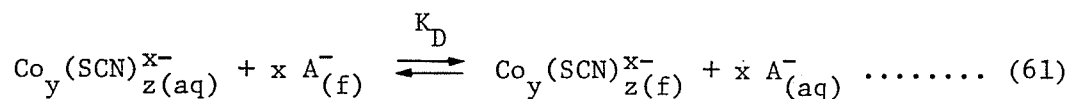

$$K_D = \frac{[\text{Co}_y (\text{SCN})_z^{x-}]_f [\text{A}^-]_{\text{aq}}^x}{[\text{Co}_y (\text{SCN})_z^{x-}]_{\text{aq}} [\text{A}^-]_f^x} \dots\dots\dots (62)$$

where A⁻ is some unspecified anion (SCN⁻, Cl⁻ or CH₃COO⁻) and we are not concerning ourselves with whether or not the anions are strongly associated with the various cationic sites. We have previously obtained the expression for the distribution ratio, D, as:

$$D = \frac{K_f K_D [\text{Co}^{2+}]_{\text{aq}}^y [\text{SCN}^-]_{\text{aq}}^z [\text{A}^-]_f^x}{[\text{Co}]_{\text{aq}} [\text{A}^-]_{\text{aq}}^x} \dots\dots\dots (64)$$

Now, using the recently-derived expression (92) for [Co²⁺]_{aq} and substituting into equation (64) gives:

$$D = \frac{K_f K_D [\text{SCN}^-]_{\text{aq}}^z [\text{A}^-]_f^x}{(\sum_{jkl} K_{jkl} [\text{SCN}^-]_{\text{aq}}^j [\text{Cl}^-]_{\text{aq}}^k [\text{CH}_3\text{COO}^-]_{\text{aq}}^l)^y [\text{A}^-]_{\text{aq}}^x} \dots\dots\dots (96)$$

Most of the parameters in equation (96) are independent of cobalt concentration when the $[\text{SCN}^-]_{\text{aq}}$, $[\text{Cl}^-]_{\text{aq}}$ and $[\text{CH}_3\text{COO}^-]_{\text{aq}}$ are large and constant. In particular, the quantity $[\text{A}^-]_{\text{aq}}$ will be simply one or a mixture of the three available anion concentrations. Also, if we specify that insufficient cobalt is sorbed from solution to displace an appreciable fraction of the $\text{A}^-_{(\text{f})}$ ions (i.e. we will not consider situations in which we are near saturation of the foam) then $[\text{A}^-]_{\text{f}}$ is also a constant and we may group many terms into the single constant, K:

$$K = \frac{K_f K_D [\text{SCN}^-]_{\text{aq}}^z [\text{A}^-]_{\text{f}}^x}{(\sum_{jkl} K_{jkl} [\text{SCN}^-]_{\text{aq}}^j [\text{Cl}^-]_{\text{aq}}^k [\text{CH}_3\text{COO}^-]_{\text{aq}}^l)^y [\text{A}^-]_{\text{aq}}^x} \quad \dots\dots (97)$$

Thus, under these conditions,

$$D = K [\text{Co}]_{\text{aq}}^{(y-1)}$$

and

$$\log D = \log K + (y-1) \log [\text{Co}]_{\text{aq}} \quad \dots\dots\dots (98)$$

This result again demonstrates that the observed slope of zero for the $\log D$ versus $\log [\text{Co}]_{\text{aq}}$ plot necessitates that $y=1$. We conclude that the species extracted by an anion exchange type of mechanism must be $\text{Co}(\text{SCN})_4^{2-}$.

Having established the most likely chief extractable species by either mechanism, some consideration should now be given to relatively minor but nevertheless reproducible aberrations visible in Figures 2-14 and 2-15. In the case of Experiment 1 (0.10 M NaSCN), it will be noted

from Figure 2-14 that the distribution ratio, D , begins to increase somewhat (about 25%) with increasing cobalt concentration immediately before the saturation limit is approached whereas the same type of phenomenon does not appear to be visible in Experiment 2 (0.25 M NaSCN). Figure 2-15 shows the same trends as a very slight positive deviation from a slope of 1.00 at high $[\text{Co}]_{\text{aq}}$ in one case but not in the other. Since when repeated on another occasion the region of cobalt concentrations in question in Experiment 1 gave identical results, the observation apparently has some definite physical significance and so an effort was made to seek a plausible explanation.

A number of possible rationalizations exist to explain the origin of such an increase and they may be roughly divided into changes caused by equilibrium shifts occurring in either the aqueous or the foam phase. In the aqueous phase, increases in distribution ratio can be caused either by the formation of another new extractable cobalt-containing species or by a shift in the equilibrium which governs the production of $\text{M}_2\text{Co}(\text{SCN})_4$ or $\text{Co}(\text{SCN})_4^{2-}$. If a new extractable species is being formed, its production must be sensitive to cobalt concentration and so must contain 2 or more cobalt atoms. From Figure 2-14, we see that the phenomenon becomes visible for 0.10 M NaSCN when the solution cobalt concentration is something less than 10^{-5} M. At this low concentration, the production of any significant quantity of dinuclear or trinuclear cobalt species seems very unlikely and we may effectively rule out this possibility. Similarly, since the total ion picture of the solution can change so little by the addition of 10^{-5} M Co^{2+} to the 0.1 M NaSCN, 1.9 M NaCl and 1.0 M buffer present, the possibility of significantly alter-

ing the solution equilibria for the formation of $M_2Co(SCN)_4$ or $Co(SCN)_4^{2-}$ by solution activity changes or any other means also seems very unlikely.

Turning to events within the foam phase which may be expected to increase the extraction of cobalt, it is true that any phenomenon which will lower the activity coefficient of the major extracted species in the foam, increase the number of sites available, or shift some of the cobalt atoms into foam-soluble forms other than the originally predominant one can result in an increase in D. In the first of these cases, the value of the "constants" K_D as expressed in concentration units rather than activities will increase thus increasing D (see equations (71) and (62)). In the second case, D will also increase as a result of the greater holding power provided by generating new sites at which sorption may occur. In the third case, D will again increase since the original equilibrium between $2 M_{(aq)}^+ + Co(SCN)_4^{2-}_{(aq)}$ in the aqueous phase and either $2 M_{(f)}^+ + Co(SCN)_4^{2-}_{(f)}$, $((M^+)_2 Co(SCN)_4^{2-})_{(f)}$ or $2(M \cdot site)_{(f)}^+ + Co(SCN)_4^{2-}_{(f)}$ in the foam phase will shift to maintain a constant ratio between the aqueous and foam concentrations of these forms while other foam cobalt species are added to the total number.

Considering first possible reasons for changes to the activity coefficient of $2 M_{(f)}^+ + Co(SCN)_4^{2-}_{(f)}$, $((M^+)_2 Co(SCN)_4^{2-})_{(f)}$ or $2(M \cdot site)_{(f)}^+ + Co(SCN)_4^{2-}_{(f)}$ in the foam, it is possible that the sorbed cobalt species sufficiently alter the dielectric constant or other physical properties of the polyurethane such that its affinity for additional cobalt species is increased. Consideration of the results in Figure 2-15 (or Table II-10) shows that the increase observed in extraction begins when the concentration of cobalt on foam is approximately 0.03 mol kg^{-1} . It is not impos-

sible that this fairly low concentration of sorbed species may produce sufficient alterations to the polyurethane bulk as a whole or between species to account for the observed increases in D. However, if the changes in properties are due to the sorbed cobalt-containing species alone, one should expect to see a similar fractional increase in D at the same foam cobalt concentration from 0.25 M NaSCN as well. The fact that none is visible suggests either that such interactions are not the answer to the problem or that NaSCN itself is also actively involved in some way.

This second situation could plausibly arise, for example, if NaSCN should also be significantly sorbed and if it produces similar property changes (e.g. to the polarity of the medium). In this case the effects of the cobalt-containing species may then be overshadowed by the increased NaSCN present at higher concentration. It is not known whether or not this is indeed the case although measurements of weight gains by foam in the presence of high and low concentrations of thiocyanate do suggest that SCN^- is much better sorbed than Cl^- or CH_3COO^- .

In some ways closely related to the concept of activity changes bringing about increases in D is the idea that the presence of sorbed substances in the polymer may result in its swelling so as to expose more sites (i.e. increase the capacity) at which chelation or exchange may take place. Such physical swelling phenomena are well known for ion exchange resins but of course would be much more difficult to observe for polymers in the form of a foam. Organic solvents, on the other hand, cannot really be considered in these terms and so one is limited to the less descriptive concept of activity in these cases. Again, as for the suggested change in activity coefficients, to explain the lack of increase in D at higher thiocyanate concentration, we must assume that

NaSCN is also significantly sorbed and that it also produces the same sort of swelling.

This brings us, then, to consideration of other cobalt-containing species in polyurethane foam formed in significant numbers at higher cobalt concentrations or a shift from one form only to more than one. The extraction of cobalt and thus D might be increased by new forms generated either by association or by dissociation of the $2 M_{(f)}^+ + Co(SCN)_{4(f)}^{2-}$, $((M^+)_2 \cdot Co(SCN)_4^{2-})_{(f)}$ or $2(M \cdot site)_{(f)}^+ + Co(SCN)_{4(f)}^{2-}$ species. However, it is difficult to imagine what true dissociation might be expected to increase as the quantity of cobalt present on the foam increases so we are forced to direct our attention towards possible association mechanisms.

One possible mechanism which seems to fit the available data involves the formation of a type of dinuclear cobalt species from the paired precursor as viewed in a solvent extraction-like process in the following manner:

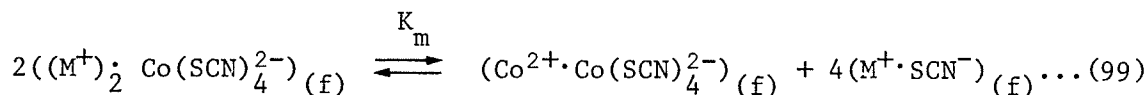

$$K_m = \frac{[Co^{2+} \cdot Co(SCN)_{4}^{2-}]_f [M^+ \cdot SCN^-]_f^4}{[(M^+)_{2} Co(SCN)_{4}^{2-}]_f^2} \dots \dots \dots (100)$$

Here, a cobalt ion, Co^{2+} , has been formed by dissociation of one of the cobalt thiocyanate species to act as the counter ion for the other and all ions are presumed to be paired. The reason for portraying the new cobalt species, $(Co^{2+} \cdot Co(SCN)_{4}^{2-})_{(f)}$, as an ion pair of this type

rather than simply as $\text{Co}_2(\text{SCN})_4$ will become apparent later when discussing the Cation Chelation Mechanism in more detail. Some of the $(\text{M}^+\cdot\text{SCN}^-)_{(f)}$ pairs thus produced may then be expected to be returned to the aqueous phase as aquated ions:

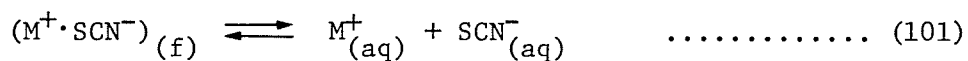

An important consequence of the mechanism proposed by equations (99) and (101) is that we predict from them that increases in either $[\text{M}^+]_{aq}$ or $[\text{SCN}^-]_{aq}$ in solution should suppress the formation of the dinuclear cobalt species. Although no test was made of the effect of sodium ion (M^+) concentration on the appearance of this phenomenon, the fact that no increase in D at high cobalt concentration is observed for 0.25 M while it is for 0.10 M thiocyanate in this experiment supports the suggested mechanism. Obviously, however, this does not constitute a proof since there are other explanations as well and we must regard this one only as a possible model without definite knowledge of its correctness.

Based on the results of this experiment which show that the identity of the extractable species is apparently unchanged in 0.10 M NaSCN up to at least 7×10^{-6} M cobalt but may involve other species at higher concentrations, the solution cobalt concentration of most other experiments performed was fixed at 1.7×10^{-6} M (0.10 ppm) to avoid any resulting complications.

Apart from the many mechanistic implications arising out of the data from this experiment, there are also several pieces of more practical information important to the potential analytical or industrial uses

of polyurethane foam. First of all, it is apparent from Figure 2-14 that the extent of cobalt extraction does not decrease even at very low solution cobalt concentrations. This fact makes polyurethane foam and thiocyanate useful either for the preconcentration of very low levels of cobalt prior to some method of analysis or for the complete recovery of cobalt from radioactive wastes or spills. Additionally, since the distribution ratio remains constant over such a wide range up to near the capacity of the foam, reasonably symmetrical elution peaks are expected when used in column chromatography. A second important note to be made is the relatively high capacity of polyurethane foam (0.47 moles of $\text{Co}(\text{SCN})_4^{2-}$ and therefore 0.94 moles of Na^+ per kilogram of foam). This capacity is in the same order of magnitude as many commercially available ion exchange resins and its cost is competitive. Finally, it has been demonstrated in this experiment that it is possible to use both the characteristic intense green to blue colour of the foam cobalt thiocyanate complex and the high extraction efficiencies possible to determine very small amounts of cobalt (in the nanogram range) semi-quantitatively with small pieces of foam. There appears to be some interference from iron in this application but only insofar as the red-brown colour of its own thiocyanate complex masks that of very small amounts of cobalt. Although it was not attempted, this problem could likely be overcome by including a masking agent for iron such as fluoride along with the thiocyanate.

6. Effect of Aqueous/Foam Phase Ratio on Cobalt Sorption from Thiocyanate Solution

To test the assumption that the distribution ratio, D , is indeed a constant which does not depend upon the relative amounts of solution and foam present, an experiment was devised to determine D over a wide range of aqueous/foam $\left(\frac{V}{W}\right)$ phase ratios. Since the available equipment did not allow major alterations to be made in the aqueous volume (volumes less than about 120 mL result in splashing in the distribution cells when operating), this parameter was held constant while large changes were made in the weight of foam used.

An initial experiment designed to accomplish this task using 0.05 M KSCN, 1.95 M KCl, 1.00 M NaOOCCH₃/HOOCCH₃ buffer and 0.10 ppm Co(II) at a temperature of 22°C appeared to show that D increased moderately (about 40%) as the weight of foam was decreased from about 1000 mg to 4 mg and then apparently fell again as only 1 mg was approached. The curiousness of this result and the fact that temperature control and other procedures were later greatly improved prompted repetition of the experiment with some changes to see if this was indeed correct.

The initial solution conditions chosen for the experiment are listed at the top of Table II-12. To ensure that only foam weights differed between individual distribution cells, a 2 liter quantity of stock solution was prepared by admixture of the various individual stock solution or solids to contain 0.10 M NaSCN, 0.88 M NaOOCCH₃/1.00 M HOOCCH₃ buffer, 1.90 M NaCl, 0.10 ppm Co(II) and sufficient ⁶⁰Co tracer to yield a count rate of about 1000 seconds⁻¹ when measured in the usual manner.

Identical 150.0 mL portions of this stock solution were then transferred into ten distribution cells using a single 150 mL volumetric flask.

Various sized pieces of #1338 BFG polyurethane foam ranging in weight from 1 to 1000 mg were cut from a single cube of the material and were cleaned before use in the usual manner. Since the problem of static charge buildup was particularly serious for the smallest foam pieces, they were all allowed to sit in contact with a grounded metal container for a full day prior to weighing. Weights were determined on a Sartorius microbalance to the nearest microgram with an uncertainty determined on another occasion to be about ± 5 micrograms (95% confidence).

Weighed foam pieces were placed in the distribution cells containing 150.0 mL of stock solution which were then mounted in the thermostatted cabinet at 25.00°C. It was necessary to squeeze the smallest foams several times by hand prior to mechanical squeezing since they were able to escape around the edges of the plunger and would float on the solution surface without squeezing if the air bubbles trapped inside were not initially forced out. Once this was done, the smaller foam pieces tumbled normally through the solution during the experiment but, of course, were not as effectively squeezed as were the larger ones.

The distribution cells were sealed as described previously with single condoms and silicone grease on the joints to retard evaporation. A 48 hour equilibration period was adopted since it was suspected that the smallest foam pieces might be slow in achieving equilibrium. Solution samples were withdrawn for ten consecutive 100 second counting periods in the usual manner after 6, 12, 24, 36 and 48 hours. Radiometric backgrounds to be subtracted were evaluated by a similar procedure for each

individual counting tube used. However, no corrections for possible drift in the spectrometer sensitivity were made in this experiment.

During the course of the squeezing, a variety of foam colours developed ranging from a green shade of yellow for the largest foam pieces to pale green for the smallest ones. These shade differences appeared to parallel the concentration of cobalt which was subsequently calculated to be present on the foam. Another important observation made was that large foam pieces showed small continual decreases in solution activity (even up to 48 hours) while the smallest one, on the other hand, showed pronounced increases instead as time passed. A possible explanation for this peculiar phenomenon will be discussed shortly.

The results of the experiment appear in Table II-12 where the calculated percentage of cobalt extracted and distribution ratio are given for each of the foam weights used. Although measurements were made after 6, 12, 24, 36 and 48 hours, only data for 12, 24 and 36 hours are included in the Table since they are sufficient to demonstrate the trends observed with increasing equilibration time. The data are also plotted in Figure 2-16 as the relation between the distribution ratio, D , and the logarithm of the ratio of the quantities of the two phases present. As for other experiments, the uncertainties shown in Table II-12 and the error bars in Figure 2-16 represent the 95% confidence intervals of the mean as calculated chiefly from counting statistics with estimates of foam weight and solution volume uncertainties included when significant. We can see from the calculated uncertainties that the most reliable data are obtained for middle foam weights while much larger errors are seen on either side of this.

From the Table and Figure, it appears that D remains nearly constant

Figure 2-16

Effect of ratio $\frac{V}{W}$ of phases (aqueous:foam) on cobalt sorption from aqueous solution by #1338 BFG polyurethane foam. The aqueous phase volume was held constant at $V = 150.0$ mL while the foam weight, W , was varied.

Initial solution conditions were as follows:

1.7×10^{-6} M (0.10 ppm) Co(II)

0.10 M NaSCN

1.90 M NaCl

0.88 M NaOOCCH_3 /1.00 M HOOCCH_3 buffer, pH 4.7

2.88 M total ionic strength

25.00°C

Notes:

○ 12 hours equilibration

□ 24 hours equilibration

△ 36 hours equilibration

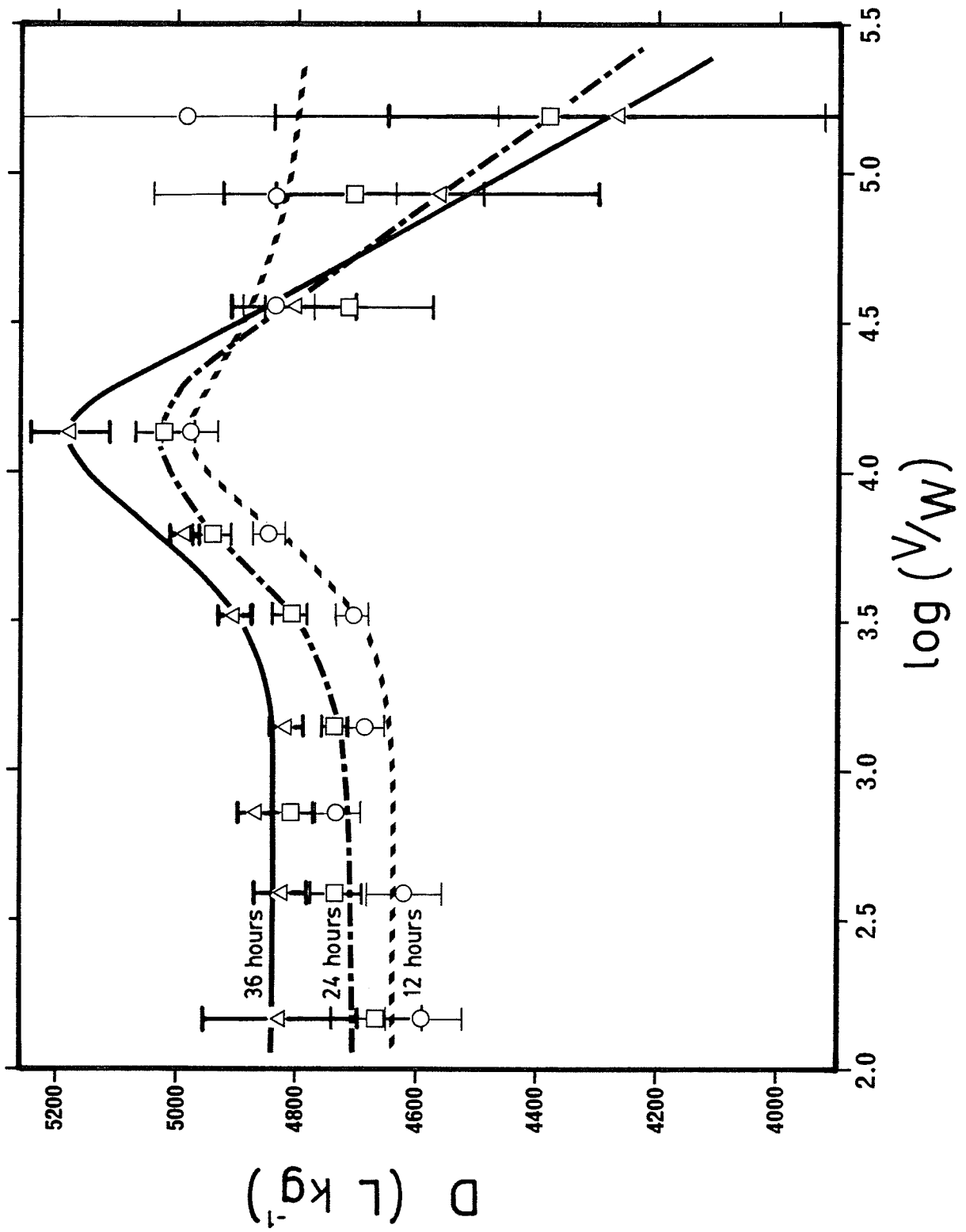

(considering that we are looking at a 1000-fold alteration of foam weight) but some complicated changes are also visible. In particular, as already mentioned, cells with large foam pieces (and therefore little cobalt left in solution) show steady increases in D with time whereas cells with small foam pieces (and therefore most cobalt left in solution) display large decreases in D with increasing time. Since this was evidently a time dependent phenomenon, it was suspected that it may be caused by losses of solvent (water) through evaporation but this conjecture will be more convincing when supported by a little mathematical modelling as follows.

Suppose first that in the absence of any solvent loss a volume of V° mL of solution containing $[\text{SCN}^-]^\circ$ mol L^{-1} of thiocyanate ion and having an initial ^{60}Co count rate of A_{initial} is brought into contact with W grams of polyurethane foam. After sorption has taken place and equilibrium is approached, the new solution activity will be some value, A° , from which we may calculate the distribution ratio as:

$$D^\circ = \frac{[\text{Co}]_f}{[\text{Co}]_{\text{aq}}} = \frac{(A_{\text{initial}}V^\circ - A^\circ V^\circ)/W}{A^\circ}$$

$$= \frac{(A_{\text{initial}} - A^\circ)V^\circ}{A^\circ W} \dots\dots\dots (102)$$

On the other hand, if some loss of solvent, ΔV mL, now occurs, the new solution volume will be:

$$V' = V^\circ - \Delta V \dots\dots\dots (103)$$

and the thiocyanate concentration (assuming essentially all of it remains in the aqueous phase) will now be increased to:

$$[\text{SCN}^-]' = [\text{SCN}^-]^\circ \left(\frac{V^\circ}{V'} \right) = [\text{SCN}^-]^\circ \left(\frac{V^\circ}{V^\circ - \Delta V} \right) \dots\dots\dots (104)$$

If the thiocyanate concentration is fairly low (as it is in this and other experiments) and no other parameter which is important to the magnitude of D changes, then we have seen that D is directly proportional to $[\text{SCN}^-]^4$. Therefore, we expect that the increase in thiocyanate concentration will result in an increase in the actual distribution ratio under these circumstances to a new value, D', given by:

$$D' = D^\circ \left(\frac{[\text{SCN}^-]'}{[\text{SCN}^-]^\circ} \right)^4 = D^\circ \left(\frac{V^\circ}{V^\circ - \Delta V} \right)^4 \dots\dots\dots (105)$$

When equilibrium is again established, this change will result in some new solution count rate, A', being measured. The value of A' will have to be such that it satisfies the new distribution ratio expression:

$$\begin{aligned} D' = \frac{[\text{Co}]_f}{[\text{Co}]_{\text{aq}}} &= \frac{\left(\begin{array}{l} \text{total moles of Co} \\ \text{initially present} \end{array} - \begin{array}{l} \text{moles of Co remaining} \\ \text{in solution} \end{array} \right) / W}{[\text{Co}]_{\text{aq}}} \\ &= \frac{A_{\text{initial}} V^\circ - A'(V^\circ - \Delta V)}{A'W} \dots\dots\dots (106) \end{aligned}$$

Combining equations (105 and (106) and solving for A', then, we get:

$$D' = D^\circ \left(\frac{V^\circ}{V^\circ - \Delta V} \right)^4 = \frac{A_{\text{initial}} V^\circ - A'(V^\circ - \Delta V)}{A'W}$$

so,

$$A' = \frac{A_{\text{initial}} V^{\circ}}{D^{\circ} W \left(\frac{V^{\circ}}{V^{\circ} - \Delta V} \right)^4 + (V^{\circ} - \Delta V)} \dots\dots\dots (107)$$

Now, since we are ignorant of the change in solution volume, we do not calculate D' directly but instead mistakenly calculate an apparent distribution ratio, D_{apparent}, simply from the measured initial (A_{initial}) and final (A') count rates and unaltered solution volume, V^o, as:

$$D_{\text{apparent}} = \frac{(A_{\text{initial}} - A') V^{\circ}}{A' W} \dots\dots\dots (108)$$

Substituting the result of equation (107) into (108) gives:

$$D_{\text{apparent}} = \frac{\left(A_{\text{initial}} - \frac{A_{\text{initial}} V^{\circ}}{D^{\circ} W \left(\frac{V^{\circ}}{V^{\circ} - \Delta V} \right)^4 + (V^{\circ} - \Delta V)} \right) V^{\circ}}{\left(\frac{A_{\text{initial}} V^{\circ}}{D^{\circ} W \left(\frac{V^{\circ}}{V^{\circ} - \Delta V} \right)^4 + (V^{\circ} - \Delta V)} \right) W}$$

which eventually reduces to:

$$D_{\text{apparent}} = D^{\circ} \left(\frac{V^{\circ}}{V^{\circ} - \Delta V} \right)^4 - \frac{\Delta V}{W} \dots\dots\dots (109)$$

To simulate the effect that solvent evaporation is expected to have on the present experiment, D_{apparent} as calculated by the above equation has been evaluated for several hypothetical losses of solvent, ΔV, under

conditions approximating the actual experimental ones used ($D^\circ = 4500 \text{ L kg}^{-1}$, $V^\circ = 150 \text{ mL}$) at a number of foam weights, W , and is displayed in Figure 2-17. We see from this that even if the distribution ratio, D , is assumed to be completely independent of foam weight, if even minor evaporative losses of solvent occur, small increases in the apparent distribution ratio will be observed at high foam weights and fairly large decreases will be seen at low foam weights. Since this describes exactly what was observed in this experiment, we conclude that solvent evaporation must be the cause of the otherwise peculiar phenomenon.

Although we should, in principle, be able to estimate directly the solvent losses indicated by the results in Figure 2-16, there is a further small complication which we have not yet considered. In the development of equation (109) we have assumed that no effects other than alteration of the solution thiocyanate concentration contribute to an increase in distribution ratio. As we will see later, however, increases in ionic strength (or $[\text{Na}^+]_{\text{aq}}$) also contribute significantly but are more difficult to treat mathematically. Very crudely, the effect of this added factor would be to increase the exponent in equation (109) to a value slightly greater than 4. For this reason, equation (109) tends to understate slightly the effects of solvent losses at the high foam weight end of Figure 2-17. Taking this modification roughly into reckoning, comparison of Figure 2-16 with Figure 2-17 shows that solvent losses of the order of perhaps 1.0 mL or so would be sufficient to account for the observed changes in distribution ratio with time. This amount of loss is not unreasonable based on solution weight and volume losses measured on other occasions over a 24 or 48 hour period.

Figure 2-17

Mathematical simulation of the expected effect of solvent evaporation on the determination of D as a function of the aqueous:foam phase ratio. Shown is the variation of the apparent distribution ratio, D_{apparent} , with the initial ratio $\frac{V^0}{W}$ of aqueous to foam phases for a hypothetical case in which the true distribution ratio is $D^0 = 4500 \text{ L kg}^{-1}$, $V^0 = 150.0 \text{ mL}$ and various losses, ΔV , are assumed to occur by evaporation.

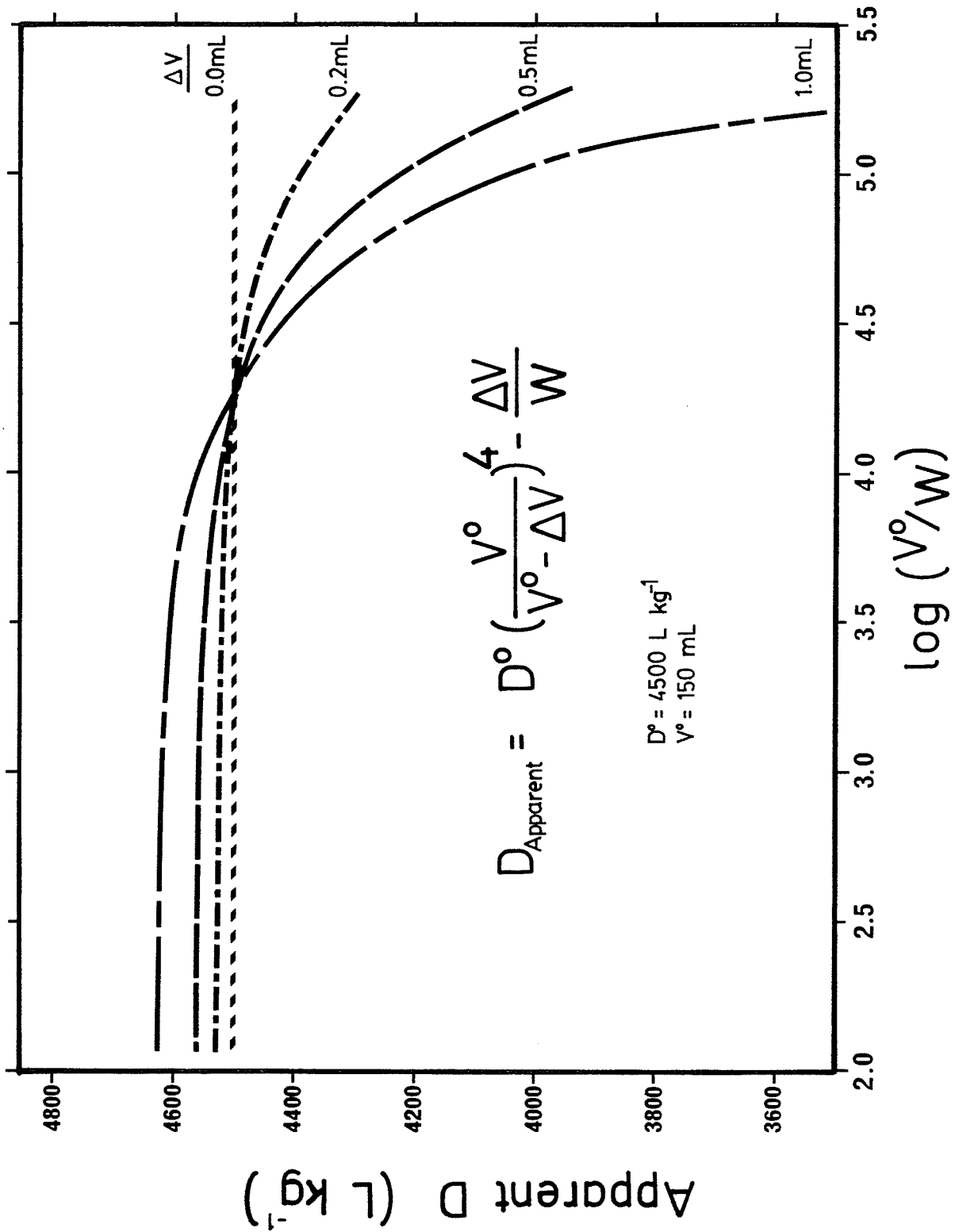

Closer comparison of Figures 2-16 and 2-17 shows, however, that not all deviations from constancy in D over the range of phase ratios (V/W) studied can be blamed on the solvent losses alone. In particular, it appears that if these effects are subtracted from the measured D versus $\log(V/W)$ profile that a measurable increase in D begins at about $\log(V/W) = 3.5$ (i.e. with $W \approx 0.05$ gram). This increase may continue through higher V/W ratios but, if so, is almost completely obliterated by the effects of solvent loss there.

In searching for an explanation for the apparent increase in D as the foam size is decreased, a number of possible physical causes were considered. One such possibility was that large foam pieces were sorbing sufficient SCN^- ligand (probably as $\text{Na}^+ + \text{SCN}^-$) to significantly decrease the solution thiocyanate concentration and thus decrease production of the extractable species. However, as pointed out earlier, measurements of weight gains by polyurethane foam after sorption show that negligible (less than 0.02%) losses of SCN^- could occur by this method for foam weights of about 0.05 grams (and presumably even less for smaller foams). Since this is the approximate upper limit of foam weight at which the increases in D begin to appear and since one would also expect no change in D at all with small foam pieces, it is clear that this explanation does not fit the data.

A second possible explanation which was considered was that large foam pieces may trap air bubbles, deep within the center which are not expelled on squeezing, and so prevent the central portion of the foam from participating in the equilibrium process thus lowering D . Again, if this were so, one would expect no effect to be observed at low foam weights

whereas large pieces would show progressively decreasing distribution ratios. This is not the pattern observed. Moreover, an experiment in which identical total weights of foam (about 0.50 gm.) either in the form of one single piece or as 222 individual small pieces were equilibrated with the same solution as used in this experiment gave identical values of D (4688 compared to 4686 $L\ kg^{-1}$ after 48 hours) in spite of the fact that the piece sizes (and thus squeezing behaviour, air entrapment, etc.) differed so drastically. Thus, we conclude that air trapped within the foam or other physical processes excluding some polymer from participating in equilibrium are not at work here.

It appears, then, that some phenomenon involving cobalt must be happening either within solution or internal to the polyurethane and one is thus reminded of the similar small increases measured in D as the solution cobalt concentration was increased (Figure 2-14). The parallel type of behaviour noted here leads one to suspect that the increase at hand may be due to changes in the foam cobalt concentration as was inferred to be the case in that experiment.

Calculation of the concentration of cobalt present on the various foam pieces after equilibration shows that it does indeed vary from 2.4×10^{-4} mol kg^{-1} for the largest piece to about 7.2×10^{-3} mol kg^{-1} for the smallest one. However, the increase in D in Figure 2-16 begins to be seen when the foam cobalt concentration is about 3.3×10^{-3} mol kg^{-1} while, by comparison, the onset of increases to D in Figure 2-14 do not begin to become visible below about 1.3×10^{-2} mol kg^{-1} . This four-fold difference in concentration would appear to indicate that the phenomenon observed in this experiment is occurring at a substantially lower foam cobalt concentration than in the previous one and thus may have a differ-

ent cause. However, the comparison is made difficult by the fact that the entire maximum increase in D measured in this experiment is only approximately 6% and this is easily visible only since the solution parameters are so closely matched to one another that the experimental error is quite small whereas in the previous experiment the maximum increase in D is about 25% and data scatter is twice as large so a 6% increase would be just barely detectable. Thus, part of the disparity may simply be due to a difference in ability to detect the onset of the occurrence in the two experiments.

In addition, although both experiments were planned to have all solution parameters identical (except $[\text{Co}]_{\text{aq}}$), an error made in preparing the stock buffer solution resulted in an ionic strength (and thus $[\text{Na}^+]_{\text{aq}}$) of only 2.88 M in this case compared to 3.00 M for the previous experiment. Evidently, this or other minor differences between experiments was sufficient to lower the average distribution ratio from about 5060 L kg⁻¹ measured in the preceding experiment to about 4760 L kg⁻¹ in this one. These differences in solution conditions will have an effect on the various equilibria involved and may alter the expected occurrence. Indeed, if the mechanism whereby D increases should in both cases be the same type of association tentatively proposed earlier (i.e. $2 (\text{Na}^+)_2 \cdot \text{Co}(\text{SCN})_4^{2-} \rightleftharpoons \text{Co}^{2+} \cdot \text{Co}(\text{SCN})_4^{2-} + 4 \text{Na}^+ \cdot \text{SCN}^-_{(\text{f})}$) then we have already predicted some increase in the foam cobalt concentration at which the phenomenon would begin to become significant with increases in either the solution $[\text{Na}^+]_{\text{aq}}$ or $[\text{SCN}^-]_{\text{aq}}$ concentrations. We would also predict the same thing to occur, however, based on changes to either the availability of sites on foam or the activity coefficients of species there when NaSCN is appreciably sorbed. In this case, we have at least a difference of 0.12

M in $[\text{Na}^+]_{\text{aq}}$ so some change in suppression of the association mechanism or of the other two effects should result. Whether this would, in fact, be sufficient to account for a significant portion of the observed difference is not really known. Obviously, considerably more data under a variety of different solution conditions would be necessary to establish whether or not the phenomena observed in the cobalt concentration and phase ratio experiments are truly manifestations of the same process and what that process might be.

However, from a more practical point of view, both processes observed are relatively minor aberrations in what is otherwise very close to strictly independent behaviour. For most purposes we conclude that the distribution ratio is essentially insensitive to both cobalt concentration (when below the saturation limit) and the relative quantities of the two phases present with some evidence for slight deviation from this constancy under specific circumstances.

It will be noted, incidentally, that the 0.05 gram foam pieces which were adopted as standard for use in most other experiments carried out is approximately the smallest size which could be used without moving into the non-linear portion of Figure 2-16. This was, in fact, fortuitous since the size of foam chosen was dictated much earlier by squeezing efficiency and sorption measurement considerations.

When considered in terms of the eventual utility of polyurethane foam for analytical or industrial applications, the results of the experiment demonstrate that large solution volumes may be extracted by small weights of polyurethane foam with no decrease (and perhaps even slight increase) in efficiency resulting. This is expected to be an important consideration where either waste recovery, preconcentration or semi-quantitative analysis at low levels may be the desired use.

7. Effect of Temperature on Cobalt Sorption from Thiocyanate Solution

An experiment was devised to determine what effect temperature over the range from 0 to 95°C may have on the sorption of cobalt by polyurethane foam from aqueous thiocyanate solutions.

Preliminary observations of the effects of temperature on the sorption equilibrium came as an unwelcome surprise resulting from uncontrollable fluctuations in our laboratory temperature. It was noted, in this way, that large decreases in extraction accompanied moderate increases in room temperature and so an elaborate temperature control mechanism was necessitated. On one occasion, during the early stages of the stepwise development of this mechanism, it was observed that foams equilibrated at one end of the cabinet showed distribution ratios which were 10% higher than for the remainder and this was found to result from a difference of only 0.2°C at those locations. It was considered important, then, to accurately establish the relationship between D and temperature quite early. Moreover, based on observations of the colours developed on polyurethane foams present when the radioactive wastes were being evaporated to dryness before disposal, it was suspected that thiocyanate concentration may influence the temperature behaviour of the sorption so plans were made to study the effect at several aqueous thiocyanate concentrations.

The experiment was carried out in five parts (Experiments 1 to 5) corresponding to the different thiocyanate concentrations studied (0.010, 0.050, 0.25, 1.00 and 5.00 M). The desired initial solution conditions

were 1.0 ppm Co(II), 0.010 to 5.00 M SCN^- (furnished by KSCN), 1.00 M $\text{NaOOCCH}_3/\text{HOOCCH}_3$ buffer, and an ionic strength of 3.00 M (maintained by KCl addition, where necessary). Unfortunately, a weighing error perpetuated in most of the experiments (except for 0.050 M SCN^-) resulted in the buffer concentration being 0.88 M $\text{NaOOCCH}_3/1.00$ M HOOCCH_3 and the actual total ionic strength being 2.88 M therefore. In addition, when 5.00 M thiocyanate was used, the ionic strength was 5.88 M by necessity. The initial solution conditions thus obtained are listed under the headings of Table II-13.

Solutions were usually prepared individually in a 150 mL volumetric flask by weighing in the necessary quantity of KCl solid and by pipetting the appropriate aliquots of stock 10.0 ppm Co(II), 2.50 M $\text{NaOOCCH}_3/2.50$ M HOOCCH_3 (or 2.20 M $\text{NaOOCCH}_3/2.50$ M HOOCCH_3 when in error) and sufficient ^{60}Co tracer to give an initial count rate of 1500 seconds $^{-1}$ when measured in the usual manner. The required amount of KSCN was also added either by weighing in the solid (for 0.25 M, 1.00 M and 5.00 M), or by pipetting a 0.25 M KSCN stock solution (for 0.010 M and 0.050 M) into the 150 mL volumetric flasks. A larger quantity than this (500 mL) was prepared in the case of the 1.00 M and 5.00 M SCN^- solutions only since those experiments were split up into several parts with fresh solution for each part. The flasks were then diluted to near the mark as usual and left to equilibrate overnight before final dilution and mixing.

As described in the General Procedure section, a single water-jacketed distribution cell (Figures 2-6 and 2-7) controlled by a recirculating thermostatic bath was used to equilibrate foam and solution. The apparatus was very effective in maintaining temperatures above that of

the room to $\pm 0.05^{\circ}\text{C}$ but was less reliable at lower temperatures.

Approximately 50 mg #1338 BFG foam pieces were weighed into the distribution cell followed by 150 mL of the appropriate solution before the cell was sealed with silicone grease and double condoms. No metal spring was used in the apparatus (to avoid iron contamination) and no silicone grease was coated on the plunger stem.

In order to eliminate as many factors as possible other than temperature, the same solution and the same foam piece were used whenever possible in each separate part of the experiment to measure equilibration at a number of different temperatures. Since the results were then being generated sequentially and thus required a great deal of time, the period left for equilibration at any particular temperature was reduced to 6 hours (or sometimes longer when frequent mechanical breakdowns or other reasons led one to suspect that equilibrium might not have been achieved). Only one measurement of extraction was made at the end of that time period. The temperature of the solution in the distribution cell was then measured just before the thermostat was altered and another 6 hour equilibration period was begun at a new temperature.

Counting of the aliquots withdrawn for analysis was performed repetitively as usual except that the filled tubes were allowed to stand in room temperature water for about 10 minutes prior to finally adjusting to the mark and counting so as to avoid errors relating to solution density changes. The mouths of the tubes were covered with polyvinylchloride film during this entire process to reduce evaporation and the counted solutions were returned to the distribution cell. Background activity on the single tube used for counting was determined daily from twenty

separate evaluations. No corrections were made to the data to allow for possible spectrometer drift.

Since the procedure followed meant that a single 150 mL aliquot of solution and a single 50 mg foam piece were in continuous use at various temperatures for from 2 to over 5 days before being replaced, it was feared that one or the other might begin to deteriorate sufficiently to affect its sorption behaviour. To provide a means of checking this possibility and also to establish whether or not equilibrium had been effectively reached in each case, the order in which individual temperatures were tested was usually arranged so that the solution was first raised from a low temperature in 10°C increments up to the point where cobalt sorption became difficult to measure and then lowered again in 10°C increments but at intermediate values. In this way, it was expected that systematic errors arising out of either failure to reach equilibrium or materials deterioration would show up as differences in the curves traced out by the ascending and descending halves of the data.

The experiments involving 1.00 M and 5.00 M SCN^- were taken up to the highest temperatures where decomposition, contamination or solvent evaporation were expected to be most severe and were therefore split up into several sections with a fresh foam piece and solution being used for each.

During the course of the experiment, a number of interesting observations were made. First of all, similar to other experiments, it was noted that the colours assumed by foams after reaching equilibrium with the solutions ranged from white to blue-green at various temperatures and exactly paralleled the measured cobalt sorptions.

Secondly, contrary to our fears, the cobalt-buffer-KSCN-KCl mixtures used in the experiments did not show any visible signs of deterioration (yellowing or changes in D) over several days of heating as long as iron was excluded. However, problems were encountered when large amounts of iron were present. For example, during an initial attempt to carry out a sixth experiment with 2.00 M KSCN in which a steel spring was used at the top of the distribution cell, the solution soon became dark reddish brown and opaque with rusty solid as a result of iron contamination. Moreover, some of the ^{60}Co tracer present coprecipitated with the rust-coloured solid and so was lost to solution. The results of that experiment had to be rejected as the ascending and descending data did not match. All later attempts which involved heating of solutions were carried out without steel springs to avoid this problem.

A third important observation which was made in this and a number of earlier experiments was that even after repeated extractions with fresh foam pieces, some very small amount of radioactivity remained which was apparently unextractable. The residue was identified by gamma spectrometry as the naturally-occurring potassium isotope, ^{40}K ($t_{1/2} \sim 1.3 \times 10^9$ years, 0.118% natural abundance) and its presence necessitated applying corrections to all of the data obtained using potassium rather than sodium or ammonium salts. This caused some inconvenience and was one of the reasons for switching to sodium salts instead for most of the other experiments.

The results of the individual temperature experiments are collected in Table II-13 which contains the final solution temperature, foam/solution contact time, percentage of cobalt extracted and calculated distrib-

TABLE II-13 EFFECT OF TEMPERATURE ON COBALT EXTRACTION

Initial Conditions:

[Co] 1.7×10^{-5} M (1.0 ppm)
 Solution Volume (V) 150.0 mL
 Foam Weight (W) 0.050 grams
 Type #1338 BFG

Experiment 1

[SCN⁻] 0.010 M (KSCN)
 Ionic Strength (I) 2.88 M (KCl)
 pH 4.7 (0.88 M Na acetate buffer)
 W 50.49 mg

Sample Number	Temperature (°C) ±0.1	1/T x 10 ³ (K ⁻¹) ±0.001	Contact Time (hours)	Cobalt Extracted (%)	D (L kg ⁻¹)	log D
1	0.25	3.658	8.0	37.30 ±0.27	1.767×10^3 ±0.015	3.247 ±0.004
2	15.4	3.466	12.0	1.06 ±0.28	3.2×10^1 ±0.8	1.50 ±0.11
3	13.1	3.493	6.0	1.97 ±0.28	6.0×10^1 ±0.8	1.78 ±0.06
4	10.5	3.525	6.0	3.75 ±0.32	1.16×10^2 ±0.10	2.06 ±0.04
5	7.4	3.564	6.0	8.20 ±0.31	2.66×10^2 ±0.10	2.424 ±0.017
6	6.3	3.578	6.0	11.07 ±0.30	3.70×10^2 ±0.10	2.568 ±0.012
7	2.7	3.625	8.0	24.89 ±0.26	9.84×10^2 ±0.11	2.993 ±0.005

Experiment 2

[SCN⁻] 0.050 M (KSCN)
 Ionic Strength (I) 3.00 M (KCl)
 pH 4.8 (1 M Na acetate buffer)
 W 50.25 mg

1	5.7	3.586	12.0	98.07 ±0.04	1.520×10^5 ±0.034	5.182 ±0.010
2	15.1	3.469	18.5	84.72 ±0.11	1.654×10^4 ±0.012	4.2188 ±0.0032
3	24.95	3.355	17.0	27.70 ±0.20	1.144×10^3 ±0.009	3.058 ±0.004
4	34.6	3.249	12.0	2.23 ±0.30	6.8×10^1 ±0.9	1.83 ±0.06

TABLE II-13 - continued

Sample Number	Temperature (°C) ±0.1	1/T x 10 ³ (K ⁻¹) ±0.001	Contact Time (hours)	Cobalt Extracted (%)	D (L kg ⁻¹)	log D
5	30.1	3.298	12.5	7.77 ±0.25	2.51 x 10 ² ±0.08	2.400 ±0.014
6	20.2	3.409	25.3	60.44 ±0.17	4.561 x 10 ³ ±0.023	3.6590 ±0.0023
7	10.6	3.524	20.9	94.73 ±0.05	5.36 x 10 ⁴ ±0.05	4.729 ±0.004
8	0.25	3.658	11.9	99.462 ±0.020	5.52 x 10 ⁵ ±0.20	5.742 ±0.016

Experiment 3

[SCN⁻] 0.25 M (KSCN)
 Ionic Strength (I) 2.88 M (KCl)
 pH 4.7 (0.88 M Na acetate buffer)
 W 49.99 mg

1	10.1	3.530	12.7	99.861 ±0.017	2.16 x 10 ⁶ ±0.26	6.33 ±0.05
2	19.8	3.414	6.1	99.571 ±0.022	7.0 x 10 ⁵ ±0.4	5.843 ±0.022
3	29.9	3.300	6.0	97.205 ±0.029	1.044 x 10 ⁵ ±0.011	5.018 ±0.005
4	40.4	3.189	6.0	77.95 ±0.10	1.061 x 10 ⁴ ±0.005	4.0256 ±0.0020
5	50.5	3.090	6.25	25.95 ±0.23	1.051 x 10 ³ ±0.010	3.022 ±0.004
6	55.5	3.043	5.8	8.56 ±0.25	2.81 x 10 ² ±0.08	2.449 ±0.013
7	60.5	2.997	5.8	0.92 ±0.24	2.8 x 10 ¹ ±0.7	1.44 ±0.11
8	45.4	3.139	10.3	58.07 ±0.16	4.154 x 10 ³ ±0.020	3.6185 ±0.0021
9	35.2	3.243	8.6	92.37 ±0.10	3.63 x 10 ⁴ ±0.05	4.450 ±0.006
10	24.8	3.356	6.4	99.002 ±0.025	2.98 x 10 ⁵ ±0.07	5.474 ±0.011
11	15.2	3.468	5.8	99.844 ±0.019	1.91 x 10 ⁶ ±0.23	6.28 ±0.05

TABLE II-13 - continued

Experiment 4

[SCN⁻] 1.00 M (KSCN)
 Ionic Strength (I) 2.88 M (KCl)
 pH 4.8 (0.88 M Na acetate buffer)

Sample Number	Temperature (°C) ±0.1	1/T x 10 ³ (K ⁻¹) ±0.001	Contact Time (hours)	Cobalt Extracted (%)	D (L kg ⁻¹)	log D
A/ W 50.78 mg						
1	39.9	3.194	6.0	99.342 ±0.024	4.45 x 10 ⁵ ±0.16	5.649 ±0.016
2	45.0	3.143	6.0	98.355 ±0.028	1.766 x 10 ⁵ ±0.030	5.247 ±0.007
3	50.0	3.095	6.0	95.88 ±0.05	6.88 x 10 ⁴ ±0.08	4.838 ±0.005
4	55.1	3.046	6.0	90.10 ±0.07	2.688 x 10 ⁴ ±0.020	4.4294 ±0.0033
5	60.0	3.003	6.0	79.44 ±0.12	1.142 x 10 ⁴ ±0.007	4.0575 ±0.0025
6	65.1	2.956	6.0	63.98 ±0.16	5.248 x 10 ³ ±0.026	3.7200 ±0.0022
B/ W 50.73 mg						
7	29.75	3.301	6.3	99.820 ±0.020	1.64 x 10 ⁶ ±0.18	6.22 ±0.05
8	34.8	3.247	6.0	99.706 ±0.019	1.00 x 10 ⁶ ±0.07	6.002 ±0.028
9	70.4	2.911	6.2	37.99 ±0.25	1.812 x 10 ³ ±0.014	3.258 ±0.034
10	75.1	2.872	6.0	21.45 ±0.25	8.08 x 10 ² ±0.10	2.907 ±0.005
11	80.0	2.832	6.0	7.09 ±0.34	2.26 x 10 ² ±0.11	2.353 ±0.022

TABLE II-13 - continued

Experiment 5

[SCN⁻] 5.00 M (KSCN)
 Ionic Strength (I) 5.88 M (KCl)
 pH 5.3 (0.88 M Na acetate buffer)

Sample Number	Temperature (°C) ±0.1	1/T x 10 ³ (K ⁻¹) ±0.001	Contact Time (hours)	Cobalt Extracted (%)	D (L kg ⁻¹)	log D
A/ W 50.83 mg						
1	49.3	3.101	6.0	99.785 ±0.021	1.37 ±0.14 x 10 ⁶	6.14 ±0.04
2	54.4	3.053	6.0	99.653 ±0.023	8.5 ±0.6 x 10 ⁵	5.928 ±0.028
B/ W 51.24 mg						
3	50.0	3.095	6.0	99.748 ±0.022	1.16 ±0.10 x 10 ⁶	6.06 ±0.04
4	55.0	3.047	6.0	99.640 ±0.023	8.1 ±0.5 x 10 ⁵	5.908 ±0.028
5	60.1	3.001	6.0	99.423 ±0.023	5.05 ±0.20 x 10 ⁵	5.703 ±0.018
6	65.1	2.956	6.0	99.057 ±0.026	3.07 ±0.09 x 10 ⁵	5.488 ±0.012
7	70.0	2.914	6.0	98.502 ±0.026	1.924 ±0.033 x 10 ⁵	5.284 ±0.008
8	75.1	2.872	6.0	97.61 ±0.04	1.198 ±0.019 x 10 ⁵	5.078 ±0.007
9	80.2	2.830	6.0	96.28 ±0.04	7.57 ±0.08 x 10 ⁴	4.879 ±0.005
10	10.0	3.532	4.25	99.926 ±0.021	3.9 ±1.2 x 10 ⁶	6.59 ±0.13
C/ W 50.69 mg						
11	25.0	3.354	13.0	99.892 ±0.025	2.7 ±0.6 x 10 ⁶	6.44 ±0.10
12	80.2	2.830	6.0	96.38 ±0.05	7.87 ±0.10 x 10 ⁴	4.896 ±0.006
13	85.2	2.791	6.0	94.23 ±0.04	4.833 ±0.034 x 10 ⁴	4.6842 ±0.0030
14	90.2	2.752	6.0	91.22 ±0.08	3.074 ±0.027 x 10 ⁴	4.488 ±0.004
15	95.1	2.716	6.1	87.87 ±0.07	2.144 ±0.013 x 10 ⁴	4.3312 ±0.0026
16	10.0	3.532	6.0	99.838 ±0.024	1.83 ±0.28 x 10 ⁶	6.26 ±0.07

Figure 2-18

Effect of temperature on extraction of cobalt from 150.0 mL of several aqueous thiocyanate solutions by 0.050 gram pieces of #1338 BFG polyurethane foam. The initial solution Co(II) concentration was 1.7×10^{-5} M (1.0 ppm) in all cases. Other initial solution conditions were as follows:

—▲—	0.010 M KSCN
—■—	1.99 M KCl
—□—	0.88 M NaOOCCH ₃ /1.00 M HOOCCH ₃ buffer, pH 4.7
—○—	2.88 M total ionic strength
—◇—	0.050 M KSCN
—▽—	1.95 M KCl
—○—	1.00 M NaOOCCH ₃ /1.00 M HOOCCH ₃ buffer, pH 4.7
—◇—	3.00 M total ionic strength
—○—	0.25 M KSCN
—▽—	1.75 M KCl
—◇—	0.88 M NaOOCCH ₃ /1.00 M HOOCCH ₃ buffer, pH 4.7
—○—	2.88 M total ionic strength
—▽—	1.00 M KSCN
—◇—	1.00 M KCl
—○—	0.88 M NaOOCCH ₃ /1.00 M HOOCCH ₃ buffer, pH 4.8
—◇—	2.88 M total ionic strength
—▽—	5.00 M KSCN
—◇—	0.88 M NaOOCCH ₃ /1.00 M HOOCCH ₃ buffer, pH 5.3
—○—	5.88 M total ionic strength

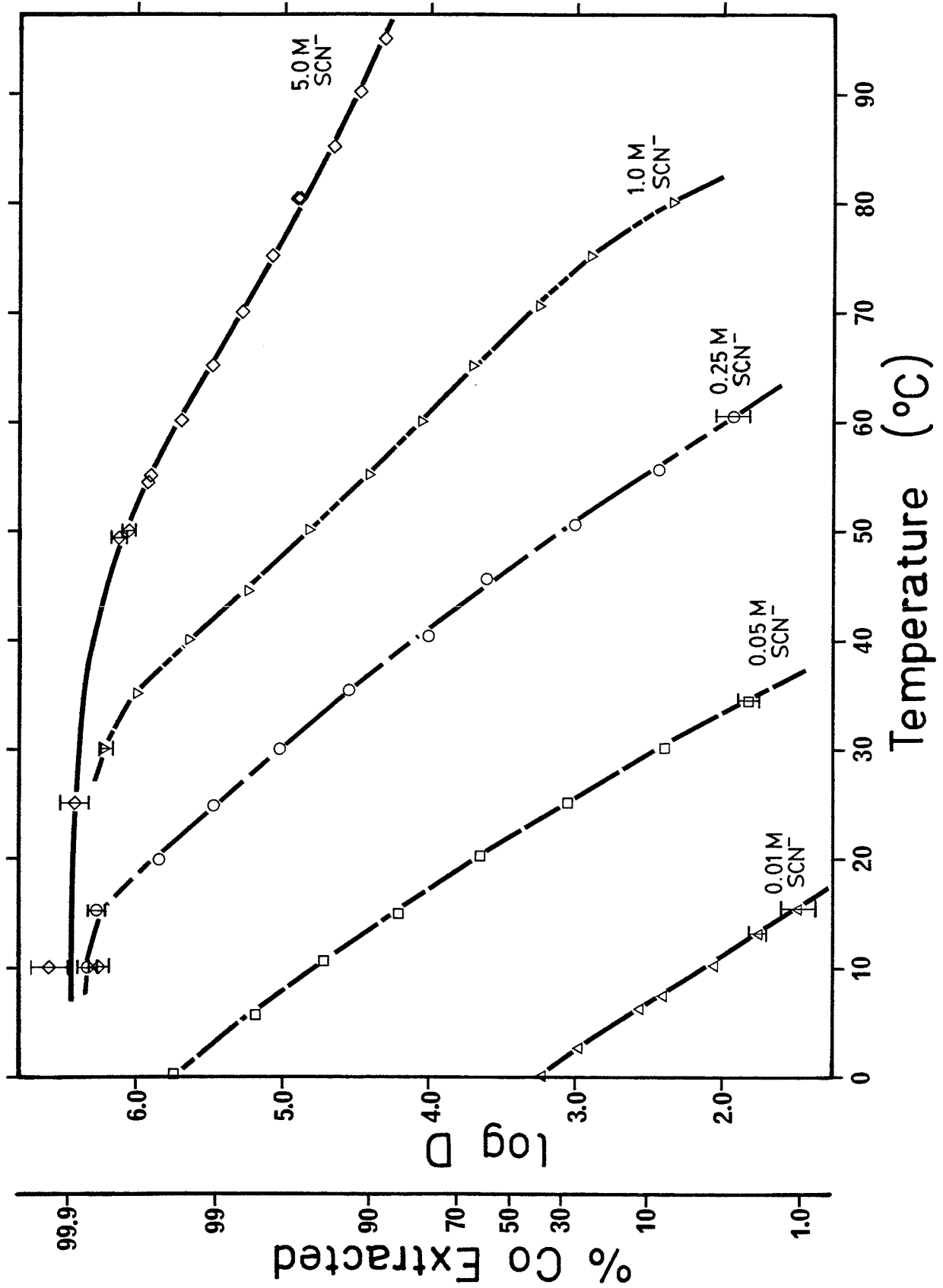

ution ratio. Within each section the data are presented in the order in which they were obtained (i.e. ascending and then descending temperatures). The results also appear graphically in Figure 2-18 as $\log D$ as a function of temperature.

From Figure 2-18, we see that cobalt sorption is indeed very sensitive to temperature but that this sensitivity is decreased when high thiocyanate concentrations are used. For example, with 0.050 M SCN^- , D decreases by about 10 000-fold with a temperature change of as little as 35°C whereas for 5.00 M SCN^- D decreases only 20-fold for a 35°C change at high temperature and almost not at all at low temperature. Also apparent from Figure 2-18 is the observation that the distribution ratio appears in each case to tend to a maximum value near $10^{6.5} = 3 \times 10^6 \text{ L kg}^{-1}$ (representing 99.9% extraction when there are 3000 liters of solution for each kilogram of foam). This apparently gives the optimum extraction available and is not an artifact since tests showed that a second piece of fresh foam equilibrated with the solutions extracted the remaining ^{60}Co activity.

To try to obtain some thermodynamic information, the data of Table II-13 are shown replotted in Figure 2-19 in the traditional format of $\log D$ versus inverse of absolute temperature, T . We see that a family of curves each containing essentially linear portions results and we will now consider what information about the extraction process may be revealed by this.

According to elementary thermodynamics⁽²²⁷⁾, the value of the true equilibrium constant, K , describing a chemical reaction is related to the standard enthalpy, ΔH° , and entropy, ΔS° , changes accompanying the

Figure 2-19

Relationship between logarithm of distribution ratio and inverse of absolute temperature for the extraction of cobalt from 150.0 mL of several aqueous thiocyanate solutions by 0.050 gram pieces of #1338 BFG polyurethane foam. The initial solution Co(II) concentration was 1.7×10^{-5} M (1.0 ppm) in all cases. Other initial solution conditions were as follows:

—▲—	0.010 M KSCN
—■—	1.99 M KCl
—□—	0.88 M NaOOCCH ₃ /1.00 M HOOCCH ₃ buffer, pH 4.7
—◇—	2.88 M total ionic strength
—○—	0.050 M KSCN
—△—	1.95 M KCl
—◇—	1.00 M NaOOCCH ₃ /1.00 M HOOCCH ₃ buffer, pH 4.7
—○—	3.00 M total ionic strength
—○—	0.25 M KSCN
—○—	1.75 M KCl
—○—	0.88 M NaOOCCH ₃ /1.00 M HOOCCH ₃ buffer, pH 4.7
—○—	2.88 M total ionic strength
—▽—	1.00 M KSCN
—▽—	1.00 M KCl
—▽—	0.88 M NaOOCCH ₃ /1.00 M HOOCCH ₃ buffer, pH 4.8
—▽—	2.88 M total ionic strength
—◇—	5.00 M KSCN
—◇—	0.88 M NaOOCCH ₃ /1.00 M HOOCCH ₃ buffer, pH 5.3
—◇—	5.88 M total ionic strength

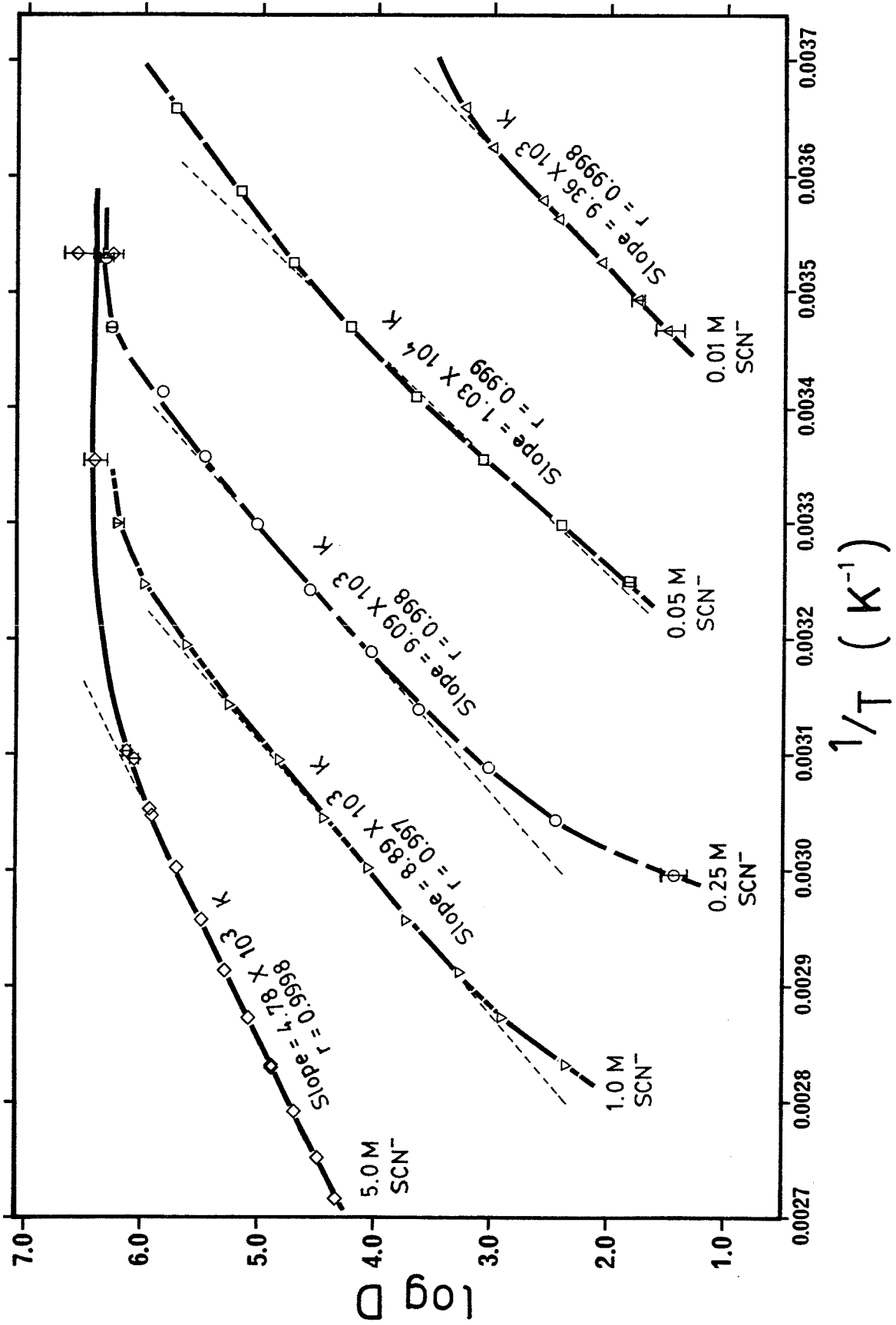

reaction by:

$$\log K = \frac{-\Delta H^\circ}{2.303 RT} + \frac{\Delta S^\circ}{2.303 R} \dots\dots\dots (110)$$

where T is the absolute temperature of the reaction and R is the universal gas constant (8.3143 J K⁻¹ mol⁻¹). The superscript ° denotes that these are the enthalpy and entropy changes expected when each of the reactants and products are present in their standard states (i.e. 1 Atmosphere pressure, 1.0 M concentrations of species in solution and most stable physical form for pure substances). Assuming that ΔH° and ΔS° are essentially independent of temperature, we expect that a plot of the logarithm of such an equilibrium constant as a function of the inverse absolute temperature will yield a line of slope -ΔH°/(2.303 R) and intercept ΔS°/(2.303 R).

The reaction we are considering in this experiment is the extraction of cobalt from aqueous solution into polyurethane foam:

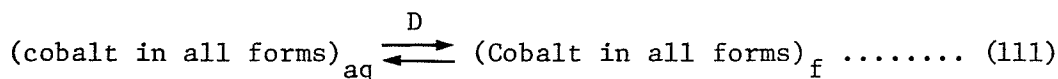

for which we define a distribution ratio, D, as:

$$D = \frac{[\text{cobalt in all forms}]_{\text{f}}}{[\text{cobalt in all forms}]_{\text{aq}}} = \frac{[\text{Co}]_{\text{f}}}{[\text{Co}]_{\text{aq}}} \dots\dots\dots (112)$$

Unfortunately, D is not a true equilibrium constant but is instead a

composite of a large number of constants and solution parameters. Therefore, it can be expected to change in a very complex manner with changes in temperature and does not generally obey the relation given by equation (110).

To see that this is so and to determine whether any information can be obtained from the temperature dependence of D, we will develop a mathematical expression for D based on the individual equilibrium constants and solution concentrations involved. As usual, we will approximate all relations by using molar and molal concentrations rather than activities since the activity coefficients will, in general, be unknown to us.

To begin, we will make use of previous information from which we have already surmised that the extraction of cobalt from thiocyanate solution is probably via the Co(SCN)_4^{2-} species. If this is the case, then no matter what the mechanism, the first stage of the extraction will be the stepwise formation of this species in the aqueous phase. We may express this by a series of overall complex formation equations each having an equilibrium constant, β_i . Moreover, each equilibrium will be accompanied by a standard molar enthalpy change, ΔH_i° , and a standard molar entropy change, ΔS_i° , as follows:

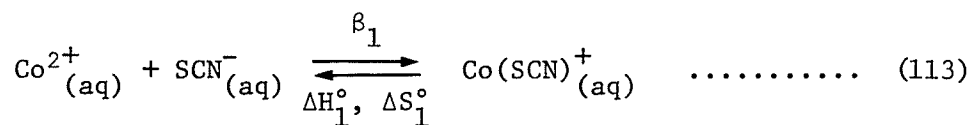

$$\beta_1 = \frac{[\text{Co(SCN)}^+]_{aq}}{[\text{Co}^{2+}]_{aq} [\text{SCN}^-]_{aq}} \dots\dots\dots (114)$$

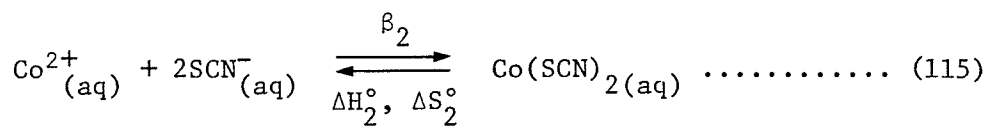

$$\beta_2 = \frac{[\text{Co}(\text{SCN})_2]_{\text{aq}}}{[\text{Co}^{2+}]_{\text{aq}} [\text{SCN}^{-}]_{\text{aq}}^2} \dots\dots\dots (116)$$

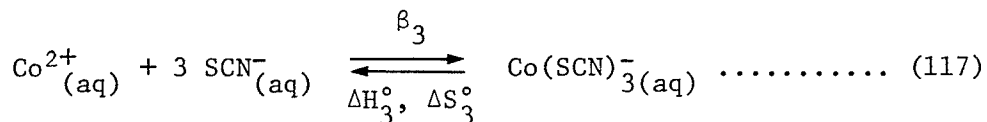

$$\beta_3 = \frac{[\text{Co}(\text{SCN})_3^{-}]_{\text{aq}}}{[\text{Co}^{2+}]_{\text{aq}} [\text{SCN}^{-}]_{\text{aq}}^3} \dots\dots\dots (118)$$

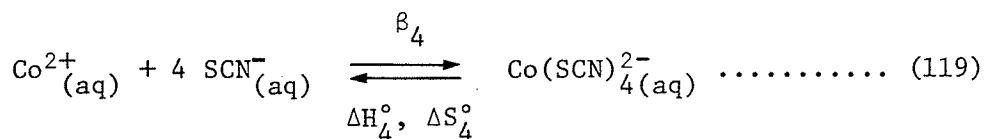

$$\beta_4 = \frac{[\text{Co}(\text{SCN})_4^{2-}]_{\text{aq}}}{[\text{Co}^{2+}]_{\text{aq}} [\text{SCN}^{-}]_{\text{aq}}^4} \dots\dots\dots (120)$$

The complex anion, $\text{Co}(\text{SCN})_4^{2-}(\text{aq})$ will then distribute itself between the aqueous and foam phases. The method by which this will happen depends upon which mechanism of extraction is in operation. Considering first the case in which extraction takes place by a solvent extraction-like mechanism (which, as we have said, includes the Cation Chelation Mechanism in the special case where very little sorption of other cation-anion pairs also occurs), then the extractable cobalt-containing species will be in association with a pair of available cations, M^+ . The exact form of the

species on foam is not necessarily known and, in particular, we are not specifying whether or not the cation is chelated or simply solvated. However, for the sake of argument, we will consider the cations and anions to be ion paired. The distribution equilibrium will then be:

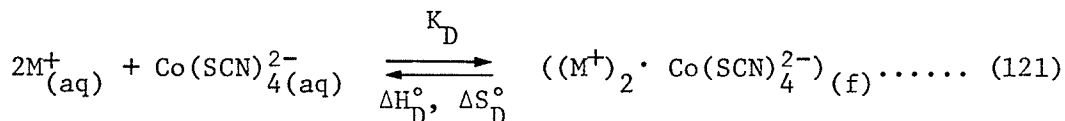

$$K_D = \frac{[(M^+)_2 \cdot Co(SCN)_4^{2-}]_f}{[M^+]_{aq}^2 [Co(SCN)_4^{2-}]_{aq}} \dots\dots (122)$$

This process is again governed by its own equilibrium constant, K_D , and will be accompanied by further enthalpy, ΔH_D° , and entropy, ΔS_D° , changes.

Assuming only these cobalt-containing species are present (although we have previously shown some possible evidence for other species on foam under certain circumstances), the distribution ratio, D, would then be given by:

$$D = \frac{[Co]_f}{[Co]_{aq}} = \frac{[(M^+)_2 \cdot Co(SCN)_4^{2-}]_f}{([Co^{2+}]_{aq} + [Co(SCN)^+]_{aq} + [Co(SCN)_2]_{aq} + [Co(SCN)_3^-]_{aq} + [Co(SCN)_4^{2-}]_{aq})} \dots\dots (123)$$

and we could use the expressions for the various equilibrium constants to give, finally:

$$D = \frac{\beta_4 K_D [M^+]_{aq}^2 [SCN^-]_{aq}^4}{1 + \beta_1 [SCN^-]_{aq} + \beta_2 [SCN^-]_{aq}^2 + \beta_3 [SCN^-]_{aq}^3 + \beta_4 [SCN^-]_{aq}^4} \dots (124)$$

Taking logarithms, then, we get:

$$\begin{aligned} \log D = & \log \beta_4 + \log K_D + 2 \log [M^+]_{aq} + 4 \log [SCN^-]_{aq} \\ & - \log(1 + \beta_1 [SCN^-]_{aq} + \beta_2 [SCN^-]_{aq}^2 + \beta_3 [SCN^-]_{aq}^3 + \beta_4 [SCN^-]_{aq}^4) \\ & \dots (125) \end{aligned}$$

Applying relation (110) to each of the logarithms of the equilibrium constants in equation (125) and grouping similar terms gives:

$$\begin{aligned} \log D = & -\left(\frac{\Delta H_4^\circ + \Delta H_D^\circ}{2.303 R}\right) \frac{1}{T} + \left(\frac{\Delta S_4^\circ + \Delta S_D^\circ}{2.303 R}\right) + 2 \log [M^+]_{aq} + 4 \log [SCN^-]_{aq} \\ & - \log(1 + \beta_1 [SCN^-]_{aq} + \beta_2 [SCN^-]_{aq}^2 + \beta_3 [SCN^-]_{aq}^3 + \beta_4 [SCN^-]_{aq}^4) \\ & \dots (126) \end{aligned}$$

Thus, if the five equilibria ((113), (115), (117), (119) and (121)) describe completely all of the solution and foam processes involving cobalt, then the distribution ratio and its logarithm would be correctly given as above and the net equilibrium relation would range from:

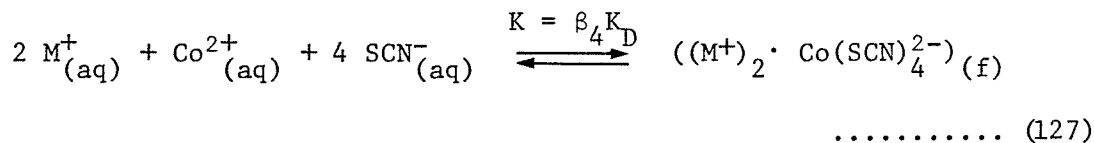

$$\Delta H^\circ_{total} = \Delta H_4^\circ + \Delta H_D^\circ$$

$$\Delta S^\circ_{total} = \Delta S_4^\circ + \Delta S_D^\circ$$

if the initial solution conditions were such that essentially all of the solution cobalt were originally in the $\text{Co}^{2+}_{(aq)}$ form to:

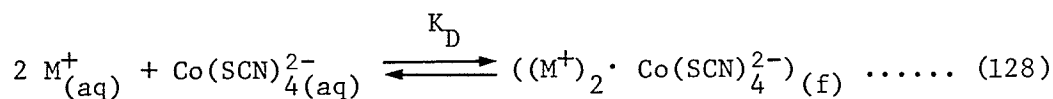

$$\Delta H^\circ_{\text{total}} = \Delta H^\circ_D$$

$$\Delta S^\circ_{\text{total}} = \Delta S^\circ_D$$

if the initial conditions were such that $\text{Co}(\text{SCN})^{2-}_4(aq)$ was the strongly favoured species. Of course, each of these possibilities represents an extreme which may or may not be realized in any particular situation according to the thiocyanate concentration, temperature and perhaps other factors. More often, intermediate conditions would exist which produce results somewhere between these limits.

However, there are several complicating factors in our temperature experiments which do not make the five equilibria totally descriptive of the system and which therefore make equations (124) and (126) incorrect. First among these is the fact that we have two different cations, M^+ , present (Na^+ from the buffer and K^+ from KCl and KSCN) and each may be differently solvated in either phase and therefore have different enthalpies and entropies of extraction. However, it is difficult to make any corrections for this since we do not know the relative proportions of the two cations extracted but we will see later that it is important and should, therefore, be kept in mind.

A second serious problem to be considered is the fact that other

ligands aside from SCN^- arising from the buffer and the ionic strength adjuster are also available to complex cobalt and these will greatly increase the number of solution species we must contend with in forming an expression for $[\text{Co}]_{\text{aq}}$. Thus, we may expect to form some amount of $\text{CoCl}^+_{(\text{aq})}$, $\text{CoCl}_2_{(\text{aq})}$, $\text{CoCl}^-_{3(\text{aq})}$, etc. and $\text{Co}(\text{OOCCH}_3)^+_{(\text{aq})}$, $\text{Co}(\text{OOCCH}_3)_2_{(\text{aq})}$, etc. or even mixed complexes containing any of SCN^- , Cl^- and CH_3COO^- as ligands. The effect this will have on equation (126) is to add to the final expression in brackets many more terms of the general form $K_{jkl} [\text{SCN}^-]^j [\text{Cl}^-]^k [\text{CH}_3\text{COO}^-]^\ell$ corresponding to the overall formation of the general complex ion:

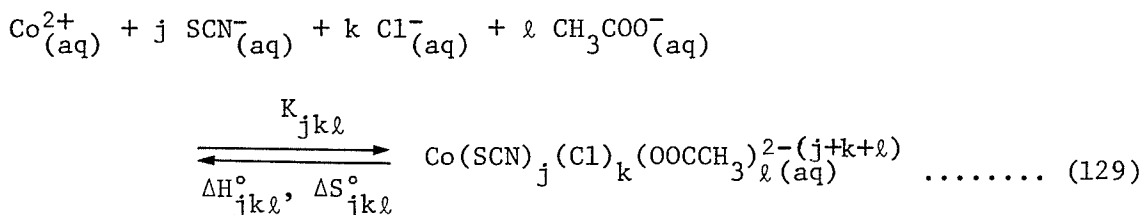

$$K_{jkl} = \frac{[\text{Co}(\text{SCN})_j (\text{Cl})_k (\text{OOCCH}_3)_\ell^{2-(j+k+\ell)}]_{\text{aq}}}{[\text{Co}^{2+}]_{\text{aq}} [\text{SCN}^-]_{\text{aq}}^j [\text{Cl}^-]_{\text{aq}}^k [\text{CH}_3\text{COO}^-]_{\text{aq}}^\ell} \dots \dots \dots (130)$$

In these equations j , k and ℓ may assume any integral values but k and ℓ are understood not to be both zero. The special case where $k = \ell = 0$ denotes the already-mentioned series of cobalt-thiocyanate species so it must be understood that we are here excluding these so that they will not be counted twice. As usual, the formation of each complex ionic species will also be accompanied by some standard enthalpy, ΔH°_{jkl} , and entropy, ΔS°_{jkl} , changes. The new relation which now describes the

distribution ratio for a solvent extraction-like process more completely is:

$$\begin{aligned} \log D = & -\left(\frac{\Delta H_4^\circ + \Delta H_D^\circ}{2.303 R}\right) \frac{1}{T} + \left(\frac{\Delta S_4^\circ + \Delta S_D^\circ}{2.303 R}\right) + 2 \log [M^+]_{aq} + 4 \log [SCN^-]_{aq} \\ & - \log(1 + \beta_1 [SCN^-]_{aq} + \beta_2 [SCN^-]_{aq}^2 + \beta_3 [SCN^-]_{aq}^3 + \beta_4 [SCN^-]_{aq}^4 \\ & + \sum_{jkl} K_{jkl} [SCN^-]_{aq}^j [Cl^-]_{aq}^k [CH_3COO^-]_{aq}^l) \dots\dots\dots(131) \\ & (k, l \text{ not both } 0) \end{aligned}$$

On the other hand, if the extraction occurs by an anion exchange-type mechanism (which includes the Cation Chelation Mechanism in the case where considerable sorption of some other ion pair, $M^+_{(aq)} + A^-_{(aq)}$, also occurs), then the distribution relation between the aqueous and foam phases will be:

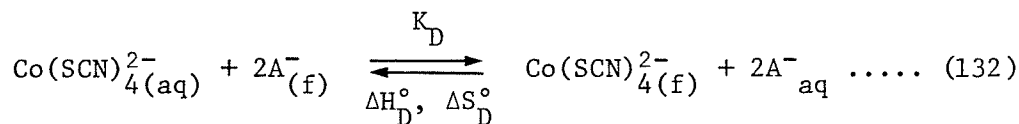

$$K_D = \frac{[Co(SCN)_4^{2-}]_f [A^-]_{aq}^2}{[Co(SCN)_4^{2-}]_{aq} [A^-]_f^2} \dots\dots\dots (133)$$

Applying to these equations a treatment similar to that taken for the solvent extraction-like model, we would get for the anion exchange situation:

$$D = \frac{K_D \beta_4 [A^-]_{aq}^2 [SCN^-]_{aq}^4}{[A^-]_f^2 (1 + \beta_1 [SCN^-]_{aq} + \beta_2 [SCN^-]_{aq}^2 + \beta_3 [SCN^-]_{aq}^3 + \beta_4 [SCN^-]_{aq}^4 + \sum_{jkl} K_{jkl} [SCN^-]_{aq}^j [Cl^-]_{aq}^k [CH_3COO^-]_{aq}^l)} \quad \dots\dots\dots (134)$$

(k, l not both 0)

and so:

$$\log D = - \left(\frac{\Delta H_4^\circ + \Delta H_D^\circ}{2.303} \right) \frac{1}{T} + \left(\frac{\Delta S_4^\circ + \Delta S_D^\circ}{2.303} \right) + 4 \log [SCN^-]_{aq} + 2 \log [A^-]_{aq} - 2 \log [A^-]_f - \log (1 + \beta_1 [SCN^-]_{aq} + \beta_2 [SCN^-]_{aq}^2 + \beta_3 [SCN^-]_{aq}^3 + \beta_4 [SCN^-]_{aq}^4 + \sum_{jkl} K_{jkl} [SCN^-]_{aq}^j [Cl^-]_{aq}^k [CH_3COO^-]_{aq}^l) \quad \dots\dots\dots (135)$$

(k, l not both 0)

Obviously, if values of each of the individual equilibrium constants in equations (131) and (135) at a number of different temperatures or the various thermodynamic quantities were known, log D and its temperature dependence could be calculated directly for either mechanism. Failing this, knowledge of some of these values but not others may allow determination of the unknown quantities by temperature dependence measurements and perhaps shed some light on the mechanism involved.

However, one finds that only very limited data of generally low dependability are available. For instance, for the four simple cobalt-thiocyanate species, $(Co(SCN)_i^{2-i})_{(aq)}$, Lehné⁽²²⁸⁾ made an attempt to estimate the overall formation constants, β_1 , β_2 , β_3 , and β_4 based on spectrophotometric measurements at ambient temperature and with uncontrolled ionic strength as $\beta_1 = 1000$, $\beta_2 = 1000$, $\beta_3 = 200$, $\beta_4 = 184$. Later,

Tribalat and Zeller⁽²¹⁵⁾ made a more refined measurement of the same things and reported approximate values for the overall formation constants as determined by spectrophotometry at 20°C on solutions containing 1.3 M NH_4^+ , 10^{-2} M acetate buffer (pH 5) and having a total ionic strength of 1.5 M as $\beta_1 = 9 \pm 1.5$, $\beta_2 = 40 \pm 15$, $\beta_3 = 60 \pm 20$, $\beta_4 = 0.5 \pm 0.3$.

The difference between these two sets of constants is striking. However, even these later values must be regarded as approximations only since work done by others⁽²²⁴⁾ to measure β_1 alone puts its value at anywhere from 0.35 to 59 and evaluation of β_2 by another group gave a value of 0.084! This large disparity among workers may arise partly out of differing solution conditions, etc. but likely reflects also the different methods of measurement used and their accuracies.

Similar problems exist for the species containing other ligands. For example, the formation constant, K_{010} (using the above nomenclature) of the $\text{CoCl}_{(aq)}^+$ ion has been measured⁽²³⁰⁾ to lie between 0.37 and 0.5 while that of $\text{CoCl}_{2(aq)}$ lies anywhere from $K_{020} = 0.05$ to 0.26. Likewise, the first two acetate complexes are assigned⁽²³⁰⁾ formation constants of $K_{001} = 33$ for $\text{Co}(\text{OOCCH}_3)_{(aq)}^+$ and $K_{002} = 85$ for $\text{Co}(\text{OOCCH}_3)_2(aq)$ by one group but K_{001} is evaluated as 0.60 by others. In addition to these large uncertainties, no formation constants for mixed ligand complexes at all are available and no assessments of the equilibrium constants at several temperatures nor of the various thermodynamic quantities have been made (with the exception of $\Delta H_1^\circ = -6.82 \text{ kJ mol}^{-1}$ and $\Delta S_1^\circ = 9.2 \text{ J K}^{-1} \text{ mol}^{-1}$ ⁽²³¹⁾). Also, of course, the value of the distribution constant, K_D , between water and foam has not previously been determined.

Thus, it appears that $\log D$ and its temperature dependence cannot be calculated directly.

It then remains for us to see whether or not we may use the present data as a means of determining any of these parameters. Returning for the moment to equation (131), we see that since each of $[M^+]_{aq}$, $[SCN^-]_{aq}$, $[Cl^-]_{aq}$ and $[CH_3COO^-]_{aq}$ is very large compared to the cobalt concentration, they must remain essentially constant during extraction. Similarly, in equation (135) the quantity $[A^-]_{aq}$ (assumed to be $SCN^-_{(aq)}$, $Cl^-_{(aq)}$ or $CH_3COO^-_{(aq)}$) must remain effectively constant and if we restrict ourselves to conditions under which almost all of the available sites are occupied by $A^-_{(f)}$ ions (i.e. at reasonably low cobalt and high $A^-_{(aq)}$ concentrations), the quantity $[A^-]_f$ may also be largely insensitive to temperature. Thus, in either case $\log D$ is expected to be a linear function of $(1/T)$ only if the values of ΔH° and ΔS° are nearly independent of temperature (approximately true for many condensed phase reactions over moderate temperature changes) and if the final term, $\log(1 + \beta_1[SCN^-]_{aq} + \beta_2[SCN^-]_{aq}^2 + \beta_3[SCN^-]_{aq}^3 + \beta_4[SCN^-]_{aq}^4 + \sum_{jkl} K_{jkl} [SCN^-]_{aq}^j [Cl^-]_{aq}^k [CH_3COO^-]_{aq}^l)$, is either also independent of temperature or inversely proportional to it. This expression would be strictly independent of temperature if the predominant term in the brackets were 1 - an occurrence which corresponds physically to the existence of $Co^{2+}_{(aq)}$ as the only significant cobalt-containing species in the aqueous phase. This situation might be anticipated if all of the possible ligands in solution were present at very low concentration. If this were so, equation (131) would simplify to:

$$\log D = - \left(\frac{\Delta H_4^\circ + \Delta H_D^\circ}{2.303 R} \right) \frac{1}{T} + \left(\frac{\Delta S_4^\circ + \Delta S_D^\circ}{2.303 R} \right) + 2 \log [M^+]_{aq} + 4 \log [SCN^-]_{aq} \dots\dots\dots (136)$$

and equation (135) to:

$$\log D = - \left(\frac{\Delta H_4^\circ + \Delta H_D^\circ}{2.303 R} \right) \frac{1}{T} + \left(\frac{\Delta S_4^\circ + \Delta S_D^\circ}{2.303 R} \right) + 4 \log [SCN^-]_{aq} + 2 \log [A^-]_{aq} - 2 \log [A^-]_f \dots\dots\dots (137)$$

We would then expect the slope, m, and intercept, b, of the lines to be, respectively:

$$\left. \begin{aligned} m &= - \left(\frac{\Delta H_4^\circ + \Delta H_D^\circ}{2.303 R} \right) \\ b &= \left(\frac{\Delta S_4^\circ + \Delta S_D^\circ}{2.303 R} \right) + 2 \log [M^+]_{aq} + 4 \log [SCN^-]_{aq} \end{aligned} \right\} \dots\dots\dots (138)$$

for a solvent extraction-like process or:

$$\left. \begin{aligned} m &= - \left(\frac{\Delta H_4^\circ + \Delta H_D^\circ}{2.303 R} \right) \\ b &= \left(\frac{\Delta S_4^\circ + \Delta S_D^\circ}{2.303 R} \right) + 4 \log [SCN^-]_{aq} + 2 \log [A^-]_{aq} - 2 \log [A^-]_f \end{aligned} \right\} \dots\dots (139)$$

for an ion exchange-like one.

We see from this that it might be possible to determine at least the sums $\Delta H_4^\circ + \Delta H_D^\circ$ and $\Delta S_4^\circ + \Delta S_D^\circ$ from the measured slope and intercept

(but only if the total exchange capacity, $[A^-]_f$, were known for the anion exchange case).

On the other hand, if some other species such as $Co(SCN)_j(Cl)_k(OOCCH_3)_\ell^{2-(j+k+\ell)}$ predominates in solution, then the final term in equations (131) or (135) becomes:

$$\begin{aligned} & \log(K_{jkl} [SCN^-]_{aq}^j [Cl^-]_{aq}^k [CH_3COO^-]_{aq}^\ell) \\ &= \log K_{jkl} + j \log [SCN^-]_{aq} + k \log [Cl^-]_{aq} + \ell \log [CH_3COO^-]_{aq} \\ &= - \frac{\Delta H_{jkl}^\circ}{2.303 RT} + \frac{\Delta S_{jkl}^\circ}{2.303 R} + j \log [SCN^-]_{aq} + k \log [Cl^-]_{aq} \\ & \quad + \ell \log [CH_3COO^-]_{aq} \end{aligned}$$

Making this substitution, equation (131) now gives:

$$\begin{aligned} \log D = & - \left(\frac{\Delta H_4^\circ + \Delta H_D^\circ - \Delta H_{jkl}^\circ}{2.303 R} \right) \frac{1}{T} + \left(\frac{\Delta S_4^\circ + \Delta S_D^\circ - \Delta S_{jkl}^\circ}{2.303 R} \right) + 2 \log [M^+]_{aq} \\ & + (4-j) \log [SCN^-]_{aq} - k \log [Cl^-]_{aq} - \ell \log [CH_3COO^-]_{aq} \\ & \dots\dots\dots (140) \end{aligned}$$

for a solvent extraction-like process and equation (135) becomes:

$$\begin{aligned} \log D = & - \left(\frac{\Delta H_4^\circ + \Delta H_D^\circ + \Delta H_{jkl}^\circ}{2.303 R} \right) \frac{1}{T} + \left(\frac{\Delta S_4^\circ + \Delta S_D^\circ + \Delta S_{jkl}^\circ}{2.303 R} \right) + 2 \log [A^-]_{aq} \\ & - 2 \log [A^-]_f + (4-j) \log [SCN^-]_{aq} - k \log [Cl^-]_{aq} - \ell \log [CH_3COO^-]_{aq} \\ & \dots\dots\dots (141) \end{aligned}$$

for an ion exchange one.

We now predict the slope and intercept of the line to be, in the first case:

$$\left. \begin{aligned} m &= - \left(\frac{\Delta H_4^\circ + \Delta H_D^\circ + \Delta H_{jkl}^\circ}{2.303 R} \right) \\ b &= \left(\frac{\Delta S_4^\circ + \Delta S_D^\circ - \Delta S_{jkl}^\circ}{2.303 R} \right) + 2 \log [M^+]_{aq} + (4-j) \log [SCN^-]_{aq} \\ &\quad - k \log [Cl^-]_{aq} - l \log [CH_3COO^-]_{aq} \end{aligned} \right\} (142)$$

or, in the second:

$$\left. \begin{aligned} m &= - \left(\frac{\Delta H_4^\circ + \Delta H_D^\circ - \Delta H_{jkl}^\circ}{2.303 R} \right) \\ b &= \left(\frac{\Delta S_4^\circ + \Delta S_D^\circ - \Delta S_{jkl}^\circ}{2.303 R} \right) + 2 \log [A^-]_{aq} - 2 \log [A^-]_f \\ &\quad + (4-j) \log [SCN^-]_{aq} - k \log [Cl^-]_{aq} - l \log [CH_3COO^-]_{aq} \end{aligned} \right\} (143)$$

The special case of any of the original four cobalt-thiocyanate complex ions being the predominant species is then given simply by allowing $k = l = 0$ in equations (131) or (135) with $\Delta H_{j00}^\circ = \Delta H_j^\circ$ and $\Delta S_{j00}^\circ = \Delta S_j^\circ$. From the expression for the slope, m , we would be able to determine the total enthalpy change, $\Delta H_4^\circ + \Delta H_D^\circ - \Delta H_{jkl}^\circ$, accompanying extraction no matter what the mechanism and even if the identity of the predominant species were unknown. However, without knowledge of the values of j , k and l , it would not be possible to determine the total

entropy change, $\Delta S_4^\circ + \Delta S_D^\circ - \Delta S_{jkl}^\circ$, from the intercept, b.

Under most conditions, we expect that a mixture of ions will exist in solution and that perhaps none of the species will truly predominate. In this case, $\log D$ will be related to $1/T$ in a rather complicated manner and, in general, a straight line will not result. Of course, linearity may still be observed in the absence of predominance but only in the fortuitous case in which the sum of the individual enthalpy changes remains constant while the fraction of the various species present changes. Regardless of whether linear or not, however, the slope of the tangent to the curve at any particular point will still reflect the enthalpy change accompanying the extraction starting from the "average" species in solution.

Although we must fully recognize the low dependability of any calculations based on the complex ion formation constants referred to earlier, we may nevertheless try to use them to obtain some notion of whether or not species predominance will exist under any conditions. To do this, those available constants which would tend to show the least formation of Co-SCN complexes and the most of other types have been deliberately chosen on the one hand so as to demonstrate the worst possible case and the reverse selection process carried out on the other to show the more favourable side. Using these two sets of values, the relative abundances, α , of the various cobalt-containing species expected at room temperature and at the thiocyanate concentrations used in the experiment have been calculated and appear in Table II-14.

It will be noted from the upper values in the Table that near room

TABLE II-14 - EXPECTED APPROXIMATE RELATIVE ABUNDANCES OF VARIOUS COBALT-CONTAINING IONS IN AQUEOUS SOLUTIONS NEAR ROOM TEMPERATURE WITH VARIOUS CONCENTRATIONS OF SCN^- , Cl^- AND CH_3COO^-

[SCN ⁻] (M)	[Cl ⁻] (M)	[CH ₃ COO ⁻] (M)	Fractional abundance, α, of Ion*												
			Co ²⁺	Co(SCN) ⁺	Co(SCN) ₂ ⁺	Co(SCN) ₃ ⁺	Co(SCN) ₄ ²⁻	CoCl ⁺	CoCl ₂	Co(OOCCH ₃) ⁺	Co(OOCCH ₃) ₂				
0.010	1.99	0.88	0.0102	0.0009	0.0000	0.0000	0.0000	0.0102	0.0105	0.2964	0.6717				
			(0.0796)	(0.7960)	(0.0080)	(0.0000)	(0.0000)	(0.0586)	(0.0158)	(0.0420)	(-)				
0.050	1.95	1.00	0.0082	0.0037	0.0008	0.0001	0.0000	0.0080	0.0081	0.2716	0.6995				
			(0.0182)	(0.9085)	(0.0454)	(0.0004)	(0.0000)	(0.0131)	(0.0034)	(0.0034)	(-)				
0.25	1.75	0.80	0.0097	0.0218	0.0242	0.0091	0.0000	0.0085	0.0077	0.2814	0.6376				
			(0.0031)	(0.7845)	(0.1961)	(0.0098)	(0.0023)	(0.0020)	(0.0005)	(0.0005)	(-)				
1.00	1.00	0.88	0.0048	0.0437	0.1941	0.2911	0.0024	0.0024	0.0013	0.1409	0.3193				
			(0.0004)	(0.4191)	(0.4191)	(0.0838)	(0.0771)	(0.0002)	(0.0000)	(0.0000)	(-)				
5.00	0	0.88	0.0001	0.0050	0.1117	0.8377	0.0349	0.0000	0.0000	0.0032	0.0074				
			(0.0000)	(0.0294)	(0.1471)	(0.1471)	(0.6765)	(0.0000)	(0.0000)	(0.0000)	(-)				

* Calculated using the following overall formation constants (224, 230):

Upper values - Co(SCN)⁺, 9; Co(SCN)₂, 40; Co(SCN)₃⁻, 60; Co(SCN)₄²⁻, 0.5; CoCl⁺, 0.5; CoCl₂, 0.26; Co(OOCCH₃)⁺, 33; Co(OOCCH₃)₂, 85

Lower Values (in brackets) - Co(SCN)⁺, 1000; Co(SCN)₂, 1000; Co(SCN)₃⁻, 200; Co(SCN)₄²⁻, 184; CoCl⁺, 0.37; CoCl₂, 0.5; Co(OOCCH₃)⁺, 0.60; Co(OOCCH₃)₂, not available

All other ions, if present, have been ignored in the calculations. Many more than sufficient significant figures have been retained to show trends.

temperature we expect the acetate species of cobalt to predominate when thiocyanate concentrations are low but that this may be altered to favour $\text{Co}(\text{SCN})_3^-$ at the highest thiocyanate concentration. However, when the lower values in the Table are examined, it appears that $\text{Co}(\text{SCN})_{(\text{aq})}^+$ will be the predominant species in solution at low thiocyanate concentrations whereas $\text{Co}(\text{SCN})_4^{2-}$ will be the largest but not truly predominant species at high thiocyanate concentration.

To try to decide which of these extremes is closer to the truth, room temperature electronic absorption spectra were measured in 10 cm cuvetts on solutions identical to those used in the experiments but containing 1.7×10^{-4} M (10.0 ppm) Co(II) instead. The intensities at low $[\text{SCN}^-]_{\text{aq}}$ are very small and thus do not provide much information at all. However, at high $[\text{SCN}^-]_{\text{aq}}$ (5.0 M), the spectrum displayed a maximum near 610 nm with a molar absorptivity, ϵ , of $250 \text{ cm}^{-1} \text{ mol}^{-1} \text{ L}$ and appeared similar in shape to that reported by Tribalat and Zeller⁽²¹⁵⁾ to be due to $\text{Co}(\text{SCN})_4^{2-}$ ($\lambda_{\text{max}} = 620 \text{ nm}$, $\epsilon \approx 360 \text{ cm}^{-1} \text{ mol}^{-1} \text{ L}$). One would guess from this that some mixture probably exists under these conditions which contains a large fraction of $\text{Co}(\text{SCN})_4^{2-}$ and perhaps smaller amounts of one or more other species. Based on this observation and on some others dealing with the small interfering effects of acetate ions on extraction even when complexes with cobalt are predicted to predominate by the upper abundance values in Table II-14, it seems that the lower values may be closer to describing equilibrium conditions in this experiment even though they may still not be nearly correct.

Regardless of the situation at room temperature, predicting the predominant species at other temperatures is nearly impossible since

there are essentially no data available. As a result, we are clearly unable to assign the observed temperature dependence of extraction to the appropriate extraction steps involved and so cannot determine the entropy change from the intercept of the log D versus $1/T$ line. Nevertheless, as we have pointed out, the total standard enthalpy change, $\Delta H_{\text{total}}^{\circ}$, of the net extraction equilibrium under the conditions then existing will be given by the slope of the tangent to the curve at any particular point even though we do not know what proportion of it to ascribe to the various individual equilibria.

Returning now to the data as displayed in Figures 2-18 and 2-19, we may observe a number of important features which are worth discussing. First of all, from Figure 2-18, we see that the distribution ratio increases very markedly with decreasing temperature and we interpret this to indicate that the solution concentration of the extractable species, whatever it may be, must be increasing. Moreover, we see that at sufficiently low temperatures, for at least three different thiocyanate concentrations (0.25 M, 1.00 M and 5.00 M), D assumes the same large value of about $3 \times 10^6 \text{ L kg}^{-1}$ within experimental error. The fact that the distribution ratio is then independent of thiocyanate concentration over a 20-fold change suggests that some species which either does not contain thiocyanate at all or which is perhaps coordinatively saturated with the ligand must then predominate in solution. We have previously shown under almost identical solution conditions that the former possibility is not correct since extraction is very thiocyanate dependent at low $[\text{SCN}^-]_{\text{aq}}$ (see Figure 2-13) and we have deduced from this and other information that the extractable species is, in fact, $\text{Co}(\text{SCN})_4^{2-}(\text{aq})$.

That the predominant species in solution at low temperatures must also be this ion is apparent from the fact that the distribution ratio is so extraordinarily large and constant under these conditions. If, for example, $\text{Co}(\text{SCN})_3^-$ were the predominant species instead (as predicted for room temperature by some of the formation constants presented earlier) and $\text{Co}(\text{SCN})_4^{2-}$ represented only perhaps 10% of the cobalt-containing species, we should expect up to a 10-fold increase in D with further increases in thiocyanate concentration. Since we are increasing $[\text{SCN}^-]_{\text{aq}}$ 20-fold without observing any large increase in D, and since it already rivals known maximum distribution ratios for either solvent extraction or ion exchange processes, we conclude that $\text{Co}(\text{SCN})_4^{2-}$ is the predominant species in solution when temperatures are sufficiently low and thiocyanate concentrations are sufficiently high.

Turning now to Figure 2-19 where log D is plotted as a function of the inverse absolute temperature, we notice that each curve contains non-linear as well as nearly linear portions but with the degree of linearity being somewhat different for each curve. This is as predicted by our notion of predominance of species and therefore constancy of $\Delta H_{\text{total}}^\circ$ occurring only under certain very specific circumstances (temperature, thiocyanate concentration and likely other factors as well). Where non-linear portions exist, more than one species is definitely deduced to be present with the proportions changing with temperature. Portions in which linearity is observed may (but need not necessarily) result from predominance of an individual species.

Taking the slope, m, of the nearly linear sections of each curve in

Figure 2-19 and applying the relation $\Delta H_{\text{total}}^{\circ} = -2.303 m R$, we obtain values for the overall enthalpy change accompanying the process. These values have been collected in Table II-15 and show that $\Delta H_{\text{total}}^{\circ}$ is fairly large and exothermic. Moreover, results which are similar within experimental error (about -180 kJ mol^{-1}) were obtained for each of the four lowest thiocyanate concentrations. It would be tempting to suggest that the same unknown species may predominate in each of these cases. However, several of the curves are not strictly linear and so may reflect complex mixtures of species which happen to differ in energy from the extractable species by similar amounts. Whichever is the case, the predominant species present in 5.00 M thiocyanate at high temperatures appears to differ from the rest since $\Delta H_{\text{total}}^{\circ}$ is considerably less exothermic there ($-91.5 \text{ kJ mol}^{-1}$). Although the ionic strength in this experiment (5.88 M) differs from that of the others (2.88 M or 3.00 M), this is not likely the reason for the difference since calculations based on the small amount of data still usable from the aborted sixth experiment with 2.00 M $\text{SCN}^{-1}_{(\text{aq})}$ and ionic strength 3.00 M gave a value of approximately -134 kJ mol^{-1} , still in line with the apparent trend. It seems likely that the species predominant in 5.00 M thiocyanate will contain several SCN^{-} ligands and may, in fact, be $\text{Co}(\text{SCN})_{3(\text{aq})}^{-}$ but it is not really possible to identify it with any confidence.

Considering, now, any one particular curve in Figure 2-19 corresponding to some fixed concentration of thiocyanate (and other ligands) and applying the relation $\Delta H_{\text{total}}^{\circ} = -2.303 mR$ to the tangent at various points, we see that the slope, m , becomes smaller and thus $\Delta H_{\text{total}}^{\circ}$ becomes less exothermic as lower solution temperatures are approached. In

TABLE II-15 THERMODYNAMIC DATA CALCULATED FROM TEMPERATURE EFFECT ON
COBALT EXTRACTION (LOG D VERSUS 1/T)

Initial Conditions

[Co] 1.7 x 10⁻⁵ M (1.0 ppm)
 Solution Volume (V) 150.0 mL
 Foam Weight (W) 0.050 grams
 Type #1338 BFG

[SCN ⁻] (M)	Ionic Strength (M)	Linear Temperature Range (K)	Number, n, of Points Included	Slope, m (K)	ΔH° total (kJ mol ⁻¹)
0.010	2.88	275.8 - 288.6	6	9400 ±200	-179 ±4
0.050	3.00	283.8 - 303.2	5	10300 ±900	-197 ±17
0.25	2.88	293.0 - 318.6	6	9100 ±1300	-174 ±25
1.00	2.88	313.0 - 348.2	8	8900 ±500	-170 ±10
5.00	5.88	327.6 - 368.2	11	4780 ±70	-91.5 ±1.3

- Notes: 1. Uncertainties quoted are approximately 95% confidence intervals based on n-1 degrees of freedom
 2. R is the Universal Gas Constant = 8.31431 J K⁻¹ mol⁻¹.
 3. ΔH° has been assumed to be approximately independent of temperature.

the limit, moreover, the slope of the curve and thus $\Delta H_{\text{total}}^{\circ}$ appears to tend to a value somewhere near zero at lower temperatures (at least for 0.25 M, 1.00 M and 5.00 M $\text{SCN}^-_{(\text{aq})}$).

We must attribute this shift in $\Delta H_{\text{total}}^{\circ}$ to the combined effect of decreases in the enthalpy of the average cobalt-containing or M^+ species in the aqueous phase, increases to that in the foam phase, or a combination of the two. Since there are probably many more equilibria involved in the aqueous phase than in foam and at least one of them is exothermic ($\Delta H_1^{\circ} = -6.82 \text{ kJ mol}^{-1}$ (231)), likely a very large portion of the change observed with decreasing temperature arises out of shifts in these equilibria toward species more closely related to the extractable one, $\text{Co}(\text{SCN})_4^{2-}_{(\text{aq})}$.

If we were able to ignore the effects of all ligands except thiocyanate, it might be possible to judiciously guess what several of the predominant species indicated by linear portions in the curves of Figure 2-19 might be. However, with one exception, the presence of other ligands in significant amounts complicates matters sufficiently that we are unable to say with any confidence what species, if any, may be predominant under any particular conditions. The exception to this is the already-mentioned circumstance in which D reaches its maximum value at high thiocyanate concentration and/or low temperature. In this case, the predominant species is evidently $\text{Co}(\text{SCN})_4^{2-}_{(\text{aq})}$ and we view the net extraction equilibrium as either:

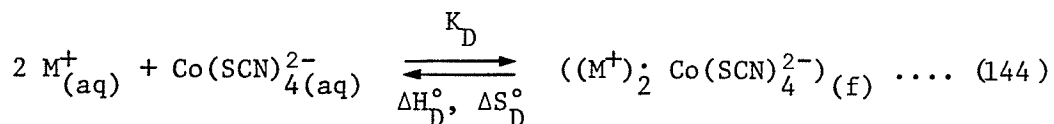

if it is a solvent extraction-like phenomenon or:

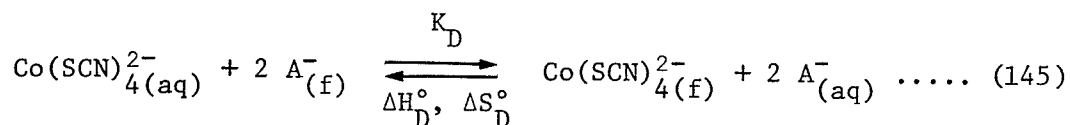

if it is of the ion exchange type.

Equations (131) and (135) describing the dependence of D then reduce to:

Solvent extraction:

$$\log D = \frac{-\Delta H_D^\circ}{2.303 R} \left(\frac{1}{T}\right) + \frac{\Delta S_D^\circ}{2.303 R} + 2 \log [M^+]_{\text{aq}} \dots\dots\dots (146)$$

Ion exchange:

$$\log D = \frac{-\Delta H_D^\circ}{2.303 R} \left(\frac{1}{T}\right) + \frac{\Delta S_D^\circ}{2.303 R} + 2 \log [A^-]_{\text{aq}} - 2 \log [A^-]_{\text{f}} \dots\dots\dots (147)$$

From this, we conclude that the slope, m, and intercept b, are given by:

Solvent extraction:

$$\left. \begin{aligned} m &= \frac{-\Delta H_D^\circ}{2.303 R} \\ b &= \frac{\Delta S_D^\circ}{2.303 R} + 2 \log [M^+]_{\text{aq}} \end{aligned} \right\} \dots\dots\dots (148)$$

Ion exchange:

$$\left. \begin{aligned}
 m &= \frac{-\Delta H_D^\circ}{2.303 R} \\
 b &= \frac{\Delta S_D^\circ}{2.303 R} + 2 \log [A^-]_{\text{aq}} - 2 \log [A^-]_f
 \end{aligned} \right\} \dots\dots\dots (149)$$

Unfortunately, there are so few data points in this region of Figure 2-19 and those present are of such comparatively high uncertainty that it is very difficult to assign dependable values to either m or b. However, making graphical estimates of the probable uncertainties involved, we might assign $m \approx 0 \pm 1000 \text{ K}$ and $b \approx 6.3 \pm 3.6$. Using these values, we may calculate the enthalpy change of the distribution equilibrium to be:

Solvent extraction or ion exchange:

$$\Delta H_{\text{total}}^\circ = \Delta H_D^\circ \approx 0 \pm 20 \text{ kJ mol}^{-1}$$

for either mechanism. Determination of the entropy change requires, in the case of the solvent extraction-like mechanism, that we know the aqueous concentration of the cation, $[M^+]_{\text{aq}}$, which accompanies the extractable species. If we assume that either Na^+ or K^+ will be effective in this capacity and use the results for the 5.00 M $\text{SCN}^-_{(\text{aq})}$ curve (where $[M^+]_{\text{aq}} = 5.88 \text{ M}$) we obtain:

Solvent extraction:

$$\Delta S_{\text{total}}^\circ = \Delta S_D^\circ \approx + 90 \pm 70 \text{ J K}^{-1} \text{ mol}^{-1}$$

On the other hand, if an ion exchange type of mechanism is involved, we must know the concentration of the anion, A^- , in each of the phases. For the experiment in which we have 5.00 M $SCN^-_{(aq)}$ and only 0.88 M $CH_3COO^-_{(aq)}$ present, it is reasonable to assume that A^- will be chiefly SCN^- and therefore $[A^-]_{aq} \approx 5.00$ M. As mentioned much earlier, we have deduced that this is normally true from the weight increases measured on polyurethane foam in equilibrium with solutions containing high and low concentrations of that ion. Also, if we suppose that at these high concentrations of both cations, M^+ , and anions, A^- , the polymer must have nearly all possible sites filled and available for exchange, then we may use the measured capacity of the foam (about 0.94 equivalent per kilogram) for $[A^-]_f$. Thus, from equation (149) we have:

Ion exchange:

$$\Delta S_{total}^{\circ} = \Delta S_D^{\circ} \approx 90 \pm 70 \text{ J K}^{-1} \text{ mol}^{-1}$$

and the result is identical to that obtained above for the solvent extraction-like mechanism. Although the large estimated uncertainty in these results makes them less useful than might otherwise be the case, we may still derive some important information from them.

First of all, the small value of ΔH_D° as determined here confirms our earlier suggestion that the enthalpy change accompanying distribution of the extractable species to the foam phase would not likely be large compared to that attributable to the various solution equilibria. The fact that ΔH_D° is as small as it is, however, indicates very similar enthalpy states of the system (foam + solution) before and after extraction has

taken place.

If we view the process as a solvent extraction with ion pairing then the equilibrium relation is:

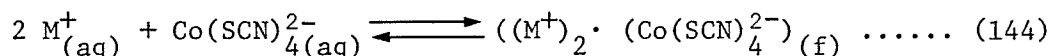

We conclude then that the enthalpy released in ion pairing and in solvating the ion pair in the polymer must be sufficient to compensate for the dehydration of the three aqueous ions. Since hydration enthalpies at least for the small ions, $M_{(aq)}^+$, are reasonably high (-406 kJ mol^{-1} for Na^+ , -322 kJ mol^{-1} for $K^{+(201)}$), this means that solvation and ion pairing in the polyurethane must be very effective.

If, instead, we suppose that the ions will be largely unpaired within the polymer, then the equilibrium will be:

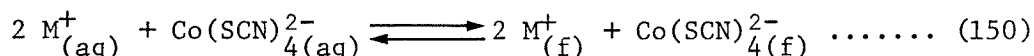

and we are forced to assume that even more effective ion solvation is taking place. This may be possible if considerable water accompanies the ions into the foam or if the cations are chelated in some way by the polyurethane as proposed by the Cation Chelation Mechanism.

However, if the mechanism is more correctly described as an ion exchange process, the equilibrium relation will be:

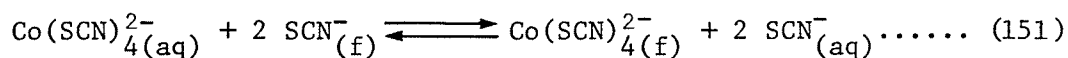

and the problem of explaining the small enthalpy change disappears since the difference in hydration enthalpies between these ions is not expected to be at all large. In fact, small enthalpy changes (typically not more than 8 to 13 kJ mol⁻¹(232)) are characteristic of ion exchange phenomena and we may take the observed value of ΔH_D° to be somewhat supportive of this type of mechanism.

If we now consider the entropy change calculated to be occurring, we are struck by the fact that it is in all probability at least slightly positive and perhaps largely so. This means on the molecular level that the state existing after extraction must be more disordered than that before extraction and since $\Delta H_D^\circ \approx 0$, the increase in entropy is then the chief factor contributing to the occurrence of cobalt sorption.

If we attempt to rationalize this apparent increase in entropy by guessing the entropy changes to be expected for each of the components of the system (ions + water + foam), several important conclusions may be reached. If, for example, either of the solvent extraction-like mechanisms (equations (144) or (150)) are correct, then we expect both of the extracted species, Na⁺ and Co(SCN)₄²⁻, to suffer reasonable losses of entropy (i.e. freedom) in being transferred from a free-flowing liquid in which they are able to travel widely along with any attached solvent shell, to a polymeric material in which motions are limited and any strong associations with "solvent" must be broken in order for translational motion to occur. This would be especially true in the ion-paired case (equation (144)) where loss of freedom is almost complete. The water of the aqueous phase, on the other hand, would definitely gain freedom by the removal of the ions (the two cations, in particular, since they are highly solvated).

However, considering how well solvated we have concluded the products in equations (144) or (150) must be in order to account for the small ΔH_D° values, the increased freedom of the water may well be expected to be offset by a corresponding increase in order in the polyurethane required to achieve this very effective solvation. The fact that the net result of all this is a significant increase in entropy must mean, in fact, that very little additional ordering of the polymer is needed to entirely solvate the extracted ions if a solvent extraction-like process is being followed. This conclusion will have some significance later when we consider the Cation Chelation Mechanism more fully.

Now, considering an ion exchange-like process (equation (151)), we may similarly argue that some loss of freedom will result from transferring an anion from the fluid aqueous phase to the viscous polyurethane phase (although solvation of the anions in either phase should not be as great as for cations). Thus, since the products side of equation (151) contains only one anion trapped within the polyurethane phase while the reactants side contains two, we conclude that there should be an increase in entropy based only on the exchanged species. On the other hand, since both anions are fairly bulky and probably better solvated by foam than by water, we expect that little change in freedom of the water will accompany extraction but that a further increase in entropy of the polyurethane may result from the decrease in the number of ions present there. Thus, an increase in entropy is again predicted.

We conclude, then, on the basis of our predictions and the positive entropy change measured that the mechanism of extraction may be one of ion exchange under conditions of low temperature and high thiocyanate concentration. Alternatively, if very little ordering of the polymer is

postulated to occur on extraction, a solvent extraction-like process may be the case.

Forgetting for the moment our interpretations and concentrating instead on the industrial or analytical uses of foam cobalt sorption, the results of this experiment are again seen to be particularly important. In the first place, Figure 2-18 shows that extraction generally improves dramatically as the temperature of the system is decreased. This has obvious implications for attaining the highest possible extraction efficiency either for mineral or radiochemical recovery processes and also, of course, for preconcentration or semiquantitative analysis based on the colour developed.

Additionally, we see that extraction apparently tends to the same maximum value with decreasing temperature almost regardless of thiocyanate concentration. From an industrial or even large-scale analytical point of view, this can result in large economies of SCN^- usage simply by cooling the extraction system. For example, from Figure 2-18 we see that a concentration of somewhere between 0.05 M and 0.25 M SCN^- would be just as effective as 5.0 M SCN^- when cooled to near 0°C and would result in very substantial materials cost savings. Of course, even greater economies of thiocyanate reagent can be tolerated if larger foam weights relative to solution volume are also feasible.

Seen from another point of view, the high temperature sensitivity of cobalt sorption itself can be useful since it means that a great deal of control (at least five orders of magnitude difference in D) is available for batch or column separation processes simply by altering the temperature. Together with control of the solution thiocyanate concentration

and pH, this property is expected to allow separations from a variety of other metals to be feasible.

A further point to be made regarding the experiment is that since we have demonstrated that the same equilibrium is achieved when approached from either higher or lower temperatures over a very wide range, the sorption process is completely reversible under a variety of conditions. Thus, it is not only feasible to use low temperatures to increase sorption efficiency but it is equally feasible to effect desorption and recovery simply by heating the system. This has implications not only for batch extractions carried out for various purposes but also for column chromatographic separations where temperature control is possible.

8. Effect of Ionic Strength on Cobalt Sorption from Thiocyanate Solution

It was desired to determine what effect changes in the solution ionic strength might have on the sorption of cobalt from aqueous thiocyanate solutions.

Prior to being able to accomplish this, however, it was first necessary to select a reagent which would act as nearly as possible as an inert salt in the extraction process and this was not considered to be an easy task especially in the absence of prior information about the mechanism whereby this occurs. Thus, some preliminary tests were undertaken shortly after the phenomenon of cobalt sorption was discovered to try to establish what might be a suitable salt for use in maintaining the ionic strength constant while changing other solution parameters in the various experiments which were planned to follow.

The preliminary tests were carried out for a small number of common sodium salts (NaCl, NaBr, NaI, NaNO₃, NaOOCCH₃, Na₂SO₄ and Na₂CO₃) simply by adding a sufficient weight of each individual salt to solutions which also contained 1.0 M NH₄SCN, 2.12 x 10⁻⁵ M (1.25 ppm) Co(II) and ⁶⁰Co tracer so that they would then be 1.0 M in the added salt as well. The process of equilibration between 0.02 gram pieces of #1338 BFG polyurethane foam and the solution was then followed closely by measuring the ⁶⁰Co content over a period of three days. Samples were withdrawn for counting and observation ten times during this period to obtain a complete sorption/time profile for each salt. The use of such a long time span was necessitated by a wish to obtain some additional information from the data about the stability of the system foam + SCN⁻ + Co(II) in

the presence of each salt. Since no temperature regulation mechanism was then in place on the squeezing apparatus, equilibration was carried out at room temperature (about $22 \pm 2^\circ\text{C}$) and therefore may have fluctuated slightly (although no large variations happened to occur during that time). No buffers were used in the experiment in order to simplify the solution chemistry as much as possible. By comparing the results obtained with each of the salts to one another and to that of a blank containing no additives, it was hoped that several might show quantitatively similar effects and could then be considered as likely "inert".

In selecting the salts to be tested in this preliminary trial, only those which were readily available in high purity, inexpensive and likely to remain almost entirely in the aqueous phase were considered. A notable omission, therefore, was sodium perchlorate (NaClO_4) which was feared might oxidize SCN^- and/or polyurethane foam and was also suspect for reasons of being slightly lipophilic in nature.

The cobalt distribution ratios, as measured after 24 hours of equilibration, along with several observations made in the preliminary experiment are displayed in Table II-16. The results, although approximate, show that most salts tested promote the extraction of cobalt into the polyurethane phase to different extents but that a few depress sorption. Several salts appeared to depart from the norm in this comparison. For example, sodium acetate appears to have enhanced sorption slightly perhaps by formation of a small amount of some extractable cobalt/acetate complex. Sodium carbonate, by contrast, adversely affected the position of equilibrium perhaps also by complexation of cobalt (there was no evidence of cobalt-containing precipitates forming as would be the case if the difference were one of pH only). However, the group NaCl , NaBr and NaNO_3

TABLE II-16 EFFECT OF SEVERAL SODIUM SALTS ON COBALT EXTRACTION - PRELIMINARY RESULTS

Initial Conditions:

[SCN⁻] 1.0 M (NH₄SCN)
 [Co] 2.12 x 10⁻⁵ M (1.25 ppm)
 Solution Volume (V) 150.0 ml
 Foam Weight (W) 0.020 grams
 Type #1338 BFG
 Squeezing Time 24 hours
 Temperature ambient (~22±2°C)

Sample Number	Added Salt	D (L kg ⁻¹)	Comments
1	none	1.51 x 10 ⁵	-
2	1.0 M NaCl	1.86 x 10 ⁵	-
3	1.0 M NaBr	1.76 x 10 ⁵	-
4	1.0 M NaI	1.15 x 10 ⁵	-foam turns slightly brown -sorbed cobalt released slowly
5	1.0 M NaNO ₃	1.78 x 10 ⁵	-
6	1.0 M NaOOCCH ₃	2.12 x 10 ⁵	-foam brighter blue colour
7	1.0 M Na ₂ SO ₄	1.51 x 10 ⁵	-very slow sorption
8	1.0 M Na ₂ CO ₃	5.23 x 10 ²	-very pale blue foam

($D = 1.86, 1.76$ and $1.78 \times 10^5 \text{ L kg}^{-1}$, respectively) seemed fairly similar in their behaviour within the relatively low precision of the experiment and so were assumed possibly to fulfill the stated requirements for an "inert" salt. Of these three, sodium chloride was chosen for use in all later experiments because of its available high purity and low cost.

From the sorption/time profiles (not shown), it was apparent that all of the salts tested (except for NaI) were stable toward the system over the 3 day period. Sodium iodide, judging from the appearance of a yellow colour in solution, appeared to suffer oxidation by air and some interference was evidently produced by the I_2 formed such that some originally sorbed cobalt was returned to solution. Sodium sulfate, on the other hand, seemed to retard the attainment of equilibrium with foam in some unknown way.

Although the results of the preliminary tests provided the basis on which a salt was selected for practical use in the experiments to follow it, the dependence of cobalt sorption on solution ionic strength still remained to be established. Since the use of sodium perchlorate in such studies is traditional and since it was later discovered apparently not to oxidize either SCN^- or foam as was feared, one such study (Experiment # 1) was performed using NaClO_4 as the "inert" salt along with another (Experiment # 2) employing NaCl instead for comparison.

In designing the experiments, it was desired to maintain the solution pH relatively constant without having to resort to a buffer (which would both increase the minimum ionic strength achievable and complicate the solution equilibria). Therefore, the pH was fixed at 1.0 by the use of

0.10 M acid (HClO_4 or HCl as appropriate) in each solution. Two 250 mL stock mixtures containing NaSCN , Co(II) and either 70% HClO_4 or 12 M HCl were prepared such that 20.00 mL of the stock would produce a solution containing 0.100 M NaSCN , 1.7×10^{-6} M (0.10 ppm) Co(II) and 0.10 M of the acid when diluted to 150.0 mL. Various weights of the salts (NaClO_4 or NaCl) were then weighed into beakers, dissolved and transferred quantitatively to 150 mL volumetric flasks followed by a 20.00 mL aliquot of the appropriate stock solution and sufficient ^{60}Co tracer to yield an initial count rate of 500-600 seconds $^{-1}$. One solution containing both NaCl and NaClO_4 was also prepared with HCl as acid to test the effect on sorption of equal amounts of the two possible anions. All solutions were diluted nearly to the mark, mixed and allowed to sit overnight before final volume adjustments and mixing. A summary of the initial solution conditions appears at the top of Table II-17.

The solutions were poured into awaiting distribution cells containing 50 mg #1338 BFG foam pieces and sealed with double condoms and silicone grease at the ground glass joints. Equilibration between foam and solution was carried out in the usual manner with samples being withdrawn after 6, 12 and 24 hours for counting. No corrections were made to the radiometric data to allow for possible spectrometer drift but counting tubes were covered with polyvinylchloride film during use to reduce evaporative losses as much as possible. After the 24 hour equilibration period had elapsed, the solution pH was checked by meter to ensure that no large changes had occurred.

A few visual observations were made during the course of the experiment which are worth noting. First of all, paralleling the measured

cobalt sorptions, many of the foam pieces did not assume any discernible colouration in contact with solutions of low ionic strength while blue or green colours developed in higher ionic strength media. Secondly, it was observed that the foam pieces acquired pink colours after very brief squeezing in those solutions in which a large amount of added salt was present. Much more of this pink colouration was noted when NaCl was the salt used than was the case for NaClO_4 . When observed, however, this colour generally reduced in intensity as cobalt was sorbed and the expected blue or green colouration appeared in its place. As for many previous experiments, these observations were interpreted to be indicative of the unavoidable presence of iron in both NaClO_4 and NaCl but at a higher concentration in the latter case. Although obviously present, because of the seemingly low distribution ratio for iron as compared to cobalt (observed in many previous instances), its presence as a contaminant is not expected to influence strongly the outcome of the experiments at hand.

The experimental results are presented in Table II-17 and in Figure 2-20 which show the percentage of cobalt extracted and calculated distribution ratio as a function of the concentration of added NaClO_4 (Experiment #1) or NaCl (Experiment #2). From both, we see that cobalt sorption by foam is generally increased by the addition of a sodium salt to the solution (in agreement with the preliminary tests carried out earlier) and that the increase achieved is quite a dramatic one. Nevertheless, we note that the effects of NaClO_4 and NaCl are quite different. To be specific, the extraction of cobalt is seen to decline with the

TABLE II-17 EFFECT OF SOLUTION IONIC STRENGTH ON COBALT EXTRACTION

Initial Conditions:

[SCN⁻] 0.100 M (NaSCN)
 [Co] 1.7 x 10⁻⁶ M (0.10 ppm)
 Ionic Strength (I) 0.2 to 6.0 M (NaClO₄ or NaCl)
 pH 1.0 (0.1 M HClO₄ or HCl)
 Solution Volume (V) 150.0 mL
 Foam Weight (W) 0.050 grams
 Type #1338 BFG
 Squeezing Time 24.0 hours
 Temperature 25.00°C

Experiment #1: pH fixed with 0.100 M HClO₄
 Ionic strength controlled with NaClO₄

Sample Number	[NaClO ₄] (M) ±1%	Ionic Strength (M) ±1%	Foam Weight (mg) ±0.01	Cobalt Extracted (%)	D (L kg ⁻¹)	log D
1	0.000	0.201	47.04	5.2 ±0.6	1.76 ±0.18 x 10 ²	2.25 ±0.05
2	0.091	0.292	50.67	4.3 ±0.4	1.34 ±0.11 x 10 ²	2.13 ±0.04
3	0.293	0.494	49.05	3.8 ±0.4	1.21 ±0.11 x 10 ²	2.08 ±0.04
4	0.489	0.690	50.23	4.4 ±0.4	1.36 ±0.12 x 10 ²	2.13 ±0.04
5	0.825	1.026	51.02	5.7 ±0.4	1.78 ±0.13 x 10 ²	2.250 ±0.031
6	1.743	1.944	49.85	12.9 ±0.4	4.47 ±0.14 x 10 ²	2.650 ±0.013
7	2.837	3.038	46.25	30.0 ±0.5	1.390 ±0.024 x 10 ³	3.143 ±0.008
8	3.83	4.03	48.01	59.8 ±0.4	4.65 ±0.05 x 10 ³	3.668 ±0.004
9	4.84	5.04	49.50	84.09 ±0.34	1.60 ±0.04 x 10 ⁴	4.205 ±0.010
10	5.70	5.90	49.24	94.1 ±0.5	4.8 ±0.4 x 10 ⁴	4.685 ±0.033

TABLE II-17 - continued

Experiment #2: pH fixed with 0.100 M HCl
 Ionic strength controlled with NaCl

Sample Number	[NaCl] (M) ±1%	Ionic Strength (M) ±1%	Foam Weight (mg) ±0.01	Cobalt Extracted (%)	D (L kg ⁻¹)	log D
1	0.000	0.200	51.37	10.5 ±0.4	3.43 ±0.14 × 10 ²	2.536 ±0.018
2	0.100	0.300	49.53	11.0 ±0.4	3.72 ±0.12 × 10 ²	2.571 ±0.014
3	0.300	0.500	50.47	12.17 ±0.34	4.12 ±0.12 × 10 ²	2.615 ±0.012
4	0.500	0.700	46.80	14.4 ±0.4	5.38 ±0.14 × 10 ²	2.731 ±0.012
5	0.800	1.000	49.53	21.2 ±0.5	8.15 ±0.18 × 10 ²	2.911 ±0.010
6	1.800	2.000	47.04	56.0 ±0.4	4.06 ±0.05 × 10 ³	3.608 ±0.005
7	2.801	3.001	50.53	88.5 ±0.4	2.29 ±0.07 × 10 ⁴	4.360 ±0.014
8	3.80	4.00	46.30	97.38 ±0.32	1.20 ±0.15 × 10 ⁵	5.08 ±0.05
9	4.80	5.00	47.63	99.38 ±0.32	5.0 ±2.6 × 10 ⁵	5.70 ±0.22
10	1.35 M NaCl +1.45 M NaClO ₄	3.00	49.44	49.45 ±0.30	2.969 ±0.026 × 10 ³	3.473 ±0.004

Figure 2-20

Effect of ionic strength on the sorption of cobalt by polyurethane foam from aqueous thiocyanate solutions using two different "inert" salts. Equilibrium was reached over 24 hours between 50 mg #1338 BFG foam pieces and 150.0 mL of solution at 25.00°C. All solutions initially contained 1.7×10^{-6} M Co(II) and other reagents as follows:

—□—	0.100 M NaSCN
	0.10 M HClO ₄
	0-5.7 M NaClO ₄
—○—	0.100 M NaSCN
	0.10 M HCl
	0-4.8 M NaCl
▽	0.100 M NaSCN
	0.10 M HCl
	1.35 M NaCl
	1.45 M NaClO ₄

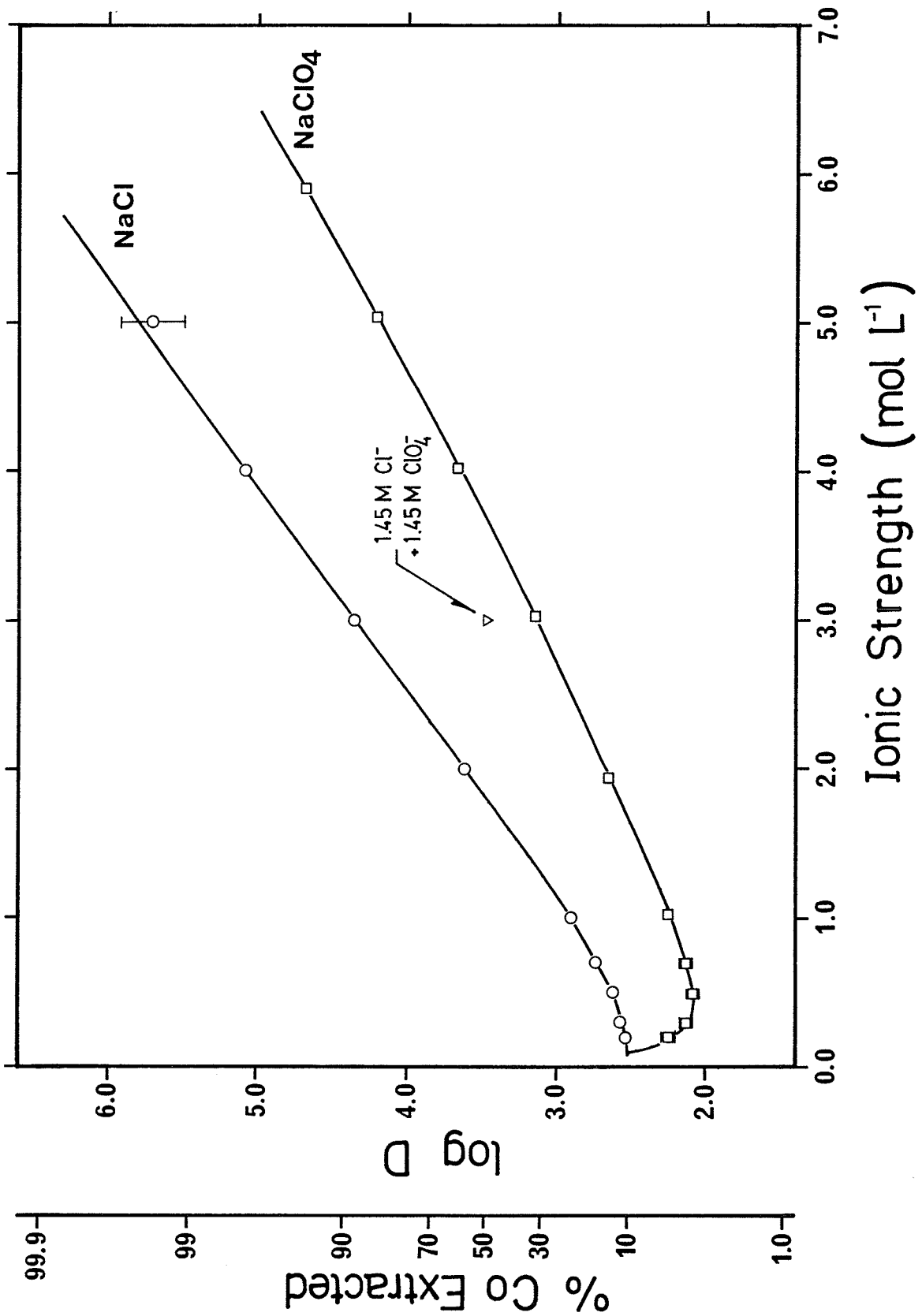

initial addition of NaClO_4 before again climbing at higher concentrations whereas a continuous increase in sorption accompanies all additions of NaCl . Obviously, at least one of the salts cannot be considered "inert".

There are, therefore, two possible explanations which might be consistent with this difference in behaviour between the two. First of all, we may consider that ClO_4^- is strictly inert and could then postulate that the presence of Cl^- as a ligand may provide for some formation of other (perhaps mixed) extractable cobalt species. Thus, the greater value of D in chloride rather than perchlorate medium at a particular ionic strength would be due to the added effect of this complexation and extraction. Although this is not impossible, a glance back to Table II-14 (which shows the calculated relative abundances of a number of cobalt-containing ions for several different solution conditions) will demonstrate that Cl^- is not a powerful ligand for cobalt and that cobalt-chloro species would be expected only in very small amounts in the presence of SCN^- . Actually, if true enhancement of cobalt sorption by Cl^- is taking place by any mechanism, then one would expect to find that $\log D$ for the mixed experiment ($1.45 \text{ M Cl}^- + 1.45 \text{ M ClO}_4^- + 0.10 \text{ M SCN}^-$) should be that characteristic of a solution which is of 3.00 M ionic strength but enhanced by an amount attributable to the presence of 1.45 M Cl^- (i.e. the difference in $\log D$ between 1.45 M Cl^- and 1.45 M ClO_4^-). This would predict, in fact, $\log D \sim 3.97$ for the mixed experiment which is much greater than the experimentally determined value of 3.473 . Thus, enhancement of sorption by Cl^- seems doubtful.

On the other hand, one may consider that Cl^- is strictly inert and that the presence of ClO_4^- in solution interferes in some way with the

cobalt sorption process. As originally suggested, it is conceivable that the method by which such interference could occur might be by oxidation of SCN^- or foam but we should probably expect declining sorptions of cobalt with time then, and this was not observed. Thus, any interference must occur in the foam phase rather than in the aqueous solution since ClO_4^- is almost devoid of power as a ligand. That this may be the case, in fact, is supported by ion exchange data which show⁽²³²⁾ that ClO_4^- is approximately 700 times more extractable into synthetic anion exchangers such as Amberlite IRA 400 than is Cl^- . In addition, if we again consider the data for the mixed experiment (1.45 M Cl^- + 1.45 M ClO_4^- + 0.10 M SCN^-), we predict that the value of log D should be that expected of a solution which is of 3.00 M ionic strength but depressed by an amount characteristic of the presence of 1.45 M ClO_4^- . In this case, we would arrive at a value of log D ~ 3.52 which is in good agreement with the experimentally measured value of 3.473. Thus, it seems that ClO_4^- interferes with sorption and is not an "inert" anion with respect to cobalt extraction by polyurethane foam.

The reasons for the interference of ClO_4^- could be several but, as was pointed out, we expect that the effect occurs within the polymer phase rather than in solution. If the mechanism whereby cobalt sorption takes place should be a type of solvent extraction, then we must assume that NaClO_4 (or perhaps HClO_4 in this particular experiment) is extracted and interferes with cobalt sorption within the polyurethane. This depression of cobalt sorption may conceivably occur by some common ion effect; for example, by suppressing the ionization of $\text{M}_2^+ \cdot \text{Co}(\text{SCN})_4^{2-}$ ion associates due to excess $\text{M}_{(f)}^+ + \text{ClO}_{4(f)}^-$ present (where M^+ could be Na^+ or perhaps H^+). Alternatively, it may be that the perchlorate is extract-

ed to the extent that it ties up a great deal of the polyurethane "solvent" (i.e. it physically occupies most of the space between chains) or perhaps that it alters the bulk physical properties (e.g dielectric constant, etc.) of the foam such that the sorption of $\text{Co}(\text{SCN})_4^{2-}$ is no longer so highly favoured.

On the other hand, if the cobalt extraction mechanism is more properly considered as an anion exchange process, then the interference could possibly be described simply as a competition between ClO_4^- and $\text{Co}(\text{SCN})_4^{2-}$ for exchange sites in the polymer (i.e. $2 \text{ClO}_4^-(\text{aq}) + \text{Co}(\text{SCN})_4^{2-}(\text{f}) \rightleftharpoons 2 \text{ClO}_4^-(\text{f}) + \text{Co}(\text{SCN})_4^{2-}(\text{aq})$).

Any of these possibilities seems not unreasonable but it is very difficult to distinguish quantitatively between them. However, some interesting results are obtained by further mathematical treatment of the data obtained in this experiment. Thus, if one calculates the ratio of the cobalt distribution constant as measured from perchlorate medium, $D_{\text{ClO}_4^-}$, at a particular total ionic strength to that measured at the same total ionic strength but from chloride medium instead, D_{Cl^-} , then the logarithm of this ratio, $\log(D_{\text{ClO}_4^-} / D_{\text{Cl}^-})$, is found to be linearly related to the square root of the solution perchlorate concentration, $[\text{ClO}_4^-]^{1/2}$. (The effect of using the ratio of $D_{\text{ClO}_4^-}$ to D_{Cl^-} at the same total ionic strength should be to cancel out those changes in the cobalt extraction which are related only to the aqueous ionic strength). Such a relationship is pictured in Figure 2-21 in which the origin (which is a logical part of the data since $D_{\text{ClO}_4^-}$ and D_{Cl^-} must be identical when neither anion is present) has been included as a filled circle.

Whether the nearly linear dependence observed here is physically

Figure 2-21

Relationship between the aqueous perchlorate concentration and the quotient of cobalt distribution ratios as measured from thiocyanate solutions containing equal amounts of either NaClO_4 ($D_{\text{ClO}_4^-}$) or NaCl (D_{Cl^-}) as "inert" salt. Equilibrium was reached over 24 hours between 50 mg #1338 BFG polyurethane foam pieces and 150.0 mL of solution at 25.00°C. For initial solution conditions see Figure 2-20.

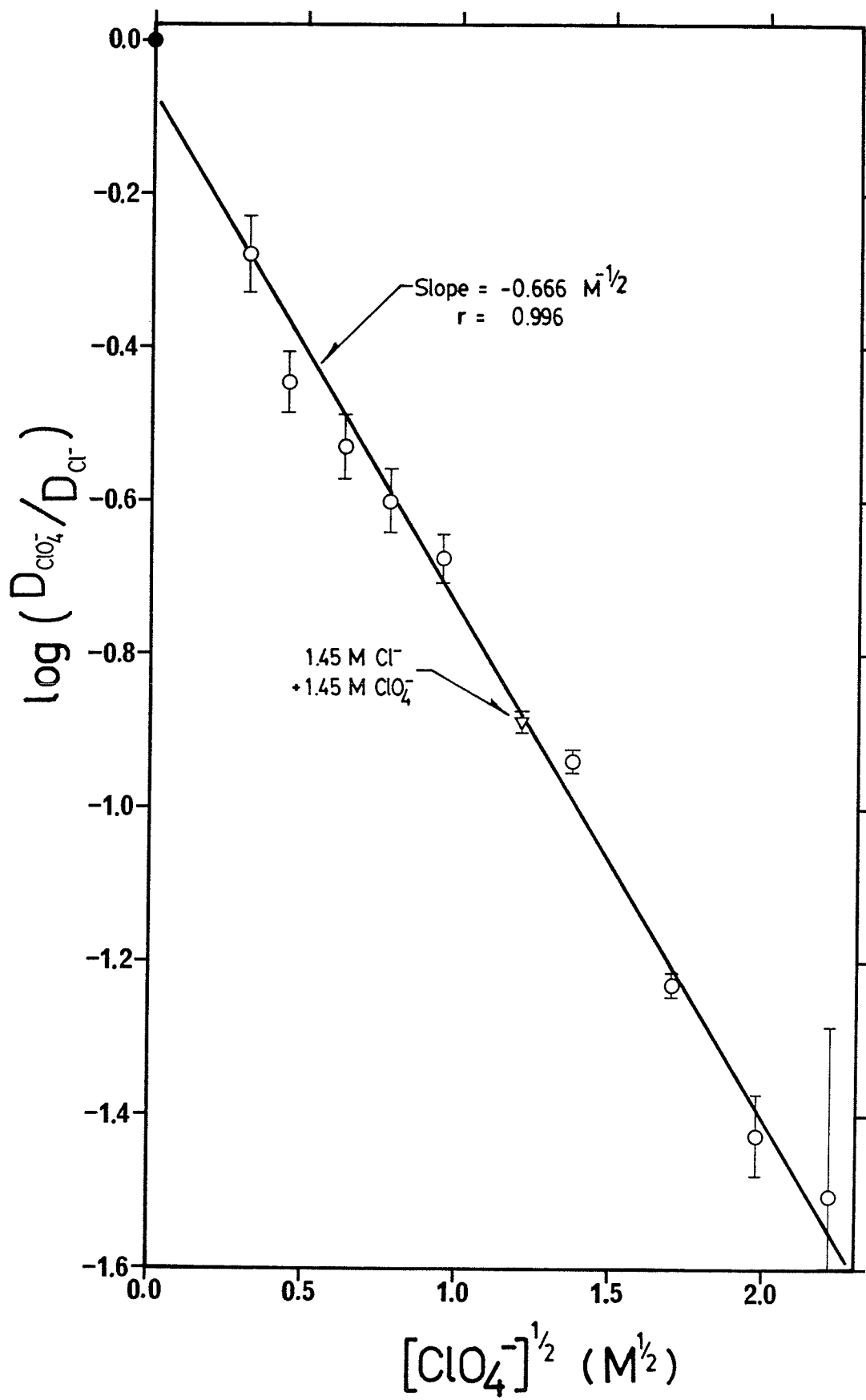

significant or simply fortuitous is not at all certain. However, if it is assumed to be real, then we may attempt to fit it as best as possible to the foregoing proposals.

Although the proposals of tying up available "solvent" or of altering the bulk physical properties of the polymer significantly are quite difficult to treat mathematically, it can be shown (at some length, unfortunately) that neither the suppression of ionization in a solvent extraction-like mechanism nor simple exchange competition in an ion exchange-like mechanism can be expected to give rise to a linear $\log (D_{\text{ClO}_4^-} / D_{\text{Cl}^-})$ versus $[\text{ClO}_4^-]^{1/2}$ relationship. Thus, it seems that some other factor must be involved.

There are, in fact, few known correlations between two physical parameters which follow a $\log/\sqrt{}$ dependence. One fairly common one, though, which may have to do with alteration of bulk physical properties of the polymer is that between the mean activity coefficient, γ_{\pm} , of ions in a solvent as a function of the solution ionic strength, μ . According to the Debye-Hückel Limiting Law⁽²³³⁾, in dilute solution the two are related by an equation of the form:

$$\log \gamma_{\pm} = -|z_+ z_-| A \sqrt{\mu} \quad \dots\dots\dots (152)$$

where A is a constant dependent on the characteristics of the solvent and on the temperature while z_+ and z_- are the charges on the ions. This relation is adhered to only at relatively low ionic strengths (up to perhaps a few tenths of a mole per liter) and so would not be expected to hold true in the aqueous phase where 5 or 6 M concentra-

tions are reached. However, if sorption of materials by the polyurethane is not extensive (up to something like 0.2 mol kg^{-1} or so) these conditions may conceivably be fulfilled there. Nevertheless, if NaClO_4 (or HClO_4) is sorbed in increasing amounts as its concentration is increased, this should produce an increase in ionic strength and, according to equation (152), we should then expect a progressive decrease in the mean ionic activity coefficient, γ_{\pm} , in the polymer. For the sorption of ions, this would lead to an increase in metal extraction (measured in concentrations, not activities) yet this is exactly opposite to what is observed. We conclude, therefore, that ionic strength changes must also not be the appropriate explanation for the phenomenon. Thus, it seems that the true origin may be related to space-filling by the sorbed perchlorate or may be a complicated composite of several factors (i.e. a fortuitious relationship). Whatever the case, the correct interpretation will have to await the more lucid thinking of others.

Having thus attempted a discussion of the possible reasons for the apparent failure of NaClO_4 to act as an "inert" salt, we will now turn our attention toward the effects of NaCl instead. Although we assume that NaCl does not suffer greatly from the same problems which we have suggested for NaClO_4 , it should be pointed out that we have no guarantee that NaCl is a truly inert salt. In fact, as we shall see, it cannot be so but it is still useful in a practical context.

Considering, then, Figure 2-20, we observe that the extraction of cobalt is steadily improved by the addition of NaCl (at least up to the limits imposed by the solubility of the salt). Based on our understand-

ing thus far of the form in which cobalt is being extracted, this must be the resultant of at least three separate effects which will influence the process.

First of all, if the cobalt is sorbed by an ion pair solvent extraction-like process and it is therefore being accompanied by two Na^+ ions (i.e. $2 \text{Na}^+ + \text{Co}(\text{SCN})_4^{2-}$) as is apparently the case at higher pH at least, then its extraction will clearly be improved by the addition of any sodium salt. Thus, to the extent that this may be true, NaCl is actually not an "inert" salt for use in ionic strength studies since it may bear a common ion to the extractable species (but it is, nevertheless, acceptable to maintain constant ionic strength when used in substitution for other sodium salts in solution). If, on the other hand, cobalt sorption were to take place via a genuine ion exchange type of mechanism ($\text{Co}(\text{SCN})_4^{2-}(\text{aq}) + 2 \text{A}^-(\text{f}) \rightleftharpoons \text{Co}(\text{SCN})_4^{2-}(\text{f}) + 2 \text{A}^-(\text{aq})$) then no such phenomenon should exist provided that Cl^- did not compete effectively for exchange sites.

A second contributing phenomenon which must be considered regardless of the mechanism is the increase in dielectric constant of the aqueous phase resulting from moderate increases in the ionic strength⁽²³⁴⁾. The effect of this change should be to favour the extraction of less polar and more hydrophobic species (such as $\text{Co}(\text{SCN})_4^{2-}$) and thus a further increase in D might be expected. However, if there are Na^+ ions accompanying $\text{Co}(\text{SCN})_4^{2-}$, these cations will then be somewhat less extractable and there are other possible, more complicated, effects which may result in small shifts in many of the solution equilibria involving cobalt. Since these may work in opposition to the above effect, the net

result of a moderate increase in ionic strength is difficult to predict.

The third phenomenon which definitely becomes important at high ionic strength (nearer saturation) would be the decreased water activity (234), $a_{\text{H}_2\text{O}}$, as a result of the large number of water molecules then tied up in solvating the added solute ions. The effect of this "salting out", of course, is to further decrease the water solubility (and thereby increase the extractability) of hydrophobic species such as $\text{Co}(\text{SCN})_4^{2-}$. In addition, equilibria such as $\text{Co}_{(\text{aq})}^{2+} + 4 \text{SCN}_{(\text{aq})}^- \rightleftharpoons \text{Co}(\text{SCN})_4^{2-}_{(\text{aq})}$ are expected to be shifted to favour products more fully since the solvation of one large ion is more easily accomplished than five smaller ones when H_2O becomes "scarce". Thus, in both cases, increases in D are predicted when the ionic strength is high.

Taking all of these phenomena into account, one expects a general improvement in cobalt sorption with increasing NaCl concentration but with some uncertainty perhaps at low values (as is observed from Figure 2-20). However, since the dependence is probably the resultant of several different phenomena, no simple mathematical relationship likely will exist between the measured values of log D and the concentration of NaCl. This was confirmed by several attempts to find such a relationship (including plotting log D as a function of the square root of the ionic strength or as a function of $\log [\text{Na}^+]$ which both failed to give near-linear results). Unfortunately, this same complicated behaviour makes obtaining mechanistic information from the data nearly impossible.

In summary, then, we have shown by experiment that the sorption of cobalt from aqueous thiocyanate solutions is a fairly sensitive function

of the concentration of salts other than NaSCN added to the solution and is often dependent on the identities of the salts used. Sodium chloride was found to be more suitable than sodium perchlorate when attempting to assess the effects of changes in solution ionic strength alone but may also be strictly unsuitable. As will be apparent from a discussion of the Cation Chelation Mechanism, the selection of a truly suitable salt for this purpose is a very difficult task.

Regardless of these problems, strictly from a industrial point of view, the results of this experiment are important since they demonstrate that large improvements in extraction are available simply by the addition to solution of relatively inexpensive salts. For instance, we see that the presence of 5 M NaCl in solution improves the extraction of cobalt from only 10% to better than 99%. Thus, processing of concentrated brine liquors (or even Dead Sea water) by the addition of quite small amounts of thiocyanate should be feasible. Of course, since a number of other metal-chloro complexes are also known to be sorbed by polyurethane foam, other metals may then also be extracted and interfere if present in large amounts and this must be taken into consideration.

From the standpoint of analytical usage, the dependence on salt concentration provides one more parameter which is available to control selective sorption or desorption of cobalt in either batch or column methods. On the other hand, of course, it represents a factor which must be closely controlled if reproducible results are required when less than quantitative extraction is being achieved.

9. Effect of Polyurethane Foam Type on Cobalt Sorption from Thiocyanate Solution

A study was desired to compare the relative abilities of several different types of polyurethane foam for sorbing cobalt from aqueous thiocyanate solutions with the hope of relating foam structure to performance.

Near the outset of the research, a semi-quantitative comparison of several readily available foam types (#1122 BFG, #1338 BFG, #1538 BFG, #1831 BFG, #2331 BFG, A, B, and diSPo) was made based on the intensities of colours developed by roughly 50 mg pieces of each type squeezed together in a single container. Thus, it was noted that with 150 mL of solution containing 1 M NH_4SCN , 1 M $\text{NaOOCCH}_3/\text{HOOCCH}_3$ buffer and 1.4×10^{-4} M (8.3 ppm) Co(II), all of the foam types tested (except the last one) acquired a bright blue colour of nearly the same intensity during 15 minutes of squeezing. All of these polyurethanes were known to be of polyether type. However, diSPo (a polyester-based polyurethane) hardly assumed any colour at all, even when the cobalt concentration was subsequently doubled.

These observations and some nagging questions regarding the actual mechanism of the sorption phenomenon prompted more exact comparisons to be made with additional foam types included. For this experiment, a 1 L stock solution containing NaSCN , $\text{NaOOCCH}_3/\text{HOOCCH}_3$ buffer and Co(II) was prepared such that 20.0 mL aliquots would yield 0.100 M NaSCN , 0.10 M buffer and 1.7×10^{-6} M (0.10 ppm) Co(II) when diluted to 150.0 mL. An equal amount of solid NaCl was then weighed individually into the 150.0

mL volumetric flasks to make the solution 2.80 M in that salt (and to give a total ionic strength of 3.00 M). Sufficient ^{60}Co tracer solution was added to yield an initial count rate of about 300 to 400 seconds⁻¹ and the flasks were diluted nearly to the mark. After sitting overnight, final adjustments to the solution volume were made before mixing and beginning the distribution study in the usual manner. A summary of the initial solution conditions appears at the top of Table II-18.

Twenty-one different available types of polyurethane foam were tested in three sets of ten or less using solutions prepared from the same stock. To ensure intercomparison between the results of each set, one of the ten in each case was chosen to be the #1338 BFG foam used exclusively in other experiments. All other foam types were tested only once.

A listing of the polyurethane foams included in the study along with the prepolymer producer and supplier (when known) is given in Table II-18. The BFG series of foams were obtained at the same time from the same supplier and are believed to have been produced from the same prepolymer with small differences only in the amounts of cross-linking achieved and minor additives present (e.g. surfactants). The series of Hypol polymers were supplied as samples from W. R. Grace and Company (Cambridge, Massachusetts) along with the formulations used in preparing them. These foams are the products of either of two polyether prepolymers (FHP 2000 or FHP 3000) but with differing amounts and types of surfactants and occasionally dyes added to produce widely differing physical appearances and properties. Those foams designated as A, B, D2931A, 27CGS44-2A, 27CGS44-1 and 27CGS44-3 were prepared specifically to be

tested by Dr. H. D. Gesser et al. of this Department and were the very kind gift of Dr. C. G. Seefried of the Union Carbide Corporation. The compositions of each are listed in the Table (PEO = polyethylene oxide, PPO = polypropylene oxide). Other foams were from various sources as shown. All types were cleaned, cut and weighed prior to testing as described in the General Procedure. Several, including #1338 BFG, were noted to develop a slight pink colour during washing with 1 M HCl but this disappeared on thorough rinsing with distilled water.

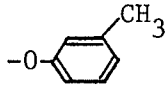
Infrared spectra of a few of the polyurethane polymer types (#1338 BFG, A, and diSPo) were obtained as thin films by dissolving 200 mg of the foam as small bits in 10 mL of refluxing freshly distilled m-cresol (3-methylphenol) and evaporating several volumes of the solution on 1.5 cm x 3 cm sodium chloride plates inside a heated vacuum desiccator. This treatment chiefly has the effect^(1, 2) of breaking some of the urethane bonds in the polymer and substituting the m-cresylate group  for the polyol at many of the chain links thus disrupting the three-dimensional structure as follows:

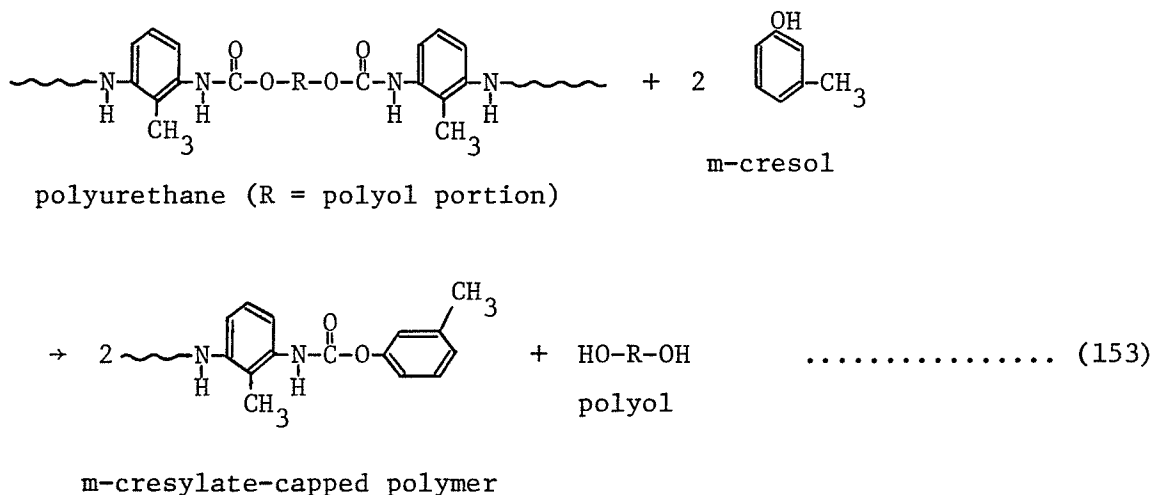

On heating under vacuum, the excess m-cresol is evaporated away to leave a thin film of the slightly degraded polymer on the sodium chloride plate.

The infrared spectra of the resulting thin films for #1338 BFG, A and diSPo foam types are shown in Figures 2-22, 2-23 and 2-24 respectively. Polyurethanes based on polyester polyols (such as diSPo) show^(1, 2) strong absorptions near 5.8 μm (shown as 'microns' in the Figures) due to the large number of ester ($-\overset{\text{O}}{\text{C}}-\text{O}-$) groups, while those of polyether type (such as #1338 BFG and A) show broad absorptions near 9.0 μm from the ether ($-\overset{|}{\text{C}}-\text{O}-\overset{|}{\text{C}}-$) groups.

The procedure followed in the distribution study itself was generally that described in the Experimental section although a malfunction of the temperature regulating system in the first 24 hours necessitated leaving the foams to equilibrate for an additional 24 hours in one case. Distribution cells were tightly sealed with double condoms and silicone grease at the joints. Calibration corrections of as much as 3% were applied to allow for changes in the sensitivity of the spectrometer over wide fluctuations in room temperature.

Visual examination of the foam pieces was made at several times during the equilibration period of the distribution experiment. In almost all cases, a green to blue colour began to appear within the first several minutes of squeezing and intensified gradually over 6 or 12 hours. Exceptions to this were the 27CGS44-2A foam which slowly achieved only a very pale green colour and diSPo which remained white throughout. As usual, the intensities of the colours developed paralleled the measured sorptions of cobalt. Some of the foam specimens (e.g.

Figure 2-22

Infrared absorption spectrum of #1338 BFG (polyether) polyurethane foam dissolved by m-cresol and deposited as a thin film on sodium chloride plate (as described in text).

Conditions:

Instrument Perkin-Elmer model
337 grating
Slit 1
NaCl plate area 4.5 cm²
Polyurethane film density ... 220 μg cm⁻²

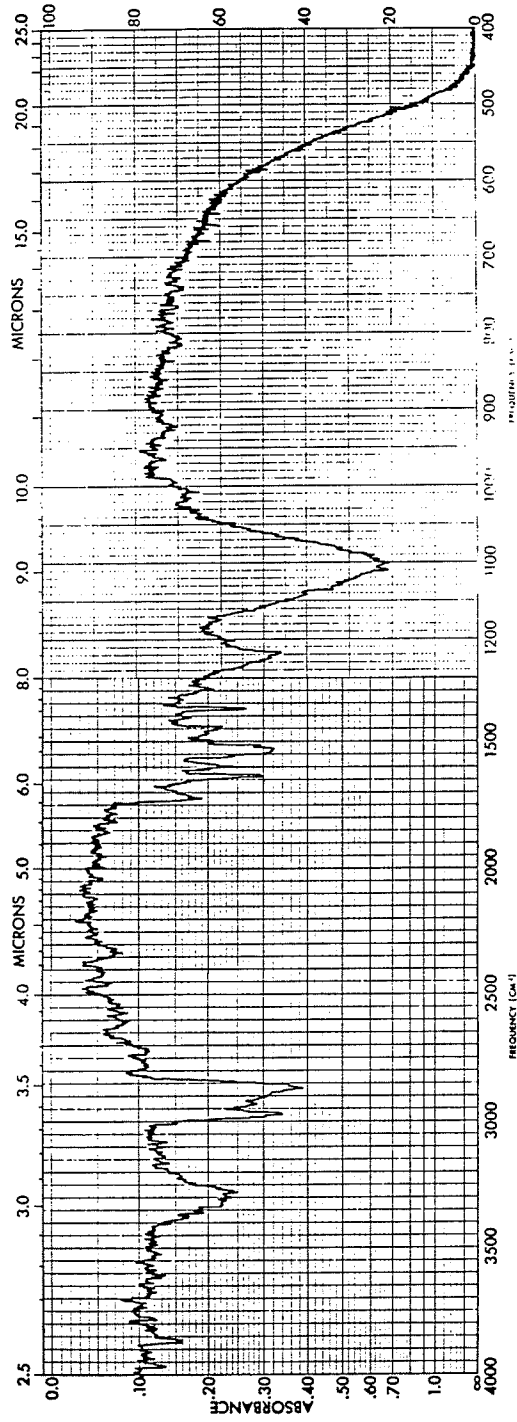

Figure 2-23

Infrared absorption spectrum of A (polyether) polyurethane foam dissolved by m-cresol and deposited as a thin film on sodium chloride plate (as described in text).

Conditions:

Instrument Perkin-Elmer model
337 grating
Slit 1
NaCl plate area 4.5 cm²
Polyurethane film density 220 μg cm⁻²

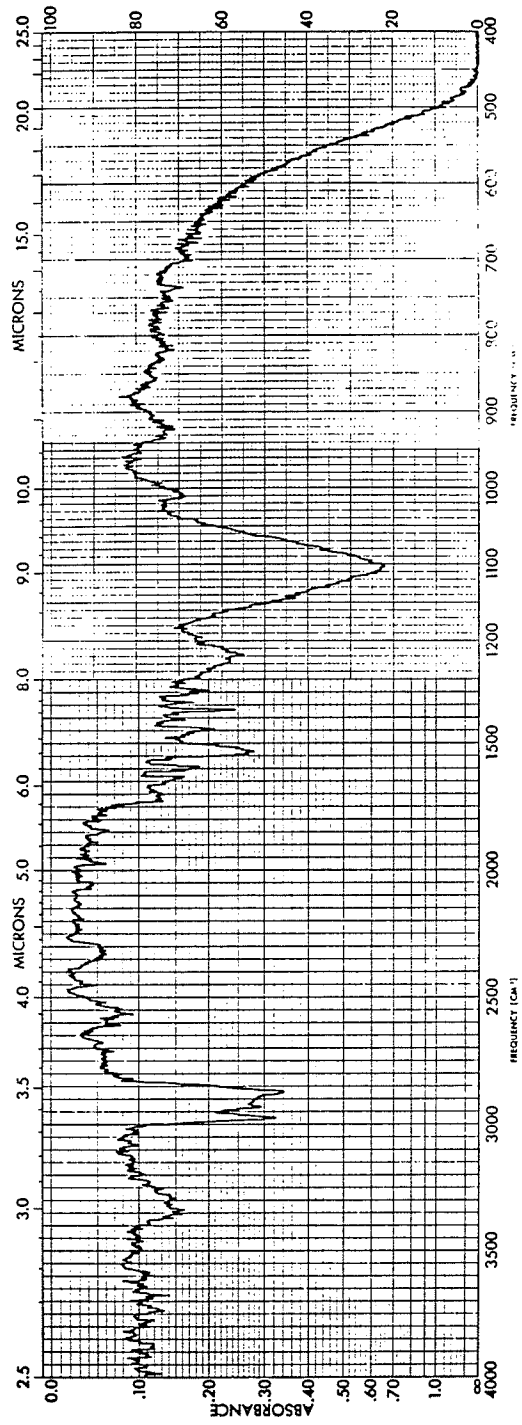
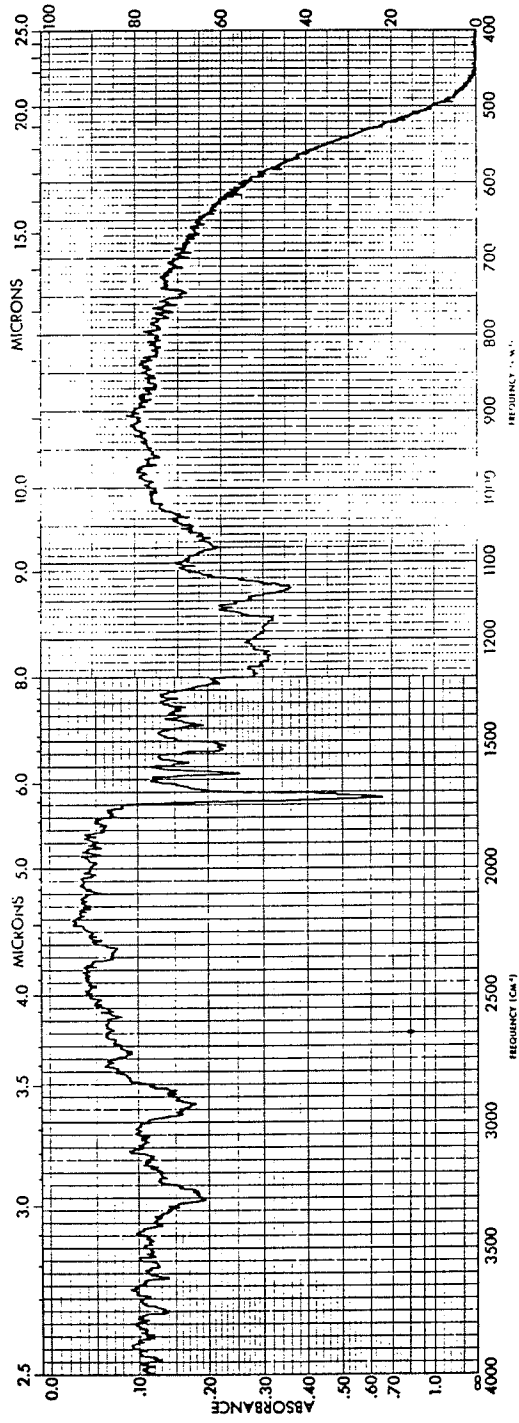

Figure 2-24

Infrared absorption spectrum of diSPo (polyester) polyurethane foam dissolved by m-cresol and deposited as a thin film on sodium chloride plate (as described in text).

Conditions:

Instrument Perkin-Elmer model
337 grating
Slit 1
NaCl plate area 4.5 cm²
Polyurethane film density 220 μg cm⁻²



D2931A and Hypol 9281-2-B) were noted to approach equilibrium more slowly than did others probably owing mostly to smaller size arising out of slightly higher density and therefore leading to lower squeezing efficiency. The diSPo foam showed a barely measurable sorption of cobalt (about 0.2%) after 6 hours but thereafter the solution cobalt concentration was measured to be higher than the initial value. In keeping with what we have demonstrated earlier, this doubtless indicates that small losses of solvent by evaporation become larger than the very small sorption after some period of time. For this reason, the data for 6 rather than 24 hours have been used in the calculations.

The results of the experiment are collected in Table II-18 which shows the percentage of cobalt extracted and distribution ratio for each foam type tested. From the Table, we see that the three separate determinations of D for #1338 BFG foam made on different days agree with one another within the experimental uncertainty resulting from radiometric counting errors alone and thus the results from all three experiments are intercomparable. Perusal of the rest of the data shows that measured values of D range all the way from only about 6 (for diSPo) up to nearly 25000 (for #1831 BFG) and that the type selected for most other experiments (#1338 BFG) is only slightly better than average amongst them.

The most striking contrast to be noted within the Table is the difference in sorption between the only available polyester-based polyurethane (diSPo) and all of the polyether-based ones. Since D in the former case is only of the order of 0.05% of that for the average polyether-based

TABLE II-18 - ABSORPTION OF COBALT BY VARIOUS POLYURETHANE FOAM TYPES

Initial Conditions:

[SCN ⁻]	0.100 M (NaSCN)	Solution Volume (V)	150.0 mL
[Co]	1.7 x 10 ⁻⁶ M (0.10 ppm)	Foam Weight (W)	0.050 grams
Ionic Strength (I)	3.00 M (NaCl)	Squeezing Time	24.0, 48.0 hours
pH	4.8 (0.1 M Na acetate buffer)	Temperature	25.00°C

Foam Designation	Foam Type	Prepolymer Producer	Supplier	Foam Weight (mg) ±0.01	Contact Time (hours) ±0.1	Cobalt Extracted (%)	D (L kg ⁻¹)	log D
#1122 BFG	unknown polyether	B.F. Goodrich Co. Ltd.	G.N. Jackson Ltd., Winnipeg	50.10	24.0	85.9 ±0.5	1.83 ±0.06	4.261 ±0.014
#1338 BFG	"	"	"	50.24	24.0	84.5 ±0.8	1.63 ±0.08	4.212 ±0.023
#1338 BFG	"	"	"	48.84	24.0	84.6 ±0.4	1.69 ±0.05	4.228 ±0.012
#1338 BFG	"	"	"	48.77	48.0	84.8 ±0.5	1.72 ±0.06	4.235 ±0.014
#1338 M	"	Monsanto	"	50.01	24.0	85.7 ±0.6	1.80 ±0.07	4.254 ±0.018
#1538 BFG	"	B.F. Goodrich Co. Ltd.	"	50.69	24.0	86.28 ±0.30	1.86 ±0.04	4.270 ±0.010
#1831 BFG	"	"	"	50.84	24.0	89.4 ±0.8	2.49 ±0.18	4.397 ±0.032
#2331 BFG	"	"	"	50.13	24.0	88.6 ±0.6	2.34 ±0.12	4.369 ±0.022
Qualux	unknown polyether	unknown	G.N. Jackson Ltd., Winnipeg	49.86	48.0	70.5 ±0.6	7.17 ±0.14	3.856 ±0.009

TABLE II-18 - continued

Foam Designation	Foam Type	Prepolymer Producer	Supplier	Foam Weight (mg) ± 0.01	Contact Time (hours) ± 0.1	Cobalt Extracted (%)	D (L kg ⁻¹)	log D
Black	unknown polyether containing carbon black	unknown	unknown	50.35	24.0	84.3 ± 0.5	1.60 $\times 10^4$ ± 0.05	4.204 ± 0.014
A	60% PEO/PPO copolymer with 40% styrene/acrylonitrile copolymer	Union Carbide Corp.	Union Carbide Corp.	49.53	24.0	70.6 ± 0.3	7.26 $\times 10^3$ ± 0.09	3.861 ± 0.006
B	80% PEO/PPO copolymer with 20% styrene/acrylonitrile copolymer	"	"	50.37	24.0	73.2 ± 0.4	8.12 $\times 10^3$ ± 0.14	3.910 ± 0.007
D2931A	unknown polyether with 14% tris-(2,3-dibromopropyl)phosphate flame retardant added	"	"	48.72	24.0	74.6 ± 0.5	9.05 $\times 10^3$ ± 0.17	3.957 ± 0.008
27CGS44-2A	100% PPO polyether	"	"	50.00	24.0	25.9 ± 0.5	1.047 $\times 10^3$ ± 0.023	3.020 ± 0.009
27CGS44-1	8% PEO/92% PPO polyether	"	"	50.13	24.0	70.8 ± 0.6	7.26 $\times 10^3$ ± 0.17	3.861 ± 0.010
27CGS44-3	14% PEO/86% PPO polyether	"	"	49.62	24.0	87.7 ± 0.4	2.16 $\times 10^4$ ± 0.07	4.335 ± 0.014
Hypo1 (9030-43-1)	unknown polyether (FHP 3000 prepolymer)	W.R. Grace & Co.	W.R. Grace & Co.	50.02	24.0	55.2 ± 0.5	3.69 $\times 10^3$ ± 0.05	3.567 ± 0.006

TABLE II-18 - continued

Foam Designation	Foam Type	Prepolymer Producer	Supplier	Foam Weight (mg) ±0.01	Contact Time (hours) ±0.1	Cobalt Extracted (%)	D (L kg ⁻¹)	log D
Hypol (9131-13-1)	unknown polyether (FHP 3000 prepolymer)	W.R. Grace & Co.	W.R. Grace & Co.	50.25	24.0	63.4 ±0.6	5.17 ±0.10 x 10 ³	3.713 ±0.008
Hypol (9131-33-8)	unknown polyether (FHP 2000 prepolymer)	"	"	48.64	24.0	67.6 ±0.5	6.42 ±0.11 x 10 ³	3.808 ±0.008
Hypol (9131-32-11)	unknown polyether (FHP 2000 prepolymer)	"	"	50.20	24.0	63.7 ±0.6	5.24 ±0.10 x 10 ³	3.719 ±0.009
Hypol (9131-6-1)	unknown polyether (FHP 3000 prepolymer)	"	"	50.53	24.0	62.6 ±0.4	4.96 ±0.06 x 10 ³	3.696 ±0.006
Hypol (9281-2-B)	unknown polyether (FHP 3000 prepolymer)	"	"	50.38	24.0	61.3 ±0.4	4.72 ±0.06 x 10 ³	3.674 ±0.006
diSPo	unknown polyester	unknown	Scientific Products Ltd.	50.20	48.0	0.2 ±0.5	6 x 10 ⁰ ±15	0.7 ±1.2

foam, we must conclude that the polyol portion of the polymer is extremely important to the sorption of cobalt and that polyesters are somehow largely unsuitable for this purpose. In seeking an explanation for this obvious difference between polyethers and polyesters, one could imagine that perhaps polyesters may engage in such significant dipole-dipole interactions between carbonyl groups in neighbouring polymer chains that the incursion of foreign ions and molecules is essentially prevented. However, for this effect to be great enough to produce the measured marked decrease in distribution ratio, the polymer should be quite stiff and rigid. Since we do not observe such rigidity in diSPo foam, we conclude that this is not the case. Thus, if there is no other indirect physical reason which prevents access of the sorbing species to sites on the foam, we deduce that the polyether itself must provide these sites and that polyester cannot.

As an easy corollary to this conclusion, we may also infer then that the urethane, urea and other links which are common structural features of all polyurethanes are apparently not greatly important to cobalt sorption (at least in the absence of polyethers). This conclusion is a very important one since it would seem to eliminate a number of possible sorption mechanisms from active consideration such as ligand exchange or addition, weak base anion exchange or cation chelation at other than ether sites. Such elimination casts further doubts on the concept of conventional site protonation as the mode of action since the nitrogen-containing portions of the polyurethanes are expected to be stronger bases than are the oxygen-containing ether or ester parts. Furthermore, the failure of polyester to perform adequately to sorb cobalt even though

esters such as butyl acetate are known ⁽²³⁵⁾ to extract the thiocyanate complex nearly as well as ethers indicates that some other more specific phenomenon is at work here.

Apart from these obviously significant observations some other information is available by considering comparisons between individual members of the various series of closely-related polyether foam types in Table II-18.

For example, in the Hypol series of polymers, for which the formulating ingredients and most physical properties are known ⁽²³⁶⁾, significant differences in the distribution coefficient are noted even though they all contain either one of two prepolymers, water and different surfactants. Hypol (9030-43-1) and Hypol (9131-13-1), for instance, are prepared by admixture of identical amounts of the same prepolymer and water but differ only in the type of surfactant used. As a result, even after cleaning, the former one is relatively hydrophobic and fine textured while the latter is more hydrophilic and completely reticulated (no walls left in cells). Even though these two must be chemically quite similar, the latter was measured to have a value of D which is 40% greater than the former. This difference must be related almost entirely to the accessibility of sites at which sorption may occur and so we see that essentially non-chemical factors may play a significant role in determining the sorption efficiency of a polyurethane foam. An attempt to correlate the sorption behaviour of the entire set of Hypol polymers to the reported physical properties of the polymers does not indicate any absolute relationship. However, it appears that properties which measure the flexibility of the polymer (e.g. elongation) or its oxygen

content (e.g. oxygen index) very roughly parallel the order of sorption efficiency with the more flexible and most oxygenated foams being generally more successful.

Another comparison to be made in Table II-18 is that between the two foam types designated as A and B which differ in the amount of polyether polymer relative to styrene/acrylonitrile copolymer. The Table shows that greater cobalt sorptions result when larger percentages of polyether are present, in agreement with our earlier statements regarding the importance of that constituent to sorption. However, the fact that an increase of 33% in the polyether content results in an increase of only about 12% in D indicates either that the styrene/acrylonitrile copolymer is also partly capable of sorbing species as well or that there are other complicating factors involved (such as site accessibility or position requirements in order that the added polyether may be useful). Which of these is the case, if not both, is not definitely known although the latter interpretation will be most consistent with models to be proposed later.

One of the most interesting comparisons to be made in Table II-18 is amongst the set of three polyurethanes denoted as 27CGS44-2A, -1 and -3. Here we see that for otherwise identical polyurethanes cobalt sorption is very sensitive to the polyether polyol portion of the polymer as it is altered from all polypropylene oxide (PPO) to 14% by weight polyethylene oxide (PEO) with 86% PPO. As this substitution of PEO for PPO occurs, D is seen to be increased by more than 20-fold and thus indicates that it is a very important chemical factor in the sorption phenomenon. (Unfortunately, no polyurethane foams known to contain 100% PEO polyether were

available for testing to see if the trend would continue!)

In trying to decide what differences in chemical properties existing between PPO and PEO might be responsible for this large difference in sorption behaviour with a change in polyether polyol, our attention is drawn both to the Lewis base strength of the ether oxygen atoms and to possible steric interference factors. Considering the first of these,

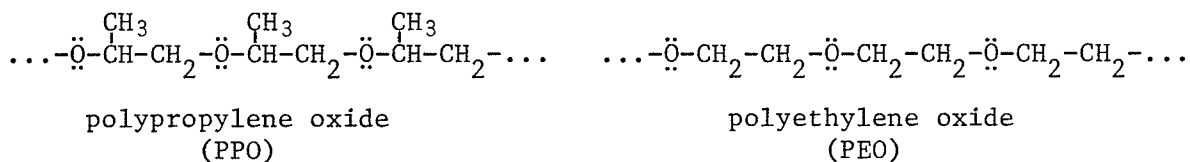

we may quite easily predict from the known mild electron-donating inductive character of the methyl group that the oxygen atoms in PPO will be slightly stronger Lewis bases (and thus generally better ligands for metal atoms) than in PEO. The fact that PEO seems to be more effective than PPO indicates that the extent of sorption must be governed by some factor other than base strength. This provides further evidence in contradiction of a weak base anion exchange type of mechanism involving protonation of ether oxygen atoms since the protonation should definitely be favoured by the stronger base (PPO).

This brings us instead to consideration of important steric factors rather than inductive ones. If this point of view is now taken, we infer that the methyl ($-\text{CH}_3$) groups in the PPO have a pronounced effect on the geometry of the polyether/sorbed species interaction, whatever it may be. We will leave further discussions of this to later sections which will consider the sorption mechanism more fully.

Some further comparisons may also be attempted in the BFG series of polymers listed in Table II-18 in order of increasing density (given in tenths of pounds per cubic foot by the first two digits in the number). From the Table, we see that #1338 BFG foam with a density of 1.3 lb ft^{-3} is apparently the least efficient at cobalt sorption and that foams of both lower and higher density perform at least marginally better. Similarly, the data show that no monotonically increasing or decreasing relationship appears to exist between the compression strength of the foam (as given by the last two digits in the number in the peculiar units of pounds per 16 square inches required to achieve 50% compression) and its ability to sorb cobalt since those with intermediate compression strength are evidently optimal. Thus, it would seem that sorption ability may not be directly related to either of these two physical characteristics and we have no other information regarding their manufacture or properties with which to make further comparisons. However, visual observation suggests that perhaps some of the decrease in the value of D for #1338 BFG foam may simply reflect the increased degradation of the polymer (as evidenced by slight yellowing) in the presence of light and oxygen owing to its storage over long periods of time in cut rather than in full sheet form. This hypothesis is partly supported by earlier comparative measurements made on five yellowed and five nearly unyellowed (obtained from the centers of stored foam pieces) samples of #1338 BFG which showed a difference in sorption of approximately 3% between the two sets. This difference is less than that observed here between #1338 BFG and foams with the next lowest distribution coefficients (about 7 or

8%) but this discrepancy may simply be due to the fact that the foam pieces obtained from the centers of the #1338 BFG foam pieces in the experiment mentioned above were also already degraded to some extent.

Although very little is known about the chemical compositions of the remaining foam types and therefore no structure/performance information may be obtained from them, they have been included in Table II-18 for completeness and to provide further representation of "average" foam types.

Apart from the many mechanistic implications which have already been mentioned, the results of this experiment, although not exhaustive, have identified some of the chemical and physical factors which should be considered in choosing a polyurethane foam for practical metal ion sorption uses. First of all, it is apparent that polyether rather than polyester-based foam is essential for efficient sorption. Secondly, the polymer should contain as large a percentage of polyether as possible and it should preferably be of polyethylene oxide rather than polypropylene oxide type. A third consideration may also be the state of degradation of the polyurethane with some losses in ability to be expected with any significant oxidation of the polyether occurring. Finally, some attention should be paid to obtaining both hydrophilic and highly porous polymers as dictated by the exact method of manufacture since each of these properties will affect at least the rate of sorption if not also the position of equilibrium. Many other factors such as the polyether chain length and degree of cross-linking are also expected to be important but we are unable to verify this from the data of the experiment.

10. Effect of Various Foam Pretreatment Procedures on Cobalt Sorption

In order to test some of the possible sorption mechanisms suggested by the results of other experiments, it was desired to observe the effects which chemical pretreatment of foam might have on its ability to sorb cobalt from aqueous thiocyanate solution.

Although no true preliminary experiments had been undertaken to assess the effects of chemical attack on the polyurethane foam alone prior to use for cobalt sorption, one early observation showed that a reducing agent (hydroxylamine) added to the solution produced an increase in cobalt sorption while an oxidizing agent (hydrogen peroxide) had the opposite effect. This prompted some curiosity about whether the observed effect arose out of changes in the chemistry of the aqueous or of the foam phase.

With this in mind, a variety of chemical reagents with which to expose the polyurethane foam pieces were selected based on reactions which might be expected to destroy or create various types of sites in polyether-based polyurethane. Thus, since it was considered possible that some reduced nitrogen (such as amine) sites might be present either from polymerization catalysts or from unreacted products of isocyanate and water, several oxidizing agents (H_2O_2 , $\text{Ce(IV)} + \text{H}^+$, Cl_2) and reducing agents (NH_2OH , H_2NNH_2 , $\text{Ti(III)} + \text{H}^+$) were tested to see whether decreases or increases respectively in sorption would occur. Similarly, to evaluate whether or not Lewis base sites might be involved in the process, a few strong Lewis acids (SiCl_4 , BF_3) were included to see if these sites might be blocked. Finally, to investigate whether strong base anion

exchange sites might be present, two anions which form insoluble precipitates with many cations and cationic sites ($\text{B}(\text{C}_6\text{H}_5)_4^-$ and PF_6^-) were also tested for their ability to block sorption. It was planned to expose polyurethane foam pieces to each of these reagents for a sufficiently long period of time to allow some reaction to occur and then to rinse away the excess before testing cobalt sorption in the normal manner.

To accomplish this task, 1 liter of stock solution was first prepared exactly as described in the previous section ("effect of foam type"). As previously, when 20.00 mL of the stock and the appropriate weight of solid NaCl were diluted to the mark in individual 150.0 mL volumetric flasks, solutions which contained 0.100 M NaSCN, 1.7×10^{-6} M Co(II), 0.10 M $\text{NaOOCCH}_3/\text{HOOCCH}_3$ buffer and 2.80 M NaCl (to maintain ionic strength at 3.00 M) resulted. A summary of the initial conditions appears at the top of Table II-19.

For the experiment, regular 50 mg #1338 BFG foam pieces previously washed, dried and weighed as usual were employed but were first treated with the variety of substances listed above. To do this, solutions of each of the chemical reactants in a suitable solvent were prepared as outlined in Table II-19 then approximately 50 mL of each was transferred into 100 mL Pyrex (or polypropylene in the case of HPF_6) beakers in which the cleaned and weighed foam pieces had been placed. Air trapped within the foams was squeezed out using the bottom of a test-tube then the tops of the beakers were covered with polyvinylchloride film to retard evaporation. The foam pieces were left in contact with the solution at room temperature for a period of 18 hours accompanied by occasional squeezing. This length of time was thought to be sufficient to allow at least some

desirable or undesirable reactions to occur with the foam.

At the end of 18 hours, the solution was poured off and replaced by an equal volume of a rinse liquid (water, dilute HCl, diethyl ether or acetone as considered necessary to remove excess reactant). After repeated squeezing, the rinse liquid was discarded and replaced with a fresh 50 mL aliquot with continued squeezing. After sufficient rinsings with this liquid (usually about three but sometimes many more), a second rinse liquid occasionally followed the first one to finish the job. The completeness of rinsing was judged in the case of the foams treated with sodium tetraphenylborate by the presence or absence of a white precipitate when a solution of tetraethylammonium chloride was added to the rinse water. In other cases, only intuition dictated when the process was halted. After all rinsing was judged to be complete, each foam was squeezed nearly dry between sheets of filter paper and visually examined for changes in its physical appearance or mechanical properties. It was then dried in a vacuum desiccator under house vacuum (but without desiccant present) for 12 hours, examined once more for physical alterations, then reweighed to determine any mass changes.

Minor exceptions to this procedure were made in three cases in which there was no chemical pretreatment. Two of these were run as blanks while for the third one sodium tetraphenylborate was added directly to the solution rather than to the foam. In this last instance, the amount of NaCl added to the solution in its preparation was reduced to compensate for the increased ionic strength due to the $\text{NaB}(\text{C}_6\text{H}_5)_4$ present.

Cobalt extraction experiments were then performed exactly as outlined in the previous section ("effect of foam type") including the method

of sealing the distribution cells and the application of spectrometer sensitivity calibrations to correct for equipment drift. Since a total of twenty measurements were made, the experiment was split up into two parts performed on separate days with a separate blank being run with each to ensure intercomparability of the results. As in the previous experiment, problems were encountered with the temperature regulating apparatus on one of the days which necessitated allowing an additional 24 hours for equilibration to take place in that case.

A number of important observations were made during the pretreatment portion of the experiment. In particular, it was noted that both saturated chlorine water (a fairly strong oxidant) and 45% (w/w) BF_3 in diethyl ether (a strong Lewis acid) proved to be too efficient at attacking the foam since they both rendered it entirely unusable in the experiment. In the case of $\text{Cl}_2/\text{H}_2\text{O}$, the polyurethane turned orange quickly and then degenerated into a sticky yellow mass over 18 hours of exposure. The foam piece exposed to BF_3 /ether, on the other hand, swelled up immediately to fill the entire beaker and soon dissolved completely.

Although further experiments using chlorine as a reagent were not considered to be worthwhile, a number of lower concentrations (0.45, 2.25, 4.5 and 9.0% (w/w)) of boron trifluoride in diethyl ether were tested successfully without destroying the polymer completely. For the least concentrated of these, only a slight greying of the foam resulted from the treatment whereas the more concentrated ones again showed remarkable swelling of the polyurethane in ether solution along with some measure of stickiness and lack of resilience in the finished product. The sticky state of the foam pretreated with 4.5% (w/w) BF_3 in ether caused a portion of it to adhere to the test-tube used to squeeze it occasionally

and thus produced a slightly anomalous weight loss (see Table II-19).

Other changes in foam characteristics were observed with many of the other reagents. For instance, 0.01 M $\text{Ce}(\text{SO}_4)_2$ in 1 M HCl (the $\text{Ce}(\text{SO}_4)_2$ was actually less concentrated than this since not all of it could be persuaded to dissolve) stained the polyurethane pale yellow and also rendered it slightly sticky. Similar changes were also observed after treatment with 99.8% SiCl_4 liquid. On the other hand, 6.5% (w/w) HPF_6 in water caused the polymer to become pale brown while 2% (w/w) TiCl_3 in 0.1 M HCl dyed the foam a deep purple colour without any increase in stickiness. Sodium tetraphenylborate produced, in some cases, a slight stiffness in the polymer but was otherwise without visual change. Other reagents produced no apparent alterations.

A further observation was made, however, for those foams which were treated with sodium tetraphenylborate. For these foams, almost no amount of rinsing with water (up to ten 50 mL aliquots) was able to reduce the bleed of that substance to a quantity which would not produce a precipitate with tetraethylammonium chloride. Furthermore, roughly the same quantity of precipitate resulted after each rinsing so it was inferred that the tetraphenylborate must be effectively sorbed by the foam and is only poorly rereleased to fresh water. Acetone proved to be much more effective at removing the salt from foam.

Several other interesting observations were made during the cobalt distribution portion of the experiment. In most cases, the foam pieces assumed a pale blue or green colour after only several minutes of squeezing and then progressed to a darker blue-green over several hours. However, the three foams exposed to the most concentrated BF_3 /ether solutions

(2.25%, 4.5% and 9.0% (w/w)) became somewhat flattened with squeezing and were noticeably slower in developing a blue or green colour. This was also paralleled by a pronounced slowness in reaching maximum cobalt sorption over 24 or 48 hours compared to all other foams. A similar slowness in equilibrium attainment was also observed for the polymer treated with 0.45% (w/w) BF_3 /ether even though no stickiness or loss of physical shape was observed in this case. Thus, it appears that the slow sorption must reflect a difficult displacement of attached BF_3 from the polyurethane rather than simply a reduction in squeezing efficiency.

Interestingly, that foam which was pretreated with 99.8% SiCl_4 was seen to develop a striking orange-red colour immediately on contact with the Co(II)/SCN^- /buffer/ NaCl solution and this colour intensified gradually for about 10 minutes then faded slowly to tan-brown over 24 hours. The origin of this colour is not entirely certain but since almost all common silicon compounds are colourless or white (the sulfide, SiS_2 , is yellow), likely the colour is due to some other component present on the foam. A reasonable suspect is iron(III) likely present as a healthy contaminant in the 99.8% SiCl_4 which would, of course, form an intensely red-brown but unstable thiocyanate complex.

Further departures from the usual blue-green colouration were noted in the case of the foam pretreated with 0.1 M $\text{NaB(C}_6\text{H}_5)_4$ in water and also for the experiment in which 0.001 M $\text{NaB(C}_6\text{H}_5)_4$ was present in solution rather than prereacted with foam. In the former instance, the usual sorts of colours developed but inhomogeneously throughout the foam intermingled with areas in which very little colour appeared. This seems to show either uneven sorption or desorption of sodium tetraphenylborate

for some unknown reason. In the latter case, no colour at all developed on foam, paralleling the very low sorption measured for cobalt (about 0.9%).

The results of the experiment are collected in Table II-19 which shows the recorded weight changes arising from pretreatment along with the percentages of cobalt extracted and distribution ratios calculated on the basis of the final pretreated foam weight.

From the data, we see first of all that the distribution ratios measured for the blank on different days (sample numbers 1 and 2) are identical within the experimental counting uncertainties alone. Thus, data acquired on the two days may be intercompared. In addition, we see that a variety of weight and distribution ratio changes have resulted from the pretreatments. In many cases, the changes in foam weight have been quite small (a few tenths of a percent increase) and doubtless indicate that relatively minor residues of the reactants (or the impurities which they contain) are being sorbed and left behind on the polymer.

However, in other cases, fairly significant increases or decreases in weight were observed and these may be correlated to changes in D in some cases. For example, with ~ 0.01 M $\text{Ce}(\text{SO}_4)_2$, the polyurethane lost 2.6% of its weight likely either by adhesion to beaker walls, etc. or by cleavage of some important links to release water-soluble materials. This loss was accompanied by a modest decrease in D (about 6%) for the remaining polymer indicating that a small part of it had been somehow damaged.

Considerably larger weight losses were recorded for most of the foams treated with BF_3 (sample numbers 11, 12 and 13) where the products were

TABLE II-19 - EFFECT OF FOAM PRETREATMENT ON COBALT ABSORPTION

Initial Conditions:

[SCN⁻] 0.100 M (NaSCN) Foam Weight (W) 0.050 grams
 [Co] 1.7 x 10⁻⁶ M (0.10 ppm) Type #1338 BFG
 Ionic Strength (I) 3.00 M (NaCl) Squeezing Time 24.0, 48.0 hours
 pH 4.8 (0.1 M Na acetate buffer) Pretreatment Time 18.0 hours
 Solution Volume (V) 150.0 ml Temperature 25.00°C

Sample Number	Foam Pretreatment	Visible Changes of Foam	Weight Change On Treatment (%)	Final Foam Weight (mg) ±0.01	Contact Time (hours) ±0.1	Cobalt Extracted (%)	D (L kg ⁻¹)	log D
1	none	-	0	49.14	24.0	84.5 ±0.6	1.66 ±0.07 x 10 ⁴	4.220 ±0.017
2	none	-	0	48.77	48.0	84.8 ±0.5	1.72 ±0.06 x 10 ⁴	4.235 ±0.014
3	30% H ₂ O ₂ in water, dry rinse with water, dry	none	+0.3	50.76	24.0	84.4 ±0.8	1.60 ±0.08 x 10 ⁴	4.206 ±0.022
4	~0.01 M Ce(SO ₄) ₂ in 1 M HCl, rinse 0.1 M HCl, rinse water, dry	-yellowed, slightly sticky	-2.6	48.03	24.0	83.30 ±0.33	1.558 ±0.031 x 10 ⁴	4.192 ±0.009
5	Cl ₂ saturated in water, rinse with water, dry	-yellowed, collapsed, very sticky	-	-	-	-	-	-
6	1.0 M NH ₂ OH·HCl in water, rinse with water, dry	none	+0.5	49.26	24.0	83.9 ±0.5	1.59 ±0.05 x 10 ⁴	4.201 ±0.013

TABLE II-19 -continued

Sample Number	Foam Pretreatment	Visible Changes of Foam	Weight Change on Treatment (%)	Final Foam Weight (mg) ± 0.01	Contact Time (hours) ± 0.1	Cobalt Extracted (%)	D (L kg ⁻¹)	log D
7	8.5% H ₂ NNH ₂ in water, rinse with water, dry	none	+0.3	49.47	24.0	84.5 ± 0.5	1.66 ± 0.06 x 10 ⁴	4.220 ± 0.015
8	2% TiCl ₃ in 0.1 M HCl, rinse 0.1 M HCl, rinse water, dry	-became deep purple	+0.1	48.93	24.0	83.7 ± 0.5	1.58 ± 0.05 x 10 ⁴	4.199 ± 0.014
9	99.8% SiCl ₄ , rinse ether, dry	-yellowed, slightly sticky	+5.0	51.18	24.0	83.7 ± 0.5	1.51 ± 0.04 x 10 ⁴	4.179 ± 0.013
10	0.45% BF ₃ in diethyl ether, rinse ether, dry	-slightly greyed	+0.7	49.85	48.0	86.4 ± 0.7	1.91 ± 0.10 x 10 ⁴	4.281 ± 0.023
11	2.25% BF ₃ in diethyl ether, rinse ether, dry	-greyed, slightly sticky	-8.4	45.18	48.0	86.7 ± 0.4	2.16 ± 0.06 x 10 ⁴	4.335 ± 0.012
12	4.5% BF ₃ in diethyl ether, rinse ether, dry	-greyed, slightly sticky	<-13	42.41	24.0	84.5 ± 0.6	1.92 ± 0.07 x 10 ⁴	4.284 ± 0.016
13	9% BF ₃ in diethyl ether, rinse ether, dry	-greyed, slightly sticky	-6.4	46.19	48.0	87.1 ± 0.4	2.19 ± 0.06 x 10 ⁴	4.341 ± 0.012

TABLE II-19 -continued

Sample Number	Foam Pretreatment	Visible Changes of Foam	Weight Change on Treatment (%)	Final Foam Weight (mg) ± 0.01	Contact Time (hours) ± 0.1	Cobalt Extracted (%)	D (L kg ⁻¹)	log D
14	45% BF ₃ in diethyl ether, rinse ether, dry	-swelled completely, dissolved	-	-	-	-	-	-
15	6.5% HPF ₆ in water, rinse with water, dry	-browned	+0.4	47.41	24.0	84.1 ± 0.6	1.67 ± 0.06 x 10 ⁴	4.224 ± 0.016
16	0.01 M NaB(C ₆ H ₅) ₄ in water, rinse repeatedly with water, dry	-slightly stiff	+5.0	49.95	48.0	84.8 ± 0.5	1.67 ± 0.06 x 10 ⁴	4.223 ± 0.015
17	0.01 M NaB(C ₆ H ₅) ₄ in water, rinse repeatedly with water, rinse with acetone, dry	none	+0.3	50.36	48.0	87.4 ± 0.5	2.06 ± 0.09 x 10 ⁴	4.314 ± 0.018
18	0.1 M NaB(C ₆ H ₅) ₄ in water, rinse with water, dry	none	+24.0	60.44	24.0	43.4 ± 0.5	1.906 ± 0.028 x 10 ³	3.280 ± 0.006
19	0.1 M NaB(C ₆ H ₅) ₄ in acetone, rinse with acetone, dry	-slightly stiff	+0.2	50.52	48.0	85.6 ± 0.6	1.76 ± 0.07 x 10 ⁴	4.246 ± 0.018
20	0.001 M NaB(C ₆ H ₅) ₄ in solution rather than on foam	-	-	48.02	48.0	0.9 ± 0.5	2.8 ± 1.6 x 10 ¹	1.44 ± 0.25

also found to be sticky after pretreatment. As already mentioned, part of the decrease in mass for sample #12 was definitely due to foam material adhering to the bottom of the test-tube used in squeezing it but degradation and solubilization may have been more important factors in the other instances. However, treatment with the least concentrated BF_3 solution showed no mass loss at all but rather a modest increase of 0.7% instead (presumably from sorbed BF_3 and/or ether). In all of these cases, though, the sorption of cobalt from solution was markedly delayed by the BF_3 treatment (more noticeably so with those foams exposed to the most concentrated solutions but nevertheless easily visible for all). This delay must reflect strong interaction of BF_3 with the key sorption sites in the polyurethane (probably polyether oxygen atoms) until it is slowly displaced to other Lewis bases (e.g. H_2O). Curiously enough, though, we see that the equilibrium value of D which is eventually achieved after 24 or 48 hours (as displayed in the Table) has been increased as a result of the process by from 11 to 27 percent above the untreated value. This could conceivably be due either to generating or freeing more sites per unit of remaining foam mass or even to direct adduct formation between BF_3 and the extracted cobalt species. Exactly how either of these might come about is not entirely obvious, though, and the explanations offered are speculative.

Another observation to be made from the Table is the 5.0% increase in weight resulting from contact with 99.8% SiCl_4 followed by ether rinses. The increase in mass is accompanied by a small (about 9%) decrease in D indicating that perhaps a little blockage of sites is occurring but the efficacy of this Lewis acid in doing so is definitely not as

great as that of BF_3 .

A number of significant changes in mass were also measured in those cases of pretreatment with sodium tetraphenylborate in which rinsing with water only has been carried out. This seems to indicate that considerable sorption of $\text{NaB}(\text{C}_6\text{H}_5)_4$ has occurred and that the original solvent (water) is very inefficient at removing it. For example, from 0.01 M $\text{NaB}(\text{C}_6\text{H}_5)_4$, a 5.0% increase in weight is recorded when followed by repeated rinsings with water only (sample #16) but little more than a 0.3% increase is obtained when acetone is used also (sample #17). Comparison of the distribution ratios measured in each case shows that D is 23% greater in the second instance so $\text{NaB}(\text{C}_6\text{H}_5)_4$ obviously interferes with cobalt sorption in some way. Even more dramatic demonstrations of this interference are evidenced in sample #18 (0.1 M $\text{NaB}(\text{C}_6\text{H}_5)_4$ with a brief water rinse) which shows a 24.0% increase in foam weight and an accompanying 8.7-fold decrease in D compared to the blank and in sample #20 in which an approximately 600-fold decrease in D resulted from adding 0.001 M $\text{NaB}(\text{C}_6\text{H}_5)_4$ directly to the solution. All of these decreases in cobalt extraction can probably be interpreted in terms of sorption of $\text{B}(\text{C}_6\text{H}_5)_4^-$ in place of $\text{Co}(\text{SCN})_4^{2-}$ at some sort of cationic sites in the polymer and thus $\text{B}(\text{C}_6\text{H}_5)_4^-$ may be regarded as a fairly effective competitor. However, the possibility also exists that some of the interference may take place in the aqueous phase perhaps from ion pairing between Co^{2+} and $\text{B}(\text{C}_6\text{H}_5)_4^-$ or some similar phenomenon which would cause a shift to decreased $\text{Co}(\text{SCN})_4^{2-}$ formation. Although this may not be ruled out entirely, it is not felt that it would be at all a major contributor to the effects observed since the solutions are so dilute in both cobalt and tetraphenylborate ions. As a partial confirmation of this, filtration of the solution containing 0.001

M $B(C_6H_5)_4^-$ through a 0.45 μ m filter after reaching equilibrium with foam showed at least that no cobalt-containing precipitates were formed.

Some further very interesting bits of information are also available from the data involving tetraphenylborate ion. For example, much as in the case of BF_3 , a 20% increase in D as compared to the blank is measured to occur for sample #17 where $B(C_6H_5)_4^-$ has apparently been deposited and then almost entirely removed by rinsing with acetone (the 0.3% increase in weight still remaining could only fill about 1/100 of the known maximum number of sites on foam). One can only guess that some new sites may have been opened up by this treatment perhaps by rearranging the three dimensional conformation of the polymer chains into a shape which then accepts other absorbed species more readily. On the other hand, no such increase in D was noted in the case of sample #19 in which the $NaB(C_6H_5)_4$ was applied in acetone solution instead and removed by means of the same solvent. Presumably, under these conditions no sorption and rearrangement of the polymer has occurred if the above hypothesis is true. This is, of course, only speculation at this point which will only gain some significance when the Cation Chelation Mechanism is discussed more fully later.

Having thus discussed most of the data in Table II-19 we may then summarize the mechanistic inferences to be drawn from them. First of all, since we do not observe appreciable increases or decreases in D in the presence of several oxidizing and reducing agents, we conclude that the preliminary observations which showed changes with hydroxylamine and hydrogen peroxide were not due to foam site formation or destruction but were more likely solution phenomena. Consequently, amine-type sites must not be present in significant numbers or at least are not involved in the

sorption of cobalt. Therefore, a weak base anion exchange type of mechanism seems doubtful.

On the other hand, BF_3 (which is a particularly good Lewis acid for sites such as the polyether oxygen atoms) shows inhibition of cobalt sorption until such time as it is removed by and transferred to other substances in the solution (most probably H_2O). The failure of SiCl_4 to do much the same thing in blocking foam sites even though some was initially absorbed by foam likely results from the fact that SiCl_4 is easily hydrolyzed in the presence of water and so would have been readily removed from the foam on contact with the cobalt-containing solution. Thus, we strongly suspect that the polyether oxygen sites are, in fact, very important to cobalt sorption in agreement with what we have already suggested on the basis of studies with different foam types. Furthermore, since sodium tetraphenylborate present on foam (originating either by a pretreatment step or by simultaneous sorption from solution) competes fairly effectively with cobalt as $\text{Co}(\text{SCN})_4^{2-}$, we guess that there may be a number of cationic sites involved. The failure of PF_6^- to similarly interfere at these sites is probably since it is not a bulky, hydrophobic and highly polarizable anion (such as are both $\text{Co}(\text{SCN})_4^{2-}$ and $\text{B}(\text{C}_6\text{H}_5)_4^-$) and so is not readily accommodated in polyurethane. In fact, much of the observed 0.4% increase in foam weight after treatment is attributed to some dark insoluble impurities in the HPF_6 which imparted the brown colour to the foam.

Thus, taken together, we conclude that the experimental results appear to be consistent with an extraction mechanism involving the polyether portion of the polyurethane in which cationic sites of some type may

possibly be involved.

Although the experiment was designed solely as a means of obtaining information of a mechanistic nature, the results might also be considered from an applications point of view. In this light, we note that at least one anion (tetraphenylborate) is capable of interfering quite strongly with cobalt sorption. Later, we will see that some others do so also and together these could probably be exploited for the recovery of cobalt from foam. However, a number of other means are already at our disposal (temperature, $[\text{SCN}^-]$, pH, ionic strength, etc.) so a more important use might be for displacement elution in column chromatography instead. Also, although the slight increases in sorption efficiency (20% or so) shown to be produced by certain pretreatment procedures might possibly be of interest in an industrial setting where very high performance is required, more dramatic improvements would probably be available in other ways such as careful polymer choice and the pretreatment route would likely be uneconomical.

11. Effect of Various Anions, Metal Ions and Nitrogen-Containing Substances on Cobalt Sorption by Polyurethane Foam

It was desired to establish what effect the presence of a wide variety of substances in solution might have on the sorption of cobalt thiocyanate. This experiment was undertaken in order to delineate the limits of concentration within which these substances could be tolerated in analytical or industrial use, to shed further light on the extraction mechanism and to suggest other areas of fruitful investigation.

A brief preliminary study to assess the effects of a few anions as their sodium salts was carried out quite early and has already been described in conjunction with the experiments concerning ionic strength effects. The results of the study appear in Table II-16 and show that both qualitative and quantitative differences exist among the various anions in respect of their effects on cobalt sorption. In some cases, enhancements were apparently produced while in others interferences definitely occurred. As a result of this, it was decided to conduct a much larger test including many more anions and the experiment was later extended to include a wide variety of metal ions and nitrogen-containing compounds as well.

In planning the experiment, it was considered important to keep the number and amounts of solution components to a minimum in an effort to simplify interpretation. Therefore, no NaCl was added to each solution (as was done in most previous experiments) and no effort was thus made to control the ionic strength. However, since a substantial drop in cobalt extraction accompanied the resulting lower ionic strength, it was

necessary to use a greater than usual concentration of NaSCN in order to keep the percentage of cobalt extracted in the range of highest measurement accuracy. Thus, a thiocyanate concentration of 0.50 M was used. In addition, since it was also desired to hold the solution pH within the already established optimum range (about 1 to 9) whenever possible but without undue influence on the solution chemistry, a mild sodium acetate/acetic acid buffer of 0.10 M strength was also incorporated. Aside from Co(II) and ^{60}Co tracer, no other reagents apart from the substance under study were added to the solution.

To perform the experiment, a 2 liter stock mixture containing NaSCN, $\text{NaOOCCH}_3/\text{HOOCCH}_3$ buffer and Co(II) was first prepared such that 20.00 mL aliquots would yield 0.50 M NaSCN, 0.10 M buffer and 1.7×10^{-6} M (0.10 ppm) Co(II) when diluted to 150.0 mL. Owing to the very large number of experiments, three such stock solutions were eventually required and were prepared as the need arose. Since different bottles of reagents often had to be used, each may have differed slightly from the others in concentrations or impurity levels and therefore had to be "standardized" in some way (to be described). A predetermined quantity of the substance selected for testing was then weighed into a 100 mL beaker, dissolved and transferred quantitatively to a 150.0 mL volumetric flask followed by 20.00 mL of the stock solution and a sufficient quantity of ^{60}Co tracer to produce an initial count rate of about 300 seconds $^{-1}$. After diluting to near the mark and mixing, the flask was allowed to stand overnight before final dilution and mixing were performed. The appearance of each solution was noted at that time before the contents were initially counted and then emptied into distribution cells. A summary of the initial

solution conditions appears at the top of Tables II-20, II-21 and II-22.

The procedure followed in the distribution study did not differ substantially from that already described in the Experimental section. Type #1338 BFG polyurethane foam pieces of 50 mg size were employed as usual. Double condoms and silicone grease were used to seal the distribution cells and a thin film of silicone grease was coated onto the plunger stems to retrieve any shredded bits of foam. Samples were withdrawn for counting and observation after 6, 12 and 24 hours and corrections to allow for any drift in spectrometer sensitivity were applied to the data. At the end of 24 hours, the final pH of each solution was determined by glass electrode to note any changes and to ensure that it still remained within the optimum range for cobalt sorption.

Blank experiments in which no extraneous substance was added to the solution were performed periodically in order to test the reproducibility of the experiment, to "standardize" the various batches and to provide a measure of extraction in the absence of additives. A total of three such experiments was performed for each batch of stock solution prepared and the resulting calculated distribution ratios were averaged. Comparison of these averages for the three different stock solutions showed that small differences (by as much as 9%) existed amongst them so that all experimental results were not directly intercomparable. However, to circumvent this problem (as a "standardization" procedure) and to allow easier comparison to be made between results with and without additives, the ratio (D/D_0) of the distribution ratio, D , measured when additives were present to the average distribution ratio, D_0 , measured on that particular batch of stock solution in their absence was calcu-

lated in each case. A value of $D/D_0 = 1.000$ therefore indicated that the added substance had no effect on cobalt sorption while values above and below this represented enhancement and depression, respectively.

In most instances, several concentrations of each added substance were tested. High concentrations were generally tried first, then, depending upon the results of these, progressively lower concentrations were used until any interferences noted became very small. In this way, interference/concentration profiles (Figures 2-25, 2-26 and 2-27) were obtained for many of the substances tested. Information about the source and purity of the variety of reagents used has already been presented in Table II-1.

The results of the experiment are collected into Tables II-20, II-21 and II-22 which show the final solution pH, percentage of cobalt extracted, calculated distribution ratio (D) and its ratio to that of the blank (D/D_0) for the various concentrations of the many substances tested. The three Tables divide the data into that pertaining to the sodium salts of anions, many metal ions (usually as chlorides or nitrates when these were available) and an assortment of selected nitrogen-containing substances. A number of observations of both foam and solution made during the experiment are also included in the Tables and will be dealt with in discussing the results.

As an auxiliary experiment to aid in distinguishing between effects arising out of changes in the state of cobalt itself (i.e. the amount of $\text{Co}(\text{SCN})_4^{2-}$ formed) and other phenomena, a small spectrophotometric study was also initiated at the conclusion of the above work. Thus, in several cases in which either substantial enhancement or depression of cobalt

sorption were found to occur, both visual observations and measurements of the electronic absorption spectra of solutions containing the same constituents and treated in a similar manner were obtained. In this case, however, in order to observe any spectrum at all, it was necessary to increase the Co(II) concentration 1000-fold to 1.7×10^{-3} M (100 ppm). Initial observations and measurements of spectra were made within 1-2 hours after the mixtures were first prepared. They were next allowed to stand at room temperature overnight and then at 25.00°C for a further 24 hours before the observations and spectra were repeated in order to mimic the history of the solutions used in the distribution study as closely as possible. A wide range of cuvet path lengths (1, 10, 40 and 100 mm) were used in the measurements to allow most peaks to be brought on scale. In all cases, the spectra obtained before and after the 24 hour period were not substantially different. The results appear in Table II-23 and will be dealt with in later discussions as required.

Considering first the effects of various anions (as their sodium salts) on the sorption of cobalt, we see from a perusal of Table II-20 that, as expected, both enhancements and interferences can occur with the addition of different salts to solution. A striking difference in the magnitudes of the effects, however, is visible when the results of Tables II-16 (the preliminary experiment) and Table II-20 are compared. In almost all cases, we see more dramatic changes in D occurring in the more recent data for the same 1.0 M addition of the various sodium salts. For example, in the current experiment, a 13-fold increase in D results from the addition of 1.0 M NaCl but only a 1.2-fold change was produced in the previous case. This vast difference is doubtless brought about

by the dissimilar experimental conditions existing in the two instances (present experiment 0.50 M NaSCN, 0.10 M NaOOCCH₃/HOOCCH₃, 1.7 x 10⁻⁶ M Co(II), 25.00°C, 50 mg foam; preliminary experiment 1.0 M NH₄SCN, 1.0 M NaOOCCH₃/HOOCCH₃, 2.12 x 10⁻⁵ M Co(II), 22°C, 20 mg foam). Although all differences may play a part, likely the most important factors in this discrepancy are the relatively large concentrations of both NH₄⁺ and Na⁺ ions present on the one hand compared to a lower Na⁺ concentration and no NH₄⁺ on the other. As we shall see later, the NH₄⁺ ion is an especially good cation for extraction and so its presence in large amounts is expected to diminish the effects of adding Na⁺ to solution as we seem to be observing.

Returning to the present experiment, then, a part of the effects visible in Table II-20 is expected to be due only to increases in ionic strength and to the presence of additional extractable cation, Na⁺ (as we have discussed in an earlier section). However, the remainder may conceivably result either from competitive reactions between added ligands and SCN⁻ to form other cobalt complexes (which are more or less extractable than Co(SCN)₄²⁻), destruction of the SCN⁻ ligand by chemical reaction, competitive sorption onto foam from solution of species other than Co(SCN)₄²⁻, or alteration of some important solution parameter such as pH.

If we assume (as we have done previously) that Cl⁻ is a sufficiently weak ligand for cobalt that it does not appreciably affect solution equilibria and also that it is not extracted into polyurethane to any great extent at pH 4-5, then the other modes of interference described above will also be negligible as well and we may suppose that the addi-

TABLE II-20 - continued

Anion	[Source]	Concentration (M)	Final pH 0.01	Foam Weight (mg) 0.01	Cobalt Extracted (%)	D (L kg ⁻¹)	D/Do*	Observations
I ⁻	[NaI]	1.00 x 10 ⁰	5.03	50.06	98.0 ±0.3	1.49 ±0.26	13.0 ±2.3	-solution yellows slowly on standing -foam turns brown
		1.00 x 10 ⁻¹	4.78	48.62	84.6 ±0.7	1.70 ±0.08	1.35 ±0.07	
NO ₃ ⁻	[NaNO ₃]	1.00 x 10 ⁰	5.01	50.38	97.06 ±0.28	9.8 ±0.9	8.6 ±0.8	-foam turns mauve, then blue green
		1.00 x 10 ⁻¹	4.78	50.30	84.6 ±0.5	1.64 ±0.06	1.31 ±0.05	
NO ₂ ⁻	[NaNO ₂]	1.00 x 10 ⁻¹	4.86	49.65	79.8 ±0.7	1.19 ±0.04	0.95 ±0.04	-foam turns brown
		1.00 x 10 ⁻²	4.83	51.07	78.29 ±0.32	1.059 ±0.016	0.924 ±0.021	-foam turns brown-yellow turns brown
HCO ₃ ⁻	[NaHCO ₃]	1.00 x 10 ⁻¹	7.04	50.98	83.9 ±0.4	1.53 ±0.04	1.22 ±0.04	-gas evolved slowly -foam turns green
		1.00 x 10 ⁰	5.00	50.27	97.6 ±0.4	1.21 ±0.21	10.6 ±1.9	
ClO ₃ ⁻	[NaClO ₃]	1.00 x 10 ⁻¹	4.85	49.36	83.2 ±0.5	1.50 ±0.04	1.31 ±0.04	

TABLE II-20 - continued

Anion	[Source]	Concentration (M)	Final pH ±0.01	Foam Weight (mg) ±0.01	Cobalt Extracted (%)	D (L kg ⁻¹)	D/Do*	Observations
ClO ₄ ⁻	[NaClO ₄ ·H ₂ O]	1.00 x 10 ⁰	5.05	48.64	96.7 ±0.6	9.0 ±1.7	x 10 ⁴ 7.9 ±1.5	
					85.6 ±0.8	1.79 ±0.10	x 10 ⁴ 1.43 ±0.08	
H ₂ PO ₄ ⁻	[NaH ₂ PO ₄ ·H ₂ O]	1.00 x 10 ⁰	4.88	49.89	96.8 ±0.8	9.1 ±2.4	x 10 ⁴ 7.9 ±2.1	
					83.8 ±0.7	1.59 ±0.07	x 10 ⁴ 1.27 ±0.06	
CN ⁻	[NaCN]	1.00 x 10 ⁻¹	7.45	50.55	0.4 ±0.8	1.1 ±2.3	x 10 ¹ 0.0009 ±0.0018	-foam remains white
					0.3 ±0.6	1.0 ±2.0	x 10 ¹ 0.0008 ±0.0016	-foam remains white
SO ₃ ²⁻	[Na ₂ SO ₃]	9.98 x 10 ⁻⁴	4.80	49.78	78.9 ±0.6	1.128 ±0.033	x 10 ⁴ 0.900 ±0.032	-foam turns green then blue-green
					80.2 ±0.4	1.231 ±0.023	x 10 ⁴ 0.964 ±0.024	
SO ₃ ²⁻	[Na ₂ SO ₃]	1.00 x 10 ⁰	8.04	49.44	69.82 ±0.30	7.02 ±0.08	x 10 ³ 0.612 ±0.013	-Cobalt desorbs steadily after being sorbed
					85.2 ±0.7	1.76 ±0.09	x 10 ⁴ 1.40 ±0.08	

TABLE II-20 - continued

Anion	[Source]	Concentration (M)	Final pH ± 0.01	Foam Weight (mg) ± 0.01	Cobalt Extracted (%)	D (L kg^{-1})	D/Do*	Observations
SO_4^{2-}	[Na_2SO_4]	1.00×10^0	5.42	49.77	98.2 ± 0.8	1.7×10^5	15 ± 6	-small amount of white precipitate -foam turns red then blue-green
								4.83
$\text{S}_2\text{O}_3^{2-}$	[$\text{Na}_2\text{S}_2\text{O}_3 \cdot 5\text{H}_2\text{O}$]	1.00×10^0	5.51	50.24	99.0 ± 0.6	2.9×10^5	25 ± 15	-white precipitate forms -white precipitate collects on blue-green foam
								4.80
S^{2-}	[$\text{Na}_2\text{S} \cdot 9\text{H}_2\text{O}$]	9.99×10^{-2}	11.21	49.40	11.8 ± 0.6	4.06×10^2	0.0324 ± 0.0018	-strong H_2S smell -solution turns yellow initially then colourless
								6.99
CrO_4^{2-}	[Na_2CrO_4]	1.00×10^0	8.01	50.80	53.48 ± 0.32	3.394×10^3	0.296 ± 0.006	-solution orange -light haze develops slowly
								6.97

TABLE II-20 - continued

Anion	[Source]	Concentration (M)	Final pH ± 0.01	Foam Weight (mg) ± 0.01	Cobalt Extracted (%)	D (L kg ⁻¹)	D/Do*	Observations
CH ₃ COO ⁻	[NaC ₂ H ₃ O ₂ · 3H ₂ O]	1.00 x 10 ⁰	6.26	49.39	95.9 ± 0.4	7.1 ± 0.7	x 10 ⁴ 6.2 ± 0.7	
		1.00 x 10 ⁻¹	5.18	47.77	84.0 ± 0.4	1.64 ± 0.04	x 10 ⁴ 1.31 ± 0.04	
C ₂ O ₄ ²⁻	[Na ₂ C ₂ O ₄]	<1.00 x 10 ⁻¹	4.93	50.02	0.0 ± 0.6	0.0 ± 1.8	x 10 ¹ 0.0000 ± 0.0014	-will not dissolve completely
		1.00 x 10 ⁻²	4.81	48.56	19.6 ± 0.5	7.55 ± 0.20	x 10 ² 0.060 ± 0.002	-foam remains white -foam turns pale green then faint green
(CH(OH)COO) ₂ ²⁻ tartrate	[Na ₂ C ₄ H ₄ O ₆ · 2H ₂ O]	1.03 x 10 ⁻³	4.79	49.85	63.4 ± 0.7	6.51 ± 0.15	x 10 ³ 0.520 ± 0.016	-foam turns light blue-green
		1.02 x 10 ⁻⁴	4.80	48.90	77.7 ± 0.6	1.068 ± 0.029	x 10 ⁴ 0.932 ± 0.030	
		1.08 x 10 ⁻⁵	4.76	49.03	80.48 ± 0.25	1.261 ± 0.017	x 10 ⁴ 0.987 ± 0.020	
		1.00 x 10 ⁻¹	4.95	51.74	69.2 ± 0.4	6.53 ± 0.08	x 10 ³ 0.521 ± 0.012	-foam turns green
		1.00 x 10 ⁻²	4.81	50.38	80.0 ± 0.5	1.189 ± 0.032	x 10 ⁴ 0.949 ± 0.031	
		9.98 x 10 ⁻⁴	4.80	50.86	79.5 ± 0.7	1.14 ± 0.04	x 10 ⁴ 1.00 ± 0.04	

TABLE II-20 - continued

Anion [Source]	Concentration (M)	Final pH ± 0.01	Foam Weight (mg) ± 0.01	Cobalt Extracted (%)	D (L kg ⁻¹)	D/Do*	Observations
(C(OH)COO)(CH ₂ COO) ₂ ³⁻ citrate	1.00 x 10 ⁻¹	5.51	49.00	1.6 ± 0.7	5.1 ± 2.2	0.0041 ± 0.0018	-foam remains white
	1.00 x 10 ⁻²	4.89	49.89	38.6 ± 0.5	1.888 ± 0.029	0.151 ± 0.004	-foam turns pale green
	9.91 x 10 ⁻⁴	4.80	51.39	74.3 ± 0.5	8.44 ± 0.17	0.673 ± 0.019	-foam turns pale blue- green
	9.96 x 10 ⁻⁵	4.80	50.45	78.9 ± 0.4	1.108 ± 0.024	0.967 ± 0.027	
	1.02 x 10 ⁻⁵	4.76	50.45	81.0 ± 0.6	1.27 ± 0.04	0.992 ± 0.034	
(CH ₂ N(COOH)COO) ₂ ²⁻ EDTA	1.00 x 10 ⁻¹	4.87	48.94	0.2 ± 0.4	5 ± 12	0.0004 ± 0.0009	-foam remains white
	1.00 x 10 ⁻²	4.79	49.80	0.0 ± 0.6	0.0 ± 1.9	0.0004 ± 0.0015	-foam remains white
	1.00 x 10 ⁻³	4.79	50.76	0.0 ± 0.7	0.0 ± 2.1	0.0000 ± 0.0017	-foam remains white
	1.01 x 10 ⁻⁴	4.81	49.56	0.0 ± 0.6	0.0 ± 1.7	0.0000 ± 0.0014	-foam remains white
	1.00 x 10 ⁻⁵	4.80	49.44	2.9 ± 0.8	9.1 ± 2.4	0.0072 ± 0.0019	-foam remains white
[Na ₂ C ₁₀ H ₁₄ O ₈ N ₂ ·2H ₂ O]	9.95 x 10 ⁻⁷	4.80	50.53	73.1 ± 0.4	8.06 ± 0.13	0.704 ± 0.017	-sorption a bit slow -foam turns blue-green
	9.95 x 10 ⁻⁸	4.81	50.00	80.4 ± 0.4	1.234 ± 0.024	1.077 ± 0.028	

TABLE II-20 - continued

* It was necessary to prepare three separate batches of stock $\text{NaSCN}/\text{NaOOCCH}_3/\text{HOOCCH}_3/\text{CoCl}_2$ solutions to complete all of the experiments. The value of Do used in each case is the average of three separate measurements of distribution ratio made in the absence of any interferent using the appropriate batch of stock solution.

** Average of all blank experiments conducted with all three batches of stock solution. Except where noted otherwise, the observations for other experiments are identical to those shown here for no interferent present.

tion of NaCl to the solution represents only the combined effects of increased extractable cation (Na^+) availability and solution ionic strength. Some support for this view is provided by the spectrophotometric study summarized in Table II-23 in which the absence of spectral changes indicates that no apparent shift in solution equilibria likely occurs with addition of 1.0 M NaCl. As we see from Table II-20, the result of adding 0.10 M NaCl to solution is to increase the distribution ratio of cobalt 1.38-fold while 1.0 M NaCl produces a 13-fold increase. We note that this is numerically very similar to the effects of both NaBr and NaI which might also be expected to be comparatively inert towards cobalt ($\log K_1 \sim -2.3$, $\log K_2 K_3 \sim -4.9$ for Br^- ; no evidence available for complex formation in aqueous solution for I^- ⁽²³⁰⁾).

The equivalent behaviour of Cl^- and Br^- was previously observed in the preliminary experiment (Table II-16) but on that occasion, differences between these two and NaI were evident which did not materialize in this experiment. There are several possible reasons for this discrepancy. One such could be additional free radical-initiated oxidation of I^- to I_2 by atmospheric oxygen since the preliminary experiment was exposed to fluorescent light and occasionally sunlight during the equilibration period while the second was essentially carried out in the dark. Thus, perhaps less I_2 was formed in the latter case although its presence was still evidenced by solution yellowing and a brown colour acquired by foam. However, a number of other factors (such as the much higher solution cobalt content and thus closer approach to saturation of the foam in the preliminary experiment) may also have contributed to the discrepancy.

Another substance which produced very similar values of D/D_0 is sodium sulfate (Na_2SO_4) which is seen from Table II-20 to have an enhancing effect on cobalt sorption perhaps even slightly greater than that of the halide salts. However, since a 1.0 M solution of Na_2SO_4 contains twice as many Na^+ ions and has three times the ionic strength of a 1.0 M NaCl solution, the fact that D/D_0 is nearly the same indicates that some form of mild interference is actually at work in the presence of SO_4^{2-} . This is apparently so since precipitation from solution of a small amount of an unidentified white solid (evidently too much for it to be CoSO_4) occurred. Another difference between the results of this experiment and that carried out previously was that although observations of the preliminary experiment had indicated that a decrease in the rate of cobalt sorption had resulted from the addition of 1.0 M Na_2SO_4 to solution, no such decrease was noted in this case. Thus, the previous observation may have had another cause or was influenced by the substantially different conditions existing then.

Similar precipitation to that of sulfate but with greater enhancements of cobalt sorption were found also with the addition of its analogue, thiosulfate (as $\text{Na}_2\text{S}_2\text{O}_3 \cdot 5\text{H}_2\text{O}$). The observed increase in cobalt distribution ratio over that expected with the addition of 1.0 M NaCl is probably still less than what one might expect from the added cation concentration and higher ionic strength so there is likely a small interference effect here, as well.

As further difference between the results of the preliminary experiments and these, we observe also that NaNO_3 in this case shows less enhancement of cobalt sorption relative to NaCl than it did in the previ-

ous experiment. The reason for this difference is not known definitely but, of course, many experimental parameters as well as the expected precision of the measurements are different in the two instances. Further, since a mauve colour was initially imparted to foam in the present experiment, it is likely that some other material (perhaps a decomposition product of SCN^- or a complex of cobalt or trace metals present) is also formed and is partly extractable under these conditions. The spectrophotometric study (Table II-23) indicates that no major changes in solution cobalt-thiocyanate equilibria occur with NaNO_3 addition so only small amounts of cobalt-nitrate complexes could be present.

Similar moderate enhancements of cobalt sorption (but less than those for NaCl , NaBr and NaI) are also produced by several other salts. Of these, NaClO_3 and NaClO_4 do not appear from spectrophotometric measurements (Table II-23) to alter the cobalt-containing equilibria noticeably and thus must act in interfering by some other means. We have previously discussed the probable behaviour of perchlorate in this respect and concluded that it was likely extractable to some extent by polyurethane foam thus interfering mildly by competition for available sorption sites or "solvent". Presumably, this mode of action may also apply to the chlorate anion since it is also reasonably large and polarizable. On the other hand, sodium dihydrogen phosphate (NaH_2PO_4), which also displays much the same quantitative effects, is known⁽²⁰⁰⁾ to form a phosphate precipitate ($\text{Co}_3(\text{PO}_4)_2 \cdot 8\text{H}_2\text{O}$) with cobalt under suitable conditions and so may be expected to interfere slightly perhaps by ion association in the aqueous phase. This would be qualitatively consistent with the

spectrophotometric observations which showed a small decline in the cobalt absorption spectrum in its presence.

Another salt which displayed enhancement effects noticeably smaller than NaCl was sodium acetate ($\text{NaC}_2\text{H}_3\text{O}_2 \cdot 3\text{H}_2\text{O}$). In this case, spectrophotometric study showed some evidence for a small amount of new cobalt complex formation as predicted by the acetate formation constants (see Table II-14). This observation has some significance, of course, since sodium acetate/acetic acid buffer was used throughout the experiments.

An apparent small depressive effect was also noted for the addition of 0.10 M NaHCO_3 to the solution. In this case, bubbles of gas (undoubtedly CO_2) were released and the pH was thereby increased to a value of 6.8. Although this is well within the optimum range for cobalt sorption, it was not possible to add larger quantities of HCO_3^- since the pH would then have been driven beyond 9. The hydroxide of cobalt, $\text{Co}(\text{OH})_2$, is said⁽²⁰⁰⁾ to be produced by the addition of sufficient carbonate or bicarbonate ion in an alkaline medium but its formation in any significant amount in this instance seems unlikely. Therefore, some other small depressive effect is likely at work - perhaps slight competitive sorption of the anion itself since carbonate is reported⁽²³⁷⁾ to be highly extracted by some anion exchangers.

Somewhat larger depressive effects were noted for the addition of a few other salts to solution. The first among these was sodium fluoride (NaF) which demonstrated the peculiar tendency of forming a white precipitate and even separating into two liquid phases at 1.0 M concentration.

From the spectra measured, it would seem that some small amounts of a new species may be formed in the process but this is not certain. The fluoride of cobalt, CoF_2 , is sparingly soluble but is not readily formed in aqueous solution⁽²⁰⁰⁾.

Sodium nitrite (NaNO_2) also showed moderate effects of depression on cobalt sorption. Unfortunately, the increased absorptions in the ultraviolet and violet regions of the spectrum were so large as to obscure any detail in the cobalt spectrum. Presumably, the observed interference effect could result either from formation of non-extractable cobalt complexes, destruction of SCN^- or of polyurethane foam. The oxidation of SCN^- by HNO_2 to give sulfate, cyanide and sulfur dicyanide is known⁽¹⁷⁶⁾ to occur but may not be significant at the pH being considered here.

Moderate interference was also produced by sodium sulfite (Na_2SO_3) and in this case spectrophotometric observation indicated that new unextractable cobalt complexes were most likely produced (perhaps similar to $\text{CoSO}_3 \cdot 5\text{H}_2\text{O}$). In addition, some subsequent chemical attack of either polyurethane or SCN^- appears to have occurred since cobalt which was originally sorbed onto foam was slowly re-released to solution over 24 hours of equilibration.

Stronger interferences were produced by a few organic and inorganic anions. For example, sodium sulfide ($\text{Na}_2\text{S} \cdot 9\text{H}_2\text{O}$) added at about 0.1 M concentration was found to create large depressions in cobalt sorption. However, since the capacity of the 0.1 M acetate buffer was thereby exceeded, the pH of the solution jumped to nearly 11 by this addition so most of the effect is expected to be by formation of cobalt hydroxide,

of mixed cobalt sulfide and hydroxide species (i.e. $\text{Co}(\text{SH},\text{OH})_2$ with the ratio of SH^- to OH^- ligands being dependent on solution alkalinity) or a variety of cobalt-sulfur complexes in quite basic solution⁽²⁰⁰⁾. By reducing the sulfide concentration to half this value (0.05 M), the solution was kept very slightly acidic (pH 6.76) and under these circumstances an enhancement ($D/D_0 = 3.35$) rather than a depression ensued.

Sodium tartrate ($\text{Na}_2\text{C}_4\text{H}_4\text{O}_6 \cdot 2\text{H}_2\text{O}$) also demonstrates significant interference of sorption ($D/D_0 = 0.521$) at the level of 0.10 M but considerably less at lower concentrations. From the spectrum measured, it appears that only minor formation of some cobalt-tartrate complex may be occurring in solution although this could be expected to be slightly greater at the lower cobalt concentration used in the sorption study.

Also, from Table II-20, we see that sodium chromate (Na_2CrO_4) at 1.0 M concentration produces fairly strong interference ($D/D_0 = 0.296$) but at 0.1 M has only a relatively small effect. Since the solution was observed to be orange in both cases, at least some of the yellow chromate ion was first converted to dichromate ($\text{Cr}_2\text{O}_7^{2-}$) in the mildly acidic environment according to: $2\text{CrO}_4^{2-} + 2\text{H}^+ \rightleftharpoons \text{Cr}_2\text{O}_7^{2-} + \text{H}_2\text{O}$. Although spectrophotometric measurements made on the solution could not be especially conclusive, the chief mode of interference here would likely be the oxidation of some of the solution thiocyanate either by chromate or by dichromate to form, ultimately, sulfate and cyanide according to⁽¹⁷⁶⁾: $2\text{CrO}_4^{2-} + \text{SCN}^- + 8\text{H}^+ \rightleftharpoons 2\text{Cr}^{3+} + \text{SO}_4^{2-} + \text{CN}^- + 4 \text{H}_2\text{O}$. Interference would then be either by loss of SCN^- ligand or, more probably, by the effects of the CN^- produced (discussed below).

Even more dramatic interferences were observed with a group of carbon-containing anions for which thiocyanate oxidation is not a consideration. The interference/concentration profiles for these anions have been plotted in Figure 2-25 for comparison between one another and with the cobalt concentration (shown by arrow). Sodium cyanide (NaCN), for example, at as little as 0.010 M almost completely prevents cobalt sorption ($D/D_0 = 0.0008$) and is still not entirely without effect at 1.10×10^{-4} M concentration ($D/D_0 = 0.964$). Spectrophotometric study shows that new and apparently unextractable cobalt complexes are definitely produced in this case and the thiocyanato ones are thus disfavoured. This is in agreement with the known⁽²³⁰⁾ ability of CN^- to behave as a strong ligand for cobalt producing complexes containing various numbers of cyanide ligands.

Much the same sort of behaviour is demonstrated by both sodium oxalate ($Na_2C_2O_4$) and sodium citrate ($Na_3C_6H_5O_7 \cdot 2H_2O$) both of which also are known to form reasonably stable complexes with cobalt ions (oxalate $\log K_1 \sim 3.7$, $\log K_2 \sim 2.3$; citrate $\log K \sim 4.5$ ⁽²³⁰⁾). This is further confirmed by our spectrophotometric measurements (Table II-23) which show that some alteration of the form of the cobalt species occurs in the presence of 0.1 M concentrations of both these salts. Oxalate ion, for instance, at a concentration approaching 0.1 M (less than this since a portion would not dissolve) interfered to the extent that no cobalt sorption by polyurethane foam could be measured at all (i.e. $\log D/D_0 \approx -\infty$ but plotted in Figure 2-25 simply as $\log D/D_0 < -3.5$). Presumably, this results from the extensive formation of the 1:1 and 2:1 oxalate-cobalt complexes. Citrate, on the other hand, was slightly less

Figure 2-25

Interference/concentration profiles for several strongly interfering anions in the sorption of cobalt by 50 mg pieces of #1338 BFG polyurethane foam from 150.0 mL of solution. Equilibration was carried out for a period of 24.0 hours at 25.00°C. Anions were added as their sodium salts and their concentration is given in mol L⁻¹. Interference is measured by the ratio of the cobalt distribution ratio in the presence (D) and in the absence (Do) of the salt. All values of log (D/Do) which were less than -3.5 are plotted at "< -3.5". For comparison, the initial solution cobalt concentration (in mol L⁻¹) is shown by the broken line and arrow. The initial solution conditions were as follows:

[SCN⁻] 0.50 M (NaSCN)
[Co] 1.7 x 10⁻⁶ M
Buffer 0.10 M NaOOCCH₃/HOOCCH₃, pH 4.6
Ionic strength 0.60 M plus contributions from
added salts

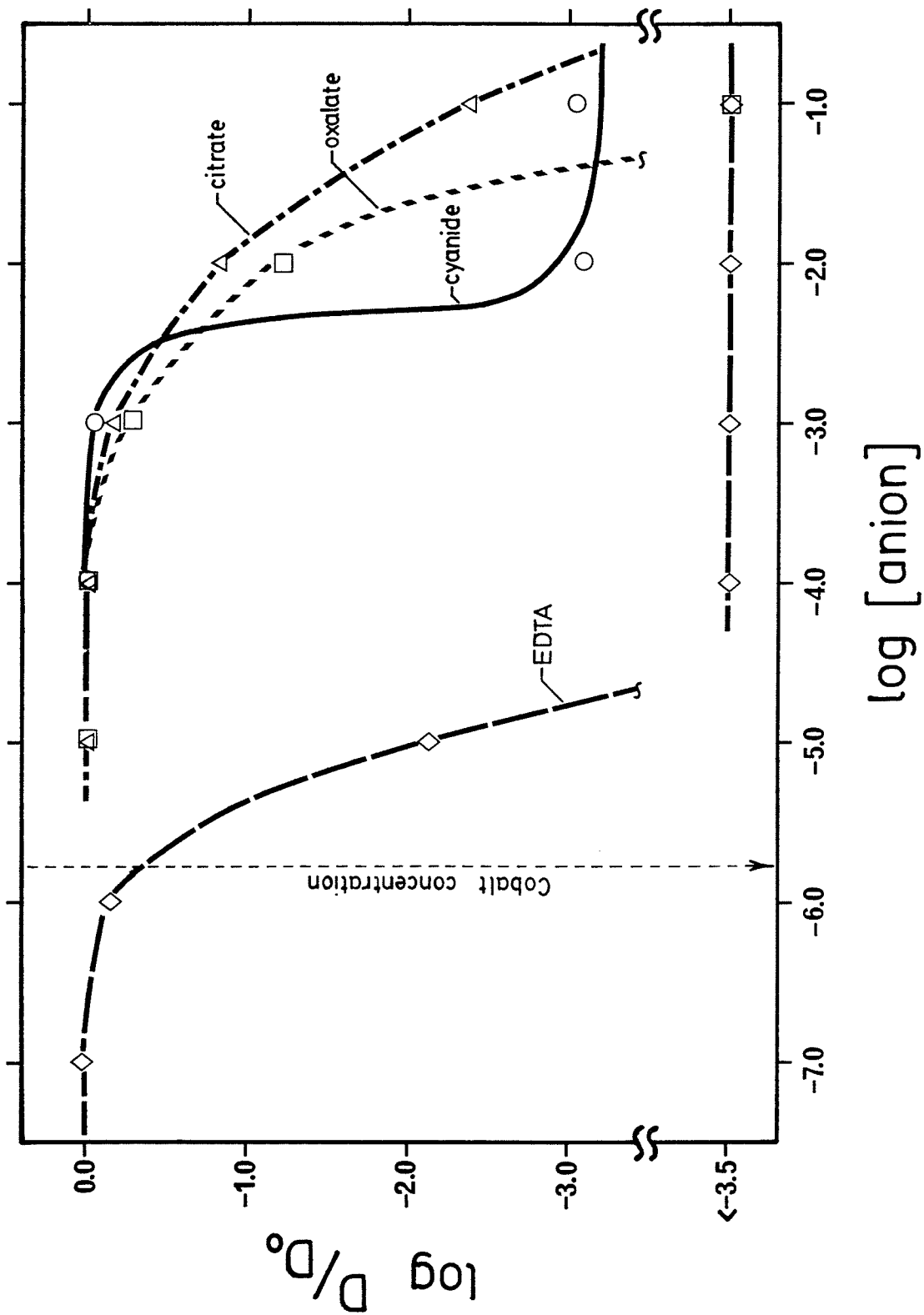

severe in its action (in spite of its reported greater formation constant) but nonetheless very strongly interfering. Both appear from Figure 2-25 to begin to bring about significant declines in cobalt sorption when they are each present at a molar ratio to cobalt of approximately 1000.

However, by far the most powerful interferent of cobalt sorption tested was ethylenediaminetetraacetic acid (EDTA) as its disodium salt, $\text{Na}_2\text{H}_2\text{Y}$. The anion is reported⁽²³⁰⁾ to have a 1:1 complex formation constant in the neighbourhood of 10^{16} with the metal. The extensive formation of this complex under the conditions of the experiment shows up both as large spectral changes and as a measurable interference in cobalt sorption beginning at concentrations which represent even less than a 1:1 molar ratio (see Figure 2-25). At higher molar ratios (100-fold or greater), EDTA suppresses cobalt sorption to the extent that it becomes unmeasurable (plotted, once more, as $\log D/D_0 < -3.5$ in Figure 2-25).

Thus, in summarizing the response of cobalt sorption to the addition of a range of sodium salts, we see a broad assortment of effects produced extending from mildly enhancing to strongly interfering. Most of the effects are explainable in terms of the modes of interaction anticipated at the beginning of this section (i.e. ionic strength increases, greater extractable cation availability, complexation of cobalt by the anion, chemical attack on SCN^- or polyurethane, or competitive sorption of the anionic salt). Before leaving the topic, however, we should briefly mention some further information regarding the last mode in this list - the sorption of anionic salts and competition of these for polyurethane foam sites. Although this has not been evaluated for

polyurethane itself, there are many similarities of circumstance to anion exchange for which, of course, many selectivity coefficients have been determined. In these cases, the order of extractability of anions depends upon the specific exchanger but is generally found⁽²³⁷⁾ to be approximately:

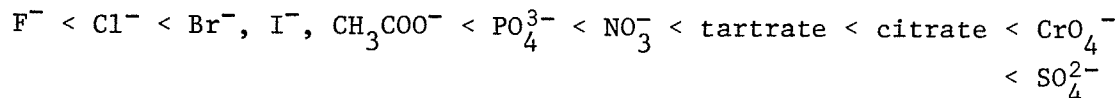

On the other hand, the selectivity order for liquid anion exchangers is said to be⁽²³⁸⁾:

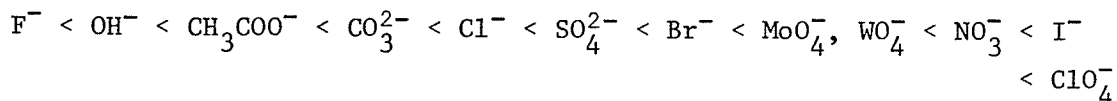

In some ways, these bear resemblances to many of the smaller interferences observed in this experiment where there are no other factors known to be at play. Thus, much as for anion exchangers, competitive sorption of anions may be the cause of certain of the interferences noted with polyurethanes as well.

Having thus discussed the effects of a number of anions, we will next consider the results of experiments with various added metal ions as well. Turning to Table II-21, we see quickly that a variety of effects ranging from strong depression to mild enhancement were observed in the presence of other metal ions. We will be dealing with these individually in their respective chemical groups.

As for the most strongly interfering anions, the interferences (D/Do) produced by a number of metal ions were evaluated at several dif-

TABLE II-21 - EFFECT OF VARIOUS METAL IONS ON COBALT ABSORPTION BY POLYURETHANE FOAM

Initial Conditions:

[SCN⁻] 0.50 M (NaSCN) Solution Volume (V) 150.0 mL
 [Co] 1.7 x 10⁻⁶ M (0.10ppm) Foam Weight (W) 0.050 grams
 Ionic Strength (I) 0.6 M plus contribution from metal salts added Type #1338 BFG
 pH 4.8 (0.1 M Na acetate buffer) Squeezing Time 24.0 hours
 Temperature 25.00°C

Metal	[Source]	Concentration (ppm)	Concentration (M)	Final pH ±0.01	Foam Weight (mg) ±0.01	Cobalt Extracted (%)	D (L kg ⁻¹)	D/Do*	Observations
none**	-	-	-	4.82	-	-	1.225 x 10 ⁴	1.000	-solution clear, colourless -foam turns blue-green
Be(II)	[BeSO ₄ ·4H ₂ O]	1001	1.11 x 10 ⁻¹	3.96	50.74	80.8 ±0.4	1.244 x 10 ⁴ ±0.027	0.993 ±0.029	-solution initially faint yellow and turbid -foam turns red, then blue
Mg(II)	[MgCl ₂ ·6H ₂ O]	1002	4.12 x 10 ⁻²	4.71	47.80	81.39 ±0.34	1.305 x 10 ⁴ ±0.025	1.022 ±0.025	-small amount of white precipitate -foam turns mauve, then blue
Ca(II)	[Ca(NO ₃) ₂ ·4H ₂ O]	1008	2.51 x 10 ⁻²	4.73	47.53	80.5 ±0.4	1.302 x 10 ⁴ ±0.030	1.039 ±0.031	
Sr(II)	[SrCl ₂ ·6H ₂ O]	1000	1.14 x 10 ⁻²	-	50.93	81.7 ±0.5	1.32 x 10 ⁴ ±0.04	1.05 ±0.04	
Ba(II)	[Ba(NO ₃) ₂]	997	7.26 x 10 ⁻³	4.75	52.26	82.0 ±0.5	1.30 x 10 ⁴ ±0.04	1.04 ±0.04	

TABLE II-21 -continued

Metal	[Source]	Concentration (ppm)	Concentration (M)	Final pH ± 0.01	Foam Weight (mg) ± 0.01	Cobalt Extracted (%) ± 0.5	D (L kg ⁻¹)	D/Do [*]	Observations
Sc(III)	[Sc(NO ₃) ₃]	100	2.22×10^{-3}	4.81	50.03	80.6 ± 0.5	1.248×10^4 ± 0.030	1.089 ± 0.032	
La(III)	[LaCl ₃ ·6H ₂ O]	1002	7.21×10^{-3}	4.78	50.07	80.9 ± 0.5	1.27×10^4 ± 0.04	1.11 ± 0.04	
Ti(III)	[TiCl ₃]	1002	2.09×10^{-2}	3.77	50.58	83.0 ± 0.5	1.45×10^4 ± 0.05	1.16 ± 0.04	-solution turns intense blue- black then white, blue and brown precipitates
Ti(IV)	[Ti(SO ₄) ₂ ·9H ₂ O]	<999	$<2.09 \times 10^{-2}$	3.82	50.04	80.0 ± 0.5	1.202×10^4 ± 0.029	0.959 ± 0.030	-white precipitate formed, pale pink solution -foam initially red, then olive
Zr(IV)	[ZrOCl ₂ ·xH ₂ O]	<100	$<2.08 \times 10^{-3}$	4.77	50.47	80.8 ± 0.5	1.255×10^4 ± 0.030	0.983 ± 0.028	-some white precipitate
V(V)	[V ₂ O ₅]	<<1000	$<<1.96 \times 10^{-2}$	4.72	49.68	81.1 ± 0.4	1.307×10^4 ± 0.031	1.023 ± 0.029	-solution initially red- brown then quickly changes to yellow -foam becomes mauve
		<100	$<1.96 \times 10^{-3}$	4.81	50.81	79.54 ± 0.34	1.148×10^4 ± 0.020	1.002 ± 0.025	-will not all dissolve -solution yellow, cloudy -will not all dissolve -solution yellow

TABLE II-21 -continued

Metal [Source]	Concentration (ppm)	Concentration (M)	Final pH ± 0.01	Foam Weight (mg) ± 0.01	Cobalt Extracted (%)	D (L kg ⁻¹)	D/Do*	Observations
V(V) [NH ₄ VO ₃]	1000	1.96 x 10 ⁻²	4.85	50.06	82.4 ± 0.6	1.38 x 10 ⁴ ± 0.05	1.20 ± 0.05	-solution dark orange-yellow
Cr(III) [CrCl ₃ ·6H ₂ O]	1000	1.92 x 10 ⁻²	4.59	50.74	9.2 ± 0.7	2.64 x 10 ² ± 0.20	0.0230 ± 0.0018	-solution green first but turns steel blue very slowly -foam turns steel blue
	100	1.91 x 10 ⁻³	4.78	50.89	41.8 ± 0.6	2.12 x 10 ³ ± 0.04	0.169 ± 0.004	-solution green first but turns steel blue very slowly -cobalt desorbs slowly from foam
	9.33	1.79 x 10 ⁻⁴	4.80	50.06	76.9 ± 0.4	9.98 x 10 ³ ± 0.17	0.796 ± 0.021	-cobalt desorbs slowly from foam
	1.03	1.98 x 10 ⁻⁵	4.80	49.81	79.3 ± 0.6	1.155 x 10 ⁴ ± 0.033	1.008 ± 0.034	
Cr(VI) [Na ₂ CrO ₄]	52000	1.00 x 10 ⁰	8.01	50.80	53.48 ± 0.32	3.394 x 10 ³ ± 0.031	0.296 ± 0.006	-solution turns orange -sorption slightly slow
	5200	1.00 x 10 ⁻¹	5.9	50.52	82.3 ± 0.6	1.38 x 10 ⁴ ± 0.05	1.10 ± 0.04	-solution turns orange
Mo(VI) [MoO ₃]	996	1.04 x 10 ⁻²	4.74	49.00	80.9 ± 0.4	1.300 x 10 ⁴ ± 0.027	1.134 ± 0.031	
	102	1.06 x 10 ⁻³	4.74	50.78	80.9 ± 0.6	1.25 x 10 ⁴ ± 0.04	1.00 ± 0.04	

TABLE II-21 --continued

Metal	[Source]	Concentration (ppm)	Concentration (M)	Final pH ± 0.01	Foam Weight (mg) ± 0.01	Cobalt Extracted (%)	D (L kg ⁻¹)	D/Do*	Observations
Mo(VI)	[Na ₂ MoO ₄ · 2H ₂ O]	1003	1.05 x 10 ⁻²	4.87	50.56	81.60 ± 0.25	1.316 x 10 ⁴ ± 0.018	1.148 ± 0.026	
W(VI)	[Na ₂ WO ₄ · 2H ₂ O]	1000	5.44 x 10 ⁻³	4.86	46.95	53.3 ± 0.7	4.47 x 10 ³ ± 0.10	0.390 ± 0.011	-Cobalt desorbs very slowly after sorption
		100	5.42 x 10 ⁻⁴	4.90	50.59	67.9 ± 0.5	6.28 x 10 ³ ± 0.11	0.548 ± 0.013	-Cobalt desorbs very slowly after sorption
		9.98	5.43 x 10 ⁻⁵	4.85	51.10	79.5 ± 0.5	1.139 x 10 ⁴ ± 0.026	0.994 ± 0.029	
		1.00	5.44 x 10 ⁻⁶	4.79	49.39	80.5 ± 0.5	1.26 x 10 ⁴ ± 0.04	0.983 ± 0.031	
Mn(II)	[MnCl ₂ · 4H ₂ O]	1002	1.82 x 10 ⁻²	4.73	50.40	81.3 ± 0.6	1.30 x 10 ⁴ ± 0.04	1.03 ± 0.04	
Fe(II)	[Fe(NH ₄) ₂ (SO ₄) ₂ · 6H ₂ O]	1000	1.79 x 10 ⁻²	4.80	48.98	53.1 ± 0.4	3.46 x 10 ³ ± 0.04	0.276 ± 0.006	-solution initially pale yellow and becomes orange on standing -foam turns rust red
		100	1.80 x 10 ⁻³	4.79	48.71	80.8 ± 0.5	1.30 x 10 ⁴ ± 0.04	1.03 ± 0.04	-slightly yellow solution, slowly darkens -foam turns red-brown
Fe(III)	[FeCl ₃ · 6H ₂ O]	999	1.79 x 10 ⁻²	4.44	50.34	58.5 ± 0.4	4.20 x 10 ³ ± 0.05	0.335 ± 0.008	-solution deep red with brown precipitate after standing -foam turns very dark brown

TABLE II-21 -continued

Metal [Source]	Concentration (ppm)	Concentration (M)	Final pH ± 0.01	Foam Weight (mg) ± 0.01	Cobalt Extracted (%)	D (L kg ⁻¹)	D/Do*	Observations
	101	1.82×10^{-3}	4.78	49.99	78.7 ± 0.8	1.11 ± 0.04	10^4 0.88 ± 0.04	-tea-colored solution with some precipitate -foam turns dark brown
	9.90	1.77×10^{-4}	4.81	50.00	80.6 ± 0.5	1.25 ± 0.04	10^4 0.997 ± 0.034	-solution red-brown with some precipitate -foam turns red-brown
Ru(IV) [K ₂ RuCl ₆]	101	9.96×10^{-4}	4.76	50.93	80.1 ± 0.8	1.19 ± 0.05	10^4 0.95 ± 0.04	-solution steel blue and fine black precipitate formed -foam turns black
	10.0	9.88×10^{-5}	4.78	52.15	81.5 ± 0.5	1.264 ± 0.032	10^4 1.009 ± 0.032	-solution mauve with some fine black precipitate -foam turns black
Os (IV) [(NH ₄) ₂ OsCl ₆]	1001	5.26×10^{-3}	4.70	50.38	81.6 ± 0.5	1.32 ± 0.04	10^4 1.05 ± 0.04	-orange-red solution
Rh(III) [Na ₃ RhCl ₆ ·18H ₂ O]	1000	9.72×10^{-3}	4.74	49.11	76.5 ± 0.7	9.93 ± 0.30	10^3 0.793 ± 0.029	-solution slowly changes from cherry red to orange on standing
	98.1	9.53×10^{-4}	4.80	50.33	80.6 ± 1.0	1.24 ± 0.07	10^4 0.99 ± 0.06	-solution initially pale orange, darkens on standing
	9.59	9.32×10^{-5}	4.80	50.78	81.0 ± 0.6	1.26 ± 0.04	10^4 0.99 ± 0.04	-solution initially pink, changes to orange-yellow on standing

TABLE II-21 -continued

Metal	[Source]	Concentration (ppm)	Concentration (M)	Final pH ± 0.01	Foam Weight (mg) ± 0.01	Cobalt Extracted (%) ± 0.5	D (L kg ⁻¹) ± 0.04	D/Do*	Observations
Ir(III)	[Na ₃ IrCl ₆ · 12H ₂ O]	1001	5.21 x 10 ⁻³	4.80	49.67	81.8 ± 0.5	1.36 x 10 ⁴	1.08 ± 0.04	-solution initially pale brown then fades quickly to yellow-green -foam turns tan then blue-green
Ir(IV)	[(NH ₄) ₂ IrCl ₆]	1007	5.24 x 10 ⁻³	4.72	50.75	81.6 ± 0.4	1.310 x 10 ⁴	1.045 ± 0.031	-solution turns quickly from brown-red to yellow-green
Ni(II)	[NiCl ₂ · 6H ₂ O]	999	1.70 x 10 ⁻²	4.81	50.37	81.9 ± 0.5	1.34 x 10 ⁴	1.07 ± 0.04	-solution green
		105	1.78 x 10 ⁻³	4.80	51.19	81.6 ± 0.7	1.30 x 10 ⁴	1.04 ± 0.04	-solution faint green
Pd(II)	[PdCl ₂]	1000	9.40 x 10 ⁻³	4.77	50.64	5.3 ± 0.8	1.65 x 10 ²	0.0131 ± 0.0020	-solution cherry red -foam turns red
		101	9.52 x 10 ⁻⁴	4.81	49.09	36.4 ± 0.4	1.748 x 10 ³	0.1395 ± 0.0032	-solution bright orange -foam turns orange
		10.4	9.74 x 10 ⁻⁵	4.82	49.23	80.2 ± 0.6	1.24 x 10 ⁴	0.99 ± 0.04	-solution yellow -foam turns orange-yellow
		1.04	9.77 x 10 ⁻⁶	4.84	50.05	81.1 ± 0.5	1.289 x 10 ⁴	1.009 ± 0.031	-solution very pale yellow -foam turns yellow-green
Pt(II)	[K ₂ PtCl ₄]	1003	5.14 x 10 ⁻³	4.80	50.04	6.6 ± 0.5	2.10 x 10 ²	0.0168 ± 0.0014	-solution dark yellow -foam turns yellow

TABLE II-21 -continued

Metal	[Source]	Concentration (ppm)	Concentration (M)	Final pH ± 0.01	Foam Weight (mg) ± 0.01	Cobalt Extracted (%)	D (L kg ⁻¹)	D/Do*	Observations
Pt(IV)	[Na ₂ PtCl ₆ ·6H ₂ O]	100	5.14 x 10 ⁻⁴	4.80	49.66	43.1 ± 0.5	2.286 x 10 ³ ± 0.034	0.200 ± 0.005	-solution yellow -foam turns yellow
		10.0	5.15 x 10 ⁻⁵	4.82	47.78	81.3 ± 0.4	1.367 x 10 ⁴ ± 0.029	1.070 ± 0.028	-solution faint yellow -foam yellow-green
		9.98	5.12 x 10 ⁻⁵	4.80	49.81	80.2 ± 0.4	1.220 x 10 ⁴ ± 0.028	1.065 ± 0.031	-solution faintly yellow -foam turns green
Cu(II)	[CuCl ₂ ·2H ₂ O]	100	1.58 x 10 ⁻³	4.79	50.63	79.9 ± 0.5	1.176 x 10 ⁴ ± 0.031	0.938 ± 0.031	-solution pale yellow with white precipitate -foam turns brown then mauve
		9.86	1.55 x 10 ⁻⁴	4.82	50.21	78.9 ± 0.5	1.117 x 10 ⁴ ± 0.027	0.975 ± 0.029	-solution pale yellow -foam turns green
		0.99	1.56 x 10 ⁻⁵	4.84	49.27	80.3 ± 0.5	1.238 x 10 ⁴ ± 0.031	0.969 ± 0.029	-very pale yellow solution -foam turns grey then blue-green
Pt(IV)	[Na ₂ PtCl ₆ ·6H ₂ O]	1002	5.13 x 10 ⁻³	4.75	48.72	0.8 ± 0.5	2.5 ± 1.5 x 10 ¹	0.0020 ± 0.0012	-solution orange -foam turns orange
		99.6	5.11 x 10 ⁻⁴	4.79	50.28	39.1 ± 0.7	1.92 x 10 ³ ± 0.04	0.153 ± 0.004	-solution yellow -foam turns apricot
		9.08	4.65 x 10 ⁻⁵	4.76	49.82	81.0 ± 0.4	1.283 x 10 ⁴ ± 0.028	1.024 ± 0.030	
Cu(II)	[CuCl ₂ ·2H ₂ O]	<<1001	<<1.58 x 10 ⁻²	4.66	49.33	69.6 ± 0.5	6.98 x 10 ³ ± 0.12	0.609 ± 0.015	-solution turns yellow, then green, then brown -white precipitate forms leaving pale yellow solution

TABLE II-21 -continued

Metal [Source]	Concentration (ppm)	Concentration (M)	Final pH ± 0.01	Foam Weight (mg) ± 0.01	Cobalt Extracted (%)	D (L kg ⁻¹)	D/Do*	Observations
Au(III) [HAuCl ₄ · 3H ₂ O]	1004	5.10 x 10 ⁻³	4.59	49.51	6.4 ± 0.7	2.07 ± 0.22 x 10 ²	0.0165 ± 0.0018	-initial yellow Au(III) colour disappears quickly from solution - gold coloured precipitate forms -foam remains white
	103	5.24 x 10 ⁻⁴	4.79	48.77	58.2 ± 0.4	4.28 ± 0.05 x 10 ³	0.342 ± 0.008	-yellow Au(III) colour disappears from solution -foam turns green
	9.90	5.03 x 10 ⁻⁵	4.78	50.33	80.4 ± 0.5	1.23 ± 0.04 x 10 ⁴	0.978 ± 0.034	-yellow Au(III) colour disappears from solution -foam turns green then blue- green
Zn(II) [ZnCl ₂]	1.10	5.58 x 10 ⁻⁶	4.85	50.12	80.3 ± 0.4	1.219 ± 0.027 x 10 ⁴	0.955 ± 0.026	
	103	1.58 x 10 ⁻³	4.81	51.16	0.00 ± 0.31	0 ± 9 x 10 ⁰	0.0000 ± 0.0007	-foam remains white
	10.0	1.54 x 10 ⁻⁴	4.82	49.73	21.2 ± 0.4	8.12 ± 0.16 x 10 ²	0.0648 ± 0.0018	-foam turns from yellow to very pale green
Cd(II) [CdCl ₂ · 2 $\frac{1}{2}$ H ₂ O]	1.00	1.54 x 10 ⁻⁵	4.83	48.57	82.7 ± 0.6	1.48 ± 0.05 x 10 ⁴	1.18 ± 0.05	-foam turns blue-grey then blue-green
	1002	8.92 x 10 ⁻³	4.74	51.31	73.0 ± 0.4	7.89 ± 0.12 x 10 ³	0.629 ± 0.015	
	102	9.10 x 10 ⁻⁴	4.81	52.26	82.4 ± 0.7	1.35 ± 0.06 x 10 ⁴	1.07 ± 0.05	

TABLE II-21 -continued

Metal	Concentration	Final pH	Foam Weight	Cobalt	D	D/Do*	Observations
[Source]	(ppm)	(M)	(mg)	Extracted (%)	(L kg ⁻¹)		
			±0.01				
Hg(II)							
[HgCl ₂] J	1002	4.99 x 10 ⁻³	48.31	29.6 ±0.6	1.305 x 10 ³ ±0.028	0.1139 ±0.0032	-foam turns faint green
	121	6.02 x 10 ⁻⁴	51.45	73.8 ±0.6	8.21 x 10 ³ ±0.20	0.655 ±0.020	-foam turns pale green then green
	9.37	4.67 x 10 ⁻⁵	50.13	81.3 ±0.6	1.30 x 10 ⁴ ±0.04	1.04 ±0.04	
Al(III)							
[Al(NO ₃) ₃ ·9H ₂ O] J	1000	3.70 x 10 ⁻²	49.20	81.4 ±0.6	1.33 x 10 ⁴ ±0.04	1.06 ±0.04	-foam turns pink then green
Ga(III)							
[Ga(NO ₃) ₃ ·9H ₂ O] J	1001	1.44 x 10 ⁻²	50.70	80.8 ±0.6	1.25 x 10 ⁴ ±0.04	0.98 ±0.04	-white precipitate forms while squeezing with foam -foam turns grey-blue then blue-green
	99.7	1.43 x 10 ⁻³	49.93	81.1 ±0.5	1.29 x 10 ⁴ ±0.04	1.012 ±0.033	
In(III)							
[InCl ₃] J	1010	8.80 x 10 ⁻³	49.78	5.6 ±0.6	1.78 x 10 ² ±0.18	0.0140 ±0.0014	-foam remains white
	101	8.79 x 10 ⁻⁴	50.30	49.0 ±0.7	2.86 x 10 ³ ±0.05	0.224 ±0.006	-foam turns pale blue-green
	9.96	8.67 x 10 ⁻⁵	50.47	79.4 ±0.5	1.148 x 10 ⁴ ±0.031	0.899 ±0.028	
	1.33	1.16 x 10 ⁻⁵	50.74	81.2 ±0.6	1.28 x 10 ⁴ ±0.04	1.000 ±0.034	

TABLE II-21 -continued

Metal	[Source]	Concentration (ppm)	Concentration (M)	Final pH ± 0.01	Foam Weight (mg) ± 0.01	Cobalt Extracted (%)	D (L kg ⁻¹)	D/Do*	Observations
Tl(I)	[TlCl ₃]	<<1002	<<4.90 x 10 ⁻³	4.80	50.39	83.0 ± 0.5	1.46 ± 0.04 x 10 ⁴	1.14 ± 0.04	-will not all dissolve
		< 99.9	<4.89 x 10 ⁻⁴	4.85	48.57	80.9 ± 0.4	1.308 ± 0.029 x 10 ⁴	1.024 ± 0.028	-will not all dissolve
Sn(II)	[SnCl ₂ ·2H ₂ O]	<<1001	<<8.44 x 10 ⁻³	4.69	48.72	78.7 ± 0.5	1.136 ± 0.028 x 10 ⁴	0.991 ± 0.030	-white precipitate forms on standing -foam turns green
Sn(IV)	[SnCl ₄ ·5H ₂ O]	<1002	<8.44 x 10 ⁻³	4.51	49.87	13 ± 18	4 ± 6 x 10 ²	0.04 ± 0.05	-small amount of gelatinous white precipitate forms on standing and contains about 90% of the ⁶⁰ Co -sorption slow, foam turns yellow
Pb(II)	[PbCl ₂]	<1001	<4.83 x 10 ⁻³	4.78	50.16	82.0 ± 0.5	1.36 ± 0.04 x 10 ⁴	1.09 ± 0.04	-will not all dissolve
		99.3	4.79 x 10 ⁻⁴	4.76	49.94	81.4 ± 0.5	1.31 ± 0.04 x 10 ⁴	1.05 ± 0.04	
Sb(III)	[SbCl ₃]	<<1000	<<8.21 x 10 ⁻³	4.61	48.09	79.3 ± 0.6	1.193 ± 0.033 x 10 ⁴	0.952 ± 0.032	-will not all dissolve
Bi(III)	[BiCl ₃]	<<1002	<<4.80 x 10 ⁻³	4.74	50.20	80.8 ± 0.5	1.26 ± 0.04 x 10 ⁴	1.005 ± 0.034	-will not all dissolve -foam turns faint pink, then green

TABLE II-21 -continued

Metal [Source]	Concentration (ppm)	Concentration (M)	Final pH ±0.01	Foam Weight (mg) ±0.01	Cobalt Extracted (%) ±0.8	D (L kg ⁻¹) ±0.05	D/Do* ±0.05	Observations
U(VI) [UO ₂ (CH ₃ COO) ₂ · 2H ₂ O]	1000	4.20 x 10 ⁻³	4.82	50.64	80.6	1.23 x 10 ⁴	1.07	-solution yellow -foam turns green

* It was necessary to prepare three separate batches of stock NaSCN/NaOCCCH₃/HOCCOH₃/CoCl₂ solution to complete all of the experiments. The value of Do used in each case is the average of three separate measurements of distribution ratio made in the absence of any interferent using the appropriate batch of stock solution.

** Average of all blank experiments conducted with all three batches of stock solution. Except where noted otherwise, the observations for other experiments are identical to those shown here for no interferent present.

Figure 2-26

Interference/concentration profiles for several interfering metal ions in the sorption of cobalt by 50 mg pieces of #1338 BFG polyurethane foam from 150.0 mL of solution. Equilibration was carried out for a period of 24.0 hours at 25.00°C. The metal ion concentrations are given in mol L⁻¹ (lower scale) as well as the molar ratio to the initial cobalt concentration (upper scale). Interference is measured by the ratio of the cobalt distribution ratio in the presence (D) and in the absence (Do) of the added metal ion. Data for Co(II) itself come from another experiment with slightly different conditions (see text) but are presented here for rough comparison. All values of log (D/Do) which were less than -3.5 are plotted at "< -3.5". The initial solution conditions were as follows:

[SCN⁻] 0.50 M (NaSCN)
[Co] 1.7 x 10⁻⁶ M
Buffer 0.10 M NaOOCCH₃/HOOCCH₃, pH 4.6
Ionic strength 0.60 M plus contributions from
added metal salts

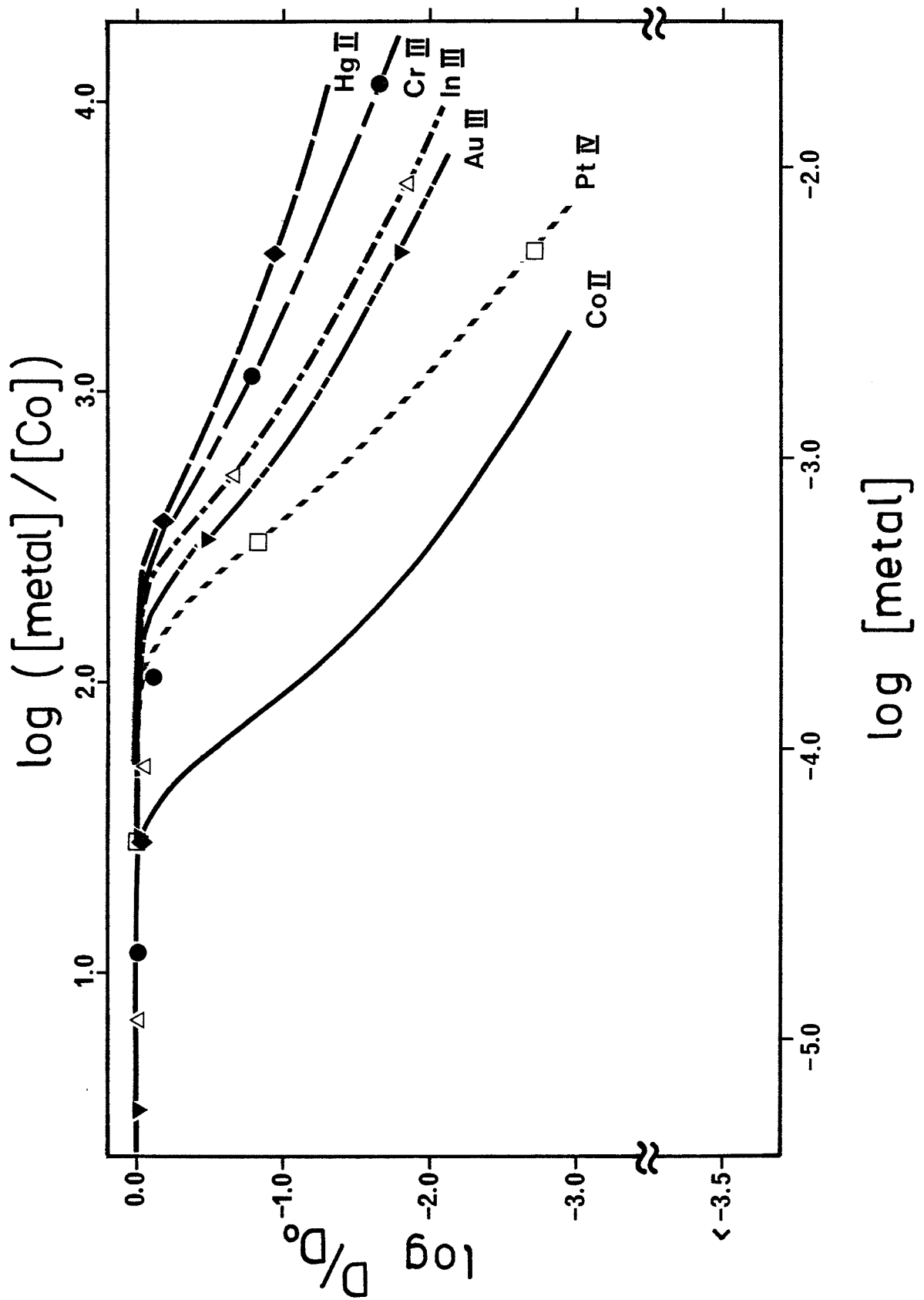
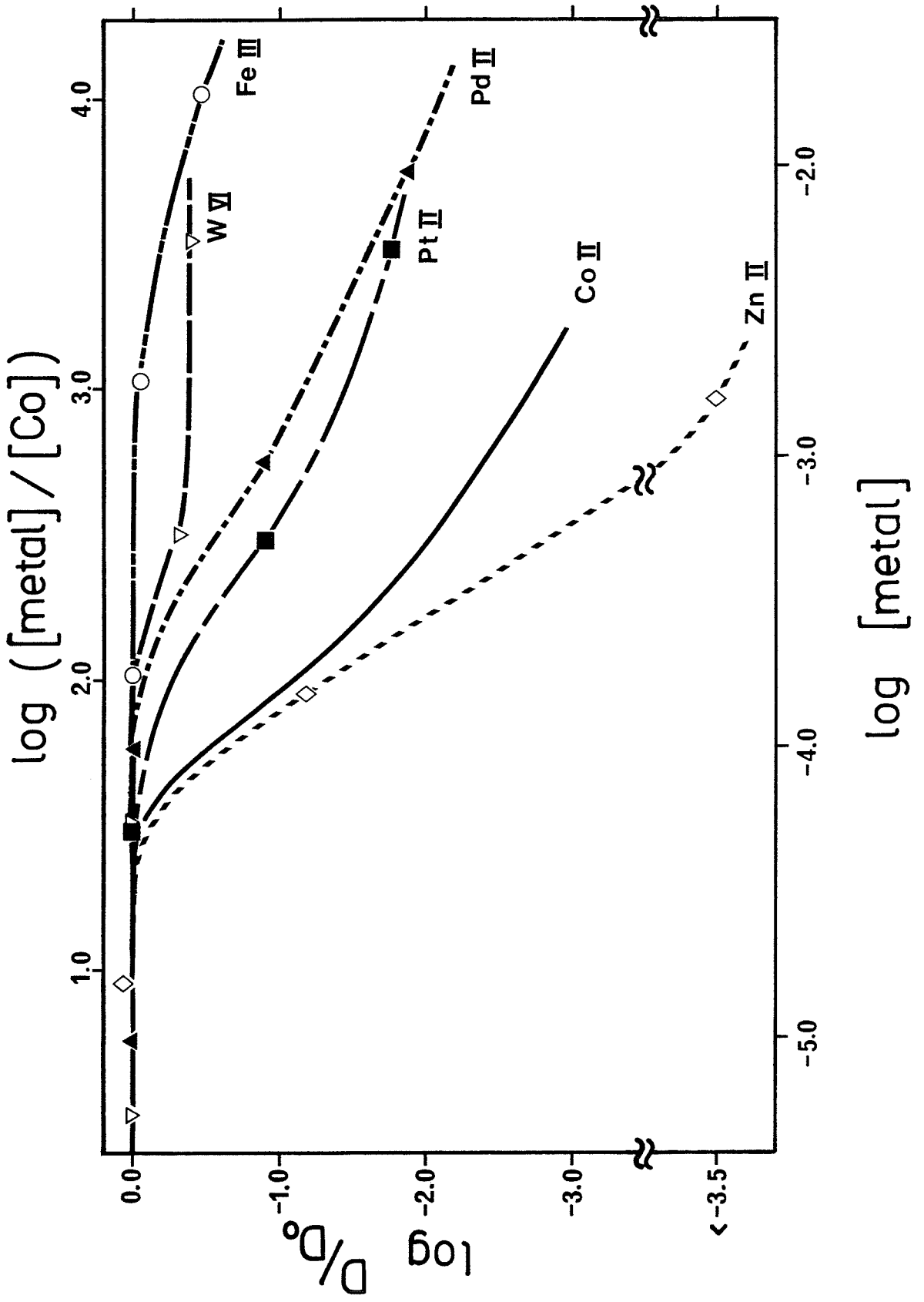

Figure 2-27

Interference/concentration profiles for several interfering metal ions in the sorption of cobalt by 50 mg pieces of #1338 BFG polyurethane foam from 150.0 mL of solution. Equilibration was carried out for a period of 24.0 hours at 25.00°C. The metal ion concentrations are given in mol L⁻¹ (lower scale) as well as the molar ratio to the initial cobalt concentration (upper scale). Interference is measured by the ratio of the cobalt distribution ratio in the presence (D) and in the absence (Do) of the added metal ion. Data for Co(II) itself come from another experiment with slightly different conditions (see text) but are presented here for rough comparison. All values of log (D/Do) which were less than -3.5 are plotted at "< -3.5". The initial solution conditions were as follows:

[SCN⁻] 0.50 M (NaSCN)
[Co] 1.7 x 10⁻⁶ M
Buffer 0.10 M NaOOCCH₃/HOOCCH₃, pH 4.6
Ionic strength 0.60 M plus contributions from
added metal salts



ferent concentrations. These have been plotted as a function of metal ion concentration in Figures 2-26 and 2-27 to allow easy visual comparison of effects to be made. Included in these Figures for reference purposes are also sorption profiles calculated for Co(II) itself based on data obtained earlier in the studies of the effect of cobalt concentration on sorption (Table II-10 and Figure 2-14). In making the calculations for these Figures, 1.7×10^{-6} M Co(II) was regarded as the sorbing metal while the remainder of the cobalt was considered to be added as interferent. Although the conditions in that experiment were not identical to this one (in particular, the ionic strength was much higher at 3.00 M and a 1.0 M buffer was employed) the comparison is nonetheless semi-quantitatively useful.

Beginning first, then with the Group IIa metals, we see that nearly all of the alkaline earth salts investigated (i.e. Mg(II), Ca(II), Sr(II), Ba(II) as either nitrates or chlorides) produce small but statistically significant increases in cobalt sorption at the level of 1000 ppm. As indicated by the lack of observations recorded in Table II-21 for these metals, no visible differences in either solution or extraction behaviour were noted in their presence. Much as for the addition of NaCl, then, such an effect must arise either by increased cation availability (if the cation is solvatable by polyurethane) or simply by raising the solution ionic strength rather than by more complicated means. On the other hand, the smallest member of the group, Be(II) (as its sulfate) produces no such enhancement and so might be supposed either to be unsuitable as an extractable counter ion for $\text{Co}(\text{SCN})_4^{2-}$ or to interfere by formation of its own extractable complex. Both of these possibilities

may be true to some extent but probably the larger effect would be interference due to the known^(198,230,239) unique behaviour of Be(II) among the alkaline earths to form a thiocyanate complex which is extractable into oxygen-containing organic solvents. This interpretation is consistent with the observed development of a red colour (presumably $\text{Be}(\text{SCN})_4^{2-}$ or a similar species) on foam prior to being displaced or obscured by the familiar blue-green $\text{Co}(\text{SCN})_4^{2-}$. Small amounts of precipitate also observed in solution are likely attributable to the accompanying sulfate anions rather than to the metal itself.

Of the Group IIIa metals, only Sc(III) and La(III) (as nitrate and chloride, respectively) were tested and both were found to produce small enhancements of cobalt sorption without any significant difference in appearance as for most of the Group IIa elements just discussed. This happens in spite of the fact that both of these metals are reported⁽¹⁹⁸⁾ to be extractable as thiocyanates from solutions of relatively high SCN^- concentration. Apparently, the conditions in this experiment were not suitable for such extraction or the complexes are so weakly held as to be unable to displace the cobalt species.

Several Group IVa metals demonstrated very interesting solution chemistry when tested for interference. For example, Ti(III) (as TiCl_3), while producing mild enhancement of cobalt sorption, also spawned a multitude of colour changes in solution prior to contact with foam. The peculiar colour changes observed likely reflect the initial formation of some mixed titanium-chloride-thiocyanate species (the black colour) which probably then undergoes hydrolysis to produce hydrated oxides, hydroxides, sulfides, etc. (the white, blue and brown precipitates).

The formation of some hydrolysis products is evidenced by a sizeable decrease in solution pH (see Table II-21) accompanying the addition of Ti(III) to solution. Ti(IV) (as the sulfate) again produced some white precipitate probably arising partly out of the use of the sulfate salt and resulted in a slight depression of cobalt sorption. As for Ti(III), a decrease in solution pH was recorded along with the addition of Ti(IV) so that hydrolysis of the original $\text{Ti}(\text{SO}_4)_2 \cdot 9\text{H}_2\text{O}$ must also have occurred. The usual products of such hydrolysis are said⁽²⁰⁰⁾ to be basic oxo salts or hydrated oxides (such as $\text{TiO}_2 \cdot x\text{H}_2\text{O}$). Likely due, in part, to this hydrolysis and precipitation, it was not possible to dissolve Ti(IV) completely to either 1000 ppm or 100 ppm concentration. Others⁽²³⁰⁾ have reported the occurrence of several Ti(IV) thiocyanate species (such as $\text{Ti}(\text{OH})(\text{SCN})^{2+}$ and even $\text{Ti}(\text{SCN})_4$ in methyl isobutyl ketone) but not with exceptionally large formation constants. The existence of these complexes and their slight extraction by polyurethane must likely be the reason for the olive colour on foam at equilibrium and the small depression of cobalt sorption. A red colour noted to be extracted after only brief equilibration of foam and solution may be due to some titanium-thiocyanate complex although some of it could easily be caused by iron (which would not be an unlikely contaminant).

Like Ti(IV), Zr(IV) (as $\text{ZrOCl}_2 \cdot x\text{H}_2\text{O}$) shows peculiar solution and foam colour changes but nevertheless results only in slight enhancement of cobalt sorption rather than depression. Judging from the initial development of a red colour in solution which quickly becomes yellow, it seems likely that the ZrOCl_2 species (which is relatively stable toward hydrolysis by water) is first transformed into a red thiocyanate complex

which then passes into some other form. The existence of species such as $ZrO(SCN)_3H_2O^-$, $Zr(SCN)_6^{2-}$ or $ZrOOH^+SCN^-$ have all been suggested by others⁽²³⁰⁾ although we have no way of knowing whether or not any of these are the observed complexes. Apparently, based on the mauve colour reached by foam at equilibrium, some complex (which may or may not be Zr-containing) must also be extracted but is evidently so weakly held that it causes no interference.

In the Group Va metals, only vanadium (V) (initially as V_2O_5) was tested for its possible interference effects. Although it was not found possible to dissolve the V_2O_5 completely at either 1000 ppm or 100 ppm levels, it was observed to interfere significantly in this form. Vanadium (V) is not known⁽¹⁹⁸⁾ to be directly extractable as a thiocyanate complex, nevertheless it is slowly reduced to V(IV) in acidic solutions and is somewhat extractable in this form. Since the acidity was quite low in the experiment, it is not known if this may have actually occurred. However, V(V) in the alternate form of NH_4VO_3 , although much more soluble, produced an enhancing effect instead. Part of this enhancement may likely be caused by the NH_4^+ ion present (as we shall see later) but evidently this form is unlike V_2O_5 in its behaviour.

Considering next Group VIa (Cr, Mo, W) we find that definite differences exist in their individual interference characteristics toward cobalt. Chromium (III), for example (as $CrCl_3 \cdot 6H_2O$) shows quite strong interference ($D/Do = 0.0230$ at 1000 ppm concentration) and its interference/concentration profile is shown in Figure 2-26. From the observations made during the extraction and from the spectrophotometric study (Table II-23), it is evident that some steel-blue complex of Cr(III) forms in

the presence of SCN^- but at a very slow rate (at least under the conditions tested) and is extracted onto foam. In fact, it seems that sitting overnight at room temperature may not have been sufficient to reach equilibrium. Apparently, more of the chromium-thiocyanate complex was produced and then slowly displaced further cobalt from foam during the 24 hour squeezing period which followed. All of these observations are consistent with the conclusions of others⁽¹⁹⁸⁾ regarding the extractability of the chromium(III)-thiocyanate complex. On the other hand, as we have already discussed when considering the effects of various anions on extraction, chromium (VI) (in the form of Na_2CrO_4) produces some interference by virtue of its oxidizing power at very high concentrations (1.0 M = 52000 ppm) but not at more moderate levels (0.10 M = 5200 ppm). Thus, Cr(VI) appears not to interfere significantly with cobalt sorption.

Similarly, Mo(VI) (either as MoO_3 or as $\text{Na}_2\text{MoO}_4 \cdot 2\text{H}_2\text{O}$) displayed only slight enhancements of cobalt sorption rather than any depressive effects. By contrast, W(VI) (as $\text{Na}_2\text{WO}_4 \cdot 2\text{H}_2\text{O}$) interfered measurably at both the 1000 ppm and 100 ppm levels and its interference profile is shown in Figure 2-27. Like Cr(III), the phenomenon of slow displacement of some initially extracted cobalt from foam was observed to occur and may thus indicate less than rapid formation of an extractable thiocyanate complex as well. Interestingly enough, both Mo(VI) and W(VI) have been reported⁽¹⁹⁸⁾ to form extractable thiocyanate complexes although we observe significant interference with cobalt sorption only in the case of W(VI). This will likely reflect differences in the relative degrees of formation or extractabilities of the two complexes under the prevailing conditions.

Of the Group VIIa metals, only Mn(II) was tested for interference and found to be without effect. However, all of the metals of Group VIII (Fe, Co, Ni and the platinum metals) were investigated and found to differ considerably in their effects.

Beginning first with iron, we see from Table II-21 that either Fe(II) (as $\text{Fe}(\text{NH}_4)_2(\text{SO}_4)_2 \cdot 6\text{H}_2\text{O}$) or Fe(III) (as $\text{FeCl}_3 \cdot 6\text{H}_2\text{O}$) interferes moderately with cobalt sorption at the 1000 ppm level but that only Fe(III) persists as a problem at 100 ppm concentration. A spectrophotometric study indicated only that large new absorptions are formed with the addition of Fe(III) which obscure the spectra of cobalt species so it is impossible to distinguish between competition in solution for SCN^- or on foam for sites. However, the observed colours developed by foam suggest that the latter possibility is much more likely. The interference/concentration profile for Fe(III) is shown in Figure 2-27 and demonstrates comparatively low interference of cobalt sorption in relation to many other metals. This is, of course, as we have noted from many observations made during several of the previous experimental sections where iron was unavoidably present as a contaminant. The formation and extractability into various solvents of Fe(III) thiocyanate complexes for both photometric and separation purposes has been known at least since the nineteenth century but the exact form of the extractable species appears to depend strongly on the solvent and solution conditions. The formation of Fe(II) thiocyanate complexes is not as well established but from the information available⁽²³⁰⁾ they seem to be of generally lower stability. This being the case, it seems peculiar that Fe(II) interferes with cobalt sorption more strongly than does Fe(III) at 1000 ppm concen-

tration. From the observations in Table II-21, it seems that some iron initially present as Fe(II) is slowly oxidized in solution (presumably by air) and is extracted as the rust-red thiocyanate complex. Judging from the precipitates formed in Fe(III) solutions, some hydrolysis to oxides and hydroxides of iron also occurs.

Ruthenium(IV) and osmium(IV), both congeners of iron, were also tested as the K_2RuCl_6 and $(NH_4)_2OsCl_6$ complex salts. Osmium(IV) produced no measurable interference with cobalt extraction under the conditions studied but Ru(IV) appears to do so slightly ($D/Do = 0.95$ at 100 ppm concentration). Both metals are known⁽¹⁹⁸⁾ to yield thiocyanate complexes which are extractable into various organic solvents under specific conditions. Since a dark blue colour was observed to be produced with ruthenium, apparently some amount of a Ru(III) complex (perhaps $RuO(SCN)_n^{1-n}$ ($n = 0, 1, 2, 3$)) is formed by reduction of Ru(IV) and is extracted. The presence of a black precipitate likely indicates that some of the salt is reduced further to metallic ruthenium.

Considering next the congeners of cobalt itself, Rh(III) (as $Na_3RhCl_6 \cdot 18H_2O$) was found to depress cobalt sorption significantly ($D/Do = 0.793$) at the 1000 ppm level but not measurably so at lower concentrations. Evidently, an extractable rhodium-thiocyanate complex must be formed but in small amounts and/or of low extractability under the solution conditions. Iridium, on the other hand, did not interfere at all either as Ir(III) ($Na_3IrCl_6 \cdot 12H_2O$) or as Ir(IV) ($(NH_4)_2IrCl_6$) at the 1000 ppm level. The observed changes in solution colours from brown to yellow-green are characteristic of the rapid reduction of that metal from the +4 oxidation state to +3 (probably by SCN^-). Brown colours

initially present in the Ir(III) salt arise from impurities of Ir(IV) very commonly present.

Like iridium, nickel present at 1000 ppm concentration (as $\text{NiCl}_2 \cdot 6\text{H}_2\text{O}$) did not interfere with cobalt sorption since its thiocyanate complexes are relatively unstable⁽²³⁰⁾. By contrast, both palladium and platinum are strong interferents of cobalt sorption. Palladium(II) as (PdCl_2) seems to be the less severe of the two but shows large depression at both the 1000 ppm and 100 ppm levels evidently by formation of an extractable red thiocyanate complex as reported for different solvents by others⁽¹⁹⁸⁾. Platinum(II) (as K_2PtCl_4) and Pt(IV) (as $\text{Na}_2\text{PtCl}_6 \cdot 6\text{H}_2\text{O}$) appear to form yellow and orange extractable thiocyanate complexes, respectively, in accord with solvent extraction methods based on thiocyanate use⁽¹⁹⁸⁾. The interference/concentration curves for both Pd and Pt are shown in Figures 2-26 and 2-27.

Considering next the Group Ib metals, we see that interferences are observed for both Cu(II) and Au(III). Copper(II) (added as $\text{CuCl}_2 \cdot 2\text{H}_2\text{O}$) would not dissolve nearly to the extent of 1000 ppm concentration but interfered considerably with cobalt sorption. From the recorded changes in solution colours and the formation of a precipitate, it seems that at least some of the Cu(II) added is reduced to Cu(I) by SCN^- under the conditions used and precipitates as CuSCN . The observed interference probably arises, then, out of the extraction of a yellow-brown copper complex (probably of SCN^-). The complex could contain either Cu(I) or Cu(II), however, since both are known to be extractable⁽¹⁹⁸⁾.

A much more powerful interferent of cobalt sorption is Au(III) (taken as $\text{HAuCl}_4 \cdot 3\text{H}_2\text{O}$) which appears to do so even down to the 1 ppm

level. From the observations made in Table II-21, it seems that the yellow Au(III) is perhaps partly reduced to Au(I) and complexed by SCN^- to form a precipitate which may or may not be extracted by foam. Some metallic gold may also be produced by disproportionation of Au(I) but it is difficult to tell whether or not this actually occurred. Since no colour was observed to be acquired by foam, we conclude either that a colourless complex is extracted to displace cobalt or that the interference effect is due to changes in the solution chemistry (e.g. production of CN^- from SCN^- or some such phenomenon). The interference/concentration profile for Au(III) is shown in Figure 2-26.

Ag(I), also a member of Group Ib, was nonetheless not tested since it forms a precipitate (AgSCN) with thiocyanate ion (the basis of a gravimetric procedure for SCN^-). For this reason, it was felt that assessing its interference effects would be difficult.

Considering next the Group IIb metals (Zn, Cd, Hg), we see from Table II-21 that each shows some tendency to block the sorption of cobalt by polyurethane foam. Most impressive among these is Zn(II) (as ZnCl_2) which suppresses cobalt sorption completely even at the 100 ppm level. Spectrophotometric measurements (Table II-23) show that no interference with the cobalt solution equilibria appears to take place so we conclude that an extractable but colourless zinc thiocyanate complex must be competing effectively for foam sites. In addition, judging from the position of the interference/concentration profile in Figure 2-27, the zinc complex appears to be even slightly more efficiently extracted than is that of Co(II) itself. This is in keeping with the known⁽¹⁹⁸⁾ ready extractability of the zinc thiocyanate complex which is variously reported to be Zn(SCN)_2 , Zn(SCN)_3^- or Zn(SCN)_4^{2-} for various solvents.

Much less strongly interfering than this is Cd(II) (taken as $\text{CdCl}_2 \cdot 2\frac{1}{2}\text{H}_2\text{O}$) which also is reported to be solvent extractable either as a neutral thiocyanate or as its acid complexes under appropriate conditions. However, Hg(II) (as HgCl_2) shows more interference than this but much less than zinc. The interference/concentration profile for Hg(II) is shown in Figure 2-26. As for Zn(II), spectrophotometric measurement indicates that interference with cobalt sorption is not accomplished by alterations to the Co-SCN^- equilibria and again a colourless Hg(II) thiocyanate complex must be both formed and extracted. Interestingly, although Hg(II) produces one of the most stable thiocyanate complexes known ($\beta_4 \approx 10^{22}$ ⁽²³⁰⁾), its presence nevertheless interferes much less with cobalt sorption than do many other metal ions. This may indicate that the complex is much less extractable than those of many other metals but part of the reason is also likely the fact that Hg(SCN)_4^{2-} forms a co-complex with cobalt, CoHg(SCN)_4 , with low solubility which has been used in a gravimetric procedure for cobalt⁽²⁰⁰⁾. Thus, either the ion pairs have been extracted or some precipitate may have been trapped by foam (although none was visible).

Next considering the Group IIIb metals (Al, Ga, In, Tl), we see from Table II-21 that Al(III) (as $\text{Al(NO}_3)_3 \cdot 9\text{H}_2\text{O}$) and Tl(I) (as TlCl) both produce very slight enhancements of cobalt sorption at approximately the 1000 ppm level (Tl(I) could not be induced to dissolve to that extent). Ga(III) (as $\text{Ga(NO}_3)_3 \cdot 9\text{H}_2\text{O}$) appears to be largely without any effect at all but In(III) (as InCl_3) is a strong interferent (see interference/concentration profile in Figure 2-26). Although neither Al(III) nor Tl(I) are known to form highly extractable thiocyanate species⁽¹⁹⁸⁾,

both In(III) and Ga(III) are reported to be readily extractable in this form. Apparently, only indium is able both to generate the thiocyanate complex and have it extracted into polyurethane to interfere with cobalt sorption under the conditions of the experiment. This interpretation is supported by spectrophotometric measurements (Table II-23) which show no alteration of the Co-SCN⁻ equilibria as a result of In(III) addition.

Moving on to the Group IVb metals (Sn and Pb), we observe from Table II-21 that both Sn(II) (as SnCl₂·2H₂O) and Pb(II) (as PbCl₂) are apparently without interference effects. Both salts were difficult to dissolve and the SnCl₂·2H₂O evidently hydrolyzed to some extent in the very weakly acidic solution to yield a white precipitate (either Sn(OH)₂ or a mixed chlorohydroxy species⁽²⁰¹⁾). On the other hand, Sn(IV) (as SnCl₄·5H₂O) was found to interfere fairly strongly with Co(II) sorption but not in the usual manner. In this case, a small amount of gelatinous precipitate (probably SnO₂·xH₂O) formed by hydrolysis of the SnCl₄ (as evidenced by the lower final solution pH produced). This precipitate was found to contain nearly 90% of the ⁶⁰Co activity likely as coprecipitated oxides or hydroxides. Additional interference with cobalt sorption may also have occurred by uptake onto foam of Sn(IV) thiocyanate species since these are reported⁽¹⁹⁸⁾ to be extracted by a variety of solvents.

With Group Vb (Sb and Bi), Table II-21 shows that Bi(III) (as BiCl₃) has no effect on cobalt sorption but that some influence is felt in the presence of Sb(III) (as SbCl₃). In the presence of water, the SbCl₃ is expected to hydrolyze⁽¹⁹⁸⁾ somewhat to produce insoluble oxo chlorides such as SbOCl and Sb₄O₅Cl₂ thus lowering the solution pH slightly. How-

ever, thiocyanate species are neither readily formed nor extractable⁽¹⁹⁸⁾ and the mechanism whereby any interference might occur is unknown, therefore.

Finally, the last remaining metal ion tested, U(VI) (as $\text{UO}_2(\text{CH}_3\text{COO})_2 \cdot 2\text{H}_2\text{O}$) was found to be without interference of cobalt sorption in spite of the fact that this element is also extractable as its thiocyanate (but probably in a neutral form such as $\text{UO}_2(\text{SCN})_2 \cdot 2\text{S}$ where S is a solvent molecule)⁽¹⁹⁸⁾.

To allow quick reference and easy comparison of the large amount of data in Table II-21 to be made, a display of the metals tested as interferences and the qualitative results obtained is shown in the format of a periodic table in Figure 2-28. Elements which showed the largest interference effects appear with the darkest backgrounds in the Figure. Many of the strongly interfering metal ions do so by formation of polyurethane-extractable thiocyanate complexes and are thus good candidates for sorption studies of their own and can obviously be separated from many others which do not, at least under the existing conditions. It should be stressed, however, that quite different results would most probably be observed if the solution parameters were altered substantially.

Having dealt with the effects of both anions and metal ions, we may now shift our attention to the various nitrogen-containing compounds listed in Table II-22. Cobalt forms a fairly large number of complexes with ligands containing the N atom and a number of extraction procedures make use of both SCN^- and a protonated nitrogen-containing compound. In addition, since we have suggested that sufficient nitrogen is actually

Figure 2-28

Summary of the results of cobalt sorption interference studies performed with various metal ions. For details of experimental conditions see

Figure 2-26 or 2-27. Further descriptions of the types of interference encountered in each case are contained in the text.

present in polyurethane foam to perhaps contribute to extraction, it was considered desirable to test a few compounds for their effects in solution. Several series of compounds were selected for these tests in the hope that developing trends would be apparent and understandable. In the process, some quite interesting characteristics were noted which have some bearing on our interpretation of the extraction mechanism.

Before proceeding, however, it is first important to establish the form in which the various added substances will exist in solution. The relative acid strengths ⁽²⁴⁰⁻⁴³⁾, pK_{HB} of the protonated bases in water (i.e. for the equilibrium $HB^+ + H_2O \rightleftharpoons B + H_3O^+$ where B is the base in question) are listed in Table II-22 for most of the substances there. By comparison of these values of pK_{HB} with the solution pH (fixed at about 4.5 by the acetate buffer), it is possible to establish the chief form of the base in solution. Thus, we see that most of the substances tested are stronger bases than acetate ion ($pK_{HB} > pH$) and so will exist primarily in the protonated HB^+ cationic form in solution. A few (tetramethylammonium bromide and tetra-n-butylammonium bromide) are ionic and exist entirely as $R_4N^+ + Br^-$ ions at any pH. On the other hand, a small number are very weak bases (the last four in Table II-22) and so will be essentially neutral under the chosen experimental conditions. Pyridine ($pK_{HB} = 5.23$) and aniline ($pK_{HB} = 4.60$) are borderline cases and significant amounts of each form will be present in these instances.

Considering then the data of Table II-22, probably one of the more interesting comparisons to be made is that between the blank, ammonium and hydroxylammonium ions. Thus, we note that the addition of either 1.0 M NH_4^+ (as NH_4Cl) or 1.0 M NH_3OH^+ (as $NH_2OH \cdot HCl$) to solution produces

TABLE II-22 - EFFECT OF VARIOUS NITROGEN-CONTAINING COMPOUNDS AND CATIONS ON COBALT ABSORPTION BY POLYURETHANE FOAM

Initial Conditions:

[SCN⁻] 0.5 M (NaSCN) Solution Volume (V) 150.0 mL
 [Co] 1.7 x 10⁻⁶ M (0.10 ppm) Foam Weight (W) 0.050 grams
 Ionic Strength (I) 0.6 M plus any contribution Type #1338 BFG
 from cation salts added Squeezing Time 24.0 hours
 pH 4.8 (0.1 M Na acetate buffer) Temperature 25.00°C

Compound/Cation [Source]	{pK _{HB} }	Concentration (M)	Final pH ±0.01	Foam Weight (mg) ±0.01	Cobalt Extracted (%)	D (L kg ⁻¹)	D/Do*	Observations
none**		-	4.82	-	-	1.225 x 10 ⁴	1.000	-solution clear, colourless
NH ₄ ⁺ ammonium	{9.95}	1.00 x 10 ⁰	4.66	51.44	99.3 ±0.5	3.9 ±2.6	34 ±22	-foam turns blue-green
[NH ₄ Cl]		1.00 x 10 ⁻¹	4.75	50.67	90.8 ±0.7	2.92 ±0.22	2.33 ±0.18	-foam turns red then grey-blue
NH ₃ OH ⁺ hydroxylammonium	{5.96}	9.99 x 10 ⁻¹	4.37	50.21	98.8 ±0.5	2.4 ±0.9	21 ±8	-foam turns pale green then green
[NH ₂ OH·HCl]		9.99 x 10 ⁻²	4.73	49.77	92.4 ±0.4	3.65 ±0.20	3.18 ±0.18	
CH ₃ NH ₃ ⁺ methylammonium	{10.68}	1.00 x 10 ⁻¹	4.83	51.38	83.9 ±0.5	1.52 ±0.05	1.19 ±0.04	
[CH ₃ NH ₂ ·HCl]		1.00 x 10 ⁻²	4.80	48.55	81.3 ±0.6	1.35 ±0.04	1.05 ±0.04	

TABLE II-22 - continued

Compound/Cation [Source]	$\{pK_{HB}\}$	Concentration (M)	Final pH ± 0.01	Foam Weight (mg) ± 0.01	Cobalt Extracted (%)	D (L kg ⁻¹)	D/Do*	Observations
$(CH_3)_2NH_2^+$ dimethylammonium [$(CH_3)_2NH \cdot HCl$]	{10.77}	1.00×10^{-1}	4.82	50.82	79.9 ± 0.5	1.173×10^4 ± 0.027	0.919 ± 0.026	-foam turns light grey then pale blue-green
$(CH_3)_3NH^+$ trimethylammonium [$(CH_3)_3N \cdot HCl$]	{9.80}	1.00×10^{-2}	4.82	49.44	80.5 ± 0.5	1.253×10^4 ± 0.033	0.981 ± 0.030	
$(CH_3)_4N^+$ tetramethylammonium [$(CH_3)_4NBr \cdot H_2O$]	{strong base}	1.00×10^0	4.98	50.26	54.1 ± 0.5	3.51×10^3 ± 0.05	0.307 ± 0.007	-solution yellows slowly -foam turns green -foam turns green
$CH_3CH_2NH_3^+$ ethylammonium [$C_2H_5NH_2 \cdot HCl$]	{10.63}	1.00×10^{-1}	4.86	49.03	75.7 ± 0.5	9.55×10^3 ± 0.22	0.837 ± 0.024	
		1.00×10^{-2}	4.78	49.63	80.7 ± 0.6	1.27×10^4 ± 0.04	0.993 ± 0.034	
		1.00×10^{-1}	4.80	48.52	83.30 ± 0.28	1.543×10^4 ± 0.026	1.208 ± 0.028	-foam turns pink, then bluish-grey
		1.00×10^{-2}	4.82	49.99	81.5 ± 0.4	1.320×10^4 ± 0.031	1.034 ± 0.029	

TABLE II-22 - continued

Compound/Cation [Source]	{pK _{HB} }	Concentration (M)	Final pH ±0.01	Foam Weight (mg) ±0.01	Cobalt Extracted (%)	D (L kg ⁻¹)	D/Do*	Observations
H ₃ NCH ₂ CH ₂ NH ₂ ⁺ ethylenediammonium	{1st 6.85}	1.00 x 10 ⁻¹	9.06	51.28	0.0	0.0	0.0000	-foam remains white
	{2nd 9.93}				±0.6	±1.7	±0.0014	
[C ₂ H ₈ N ₂]		5.00 x 10 ⁻²	6.65	50.20	0.5	1.4	0.0012	-foam remains white
					±0.5	±1.4	±0.0012	
CH ₃ (CH ₂) ₃ NH ₃ ⁺ n-butylammonium	{10.01}	9.90 x 10 ⁻³	4.97	49.10	79.7	1.20	0.96	
					±0.7	±0.04	±0.04	
[C ₄ H ₉ NH ₂]		1.02 x 10 ⁻³	4.80	50.74	81.9	1.339	1.069	
					±0.4	±0.031	±0.032	
CH ₃ CH ₂ CH(CH ₃)NH ₃ ⁺ sec-butylammonium	{10.60}	1.00 x 10 ⁻¹	6.72	49.42	91.4	3.21	2.80	-sorption a bit slow
					±0.4	±0.14	±0.14	
[C ₄ H ₉ NH ₂]		1.00 x 10 ⁻²	4.92	50.99	81.6	1.30	1.14	
					±1.1	±0.08	±0.07	
(CH ₃) ₃ CNH ₃ ⁺ t-butylammonium	{10.83}	1.00 x 10 ⁻¹	6.27	49.76	85.0	1.70	1.33	-solution slightly yellow
					±0.5	±0.06	±0.05	
[C ₄ H ₉ NH ₂]		1.00 x 10 ⁻²	4.89	49.63	81.1	1.30	1.01	-foam turns pale green
					±0.6	±0.04	±0.04	
[C ₄ H ₉ NH ₂]		1.00 x 10 ⁻¹	6.24	48.80	82.3	1.43	1.12	
					±0.6	±0.05	±0.04	
[C ₄ H ₉ NH ₂]		1.00 x 10 ⁻²	4.89	49.93	80.6	1.25	0.976	
					±0.5	±0.04	±0.031	

TABLE II-22 - continued

Compound/Cation [Source]	{pK _{HB} }	Concentration (M)	Final pH ±0.01	Foam Weight (mg) ±0.01	Cobalt Extracted (%)	D (L kg ⁻¹)	D/Do*	Observations
(CH ₃ (CH ₂) ₃) ₂ NH ⁺ di-n-butylammonium [(C ₄ H ₉) ₂ NH]	{11.25}	1.00 x 10 ⁻¹	6.64	49.73	98 ±4	1.3 ±2.0 x 10 ⁵	11 ±17	-solution pale yellow -foam turns greenish- yellow
(CH ₃ (CH ₂) ₃) ₃ NH ⁺ tri-n-butylammonium [(C ₄ H ₉) ₃ N]	{11.04}	1.00 x 10 ⁻²	4.92	47.31	86.2 ±0.5	1.98 ±0.08 x 10 ⁴	1.72 ±0.07	-forms two layers -upper organic layer (~3 mL) contains about 80% of ⁶⁰ Co -foam swells and turns brown
(CH ₃ (CH ₂) ₃) ₄ N ⁺ tetra-n-butylammonium [(C ₄ H ₉) ₄ NBr]	{strong base}	9.97 x 10 ⁻³	4.93	49.96	97.5 ±0.7	1.18 ±0.32 x 10 ⁵	10.2 ±2.8	-forms two layers -upper organic layer (~4-5 mL) contains about 90% of ⁶⁰ Co -foam turns yellowish
(CH ₃ (CH ₂) ₃) ₂ NH ⁺ di-n-butylammonium [(C ₄ H ₉) ₂ NH]		1.00 x 10 ⁻¹	4.88	47.69	60.0 ±3.2	4.7 ±0.5 x 10 ³	0.37 ±0.04	-forms two layers -upper organic layer (~4-5 mL) contains about 90% of ⁶⁰ Co -foam turns yellowish
(CH ₃ (CH ₂) ₃) ₃ NH ⁺ tri-n-butylammonium [(C ₄ H ₉) ₃ N]		1.00 x 10 ⁻²	4.86	49.16	99.5 ±0.8	6 ±10 x 10 ⁵	50 ±70	-solution faintly hazy -foam turns orange-pink then greenish-yellow

TABLE II-22 - continued

Compound/Cation [Source]	{pK _{HB} }	Concentration (M)	Final pH ±0.01	Foam Weight (mg) ±0.01	Cobalt Extracted (%)	D (L kg ⁻¹)	D/Do*	Observations
CH ₃ (CH ₂) ₅ NH ₃ ⁺ n-hexylammonium	{10.56}	1.00 x 10 ⁻¹	6.62	51.47	98.9 ±1.1	2.6 ±2.6	20 ±20	-solution cloudy with small droplets contain- ing some green colour -foam turns green -sorption a bit slow
[C ₆ H ₁₃ NH ₂]		***	"	"	-99.1 ±0.9	-3.4 ±3.4	-26 ±27***	
C ₅ H ₅ N/C ₅ H ₅ NH ⁺ pyridine/pyridinium	{5.23}	1.00 x 10 ⁻²	4.90	49.16	92.7 ±0.6	3.89 ±0.32	3.05 ±0.26	
[C ₅ H ₅ N]		1.00 x 10 ⁻¹	5.44	49.11	71.8 ±0.4	7.76 ±0.12	0.619 ±0.015	-foam turns pale green
C ₆ H ₅ NH ₂ /C ₆ H ₅ NH ₃ ⁺ aniline/anilinium	{4.60}	1.00 x 10 ⁻²	4.86	50.84	81.6 ±0.8	1.31 ±0.06	1.05 ±0.05	
[C ₆ H ₅ NH ₂]		1.00 x 10 ⁻¹	5.22	48.88	94.3 ±0.4	5.1 ±0.4	4.41 ±0.32	-solution pale yellow -foam turns brown-yellow
CH ₃ CONH ₂ formamide	{small}	9.98 x 10 ⁻³	4.87	49.37	87.3 ±0.6	2.08 ±0.09	1.63 ±0.08	-solution faintly yellow -foam turns green
[CH ₃ CONH ₂]		1.00 x 10 ⁻¹	4.84	49.97	81.6 ±0.7	1.33 ±0.05	1.04 ±0.04	
		9.99 x 10 ⁻³	4.84	51.22	80.9 ±0.5	1.241 ±0.034	0.972 ±0.031	

TABLE II-22 - continued

Compound/Cation [Source]	{pK _{HB} }	Concentration (M)	Final pH ±0.01	Foam Weight (mg) ±0.01	Cobalt Extracted (%)	D (L kg ⁻¹)	D/Do*	Observations
CH ₃ CONH(CH ₃)								
N-methylformamide	{small}	9.99 x 10 ⁻²	4.83	51.03	81.0 0.6	1.26 0.04 x 10 ⁴	0.98 0.04	
[CH ₃ CONH(CH ₃)]		1.00 x 10 ⁻²	4.82	48.42	80.0 0.5	1.236 0.032 x 10 ⁴	0.968 0.029	
(CH ₃)HNCONH(CH ₃)								
N,N'-dimethylurea	{small}	1.00 x 10 ⁻¹	4.85	48.67	80.4 0.7	1.26 0.04 x 10 ⁴	0.99 0.04	
[(CH ₃)HNCONH(CH ₃)]		1.00 x 10 ⁻²	4.83	49.36	80.7 0.6	1.27 0.04 x 10 ⁴	0.99 0.04	
H ₂ NCOOCH ₂ CH ₃								
urethane	{small}	1.00 x 10 ⁻¹	4.82	50.31	81.0 0.7	1.27 0.04 x 10 ⁴	1.00 0.04	
[H ₂ NCOOCH ₂ H ₅]		1.00 x 10 ⁻²	4.82	48.66	80.3 0.5	1.255 0.031 x 10 ⁴	0.983 0.029	

* It was necessary to prepare three separate batches of stock NaSCN/NaOCCCH₃/HOCCCH₃/CoCl₂ solution to complete all of the experiments. The value of Do used in each case is the average of three separate measurements of distribution ratio made in the absence of any interferent using the appropriate batch of stock solution.

** Average of all blank experiments conducted with all three batches of stock solution. Except where noted otherwise, the observations for other experiments are identical to those shown here for no interferent present.

*** Based on estimated total initial ⁶⁰Co activity rather than measured value (which nearly excludes upper organic phase).

enhancements in cobalt extraction (D/Do) of 34- and 21-fold, respectively. Recalling that 1.0 M NaCl produces an enhancement of only 13-fold and that this has been interpreted as arising from both increased ionic strength and greater cation concentration, we infer that some additional effect must be at play here. Spectrophotometric measurements with both NH_4Cl and $\text{NH}_2\text{OH}\cdot\text{HCl}$ (Table II-23) show that no visible changes in the solution cobalt-thiocyanate equilibria accompany the additions. Thus, the effects must probably be related directly to some sorption characteristics of the added ions themselves. As already mentioned, the ammonium chloride will be almost entirely in the $\text{NH}_4^+ + \text{Cl}^-$ form at the pH of the experiment while the $\text{NH}_2\text{OH}\cdot\text{HCl}$ would exist as about 96% $\text{NH}_3\text{OH}^+ + \text{Cl}^-$ with the remainder as NH_2OH . Since there is a large effect for NH_4Cl and a smaller one for $\text{NH}_2\text{OH}\cdot\text{HCl}$, it is most likely that the ions NH_4^+ and NH_3OH^+ are extractable as counter ions to $\text{Co}(\text{SCN})_4^{2-}$ and that each of these cations is more efficiently sorbed than is Na^+ . Apparently, NH_3OH^+ is slightly less so perhaps because of its increased hydrophilicity due to the -OH group. Seen in this light, we thus realize that the identity of the cation is quite important to anion sorption. A strong interaction between polyurethane foam and the ammonium ion may be indicated by the red colour developed initially by the foam but this colour would be difficult to distinguish from what might be expected from contaminating iron.

Further interesting information comes from a comparison of the D/Do values for the series in which H atoms in NH_4^+ are progressively replaced by methyl groups. Thus, summarizing the results of Table II-22, we have:

Ion Added	D/Do for 0.10 M concentration
NH_4^+	2.33 ± 0.18
CH_3NH_3^+	1.19 ± 0.04
$(\text{CH}_3)_2\text{NH}_2^+$	0.919 ± 0.026
$(\text{CH}_3)_3\text{NH}^+$	0.888 ± 0.030
$(\text{CH}_3)_4\text{N}^+$	0.837 ± 0.024

From this, we see a steady trend away from the substantial enhancement produced by 0.10 M NH_4^+ to the slight depression caused by 0.10 M $(\text{CH}_3)_4\text{N}^+$. Although spectrophotometric measurements were not made on all of the members of this series, both NH_4^+ and $(\text{CH}_3)_4\text{N}^+$ were observed not to produce any substantial changes in the Co- SCN^- equilibria (see Table II-23) and this might be assumed to be true for the others as well. The steady decline in the measured cobalt sorption as hydrogen atoms in NH_4^+ are substituted with methyl groups is curious since it occurs in spite of the fact that the cations thereby become progressively more hydrophobic and should therefore be expected to be more readily extractable into any solvents with lower polarity than water. This should apply to polyurethane and so we again infer that there is special solvation available to the NH_4^+ ion which becomes impossible with the trend to $(\text{CH}_3)_4\text{N}^+$.

There are two obvious chemical properties which change in a regular manner in this series: ion size and the availability of weakly acidic hydrogen atoms for H-bonding. Either or both of these may be important factors in deciding the effect of the cation. If hydrogen-bonding capability is at issue then the progression is very easily understood since NH_4^+ is very well-equipped while $(\text{CH}_3)_4\text{N}^+$, of course, is not. However, if ion size is the key, then it must be directly related to the mechanism

of special solvation rather than to limitations on penetration into the polyurethane (as it is for ion exclusion chromatography, for example) since ions much larger than $(\text{CH}_3)_4\text{N}^+$ (such as $\text{Co}(\text{SCN})_4^{2-}$, for that matter) are easily sorbed. We have previously hinted that cation solvation in polyurethane may be of a chelation type probably involving the polyether moieties (the Cation Chelation Mechanism) and in this light it is easy to understand decreases in its possible effectiveness as the bulk of the cation is greatly increased or its H-bonding abilities are removed. What is perhaps more difficult to explain is the mechanism whereby interference with cobalt sorption may be brought about (i.e. $D/D_0 < 1.00$) by the addition to solution of a cation such as $(\text{CH}_3)_4\text{N}^+$ which appears not to disrupt the Co-SCN^- solution equilibria measurably and which we suppose not to be especially well sorbed by foam. One possible explanation of this is that the addition of Cl^- or Br^- to solution actually depresses sorption slightly (perhaps by competition for sorption sites) but that this effect was previously masked by the accompanying increases due to extra Na^+ also added. Although possible, this seems unlikely since the addition of 0.1 M Cl^- or Br^- in the presence of 0.5 M SCN^- (which should be a much more extractable anion) would not be expected to produce a significant effect. On the other hand, it is possible that ion multiples of the type $((\text{CH}_3)_4\text{N}^+)_2\text{Co}(\text{SCN})_4^{2-}$ may be forming in solution to some extent thereby interfering with the normal extraction of $\text{Na}_2\text{Co}(\text{SCN})_4$. This is perhaps not entirely unreasonable although another equally feasible explanation is that small amounts of the large cation (along with some anion) are sorbed by foam and as a result of not being chelatable tie up "solvent" very inefficiently. This loss of available

"solvent" might thus interfere with the solvation of a larger number of chelatable cations to produce a net drop in cobalt sorption. Which, if any, of these suggestions is true, is not known and would be difficult to determine.

Strangely enough, although successive substitution of CH_3 groups for hydrogen atoms in the ammonium ion leads to decreased sorption of cobalt, the opposite effect was apparently demonstrated when n-butyl groups are substituted instead:

Ion Added	D/Do	
	0.10 M	0.010 M
NH_4^+	2.33 ± 0.18	-
$(\text{CH}_3(\text{CH}_2)_3)\text{NH}_3^+$	2.80 ± 0.14	1.14 ± 0.07
$(\text{CH}_3(\text{CH}_2)_3)_2\text{NH}_2^+$	11 ± 17	1.72 ± 0.07
$(\text{CH}_3(\text{CH}_2)_3)_3\text{NH}^+$	$\sim 200 \pm 1000$	10.2 ± 2.8
$(\text{CH}_3(\text{CH}_2)_3)_4\text{N}^+$	$\sim 6.8 \pm 1.1$	50 ± 70

However, the situation is more complicated here since it was observed in the experiment and again in the spectrophotometric studies (see Table II-23) that two phases were produced in each case by the addition of the (n-butyl)-containing substances to solution and that much of the green cobalt colour and ^{60}Co activity (progressively more as the number of such groups increases) was extracted into the organic phase. The existence of two immiscible phases containing very different concentrations of cobalt created large analytical problems in the experiment and so precision was low. An attempt was made to circumvent a part of this by not using some of the initial solution activity data in the calculations

(see Table II-22 and footnotes thereof) but with limited success.

Once in contact with polyurethane foam, the organic phases were noted to associate themselves immediately with the foam, causing it to swell considerably in some cases. Where the volume of the organic phase was relatively large, much of it was squeezed out by the action of the distribution cell plunger but was again "mopped up" when the foam expanded once more. Thus, the apparent anomaly is easily explained since these (n-butyl)-containing amines evidently are themselves behaving as liquid ion exchangers which probably collect mostly at the foam/water interface. The use of liquid ion exchangers (but of higher molecular weight) in conjunction with polyurethane foam for metal ion extraction has already been described^(50, 121-3, 125-7).

Another interesting series in this respect is that created by the substitution of only one alkyl group but of differing chain length for a hydrogen atom in the ammonium ion:

Ion Added	D/Do	
	0.10 M	0.010 M
NH_4^+	2.33 ± 0.18	-
CH_3NH_3^+	1.19 ± 0.04	1.05 ± 0.04
$\text{CH}_3\text{CH}_2\text{NH}_3^+$	1.208 ± 0.028	1.034 ± 0.029
$\text{CH}_3(\text{CH}_2)_3\text{NH}_3^+$	2.80 ± 0.14	1.14 ± 0.07
$\text{CH}_3(\text{CH}_2)_5\text{NH}_3^+$	$\sim 26 \pm 27$	3.05 ± 0.26

In this series, we note that the initial decrease in cobalt extraction accompanying the replacement of one H-atom in NH_4^+ with a methyl group and then an ethyl group (and thus decreasing H-bonding or creating steric interferences with chelation) is overtaken by the liquid anion

exchanger effect mentioned above as longer chains are incorporated. Again, two distinct phases were observed (at least in the case of the n-hexylammonium ion) in both the distribution experiment and the spectrophotometric study (Table II-23).

A further series comparison to be made in Table II-22 is that between the various ammonium salts which contain the three isomers of the butyl ion as the sole alkyl group:

Ion Added	D/Do	
	0.10 M	0.010 M
$\text{CH}_3(\text{CH}_2)_3\text{NH}_3^+$	2.80 ± 0.14	1.14 ± 0.07
$\text{CH}_3\text{CH}_2\text{CH}(\text{CH}_3)\text{NH}_3^+$	1.33 ± 0.05	1.01 ± 0.04
$(\text{CH}_3)_3\text{CNH}_3^+$	1.12 ± 0.04	0.976 ± 0.031

In this case, there appears to be a general decrease in the enhancement of cobalt sorption as the alkyl group becomes shorter and more compact. Such an effect could arise either by increasing the steric interference of cation chelation (since more of the alkyl group is then in the immediate vicinity of the chelatable $-\text{NH}_3^+$ group) or by decreasing the extent to which it can behave as a liquid anion exchanger with its hydrophobic "tail" solvated by polyurethane while anions exchange at its polar "head" in the aqueous phase. Quite likely, both of these phenomena should be considered.

Several other substances which do not fit readily into a logical series were also tested for different reasons. First of all, ethylenediamine (added in that form but present chiefly as the mono- or diammonium salt in solution) was tested as an example of a known N-containing

complexant of cobalt (with stepwise formation constants $K_1 = 7.8 \times 10^5$, $K_2 = 6.9 \times 10^4$ and $K_3 = 1.3 \times 10^3$ ⁽²⁴⁰⁾). The results in Table II-22 show that it is a powerful interferent presumably through its influence on the solution equilibria of cobalt. In addition, the reasonably weak base, pyridine (which should be approximately 84% protonated to the pyridinium ion in this experiment) showed some interfering effect though not so dramatic. The spectrophotometric study indicated that a pink precipitate (most probably $\text{Co}(\text{C}_5\text{H}_5\text{N})_4(\text{SCN})_2$) formed with its addition and removed almost all of the cobalt from solution. This complex is commonly used for the gravimetric determination of cobalt⁽²⁰⁰⁾. Another amine which was tested was aniline ($\text{C}_6\text{H}_5\text{NH}_2$) which would be present in approximately equal amounts as the protonated and free base forms under the experimental conditions. In this case, moderate enhancement of cobalt sorption was experienced. However, spectrophotometric study indicated that no shift in Co-SCN^- equilibria occurred and that two phases were again present in the absence of foam. Thus, a liquid anion exchanger effect similar to many other large bases was likely again at work.

Another interesting but largely unrelated set of N-containing compounds tested in this experiment was the group of four found last in Table II-22 (formamide, N-methylformamide, N,N'-dimethylurea and urethane). All are very weak bases and so would not be measurably protonated at pH 4.5. These were deliberately chosen to mimic the types of N-containing groups present in large numbers in polyurethane foam which might possibly be expected to participate in cobalt sorption. Thus, amide, urea and urethane links are represented by these compounds and might be expected to influence the sorption of cobalt either positively or negatively by

TABLE II-23 - SPECTROPHOTOMETRIC STUDY OF THE EFFECTS OF ADDED SUBSTANCES ON COBALT-THIOCYANATE FORMATION IN AQUEOUS SOLUTION

Conditions:

[SCN⁻] 0.50 M (NaSCN) Spectrophotometer Unicam model 600B
 [Co] 1.7 x 10⁻³ M (100 ppm) Cuvet Path Length 1.0, 10.0, 40.0,
 pH 4.6 (0.1 M Na acetate buffer) Type quartz
 Observation times 1. within 2 hours of mixing
 2. after 12 hours at room temperature and 24 hours at 25.00°C

Added Substance	Source	Concentration (M)	Visual Changes	Spectral Changes	D/Do	Inferences
none	-	-	pink solution unchanged with time	-peak at 510 nm -shoulder at 470 nm -shoulder to large SCN ⁻ peak at 275 nm	1.000	
F ⁻	NaF	1.0	slight white precipitate, turbidity	-more intense UV absorptions -small decrease of 510 nm relative to 470 nm	2.84 ±0.13	possibly some decrease in Co-SCN ⁻ formation
Cl ⁻	NaCl	1.0	none	none	13 ±4	Co equilibria unaltered

TABLE II-23 - continued

Added Substance	Source	Concentration (M)	Concentration (ppm)	Visual Changes	Spectral Changes	D/Do	Inferences
NO_3^-	NaNO_3	1.0	-	none	-more intense UV absorptions (~300 nm) -visible spectrum unchanged	8.6 ± 0.8	Co equilibria probably unaltered
NO_2^-	NaNO_2	1.0	-	orange solution	-much stronger UV absorption with tail into visible obscures spectrum	-	-
ClO_3^-	NaClO_3	1.0	-	none	none	10.6 ± 1.9	Co equilibria unaltered
ClO_4^-	$\text{NaClO}_4 \cdot \text{H}_2\text{O}$	1.0	-	none	none	7.9 ± 1.5	Co equilibria unaltered
H_2PO_4^-	$\text{NaH}_2\text{PO}_4 \cdot \text{H}_2\text{O}$	1.0	-	none	about 15% decrease in both visible and UV absorptions	7.9 ± 2.1	some decrease in Co-SCN ⁻ formation
CN^-	NaCN	0.01	-	solution turns orange-yellow after several minutes	-much stronger UV absorption -new peak at 325 nm -increased tail absorptions at blue end of visible spectrum -sharp decreases in peaks at 480 nm and 510 nm	0.0009 ± 0.0018	new unextractable Co complex forming

TABLE II-23 - continued

Added Substance	Source	Concentration (M)	Concentration (ppm)	Visual Changes	Spectral Changes	D/Do	Inferences
SO_3^{2-}	Na_2SO_3	1.0	-	pale pink solution	-more intense UV absorptions near 580 and 620 nm added	0.612 ± 0.013	some new unextractable cobalt complexes forming
$\text{S}_2\text{O}_3^{2-}$	$\text{Na}_2\text{S}_2\text{O}_3 \cdot 5\text{H}_2\text{O}$	1.0	-	-solution turns pale violet -small amount of white precipitate -slight turbidity	-more intense UV absorptions at 670, 610 and 570 nm added	25 ± 15	some additional new extractable cobalt complexes or trapped precipitates forming
CrO_4^{2-}	Na_2CrO_4	1.0	-	dark orange solution	-more intense UV absorptions -increased tail absorptions at blue end of visible obscures spectrum	0.296 ± 0.006	possibly SCN^- being destroyed
CH_3COO^- acetate	$\text{Na}_2\text{C}_2\text{H}_3\text{O}_2 \cdot 3\text{H}_2\text{O}$	1.0	-	none	-about 15% decrease in UV absorption -increased absorption near 550 nm	6.2 ± 0.7	probably some new but perhaps partly extractable cobalt complexes forming

TABLE II-23 - continued

Added Substance	Source	Concentration (M)	Concentration (ppm)	Visual Changes	Spectral Changes	D/Do	Inferences
$C_2O_4^{2-}$ oxalate	$Na_2C_2O_4$	0.10	-	slightly paler pink	-increase in UV absorption -small shift of absorption at 480 nm and 510 nm	0.0 ± 1.8	some new Co complex forming
$(CH(OH)COO)_2^{2-}$ tartrate	$Na_2C_4H_4O_6 \cdot 2H_2O$	0.10	-	none	-about 15% decrease in UV absorption -slight increases at 480 nm and 510 nm	0.521 ± 0.012	possibly some small amount of new complex forming
$(C(OH)COO)(CH_2COO)_2^{3-}$ citrate	$Na_3C_6H_5O_7 \cdot 2H_2O$	0.10	-	paler pink	-large decrease in 280 nm absorption -decreases and slight shift in absorption at 480 nm and 510 nm	0.0041 ± 0.0018	new unextractable Co complex probably forming
$(CH_2N(COOH)COO)_2^{2-}$ EDTA	$Na_2C_{10}H_{14}O_8N_2 \cdot 2H_2O$	0.10	-	none	-large decrease in 280 nm absorption -increase in absorption near 480 nm	0.0004 ± 0.0009	new unextractable Co complex forming
Cr(III)	$CrCl_3 \cdot 6H_2O$	1.92×10^{-2}	1000	solution slowly turns mauve after SCN^- addition	-large increase in UV absorption -large new absorptions at 565 nm and 420 nm obscure spectrum	0.0203 ± 0.0018	-

TABLE II-23 - continued

Added Substance	Source	Concentration (M)	Concentration (ppm)	Visual Changes	Spectral Changes	D/Do	Inferences
Fe(III)	$\text{FeCl}_3 \cdot 6\text{H}_2\text{O}$	1.80×10^{-2}	1000	solution deep orange-red orange precipitate forms	very large UV and visible absorptions obscure spectrum	0.335 ± 0.008	-
Zn(II)	ZnCl_2	1.55×10^{-3}	100	none	none	0.0000 ± 0.0007	Co equilibria unaltered
Hg(II)	HgCl_2	4.99×10^{-3}	1000	none	-more intense UV absorption -visible spectrum unchanged	0.1139 ± 0.0032	Co equilibria unaltered
In(III)	InCl_3	8.79×10^{-4}	100	none	none	0.224 ± 0.006	Co equilibria unaltered
NH_4^+	NH_4Cl	1.0	-	none	-very slight decrease in UV absorption -no change in visible spectrum	34 ± 22	Co equilibria unaltered
NH_3OH^+	$\text{NH}_2\text{OH} \cdot \text{HCl}$	1.0	-	none	-very slight decrease in UV absorption -visible spectrum unchanged	21 ± 8	Co equilibria unaltered

TABLE II-23 - continued

Added Substance	Source	Concentration (M)	Concentration (ppm)	Visual Changes	Spectral Changes	D/Do	Inferences
$(\text{CH}_3)_4\text{N}^+$	$(\text{CH}_3)_4\text{NBr} \cdot \text{H}_2\text{O}$	0.10	-	none	none	0.837 ± 0.024	Co equilibria unaltered
$\text{CH}_3(\text{CH}_2)_3\text{NH}_3^+$	$\text{C}_4\text{H}_9\text{NH}_2$	0.10	-	slight turbidity (white precipitate)	-increased UV absorption -increases in blue end of visible spectrum -peaks at 480 nm and 510 nm reduced	2.80 ± 0.14	possibly some decrease in Co-SCN ⁻ formation but some other partly extractable form produced
$(\text{CH}_3(\text{CH}_2)_3)_2\text{NH}_2^+$	$(\text{C}_4\text{H}_9)_2\text{NH}$	0.10	-	2 phases: -green oily droplets -pink slightly turbid solution	-decreased absorption at 280 nm -new peak at 370 nm and smaller one at 620 nm -rest of spectrum mostly unaltered	11 ± 17	some Co-SCN ⁻ complex extracting into organic layer
$(\text{CH}_3(\text{CH}_2)_3)_3\text{NH}^+$	$(\text{C}_4\text{H}_9)_3\text{N}$	0.010	-	2 phases: -blue-green oily droplets -colourless solution	-decreased UV absorption -much reduced absorption at 480 nm and 510 nm	10.2 ± 2.8	much Co-SCN ⁻ complex extracting into organic layer

TABLE II-23 - continued

Added Substance	Source	Concentration (M)	Concentration (ppm)	Visual Changes	Spectral Changes	D/Do	Inferences
$(\text{CH}_3(\text{CH}_2)_3)_4\text{NH}^+$	$(\text{C}_4\text{H}_9)_4\text{NBr}$	0.010	-	2 phases: -blue-green oily droplets which eventually crystallized -colourless cloudy solution	-much decreased UV absorption -very little visible spectrum	50 ± 70	Co-SCN ⁻ complex likely precipitated
$\text{CH}_3(\text{CH}_2)_5\text{NH}_3^+$	$\text{C}_6\text{H}_{13}\text{NH}_2$	0.10	-	2 phases: -dark green oily droplets -pale pink solution	proportional decrease in absorption at 480 nm and 510 nm	20 ± 20	some Co-SCN ⁻ complex extracting into organic layer
$\text{C}_5\text{H}_5\text{N}/\text{C}_5\text{H}_5\text{NH}^+$	$\text{C}_5\text{H}_5\text{N}$	0.10	-	pink precipitate colourless supernate	spectrum not measured	0.619 ± 0.015	Co precipitated in octahedral complex
$\text{C}_6\text{H}_5\text{NH}_2/\text{C}_6\text{H}_5\text{NH}_3^+$	$\text{C}_6\text{H}_5\text{NH}_2$	0.10	-	2 phases: -dark brown oily droplets -pink solution	increased UV absorption slight absorption tail into visible peaks at 480 nm and 510 nm unchanged	4.41 ± 0.32	Co equilibria unaltered

their presence. The fact that there was no detectable effect in either direction from any of them suggests that their counterparts in polyurethane also likely exert little or no influence on the phenomenon of cobalt-thiocyanate sorption. This information complements the previous observations based on extraction differences related to foam type and foam pretreatment which indicated that the polyol portion of the polymer was most important. It would thus appear that it may be all-important and that any possible mechanism involving foam nitrogen ligands can probably be rejected in this instance.

Having now considered all of the data in Tables II-20, II-21 and II-22, it is possible to say that the results are generally in agreement with the proposal of a special solvent extraction or ion exchange-like process in which the identity of the cation and anion are both important parameters. Many substances present in solution can exert some influence (both positive and negative) on the extraction but many others are without effect. Those substances which interfere with the cobalt sorption process apparently do so by one or more general mechanisms.

Interference phenomena:

1. Formation of cobalt-containing complexes other than $\text{Co}(\text{SCN})_4^{2-}$ which are of lower extractability by polyurethane.
2. Removal or destruction of free SCN^- ion from solution as by oxidation or by competitive complexation of other substances where SCN^- is at low concentration.
3. Filling or destroying sorption sites on foam such as by competitive sorption of anions other than $\text{Co}(\text{SCN})_4^{2-}$ or by such reactions as oxidation.

4. Alteration of some solution parameter critical to $\text{Co}(\text{SCN})_4^{2-}$ formation.

On the other hand, where enhancements of cobalt sorption are seen to occur, they likely do so by one or more of the following processes.

Enhancement phenomena:

1. Formation of cobalt-containing complexes other than $\text{Co}(\text{SCN})_4^{2-}$ which are of higher extractability by polyurethane.
2. Increasing the concentration of available cation, M^+ (or M^{2+} , etc.), which accompanies the $\text{Co}(\text{SCN})_4^{2-}$ into the polyurethane phase. All cations are not equal in their abilities to perform this function and size and/or hydrogen bonding ability may be important factors.
3. Increasing solution ionic strength.

From a practical point of view, these generalizations are vital both in predicting and avoiding other interferences and in planning possible enhancements. In an industrial setting or in the cleanup of nuclear wastes, a number of other metals, salts and perhaps surfactants, flocculants, etc. will normally accompany cobalt in solutions from which it is to be recovered. In both qualitative and quantitative analytical uses as well, many substances will be present in specific samples and will require careful choice of conditions.

Based on the data already obtained, it is evident that the important separation of cobalt from iron or from nickel (with which it will often be associated) should not be difficult. Furthermore, glancing at Figure 2-28, it seems that separations based on polyurethane foam and

thiocyanate within almost any Group of metals in the periodic table should be possible. Also, marked enhancements of sorption can be achieved by the use of long chain organic amines in conjunction with foam. In addition, we see that a variety of organic and inorganic complexants (CN^- , EDTA, oxalate, citrate, ethylenediamine) are available, if necessary, to aid in the recovery of cobalt from foam and that many others which do not greatly interfere with cobalt sorption (NO_3^- , F^- , Cl^- , Br^- , I^- , H_2PO_4^- , etc.) may be used to mask other interfering elements.

12. Polyurethane Film Sorption and Membrane Diffusion of Cobalt

The fact that the measured capacity of polyurethane foam for cobalt-thiocyanate is too large to be due to an adsorption phenomenon indicates that the species involved must be transported directly into the bulk of the polymer, presumably by diffusion. The probability then exists (as suggested by the prior work of Horsfall⁽⁴²⁾ on gallium chloride, Gesser *et al.*⁽¹⁵⁶⁾ on gallium and iron chlorides and the later work of Gupta⁽⁴⁸⁾ using uranyl nitrate) that cobalt-thiocyanate could thus be absorbed on one side on a thin film (membrane) of polyurethane and transported by diffusion to the other side.

Concurrently with the experiments designed to confirm this, some preliminary comparative tests were made of the relative cobalt sorption abilities of several commercially-available polyurethane film types. The blue colour of the absorbed cobalt-thiocyanate complex made this task qualitatively quite easy. Thus, 2.0 x 3.0 cm pieces of a number of available membrane materials were cut and exposed as a group to stirred solutions containing cobalt(II), potassium thiocyanate and sodium acetate/acetic acid buffer. The intensity of blue colour developed by each was noted visually and selections of those films to be tested further were thus made.

The three polyurethane types chosen for further study were those known as MP 1880 (a polyether-based product of the J. P. Stevens Company, Easthampton, Massachusetts) and Tuftane 312 and 410 (both polyether-based products of the B. F. Goodrich Company, Cleveland, Ohio). The physical properties of these substances are summarized at the top of

Table II-24.

Two solutions of 100 mL volume were prepared each containing 8.5×10^{-4} M (50 ppm) Co(II) and 1.0 M NaOOCCH₃/HOOCCH₃ buffer. The first solution also contained 1.00 M KSCN and was pink in colour while the second was 5.00 M in that salt and was decidedly blue. Two rectangles of 2.0 x 3.0 cm size were cut from each type and one of these was placed in a beaker containing the 1.00 M KSCN and the second in the 5.00 M KSCN solutions described above. Magnetic stirring bars were added, the tops were sealed with polyvinylchloride film to retard evaporation and the film pieces in the beakers were left to stir at room temperature for some time. The three film types were thus exposed to identical solution conditions.

After certain periods of time had elapsed, the film pieces were removed, rinsed briefly with distilled water, visually examined and then the transmission electronic absorption spectrum was measured for each. The results of the measurements are collected in Table II-24. None of the film types was found to acquire any appreciable colour in the pink 1.00 M KSCN solution even after nearly one week of stirring. In this respect, all of the polyurethane membrane types are quite different from polyurethane foam since the foam material under these conditions (1.0 M KSCN, 1.0 M buffer) would be expected to have a cobalt distribution ratio, D , in the neighbourhood of 10^6 L kg⁻¹ (see Figure 2-18) and would have become intensely coloured almost immediately. We conclude that the types of polyurethane film available are of such a composition as to be very much less efficient at cobalt sorption than are the foams. Possible reasons for this will become apparent later.

Both Tuftane 312 and Tuftane 410 were, however, noted to become visibly blue after less than one hour of exposure to the blue 5.00 M KSCN solution and an absorption maximum at 623 nm developed with time. MP 1880 also acquired a faint blue colour but much more slowly.

Measurements of the absorbance at 623 nm as a function of polymer/solution contact time for each of the three membrane types are tabulated in Table II-24 and displayed graphically in Figure 2-29. From these, we see that Tuftane 410 is the most proficient of the three at sorbing the blue colour of the cobalt-thiocyanate complex from solution but that equilibrium is not established quickly. It is obvious, however, that rapid equilibrium attainment may not be expected since the conditions of the experiment (with vast excesses of Co(II) and SCN^- compared to the quantity of polyurethane) would be such as to saturate each of the polymer types with the cobalt complex.

The visible spectrum of the sorbed complex on each of the three membrane types is shown in Figure 2-30 along with that of the blue aqueous solution (8.5×10^{-4} M Co(II), 5.00 M KSCN, 1.0 M $\text{NaOOCCH}_3/\text{HOOCCH}_3$ buffer) with which they were in contact. The Figure illustrates, first of all, that the same (or nearly the same) species must be absorbed by each of the polyurethane film types (A = Tuftane 410, B = Tuftane 312, C = MP 1880) although to greatly different extents. Furthermore, this spectrum is identical to that reported for the $\text{Co}(\text{SCN})_4^{2-}$ anion in a wide variety of simple organic solvents (acetone⁽²⁰⁶⁾, methylisobutyl ketone⁽²¹⁵⁾, dimethylsulfoxide^(207,244), tributylphosphate⁽²⁴⁵⁾, trimethylphosphate⁽²⁰⁷⁾, nitromethane⁽²⁴⁶⁾, N,N-dimethylacetamide⁽²⁰⁷⁾, and 1,2-propanediol carbonate⁽²⁰⁷⁾). Thus, the absorbed cobalt-containing

TABLE II-24 COMPARISON OF VARIOUS POLYURETHANE MEMBRANE TYPES FOR
ABSORPTION OF COBALT FROM AQUEOUS THIOCYANATE SOLUTIONS

Solution Conditions:

[Co] 8.5 x 10⁻⁴ M (50 ppm)
 [SCN⁻] 1.00 M, 5.00 M (KSCN)
 pH 4.8 (1.0 M Na acetate buffer)
 Ionic Strength (I) 2.0 M, 6.0 M
 Solution Volume (V) 100 mL
 Temperature ambient (20 - 24°C)
 Membrane Size 2.0 cm x 3.0 cm

Membrane Specifications:

Type	MP 1880	Tuftane 312	Tuftane 410
Supplier	J.P. Stevens	B.F. Goodrich	B.F. Goodrich
Thickness (mm)	0.13	0.025	0.038
(inches)	0.005	0.001	0.0015
Area Density (gm cm ⁻²) ..	0.01951	0.00353	0.00584

Membrane Type	[SCN ⁻] (M)	Contact Time (hours)	Absorbance at 623 nm
MP 1880	1.00	125.0	0.02
		25.2	0.05
	125.0	0.12	
Tuftane 312	1.00	143.0	0.00
		1.1	0.06
	3.0	0.10	
	17.5	0.42	
	43.5	0.64	
	143.0	0.83	
Tuftane 410	1.00	125.0	0.02
		6.0	0.72
	25.2	1.68	
	125.0	2.34*	

* Calculated from measured absorbance at 585 nm shoulder

Figure 2-29

Development of blue colour by 2.0 x 3.0 cm pieces of three different polyurethane film types simultaneously exposed to a stirred 100 mL cobalt-thiocyanate solution at room temperature (20-24°C). The film types and their thicknesses were: MP 1880 (0.13 mm), Tuftane 312 (0.025 mm), Tuftane 410 (0.038 mm). The initial solution conditions were as follows:

[Co] 8.5 x 10⁻⁴ M (50 ppm)
[SCN⁻] 5.00 M (KSCN)
pH 4.8 (1.0 M NaOOCCH₃/HOOCCH₃ buffer)
Ionic Strength ... 6.0 M

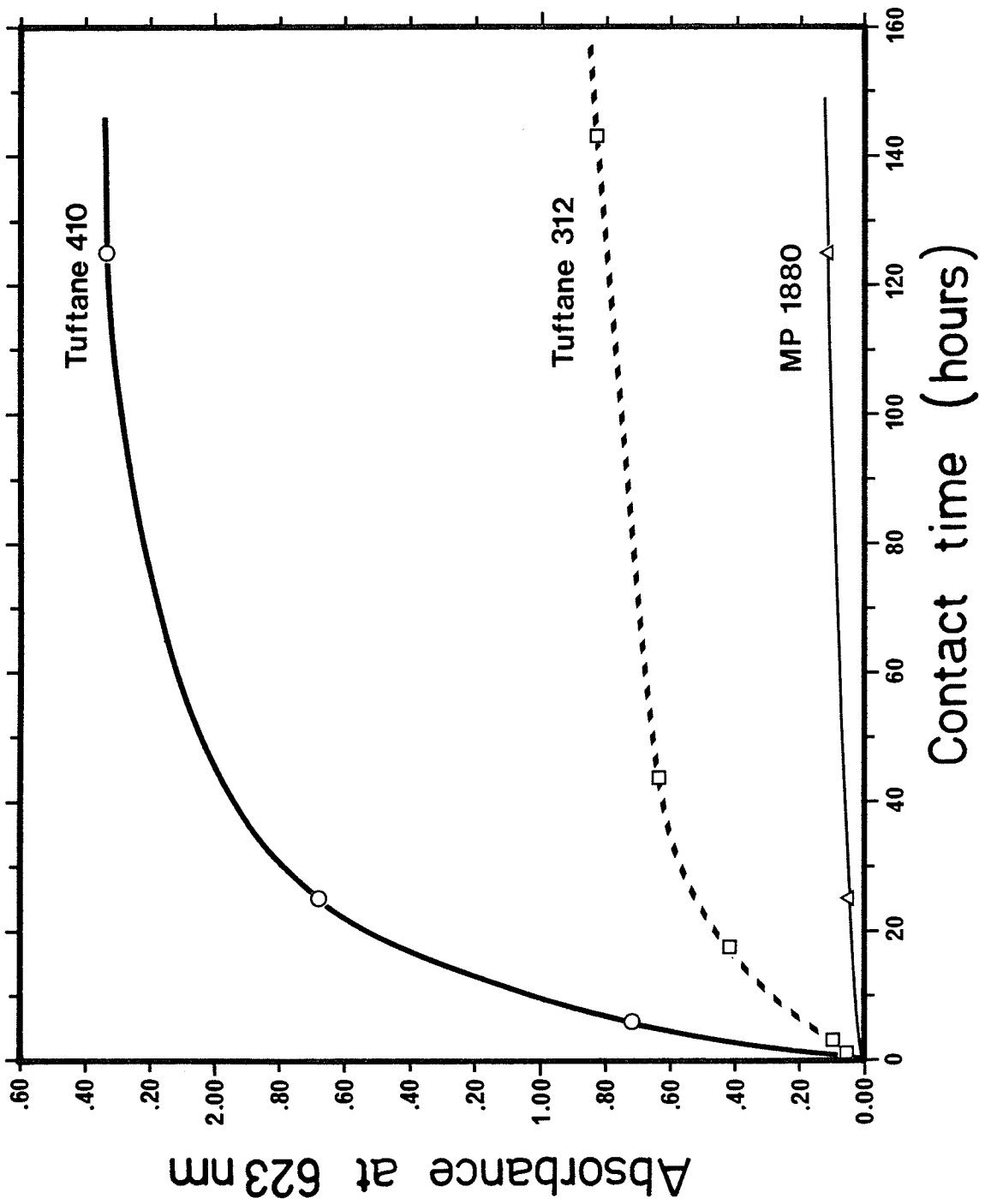
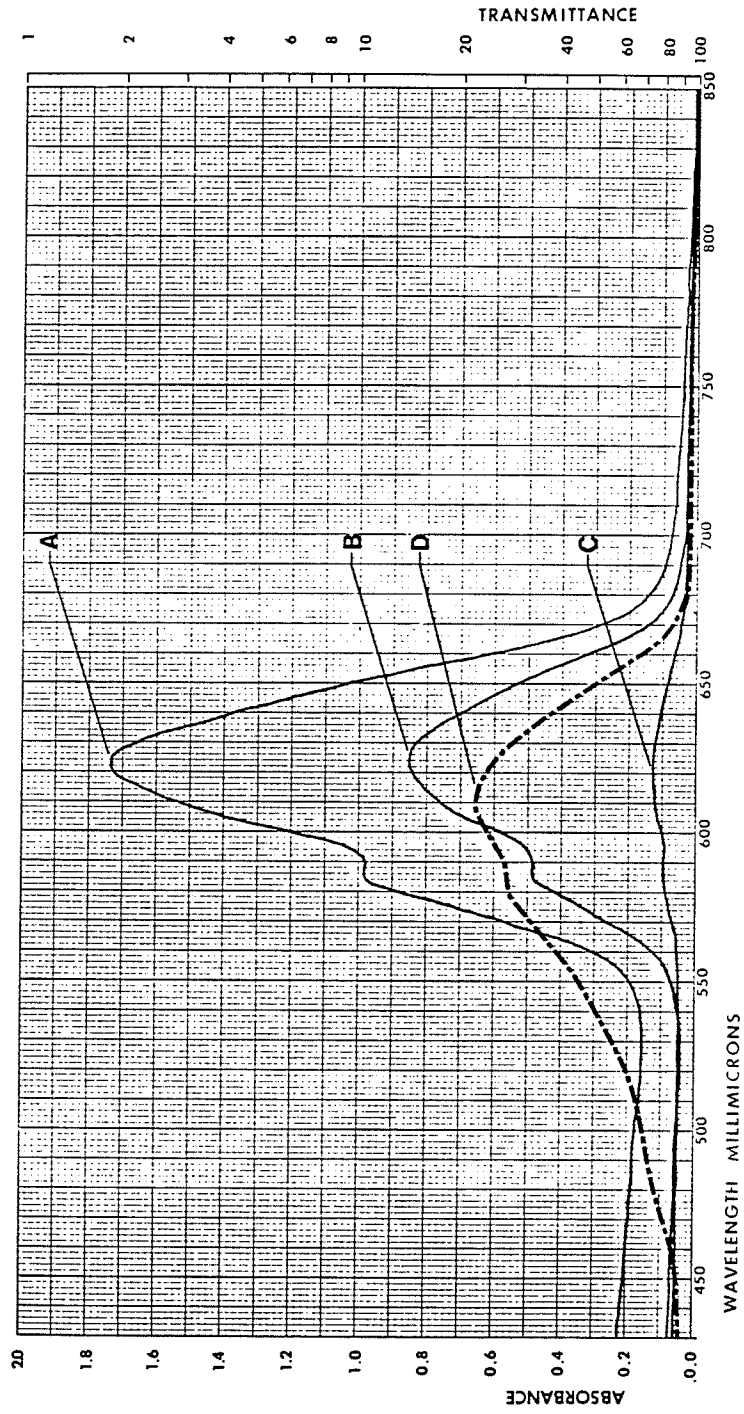

Figure 2-30

Electronic absorption spectrum of cobalt-thiocyanate complex sorbed by three polyurethane film types and in aqueous solution. Pieces of each type 2.0 x 3.0 cm in size were exposed for various periods of time with constant stirring to 100 mL of a solution containing 8.5×10^{-4} M Co(II), 5.00 M KSCN and 1.0 M $\text{NaOOCCH}_3/\text{HOOCCH}_3$ buffer. The curves shown are identified as follows:

- A Tuftane 410, 0.038 mm thick
25.2 hours
- B Tuftane 312, 0.025 mm thick
143.0 hours
- C MP 1880, 0.13 mm thick
125.0 hours
- D Aqueous Co(II)/SCN⁻/buffer
solution used
(1.0 cm cuvet path length)



species is apparently $\text{Co}(\text{SCN})_4^{2-}$ as was suggested to be the case for polyurethane foam, as well.

The last curve (D) in Figure 2-30 is the absorption spectrum of the 8.5×10^{-4} M Co(II), 5.00 M KSCN, 1.0 M $\text{NaOOCCH}_3/\text{HOOCCH}_3$ solution with which these films were equilibrated. From the spectrum, it is evident that species other than $\text{Co}(\text{SCN})_4^{2-}$ are also present in the aqueous phase at room temperature (since the spectrum of $\text{Co}(\text{SCN})_4^{2-}$ in water is very similar to that in organic solvents⁽²¹⁵⁾). This is as predicted by some of the relative ion abundances calculated in Table II-14 for the thiocyanate and other species.

The infrared spectrum of the thinnest of the film types (Tuftane 312, 0.025 mm in thickness) was also obtained before and after 143.0 hours of contact with both the 1.00 M and 5.00 M KSCN/Co(II)/buffer solutions. In the case of the 1.00 M KSCN solution, very little change in the spectrum was noted to have taken place, paralleling the lack of visible absorption at 623 nm. However, in Figure 2-31 we see that from 5.00 M KSCN solution, a large absorption band at $4.87 \mu\text{m}$ (2055 cm^{-1}) was observed as well as a much smaller one at $20.8 \mu\text{m}$ (480 cm^{-1}). These absorptions are consistent with the identification of the sorbed cobalt-containing species as $\text{Co}(\text{SCN})_4^{2-}$ (or, more properly, as $\text{Co}(\text{NCS})_4^{2-}$ taking linkage isomerism - which we have consistently ignored so far - into account). To support this, Lewis *et al.*⁽¹⁸⁵⁾ have observed an intense C-N stretching band at $4.82 \mu\text{m}$ (2076 cm^{-1}) for $\text{K}_2\text{Co}(\text{NCS})_4 \cdot 4\text{H}_2\text{O}$ in acetophenone solution and an $-\text{N}=\text{C}=\text{S}$ bending mode of moderate intensity at $21.0 \mu\text{m}$ (475 cm^{-1}) in either solution or mull. Heitner-Wirguin and Ben-Zwi⁽²⁴⁷⁾ report the C-N stretching frequency to be $4.85 \mu\text{m}$ (2060 cm^{-1}),

Figure 2-31

Infrared spectrum of Tuftane 312 (0.025 mm) polyurethane film containing cobalt species absorbed over 143.0 hours from an aqueous solution containing 8.5×10^{-4} M Co(II), 5.00 M KSCN and 1.0 M NaOOCCH₃/HOOCCH₃ buffer. The regions of the spectrum which were not visible in the absence of absorbed cobalt are shaded.

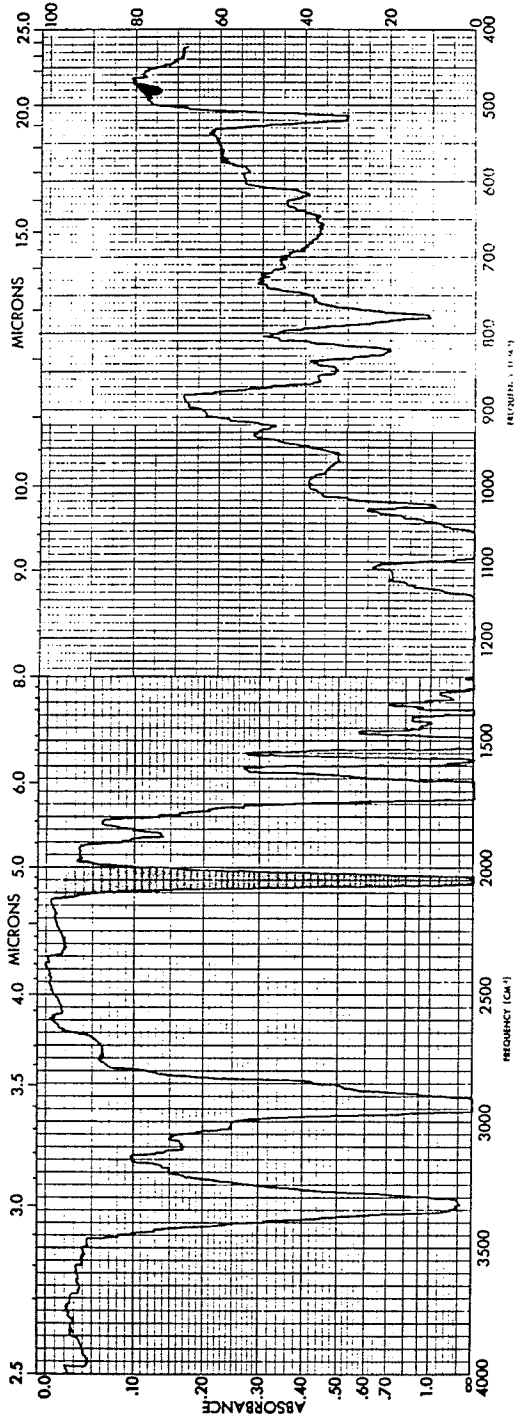

in much closer agreement with our observations. Another absorption reported by these authors at $116 \mu\text{m}$ (860 cm^{-1}) would likely have been too weak and obscured by the polymer spectrum to be visible here.

Having established from the preliminary results both the absorbing species and the relative extracting abilities of several polyurethane membrane types, a few experiments were then devised to test the transport of cobalt-thiocyanate from one solution through a membrane and into another solution on the other side. For this purpose, a special Pyrex glass membrane diffusion cell (Figure 2-32) was used as in the work of others^(42,48,156). The apparatus was assembled by cutting a piece of the membrane material to be larger than the ground glass flange opening on one side of the equipment and sealing it to the ground surface with high vacuum silicone grease. The other half, also bearing silicone grease on its ground surface, was then fitted to this, the excess membrane cut away and the two halves fixed together with a stainless steel split ring clamp (not shown). Teflon stirring bars were inserted and the ground glass stoppers were lightly greased before inserting the cell into a thermostatted water bath ($25 \pm 1^\circ\text{C}$) to test for leaks and to come to thermal equilibrium in preparation for their use.

In the experiments, different solutions were prepared to fill the two halves, "A" and "B" of the diffusion cell. In side "A" (the starting flask) a solution containing Co(II), ^{60}Co tracer, KSCN and a $\text{NaOOCCH}_3/\text{HOOCCH}_3$ buffer was placed while side "B" (the receiving flask) contained only the buffer. One liter volumes of each type were prepared and placed in the thermostatted water bath for 12 hours prior to begin-

Figure 2-32

Pyrex glass cell used in membrane diffusion experiments. The polyurethane membrane was sandwiched between the two halves of the large ground glass flange at the middle and sealed to each around the edges with high vacuum silicone grease. An external stainless steel ring clamp (not shown) secured the two halves to one another. Each half had a capacity of nearly 1 L.

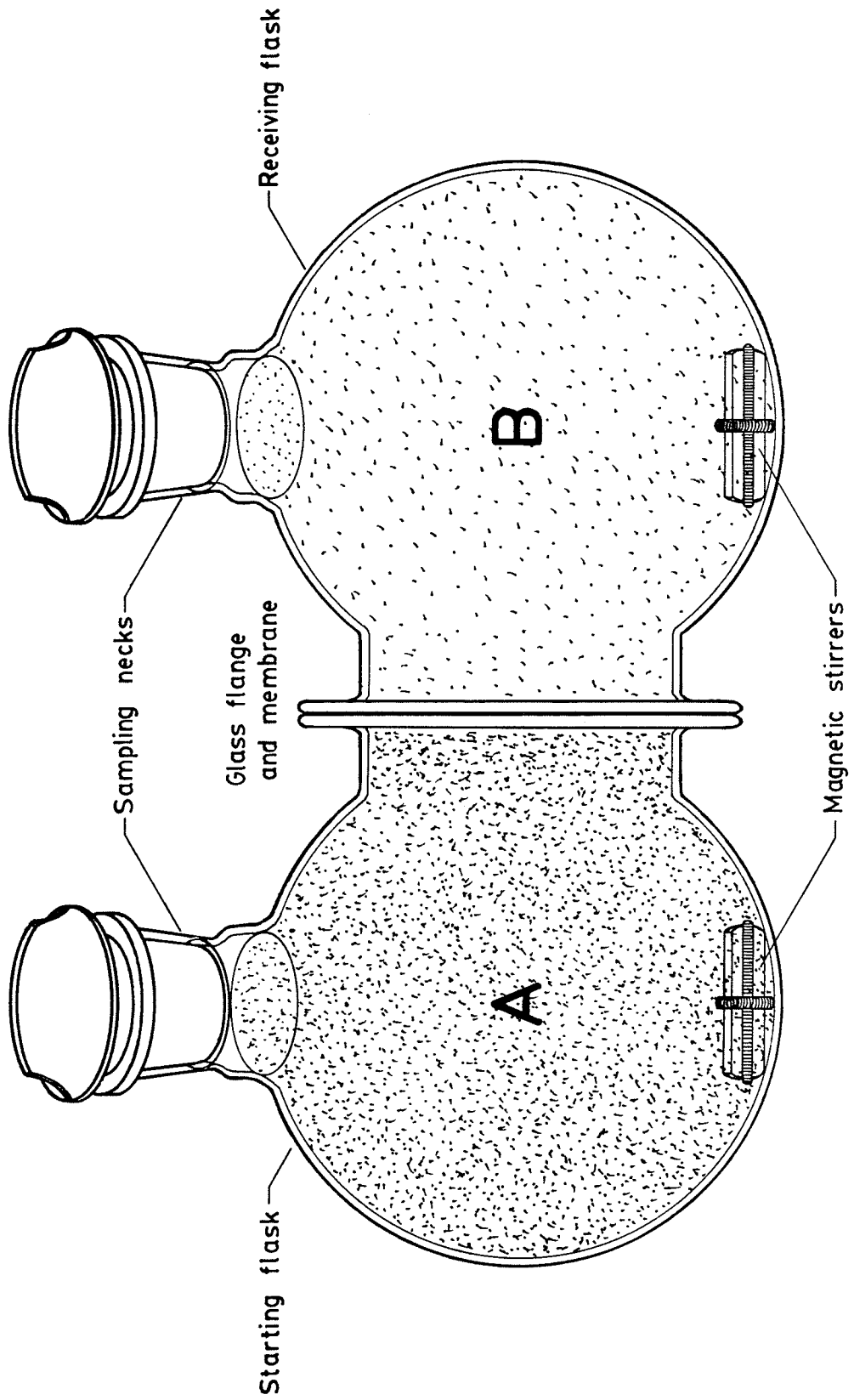

ning the experiment in order to come to thermal equilibrium.

To begin the experiment, samples were first removed into calibrated 15.0 mL test-tubes for non-destructive analysis by repetitive radioactive counting (ten 100 second intervals in most cases but occasionally twenty intervals where activity levels were quite low). The counted solutions were returned to the flasks then the two halves of the diffusion cell were filled in stages to give equal heights of liquid on both sides (but not necessarily exactly equal volumes). The volume of liquid delivered to each side was measured as it was dispensed and these volumes were recorded for comparison with what remained at the completion of the experiment.

Visual observations of the progress of diffusion during the experiment were made periodically over many days and 15.0 mL samples were withdrawn for counting in the same test-tubes as were used for the initial measurements. The measured activities were employed to calculate the concentrations of cobalt on both sides of the membrane after corrections for background and ^{40}K activity were applied.

Three attempts were made to observe diffusion of cobalt through polyurethane with different film types, cobalt concentrations and thiocyanate concentrations. The first two, using polyurethane with a poor affinity for the cobalt complex and/or lower thiocyanate concentrations were terminated after only 9 or 10 days had elapsed. The third one, which was much more informative, was continued for nearly one month.

The results of the experiments are displayed in Table II-25 where the corrected solution activities and cobalt concentrations on either side of the membrane are shown as a function of the time elapsed from

TABLE II-25 DIFFUSION OF COBALT THROUGH POLYURETHANE MEMBRANES

Experiment 1

Initial Conditions:

Membrane Type	MP 1880/Natural	
Thickness	1.3 x 10 ⁻² cm (0.005 inch)	
Area	50 cm ²	
Temperature	25 ±1°C	
pH	4.8 (1.0 M Na acetate buffer)	
	<u>Starting Side</u>	<u>Receiving Side</u>
[Co]	1.7 x 10 ⁻⁵ M (1.0 ppm)	0
[SCN ⁻]	1.0 M (KSCN)	0
Ionic Strength (I)	2.0 M	1.0 M
Solution Volume (V)	940 mL	780 mL

Sample Number	Elapsed Time (days) ±0.004	Starting Side		Receiving Side	
		Solution Activity (dps)	Cobalt Concentration (ppm)	Solution Activity (dps)	Cobalt Concentration (ppm)
1	0.000	207.3 ±1.5	1.000 ±0.007	0.03 ±0.19	0.0014 ±0.0009
2	0.031	206.4 ±0.8	0.996 ±0.004	0.12 ±0.12	0.0006 ±0.0006
3	0.201	206.7 ±0.8	0.997 ±0.004	0.02 ±0.18	0.0001 ±0.0009
4	1.045	207.3 ±1.4	1.000 ±0.007	0.02 ±0.20	0.0001 ±0.0010
5	2.045	206.3 ±1.1	0.995 ±0.005	0.06 ±0.15	0.0003 ±0.0007
6	4.031	207.6 ±1.1	1.002 ±0.005	0.10 ±0.16	0.0005 ±0.0007
7	10.021	205.3 ±1.1	0.990 ±0.005	0.19 ±0.22	0.0009 ±0.0011

TABLE II-25 - continued

Experiment 2

Initial Conditions:

Membrane Type	Tuftane 410/Natural
Thickness	3.8 x 10 ⁻³ cm (0.0015 inch)
Area	50 cm ²
Temperature	25 °C
pH	4.8 (1.0 M Na acetate buffer)
	<u>Starting Side</u> <u>Receiving Side</u>
[Co]	8.5 x 10 ⁻⁴ M (50 ppm) 0
[SCN]	2.0 M (KSCN) 0
Ionic Strength (I)	3.0 M 1.0 M
Solution Volume (V)	945 mL 770 mL

Sample Number	Elapsed Time (days) ±0.004	Starting Side		Receiving Side	
		Solution Activity (dps)	Cobalt Concentration (ppm)	Solution Activity (dps)	Cobalt Concentration (ppm)
1	0.000	131.1 ±0.7	50.00 ±0.28	0.19 ±0.16	0.07 ±0.06
2	0.018	131.6 ±1.1	50.2 ±0.4	-	-
3	0.125	131.5 ±0.8	50.14 ±0.31	-	-
4	0.370	132.0 ±0.7	50.32 ±0.28	-	-
5	0.950	131.2 ±0.8	50.00 ±0.31	0.12 ±0.14	0.04 ±0.05
6	1.943	131.7 ±1.0	50.2 ±0.4	0.15 ±0.19	0.06 ±0.07
7	2.964	131.4 ±0.9	50.1 ±0.4	0.39 ±0.14	0.15 ±0.05
8	3.957	131.4 ±0.5	50.11 ±0.19	0.30 ±0.14	0.12 ±0.06
9	5.992	131.3 ±0.8	50.06 ±0.32	0.15 ±0.14	0.06 ±0.05
10	8.929	130.8 ±1.1	49.9 ±0.4	0.27 ±0.18	0.10 ±0.07

TABLE II-25 - continued

Experiment 3

Initial Conditions:

Membrane Type	Tuftane 410/Natural	
Thickness	3.8 x 10 ⁻³ cm (0.0015 inch)	
Area	50 cm ²	
Temperature	25 ±1°C	
pH.....	4.8 (1.0 M Na acetate buffer)	
	<u>Starting Side</u>	<u>Receiving Side</u>
[Co]	8.5 x 10 ⁻⁴ M (50 PPM)	0
[SCN]	5.00 M (KSCN)	0
Ionic Strength (I)	6.0 M	1.0 M
Solution Volume	939 mL	745 mL
	Total = 1684 mL	
Final Solution Volume	1130 mL	531 mL
	Total = 1661 mL	

Sample Number	Elapsed Time (days) ±0.004	Starting Side		Receiving Side	
		Solution Activity (dps)	Cobalt Concentration (ppm)	Solution Activity (dps)	Cobalt Concentration (ppm)
1	0.000	141.6 ±0.9	50.00 ±0.33	0.00 ±0.16	0.00 ±0.06
2	0.097	139.8 ±0.8	49.38 ±0.28	-	-
3	0.306	138.7 ±0.6	48.98 ±0.22	0.000 ±0.009	0.0000 ±0.0032
4	0.847	136.5 ±0.8	48.21 ±0.27	1.14 ±0.21	0.40 ±0.07
5	1.853	133.1 ±0.9	47.02 ±0.30	4.38 ±0.17	1.55 ±0.06
6	3.853	126.0 ±1.0	44.50 ±0.34	12.21 ±0.24	4.31 ±0.08
7	5.875	117.0 ±0.7	41.34 ±0.23	23.36 ±0.35	8.25 ±0.12
8	7.898	108.0 ±1.0	38.14 ±0.36	34.22 ±0.24	12.08 ±0.08
9	9.888	98.4 ±0.8	34.76 ±0.30	47.0 ±0.4	16.61 ±0.15
10	11.901	82.4 ±0.6	29.12 ±0.20	67.9 ±0.6	23.98 ±0.21
11	14.058	61.6 ±0.4	21.74 ±0.15	94.9 ±0.9	33.52 ±0.33

TABLE II-25 - continued
 Experiment 3 - continued

Sample Number	Elapsed Time (days) ± 0.004	Starting Side		Receiving Side	
		Solution Activity (dps)	Cobalt Concentration (ppm)	Solution Activity (dps)	Cobalt Concentration (ppm)
12	15.877	45.0 ± 0.6	15.88 ± 0.21	118.1 ± 0.7	41.72 ± 0.24
13	17.891	28.03 ± 0.32	9.90 ± 0.11	143.8 ± 1.0	50.8 ± 0.4
14	19.943	13.2 ± 0.4	4.65 ± 0.13	167.9 ± 0.9	59.31 ± 0.30
15	21.832	4.69 ± 0.20	1.66 ± 0.07	191.4 ± 1.2	67.6 ± 0.4
16	23.783	1.48 ± 0.19	0.52 ± 0.07	210.7 ± 1.2	74.4 ± 0.4
17	25.971	0.2 ± 0.4	0.06 ± 0.14	229.8 ± 1.2	81.2 ± 0.4
18	27.867	0.14 ± 0.17	0.05 ± 0.06	242.6 ± 1.5	85.7 ± 0.5

the beginning of the experiment. In Experiment 1 (which actually preceded the preliminary investigations to find the most suitable film type), we see that no measurable ^{60}Co disappeared from the solution in the starting flask and none appeared in the receiving flask after 10 days of equilibration when 1.0 ppm Co(II), 1.0 M KSCN and MP 1880 polyurethane film were used. This lack of measurable change was accompanied by a matching lack of visual alteration (although at 1.0 ppm Co(II) is not easily visible in solution).

To concentrate the radioactive waste prior to disposal, a single 50 mg piece of #1338 BFG polyurethane foam was added to the starting side of the diffusion apparatus. After two days of stirring, approximately 95% of the solution activity was found to be mopped up by the foam piece. This clearly demonstrates the difference in behaviour between the MP 1880 material and that of polyurethane foam since although there was actually about 980 mg of polyurethane membrane here with a surface area comparable to that of the 50 mg foam piece, no cobalt was absorbed by the film over a 10 day period.

After some of the preliminary experiments had demonstrated the poor performance of MP 1880 for cobalt sorption, Experiment 2 was begun using Tuftane 410 instead, at a higher thiocyanate concentration (2.0 M) and at 50.0 ppm Co(II) concentration (so observations could be made more readily). From Table II-25, however, it will be apparent that once again very little, if any, ^{60}Co was removed from the starting side or appeared in the receiving side of the diffusion apparatus. Visual observation, nevertheless, revealed that a very faint green colour was transferred from the bluish-pink starting solution to the polyurethane film and the

presence of slight ^{60}Co activity was measured on it following termination of the experiment after 9 days. Evidently, though, 2.0 M SCN^- was insufficient to produce appreciable absorption or diffusion of any cobalt-containing species.

Another experiment (Experiment 3) was thus devised in which the aqueous thiocyanate concentration was increased substantially to 5.00 M while other parameters were maintained similar to Experiment 2. The results, as listed in Table II-25 and plotted in Figure 2-33 show that, as expected, under these conditions cobalt is removed from the starting side and transported at an appreciable rate to the receiving side until the transfer is essentially quantitative (>99.5% after 28 days).



During the course of this experiment, several very interesting observations were made. First of all, the starting solution was, in this case, blue in colour indicating the presence of significant amounts of tetrahedral Co(II) species. The polyurethane film, moreover, became bright blue-green within the first few hours of exposure and remained this colour (with gradual reduction in intensity) throughout most of the duration of the experiment. As time progressed, the blue colour of the starting solution disappeared and it eventually became colourless while the receiving side acquired a discernible pink colour after being initially colourless.

The membrane itself was also observed to undergo definite physical changes during the experiment. After 12 or so days, it began to bulge noticeably into the receiver side of the apparatus until it was very markedly distorted at the conclusion of the experiment. Examination of the membrane after dismantling the apparatus showed that,

Figure 2-33

Concentration/time profile of cobalt-thiocyanate diffusion through Tuftane 410 polyurethane membrane of 0.038 mm thickness and 50 cm² area. The initial solution conditions were as follows:

pH 4.8 (1.0 M NaOOCCH₃/HOOCCH₃ buffer)
Temperature 25 ± 1°C

	<u>Starting Side</u> 	<u>Receiving Side</u> 
[Co]	8.5 x 10 ⁻⁴ M (50 ppm)	0
[SCN ⁻]	5.00 M (KSCN)	0
Ionic Strength	6.0 M	1.0 M
Solution Volume	939 mL	745 mL

For an explanation of the regions (A, B, C and D) see text.

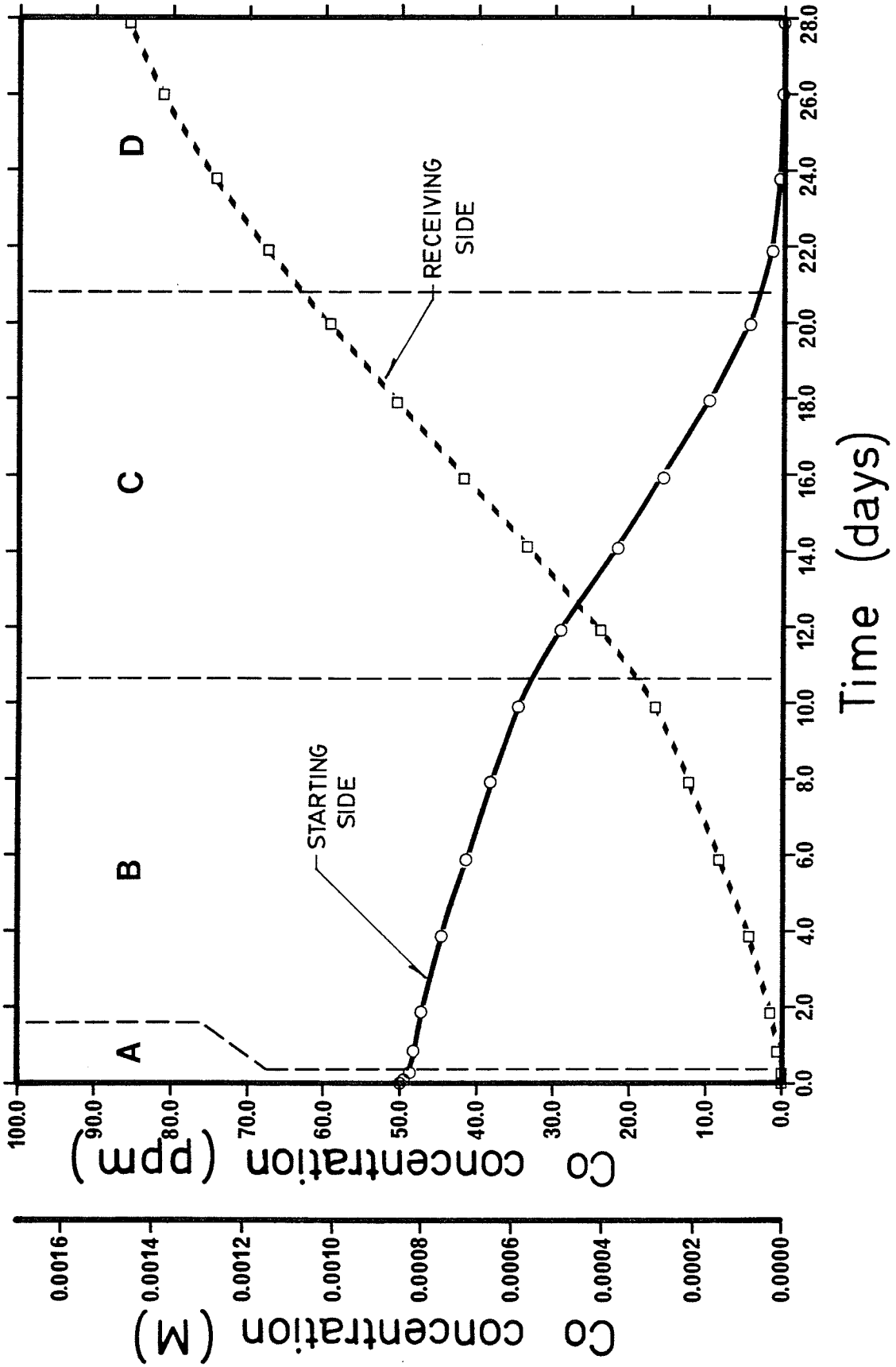

although no weakening of the polymer was apparent, this change in physical shape was permanent and that the polyurethane had transformed itself from being faintly amber and nearly transparent to being white and opaque. Accompanying this deformation of the membrane, there was a substantial transfer of water (measured to be approximately 200 mL) from the receiving side of the apparatus to the starting side thus necessitating the bulging.

In developing an explanation for the observed behaviour, we may first draw upon the preliminary observations (Figure 2-30) which demonstrate that the cobalt species sorbed by Tuftane 410 from 5.00 M KSCN solution is most likely $\text{Co}(\text{SCN})_4^{2-}$ (in company with some cations, M^+ , of course). Thus, the first two steps in the process are the formation of this species and its extraction into the polymer:

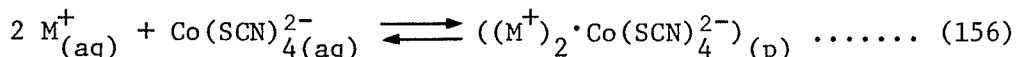
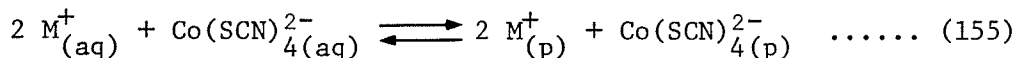
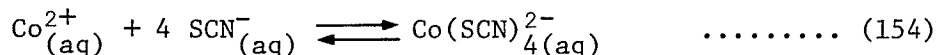

where the subscripts aq and p refer to species present in the aqueous and polymer phases, respectively. We are uncertain whether the ionic species will be appreciably ionized (equation (155)) or associated with one another (equation (156)) in the polymer phase but this is not greatly important here.

The complex formation equilibrium (equation (154)) is very rapid

and so will not influence the comparatively slow rate of absorption. For a period of time, therefore, the blue $\text{Co}(\text{SCN})_4^{2-}$ ion is absorbed at some rate from solution by the polyurethane and diffuses into the bulk of the polymer until it begins to approach saturation. During this time, no appreciable amounts of cobalt reach the opposite side of the membrane and are discharged into the receiving side. This phase, occupying about 6 to 8 hours of time, is identified as region A in Figure 2-33 and is characterized by a fairly rapid drop in cobalt concentration on the starting side but no change in the receiving side as the polyurethane membrane becomes "charged" with the absorbed species. Once nearly filled, significant transfer of the cobalt to the receiver begins by the reverse of equations (154-56) since there is no appreciable SCN^- ligand there. The nearly constant rate of cobalt transfer during this diffusion phase (region B of Figure 2-33) is presumably controlled jointly by the rates of absorption, diffusion and desorption (with diffusion likely being the slowest).

However, a further complicating phenomenon begins to become apparent after approximately 10 days of diffusion (region C of Figure 2-33) since here we observe an increase in the rate at which the cobalt concentrations are altered on the two sides of the membrane. As noted from the observations, this coincides with the perception of membrane bulging and has been related to the eventual transfer of approximately 200 mL of water from the receiving to the starting side. It seems, therefore, that the polyurethane membrane has suffered morphological changes to become semi-permeable during the transport of cobalt so that osmosis of water occurs in the opposite direction (from the receiving side, where the ionic strength is 1.0 M, to the starting side, where it is 6.0 M).

Thus, some of the hastened concentration changes observed in this region are attributable to this transfer of solvent from one side to the other although we also expect improved cobalt diffusion as a result of the larger surface area and decreased thickness of a bulged membrane.

Similar phenomena of osmosis and membrane bulging were also reported by Gesser et al.⁽¹⁵⁶⁾ for the transport of Ga, Fe(III) and U(VI) and were noted to occur only after some diffusion of metal complex had taken place. This strongly suggests that the presence of sorbed metal complexes results in a relaxation of the inter-chain forces (plasticization) in the polymer during which they are free to adopt new relative orientations as imposed by invading water molecules. Thus, a series of "channels" through which water may pass are formed and would likely remain until complete drying of the polymer or thermal disruptions resulted in a reversion to specific inter-chain associations or to randomness.

There is no distinct boundary between regions C and D in Figure 2-33; however a distinction is made to illustrate the fact that nearly all metal transport is concluded after some period of time and the largest contribution to concentration changes thereafter (region D) is simply by the osmotic movement of water. As we see from Figure 2-33, this concentrating by loss of water of the receiving side solution has resulted in a substantial increase in the final cobalt concentration reached there (about 85 ppm) as compared with the initial concentration on the starting side (50 ppm). It should be pointed out that although this additional concentrating ability is probably desirable in a number of applications, it could likely be eliminated along with membrane bulg-

ing by choosing starting and receiving solutions which are isotonic.

The polyurethane membrane diffusion phenomenon has obvious potential industrial applications in the extractive processing of mine liquors or even of sea water. However, due to the relatively long times required, analytical applications might be expected to be limited to cumulative monitoring problems (such as, perhaps, in the vicinity of industrial outfalls along the ocean coastlines or in specific marine locales such as oyster beds or fishing grounds). Unfortunately, the oceans do not contain sufficient thiocyanate ions to make the monitoring of cobalt amenable to this type of application but a number of other metals which readily form extractable chloro complexes (e.g. Au(III) or Hg(II)) would be natural alternatives to test.

D. INTERPRETATION

Having presented the experimental information obtained concerning the extraction of cobalt-thiocyanate by polyether-based polyurethane foam, we will now describe what we feel to be the most probable mechanism for the phenomenon which is consistent with the data. It will by now be no secret that the mechanism to be put forward is the Cation Chelation Mechanism (CCM) which was outlined only very briefly in the Introduction. This mechanism has not previously been suggested or proposed to account for the extraction behaviour of polyurethanes and before unveiling the concept completely, it is first necessary to consider some background information about the chemical and physical properties of polyethers in general.

1. The Chemical and Physical Properties of Cyclic and Noncyclic Polyethers

Basically, polyethers are molecules of the general form $R'-O(R-O)_nR''$ which contain alternating alkyl (R) and ether (-O-) groups repeated regularly in a cyclic or linear chain. The value of n may range anywhere from as little as 2 to several millions and the ends of the polymer (R' and R'') may bear hydrogen atoms or various alkyl or aryl groups or may be joined together in the case of a cyclic polyether. The wide range of n as well as the variety of potential identities for R, R' and R'' (and the possible inclusion of other occasional groupings) ensure that the number of compounds included in this classification is very large. Polyethers of the noncyclic type have been in manufacturing and chemical use

for quite some time but the cyclic types proved to be the key to understanding some of the peculiar properties of their noncyclic relatives. We will therefore first discuss cyclic polyethers before moving on to a consideration of the noncyclic variety.

a. Cyclic Polyethers

Cyclic polyethers (or, more properly, "macrocyclic" polyethers - to distinguish them from small molecules such as tetrahydrofuran) are those which contain a minimum of two and usually at least four ether (-O-) groups in the form of a ring. A large number of these compounds, mostly of the type shown as compound I below, have now been prepared and discovered to have very interesting cation binding properties. The pioneer

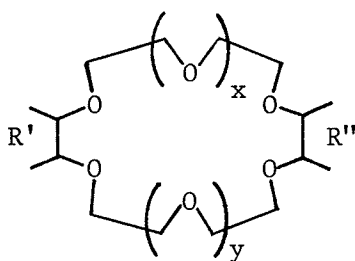

compound I - a cyclic polyether

in the field of both their synthesis and complexing abilities was Charles J. Pedersen of E. I. DuPont de Nemours and Company who in 1967 announced^(248, 249) the preparation and metal salt complexing properties of thirty-three such cyclic polyethers given the collective title of "crown ethers". The standard nomenclature of these compounds is very cumbersome so Pedersen proposed a trivial naming system consisting of one or more prefixes describing the R' and R'' groups, followed by the number of atoms in the ring structure, then the word "crown" (to describe

the geometrical shape of the ether ring) and, finally the number of oxygen atoms in the ring. For instance, compound II below would have either

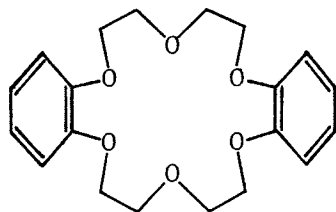

compound II - dibenzo-18-crown-6

the recommended IUPAC name of 2,3,11,12-dibenzo-1,4,7,10,13,16-hexaoxacyclooctadiene or the trivial name of dibenzo-18-crown-6.

Many of the crown ethers were discovered by Pedersen to form stable complexes with some or all of the cations Li^+ , Na^+ , NH_4^+ , RNH_3^+ , K^+ , Rb^+ , Cs^+ , Ag^+ , Au^+ , Ca^{2+} , Sr^{2+} , Ba^{2+} , Cd^{2+} , Hg^+ , Hg^{2+} , La^{3+} , Ce^{3+} , Tl^+ and Pb^{2+} when they contained from 5 to 10 oxygen atoms in the ring. From these, a simple 1:1 stoichiometry was found to exist between the cations and the crown ethers regardless of the valence of the ion. The author interpreted the complex formation as arising from ion-dipole interactions between single cations fitting within the cavity of the ring and the coplanar oxygen atoms of that ring (as shown below for the complex of Ba^{2+} with dicyclohexyl-18-crown-6).

One of the primary factors governing the ability of the crown ether-cation pairs to form a complex was said to be the relative sizes of the ion and the central cavity of the crown with complexation of only those ions which fit snugly within the cavity being very strong. However, a number of other considerations such as the number and symmetry of placement of the O-atoms in the ring, any steric hindrance produced by substit-

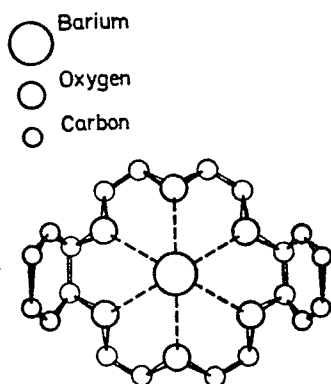

Complex of Ba^{2+} with dicyclohexyl-18-crown-6⁽²⁵⁰⁾

uents on the R' and R'' groups, the basicity of the ether oxygen atoms (as influenced by these substituents), association of the ion with solvent molecules and its electrical charge were all said to be important in determining whether or not a stable complex would be formed. Approximately six oxygen atoms in the ring were usually found to be optimum in accomplishing the task with declines in complexation accompanying much larger and particularly smaller ring sizes (into which larger cations were then unable to fit).

Several later publications by Pedersen and his coworker, H. K. Frensdorff⁽²⁵¹⁻⁵⁶⁾ expanded both the lists of crown ethers available (to more than sixty) and the number and types of cations noted to form complexes with them. In these works, comparative studies were undertaken in which several primary alkylammonium ions, RNH_3^+ , were found to be effectively complexed and hydrogen bonded by the crown ethers by intruding the $-NH_3^+$ moiety into the cavity of the crown ether while the corresponding secondary ($R_2NH_2^+$), tertiary (R_3NH^+) and quaternary (R_4N^+) ammonium ions were not (apparently because of size and steric

hindrance effects). Although they were usually of somewhat lower stability, the possibility of forming some 2:1 ("sandwich") and 3:2 ("club sandwich") complexes (shown below) of small crown ethers with larger metal ions was also recognized and some of the compounds were isolated. It was

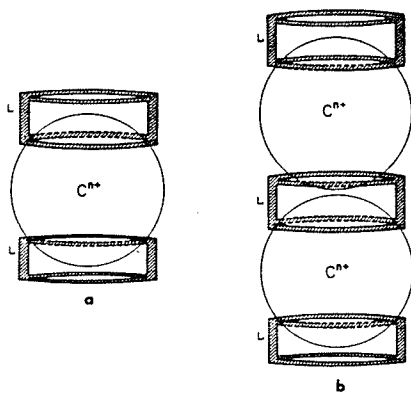

a) sandwich complex

b) club sandwich complex⁽²⁵⁷⁾

(C^{n+} = cation, L = crown ether ligand)

further pointed out that in all cases of cation complexation, the particular anion used greatly influenced the solubility in an organic solvent of the complexed cation-anion pair with only "soft" anions such as SCN^- , I^- , picrate and fatty acid anions being successfully accommodated. Very interesting applications to solubilizing and increasing the effectiveness of various polarizable anionic catalysts and oxidizing agents (such as $KMnO_4$ in benzene) were then suggested and a number of these are in current use.

The stability constants of all types of crown ether-cation complexes were found to be much higher (by 3 or 4 orders of magnitude) in an organic

solvent such as methanol compared to the case in water. In testing a series of related macrocyclic polyethers in which there were different numbers of carbon atoms between successive oxygen atoms in the ring, the authors noted that a $-\text{CH}_2\text{CH}_2-$ interval produced much stronger complexation than did either $-\text{CH}_2-$ or $-\text{CH}_2\text{CH}_2\text{CH}_2-$ (or longer) moieties. Further, comparisons between the cyclic polyethers and their noncyclic counterparts containing the same number of oxygen atoms showed much lower stability constants existing for the latter. However, some increases in the stability of metal complexes was observed when the ring size became quite large and this was explained by an ability, then, of the polyether to wrap around the cation to solvate it completely (as was not possible for the small coplanar "crown").

Following the initial and extensive pioneering work of Pedersen and Frensdorff, interest in the subject spread quickly around the world and many other researchers subsequently offered significant contributions. Although it would be neither possible nor appropriate to review all of these at this point, a very brief overview might be in order.

A number of additions were made⁽²⁵⁸⁻⁶²⁾ to the long list of complexes isolated containing a variety of metal ions, crown ethers and anions. On the other hand, measurement of the complex stability constants in water and several other solvents and solvent mixtures has been the subject of many publications⁽²⁶³⁻⁶⁸⁾. The general consensus reached by these works, is that the complex stabilities depend upon the relative sizes of both crown ether and cation and in some cases also on the cation-solvating properties of the solvent as well as steric effects produced by substituents present on the polyether.

Specific studies on the solvation of alkylammonium ions⁽²⁶⁹⁻⁷²⁾ and of hydrogen ions⁽²⁷³⁾ have also been reported for particular crown ethers and outline the importance of both size compatibility and hydrogen bonding on the strength of complex formation. Other authors have dealt primarily with the evaluation of thermodynamic parameters of complex formation and extraction⁽²⁷⁴⁻⁷⁶⁾ into organic solvents. Much information of a concrete nature has come primarily from x-ray crystal structure determinations^(250, 277) while infrared studies of the solids^(278, 279) or ultraviolet measurements on solution⁽²⁸⁰⁾ have also shed some light on the mechanism of complexation. On the other hand, a good theoretical treatment was offered by Marcus and Asher⁽²⁸¹⁾.

A number of practical applications of crown ethers to nearly all branches of chemistry and technology have been realized. However, some which are of more analytical interest to us deal with the separation of various metal ions by selective solvent extraction⁽²⁸²⁻²⁸³⁾ or column chromatography^(284, 285) of their crown ether complexes. Several other papers which compared the solvent extraction capabilities for several metal ions but which stopped short of an actual separation based on this process were also reported^(286, 287). Another procedure which incorporated the selective separation of sodium ion into neutron activation analysis has also been described⁽²⁸⁸⁾. In addition, considerable activity into the preparation of ion-selective electrodes based on crown ether and related complexes is also under way.⁽²⁸⁹⁾

The chemical attachment of crown ether complexing groups to various solid supports has also been described⁽²⁹⁰⁻⁹⁴⁾. These

polymers have been found to be more efficient extractants than are their monomeric analogues and show great promise for future use. Japanese investigators, in particular, are currently very active in this field.

Shortly after the disclosure of interesting binding capabilities of the crown ether complexes, an improvement in both selectivity and strength of complexation was achieved by Lehn and coworkers in their production of the "cryptates"⁽²⁹⁵⁻⁹⁶⁾. The complexing agents, "cryptands" (shown below) accomplish much the same complexing functions as do

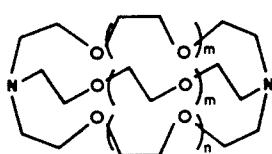

1	[1.1.1]	m+n=0
2	[2.1.1]	m+0,n=1
3	[2.2.1]	m+1,n=0
4	[2.2.2]	m+n=1
5	[3.2.2]	m+1,n=2
6	[3.3.2]	m+2,n=1
7	[3.3.3]	m+n=2

11

Lehn's "cryptands" showing ⁽²⁵⁷⁾ shorthand naming system

crown ethers except that these do so by completely surrounding the bound metal ions in a well-defined cavity. As for the crown ethers, the IUPAC nomenclature is cumbersome so Lehn adopted a shorthand naming system which includes only the number of oxygen atoms in the three polyether chains (as indicated above). Cryptate complexes of a variety of alkali, alkaline earth and transition metal complexes⁽²⁹⁷⁾ have been reported. Both oxygen and nitrogen atoms in the cage structure were found to be capable of participating in coordinating metal ions contained within the cavity. Some interesting equilibria between the two possible conformations of the

N atoms were noted (each may have its lone pair of electrons directed inward to or outward from the cavity)^(296, 298). Also, potentially useful protonation behaviour of the bridgehead nitrogen atoms was observed⁽²⁹⁹⁾ which may be employed to remove complexed ions and to improve discrimination between various metals. Although generally higher selectivities and complex strengths are available from the cryptand family of complexants than from crown ethers, the increased cost of preparation is a disadvantage to be considered.

Although we have presented only a very small (but fairly representative) fraction of the literature dealing with cyclic polyether (including cryptand) complexants, several excellent reviews have appeared in the literature from which more detail is available. One such which was published in 1974 by Christensen et al.⁽³⁰⁰⁾ is quite complete in that it discusses all aspects of cyclic polyether preparation and use. Another by Lévêque and Rossett⁽³⁰¹⁾ of approximately the same vintage confines itself to the analytical applications of the compounds. Both of these treatises are now slightly out of date, however, and have now been added to by Akabori⁽³⁰²⁾ (unfortunately, in Japanese) and by Kolthoff⁽²⁵⁷⁾. These last two reviews also concern themselves with analytical applications only. The latter work is especially recommended as being both complete and well-written.

b. Noncyclic Polyethers⁽³⁰³⁻³⁰⁴⁾

Having described some of the important complexing discoveries made with macrocyclic polyether compounds, we will now direct our attention toward the simpler noncyclic analogues of these compounds.

The polyethers in most common industrial use today are materials produced from ethylene oxide or propylene oxide to yield, respectively, the polymers shown below:

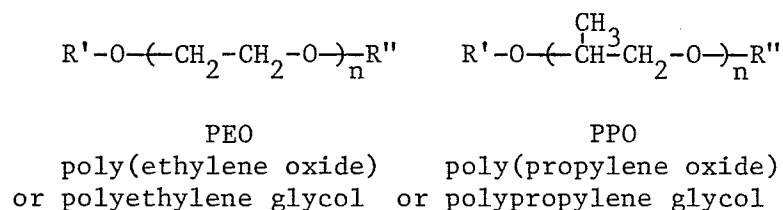

The values of n may extend from just a few to several millions while the identities of the R' and R'' groups may be quite varied ranging anywhere from H atoms (to give, therefore, polyols suitable for polyurethane manufacture) to large alkyl or aryl groups. As we have already suggested, the true complexing abilities of some of these compounds went largely unnoticed until the properties of their cyclic counterparts were elucidated.

Noncyclic polyethers, unlike their cyclic cousins, are comparatively inexpensive and have been available on an industrial scale in several products for quite some time. In fact, poly(ethylene oxide) or polyethylene glycol was first prepared in 1859 by Lourenco by heating ethylene glycol with ethylene dibromide in a sealed tube at 115-120°C. However, this method produces only fairly low molecular weight polymers and it was not until later (the 1930s) that longer chains and only in the 1950s that very high molecular weight polymers could be produced by different means. Poly(propylene oxide), PPO, is a relatively recent but cheaper addition to the list of commercially-produced polyethers.

The physical properties of the polyethers are of some interest. All

are stable, nonvolatile and odourless materials. The PEO polymers having molecular weights below about 700 daltons and nearly all of the PPO polymers are liquids at room temperature. Above 700 daltons, PEO polymers have increasingly higher melting points until a maximum of about 65°C is reached beyond a molecular weight of 7000-8000 daltons. The solubility characteristics of the two polyether types are also slightly different. PEO of low molecular weight (under 1000 daltons) is completely miscible with water and the solubility falls off quite slowly with increasing molecular weight at least up to 4000 daltons. On the other hand, while also completely water-miscible at low molecular weights (up to about 500-600 daltons), the solubility of PPO drops off quite rapidly thereafter so that it is nearly insoluble at 2000 daltons.

Aside from their applications as polyols for polyurethane manufacture (discussed earlier), PEO and PPO have a number of industrial and commercial uses. Poly(ethylene oxide), for example, finds a wide variety of direct applications in the pharmaceutical, cosmetics, textiles, agricultural and packaging industries as well as more indirect use in many others in which substantial liquid pumping is carried out.

As pharmaceuticals, the poly(ethylene oxides) of low molecular weight are used extensively in ointments, suppositories and as lubricants in the manufacture of compressed tablets. In cosmetics they are included in shaving creams, lotions, cakes, sticks, powders and hair dressings. Industrially, poly(ethylene oxide) finds use in "lost-wax" metal-casting and as mold release agents, pigment dispersants, polishes and lubricants. They are also employed extensively in textile manufacture as spinning lubricants, sizing formulations and as dye dispersants while, in other areas,

they are used as emulsifiers in agricultural sprays, nonionic surfactants in detergent manufacture, anti-static agents, humectants and plasticizers for starch adhesives and cellulose.

Poly(ethylene oxide) of higher molecular weight is used in small amounts to reduce dramatically the friction of water in turbulent flow situations (such as in fire hoses, for example). It is also formed into water-soluble films used in the packaging of products such as pesticides. Another application in use today is in the preparation of "seed tape" for the planting of very uniform rows necessary for mechanical harvesting equipment. The very high molecular weight products are effective flocculants for finely dispersed solids in water. In addition to all of these uses, however, the chemist will recognize poly(ethylene oxide) of various molecular weights as very common stationary phases for use in gas chromatography under the CARBOWAX trade name.

The poly(propylene oxide) polymers are employed primarily as intermediates in the preparation of many emulsifiers, alkyd resins and lubricants. PPO itself finds use as a lubricant, in hydraulic fluids and as a component of automotive brake fluid. Monoesters of poly(propylene oxide) are effective as nonionic surfactants useful in a number of applications.

The structures of these two polyethers are also of some importance to us. In the crystalline state, it has been determined⁽³⁰⁵⁾ by x-ray diffraction that poly(ethylene oxide) adopts a helical arrangement in which there are seven oxygen atoms and two turns of the helix contained in a unit cell (as shown below). The conformations of the $O-CH_2$, CH_2-CH_2

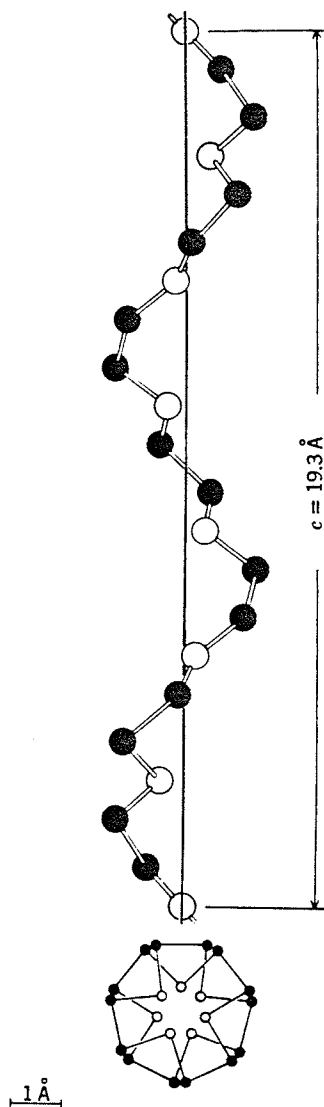

Skeletal model of poly(ethylene oxide) in the crystalline state⁽³⁰⁵⁾
(oxygen atoms are white, methylene groups black)

and $\text{CH}_2\text{-O}$ bonds in the polymer are, respectively, trans, gauche and trans.
On the other hand, poly(propylene oxide) crystallizes in a planar zigzag

configuration (see below) with a unit cell containing three such chains.

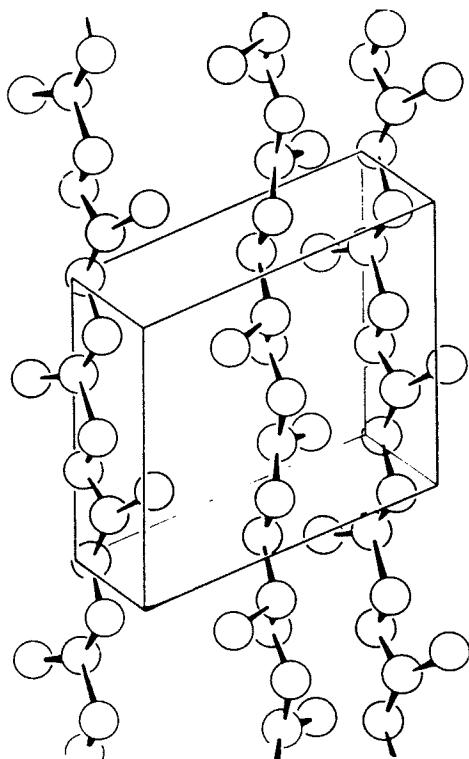

Crystal structure of poly(propylene oxide)⁽³⁰⁵⁾

Of course, although they reflect the lowest energy state to which these polyethers would tend, these structures do not necessarily indicate the conformations adopted under conditions other than the crystalline state. In particular, in the liquid state the C-C and C-O bonds in the PEO chain

apparently become⁽³⁰⁶⁻³⁰⁷⁾ nearly randomly oriented in trans and gauche conformations and so the helical structure is lost. A similar disordered structure has also been shown⁽³⁰⁷⁾ to exist in chloroform solutions. However, in water, much more of the crystalline helical structure is observed to be retained⁽³⁰⁷⁾ and so we expect at least some helical segments under conditions in which water is the only solvent present. Poly(propylene oxide), on the other hand, is apparently much less disposed to adopt the form of a helix under any conditions, preferring the planar zigzag arrangement in which alternate oxygen atoms point in opposite directions instead.

We will now consider the complexing behaviour of the noncyclic polyether family. Although isolated examples of interactions between these compounds and a few metal ions have been known for some time, only after the disclosures of Pedersen^(248,249) did further systematic investigations and a unified interpretation begin to emerge. Some of the impetus to study noncyclic polyethers has arisen strictly from a desire to understand the complexing abilities of the cyclic molecules better and perhaps to produce cheaper noncyclic analogues which would behave in the same manner. Some further interest has developed as a result of the need to reassess the mechanisms of old methods developed for the analysis of commercially-prominent polyethers and a few related topics.

Beginning first with the experiments devised to test short-chain analogues of cyclic crown ethers, a number of workers^(285, 308-311) have studied molecules containing about 4 to 6 ethylene oxide units terminated at both ends with groups capable of participating in cation

coordination by virtue of oxygen or nitrogen atoms present there. An example of such a noncyclic ether with complexing end groups is shown below. These compounds are found to form fairly strong complexes with alkali and alkaline earth metal ions and are viewed to chelate the cation in a spiral wrap-around fashion. X-ray crystal structures have been determined for a few of these complexes.⁽³¹²⁻¹⁵⁾ However, it has also been shown^(285, 308, 310-12, 316-17)

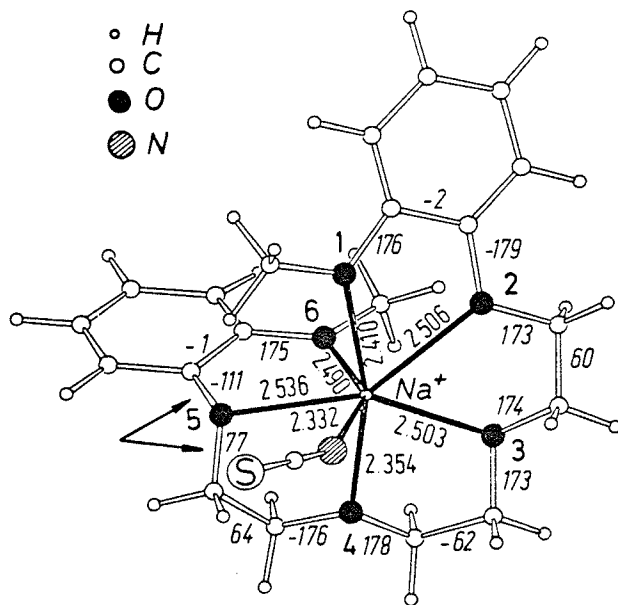

X-ray crystal structure of complex formed between NaSCN and $\text{CH}_3\text{OC}_6\text{H}_5(\text{OCH}_2\text{CH}_2)_3\text{OC}_6\text{H}_5\text{OCH}_3$ showing spiral arrangement of oxygen ligands⁽³¹⁵⁾.

that chains containing about 5 to 7 ethylene oxide units terminated at each end with a hydrophobic group (such as phenyl, naphthyl, etc.) which cannot participate in coordination so readily also produce complexes. These are once again imagined to form a spiralling ring type of complex but with the attraction between the hydrophobic groups being

responsible for holding the ends close together (see below).

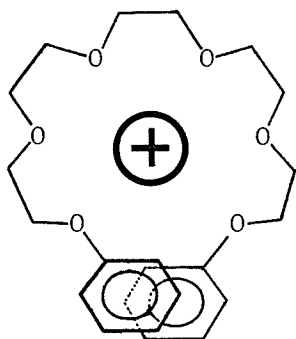

Noncyclic polyether complex of spiral type with hydrophobic (phenyl) end groups. Complexed cation is shown at center.

In both of the above cases, the degree of complexation for a particular metal ion was found to be fairly sensitive to the number of ethylene oxide units present in the chain with an optimum size existing for each. Although apparently leading to higher complex stability constants in the case of these short-chain polyethers, the presence of coordinating or hydrophobic end groups on the poly(ethylene oxide) chains was, however, found not to be a necessary requirement for complex formation⁽³⁰⁹⁾. A number of publications have been reported which describe metal ion complexation by polyethers with only one^(309,318-19) and many more with no⁽³¹⁸⁻²⁷⁾ attached end groups particularly where the poly(ethylene oxide) chain is made quite long⁽³²²⁻²³⁾. In fact, complexing strength comparable to that of the crown ethers has been noted for PEO with more than 23 ethylene oxide units⁽³²³⁾. Thus, taken together, the studies indicate that a minimum of about five to seven coordinating oxygen atoms are required to form complexes of reasonable stability with most metal ions and that the two ends of the

successful complexant must be kept from wandering either by being coordinated to the metal ion, by associating with one another or by being made sufficiently long.

Of further importance is the suggestion by some authors⁽³²⁶⁾ that the requirements of matching between polyether cavity size and ion diameter are not as absolute as Pedersen had implied probably due to the very high flexibility of the polyether chain and the realization of an "induced fit" therefore. This particular situation would apply, it seems, even more commonly to noncyclic than to small cyclic polyethers for which less freedom of conformation must exist. This is borne out by the observed⁽³¹⁶⁾ lower cation selectivity of the noncyclic polyethers compared to their cyclic counterparts. In addition, where comparisons between the abilities of polyethers based on poly(ethylene oxide) and poly(propylene oxide) have been made⁽³²³⁾, it has been found that the latter type does not achieve as great metal ion complexation as does the former although the complexes formed may be more extractable into an organic solvent⁽³¹⁹⁾.

Considering now the area of analysis of polyethers, several interesting papers have appeared dealing with the determination of nonionic surfactants in water (an important consideration regarding water quality). Of most concern to us are those which deal with the indirect uses of the cobalt-thiocyanate complex in the determination since these bear a very strong resemblance to the experiments at hand.

In this connection, van der Hoeve⁽³²⁸⁾ as long ago as 1948 proposed the use of a mixture of cobalt nitrate and ammonium thiocyanate as a reagent for the qualitative identification of poly(ethylene oxide), PEO,

compounds in water. According to his observations, the polymers of ethylene oxide assume a blue colour in the presence of both cobalt and thiocyanate ions which would remain unprecipitated for two hours (as distinct from the behaviour of some other compounds such as quaternary ammonium salts with which a blue precipitate was formed before this time). Although no interpretation of the phenomenon was offered, it was noted that PEOs which also contained a large group (such as the lauryl radical) at one end were even more effective in producing the blue colour.

A number of other qualitative and quantitative tests for nonionic surfactants were subsequently developed using such reagents as phosphomolybdate, silicotungstate, ferrocyanide and a few others. However, the cobalt-thiocyanate colour reaction was extended in 1955 (with modification) by Brown and Hayes⁽³²⁹⁾ to produce a usable quantitative method. These authors observed that the blue-coloured complex which formed in the presence of PEOs was stable with time and could be extracted into a number of organic solvents. Chiefly for reasons of ease of phase separation, chloroform was chosen as the solvent for the procedure and spectrophotometric measurement was made at either 620 nm or 318 nm. Although many amines, alkylammonium compounds and monoethers of PEO also produced an extractable blue colour, low molecular weight monoesters of PEO (such as triethyleneglycol monostearate) were tolerated without significant error. Temperature, however, was found to play an important part in the efficiency of extraction with definite decreases resulting above about 25°C. The authors suggested that the poly(ethylene oxide) most likely first produces a polyoxonium complex with NH_4^+ ions which then associates with

$\text{Co}(\text{SCN})_4^{2-}$ anions to which the blue colour was attributed.

Crabb and Persinger⁽³³⁰⁾ later adapted this procedure to the determination of nonionic surfactants at low concentrations in aqueous bacterial solutions used in biodegradation studies by adding a preliminary continuous ether extraction step to the procedure for preconcentration. It was found that the intensity of blue colour developed in the presence of the cobalt-thiocyanate reagent was quite dependent upon the length of poly(ethylene oxide) chain in the molecule with six such units apparently being the minimum number required. It was further pointed out that the presence of high salt (KCl) concentrations in the aqueous phase resulted in a drastic decrease in the efficacy of the initial ether extraction and that both very high and very low pHs were equally unsuitable. Based only on the apparent requirements of six ethylene oxide units, the authors surmised that the structure of the final coloured species consisted of a Co^{2+} cation octahedrally coordinated by the oxygen atoms of the poly(ethylene oxide) chain together with an accompanying blue $\text{Co}(\text{SCN})_4^{2-}$ anion for neutrality. Thus, for a nonionic surfactant, $\text{R-O}-(\text{CH}_2\text{CH}_2\text{O})_m\text{H}$, the extracted ion complex was envisioned as $[\text{Co}_n \text{R-O}-(\text{CH}_2\text{CH}_2\text{O})_{6n}\text{H}]^{2+} [\text{Co}(\text{SCN})_4^{2-}]_n$.

Morgan⁽³³¹⁾ next submitted a modification of the method of Brown and Hayes which increased the sensitivity of the analysis slightly by using benzene as the extracting solvent and by decomposing the extracted cobalt-thiocyanate-PEO complex prior to determination of cobalt by formation of the nitroso-R salt. Considerable differences in the sensitivity of the method as applied to different nonionic surfactants were again noted so that standardization against the same particular

type of surfactant was essential for quantitation.

Weber et al. ⁽³³¹⁾ made a further modification to the procedure of Brown and Hayes which allowed for some prior removal by mixed-bed ion exchange of both anionic and cationic surfactants also present in solution. The cobalt-thiocyanate colorimetric procedure was further altered to use 1,2-dichloroethane as the solvent of extraction and measurement.

Shortly after this in 1965, Greff et al. ⁽³³²⁾ presented a similar quantitative method based on cobalt-ammonium thiocyanate using benzene as extracting solvent with measurement at 320 nm. In this case, the aqueous phase was saturated with NaCl which was found to improve extraction somewhat. The reagent formed extractable blue complexes with PEO compounds containing three or more ethylene oxide units but with differences in sensitivity for different chain lengths. With less than about 2.5 ethylene oxide units per cobalt atom, no blue colour at all was developed or extracted. The authors concluded, as did Brown and Hayes ⁽³²⁹⁾, that the reaction probably involves formation of oxonium ions with NH_4^+ accompanied in extraction by the blue $\text{Co}(\text{SCN})_4^{2-}$ ion.

Shortly thereafter, Huddleston and Allred ⁽³³³⁾ made a reassessment of the applicability of the cobalt-thiocyanate spectrophotometric analytical method to biodegradation studies of nonionic surfactants. They pointed out that the disappearance of extractable blue complexes after a period of bacterial degradation did not always correlate with the surface tension and foaming observations on these solutions. The difference between the chemical and physical measurements was attributed to only partial degradation of some nonionic surfactants to the point that

they still had surface-active properties but contained insufficient ethylene oxide units (two or less) to produce the blue cobalt-thiocyanate complex.

Several years later, Courtot-Coupez and Le Bihan⁽³³⁴⁾ improved the method of Greff et al. further by fixing the solution pH (at 7.4) and by using atomic absorption rather than spectrophotometry as the means of determining cobalt extracted along with the nonionic surfactant and ammonium thiocyanate. The method was applied to the determination of nonionic surfactants in ocean water samples. Since it was observed that the extraction of cobalt into benzene was decreased at pH values below 7 and on the basis of some spectrophotometric measurements, they supported the proposal of Crabb and Persinger⁽³³⁰⁾ of some Co^{2+} ions octahedrally coordinated by the poly(ethylene oxide) and an equal number of cobalt atoms in the tetrahedral thiocyanate complex (i.e. $[\text{Co}_n \text{R-O}-(\text{CH}_2\text{CH}_2\text{O})_n \text{H}]^{2n+} [\text{Co}(\text{SCN})_4]_n^{2-}$).

Still later, Calzolari et al.⁽³³⁵⁾ obtained an empirical relationship between the average poly(ethylene oxide) chain length of the nonionic surfactants and the intensity of the blue colour extracted into 1,2-dichloroethane from $\text{Co}^{2+} - \text{NH}_4\text{SCN}$ solutions. The results were applied to the analysis of nonylphenyl ethers of PEO in hair dressings with the PEO chain length being determined independently by vapour-pressure osmometry.

At about the same time, Calzolari et al.⁽²⁴¹⁾ finally published the x-ray crystal structures of cobalt-thiocyanate complexes of closely related noncyclic polyethers which carried phenyl groups at each end (i.e. $\text{C}_6\text{H}_5\text{O}(\text{CH}_2\text{CH}_2\text{O})_n\text{OC}_6\text{H}_5$ with $n = 4$ or 6) to attempt to settle the

issue of the extracted complex structure. It was found that the PEO with $n = 6$ forms a 1:1 complex with each of two NH_4^+ or Na^+ ions and precipitates with a single $\text{Co}(\text{SCN})_4^{2-}$ anion (i.e. $[(\text{C}_6\text{H}_5\text{O}(\text{CH}_2\text{CH}_2\text{O})_6\text{C}_6\text{H}_5)\text{NH}_4]_2^{2+} \cdot \text{Co}(\text{SCN})_4^{2-}$ and $[(\text{C}_6\text{H}_5\text{O}(\text{CH}_2\text{CH}_2\text{O})_6\text{C}_6\text{H}_5)\text{Na}]_2^{2+} \cdot \text{Co}(\text{SCN})_4^{2-}$). On the other hand, the polyether with $n = 4$ formed a complex in which two chains coordinated to each of two NH_4^+ ions and precipitated with a single $\text{Co}(\text{SCN})_4^{2-}$ anion (i.e. $[(\text{C}_6\text{H}_5\text{O}(\text{CH}_2\text{CH}_2\text{O})_4\text{C}_6\text{H}_5)_2\text{NH}_4]_2^{2+} \cdot \text{Co}(\text{SCN})_4^{2-}$). This type of behaviour explains many of the observed differences in the sensitivity of the colorimetric method for nonionic surfactants of varying chain lengths.

An important paper which shed some light on the topic of the association between many noncyclic polyethers and cobalt-thiocyanate was offered by Sotobayashi et al. ⁽³²⁰⁾ a few years later. The study approached the interaction from a point of view opposite to that taken in the previous papers by considering it as a means of extracting trace amounts of cobalt into 1,2-dichloroethane containing a polyether compound in the presence of excess ammonium thiocyanate. As such, these studies bear the closest resemblance to our own work.

Several commercially available polyether mixtures were tested in the experiments including various poly(ethylene oxide)s (PEO) ranging in length from approximately 4.5 to 455 units, poly(propylene oxide)s (PPO) ranging from about 17 to 34 units in length, as well as some commonly -used commercial nonionic surfactants; Triton X-100 (PEO monoisooctylphenyl ether with roughly 10 $-\text{CH}_2\text{CH}_2\text{O}-$ units), Nonion NS (PEO monononylphenyl ether with approximately 20 $-\text{CH}_2\text{CH}_2\text{O}-$ units), Brij 58 (PEO monocetyl

ether with about 20 $-\text{CH}_2\text{CH}_2\text{O}-$ units), and Brij 35 (PEO monolauryl ether with about 23 $-\text{CH}_2\text{CH}_2\text{O}-$ units). It was observed from the results that under suitable conditions cobalt could be quantitatively extracted into an organic phase containing 1% (w/v) of many of these compounds, particularly those with longer polyether chain segments. For compounds with the same degree of polyether polymerization, the order of effectiveness for cobalt extraction was found to be PEO alkyl ethers, PEO alkylphenyl ethers > PPO > PEO. [In this, the order of the last two is contrary to the expectation of higher cation binding ability for PEO than for PPO; however, the difference is likely due mostly to the lower water solubility of the PPO material.]

Further experiments to test the thiocyanate dependence of extractions with most of the polyether compounds demonstrated that maximum cobalt extraction was achieved from about 2 to 4 M NH_4SCN , with PEO 1000 (i.e. with about 23 units) as the only exception. [In this case, no maximum was attained probably because of the inherent high water solubility of PEO and the superimposed salting-out effect of adding NH_4SCN to the solution.] Also, the addition of substantial amounts of acid was found to affect the extraction of cobalt deleteriously and best results were obtained with only 0.01 M HCl or less.

Some more detailed tests, carried out with Triton X-100 specifically as extracting agent showed that cobalt extraction was very sensitive both to the concentration of thiocyanate in the aqueous phase and to surfactant in the organic phase when present in small amounts. The $\log D$ versus $\log[\text{SCN}^-]$ plot at constant NH_4^+ concentration yielded a slope of 4 while

log D versus log [Triton X-100] gave a slope of 2. On this basis, the authors concluded that the extracted species was most likely $(\text{NH}_4)_2\text{Co}(\text{SCN})_4 \cdot (\text{Triton X-100})_2$ although whether the surfactant was expected to be associated with the cations or with the anion was not clarified and generally little interpretation was offered.

With the exception of the x-ray crystal studies, all of the preceding reports deal with nonionic surfactants manufactured from industrially-produced poly(ethylene oxide)s which inevitably contain a statistical mixture of chain lengths. However, Nozawa *et al.*⁽³³⁶⁾ re-examined the phenomenon of cobalt extraction more carefully using chemically pure individual POE monododecyl ethers and specific synthetically-prepared mixtures of these. From this study, it was concluded that the cobalt-ammonium thiocyanate spectrophotometric method in which benzene was used as the extracting solvent did not always obey Beer's Law but that apparently many commercial mixtures fortuitously did so. Different results were thus obtained with synthetic mixtures even having the same average number of ethylene oxide units but produced by mixing different proportions of the pure substances. Essentially quantitative extraction of nonionic surfactant was observed with compounds containing from 4 to 10 (and presumably more) ethylene oxide units. However, appreciable blue colour formation was not observed for less than 6 ethylene oxide units. The authors concluded from the absorption spectrum and the number of PEO chains associated with each cobalt atom (about 2.5 irrespective of length in the range from 6 to 10 units per chain) that there is no direct coordination of etheric oxygen to cobalt, in agreement with suggestions that NH_4^+ is actually the complexed cation.

Most recently, a further modification to the method of Greff et al. has been reported by Le Bihan and Courtot-Coupez⁽³³⁷⁾. In this case, flameless atomic absorption was used as the method of analysis for cobalt-thiocyanate extracted into benzene in the presence of commercial mixtures of PEO nonionic surfactants with a resulting improvement in detection limits. A fairly detailed study of the effects of the relative extractions of nonionic surfactants and poly(ethylene oxide)s (i.e. containing no attached alkyl group) was made in an effort to determine one in the presence of the other. As in their previous investigation⁽³³⁴⁾, they found an optimum pH of about 7.4 for the extraction of cobalt and an increase in extraction resulting from the addition of NaCl. Quite complicated interference effects were noted in the determination of nonionic surfactants in the presence of PEOs of various chain lengths but the authors claimed that careful choice of extraction volumes could render many of these tolerable.

As alluded to earlier, several other procedures have been developed for the analysis of nonionic surfactants which make use of the peculiar cation complexing characteristics of poly(ethylene oxide) compounds in conjunction with a variety of other intensely-coloured anions for extraction. These are not directly related to the cobalt-thiocyanate sorption of primary concern to us here but are further examples of the complexing behaviour of noncyclic polyethers. These will not be dealt with specifically. However, in passing, we should mention a more recent article by Favretto et al.⁽³³⁸⁾ which describes the use of picrate anions in the determination and which will serve as a source of references to

this related literature.

Apart from these, some other strictly analytical applications have been made of the observed noncyclic polyether complexing abilities. Some of these compounds have found direct use in the column chromatographic separation of several alkali and alkaline earth metal ions⁽²⁸⁵⁾. Also, largely successful efforts have been underway to prepare ion-selective electrodes based on noncyclic neutral charge carriers of this type. To that end, Levins⁽³³⁹⁻⁴⁰⁾ has described an electrode with high selectivity for barium over many other common metal ions and proposed it as an indicator electrode for SO_4^{2-} titrations. The polyether in this case is the nonylphenoxy polyoxyethylene ethanol containing about thirty ethylene oxide units and distributed under the trade name of Igepal CO-880. Minor modifications to this⁽³⁴¹⁾ and an extension to a poly(propylene oxide) derivative possibly usable for calcium ions⁽³⁴²⁾ have also appeared more recently.

In addition, the preparation of polystyrene resins containing pendant noncyclic poly(ethylene oxide) groups has been reported in the last few years⁽³⁴³⁻⁴⁵⁾. Separations of a few alkali and alkaline earth metal ions as their nitrate or thiocyanate salts were demonstrated using packed columns. As for the free polyethers, the length of PEO chain as well as the accompanying anion and the solvent chosen were all found⁽³⁴⁵⁾ to be important factors in the strength of cation binding observed. A minimum of five ethylene oxide units appeared to be required to exhibit significant complexation. In this case, then, the order of increasing extractability of the K^+ ion in its various salts proved to be $\text{SCN}^- > \text{I}^- > \text{Br}^- > \text{Cl}^-$ and for a particular anion the order of cation selectivity

was found to be $K^+ > Rb^+ > Cs^+ > Na^+$.

Of course, as we have briefly mentioned earlier, polyethers as a class have been widely applied to the analytical methods of gas and high pressure liquid chromatography for some time now. However, in our impending consideration of the complexation of cations, some more interesting observations are made from the alteration of chromatographic properties noted for the polyethers which have been treated with alkali metal salts. In this connection, Hamaguchi et al. ⁽³⁴⁶⁻⁴⁸⁾ have reported dramatic changes in the gas chromatographic interaction behaviour between a variety of amides and poly(ethylene oxide) stationary phases with and without added alkali metal salts. Since the same changes were not apparent when the salts were added to a polyester stationary phase (diethylene glycol succinate polymer - DEGS) instead, it seems likely that polyether cation complexation is at work in the former case (even though the authors did not interpret the phenomenon in this way). Similar effects should also be visible for bonded polyether liquid chromatographic stationary phases but no such reports have come to our attention.

Polymer chemists per se seem to have been more observant in respect of property changes resulting from the inclusion of metal salts in polyether polymers. An early such observation was reported in 1966 by Moacanin and Cuddihy ⁽³⁴⁹⁾ who noted large increases in the glass transition temperature, modulus and density of poly(propylene oxide) polymers which accompanied the addition of lithium perchlorate. Rather foresightedly, they concluded that these changes were induced by the formation of helical structures in the polyether stabilized by lithium perchlorate situated in the helix core. Unfortunately, they seem to have viewed the

entire $\text{Li}^+\text{ClO}_4^-$ ion pair as being solvated in this fashion rather than the cation only. Similar sorts of interaction behaviour were also reported much later by Hannon and Wissbrun⁽³⁵⁰⁾ between calcium thiocyanate and "phenoxy" polymer (an aromatic polyether prepared from 2,2-bis(4-hydroxyphenyl)-propane and 1-chloro-2,3-epoxypropane) in which the cation was suggested as the entity associated with the polyether but the property changes were thought to be only the result of reducing the free volume of the polymer. Wetton *et al.*⁽³⁵¹⁾ also reported similar phenomena for poly(propylene oxide) (but not for poly(tetramethylene glycol)) to which zinc or cobalt(II) chlorides were added. They concluded, however, that the strong interactions observed were the result of direct inner sphere coordination of two adjacent polyether oxygen atoms with the ZnCl_2 or CoCl_2 species. A later paper⁽³⁵²⁾ from the same laboratory extended the study to include the chloride salts of Fe(III), Sn(II), Hg(II) and Li(I) as well as to the bromide and iodide salts of zinc. Once again, based primarily on capacity measurements, a primary shell polyether oxygen coordination process involving the metal halide species was proposed although it seems equally likely that the cations of cation-anionic metal complex pairs were the actual participants. This should be easily verifiable by study of the infrared spectra.

Although one might include many other pieces of information from various areas of the chemical and technical literature, it should now be quite clear that there is ample evidence for a type of specific interaction between several types of polyethers and metal ions. With this background it is now appropriate to propose the Cation Chelation Mechanism as it applies to metal ion sorption by polyurethane foam.

2. The Cation Chelation Mechanism (CCM) for Polyurethane Foam

As we have previously pointed out in Chapter I, flexible polyurethanes are usually prepared from polyols of either polyether or polyester type joined together by the urethane and urea links characteristic of polyurethane chemistry. Those polyols of polyether type employed in flexible foam manufacture are generally prepared either from poly(ethylene oxide) (PEO), poly(propylene oxide) (PPO) or, quite often nowadays, a mixture of the two. Polyether polyols of an approximate average molecular weight of 1000 daltons (give or take a factor of two or so) are usually selected for this purpose. Thus, a single prepolymer chain of this type contains of the order of perhaps 10 to 40 ether oxygen atoms spaced at regular two-carbon intervals down its length and is joined at its ends to other segments of the polymer by urethane links. Both PEO- and PPO-based foams share this skeletal structure; the only difference between them being the presence of pendant CH_3 groups in the latter but not the former. Either type gives rise to a very flexible molecule owing to the facile rotation possible about C-C or C-O single bonds and the lack of very strong dipole-dipole interactions or hydrogen bonding between chains.

Polyesters, on the other hand, may consist of a wider range of types and skeletal patterns depending on the choice of parent diol and dicarboxylic acid from which they may be prepared. Compared to polyethers, polyester polyols chosen for use in flexible foam manufacture must contain larger numbers of carbon atoms in each monomer unit (about 8 or 10) and must usually also be of higher molecular weight (about 1000 to 3000 daltons) in order to compensate for their inherently less flexible

nature. A more-or-less typical type of polyester for purposes of discussion is poly(ethylene adipate) (PEA) which would possess chains of approximately 6 to 17 or so monomer units. For this and for polyester-based foams in general, the oxygen atoms in the chain will obviously be more widely and less uniformly spaced than is the case for most polyether polymers and this is one of the key chemical differences between the two types.

Further differences also exist in the three-dimensional conformations adopted by each of the polyol types: x-ray studies in the crystalline state have revealed that they each prefer slightly different orientations. Polyesters such as PEA typically assume a planar zigzag arrangement in which alternate carbonyl groups point in diametrically opposite directions (353) with strong interactions occurring between carbonyls in neighbouring chains. Polyethers of PPO type also crystallize in a planar zigzag form but without such distinct inter-chain attractions while those of the PEO variety readily adopt a helical configuration⁽³⁰⁵⁾. Although none of these structures could be expected to be strictly realized throughout the bulk of an entire polyurethane polymer (there are intervening links and cross-links with some obvious disorder since the polymers are, in fact, non-crystalline), they should, nevertheless, represent the lowest energy states which would be most nearly adopted by those portions which are free to do so. Different structures may certainly be induced locally in any of the polymers but at some additional energy cost. A summary comparison of the normal properties of the three representative polyol types appears below.

Comparison of Properties for Polyols of Different Types

	Polyol Type		
	Poly(ethylene oxide) (PEO)	Poly(Propylene oxide) (PPO)	Poly(ethylene adipate) (PEA)
Structure	$-(\text{CH}_2\text{CH}_2\text{O})_n-$	$-(\overset{\text{CH}_3}{\text{C}}\text{HCH}_2\text{O})_n-$	$-(\text{CH}_2\text{CH}_2\text{O}-\overset{\text{O}}{\parallel}{\text{C}}-(\text{CH}_2)_4-\overset{\text{O}}{\parallel}{\text{C}}-\text{O})_n-$
Molecular weight per monomer unit (daltons)	44	58	172
Typical total molecular weight (daltons)	500-2000	500-2000	1000-3000
Typical number, n, of monomer units in prepolymer chain	11-45	9-35	6-17
Crystalline structure	helical	planar zigzag	planar zigzag

In successfully developing a model for the sorption of metal ions by polyurethane foam according to a mechanism involving cation chelation, we require first an arrangement of the polyol which readily lends itself to chelation. In this respect, very few reports of significant metal ion complexation by polyesters containing 6 or 8 carbon atoms between consecutive ester groups have come to our attention. This lack is perhaps a reflection of relatively low complexing strength of the ester group but is likely more closely related to the geometrical problems of bringing many such groups near to a metal atom. However, from the work of many others, it has been demonstrated quite convincingly thus far that cyclic and noncyclic polyethers alike having the skeletal struc-

ture of PEO (and to a slightly lesser extent PPO) possess the ability to complex many cations to the extent that some ion pairs containing these cations are then extractable into organic solvents or resins containing the polyethers.

Included in the long list of cations thus far reported to be complexed to varying degrees by cyclic and noncyclic polyethers are the alkali metals (except Fr^+) (248-49, 251-56, 259-60, 263-68, 270-72, 275, 277-78, 280-82, 285, 287-90, 292, 293-96, 299, 301, 308, 316, 321-23, 325-26, 344-45) the alkaline earths (except Be^{2+}) (247-48, 250-51, 256-58, 261, 268, 274, 278, 280, 282, 284, 289, 295-96, 299-301, 321, 323, 325, 330, 344-45), Cr^{3+} (259), Mn^{2+} (257, 262), Co^{2+} (257, 262), Ni^{2+} (321, 257, 262), Cu^{2+} (321), Ag^+ (248, 254, 256-57, 274, 295-96, 299, 301), Au^+ (248, 256), Zn^{2+} (256-57), Cd^{2+} (247-48, 256-57), Hg^+ (248, 256, 301), Hg^{2+} (247-48, 256, 301), Tl^+ (248, 256, 276, 301), Pb^{2+} (247-48, 256, 276, 295, 321), Bi^{3+} (257), several lanthanides (248, 251, 256-57), UO_2^{2+} (257, 319), ammonium ion (NH_4^+) (247-48, 251, 254, 256, 271-72, 274, 283, 289, 301, 323, 325-26), various alkylammonium ions (RNH_3^+) (247-48, 256, 269, 271-72), H_3O^+ (273) and several others listed in the reviews by Christensen *et al.* (300) and Kolthoff (257). For many of these ions, complex strength is not large but they may be prepared under carefully chosen conditions, whereas for others quite stable associations are formed. The aqueous binding constants ($K = \frac{[\text{M}\cdot\text{CrE}^{\text{P}^+}]}{[\text{M}^{\text{P}^+}][\text{CrE}]}$) of many univalent and bivalent cations, M^{P^+} , with the cyclic crown ethers (CrE) dicyclohexyl-18-crown-6 (this compound exists as two isomers, A and B) have been measured by calorimetry and a comparison between them has been presented by Christensen *et al.* (300) (see below). From this, the cation selectivity characteristic

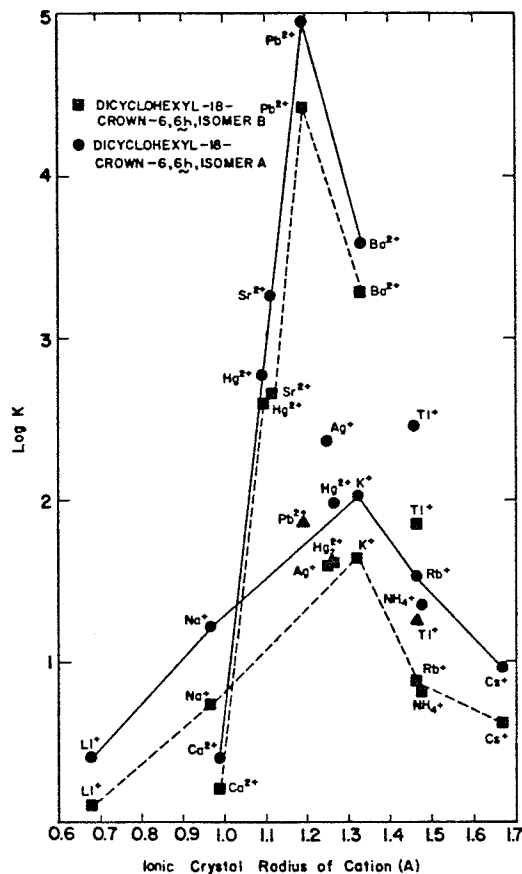

Relationship between magnitude of binding constant, K , and metal ion radius for the cyclic polyether dicyclohexyl-18-crown-6 in aqueous solution. The diameter of the cavity is approximately 3.0 Ångstroms. (300)

of the crown ethers based partly on ion size will be quite evident. Although their noncyclic cousins tend to demonstrate reduced selectivity, the trends observed here are also expected for them as well.

The peculiar complexing ability of the polyethers compared to their monomeric counterparts appears to be the result of the simultaneous proximity of a number of pairs of ether oxygen atoms each separated

from its neighbours by a two-carbon interval so that a five-membered ring can be formed in association with a metal ion, M^{P+} (as shown below). Polyethers containing larger or smaller numbers of intervening carbon

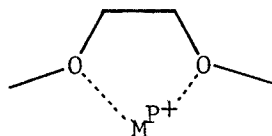

Five-membered ring associations formed between metal ions, M^{P+} , and PEO or PPO polyethers

atoms are much less effective at complexing cations evidently owing to the departure from 5-membered ring stability. Furthermore, the excellent flexibility of the polyether structure (as distinct from polyesters, for example) allows considerable leeway in forming many 5-membered ring associations at the same time with little or no actual distortion of the C-C or C-O bond angles. Thus, an "induced fit" to many cations having slight differences in size or coordination requirements is possible.

In cyclic polyethers, the geometrical constraints imposed by the ring ensure the perpetual alignment of the oxygen and metal atoms when both are of nearly compatible size. In noncyclic polyethers, however, we have seen that a spiral wrap-around arrangement results in much the same sort of alignment and with longer chains the effectiveness has been observed to improve ⁽³²²⁻²³⁾. The extension of this spiral configuration in longer polymers leads to a helix. As we have noted, this is the form adopted naturally by PEO in its crystalline state ⁽³⁰⁵⁾ and largely retained in aqueous solution ⁽³⁰⁷⁾. This helical structure, then, is easily

formed and possesses the requisite ability, with only minor distortion (by contraction in length or slight opening of the helix), to bring many oxygen atoms into simultaneous proximity with a specific point within its core. Here, they are able to solvate (chelate) any cations of suitable size and coordination preferences with many 5-membered ring associations. The cations are thus viewed as being accommodated along the central axis of a helix formed by the inwardly-directed polyether oxygen atoms in which many of them (6 to 12 or more) will be sufficiently close to the cation to engage in ion-dipole attractions. Presumably, PPO polymers are also able to adopt this arrangement although less readily due to steric influences of the methyl groups. Polyesters, however, (especially those with large numbers of intervening carbon atoms) would not be disposed to assuming the helical shape with inwardly-directed oxygen atoms.

Since we have no logical reason to expect substantially different chemical behaviour from polyethers dissolved in an organic solvent or indigenous in polyurethane foam (an extremely viscous organic liquid from our point of view), we predict that the identical type of interaction between the polyether-based polymer and many cations must also occur in this medium as well. The equilibrium between cations, M^{p+} , in solution and in polyurethane may thus be written as:

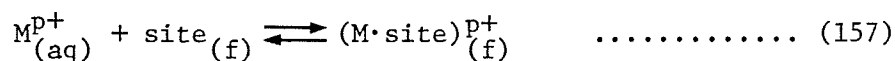

where, as usual, the subscripts *aq* and *f* refer to species in the aqueous and foam phases, respectively, and we now understand the specific chel-

ation "sites" to be the helical polyether portions of the polymer.

Polyurethane foam thus bears a very strong resemblance to the polymer-attached noncyclic polyether resins⁽³⁴⁴⁻⁴⁵⁾ which have been observed to complex Li^+ , Na^+ , K^+ , Rb^+ , Cs^+ , Mg^{2+} , Ca^{2+} and Ba^{2+} to varying degrees. The products produced by Fujita et al.⁽³⁴⁵⁾ are probably the most similar to polyurethane foam. These were reported to have theoretical cation complexing capacities of about 0.5 to 1.3 mol kg^{-1} and said to exhibit distribution ratios, D , ranging up to 68 L kg^{-1} (depending on the metal ion, the polyether chain length and solvent used). Less polar solvents and longer chains were noted to be most effective and the cation selectivity sequences were $\text{K}^+ > \text{Rb}^+ > \text{Cs}^+ > \text{Na}^+ > \text{Li}^+$ for univalent cations and $\text{Ca}^{2+} > \text{Mg}^{2+}$ for bivalent ones.

The chemical resemblances between these resins and polyurethane foam obviously arise only by accident since the polyurethanes have been selected and prepared almost entirely on the basis of physical rather than specific chemical properties as compared to the conscious and careful design of the polymer-attached polyether resins. The two differ, additionally, in the fact that aside from comparatively small amounts of chain linking (urethane, urea, etc.) groups, polyurethane foam consists almost entirely of potentially active polyether whereas the meticulously prepared resins contain a significant proportion of styrene-divinylbenzene backbone. Thus, there may possibly be a small improvement expected in the capacity of polyurethane foam compared to that of the resins for cation complexation but otherwise fairly similar behaviour is anticipated. We therefore expect that chromatographic

separations of cations based on the affinity differences should be possible for polyether-based polyurethane foam just as they have been demonstrated for the polyether-containing resins.

However, the important question which now occupies our interest is whether this can be directly related to the observed sorption by polyurethane foam of a number of metal-ion-containing anionic complexes instead. The answer to this question is obviously quite simple since the sorption of any cations, M^{p+} , automatically requires the simultaneous sorption of an equivalent number either of simple anions, A^- , (assumed to be univalent for simplicity) or complex ones, MeX_n^{m-} (Me = metal atom, X = anionic ligand), to maintain electrical neutrality in both the polyurethane and aqueous phases. Thus, while the polyether portions of the foam act as the "sites" at which cation chelation occurs, suitable accompanying anions are also sorbed. In general, therefore, we may write the equation describing the sorption of simple anions by foam as:

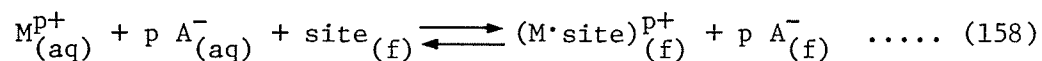

and the corresponding equation for the complex anions as:

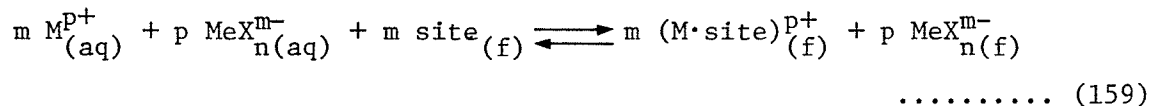

Here, we understand that ion pairing between the chelated cations and anions may possibly take place within the polyurethane depending on

the effective dielectric constant of the polymer and the charge, size, etc. of the ions involved. It should be borne in mind, though, that the chelated cation will have quite a large effective diameter so that close approach to any anions (as would be conducive to ion pairing) will be difficult. However, if ion pairing does occur, it may be written as:

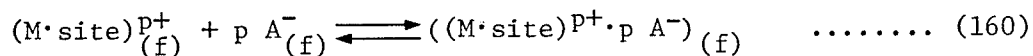

and

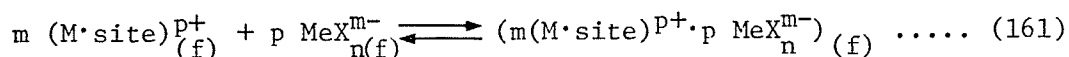

Just as there are preferences displayed by polyethers for particular cations, the sorption of anions by any solvent and all ion exchangers is not random and without selection. Therefore, the relative proportions of the two or more types which find their way into the polyurethane will depend primarily upon their own solvation properties in both phases. In respect to this anion selectivity phenomenon, Marcus and Asher⁽²⁸¹⁾ have recently considered many of the factors which are important in the relative extractabilities of several anions of simple type (halides, sulfate, acetate) when the accompanying cation is complexed by a macrocyclic crown ether in the organic phase. They conclude, based on both theoretical and experimental grounds, that the degree of extractability depends largely on the free energies of hydration of the anions in the aqueous phase from which they are removed and the corresponding free energy of

solvation offered by the organic solvent (and also perhaps partly by any accompanying water molecules). Thus, since the transfer of anions becomes the primary problem in cases where the cation is assured efficient solvation (chelation), as small as possible a free energy of transfer of the anion from water to the solvent is the prime condition for extractability of the pair. Physical properties of the solvent (dielectric constant, hydrogen donor abilities) and of the anions (size, charge, polarizability) are of very great importance, therefore, to the extraction of ion pairs.

With reference to the physical properties of the solvent, the authors state that an ideal solvent for a salt such as KCl (in the presence of crown ether) would be a protic one which has a low dielectric constant (to permit ion pairing), a low free energy of transfer of the anions (i.e. chloride ions in this example) into it from water, a high solubility of water in it (thus further reducing the free energy of transfer) but which has itself a low solubility in water. The "solvent" we are dealing with is the extremely viscous liquid called 'polyurethane' which, being primarily a polyether, has only moderate polarity and dielectric constant as well as rather limited hydrogen donor capabilities for hydrogen bonding (conceivably there may be some from urea or urethane >N-H groups). In addition, since it is a polymer, its solubility in water is definitely very low and if it were entirely of PEO type, the solubility of water in the polymer could likely be fairly high (judging from the miscibility of PEO with water) but this will be less true of PPO polyethers. Thus, since polyether-based polyurethane possesses some but not all of the necessary attributes for efficient

simple anion solvation, we expect fairly poor (and therefore fiercely competitive) but not negligible sorption of some anions along with the chelated cations.

Considering next desirable properties of the anions, we see that the primary factor governing extraction is their relative energies of solvation in the two phases - water and polyurethane. Other things being equal, small anions and those of greater charge (which are therefore more strongly hydrated in water) will be most difficult to transfer to the organic phase. In addition, even if much water of hydration is carried over into the organic phase along with the anions, those which are larger (and thus less hydrated) are expected to engage in more ion pairing with the cations, thus increasing extraction ability. We conclude from this that large ions of low charge density (such as I^- , ClO_4^- , etc.) will be preferred while low extractability will be characteristic of small ions of high charge density (such as F^- or Cl^- , for example).

The same basic thermodynamic principles which influence the extractability of simple anions also govern the extraction of anionic metal complexes, MeX_n^{m-} , as well. However, there are other complicating factors added to these which are related to the formation and decomposition equilibria of the complex anions themselves. Since complexes of this type have long been used in the solvent extraction separations of many metals, a very large number of publications dealing with the multitude of factors involved (but in the absence of crown ethers, of course) have appeared over the years. It is certainly not possible to review these but a representative sampling of the principles involved can be

obtained from the works of a few of the pioneers in the field.

In this connection, Irving, Rossotti and coworkers⁽³⁵³⁻⁵⁷⁾ presented a fairly comprehensive study of the consequences of alterations in a number of solution parameters (ligand concentration, metal concentration, pH, solvent type, etc.) on the solvent extraction of metals. Various conditions in which dimer formation, ion association, dissociation and acid-base equilibria became involved were dealt with quite thoroughly but these are related mostly to complex formation and stability.

In addition to these considerations, however, Diamond and Tuck⁽³⁵⁸⁾ and Diamond⁽³⁵⁹⁻⁶³⁾ have listed the most important attributes for extraction of complex anions as low charge, large size and hydrophobic structure (all of which are seen to reduce the degree of hydration of the anion). Also, they point out the important observation that complex anions formed with the larger pseudohalide ions such as thiocyanate are often stronger than are the halide ones (such as chlorides) and, being larger, are more extractable. This fact is further confirmed by the treatise of Sultanova, Zolotov et al.⁽²⁰⁴⁾ which reviews the many thiocyanate complexes employed in solvent extraction procedures.

Finally, Zolotov et al.⁽³⁶⁴⁻⁶⁶⁾ have pointed out that only those complex metal ions which contain neither free hydroxyl nor carboxyl groups can be expected to be efficiently extracted from aqueous solutions since only they are hydrophobic in nature. Included within the "forbidden" ligands, therefore, is the water molecule so that only complexes which are coordinatively saturated with some other ligand(s) are easily

transferred to an organic phase. Extractions were also classified into several different categories by the authors and, in particular, the competition between metal extraction via neutral species which contain the solvent as a ligand ("coordination solvation") or as anionic complexes in company with cations ("ion association") was pointed out. Mention was also made of the useful application of Pearson's⁽¹⁹⁰⁻⁹¹⁾ Principle of Hard and Soft Acids and Bases to predicting the extent of interaction between various solvents and metal complexes as a means of identifying the extraction mechanism (whether by ion association or by coordination solvation). Many other publications by this group⁽³⁶⁷⁻⁹⁹⁾ have been concerned primarily with factors which affect coextraction and suppression phenomena in acido complex metal ion extraction (i.e. complexes of the $H_m MeX_n$ type sometimes formed in acidic solutions). These considerations may be quite important under acidic conditions since this may be a competing mechanism to CCM for metal extraction. However, at higher pHs this mode becomes unfavourable.

From these discussions, it will be apparent that when a mixture of simple and complex anions is present in the aqueous phase, all will not be equally represented in the organic phase in company with cations chelated there when equilibrium is established with polyurethane foam (or any other solvent). In general, when suitable complex anions are present, they will be larger, more hydrophobic and thus less hydrated than will be the majority of simple anions and so will be the most efficiently extracted. However, appreciable amounts of both types may be present under appropriate circumstances.

Keeping this in mind, there are therefore two distinguishable ways in which we may regard the process of complex metal ion sorption to occur in terms of the extraction mechanism (CCM) which we are proposing. In the first of these, if the concentrations of all other anions, A^- , are sufficiently low in solution or if their properties are such as to render them very poorly extracted by polyurethane (i.e. if equation (158) above can be neglected), then essentially all of the cations, M^{P+} , which are sorbed and chelated by the polymer will have originated as partners with the extracted complex anion, MeX_n^{m-} . In this case, there will be m cations sorbed and m polyether sites filled for each p anions present and the process will be largely indistinguishable (except, perhaps, for higher distribution ratios) from any simple solvent extraction in which cation chelation is not involved at all. The complex anion extraction equilibria (including ion pairing but neglecting dimer formation and other complications) can then be summarized by:

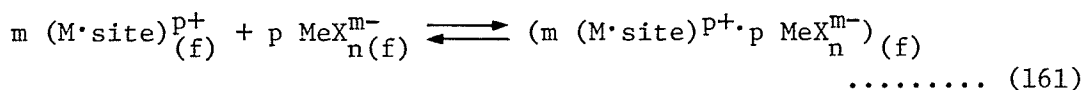
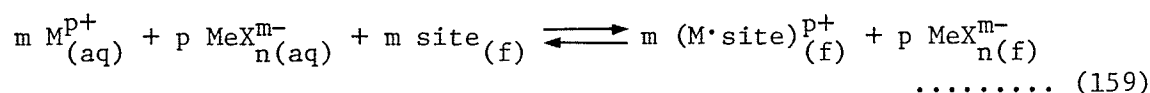

On the other hand, if large numbers of appreciably-extracted anions, A^- , are present in solution, then the chief source of filled sites (i.e. ones complexing a cation, M^{P+}) will be from the sorption of $M^{P+} + p A^-$ ion associates:

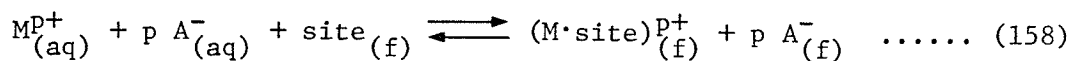

In the limiting case, these sorbed ion associates may be so numerous as to fill completely the available sites so that the maximum possible number of positive charges will be developed in the polymer. Under these conditions, any complex anions, MeX_n^{m-} , in solution must compete with and displace A^{-} ions from the polymer in order to be sorbed at all. The polymer is then most conveniently thought of as an anion exchanger in which, unlike conventional types, the positive sites are not permanent (as with quaternary ammonium sites in strong base exchangers) and yet are not dependent on pH (as is the case with weak base anion exchangers). Instead, they arise entirely from the presence of chelated cations, MP^{+} , and thus their numbers depend on the available concentration of these cations. We may then express the sorption of complex anions simply as the exchange equilibrium:

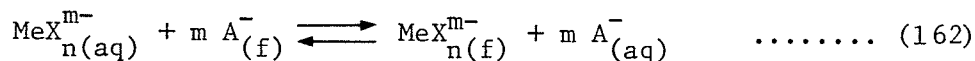

Naturally, if the anions, A^{-} , are very well extractable and abundant, the competition between MeX_n^{m-} and A^{-} anions expressed by equation (162) will be one-sided in favour of the A^{-} ions so that very little metal complex sorption can take place. In most cases, however, conditions intermediate between very efficient anion sorption and none at all will likely exist resulting in extraction behaviour somewhere between these two extremes, being neither entirely solvent extraction-like nor ion exchange-like.

As an easy corollary to the proposed CCM model, the maximum capacity of the polyurethane for complex anion sorption can be seen to be directly related to its capacity for cation chelation and is thus given by the number of equivalents represented by the product of the number of polyether chain sites and the charge, p , on the cations chelated there. Thus, if one kilogram of the polyurethane will accommodate Q moles of M^{p+} cations at an equal number of chain sites, then the maximum number of MeX_n^{m-} anions which may be accommodated will be $Q \cdot \frac{p}{m}$ mol kg^{-1} . This relationship arises simply out of the requirement of organic phase charge balance.

What is difficult to estimate, however, is the value of Q (the maximum number of polyether sites at which cation chelation can occur). We predict from the previous work of others on polyether complexation that such a site could not involve fewer than 5 to 7 consecutive ether units (depending on the cation size) if they were all of ethylene oxide type and all were available for cation chelation. In this case, Q could have a value as high as 3.2 to 4.5 mol kg^{-1} with a polymer which is essentially pure PEO with no other chemical constituents. In actual fact, however, we are dealing with a mixture which may also contain PPO (which has a higher monomer unit weight) and there will definitely be intervening links and crosslinks to prevent complete utilization of the polyether (for example, at positions immediately adjacent to such links). For these reasons, it is perhaps not too surprising that cation capacities of only about 1.0 to 1.5 mol kg^{-1} are more typically observed (by inference from the complex anion capacities) for polyurethane foam.

Interestingly, values such as these represent approximately one cation per polyether chain in the average polymer (in which about 20 ether units per chain is common) so that as much as two thirds of the units in a chain apparently may not be directly utilized in cation chelation. If the cations are, in fact, accommodated within the central core of a polyether helix, then we might expect that this "unused" fraction may depend somewhat on solution conditions such as the excess of available cation. This arises since some sites which do not naturally adopt a helical configuration may likely be induced to do so (at some additional energy cost) in the presence of a cation if there is sufficient outside chemical "pressure" for it to do so. Thus, we anticipate some limited expandability to the polymer capacity which may only be realized when the sorbing species are in overabundance.

Although the capacity for cations may be essentially fixed by the number of polyether sites available, it should be noted that the capacity for any given anion can be altered by changing the ratio of charges, p/m , on the cation and anion. Therefore, if the cation capacity is 1.0 mol kg^{-1} for a particular polyurethane when univalent cations are sorbed, the anion capacity will be only one half or one third of this value for divalent and trivalent anions, respectively. On the other hand, one can conceivably double or even triple the anion capacity if suitable di- and trivalent cations can be found to be sorbed. This is perhaps feasible for several divalent cations such as Ba^{2+} , Sr^{2+} , Pb^{2+} and Hg^{2+} which are effectively complexed by polyethers. In fact, Ba^{2+} has been found by x-ray fluorescence analysis to be present already in some commercially produced polyurethanes (but not in the one used

extensively in these experiments). Its addition to these polyurethanes is likely quite deliberate, incidentally, as a means of improving the load-bearing characteristics of the polymer but it will have the added effect of giving the polyurethane anion exchange capabilities.

To summarize, then, the Cation Chelation Mechanism for complex metal ion sorption by polyurethane foam has as its basis the supposition that many cations, MP^+ , such as Na^+ , K^+ , NH_4^+ , Ag^+ , Pb^{2+} , Ba^{2+} , etc. and including H_3O^+ are capable of being effectively (but not equally) chelated at the center of a helix formed by the polyether portion of the polymer. The extraction of ion pairs including these cations is then greatly facilitated owing to the stability of the chelated cation. However, which anions will accompany the cations in largest numbers to maintain electrical neutrality will be determined by a variety of factors including the anion's individual hydrophobic nature, its charge and perhaps its ability to interact in other ways with the polymer. Nevertheless although at least some specific anion-polymer interactions must take place (since selectivity is demonstrated) and are important in their own right, the central focus in understanding the entire phenomenon is really on the state of the cations.

Having thus presented an outline of the concepts of the Cation Chelation Mechanism, we may now apply the general equations and concepts expressed above to the specific case of the sorption of cobalt from thiocyanate solutions as investigated in the preceding experiments.

3. CCM Applied to Cobalt-Thiocyanate Sorptions

From the preceding discussions, it will be apparent that we regard the key to understanding the observed sorption of many metal anionic complexes to be the unique association of the accompanying cations with the polymer. The selectivity for particular anions is then based on such factors as their size, hydrophobic nature and possibly other criteria.

In applying these principles to the particular example of cobalt sorption, we should first identify the various ions involved. In the case of cations, the only abundantly available one in most cases has been Na^+ (usually at 3.0 M concentration jointly from NaSCN , NaCl and NaOOCCH_3) although very minor amounts of others such as H_3O^+ (at 2×10^{-5} M concentration when $\text{pH} = 4.7$), or $\text{Co}(\text{H}_2\text{O})_6^{2+}$, $\text{Co}(\text{SCN})(\text{H}_2\text{O})_5^+$, $\text{CoCl}(\text{H}_2\text{O})_5^+$ and $\text{Co}(\text{OOCCH}_3)(\text{H}_2\text{O})_5^+$ (at a total concentration not exceeding 1.7×10^{-6} M when the initial cobalt concentration was 0.1 ppm) will also have been present in a typical experiment. We infer, therefore, that the sodium ion will have been essentially the only cation chelated by the polymer in almost all instances though some important possible exceptions will be mentioned a bit later.

On the anion side of the ledger, there is slightly more diversity since at least three anionic ligands have generally been present at appreciable concentrations (typically $[\text{SCN}^-] = 0.10$ M, $[\text{Cl}^-] = 1.90$ M and $[\text{CH}_3\text{COO}^-] = 1.00$ M). Individually or in mixtures, these may form various anionic complexes with the cobalt ions present (i.e. complexes of the form $\text{Co}(\text{SCN})_j(\text{Cl})_k(\text{CH}_3\text{COO})_l^{2-(j+k+l)}$ where $(j+k+l) \geq 3$) but their

total abundance is again limited by the low initial cobalt concentration, 1.7×10^{-6} M. At least one of these minor anions ($\text{Co}(\text{SCN})_4^{2-}$) is most important to us, however, since it represents the chief means by which the metal is sorbed into polyurethane. In a few experiments (notably those in which the influence of many interferences was studied), other anions have also been present but we will also consider some of these later.

Of the three major anions added, we expect that the chloride and acetate ions are likely more strongly hydrated than is the large and hydrophobic thiocyanate ion and so this last may be the most efficiently sorbed of the three. This is certainly the case in most ion pair solvent extractions and, consequently, SCN^- has been used as a counter ion for various cations in many such extractions, including those involving crown ethers. However, since SCN^- is present here in much lower concentrations than are either Cl^- or CH_3COO^- , we cannot rule out the possibility that these last two will share some of the responsibility of accompanying the extracted cations.

We have deduced, we think, from a number of pieces of evidence that the chief sorbed cobalt-containing species is actually $\text{Co}(\text{SCN})_4^{2-}$. This conclusion has been reached based largely on the observed relationships between the cobalt distribution ratio, D , and the concentrations of cobalt and thiocyanate ions. Thus, since the $\log D$ versus $\log [\text{SCN}^-]$ plot (Figure 2-13) tends at low thiocyanate concentrations to be linear with a slope very near to 4, we have concluded that the extractable species contains four thiocyanate ligands. Similarly, the linearity and slope of zero exhibited by the $\log D$ versus $\log [\text{Co}]_{\text{aq}}$ graph (Figure 2-14)

has suggested that only one cobalt atom is involved in this species. Together, these observations are fairly strong evidence in support of $\text{Co}(\text{SCN})_4^{2-}$ but are not, of themselves, entirely conclusive since, as Danesi et al. ⁽⁴⁰⁰⁾ have pointed out, uncontrollable changes in the organic phase ionic strength (and thus activity coefficients) can occur with changes in the aqueous phase composition and can lead to misleading results.

However, many other bits of information which we have gathered also point to the presence of the $\text{Co}(\text{SCN})_4^{2-}$ species in polyurethane foam. One such obvious one is the very striking blue-green colour which is observed to appear on the polymer whenever cobalt-thiocyanate is sorbed (either in the presence or absence of both Cl^- and CH_3COO^-). This blue colour is characteristic of many Co(II) tetrahedral complexes and is visually identical to that which was obtained when an aqueous solution containing Co(II), acetate buffer and large amounts of NaSCN were mixed with a large number of oxygen-containing organic solvents (tetrahydrofuran, 1,4-dioxane, acetone, diethyl ketone, methylisobutyl ketone, dimethylsulfoxide, anisole, ethyl acetate, acetylacetone, formic acid, acetic acid, methanol, ethanol, isopropanol, nitromethane, tributylphosphate and hexamethylphosphoramide). The chief cobalt-containing species in several of these solvents (acetone ⁽²⁰⁶⁾, dimethylsulfoxide ^(207,244), methylisobutyl ketone ⁽²¹⁵⁾, tributylphosphate ⁽²⁴⁵⁾ and nitromethane ⁽²⁴⁶⁾) has already been identified by others to be $\text{Co}(\text{SCN})_4^{2-}$ so we suspect that the colours we observe are likewise indicative of this species on polyurethane foam.

However, more conclusive evidence would be obtained from spectral measurements made in situ on the polyurethane foam itself. Unfortunately, attempts to obtain a usable transmission electronic absorption spectrum of the sorbed complex directly on foam squashed between two glass plates were not successful (owing to the very high light scatter of the foamed polymer) and other efforts to generate a reflectance spectrum of this material were also filled with technical difficulties. Thus, it proved not to be possible to produce an electronic absorption spectrum of the complex as it exists on polyurethane foam.

As an alternative to the direct measurement, however, it was found that the blue cobalt-thiocyanate colour could be transferred rapidly and visibly unaltered from a piece of polyurethane foam on which it had been absorbed into several oxygen-containing organic solvents (acetone, methylisobutyl ketone and tetraglyme) in which the absorption spectrum could then be readily determined. The spectra of these solutions then showed that they all contained the same absorption maximum near 620 nm with a shoulder near 585 nm which is identical to that of the $\text{Co}(\text{SCN})_4^{2-}$ anion reported in a wide variety of organic solvents (acetone⁽²⁰⁶⁾, methylisobutyl ketone⁽²¹⁵⁾, dimethylsulfoxide^(207,244), tributylphosphate⁽²⁴⁵⁾, trimethylphosphate⁽²⁰⁷⁾, nitromethane⁽²⁴⁶⁾, N,N-dimethylacetamide⁽²⁰⁷⁾ and 1,2-propanediol carbonate⁽²⁰⁷⁾). Thus, the species rapidly removed from polyurethane foam is evidently $\text{Co}(\text{SCN})_4^{2-}$ although we cannot be certain from this that it is not altered on removal.

As a further confirmation of the identity, however, we have previously recorded the spectrum of the cobalt-thiocyanate species absorbed by several polyurethane film types (Figure 2-30) and this is identical

in feature to the spectrum of $\text{Co}(\text{SCN})_4^{2-}$ reported by the various works listed above. Although we concede that these films are not chemically identical to #1338 BFG polyurethane foam (as evidenced by lower extracting abilities), the strong similarity between the two types of polymer and the apparently large number of structurally different oxygen-containing organic solvents in which $\text{Co}(\text{SCN})_4^{2-}$ is the predominant cobalt-containing species is very strongly suggestive of its presence in polyurethane foam, as well.

Still further evidence comes from measurement of the infrared absorption spectrum of the polymer bearing sorbed cobalt-thiocyanate. Once again, unfortunately, the physical form of polyurethane foam makes direct measurement of its transmission spectrum difficult. However, some success was achieved using the Attenuated Total Reflectance (ATR) technique in which the specimen is pressed against the outside surfaces of a high density crystal material within which multiple total internal reflection of infrared radiation takes place. By this means, it was observed that the sorption of cobalt either from solutions containing 0.10 M NaSCN, 2.80 M NaCl and 0.10 M $\text{NaOOCCH}_3/\text{HOOCCH}_3$ buffer or from those containing 2.9 M NaSCN and 0.10 M $\text{NaOOCCH}_3/\text{HOOCCH}_3$ buffer resulted in the appearance of the same additional absorption bands at 4.85 μm (2060 cm^{-1}) and 11.9 μm (840 cm^{-1}). These absorptions would agree fairly well with the reported^(185,247) infrared spectrum of the $\text{Co}(\text{SCN})_4^{2-}$ ion (or, more properly $\text{Co}(\text{NCS})_4^{2-}$ since evidence indicates that it is an isothiocyanato complex) and so we take this as confirmatory evidence. This assessment also agrees with the spectrum of the complex on polyurethane film (Figure 2-31) obtained by the regular infrared

transmission technique.

Thus, although no one piece of evidence establishes the sorbed complex identity unambiguously, we conclude from the mass of accumulated data that polyurethane foam extracts the $\text{Co}(\text{SCN})_4^{2-}$ anion as the chief cobalt-containing species.

With the identity of the sorbed cobalt-containing species thus established, it is now possible to describe in pictorial fashion what we view to be the physical state of the polymer and absorbed species. If we assume that only univalent cations, M^+ , are available to accompany $\text{Co}(\text{SCN})_4^{2-}$ into the polyurethane (i.e. Na^+ , K^+ or perhaps H_3O^+ as were generally the only possibilities in these experiments), then we expect the type of arrangement portrayed in Figure 2-34.

Here, as dictated by the Cation Chelation Mechanism, the cations, M^+ , are accommodated at positions along the central axis of helical poly-(ethylene oxide) chains in which 6 to 10 or so inwardly-directed oxygen atoms are simultaneously in reasonable proximity to the cation and so constitute a chelated "solvent shell" in which it resides. As shown in the Figure, the polyether helix is expanded slightly at the position of cation chelation. This action would bring larger numbers of oxygen atoms into the neighbourhood of the cation but would also separate them further from it and thereby tend to reduce the effectiveness of ion-dipole interactions. The diameter of the helix at the chelation point would therefore be dictated by a balance between these two factors and would depend upon both the size and coordination requirements of the particular cation. It should be clear, however, that some distortion of the regular helical structure is inevitable here as oxygen atoms are

Figure 2-34

Structure (not strictly to scale) of cobalt-thiocyanate-polyether complex proposed by the Cation Chelation Mechanism for the extraction of cobalt by polyurethane foam. The cations, M^+ , are unspecified and are shown larger than normal to demonstrate the expandability of the polyether to accommodate ions of various sizes. The poly(ethylene oxide) chains shown here have been extended slightly beyond a length typical of polyurethane foam (~20-25 ethylene oxide units) in order to portray the geometrical shape more clearly.

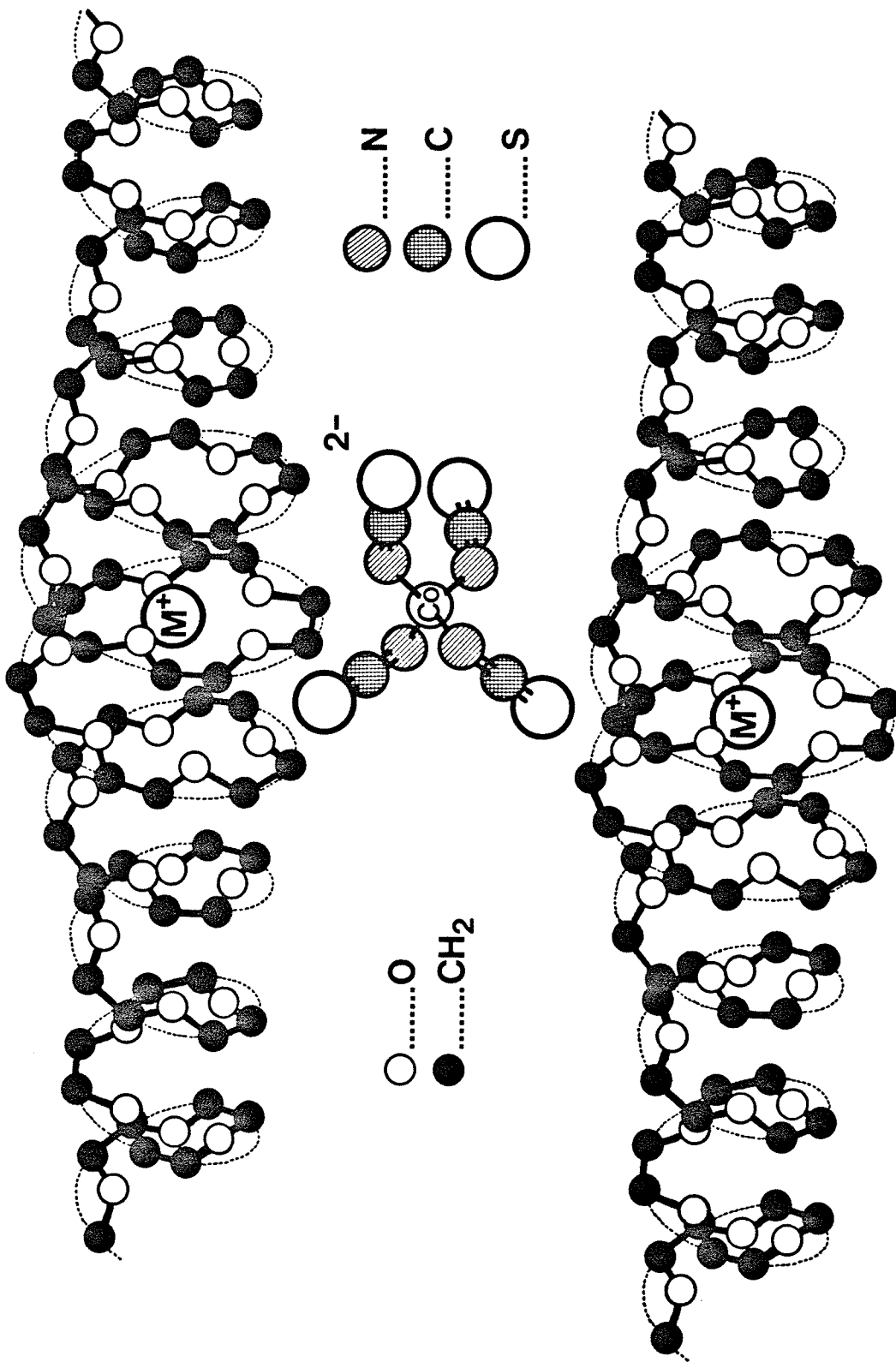

redirected to give optimum interaction with the cation and also that movements of the cation will be restricted largely to the axis of the helix.

In polyurethane, naturally, the polyether chains must be joined to their neighbours by the usual urethane and urea links and cross-links (not shown) to form the final polymer network. The presence of such amorphous regions (which often contain aromatic rings) thus disrupts the extension of the helical polyether arrangement at intervals along the length of the polymer and thereby would limit effective cation chelation to the intervening polyether sections. Although Figure 2-34 shows 38 ethylene oxide units in each of the polyether chains in order to portray the helical nature clearly, this represents an upper limit to the number which would be found between any two linkage disruptions in a polyurethane foam formulation. A more typical representation would contain only about 20 to 25 units. Thus, since disruptions to the helical structure must be suffered in the vicinity of the links at each end of the polyether chain, we expect that only the middle portion will be capable of achieving effective cation chelation and that only sufficient units will probably then be available to accommodate a single cation there. This restriction will then establish the capacity of the polymer for cation absorption.

The anionic $\text{Co}(\text{SCN})_4^{2-}$ complex as we have shown in Figure 2-34, is reported⁽¹⁸⁵⁾ to have a tetrahedral geometry with nearly 120° Co-N-C bond angles and might be expected to prefer a staggered arrangement of the SCN^- ligands. The complex would probably tend most often to occupy

a space somewhere between the polyether chains in the vicinity of two chelated cation sites but may derive some further degree of solvation by closer association with free polyether as well. In contrast to the accompanying chelated cations, the anion would therefore be expected to have a reasonable degree of freedom to stray some distance from these sites if its solvation requirements are minimal. This would be particularly true in a polymer containing many neighbouring cationic sites (i.e. one having a high concentration of sorbed ionic species) where hopping from pair to pair of cationic sites should be quite easy.

Accompanying this pictorial description, we would like now to express some of the concepts of the sorption of cobalt-thiocyanate according to the Cation Chelation Mechanism in mathematical form as well. Thus, as we have stated several times before, the first steps involved in the process will be those controlling the formation of the extractable $\text{Co}(\text{SCN})_4^{2-}$ species in aqueous solution. To summarize these, there are, first of all, the four stepwise formation reactions replacing water ligands with SCN^- about the cobalt atom. For simplicity, we will omit the water ligands and also write the equations in overall form as:

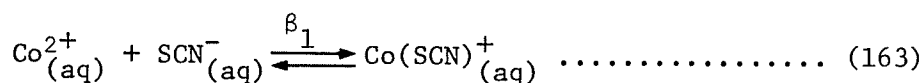

$$\beta_1 = \frac{[\text{Co}(\text{SCN})^+]_{\text{aq}}}{[\text{Co}^{2+}]_{\text{aq}} [\text{SCN}^-]_{\text{aq}}} \dots\dots\dots (164)$$

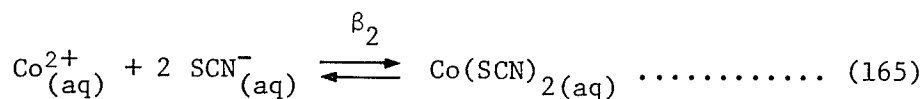

$$\beta_2 = \frac{[\text{Co}(\text{SCN})_{2}]_{\text{aq}}}{[\text{Co}^{2+}]_{\text{aq}} [\text{SCN}^{-}]_{\text{aq}}^2} \dots\dots\dots (166)$$

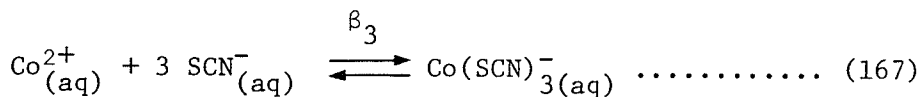

$$\beta_3 = \frac{[\text{Co}(\text{SCN})_{3}^{-}]_{\text{aq}}}{[\text{Co}^{2+}]_{\text{aq}} [\text{SCN}^{-}]_{\text{aq}}^3} \dots\dots\dots (168)$$

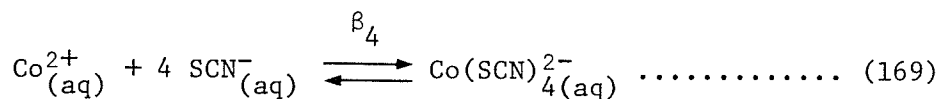

$$\beta_4 = \frac{[\text{Co}(\text{SCN})_{4}^{2-}]_{\text{aq}}}{[\text{Co}^{2+}]_{\text{aq}} [\text{SCN}^{-}]_{\text{aq}}^4} \dots\dots\dots (170)$$

From the equation describing the formation of the extractable species (169), we deduce that the extraction of cobalt will generally increase with increasing thiocyanate concentration. Also, in the presence of such ligands as Cl^{-} and $\text{CH}_3\text{COO}^{-}$, we may have appreciable amounts of other complexes formed in solution which we summarily describe by the general equation for the formation of such species:

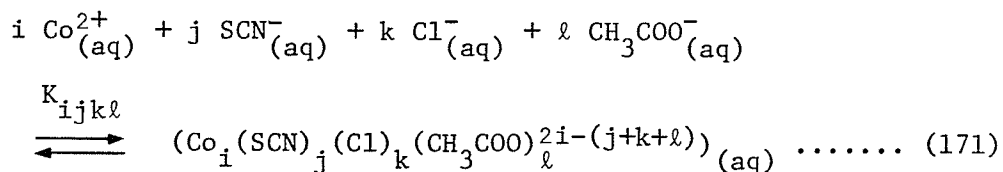

$$K_{ijk\ell} = \frac{[\text{Co}_i(\text{SCN})_j(\text{Cl})_k(\text{CH}_3\text{COO})_\ell^{2i-(j+k+\ell)}]_{\text{aq}}}{[\text{Co}^{2+}]_{\text{aq}}^i [\text{SCN}^-]_{\text{aq}}^j [\text{Cl}^-]_{\text{aq}}^k [\text{CH}_3\text{COO}^-]_{\text{aq}}^\ell} \dots\dots\dots (172)$$

where we exclude the conditions $i=1, k=\ell=0$ since these would then duplicate the equations (163), (165), (167) and (169) above. The effect of any appreciable formation of species of this type would be expected to decrease formation of the extractable $\text{Co}(\text{SCN})_4^{2-}$ anion and thus some depression of cobalt extraction may result.

Two other reactions which may also substantially affect the formation of the extractable complex in moderately acidic or basic solutions are the following:

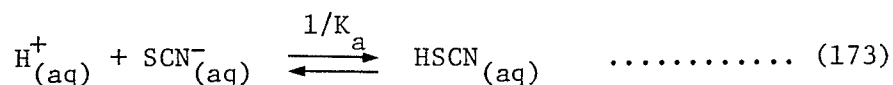

$$K_a = \frac{[\text{H}^+]_{\text{aq}} [\text{SCN}^-]_{\text{aq}}}{[\text{HSCN}]_{\text{aq}}} \dots\dots\dots (174)$$

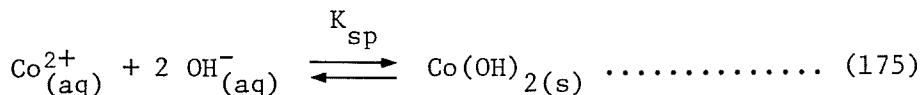

$$K_{\text{sp}} = [\text{Co}^{2+}]_{\text{aq}} [\text{OH}^-]_{\text{aq}}^2 \dots\dots\dots (176)$$

Both equations (173) and (175) represent further competing reactions to the formation of the extractable cobalt-containing species and so we predict declines in cobalt distribution in both strongly acidic or strongly basic solutions.

The major method of transfer of cobalt to the foam (f) phase is then via the absorption of the $\text{Co}(\text{SCN})_4^{2-}$ anion in association with two cations, M^+ , which become chelated by polyether "sites" in the foam. For simplicity, we will assume that the cations are univalent but will not identify them further (although, as we have indicated, they will be Na^+ in most experimentally tested cases). Thus, we write the distribution equilibrium as:

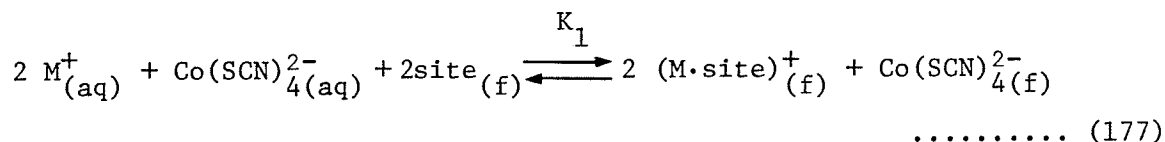

$$K_1 = \frac{[(\text{M}\cdot\text{site})_{(\text{f})}^+]^2 [\text{Co}(\text{SCN})_4^{2-}]_{\text{f}}}{[\text{M}_{(\text{aq})}^+]^2 [\text{Co}(\text{SCN})_4^{2-}]_{\text{aq}} [\text{site}_{(\text{f})}]^2} \quad \dots\dots\dots (178)$$

Here, we have assumed that very little ion pairing of the absorbed anion with the chelated cations occurs as is consistent with our view of the mechanism in which the anion is free to wander whereas the cations are largely fixed in position and are unavailable to accompany (i.e. be paired with) the anion in its wanderings.

Since effective cation chelation is the important feature of the mechanism, we further expect that perhaps some sorption of other hydrophobic anions, A^- , may also occur when these are present (again, without identifying them specifically and assuming that they are univalent). These anions could be Cl^- , CH_3COO^- or SCN^- in most of the experiments described previously but many others such as ClO_4^- or other metal anionic

complexes may be included in this group when they are also present.

Thus, we may express the sorption of A⁻ anions by the equation:

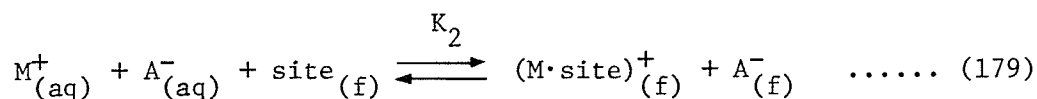

$$K_2 = \frac{[(M \cdot \text{site})^+]_f [A^-]_f}{[M^+]_{aq} [A^-]_{aq} [\text{site}]_f} \quad \dots\dots\dots (180)$$

The foregoing nine chemical equations express most of the significant happenings to be expected with respect to cobalt and polyurethane foam. However, we will add one other which may become significant at higher aqueous concentrations of cobalt:

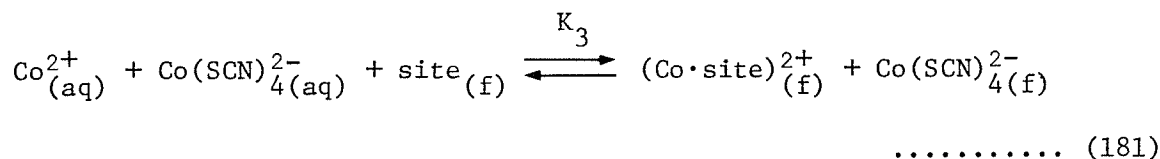

$$K_3 = \frac{[(\text{Co} \cdot \text{site})^{2+}]_f [\text{Co}(\text{SCN})^{2-}_4]_f}{[\text{Co}^{2+}]_{aq} [\text{Co}(\text{SCN})^{2-}_4]_{aq} [\text{site}]_f} \quad \dots\dots\dots (182)$$

The existence of reaction (181) presupposes that some appreciable polyether chelation of the Co²⁺ ion may occur and that this may represent another (probably minor) avenue for its sorption. There is, in fact, some prior justification for this suggestion. For example, both Crabb and Persinger⁽³³⁰⁾ and Courtot-Coupez and Le Bihan⁽³³⁴⁾ proposed just such an association between Co²⁺ and nonionic surfactants, the latter group citing a very weak visible absorption at 495 nm in concentrated

solutions as evidence for the presence of octahedrally-coordinated Co^{2+} (accompanied by $\text{Co}(\text{SCN})_4^{2-}$ as the anion). Although other x-ray crystallographic results (241) with short-chain non-cyclic polyethers did not confirm this under other conditions of complex formation, it seems possible that such may occur to a limited extent under certain circumstances. In particular, where nitrogen ligands are also available, cobalt may well be complexed by a polyether. This has been demonstrated by Mathieu and Weiss (297) who presented the x-ray crystallographic structure of the cobalt-thiocyanate complex of the 1.2.2 cryptand showing it to be a $(\text{Co}\cdot\text{cryptand})^{2+}\cdot\text{Co}(\text{SCN})_4^{2-}$ ion pair. If the urea, urethane and other nitrogen atoms of polyurethane may also participate in similar fashion, the proposal of reaction (181) to a limited extent (i.e. K_3 not large) is not unreasonable.

Taking, then, these ten equations, we may write the expression for the cobalt distribution ratio (ignoring any $\text{Co}(\text{OH})_2(\text{s})$ in both phases) as:

$$\begin{aligned}
 D &= \frac{[\text{cobalt in all forms}]_f}{[\text{cobalt in all forms}]_{\text{aq}}} = \frac{[\text{Co}]_f}{[\text{Co}]_{\text{aq}}} \\
 &= \frac{[(\text{Co}\cdot\text{site})^{2+}]_f + [\text{Co}(\text{SCN})_4^{2-}]_f}{[\text{Co}^{2+}]_{\text{aq}} + [\text{Co}(\text{SCN})^+]_{\text{aq}} + [\text{Co}(\text{SCN})_2]_{\text{aq}} + [\text{Co}(\text{SCN})_3^-]_{\text{aq}} \\
 &\quad + [\text{Co}(\text{SCN})_4^{2-}]_{\text{aq}} + \sum_{ijkl} [\text{Co}_i(\text{SCN})_j(\text{Cl})_k(\text{CH}_3\text{COO})_l^{2i-(j+k+l)}]_{\text{aq}} \\
 &\hspace{15em} \dots\dots\dots (183)
 \end{aligned}$$

Unfortunately, though visibly fairly simple, the mathematical

solution of this equation based on things we might be able to know (i.e. $[\text{SCN}^-]_{\text{aq}}$, $[\text{Cl}^-]_{\text{aq}}$, $[\text{CH}_3\text{COO}^-]_{\text{aq}}$, $[\text{M}^+]_{\text{aq}}$, $[\text{A}^-]_{\text{aq}}$, $[\text{H}^+]_{\text{aq}}$, $[\text{OH}^-]_{\text{aq}}$, the initial concentration of cobalt, and the number of foam sites) would involve more than twelve simultaneous non-linear equations in an equal number of unknowns (i.e. D , $[\text{Co}^{2+}]_{\text{aq}}$, $[\text{Co}(\text{SCN})^+]_{\text{aq}}$, $[\text{Co}(\text{SCN})_2]_{\text{aq}}$, $[\text{Co}(\text{SCN})_3^-]_{\text{aq}}$, $[\text{Co}(\text{SCN})_4^{2-}]_{\text{aq}}$, $[\text{HSCN}]_{\text{aq}}$, $[(\text{M}\cdot\text{site})^+]_{\text{f}}$, $[(\text{Co}\cdot\text{site})^{2+}]_{\text{f}}$, $[\text{Co}(\text{SCN})_4^{2-}]_{\text{f}}$, $[\text{A}^-]_{\text{f}}$, $[\text{site}]_{\text{f}}$ and each of the $[\text{Co}_i(\text{SCN})_j(\text{Cl})_k(\text{CH}_3\text{COO})_\ell^{2i-(j+k+\ell)}]_{\text{aq}}$) and so is not readily solvable even if all of the β and K values are known or assumed. However, one might attempt to do so numerically with a large allotment of computer time although, of course, many of the various β and K values are unknown or difficult to assume and most others are poorly known, at best. Thus, we are unable to deal mathematically with the general sorption equation.

Before we leave the topic of the Cation Chelation Mechanism as it applies to cobalt (and presumably to other metals) sorption, we should point out that, although we expect it to be the dominant mode, it should not be supposed that all sorption (even of anions) must occur by this mechanism. It has been amply demonstrated in our review of the work of others (Chapter I) that a large number of completely neutral compounds are quite efficiently extracted from both gases and liquids by polyurethane foam. Consideration of this obviously demonstrates that the polymer possesses all of the requisite properties of a simple ether-like solvent in which chelation need not be a part. Moreover, we expect from the very much lower affinities of the polyurethane film materials tested compared to the foams, that cation chelation could not have been in operation there (conceivably as a result of a polyether

component which contains many more than two intervening carbon atoms). Nevertheless, the species absorbed in that case was again $\text{Co}(\text{SCN})_4^{2-}$ and we expect that the poor sorption observed probably represents the extent of strictly ether-like solvent extraction of $\text{Na}_2\text{Co}(\text{SCN})_4$. Thus, some (probably much less than one percent) of the metal ion sorption by polyurethane foam which we observe may occur by simple solvent extraction. This proportion may be considerably higher in those instances in which anionic complexes do not form readily or in cases where acido metal complexes do. Likely, in all cases, a mixture of extraction mechanisms may exist with possible but not necessary predominance of one or another.

4. Comparison of Some Experimental Results with CCM

We may now review some of the observed experimental results in light of the proposed mechanism. First of all, one of the most striking features of the sorption of cobalt is the very high distribution ratio attainable (up to about 3×10^6 L kg⁻¹). In the simple solvent extraction of ion pairs or even neutral complexes, distribution ratios exceeding 1000 (or even 100) are extremely rare even under optimum conditions. Thus, although some additional improvement might be expected when the "solvent" is polymeric due to the reduced phase mixing, this cannot logically be expected to result in values in the 10^6 range based solely on solvent extraction. However, the Cation Chelation Mechanism explains fairly readily how the distribution ratio for anions can approach that more typical of ion exchange (about 10^5 or 10^6 L kg⁻¹). The two are quite closely related, in fact, since in both cases the solvation of a cation within the polymer becomes an unimportant consideration relative to the sorption of the anion (i.e. it is energetically assured already and so does not represent an impediment).

Furthermore, in studying the extent of cobalt sorption as a function of equilibration time, it was noted that an exponential sorption profile was not strictly followed. Instead, fairly rapid initial uptake of cobalt occurred (considering the unfavourable ratio of phase volumes and weights chosen) but that much slower increases resulted thereafter (Figures 2-10 and 2-11). In addition, it was observed that considerable differences in rate of uptake could exist between foam pieces located in different distribution cells where the efficiencies of squeezing dif-

ferred. It was suspected at the time of those experiments that diffusion and possibly polymer reordering phenomena must be the cause of some of these observations; however, it is now possible to understand the mechanics of this more clearly.

First of all, we recognize that at least some of the useful compressibility and expandability of the polyurethane is due to the easy compression, extension and bending of the polyether sections of the polymer. Where helical sections exist, it is not difficult to view the effects of such deformations on the polymer in much the same fashion as they would be for a spring. Consequently, we expect that the act of flexing the foamed polymer (as we have done by squeezing it 25 times per minute in contact with solutions to bring them to equilibrium) would result in opening and closing of the helices or reorienting some polymer segments to and from a helical arrangement. The introduction of a cation into a helical site or its expulsion from one should therefore be enhanced by such a process. Thus, the provision of mechanical energy in this fashion should have the dual effects of increasing both cation absorption and desorption rates in the polymer and this should probably, in turn, aid the process of diffusion further into its bulk. Whether this or the more obvious problem of continuously bringing fresh solution into contact with the polyurethane surface is the primary reason for differences in sorption rates with different squeezing efficiencies is difficult to tell, however.

From the experiments designed to test the effects of solution pH on cobalt sorption (Figure 2-12), we have interpreted the precipitous decline in D at a pH lower than 1.0 as arising out of the formation of

HSCN at the expense of SCN^- ligand. However, one facet of the results which was not commented on earlier was the slight but measurable increase in the distribution ratio, D , as the pH was lowered from 9.0 to 1.0. Although minor activity coefficient changes could simply be the cause, another possibility to be considered is that H_3O^+ could actually be chelated by polyether in slight preference to Na^+ (which it replaces in solution as the pH is decreased to maintain constant ionic strength). Any such cation sorbed more effectively than Na^+ would then generate a larger number of filled "sites" at which cobalt sorption could occur.

Chelation of H_3O^+ by polyether could conceivably occur, in fact, since it would be able to engage in hydrogen bonding to the oxygen atoms of the helix surrounding it in addition to the usual type of solvation available to most cations. In support of this suggestion, Haymore and Huffman⁽⁴⁰¹⁾ have reported the x-ray structure of an H_3O^+ -cyclic crown ether complex confirming such an arrangement. However, competing with the possible improvement in polyether-cation interaction brought about by hydrogen bonding is the extremely hydrophilic nature of H_3O^+ surely rendering it very difficult to remove from water. The net effect of this, therefore, is not known and the suggestion that H_3O^+ may be better than Na^+ is conjecture only. Nevertheless, in strongly acid solutions, polyurethane foam has been noted to become pink and to sorb several metal anionic complexes (e.g. GaCl_4^-). The existence of chelated H_3O^+ ions in these cases seems quite possible.

Considering next those experiments performed to establish the effects of cobalt concentration (see Figures 2-14 and 2-15) and aqueous:polymer phase ratio (see Figure 2-16) on sorption, we commented at that time

that fairly small increases in D observed at high foam cobalt concentrations could perhaps be explained by equations such as the following (written in ion paired solvent extraction format with appreciable sorption of MSCN assumed):

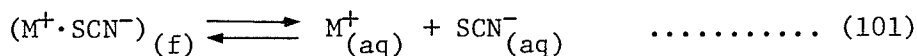
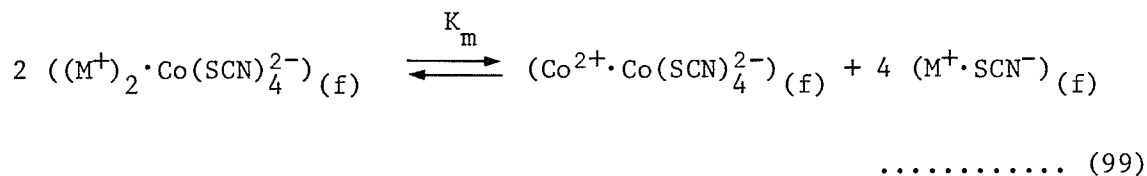

In light of the CCM, we now recognize this as an expression of the chelation of a Co²⁺ cation (rather than an M⁺ cation) at a polyether site when the concentration of cobalt becomes higher. The result of this switch from a +1 to a +2 ion as the capacity of the foam is approached is, of course, to increase the effective capacity and thereby to increase cobalt sorption. Thus, the peculiar increases which were noted in these experiments now seem interpretable.

A further observation made in the experiments to establish the capacity of the foam for cobalt sorption (Tables II-10 and II-11) was that some degree of foam breakage occurred near saturation. This comes, in fact, as an easy consequence of the CCM since the orientation by moderately strong ion-dipole interactions of some 6 to 10 or so oxygen atoms in the polyether chain about a single cation will severely restrict the ability of that portion of the polymer to undergo any sort of deformation readily. As a result, some overall stiffening should thereby

occur with the degree of change being dependent on the concentration of cations so complexed. In addition, when the anion:cation charge ratio is greater than one (as is the present case where divalent anions and univalent cations are involved), the electrostatic attractions between chelated cations in neighbouring chains and the intervening anion constitute a type of ionic cross-link between the chains and would tend to restrict their motions relative to one another with a further decrease in polymer flexibility. The combination of these two effects was apparently severe enough to result in the breaking of covalent bonds in the polymer and the release of small bits to solution when squeezed repeatedly. The same behaviour was also noted by Moore⁽⁵²⁾ while studying the sorption of Na_2IrCl_6 from acetone and ethyl acetate although it passed uninterpreted.

In investigating the effects of temperature on the sorption of cobalt (Figures 2-18 and 2-19), we noted that under conditions of optimum extraction (i.e. low temperature and/or high thiocyanate concentration), temperature had very little influence on extraction over a fairly wide range. This led to calculation of $\Delta H \approx 0$ and $\Delta S > 0$. We were forced to interpret this either in terms of an ion exchange-like process or of a solvent extraction-like one in which very effective solvation of at least the cation must be in effect and for which little additional ordering of the polymer must take place on solvation. We see now that either interpretation is indeed quite in keeping with the Cation Chelation Mechanism as we have discussed it and we consider this to be evidence in its favour.

Likewise, it is now possible to interpret more easily the results

of some other experiments having to do with the effect of polymer type on the efficiency of cobalt sorption. We understand, therefore, that the chief effect of structural changes will be to alter the effectiveness of chelation of the cation. Thus, the key requirements to achieve efficient chelation are that the polyol must be of polyether type (since polyesters do not form helical chains so readily) and that two carbon atoms intervene between successive oxygen atoms (so 5-membered ring associations can be made with the cation). These requirements obviously indicate why polyester-based foam was so much less successful than its polyether cousins (Table II-18). Also, since polyurethane films are often prepared from such polyethers as poly(tetramethylene oxide) which contain four intervening carbon atoms between successive oxygens, we expect poorer performance for the films, as was observed (Table II-24).

The preference for poly(ethylene oxide) over poly(propylene oxide) demonstrated in Table II-18 must likely be related, then, to the reduced helix formation brought about by steric interference of the methyl groups. Furthermore, insofar as some methods of preparation (with various surfactants, etc.) may tend to leave much of the polyether in a permanently tangled form when the polymer links are completed, we can understand some of the differences displayed by polyurethanes prepared from the same major starting materials. We may also thus understand why it was generally observed that the more flexible foams tended to perform best.

Thus, we see from these few comparisons between the experimental results obtained and our expectations based on the Cation Chelation Mechanism that the data are generally consistent with the mechanism.

Although this does not alone constitute its proof, it is strong evidence in its favour. Additional, more conclusive evidence in support of CCM has already been amassed by others of this laboratory⁽⁴⁰²⁻⁴⁰³⁾ following its initial conception some time ago. The results of their studies will be presented by them shortly.

E. CONCLUSIONS

Cobalt(II) is extracted very efficiently from aqueous thiocyanate solutions by many types of polyurethane foam and less efficiently by several types of polyurethane film. The cobalt sorption capacity of the polyurethane foam material tested (#1338 BFG) is approximately 0.47 mol kg^{-1} and the efficiency (as measured by the distribution ratio, D) can be as high as $D = 3 \times 10^6 \text{ L kg}^{-1}$. The distribution ratio is essentially independent of aqueous cobalt concentration when the capacity for sorption is not approached and D is also reasonably independent of the ratio of phases chosen (aqueous:foam) with slight increases apparent for high ratios.

Conditions which favour efficient cobalt extraction and which lead to maximum values of D are: high thiocyanate concentration, high ionic strength, low temperature and $1.0 < \text{pH} < 9.0$. Most simple salts added to solution produce enhancements due to ionic strength increases. However, a few others create substantial depressions where some cobalt complexation or competitive sorption are indicated. Thus, probably through cobalt complexation, EDTA produces a very strong depressive effect on sorption while cyanide, citrate, oxalate and ethylenediamine are less severe. Tetraphenylborate ($(\text{C}_6\text{H}_5)_4\text{B}^-$) also interferes but likely by competitive sorption instead.

In 0.5 M NaSCN , $0.1 \text{ M NaOOCCH}_3/\text{HOOCCH}_3$ buffer solution, the presence of many metal ions (Ca(II), Mg(II), Sr(II), Ba(II), Sc(III), La(III), Ti(III), Zr(IV), Cr(VI), Mo(VI), Mn(II), Os(IV), Ir(III), Ir(IV), Ni(II), Al(III), Tl(I), Sn(II), Pb(II), Bi(III) and U(VI)) is apparently without

effect even at 1000 ppm levels when Co(II) is present at only 0.10 ppm concentration. Others (Be(II), Ti(IV), Ru(IV), Ga(III) and Sb(III)) produce only mild interferences while still others (W(VI), Fe(II), Fe(III), Rh(III), Cu(II) and Cd(II)) are tolerated less well. The strongest interferences to cobalt sorption, however, come from Cr(III), Pd(II), Pt(II), Pt(IV), Au(III), Zn(II), Hg(II), In(III) and Sn(IV). Most of these metals are suspected of also being sorbed efficiently from thiocyanate solutions by polyurethane foam but others interfere by other means (such as coprecipitation in the case of Sn(IV)).

By contrast, the presence of some organic nitrogen-containing species is very conducive to cobalt extraction. Thus, several ions of the form RNH_3^+ , R_2NH_2^+ , R_3NH^+ or R_4N^+ increase the distribution ratio when R is quite large (such as n-butyl or n-hexyl) but are much less effective or even depress extraction where R is small (e.g. methyl). The compounds with large R groups evidently behave as liquid anion exchangers to aid in cobalt extraction. The presence of NH_4^+ and NH_3OH^+ ions also results in substantial increases in the distribution ratio as a result of their greater extractability by polyurethane than Na^+ .

We conclude strictly from a consideration of the measured high distribution ratios and reasonably large capacities (both of which are similar to those of typical ion exchangers) that polyurethane foam may find several industrial and analytical applications for the extraction of cobalt (and obviously other metals also). Like ion exchange resins, polyurethane foam has several advantages over organic solvents. Firstly, it is completely insoluble and so is not lost to and does not itself contaminate aqueous solutions which it may be used to extract. Since it

is equally insoluble in organic solvents, its range of application can be extended to them as well. Moreover, as it has no vapour pressure, it does not represent either a health or explosion hazard as do many organic solvents. While possessing many of the advantages of traditional ion exchange resins, however, it has the important advantage of being reasonably inexpensive (current commercial price about \$2.00 per kilogram) and so may be industrially attractive.

As possible industrial applications, we have in mind the concentration and purification of cobalt by selective extraction from mining liquors, the treatment of industrial effluents, the cleanup of radioactive wastes or perhaps even the reprocessing of nuclear fuels. As we have shown, high extraction efficiencies for cobalt can be obtained with rather modest use of thiocyanate especially when other cheaper salts such as sodium chloride and low temperatures are used. We have also shown that cobalt-thiocyanate is extracted in the presence of many other metal ions and could therefore be separated from them.

In analytical usage, we recognize that the physical form of an open-cell foam is a good one for efficient flow with equally efficient solution/polymer contact. Its use in column chromatography is therefore natural and has been demonstrated many times by others. However, this is not the only perceived asset, particularly in the cobalt-thiocyanate extraction system which we have described. Thus, the combination of very high distribution ratio, intense blue colour of the complex and high degree of control of sorption available through manipulation of the various parameters involved ($[\text{SCN}^-]$, temperature and ionic strength are each capable of altering D by several orders of magnitude) suggest its

use in several ways. First of all, the very high distribution ratio achievable under optimum conditions and the fact that it does not decrease at either low cobalt concentrations or high solution volumes allows one to apply polyurethane foam quite successfully to the preconcentration of that metal from very large volumes of dilute solution. Since cobalt sorption is quite insensitive to pH (over the range from 1.0 to 9.0), some selectivity over other metals may thus be found by careful choice of this parameter. Also we expect further metal selection to be possible based on the aqueous thiocyanate concentration and probably on the temperature chosen.

Once sorbed, the cobalt is then readily amenable to qualitative, semi-quantitative or quantitative analysis directly on the polymer by visual examination, x-ray fluorescence, neutron activation or other methods. Alternatively, it can be stripped off into strong acids, organic oxygen-containing solvents or simply hot water for identification or quantitation by spectrophotometry, atomic absorption or any other convenient technique. We have demonstrated in this work at least the feasibility of applying the method to the semi-quantitative analysis of cobalt by simple visual comparison down to the nanogram range on a radioactive tracer. The technique would not be without strong interferences from a few metals but we have demonstrated that many others and a large number of common salts do not interfere appreciably. The applicability to quantitative analysis by means other than radioactive tracer remains to be demonstrated properly by others.

From log D versus $\log [\text{Co}]_{\text{aq}}$ and log D versus $\log [\text{SCN}^-]_{\text{aq}}$ plots as well as spectroscopic evidence, we conclude that the species extracted from aqueous thiocyanate solutions by polyurethane is the $\text{Co}(\text{NCS})_4^{2-}$ isothiocyanato complex anion in company with an equivalent number of cations to maintain electrical neutrality.

Based on the many experimental measurements made in the cobalt(II) - thiocyanate system and also on a careful consideration of the known cation complexing behaviour of polyethers, we conclude that the sorption of many anionic metal complexes may take place via a newly-proposed mechanism (the Cation Chelation Mechanism). In this proposal, suitable accompanying cations are multiply complexed (chelated) at the central axis of distorted helices formed by the polyether portions of the polyether-based polyurethane thus generating cationic "sites" in the polymer.

The strength of cation complexation likely depends on characteristics both of the polyether and of the cations. Polyethers (such as poly(ethylene oxide)) containing two intervening carbon atoms between successive oxygen atoms are expected to form more stable complexes than are those with either fewer or more carbon atoms since their associations with cations then result in 5-membered rings. Alkyl groups attached to the carbon skeleton (such as CH_3 in poly(propylene oxide)) significantly decrease the complexing ability apparently due to their steric hindering effects on the adoption of a helical structure. Polyester-based polyurethanes are without the ability to chelate cations.

Many cations, including most of the alkali metals, alkaline earths, lanthanides, actinides, some main group transition metals, H_3O^+ , NH_4^+ and its monoalkyl (and possibly dialkyl) derivatives as well as a few others

can be expected to be complexed by polyether. However, the strength of complexation will vary according to both the size and character of the cations. Cations which are very large (e.g. $(C_4H_9)_4N^+$) will be unable to be accommodated within an unstrained helical arrangement of the polyether. On the other hand, those which are very small (such as Li^+) will not be closely approached by sufficient ether oxygen atoms to be strongly complexed by them but will be very well solvated in water. Moreover, all other factors being equal, cations (such as NH_4^+) for which extensive hydrogen bonding with the polyether oxygen atoms is possible are expected to have enhanced complex stabilities. For all types, however, the flexibility of the polyether chain is expected to allow for accommodation of a fairly wide range of cation sizes in tetrahedral, octahedral or a number of other coordination geometries by some adjustments in the dimensions and local distortions of the helix. Nevertheless, some degree of selectivity between cations will be displayed.

In the presence of an abundance of chelatable cations, the very efficient sorption of ion pairs containing those anions which are poorly solvated in water and/or well solvated by the polymer will occur. In particular, we expect large and bulky anions which contain neither free carboxyl nor hydroxyl groups and which can be generally described as "soft" Lewis bases to be preferred. Among the easily extractable anions are many metal complexes (such as $Co(SCN)_4^{2-}$, $GaCl_4^-$, $AuCl_4^-$, $FeCl_4^-$, and $Fe(CN)_6^{3-}$) which are coordinatively saturated with ligands other than water. Also included, however, are some common anions such as ClO_4^- , $(C_6H_5)_4B^-$ and even SCN^- (but to differing extents). From solutions in which only one reasonably extractable anion is present, its extraction

may be regarded essentially as a simple ion pair solvent extraction in which the cation is especially well solvated. However, in the presence of appreciable quantities of other extractable anions which enter the polymer prior to or concurrently with the one in question (and thereby create a large number of cationic "sites"), the sorption process is more easily viewed as one of anion exchange.

REFERENCES

- 1) Saunders, J. H. ; Frisch, K. C. : High Polymers. Volume XVI. Polyurethanes : Chemistry and Technology. Part I. Chemistry; Interscience Publishers, John Wiley and Sons, New York, 1962
- 2) Saunders, J. H. ; Frisch, K. C. : High Polymers. Volume XVI. Polyurethanes : Chemistry and Technology. Part II. Technology; Interscience Publishers, John Wiley and Sons, New York, 1964
- 3) Benning, C. J. : Plastic Foams : The Physics and Chemistry of Product Performance and Process Technology ; Volume I, Wiley Interscience, John Wiley and Sons, 1969, p. 142 ff.
- 4) Pigott, K. A. : "Urethane Polymers" in The Kirk-Othmer Encyclopedia of Chemical Technology, 2nd Edition; H. F. Mark, editor; Interscience Publishers, New York, 1970
- 5) Flexible Polyurethane Foam Manual, Technical Service Report; Union Carbide Corporation, Chemicals and Plastics Research and Development Department, 1970
- 6) Braun, T. ; Farag, A. B. : "Use of Cellular Plastics in Extraction Chromatography" in Extraction Chromatography, Journal of Chromatography Library, Volume 2, T. Braun, G. Ghersini (editors), Elsevier Scientific Publ. Co., N.Y., 1975 pp.344-65
- 7) Braun, T. ; Farag, A. B. : "Cellular and Foamed Plastics as Separation Media. A New Geometrical Form of the Solid Phase in Analytical Liquid-Solid Contact"; Talanta, 22, 699-705 (1975)
- 8) Braun, T. ; Farag, A. B. : "Polyurethane Foams and Microspheres in Analytical Chemistry. Improved Liquid-Solid, Gas-Solid and Liquid-Liquid Contact Via a New Geometry of the Solid Phase"; Analytica Chimica Acta, 99, 1-36 (1978)
- 9) Moody, G. J. ; Thomas, J. D. R. : "Extractions and Separations with Foamed Plastics and Rubbers. A Review."; The Analyst, 104(1234), 1-15 (1979)

- 10) Lee, D. W. : "Application of Polymer Foams to Foam Chromatography"; Hwahak Kwa Kongop Ui Chinbo, 17(3), 131-139 (1977), [Chemical Abstracts, 88(14), #98545w (1978)]
- 11) Ross, W. D. : "Open Pore Polyurethane - A new Separation Medium"; Separation and Purification Methods, 3(1), 111-13, (1974)
- 12) Navratil, J. D. ; Sievers, R. E. : "Chemical Separations with Open-Pore Polyurethane"; American Laboratory, 9(10), 38-42 (1977)
- 13) Van Venrooy, J. J. : "Polymeric Foam Column Packing for Gas Chromatography"; Patent, U.S. 3,347,020 ; Oct. 17, 1967 [Chemical Abstracts, 68 #56451u (1968)]
- 14) Schnecko, H. ; Bieber, O. : "Colonnes Remplies de Matériaux Cellulaires pour la Chromatographie en Phase Gazeuse"; Chromatographia, 4, 109-12 (1971)
- 15) Strickman R. L. : "Tobacco Smoke-Filtering Materials"; Patent, U.S. 3,618,618 ; Nov. 9, 1971 [Chemical Abstracts, 76 #97051 (1972)]
- 16) Moroni, R. ; Kalbow, H. : "Air Filter for Removal of Foreign Gases, Particularly Sulfur- or Nitrogen-Containing Gases"; Patent, Ger. Offen. 2,329,645; Jan. 9, 1975 [Chemical Abstracts, 82 #144479d (1975)]
- 17) Duce, A. ; Quinn, G. ; Wade, L. : "Residence Time of Non-Methane Hydrocarbons in the Atmosphere"; Marine Pollution Bulletin, 5(4), 59-61 (1974)
- 18) Bidleman, T. F. ; Olney, C. E. : "Chlorinated Hydrocarbons in the Sargasso Sea Atmosphere and Surface Water"; Science, 183, 516-18 (1974)
- 19) Bidleman, T. F. ; Olney, C. E. : "High-Volume Collection of Atmospheric Polychlorinated Biphenyls"; Bulletin of Environmental Contamination and Toxicology, 11(5), 442-50 (1974)
- 20) Bidleman, T. F. ; Olney, C. E. : "Long Range Transport of Toxaphene Insecticide in the Atmosphere of the Western North Atlantic"; Nature, 257, 475-77 (1975)
- 21) Rice, C. P. ; Olney, C. E. ; Bidleman, T. F. : "Use of Polyurethane Foam to Collect Trace Amounts of Chlorinated Hydrocarbons and Other Organics from Air"; World Meteorological Organization (W.M.O. - No.460) Special Environmental Report No.10, Air Pollution Measurement Techniques, 1977

- 22) Yamasaki, H. ; Kuwata, K. ; Miyamoto, H. : "Collection of Atmospheric Polycyclic Aromatic Hydrocarbons Using Polyurethane Foam Plugs"; Bunseki Kagaku, 27(6), 317-21 (1978) [Chemical Abstracts, 89, #185008n (1978)]
- 23) Gough, K. M. : "The Extraction and Recovery of Phthalates from Water by the Use of Polyurethane Foam"; M. Sc. Thesis, Chemistry Department, University of Manitoba, 1976
- 24) Yamasaki, H. ; Kuwata, K. : "Collection of Atmospheric Phthalate Esters Using Polyurethane Foam Plugs"; Bunseki Kagaku, 26(1), 1-5 (1977), [Chemical Abstracts, 86, #194125p (1977)]
- 25) Turner, B. C. ; Glotfelty, D. E. : "Field Air Sampling of Pesticide Vapours with Polyurethane Foam"; Analytical Chemistry, 49(1), 7-10 (1977)
- 26) Lewis, R. G. ; Brown, A. R. ; Jackson, M. D. : "Evaluation of Polyurethane Foam for Sampling of Pesticides, Polychlorinated Biphenyls and Polychlorinated Naphthalenes in Ambient Air"; Analytical Chemistry, 49(12), 1668-72 (1977)
- 27) Evans, W. H. ; Mage, M. G. ; Peterson, E. A. : "A Method for the Immunoabsorption of Cells to an Antibody-Coated Polyurethane Foam"; Journal of Immunology, 102(4), 899-907 (1969)
- 28) Bowen, H. J. M. : "Absorption by Polyurethane Foams; New Method of Separation"; Journal of the Chemical Society, Part A, 1970, 1082-85 (1970)
- 29) Bowen, H. J. M. : "Measuring Surface Areas of Polyurethane Foams using Stearic Acid-1-¹⁴C"; Radiochemical and Radioanalytical Letters, 2(4), 169-73 (1969)
- 30) Dunlop Holdings Limited, Bowen, H. J. M. : "Recovery of Substances from a Fluid Medium"; Patent, British 1,305,375 ; Jan. 30, 1970
- 31) Schiller, P. ; Cook, G. B. : "Determination of Trace Amounts of Gold in Natural Sweet Waters by Non-Destructive Activation Analysis after Preconcentration"; Analytica Chimica Acta, 54, 364-68 (1971)
- 32) Bowen, H. J. M. : "Testing the Recovery of Silver and Gold from Liquid Mineral Wastes"; Radiochemical and Radioanalytical Letters, 7(2), 71-73 (1971)

- 33) Braun, T. ; Farag, A. B. : "The Recovery of Gold from Thiourea Solutions with Open-Cell Polyurethane Foams"; Analytica Chimica Acta, 66, 419-26 (1973)
- 34) Sukiman, S. : "The Extraction of Gold from Aqueous Solution with Treated and Untreated Polyurethane Foams"; Radiochemical and Radioanalytical Letters, 18(3), 129-34 (1974)
- 35) Khan, A. S. ; Chow, A. : unpublished results
- 36) Mazurski, M. A. J. : "Extraction of Some Inorganic Pollutants Using Flexible Polymer Foams"; M.Sc. Thesis, Chemistry Department, University of Manitoba, 1972
- 37) Chow, A. ; Buksak, D. : "The Extraction of Mercury and Methylmercury by Diphenylthiocarbazono-treated Polyurethane Foams"; Canadian Journal of Chemistry, 53, 1373-77 (1975)
- 38) Lypka, G. N. : "The Extraction and Separation of Copper and Cadmium Chelates by the Use of Polyurethane Foam"; M.Sc. Thesis, Chemistry Department, University of Manitoba, 1975
- 39) Lypka, G. N. ; Gesser, H. D. ; Chow, A. : "Foam Chromatography: The Extraction and Separation of a Copper - Cadmium System by Benzoylacetone-treated Polyurethane Foam"; Analytica Chimica Acta, 78, 367-73 (1975)
- 40) Gesser, H. D. ; Bock, E. ; Baldwin, W. G. ; Chow, A. ; McBride, D. W. ; Lipinsky, W. : "Open-cell Polyurethane Foam sponge as a 'Solvent Extractor' for Gallium and Iron"; Separation Science, 11(4), 317-27 (1976)
- 41) Canada, Research Council of Manitoba : "Metal Extraction and Recycle from Aqueous Solutions"; Patent, Japan. Kokai 76 66201 ; June 8, 1976 [Chemical Abstracts, 87 #204752c (1977)]
- 42) Horsfall, G. A. : "The Extraction of Gallium from Acid Chloride Systems using Open-Celled Polyurethane Foam"; M.Sc. Thesis, Chemistry Department, University of Manitoba, 1977
- 43) Gesser, H. D. ; Horsfall, G. A. : "Separation and Concentration of Gallium by Polyurethane"; Journal de Chimie Physique et de Physico-Chimie Biologique, 74(10), 1072-76 (1977)
- 44) Oren, J. J. ; Gough, K. M. ; Gesser, H. D. : "The Solvent Extraction of Fe(III) from Acidic Chloride Solutions by Open Cell Polyurethane Foam Sponge (OCPUFS)"; Canadian Journal of Chemistry, 57(15), 2032-36 (1979)

- 45) Valente, I. ; Bowen, H. J. M. : "Method for the Separation of Antimony(III) from Antimony(V) Using Polyurethane Foam"; Analyst, 102, 842-45 (1977)
- 46) Lo, V. S. K. : "The Extraction of Tin and Antimony by the Use of Polyurethane Foam"; M.Sc. Thesis, Chemistry Department, University of Manitoba, 1978
- 47) Lo, V. S. K. ; Chow, A. : "The Extraction of Antimony with Open-Cell Polyurethane Foam"; Analytica Chimica Acta, 106(1) 161-65 (1979)
- 48) Gupta, B. M. : "The Extraction of Uranyl Nitrate from Aqueous Nitrate Solutions by Open-Cell Polyurethane Foam Sponge"; M.Sc. Thesis, Chemistry Department, University of Manitoba, 1979
- 49) Braun, T. ; Farag, A. B. ; Maloney, M. P. : "Polyurethane - Pyridylazonaphthol Foams in the Preconcentration and Separation of Trace Elements"; Analytica Chimica Acta, 93, 191-201 (1977)
- 50) Maloney, M. P. ; Moody, G. J. ; Thomas, J. D. R. : "Extraction and Separation of Metal Ions by Foam-Supported Reagents"; Proceedings of the Analytical Division of the Chemical Society, 14(9), 244-46 (1977)
- 51) Braun, T. ; Farag, A. B. : "Polyurethane Foam of the Polyether Type as a Solid Polymeric Extractant for Cobalt and Iron from Thiocyanate Media"; Analytica Chimica Acta, 98, 133-36 (1978)
- 52) Moore, R. A. : "The Extraction of Iridium and Platinum from Organic Solvents by the Use of Polyurethane Foam"; M.Sc. Thesis, Chemistry Department, University of Manitoba, 1979
- 53) Will, R. G. ; Grutsch, J. F. : "Purifying Oil-Contaminated Water by Filtration"; Patent, U.S. 3,617,552 ; Nov. 2, 1971 [Chemical Abstracts, 76 #27828g (1972)]
- 54) Cadron, E. C. A. ; Jourquin, L. E. L. : "Use of Polyurethane Foam for Combating Oil and Hydrocarbon Pollution on Water"; Patent, Belg. 764,805 ; Aug. 16, 1971 [Chemical Abstracts, 76 #158071c (1972)]
- 55) Henager, C. H. ; Smith, J. D. : "Concept Evaluation. Oil Spill Cleanup by Polyurethane Foam"; United States NTIS Report PB 221251/2 (1972) [Chemical Abstracts, 80 #17124t (1974)]
- 56) Kovaleva, T. V. ; Pichakhchi, I. D. ; Khailovich, Yu. A. : "Removal of Petroleum Products from the Surface of Water Using Foamed Polyurethanes"; Problemy Okhrany Vod., 1972 (1) 122-27 : (1972) [Chemical Abstracts, 81 #16394q (1974)]

- 57) Miller, E. ; Stephens, L. ; Ricklis, J. : "Development and Preliminary Design of a Sorbent-Oil Recovery System"; United States NTIS Report PB 221497/1 (1973) [Chemical Abstracts, 80 #17125u (1974)]
- 58) Takanaka, H. : "Absorbing Petroleum from Ocean with Polyurethane"; Patent, Japan. Kokai 73 75462 ; Oct. 11, 1973 [Chemical Abstracts, 80 #40808c (1974)]
- 59) Oxenham, J. P. ; Cochran, R. A. ; Hemphill, D. P. ; Scott, P. R. ; Fraser, J. P. : "Development of a Polyurethane Foam Marine Oil Recovery System"; Proceedings of Joint Conference on Prevention and Control of Oil Spills, Washington, D.C. (1973), pp. 277-89 [Chemical Abstracts, 80 #124330d (1974)]
- 60) Kondo, G. ; Hayashi, M. : "Removal of Oils on the Surface of the Sea"; Patent, Japan. 73 18180 ; June 4, 1973 [Chemical Abstracts, 81 #41182b (1974)]
- 61) Cochran, R. A. ; Fraser, J. P. ; Hemphill, D. P. ; Oxenham, J. P. ; Scott, P. R. ; "Oil Recovery System Utilizing Polyurethane Foam. Feasibility Study" ; United States NTIS Report PB 231838/4GA (1973) [Chemical Abstracts, 81 #122054p (1974)]
- 62) Gollan, A. ; Fruman, D. H. : "Separation of Oil from Water Using an Oleophilic Porous Material"; Patent, Fr. Demande 2,224,412 ; Oct. 31, 1974 [Chemical Abstracts, 83 #32738b (1975)]
- 63) Ohkuma, I. ; Suzuki, K. : "Removal of Oils from Water or Seawater with Synthetic Resin"; Patent, Japan. Kokai 74,111,883 ; Oct. 24, 1974 [Chemical Abstracts, 84 #35055h (1976)]
- 64) International B. F. Goodrich ; "Combatting the Contamination of Water by Oil Floating on it"; Patent, Neth. Appl. 73 10267 ; Jan. 28, 1975 [Chemical Abstracts, 83 #32721r (1975)]
- 65) De Young, W. J. : "Oil Sorption Material" ; Patent, U.S. 3,888,766 ; June 10, 1975 [Chemical Abstracts, 84 # 49705g (1976)]
- 66) Barbulescu, N. ; Greff, C. ; Serbanescu, O. ; Stoicescu, C. S. : "Depolluting Agent"; Patent, Romania 57629 ; June 30, 1975 [Chemical Abstracts, 89 #64718k (1978)]
- 67) Sumida, A. ; Kataoka, H. : "Adsorption of Oils by Polyurethane Foams"; Patent, Japan. Kokai 76 76,365 ; July 1, 1976 [Chemical Abstracts, 85 #125272b (1976)]

- 68) Sumikura, T. ; Terada, H. ; Kaneko, S. : "Polyurethane Foam with Improved Oil Absorption"; Patent, Japan. 76 27,710 ; Aug. 14, 1976 [Chemical Abstracts, 86 #56276n (1977)]
- 69) Anufrieva, N. M. ; Nesterova, M. P. : "Study of Polyurethane Foam as an Agent for Removing Petroleum from the Surface of Reservoirs"; Vodnye Resursy, 1976 (4), 149-53 (1976) [Chemical Abstracts, 86 #145532k (1977)]
- 70) Turbeville, J. E. : "A Ferromagnetic Sorbent System for Oil Spill Recovery"; Proceedings - Annual Offshore Technology Conference, 8(3), 883-88 (1976) [Chemical Abstracts, 88 #138784g (1978)]
- 71) Nesterova, M. P. ; Anufrieva, N. M. : "Composition for the Removal of Petroleum from the Surface of Water"; Patent, U.S.S.R. 542,730 ; Jan. 15, 1977 [Chemical Abstracts, 86 #145324u (1977)]
- 72) Murakami, Y. ; Hagiwara, K. ; Saito, T. ; Ozasa, Y. ; Higashi, K. : "Control of Dispersion of Oil Spills Using an Oil Collecting Agent"; Osaka Kogyo Gijutsu Shikensho Kiho, 28(1), 12-17 (1977) [Chemical Abstracts, 87 #186764b (1977)]
- 73) Kawakami, K. ; Moriyama, Y. ; Takuma, T. : "Recovery of Spilled Oil"; Patent, Japan. Kokai 77 80291 ; July 5, 1977 [Chemical Abstracts, 87 #188950h (1977)]
- 74) Ito, H. ; Oh, K. ; Sudo, T. ; Nagao, Y. : "Oil Removal from Waters"; Patent, Japan. 77 32870 ; Aug. 24, 1977 [Chemical Abstracts, 88 #110133v (1978)]
- 75) Fondekar, S. P. ; Sen Gupta, R. ; Bhandare, M. B. : "The Efficiency of Indigenously Manufactured Polyurethane Foams and Dispersants in the Removal of Spilled Oil"; Mahasagar, 10(3-4), 151-56 (1977) [Chemical Abstracts, 89 #91928k (1978)]
- 76) Sandstrom, K. : "Oil-Absorbing Material Consisting of Small Sections of a Foamed Plastic with Open Cells"; Patent, Sweden 399905 ; Mar. 6, 1978 [Chemical Abstracts, 89 #90833p (1978)]
- 77) Schaus, B. : "Apparatus for Separating a Liquid Component from a Liquid Mixture"; Patent, Ger. 2,352,508 : June 6, 1974 [Chemical Abstracts, 81 #93451h (1974)]
- 78) Amano, T. ; Shindo, M. : "Emulsified-Oil Removal from Waste Water"; Patent, Japan. Kokai 74,114,268; Oct. 31, 1974 [Chemical Abstracts, 84 #21754y (1976)]

- 79) Lozovskii, D. S. ; Khailovich, Yu. A. ; Kikhteva, V. I. ; Sevryukov, S. K. : "Use of Polyurethane Foam for Purifying Oil-Containing Waste Waters"; Vodosnabzhenie I Sanitarnaya Tekhnika, 1977 (4),28-30 (1977) [Chemical Abstracts, 87 #90191m (1977)]
- 80) Yoshida, C. ; Yoshimura, S. ; Nagai, T. : "Urethane Foam for Separation of Oil from Water"; Patent, Japan. Kokai 78 42191 ; Apr. 17, 1978 [Chemical Abstracts, 89 #25811r (1978)]
- 81) Schatzberg, P. ; Jackson, D. F. : "Remote Sampler for Determining Residual Oil Content of Surface Waters"; Joint Conference on Prevention and Control of Oil Spills, March 13-15, 1973 Washington, Proceedings, pp.139-44 (1973)
- 82) Webb, R. G. ; "Isolating Organic Water Pollutants: XAD Resins, Urethane Foams, Solvent Extraction"; U.S. Environmental Protection Agency Report PB 245 647, distributed by National Technical Information Service, June, 1975
- 83) Ahmed, S. M. ; Beasley, M. D. ; Efromson, A. C. ; Hites, R. A. : "Sampling Errors in Quantitation of Petroleum in Boston Harbor Water"; Analytical Chemistry, 46(12), 1858-60 (1974)
- 84) Marsh, H. E., Jr. : "Oil-Absorbing Polymers"; California Institute of Technology, Jet Propulsion Laboratory, Quarterly Technical Reviews, 1(1), 49-56 (1971)
- 85) Marsh, H. E., Jr. ; Wallace, C. J. : "Lipid-Absorbing Polymers"; Jet Propulsion Laboratory Quarterly Technical Review, 2(4), 1-6 (1973)
- 86) Marsh, H. E., Jr. ; Hsu, G.C. ; Wallace, C. J. ; Blankenhorn, D. H. : "Some Essential Polymer Characteristics for Absorption of Cholesterol and Other Lipids from Micellar Solutions"; American Chemical Society, Division of Organic Coatings and Plastics Chemistry, Papers, 33(2), 327-31 (1973)
- 87) Marsh, H. E., Jr. ; Hsu, G. C. ; Wallace, C. J. ; Blankenhorn, D. H. : "Interactions Between Polymers and Micellar Lipids" in Polymer Science and Technology, Volume 7, Biomedical Applications of Polymers, H. P. Gregor (editor), Plenum Press, N.Y., 1975, pp. 33-50
- 88) Marsh, H. E., Jr. : "Water-Insoluble, Swellable Polyurethanes"; Patent, U.S. 3,953,406 ; Apr. 27, 1976 [Chemical Abstracts, 85 #51754m (1976)]

- 89) Gesser, H. D. ; Chow, A. ; Davis, F. C. ; Uthe, J. F. ; Reinke, J. : "The Extraction and Recovery of Polychlorinated Biphenyls (PCB) Using Porous Polyurethane Foam"; Analytical Letters, 4(12), 883-86 (1971)
- 90) Gesser, H. D. ; Sparling, A. B. ; Chow, A. ; Turner, C. W. : "The Monitoring of Organic Matter with Polyurethane Foam"; Journal of the American Water Works Association, 65(4), 220-21 (1973)
- 91) Uthe, J. F. ; Reinke, J. ; Gesser, H. : "Extraction of Organochlorine Pesticides from Water by Porous Polyurethane Coated with Selective Absorbent"; Environmental Letters, 3(2), 117-35 (1972)
- 92) Bedford, J. W. : "The Use of Polyurethane Foam Plugs for Extraction of Polychlorinated Biphenyls (PCB's) from Natural Waters"; Bulletin of Environmental Contamination and Toxicology, 12(5), 622-25 (1974)
- 93) Musty, P.R. ; Nickless, G. : "The Extraction and Recovery of Chlorinated Insecticides and Polychlorinated Biphenyls from Water using Porous Polyurethane Foams"; Journal of Chromatography, 100, 83-93 (1974)
- 94) Musty, P. R. ; Nickless, G. : "Foams as Extractants for Organochlorine Insecticides, Polychlorobiphenyls and Heavy Metals from Water"; Proceedings of the Analytical Division of the Chemical Society, 12(11), 295-96 (1975)
- 95) Musty, P. R. ; Nickless, G. : "Extractants for Organochlorine Insecticides and Polychlorinated Biphenyls from Water"; Journal of Chromatography, 120, 369-78 (1976)
- 96) Lawrence, J. ; Tosine, H. M. : "Adsorption of Polychlorinated Biphenyls from Aqueous Solutions and Sewage"; Environmental Science and Technology, 10(4), 381-83 (1976)
- 97) Gough, K. M. ; Gesser, H. D. : "The Extraction and Recovery of Phthalate Esters from Water Using Porous Polyurethane Foam"; Journal of Chromatography, 115, 383-90 (1975)
- 98) Carmignani, G. M. ; Bennett, J. : "Filter Media for the Removal of Phthalate Esters in Water of Closed Aquaculture Systems"; Aquaculture, 8, 291-94 (1976)
- 99) Saxena, J. ; Kozuchowski, J. ; Basu, D. K. : "Monitoring of Polynuclear Aromatic Hydrocarbons in Water. I. Extraction and Recovery of Benzo(α)pyrene with Porous Polyurethane Foam"; Environmental Science and Technology, 11(7), 682-85 (1977)

- 100) Basu, D. K. ; Saxena, J. : "Monitoring of Polynuclear Aromatic Hydrocarbons in Water. II. Extraction and Recovery of Six Representative Compounds with Polyurethane Foams"; Environmental Science and Technology, 12(7), 791-95 (1978)
- 101) Basu, D. K. ; Saxena, J. : "Polynuclear Aromatic Hydrocarbons in Selected U.S. Drinking Waters and Their Raw Water Sources"; Environmental Science and Technology, 12(7), 795-98 (1978)
- 102) Tanaka, T. ; Hiro, K. ; Kawahara, A. : "Simple Method for the Determination of Alkylbenzene Sulfonate by Visual Colorimetry"; Bunseki Kagaku, 22(5), 523-27 (1973) [Chemical Abstracts, 79 (14), #87234 g (1973)]
- 103) Arkell, A. ; Schlicht, R. C. ; McCoy, F. C. : "Recovery of Cyclohexylbenzene Hydroperoxide from Reaction Mixtures"; Patent, U.S. 3,821,314 ; June 28, 1974 [Chemical Abstracts, 81 #77674c (1974)]
- 104) Gubela, H. E. : "Polyurethane Foam as Flotation Agents"; Patent, Ger. Offen. 2,306,178 ; Aug. 14, 1974 [Chemical Abstracts, 82 #64146c (1975)]
- 105) Matsuda, M. ; Masuda, H. : "Method for Recovering Polynitro Diphenylamine (PNDA)"; Patent, Japan. 76 09741 ; Mar. 30, 1976 [Chemical Abstracts 85 #148679d (1976)]
- 106) Schlicht, R. C. ; McCoy, F. C. : "Selective Adsorption of Phenols From Solution in Hydrocarbons"; Patent, U.S. 3,617,531 ; Feb, 1972 [Chemical Abstracts, 76 #155054 (1972)]
- 107) McCoy, F. C. ; Schlicht, R. C. : "Selective Adsorption of High Viscosity, Low Viscosity Index Components from Hydrocarbon Mixtures"; Patent, U.S. 3,890,219 ; June 17, 1975 [Chemical Abstracts, 83 #150215b (1975)]
- 108) Schlicht, R. C. ; McCoy, F. C. : "Removal of Unconsumed Reactants and Polar By-Products from Reaction Product Mixtures Through Adsorption on Polyurethane Foam"; Patent, U.S. 3,975,387 ; Aug. 17, 1976 [Chemical Abstracts, 86 #19364u (1977)]
- 109) Washburn, O. V. ; Kouvarellis, G. K. ; Ferguson, W. A. : Patent, Ger. Offen. 2,628,483 ; Jan. 20, 1977 [Chemical Abstracts, 86 #145591d (1977)]
- 110) Imanaka, Y. ; Yoshida, N. : "Polyurethane Foam Containing Catalysts for an Air Filter"; Patent, Japan. Kokai 74,131,986 ; Dec. 18, 1974 [Chemical Abstracts, 84 #126220z (1976)]

- 111) Bauman, E. K. ; Goodson, L. H. ; Guilbault, G. G. ; Kramer, D. N. : "Preparation of Immobilized Cholinesterase for Use in Analytical Chemistry"; Analytical Chemistry, 37(11), 1378-81 (1965)
- 112) Bauman, E. K. ; Goodson, L. H. ; Thomson, J. R. : "Stabilization of Serum Cholinesterase in Dried Starch Gel"; Analytical Biochemistry, 19, 587-92 (1967)
- 113) Goodson, L. H. ; Jacobs, W. B. ; Davis, A. W. : "An Immobilized Cholinesterase Product for Use in the Rapid Detection of Enzyme Inhibitors in Air or Water"; Analytical Biochemistry, 51, 362-67 (1973)
- 114) Goodson, L. H. ; Jacobs, W. B. : "Use of Immobilized Enzyme Product in Water Monitoring"; National Conference on the Control of Hazardous Material Spills, San Francisco, August 1974, Proceedings, pp. 292-99 (1974)
- 115) Goodson, L. H. ; Jacobs, W. B. : "Rapid Detection System for Organophosphates and Carbamate Insecticides in Water ; U.S. Environmental Protection Agency, Environmental Protection Technology Series, Report #EPA-R2-72-010, 1974
- 116) Goodson, L. H. ; Jacobs, W. B. ; Davis, A. W. : "Air Pollution-Monitoring System" Patent, U.S. 3,715,298 ; Feb. 6, 1973 [Chemical Abstracts, 78 #151065m (1973)]
- 117) Goodson, L. H. ; Jacobs, W. B. ; Davis, A. W. : "Air Pollution Monitoring"; Patent, U.S. 3,783,109 ; Jan. 1, 1974 [Chemical Abstracts, 81 #5948x (1974)]
- 118) Goodson, L. H. ; Jacobs, W. B. : "Monitoring of Air and Water for Enzyme Inhibitors", in Methods in Enzymology, Volume XLIV, Immobilized Enzymes, K. Mosbach (editor), Academic Press Inc., N.Y., 1976
- 119) Uthe, J. F. ; Reinke, J. ; O'Brodovich, H. : "Field Studies on the Use of Coated Porous Polyurethane Plugs as Indwelling Monitors of Organochlorine Pesticides and Polychlorinated Biphenyl Contents of Streams"; Environmental Letters, 6(2), 103-15 (1974)
- 120) Huckins, J. N. ; Stalling, D. L. ; Smith, W. A. : "Foam-Charcoal Chromatography for Analysis of Polychlorinated Dibenzodioxins in Herbicide Orange"; Journal of the Association of Official Analytical Chemists, 61(1), 32-38 (1978)

- 121) Higashi, K. ; Miyake, Y. : "Extraction of Metal Ions from Solutions by Fibers or Foams Impregnated with Ion-Exchanger Liquids"; Patent, Japanese Kokai 72 23374; Oct. 12, 1972 [Chemical Abstracts, 79 #83225g (1973)]
- 122) Braun, T. ; Huszar, E. ; Bakos, L. : "Reversed-Phase Foam Chromatography. Separation of Trace Amounts of Cobalt from Nickel in the Tri-n-octylamine - Hydrochloric Acid System"; Analytica Chimica Acta, 64, 77-84 (1973)
- 123) Braun, T. ; Farag, A. B. : "Chromofoams: Qualitative and Semi-Quantitative Tests with Chromogenic Organic Reagents Immobilized in Plasticized Open-Cell Polyurethane Foams"; Analytica Chimica Acta, 73, 301-9 (1974)
- 124) Vernon, F. : "Ion Exchange on LIX 65N and Kelex 100 Impregnated Foams"; Separation Science and Technology, 13(7), 587-95 (1978)
- 125) Palagyi, S. ; Bila, E. : "Separation of Radioiodine by Static and Dynamic Isotope Exchange on Hydrophobic Organic Phases Immobilized in Open-Cell Polyurethane Foam"; Radiochemical and Radioanalytical Letters 32(1-2), 87-102 (1978)
- 126) Palagyi, S. ; Markusova, R. : "Rapid Separation of Radioiodine from Milk by a Polyurethane Foam Column-Filtration Method"; Radiochemical and Radioanalytical Letters, 32(1-2), 103-12 (1978)
- 127) Palagyi, S. ; Braun, T. : "Pulsed Column Separation and Preconcentration of Radioiodine on Hydrophobic Organic Reagent Loaded Resilient Open-Cell Polyurethane Foam"; Journal of Radioanalytical Chemistry, 51(2), 267-79 (1979)
- 128) Braun, T. ; Bekeffy, O. ; Haklits, I. ; Kadar, K. ; Majoros, G. ; "Ion-Exchange Foam Chromatography. Part I. Preparation of Rigid and Flexible Ion-Exchange Foams"; Analytica Chimica Acta, 64, 45-54 (1973)
- 129) Braun, T. ; Farag, A. B. : "Ion-Exchange Foam Chromatography. Part II. Rapid Separations on Heterogeneous Cation-Exchange Foams"; Analytica Chimica Acta, 68, 119-30 (1974)
- 130) Braun, T. ; Farag, A. B. : "Static and Dynamic Isotope Exchange Separations on Finely Divided Precipitates Immobilized in Open-Cell Polyurethane Foams"; Radiochemical and Radioanalytical Letters, 19(4), 275-80 (1974)
- 131) Braun, T. ; Farag, A. B. : "Static and Dynamic Redox Exchange Separations on Finely Divided Copper Immobilized in Open-Cell Polyurethane Foam"; Radiochemical and Radioanalytical Letters, 19(5-6), 377-80 (1974)

- 132) Braun, T. ; Farag, A. B. : "Plasticized Open-Cell Polyurethane Foam as a Universal Matrix for Organic Reagents in Trace Element Preconcentration. Part I. Collection of Silver Traces on Dithizone Foam"; Analytica Chimica Acta, 69, 85-96 (1974)
- 133) Braun, T. ; Farag, A. B. : "Plasticized Open-Cell Polyurethane Foam as a Universal Matrix for Organic Reagents in Trace Element Preconcentration. Part II. Collection of Mercury Traces on Dithizone and Diethyldithiocarbamate Foams"; Analytica Chimica Acta, 71, 133-40 (1974)
- 134) Braun, T. ; Farag, A. B. : "Static and Dynamic Isotope Exchange Separations on Hydrophobic Organic Phases Immobilized in Plasticized Open-Cell Polyurethane Foams"; Journal of Radioanalytical Chemistry, 25, 5-16 (1975)
- 135) Braun, T. ; Farag, A. B. : "Plasticized Open-Cell Polyurethane Foam as a Universal Matrix for Organic Reagents in Trace Element Preconcentration. Part III. Collection of Cobalt Traces on 1-Nitroso-2-Naphthol and Diethyldithiocarbamate Foams"; Analytica Chimica Acta, 76, 107-12 (1975)
- 136) Lee, D. W. ; Halmann, M. : "Selective Separation of Nickel(II) by Dimethylglyoxime-treated Polyurethane Foam"; Analytical Chemistry, 48(14), 2214-18 (1976)
- 137) Valente, I. ; Bowen, H. J. M. : "A Method of Concentrating Antimony from Natural Waters"; Analytica Chimica Acta, 90, 315-18 (1977)
- 138) Srikameswaran, K. ; Gesser, H. D. : "A Novel Method for the Concentration and Determination of Trace Elements in Water"; Journal of Environmental Science and Health, A13(7), 415-27 (1978)
- 139) Braun, T. ; Farag, A. B. : "Foam Chromatography. Solid Foams as Supports in Column Chromatography"; Talanta, 19, 828-30 (1972)
- 140) Braun, T. ; Farag, A. B. : "Reversed-Phase Foam Chromatography. Separation of Palladium, Bismuth and Nickel in the Tributyl Phosphate - Thiourea - Perchloric Acid System"; Analytica Chimica Acta, 61, 265-75 (1972)
- 141) Braun, T. ; Farag, A. B. : "A New Method for Column Packing in Reversed-Phase Chromatography"; Analytica Chimica Acta, 62, 476-80 (1972)

- 142) Braun, T. ; Farag, A. B. : "Reversed-Phase Foam Chromatography. Chemical Enrichment and Separation of Gold in the Tributylphosphate - Thiourea - Perchloric Acid System,; Analytica Chimica Acta, 65, 115-26 (1973)
- 143) Braun, T. ; Bakos, L. ; Szabo, Zs. : "Reversed Phase Foam Chromatography. Separation of Iron from Copper, Cobalt and Nickel in the Tri-n-Butyl Phosphate -Hydrochloric Acid System"; Analytica Chimica Acta, 66, 57-66 (1973)
- 144) Braun, T. ; Farag, A. B. ; Klimes-Szmik, A. : "Reversed-Phase Foam Chromatography, Redox Reactions on Open-Cell Polyurethane Foam Columns Supporting Tetrachlorohydroquinone"; Analytica Chimica Acta, 64, 71-76 (1973)
- 145) Braun, T. ; Farag, A. B. : "Pulsed Column Redox Techniques with Flexible Foam Fillings"; Analytica Chimica Acta, 65, 139-45 (1973)
- 146) Szabo, Z. ; Braun, T. ; Haklits, I. : "Fixation of Hydrophobic Chelate-Forming Organic and Complex-Forming Inorganic Analytical Reagents in Open Cell Polymer Foams for the Detection, Separation and Enrichment of Tracer Elements and Radioisotopes"; Patent, Hungary Teljes. 12407 ; Oct. 28, 1976 [Chemical Abstracts, 86 #122536a (1977)]
- 147) Grégoire, D. C. : "The Separation of Platinum and Palladium by Foam Chromatography"; M.Sc. Thesis, Chemistry Department, University of Manitoba, 1974
- 148) Grégoire, D. C. ; Chow, A. : "The Separation of Platinum and Palladium with Silicone-Rubber Foam Treated with Dimethylglyoxime" Talanta, 22, 453-58 (1975)
- 149) Baghai, A. ; Bowen, H. J. M. : "Separation of Rhodium and Iridium Using Silicone Rubber Foam Treated with Tri-n-Octylamine"; Analyst, 101, 661-65 (1976)
- 150) Mage, M. G. ; Evans, W. H. ; Peterson, E. A. : "Enrichment of Antibody Plaque-Forming Cells by Immunoabsorption to an Antigen-Coated Polyurethane Foam"; The Journal of Immunology, 102(4), 908-10 (1969)
- 151) Mazurski, M. A. J. ; Chow, A. ; Gesser, H. D. : "A Method for the Extraction of Mercury from Aqueous Solution"; Analytica Chimica Acta, 65, 99-104 (1973)
- 152) Nyssen, G. A. ; Jones, M. M. : "Detoxification by Chemical Entrapment"; Chemtech, 1978, 546-50 (1978)

- 153) U.S.A., Institute of Gas Technology : "Eliminating Corrosive Constituents of a Gas Using a Membrane"; Patent, France Demande 2,310,326 ; Dec. 3, 1976 [Chemical Abstracts, 87 #154712s (1977)]
- 154) Elfert, K. ; Rosenkranz, H. J. ; Rudolph, H. : "Separation of Aromatic Hydrocarbon from Mixtures Using Polyurethane Membranes"; Patent, Ger. Offen. 2,627,629 ; Dec. 22, 1977 [Chemical Abstracts, 88 #136277v (1978)]
- 155) Davis, J. C. ; Stevens, R. C. : "Hollow Fiber Separatory Device"; Patent, U.S. 3,962,094 ; June 8, 1976 [Chemical Abstracts, 86 #18842m (1977)]
- 156) Gesser, H. D. ; Horsfall, G. A. ; Gough, K. M. ; Krawchuk, B. : "Transport of Metal Complex Chlorides Through Plastic Film Membrane"; Nature, 268, 323-24 (1977)
- 157) Zentner, G. M. ; Cardinal, J. R. ; Kim, S. W. : "Progesterone Permeation Through Polymer Membranes. I : Diffusion Studies on Plasma-Soaked Membranes"; Journal of Pharmaceutical Science, 67(10), 1347-51 (1978) [Chemical Abstracts, 89 #204112k (1978)]
- 158) Barrie, J.A. ; Nunn, A. ; Sheer, A. : "The Sorption and Diffusion of Water in Polyurethane Elastomers"; Polymer Science and Technology, 6, 167-82 (1974) [Chemical Abstracts, 86 #172801d (1977)]
- 159) Illinger, J. L. ; Schneider, N. S. ; Karasz, F. E. : "Water Vapour Transport in Hydrophilic Polyurethanes"; Polymer Science and Technology, 6, 183-96 (1974) [Chemical Abstracts, 86 #190739u (1977)]
- 160) Tager, A. A. ; Dul'tseva, L. D. : "Sorption of Dioxane Vapours by Elastomeric and Glassy Reticular Polyurethanes and Thermodynamics of this Process"; Vysokomolekularnye Soedineniya, Seriya A, 18(4), 853-62 (1976) [Chemical Abstracts, 85 #95005x (1976)]
- 161) Lipatnikov, N. A. ; Makarevich, I. P. ; Sukhorukova, S. A. : "Sorption and Diffusion of Methyl Alcohol by Polyurethanes"; Struktura I Mekhanicheskie Svoistva Vysokomolekulyarnykh Soedinenii, "Naukova Dumka", Kiev, USSR, 1976, 102-8 (1976) [Chemical Abstracts, 87 #118556k (1977)]
- 162) Salyer, I. O. ; Schwendeman, J. L. ; Jefferson, R. T. : "Polyurethane Precipitation Foam"; presented at the 156th National Meeting, American Chemical Society, Atlantic City, N.J., September 8-14, 1968
- 163) Jefferson, R. T. ; Salyer, I. O. : "Open-Pore Polyurethane Product"; Patent, U.S. 3,574,150 ; Apr. 6, 1971 [Chemical Abstracts, 75 #6891m (1971)]

- 164) Ross, W. D. ; Jefferson, R. T. : "In Situ-Formed Open-Pore Polyurethane as Chromatography Supports"; Journal of Chromatographic Science, 8, 386-89 (1970)
- 165) Anonymous : "Formed-in-place Polymer is Good GC Support"; Chemical and Engineering News, 48 (June 29), 44 (1970)
- 166) Salyer, I. O. ; Jefferson, R. T. ; Ross, W. D. : "Polyurethane Support for a Chromatographic Column for Separating Organic Compounds"; Patent, U.S. 3,580,843 ; May 25, 1971 [Chemical Abstracts, 75 #64833e (1971)]
- 167) Salyer, I. O. ; Jefferson, R. T. ; Pustinger, J. V. ; Schwendeman, J. L. : "Preparation and Properties of Open Pore Polyurethane (OPP)"; Journal of Cellular Plastics, 9(1), 25-34 (1973)
- 168) Hileman, F. D. ; Sievers, R. E. ; Hess, G. G. ; Ross, W. D. : "In Situ Preparation and Evaluation of Open Pore Polyurethane Chromatographic Columns"; Analytical Chemistry, 45(7), 1126-30 (1973)
- 169) Chen, T. M. ; Hess, G. G. ; Sievers, R. E. : "Improvements in Gas Chromatographic Columns Formed by In Situ Polymerization"; Journal of Chromatography, 134, 170-73 (1977)
- 170) Lynn, T. R. ; Rushneck, D. R. ; Cooper, A. R. : "High Resolution - Low Pressure Liquid Chromatography"; Journal of Chromatographic Science, 12, 76-79 (1974)
- 171) Hansen, L. C. ; Sievers, R. E. : "Highly Permeable Open-Pore Polyurethane Columns for Liquid Chromatography"; Journal of Chromatography, 99, 123-33 (1974)
- 172) Cooper, A. R. ; Lynn, T. R. : "Coiled High-Efficiency Liquid Chromatography Columns"; Separation Science, 11(1), 39-44 (1976)
- 173) Tollinche, C. A. ; Risby, T. H. : "Liquid Chromatography of Metal Chelates"; Journal of Chromatographic Science, 16, 448-54 (1978)
- 174) Navratil, J. D. ; Sievers, R. E. ; Walton, H. F. : "Open-Pore Polyurethane Columns for Collection and Preconcentration of Polynuclear Aromatic Hydrocarbons from Water"; Analytical Chemistry, 49(14), 2260-63 (1977)
- 175) Smith, C. M. ; Navratil, J. D. : "Removal and Preconcentration of Surfactants from Wastewater with Open-Pore Polyurethane"; Separation Science and Technology, 14(3), 255-59 (1979)

- 176) "Chemistry and Biochemistry of Thiocyanic Acid and its Derivatives", Newman, A. A. (editor); Academic Press, London (1975) pp. 13-17, 37
- 177) Jones, L. H. : "Infrared Spectrum and Structure of the Thiocyanate Ion"; Journal of Chemical Physics, 25, 1069-72 (1956)
- 178) Chamberlain, M. M. ; Bailar, J. C. Jr. : "The Infrared Spectra of Some Thiocyanatocobalt Ammines"; Journal of the American Chemical Society, 81, 6412-15 (1959)
- 179) Schaffer, C. E. : "Coordination of Thiocyanate Ion: Its Effects upon the Spectra of Metal Ions"; in Chemical Society Special Publication No. 13, International Conference on Coordination Chemistry, London, 1959, pg. 153
- 180) Baldwin, M. E. : "The Infrared Spectra of Cobalt(III) Ethylenediamine Complexes. Part II. Compounds containing the Thiocyanate Group"; Journal of the Chemical Society, 1961, 471-73 (1961)
- 181) Mitchell, P. C. H.; Williams, R. J. P. : "The Infrared Spectra and General Properties of Inorganic Thiocyanates"; Journal of the Chemical Society, 1960, 1912-18 (1960)
- 182) Turco, A. ; Pecile, C. : "Coordination of the Thiocyanate Group in Inorganic Compounds"; Nature, 191, 66-67 (1961)
- 183) Fronaeus, S. ; Larsson, R. : "Studies on Metal Complexes in Aqueous Solution by Infrared Spectrophotometry. III. Further Investigations on Thiocyanato Complexes."; Acta Chemica Scandinavica, 16, 1447-54 (1962)
- 184) Fronaeus, S. ; Larsson, R. : "Studies on Metal Complexes in Aqueous Solution by Infrared Spectrophotometry. II. An Investigation of Some First-Row Transition Metal Thiocyanato Complexes."; Acta Chemica Scandinavica, 16, 1433-46 (1962)
- 185) Lewis, J. ; Nyholm, R. S. ; Smith, P. W. : "The Structure of Complex Molybdenum (III) Thiocyanates"; Journal of the Chemical Society, 1961, 4590-99 (1961)
- 186) Forster, D. ; Goodgame, D. M. L. : "Infrared Spectra (400-200 cm^{-1}) of Some Thiocyanate and Isothiocyanate Complexes"; Inorganic Chemistry, 4(5), 715-18 (1965)
- 187) Bailey, R. A. ; Kozak, S. L. ; Michelsen, T. W. ; Mills, W. N. : "Infrared Spectra of Complexes of the Thiocyanate and Related Ions"; Coordination Chemistry Reviews, 6, 407-45 (1971)

- 188) Polasek, M. ; Bartusek, M. : "Thiocyanate Complexes of Bivalent Metals in Dilute Aqueous Solutions."; Scripta Fac. Sci. Nat. Ujep Brunensis, Chemia, 2(1), 109-18 (1971)
- 189) Kabesova, M. ; Kohout, J. ; Gazo, J. : "Effect of Bridging Mode of the Thiocyanate Group in Compounds on Infrared Spectra"; Inorganica Chimica Acta, 31, L435-36 (1978)
- 190) Pearson, R. G. : "Hard and Soft Acids and Bases, HSAB, Part I: Fundamental Principles"; Journal of Chemical Education, 45(9), 581-87 (1968)
- 191) Pearson, R. G. : "Hard and Soft Acids and Bases, HSAB, Part II: Underlying Theories"; Journal of Chemical Education, 45(10), 643-48 (1968)
- 192) Kolthoff, I. M. : "The Cobalt Thiocyanate Reaction for the Detection of Cobalt and Thiocyanate"; Mikrochemie, 2, 176-81 (1930) [Chemical Abstracts, 24, #4235 (1930)]
- 193) Martini, A. : "A Microchemical Test for the Identification and Differentiation of Chromate, Dichromate and Thiocyanate Ions"; Publicaciones del Instituto de Investigaciones Microquimicas, Universidad Nacional del Litoral (Rosario, Argentina), 4, 25-9 (1940) [Chemical Abstracts, 36 #366 (1942)]
- 194) Zhivopistsev, V. P. : "Possible Applications of Diantipyrylmethane in Inorganic Analysis"; Doklady Akademii Nauk SSSR, 73, 1193-96 (1950) [Chemical Abstracts, 45, # 492h (1951)]
- 195) Zharovs'kii, F. G. : "Fine Detection of Thiocyanate by Extraction". Ukrains'kii Khemichaii Zhurnal, 22, 232-33 (1956) [Chemical Abstracts, 50, #12752d (1956)]
- 196) Hashmi, M. H. ; Chughtai, N. A. ; Shahid, M. A. : "Microidentification of Twenty Anions by the Nichrome Wire Ring Chamber"; Mikrochimica Acta, 1968, 1237-43 (1968) [Chemical Abstracts, 70, #33959t (1969)]
- 197) Senise, P. ; Perrier, M. : "Ultraviolet Spectrophotometric Determination of Thiocyanate"; Universidade Sao Paulo, Faculdade de Filosofia, Cienciase Letras, Boletim, Botanica, 5, 27-37 (1959) [Chemical Abstracts, 57, #13182 (1959)]
- 198) Sultanova, Z. Kh. ; Chuchalin, L. K. ; Iofa, B. Z. ; Zolotov, Yu. A. : "Extraction of Metal Thiocyanate Complexes"; Journal of Analytical Chemistry of the U.S.S.R., 28, 369-89 (1973)
- 199) Singh, D. ; Tandon, S. N. : "Anion-Exchange Studies of Metal Thiocyanates in Aqueous and Mixed Solvent Systems"; Talanta, 26(2), 163-65 (1978)

- 200) "Comprehensive Inorganic Chemistry", Volume III; Bailar, J. C. Jr. ; Emel us, H. J. ; Nyholm, R. ; Trotman-Dickenson, A. F. (editors) ; Pergamon Press, London, 1973 pp. 1053-1107
- 201) Cotton, F. A. ; Wilkinson, G. : "Advanced Inorganic Chemistry", 3rd edition, Interscience Publishers, New York, 1972 p. 645, 330, 376, 875-90
- 202) Morral, F. R. : "Cobalt and Cobalt Alloys", "Cobalt Compounds" in Kirk-Othmer Encyclopedia of Chemical Technology, 2nd edition, H.F. Mark (editor), Interscience Publishers, New York, 1970, Volume 5, pp. 716-48
- 203) "Cobalt. Its Chemistry, Metallurgy and Uses"; R. S. Young (editor), Reinhold Publishing Corporation, New York, 1960
- 204) Howell, O. R. ; Jackson, A. : "The Absorption Spectrum of Potassium Cobaltous Thiocyanate"; Journal of the Chemical Society, 1937, 621-26 (1937)
- 205) Bobtelsky, M. ; Spiegler, K. S. : "The Cobalt Halide and Thiocyanate Complexes in Ethyl-alcoholic Solution"; Journal of the Chemical Society, 1949, 143-48 (1949)
- 206) Katzin, L. I. ; Gebert, E. : "Spectrophotometric Studies of Cobalt(II) Thiocyanate Complexes in Organic Solvents"; Journal of the American Chemical Society, 72, 5659-62 (1950)
- 207) Gutmann, V. ; Buhunovsky, O. : "Rhodano-, Azido- und Cyanokomplexe von Kobalt(II) in einigen nichtwässrigen Lösungsmitteln"; Monatshefte für Chemie, 99, 751-62 (1968)
- 208) Antipova-Karataeva, I. I. ; Sultanova, Z. Kh. ; Zolotov, Yu. A. : "Spectrophotometric Study of the Thiocyanate Complexes of Cobalt(II) and Iron(III) in Connection with their Extraction"; Journal of Analytical Chemistry of the U.S.S.R., 28, 996-1000 (1973)
- 209) Turco, A. ; Pecile, C. ; Nicolini, M. : "Tetrahedral Isoselenocyanato-complexes of Cobalt(II) and Infrared Spectra of Inorganic Selenocyanates"; Journal of the Chemical Society, 1962, 3008-15 (1962)
- 210) Holm, R. H. ; Cotton, F. A. : "Magnetic Investigations of Spin-Free Cobaltous Complexes. II. Tetrahedral Complexes."; Journal of Chemical Physics, 32(4), 1168-72 (1960)
- 211) Cotton, F. A. ; Goodgame, D. M. L. ; Goodgame, M. ; Sacco, A. : "Magnetic Studies of High-Spin Cobaltous Compounds. VII. Some Thiocyanate Complexes."; Journal of the American Chemical Society, 83, 4157-61 (1961)

- 213) Misumi, S. ; Aihara, M. ; Kinoshita, S. : "Polarographic Studies of Some Metal(II)-Thiocyanate Complexes in Acetonitrile"; Bulletin of the Chemical Society of Japan, 47(1), 127-30 (1974)
- 214) Szabo-Akos, Zs. ; Izvekov, V. ; Pungor, E. : "Cobalt(II) and Nickel(II) Thiocyanate Complexes in Acetone"; Mikrochimica Acta, 1974(2), 187-201 (1974)
- 215) Tribalat, S. ; Zeller, C. : "Complexes thiocyanate de cobalt dans l'eau et dans la méthylisobutylcétone."; Bulletin de la Société Chimique de France, 1962, 2041-47 (1962)
- 216) "Handbook of Analytical Chemistry", 1st edition; Louis Meites (editor); McGraw-Hill Book Co., New York, 1963 pp. 3-7
- 217) Koosis, Donald J. : Statistics; John Wiley & Sons, Inc., New York, 1972
- 218) Beers, Yardley : Introduction to the Theory of Error; Addison-Wesley Publ. Co. , Cambridge, Mass., 1953
- 219) De, A. K. ; Khopkar, S. M. ; Chalmers, R. A. : Solvent Extraction of Metals ; Van Nostrand Reinhold Co., London, 1970 p. 2
- 220) Shoemaker, D. P. ; Garland, C. W. ; Steinfeld, J. I. : Experiments in Physical Chemistry; 3rd edition, McGraw-Hill Inc., New York, 1974 p. 58
- 221) Friedlander, G. ; Kennedy, J. W. : Nuclear and Radiochemistry, John Wiley and Sons, Inc. ; New York, 1962 pp. 6-8, 265-66
- 222) Nielsen J. M. : The Radiochemistry of Iron; National Academy of Sciences, National Research Council, 1960, p. 16
- 223) Fischer, R. B. ; Peters, D. G. : Quantitative Chemical Analysis, 3rd edition; W. B. Saunders Company, Philadelphia, Pennsylvania, 1968 p. 829
- 224) Sillen, L. G. : Stability Constants of Metal-Ion Complexes. Supplement No. 1, Part I; Special Publication No. 25, The Chemical Society, Burlington House, London, 1971 pp. 59-70
- 225) Oren, J. J. , Research Associate, University of Manitoba Chemistry Department, private communication (1978)
- 226) Handbook of Chemistry and Physics, 48th Edition; R. C. Weast (editor); The Chemical Rubber Company, Cleveland Ohio, 1967 p. F-143

- 227) Mahan, B. H. : Elementary Chemical Thermodynamics; W. A. Benjamin, Inc., New York, 1964 pp. 103 ff.
- 228) Lehné, M. : "No. 13. Etude sur les complexes en solution. Sulfocyanures de cobalt."; Bulletin de la Societé Chimique de France, 1951, 76-81 (1951)
- 229) Handbook of Chemistry and Physics, 48th Edition; R. C. Weast (editor); The Chemical Rubber Company, Cleveland, Ohio, 1967 p. D-92
- 230) Sillen, L. G. ; Martell, A. E. : Stability Constants of Metal-Ion Complexes, Special Publication No. 17, The Chemical Society, Burlington House, London, 1964
- 231) Nancollas, G. H. ; Torrance, K. : "Thermodynamics of Ion Association. XIV. Metal Monothiocyanate Complexes"; Inorganic Chemistry, 6(8), 1567-69 (1967)
- 232) Rieman, W. ; Walton, H. F. : Ion Exchange in Analytical Chemistry; Pergamon Press, New York, 1970, p. 43-44
- 233) Moore, W. J. : Physical Chemistry, 3rd Editon, Prentice-Hall Inc., Englewood Cliffs, N. J. , 1962 pp. 351-52
- 234) Ionov, V. P. ; Zolotov, Yu. A. : "Dependence of Activity Coefficient on Electrolyte Concentration"; Doklady Physical Chemistry, 223(4), 807-9 (1975)
- 235) Levashova, L. B. ; Darienko, E. P. ; Degtyarev, V. F. : "Investigation of the Distribution of Cobalt Thiocyanates in Two Nonmiscible Solvents by the Method of Radioactive Indicators."; Journal of General Chemistry of the U.S.S.R., 25, 1025-30 (1955)
- 236) Hypol Foamable Hydrophilic Polymers, Laboratory Procedures and Foam Formulations; distributed by the Dewey and Almy Chemical Division of W. R. Grace and Company, Whittemore Ave., Cambridge, Massachusetts, 1975
- 237) Samuelson, O. : Ion Exchange Separations in Analytical Chemistry; John Wiley and Sons, New York, 1963 pp. 73-74
- 238) Ivanov, I. M. ; Gindin, L. M. ; Chichagova, G. N. : "Thermodyanamic Characteristics of the Extraction of Anions"; Proceedings of The International Solvent Extraction Conference (ISEC 74), 2, 1391-98 (Sept. 1974) Lyons, France, published by the Society of Chemical Industry, London, 1974

- 239) Bierman, W. J. ; McCorkell, R. : "Liquid-Liquid Extraction of Beryllium. I. A Study of Factors Affecting Extraction"; Canadian Journal of Chemistry, 40, 1368-73 (1962)
- 240) Fischer, R. B. ; Peters, D. G. : Quantitative Chemical Analysis, 3rd edition; W. B. Saunders Co., Philadelphia, Pa., 1968 pp. 834-35
- 241) Handbook of Chemistry and Physics, 57th edition; R. C. Weast (editor), Chemical Rubber Co. Press, Cleveland, Ohio, 1976 p. D-147
- 242) Morrison, R. T. ; Boyd, R. N. : Organic Chemistry, 3rd edition; Allyn and Bacon, Inc., Boston, Mass., 1973 pp. 729-30
- 243) Korolev, B. A. ; Malt'tseva, M. A. ; Tarasov, A. I. ; Vasnev, V. A. : "Basicity of Amines and Solvation of Substituted Ammonium Ions in Nitromethane"; Zhurnal Obschei Khimii, 44, 864-69 (1974)
- 244) Dickinson, J. R. ; Griffiths, T. R. ; Potts, P. J. : "Some Applications of Computer Techniques to Absorption Spectra. Thiocyanate - Cobalt(II) Interactions in Dimethyl Sulphoxide"; Journal of Inorganic and Nuclear Chemistry, 37, 511-20 (1975)
- 245) Specker, H. ; Werding, G. : "Kobaltverbindungen in Verteilungssystemen"; Zeitschrift für Analytische Chemie, 200(5), 337-51 (1964)
- 246) Gutmann, V. ; Wegleitner, K. H. : "Halogen- und Pseudohalogenkomplexe von Kobalt(II) in Nitromethan"; Monatshefte für Chemie, 99, 368-79 (1968)
- 247) Heitner-Wirguin, C. ; Ben-Zwi, N. : "Cobalt (II) Thiocyanate Species Sorbed on Ion Exchangers" ; Inorganica Chimica Acta, 6(1), 93-96 (1972)
- 248) Pedersen, C. J. : "Cyclic Polyethers and their Complexes with Metal Salts"; Journal of the American Chemical Society, 89(10), 2495-96 (1967)
- 249) Pedersen, C. J. : "Cyclic Polyethers and Their Complexes with Metal Salts"; Journal of the American Chemical Society, 89(26), 7017-36 (1967)
- 250) Dalley, N. K. ; Smith, D. E. ; Izatt, R. M. ; Christensen, J. J. : "X-ray Crystal Structure of the Barium Thiocyanate Complex of the Cyclic Poly-ether Dicyclohexyl-18-Crown-6 (Isomer A)"; Journal of the Chemical Society, Chemical Communications, 1972, 90-91 (1972)

- 251) Pedersen, C. J. : "Ionic Complexes of Macrocyclic Polyethers"; Federation Proceedings, 27(6), 1305-09 (1968)
- 252) Pedersen, C. J. : "New Macrocyclic Polyethers"; Journal of the American Chemical Society, 92(2), 391-94 (1970)
- 253) Pedersen, C. J. : "Crystalline Salt Complexes of Macrocyclic Polyethers"; Journal of the American Chemical Society, 92(2), 386-91 (1970)
- 254) Frensdorff, H. K. : "Stability Constants of Cyclic Polyether Complexes with Univalent Cations"; Journal of the American Chemical Society, 93(3), 600-606 (1971)
- 255) Frensdorff, H. K. : "Salt Complexes of Cyclic Polyethers. Distribution Equilibria"; Journal of the American Chemical Society, 93(19), 4684-88 (1971)
- 256) Pedersen, C. J. ; Frensdorff, H. K. : "Macrocyclic Polyethers and their Complexes"; Angewandte Chemie International Edition, 11(1), 16-25 (1972)
- 257) Kolthoff, I. M. : "Application of Macrocyclic Compounds in Chemical Analysis"; Analytical Chemistry, 51(5), 1R-22R (1979)
- 258) Hogen Esch, T. E. ; Smid, J. : "Ion-Pair Structures of Divalent Carb anion Salts"; Journal of the American Chemical Society, 91(16), 4580-81 (1969)
- 259) Wong, K. H. ; Konizer, G. ; Smid, J. : "Binding of Cyclic Polyethers to Ion Pairs of Carbanion Alkali Salts"; Journal of the American Chemical Society, 92(3), 666-70 (1970)
- 260) Parsons, D. G. ; Truter, M. R. ; Wingfield, J. N. : "Alkali Metal Tetraphenylborate Complexes with Some Macrocyclic, "Crown", Polyethers"; Inorganica Chimica Acta, 14, 45-48 (1975)
- 261) Parsons, D. G. ; Wingfield, J. N. : "Alkali Earth Metal Complexes with Some Macrocyclic 'Crown' Polyethers"; Inorganica Chimica Acta, 18, 263-67 (1976)
- 262) Farago, M. E. : "Transition Metal Complexes of "Crown" Ethers"; Inorganica Chimica Acta, 25, 71-76 (1977)
- 263) Koryta, J. ; Mittal, M. L. : "Electroreduction of Monovalent Metal Ion Complexes of Macrocyclic Polyethers"; Journal of Electroanalytical Chemistry, 36, App. 14-19 (1972)

- 264) Danesi, P. R. ; Meider-Gorican, H. ; Chiarizia, R. ; Capuano, V. ; Scibona, G. : "Alkali Metals Extraction by the Cyclic Polyether Dibenzo-18-Cr-6"; Proceedings of the International Solvent Extraction Conference (ISEC 74), 2, 1761-74 (Sept. 1974) Lyons, France, published by the Society of Chemical Industry, London, 1974
- 265) Danesi, P. R. ; Meider-Gorican, H. ; Chiarizia, R. ; Scibona, G. : "Extraction Selectivity of Organic Solutions of a Cyclic Polyether with Respect to the Alkali Cations"; Journal of Inorganic and Nuclear Chemistry, 37, 1479-83 (1975)
- 266) Danesi, P. R. ; Chiarizia, R. ; Fabiani, C. ; Domenichini, C. : "Association of the Cyclic Polyether-Alkali Cation Complexes with Thiocyanate Anions in Non-Aqueous Solvents"; Journal of Inorganic and Nuclear Chemistry, 38, 1226-28 (1976)
- 267) Tusek-Bozic, Lj. ; Danesi, P. R. : "Complexation of Some Substituted Macrocyclic Polyethers with Alkali Metal Cations in Methanol, Dimethylsulfoxide and Acetonitrile"; Journal of Inorganic and Nuclear Chemistry, 41, 833-37 (1979)
- 268) Jawaid, M. ; Ingman, F. : "Ion-Pair Extraction of Na^+ , K^+ and Ca^{2+} with Some Organic Counter-Ions and Dicyclohexyl-18-Crown-6 as Adduct-Forming Reagent"; Talanta, 25, 91-95 (1978)
- 269) Timko, J. M. ; Helgeson, R. C. ; Newcomb, M. ; Gokel, G. W. ; Cram, D. J. : "Structural Parameters that Control Association Constants Between Polyether Host and Alkylammonium Guest Compounds"; Journal of the American Chemical Society, 96(22), 7097-99 (1974)
- 270) Newcomb, M.; Cram, D. J. : "Effect of Centered Functional Groups on Complexing Properties of Cyclic Polyether Hosts"; Journal of the American Chemical Society, 97(5), 1257-59 (1975)
- 271) DeJong, F. ; Reinhoudt, D. N. ; Smit, C. J. : "On the Role of Water in the Complexation of Alkylammonium Salts by Crown Ethers"; Tetrahedron Letters, 17, 1371-74 (1976)
- 272) DeJong, F. ; Reinhoudt, D. N. ; Smit, C. J. : "Complexation of Alkylammonium Salts by Crown Ethers Under Anhydrous Conditions"; Tetrahedron Letters, 17, 1375-78 (1976)
- 273) Shchori, E. ; Jagur-Grodzinski, J. : "Protonation of Macrocyclic Polyethers. Complexes with Hydrogen Bromide and Hydrogen Tri-bromide in Chloroform"; Journal of the American Chemical Society, 94(23), 7957-62 (1972)

- 274) Izatt, R. M. ; Nelson, D. P. ; Rytting, J. H. ; Haymore, B. L. ; Christensen, J. J. ; "A Calorimetric Study of the Interaction in Aqueous Solution of Several Uni- and Bivalent Metal Ions with the Cyclic Polyether Dicyclohexyl-18-Crown-6 at 10, 25 and 40°"; Journal of the American Chemical Society, 93(7), 1619-23 (1971)
- 275) Sadakane, A. ; Iwachido, T. ; Toei, K. : "The Extraction of Alkali Metal Picrates with Dibenzo-18-Crown-6; Bulletin of the Chemical Society of Japan, 48(1), 60-63 (1975)
- 276) Kodama, M. ; Kimura, E. : "Equilibria of Complex Formation in Aqueous Solution Between Lead(II) and Thallium(I) Ions, and Cyclic and Linear Polyethers"; Bulletin of the Chemical Society of Japan, 49(9), 2465-68 (1976)
- 277) Hasek, J. ; Huml, K. ; Hlavata, D. : "The Structure of a Complex Between Rubidium Thiocyanate, Water and Dibenzo-[b,q][1,4,7,10,13,16,19,22,25,28] decaoxacyclotriacontane (Dibenzo-30-Crown-10)."; Acta Crystallographia, B35, 330-34 (1979)
- 278) Dale, J. ; Kristiansen, P. O. : "Macrocyclic Oligo-ethers Related to Ethylene Oxide"; Acta Chemica Scandinavica, 26, 1471-78 (1972)
- 279) Tsatsas, A. T. ; Stearns, R. W. ; Risen, W. M. Jr. : "The Nature of Alkali Metal Ion Interactions with Cyclic Polyfunctional Molecules. I. Vibrations of Alkali Ions Encaged by Crown Ethers in Solution"; Journal of the American Chemical Society, 94(15), 5247-53 (1972)
- 280) Tusek, Lj. ; Meider-Gorican, H. ; Danesi, P. R. : "Alkali and Alkaline Earth Perchlorate and Picrate Complexes with some Macrocyclic Polyethers"; Zeitschrift fur Naturforschung, 31B, 330-35 (1976)
- 281) Marcus, Y. ; Asher, L. E. : "Extraction of Alkali Halides from Their Aqueous Solutions by Crown Ethers"; Journal of Physical Chemistry, 82(11), 1246-54 (1978)
- 282) Rais, J. ; Kyrs, M. ; Kadlecova, L. : "Extraction of some Univalent and Bivalent Metals in the Presence of Macrocyclic Polyether"; Proceedings of the International Solvent Extraction Conference (ISEC 74), 2, 1705-15 (Sept. 1974) Lyons, France, published by the Society of Chemical Industry, London, 1974

- 283) Yoshio, M. ; Ugamura, M. ; Noguchi, H. ; Nagamatsu, M. : "Analytical Applications of Crown Ether Extraction of Cobalt Thiocyanate Complex with Ammonium-Crown Ether Complex."; Analytical Letters, All(4), 281-86 (1978)
- 284) Lada, W. A. ; Smulek, W. : "Separation of Alkali Earth Metals by Extraction Chromatography Using Dibenzo-18-Crown-6"; Radiochemical and Radioanalytical Letters, 34(1), 41-50 (1978)
- 285) Smulek, W. ; Lada, W. : "Separation of Alkali Metals by Extraction Chromatography Using Polyethers"; Radiochemical and Radioanalytical Letters, 30(3), 199-208 (1977)
- 286) Rais, J. ; Selucky, P. : "New Extraction Agents for Cesium. III. Complex formed Between Some Cesium Salts and 2,3,11,12-dibenzo-1,4,7,10,13,16-hexaoxocyclooctadeca-1,11-diene (Dibenzo-18-Crown-6)"; Radiochemical and Radioanalytical Letters, 6(4), 257-64 (1971)
- 287) Tusek, Lj. ; Danesi, P. R. ; Chiarizia, R. : "A Cyclic Polyether Suitable for Alkali Cations Solvent Extraction Procedures"; Journal of Inorganic and Nuclear Chemistry, 37, 1538-39 (1975)
- 288) Mitchell, J. W. ; Shanks, D. L. : "Substoichiometric Neutron Activation Determination of Sodium: Extraction of Sodium Dicyclohexyl-18-Crown-6 Tetraphenylborate"; Analytical Chemistry, 47(4), 642-46 (1975)
- 289) Rechnitz, G. A. ; Eyal, E. : "Selectivity of Cyclic Polyether Type Liquid Membrane Electrodes"; Analytical Chemistry, 44(2), 370-72 (1972)
- 290) Kopolow, S. ; Hogen Esch, T. E. ; Smid, J. : "Cation Binding Properties of Poly(vinyl macrocyclic polyethers)"; Macromolecules, 4(3), 359-60 (1971)
- 291) Dotsevi, G. ; Sogah, Y. ; Cram, D. J. : "Chromatographic Optical Resolution Through Chiral Complexation of Amino Ester Salts by a Host Covalently Bound to Silica Gel"; Journal of the American Chemical Society, 97(5), 1259-61 (1975)
- 292) Shah, S. C. ; Kopolow, S. ; Smid, J. : "Conductance Studies of Salt Solutions in the Presence of Poly(vinylbenzo Crown Ethers)"; Journal of Polymer Science, 14, 2023-31 (1976)
- 293) Kimura, K. ; Maeda, T. ; Shono, T. : "New Poly- and Bis (Crown Ether)s as Extracting Agents"; Analytical Letters, All(10), 821-27 (1978)

- 294) Varma, A. J. ; Majewicz, T. ; Smid, J. : "Polysalt Complexes of Poly(vinylbenzo-18-Crown-6) and of Poly(crown Acrylate)s with Polyanions"; Journal of Polymer Science, 17, 1573-81 (1979)
- 295) Dietrich, B. ; Lehn, J. M. ; Sauvage, J. P. : "Diaza-Polyoxa-macrocycles et Macrobicycles"; Tetrahedron Letters, 34, 2885-88 (1969)
- 296) Dietrich, B. ; Lehn, J. M. ; Sauvage, J. P. : "Les Cryptates"; Tetrahedron Letters, 34, 2889-92 (1969)
- 297) Mathieu, F. ; Weiss, R. : "Transition Metal Cryptates: The Crystal and Molecular Structure of a Cobalt(II) Cryptate, $[\text{Co}(\text{C}_{16}\text{H}_{32}\text{N}_2\text{O}_5)][\text{Co}(\text{SCN})_4]$."; Journal of the Chemical Society, Chemical Communications, 1973, 816 (1973)
- 298) Lehn, J. M. ; Sauvage, J. P. ; Dietrich, B. : "Cryptates. Cation Exchange Rates"; Journal of the American Chemical Society, 92(9), 2916-18 (1970)
- 299) Cheney, J. ; Lehn, J. M. : "Proton Cryptates"; Journal of the Chemical Society, Chemical Communications, 1972, 487-89 (1972)
- 300) Christensen, J. J. ; Eatough, D. J. ; Izatt, R. M. : "The Synthesis and Ion Binding of Synthetic Multidentate Macrocyclic Compounds"; Chemical Reviews, 74(3), 351-84 (1974)
- 301) Lévêque, A. ; Rossett, R. : "Les Cryptates en Chimie Analytique"; Analisis, 2(3), 218-26 (1973)
- 302) Akabori, S. : "Macrocyclic Polyethers - Their Applications to Analytical and Environmental Chemistry"; Kogyo Yosui, Series 2, 208, 39-46 (1976)
- 303) Miller, P. H. : "Ethylene Glycol, Propylene Glycol and their Derivatives" in the Kirk Othmer Encyclopedia of Chemical Technology 2nd edition, H. F. Mark (editor), Interscience Publishers, New York, 1970, Volume 10, pp. 638-59
- 304) Bailey, F. E. Jr. ; Koleske, J. V. : Poly(ethylene oxide); Academic Press, New York, 1976
- 305) Tadokoro, H. : "Structure of Crystalline Polyethers" in Macromolecular Reviews, A. Peterlin, M. Goodman, S. Okamura, B. H. Zimm, H. F. Mark (editors); Interscience Publishers, John Wiley & Sons, N. Y. , 1967 ; Volume 1, pp. 119-172

- 306) Machida, K. ; Miyazawa, T. : "Infrared and Raman Spectra of Polyethyleneglycol Dimethylethers in the Liquid State"; Journal of Chemical Physics, 39, 1865-73 (1964)
- 307) Koenig, J. L. ; Angood, A. C. : "Raman Spectra of Poly(ethylene Glycols) in Solution"; Journal of Polymer Science, Part A-2, 8, 1787-96 (1970)
- 308) Vögtle, F. ; Sieger, H. ; "'Noncyclic Crown Ethers' The Terminal Group Concept"; Angewandte Chemie International Edition (Engl.), 16 (6), 396-98 (1977)
- 309) Heimann, U. ; Vögtle, F. : "Complexes of Short-Chain Oligo(ethylene Glycol Ethers) Bearing Only One Rigid Donor End Group"; Angewandte Chemie International Edition (Engl.), 17(3), 197-98 (1978)
- 310) Rasshofer, W. ; Oepen, G. ; Vögtle, F. : "Ligand Structure and Complexation, XVIII. Non-cyclic Crown Ethers Exclusively Containing Oxygen Donor Atoms"; Chemische Berichte, 111(2), 419-30 (1978)
- 311) Tümmler, B. ; Maass, G. ; Vögtle, F. ; Sieger, H. ; Heimann, U. ; Weber, E. : "Open-Chain Polyethers. Influence of Aromatic Donor End Groups on Thermodynamics and Kinetics of Alkali Metal Ion Complex Formation"; Journal of the American Chemical Society, 101(10), 2588-98 (1979)
- 312) Calzolari, C. ; Favretto, L. : "Coordination of Alkali Metals by Polyoxyethylene Compounds"; Annali di Chimica (Rome), 64(7-8), 463-70 (1974) [Chemical Abstracts, 84 #38132s (1976)]
- 313) Suh, I. H. ; Weber, G. ; Saenger, W. : "Structures of Polyether Complexes. III. Molecular and Crystal Structure of Bis[(o-methoxyphenoxy)ethoxy]ethane - Sodium Isothiocyanate"; Acta Crystallographica, B34, 2752-56 (1978)
- 314) Hughes, D. L. ; Wingfield, J. N. : "X-ray Crystal Structures of Anhydrous Sodium and Potassium Complexes of an Open Chain Polyether Diol"; Journal of the Chemical Society, Chemical Communications, 1978, 1001-3 (1978)
- 315) Saenger, W. ; Suh, I. H. ; Weber, G. : "Wrapping of Metal Cations by Linear Polyethers"; Israel Journal of Chemistry, 18, 253-58 (1979)
- 316) Tümmler, B. ; Spielmann, D. ; Maass, G. : "Thermodynamics and Kinetics of Complex Formation of Alkali Metal Ions by Noncyclic Crown-Type polyethers"; Hoppe-Seyler's Zeitschrift für Physiologische Chemie, 359(9), 1159 (1978)

- 317) Sieger, H. ; Vögtle, F. : "Alkaline Earth Metal Complexes of Simple Oligo(ethylene Glycol Ethers)"; Angewandte Chemie International Edition (Engl.), 17(3), 198-99 (1978)
- 318) Sotobayashi, T. ; Suzuki, T. ; Tonouchi, S. : "Liquid-liquid Extraction of Various Metal Ions With Polyethyleneglycol and its Derivatives"; Chemistry Letters, 1976(6), 585-88 (1976)
- 319) Sotobayashi, T. ; Suzuki, T. ; Kudo, H. : "Liquid-liquid Extraction of some Actinides with Polyethyleneglycol and its Derivatives"; Journal of Radioanalytical Chemistry, 36, 145-52 (1977)
- 320) Sotobayashi, T. ; Suzuki, T. ; Yamada, K. : "Liquid-liquid Extraction of Cobalt(II) with Polyethylene Glycol and its Derivatives"; Chemistry Letters, 1976, 77-80 (1976)
- 321) Rais, J. ; Sebestova, E. ; Selucky, P. ; Kyrs, M. : "Synergistic Effect of Polyethyleneglycols in Extraction of Alkaline Earth Cations by Nitrobenzene"; Journal of Inorganic and Nuclear Chemistry, 38, 1742-44 (1976)
- 322) Toke, L. ; Szabo, G. T. : "Polyethylene Glycol Derivatives as Complexing Agents And Phase-Transfer Catalysts, I"; Acta Chimica Academiae Scientiarum Hungaricae, 93 (3-4), 421-24 (1977)
- 323) Yanagida, S. ; Takahashi, K. ; Okahara, M. : "Metal-ion Complexation of Noncyclic Poly(oxyethylene) Derivatives. I. Solvent Extraction of Alkali and Alkaline Earth Metal Thiocyanates and Iodides"; Bulletin of the Chemical Society of Japan, 50(6), 1386-90 (1977)
- 324) Rais, J. ; Selucky, P. ; Jirasek, V. ; Sebesta, F. : "New Type of Sorbents Based on Polyethers and Some Hydrophobic Anions"; Journal of Radioanalytical Chemistry, 35, 351-59 (1977)
- 325) Yanagida, S. ; Takahashi, K. ; Okahara, M. : "Metal-ion Complexation of Non-cyclic Poly(oxyethylene) Derivatives. II. PMR Studies of the Complexation with Alkali and Alkaline-Earth Metal Cations"; Bulletin of the Chemical Society of Japan, 51(5), 1294-99 (1978)
- 326) Yanagida, S. ; Takahashi, K. ; Okahara, M. : "Metal-ion Complexation of Noncyclic Poly(oxyethylene) Derivatives. III. Complexation in Aprotic Solvent and Isolation of Their Solid Complexes"; Bulletin of the Chemical Society of Japan, 51(11), 3111-20 (1978)

- 327) Hirashima, Y. ; Shiokawa, J. : "Crystalline Complexes of Poly-(oxyethylene) Derivatives with Lanthanoids"; Chemistry Letters, 1979(5), 463-64 (1979)
- 328) Van der Hoeve, J. A. : "Analysis of Textile Auxiliary Products"; Recueil des Travaux de Chimiques des Pays-Bas, 67, 649-64 (1948)
- 329) Brown, E. G. ; Hayes, T. J. : "The Absorptiometric Determination of Polyethyleneglycol Mono-oleate"; Analyst, 80, 755-67 (1955)
- 330) Crabb, N. T. ; Persinger, H. E. : "The Determination of Polyoxyethylene Nonionic Surfactants in Water at the Parts per Million Level"; Journal of the American Oil Chemists' Society, 41, 752-55 (1964)
- 331) Weber, J. R. ; Degner, E. F. ; Bahjat, K. S. : "Determination of Nonionic Ethylene Oxide Adduct in Some Commercial Products"; Analytical Chemistry, 36(3), 678-79 (1964)
- 332) Greff, R. A. ; Setzkorn, E. A. ; Leslie, W. D. : "A Colorimetric Method for the Determination of Parts/Million of Nonionic Surfactants"; Journal of the American Oil Chemists' Society, 42, 180-85 (1965)
- 333) Huddleston, R. L. ; Allred, R. C. : "Determination of Nonionic Surfactant Biodegradability: Physical Properties vs. Colorimetry"; Journal of the American Oil Chemists' Society, 42, 983-86 (1965)
- 334) Courtot-Coupez, J. ; LeBihan, A. : "Dosage des Traces de Detergents Non-Ioniques Dissous Par Spectrophotometrie D'Absorption Atomique."; Analytical Letters, 2(11), 567-76 (1969)
- 335) Calzolari, C. ; Favretto, L. ; Tunis, F. : "Determination of Polyoxyethylene p-t-Nonylphenyl Ethers in Pomades"; Analyst, 99, 171-77 (1974)
- 336) Nozawa, A. ; Ohnuma, T. ; Sekine, T. : "Re-examination of the Microanalysis of Non-ionic Surfactants that contain Polyoxyethylene Chains by the Method Involving Solvent Extraction of the Thiocyanatocobaltate(II) Complex"; Analyst, 101, 543-48 (1976)
- 337) Le Bihan, A. ; Courtot-Coupez, J. : "Dosage des agents de surface non ioniques en présence de polyéthylèneglycols"; Analisis, 6(8), 339-46 (1978)
- 338) Favretto, L. ; Stancher, B. ; Tunis, F. : "Extraction and Determination of Polyoxyethylene Alkyl Ether Non-ionic Surfactants in Water at Trace Levels"; Analyst, 103, 955-62 (1978)

- 339) Levins, R. J. : "Barium Ion-Selective Electrode Based on a Neutral Carrier Complex"; Analytical Chemistry, 43(8), 1045-47 (1971)
- 340) Levins, R. J. : "Barium Ion-Selective Electrode Based on a Neutral Carrier Complex"; Analytical Chemistry, 44(8), 1544 (1972)
- 341) Jaber, A. M. Y. ; Moody, G. J. ; Thomas, J. D. R. : "Solvent Mediator Studies on Barium Ion-selective Electrodes Based on a Sensor of the Tetraphenylborate Salt of the Barium Complex of a Nonylphenoxypoly(ethyleneoxy)ethanol"; Analyst, 101, 179-86 (1976)
- 342) Jaber, A. M. Y. ; Moody, G. J. ; Thomas, J. D. R. : "Alkali and Alkaline Earth Metal-Ion Adducts of Poly(propylene Glycol) as Sensors for Ion-Selective Electrodes"; Analyst, 102, 943-48 (1977)
- 343) Kraus, M. ; Patchornik, A. : "Polymeric Reagents"; Chemtech, 1979, 118-28 (1979)
- 344) Grossmann, P. ; Simon, W. : "Preparation and Properties of Styrene-Divinylbenzene Copolymers with Immobilized Neutral Complexing Molecules"; Analytical Letters 10(12), 949-59 (1977)
- 345) Fujita, H. ; Yanagida, S. ; Okahara, M. : "Separation of Metal Salts by Insolubilized Noncyclic Poly(oxyethylene) Derivatives"; Analytical Chemistry, 52, 869-75 (1980)
- 346) Hamaguchi, N. ; Nakagawa, T. ; Uno, T. : "Alkali Halide-Acid Amide Interaction in Gas Chromatographic Stationary Phases"; Journal of Chromatography, 147, 151-61 (1978)
- 347) Hamaguchi, N. ; Shiogai, Y. ; Yamaoka, K. ; Nakagawa, T. ; Uno, T. : "Efficiency of Polyethylene Glycol Containing Potassium Iodide as a Gas Chromatographic Stationary Phase"; Journal of Chromatography, 168, 208-11 (1979)
- 348) Hamaguchi, N. ; Nakagawa, T. ; Uno, T. : "Characteristics of Lithium Iodide - Containing Poly(ethylene glycol) as a Gas Chromatographic Stationary Phase, and its Application to Analysis of Amidic Drugs"; Journal of Chromatography, 170, 81-88 (1979)
- 349) Moacanin, J. ; Cuddihy, E. F. : "Effect of Polar Forces on the Viscoelastic Properties of Poly(propylene oxide)"; Journal of Polymer Science, Part C, 14, 313-22 (1966)

- 350) Hannon, M. J. ; Wissbrun, K. F. : "Interaction of Inorganic Salts with Polar Polymers. I. Physical Properties of Phenoxy-Calcium Thiocyanate Mixtures"; Journal of Polymer Science, Part A, 13, 113-26 (1975)
- 351) Wetton, R. E. ; James, D. B. ; Whiting, W. : "Modification of Polyethers by Transition Metal Chlorides"; Journal of Polymer Science (Polymer Letters Edition), 14, 577-83 (1976)
- 352) James D. B. ; Wetton, R. E. ; Brown, D. S. : "Polyether-metal Salt Complexes: 1. The Elevation of the Glass Transition Temperature of Polyethers by Metal Salts"; Polymer, 20(2), 187-95 (1979)
- 353) Irving, H. ; Rossotti, F. J. C. ; Williams, R. J. P. : "A General Treatment of the Solvent Extraction of Inorganic Compounds."; Journal of the Chemical Society, 1955, 1906-19 (1955)
- 354) Chalkley, D. E. ; Williams, R. J. P. : "The Extraction of Ferric Chloride into Non-Aqueous Solvents"; Journal of the Chemical Society, 1955, 1920-26 (1955)
- 355) Irving, H. ; Rossotti, F. J. C. : "The Extraction of Indium at Tracer Concentration From Acid-Bromide Solutions into Isobutyl Methyl Ketone"; Journal of the Chemical Society, 1955, 1927-37 (1955)
- 356) Irving, H. ; Rossotti, F. J. C. : "The Extraction of Indium at Macro-concentrations from Hydrobromic Acid into Isobutyl Methyl Ketone and Diethyl Ether"; Journal of the Chemical Society, 1955, 1938-46 (1955)
- 357) Irving, H. ; Rossotti, F. J. C. : "The Extraction of the Indium Halides into Organic Solvents"; Journal of the Chemical Society, 1955, 1946-66 (1955)
- 358) Diamond, R. M. ; Tuck, D. G. : "Extraction of Inorganic Compounds into Organic Solvents" in Progress in Inorganic Chemistry, Volume II; F. A. Cotton (editor), Interscience Publisher, New York, 1960 pp. 109-192
- 359) Nelidow, I. ; Diamond, R. M. : "The Solvent Extraction Behaviour of Inorganic Compounds: Molybdenum(VI)"; Journal of Physical Chemistry, 59, 710-18 (1955)
- 360) Diamond, R. M. : "The Solvent Extraction Behaviour of Inorganic Compounds: II. General Equations"; Journal of Physical Chemistry, 61, 69-74 (1957)

- 361) Diamond, R. M. : "The Solvent Extraction Behaviour of Inorganic Compounds. III. Variation of the Distribution Quotient with Metal Ion Concentration"; Journal of Physical Chemistry, 61, 75-81 (1957)
- 362) Diamond, R. M. : "The Solvent Extraction Behaviour of Inorganic Compounds. IV. Variation of the Distribution Quotient with Chloride, Hydrogen Ion Held Constant"; Journal of Physical Chemistry, 61, 1522-31 (1957)
- 363) Diamond, R. M. : "Salting Effects in the Solvent Extraction Behaviour of Inorganic Compounds"; Journal of Physical Chemistry, 63, 659-67 (1959)
- 364) Spivakov, B. Ya. ; Petrukhin, C. M. ; Zolotov, Yu. A. : "On the Extraction of Halide Complexes of Metals from the Point of View of Coordination Chemistry"; International Solvent Extraction Conference Proceedings, 1, 35-48 (1974), G. V. Jeffreys (ed.)
- 365) Spivakov, B. Ya. ; Stoyanov, E. S. ; Zolotov, Yu. A. : "Co-ordinative Hydration and the Extraction of Metal Halide Complexes"; Academy of Sciences of the U.S.S.R., Proceedings Chemistry, 220(2)., 87-89 (1974)
- 366) Zolotov, Yu. A. : "The Chemical Principles of Solvent Extraction"; Soviet Journal of Non-Ferrous Metals, 11, 18-20 (1975)
- 367) Sokolov, A. B. ; Moseev, L. I. ; Karabash, A. G. : "The Coextraction of Traces of Elements During the Extraction of Bromides with Oxygen-Containing Organic Solvents"; Russian Journal of Inorganic Chemistry, 6(4), 505-508 (1961)
- 368) Moseev, L. I. ; Karabash, A. G. : "Coextraction of Trace Elements in the Extraction of Chlorides with Oxygen-Containing Organic Solvents"; Russian Journal of Inorganic Chemistry, 6(8), 992-96 (1961)
- 369) Morgunov, A. F. ; Fomin, V. V. : "Extraction of Ferric Chloride with Ethers and Ketones; Dependence of Partition Coefficient on Ferric Chloride Concentration"; Russian Journal of Inorganic Chemistry, 8(2), 263-68 (1963)
- 370) Alimarin, I. P. ; Zolotov, Yu. A. ; Shakhova, N. V. : "Coextraction Phenomenon"; Akademiia Nauk SSR Komissiiia po Analiticheskoi Khimii Trudy, 14, 24-30 (1963)

- 371) Moseev, L. I. ; Karabash, A. G. : "The Coextraction of Traces of Elements During the Extraction of Iodides by Oxygen-Containing Organic Solvents"; Russian Journal of Inorganic Chemistry, 9(7), 931-33 (1964)
- 372) Zolotov, Yu. A. : "Coextraction and Suppression of Extraction of Metal-Acid Complexes"; Academy of Sciences of the U.S.S.R. Proceedings Chemistry, 180, 566-68 (1968)
- 373) Golovanov, V. I. ; Zolotov, Yu. A. : "The Mutual Effect of the Elements During the Extraction of Complex Metalloacids"; Journal of Analytical Chemistry of the U.S.S.R., 25, 1091-93 (1970)
- 374) Zolotov, Yu. A. ; Golovanov, V. I. : "Mutual Element Effects During Extraction of Complex Metalloacids"; Journal of Analytical Chemistry of the U.S.S.R., 25, 524-28 (1970)
- 375) Zolotov, Yu. A. ; Golovanov, V. I. : "Suppression of the Extraction of Elements in the Extraction of Metal-Acid Complexes"; Academy of Sciences U.S.S.R. Proceedings Chemistry, 191, 177-80 (1970)
- 376) Zolotov, Yu. A. ; Golovanov, V. I. : "Mechanism of the Inter-element Effect in Metal Acido Complex Extraction"; Academy of Sciences U.S.S.R. Proceedings Chemistry, 193, 563-65 (1970)
- 377) Zolotov, Yu. A. ; Golovanov, V. I. : "Use of the Extraction Suppression of Complex Acids for Purifying and Concentrating Elements"; Journal of Analytical Chemistry of the U.S.S.R., 26(10), 1680-85 (1971)
- 378) Zolotov, Yu. A. ; Golovanov, V. I. : "Mutual Influence of Elements During Extraction (Co-extraction and Extraction Suppression)"; Proceedings of the International Solvent Extraction Conference, 1, 625-30 (1971)
- 379) Zolotov, Yu. A. ; Prokoshev, A. A. : "Mutual Effect of Elements During their Extraction with Oxygen-Containing Solvents from Their Hydriodic Acid Solutions."; Journal of Analytical Chemistry of the U.S.S.R., 26(12), 2070-72 (1971)
- 380) Zolotov, Yu. A. ; Golovanov, V. I. : "Some Problems in the Theory of the Extraction of Complex Acids"; Russian Journal of Inorganic Chemistry, 16(10), 1468-70 (1971)
- 381) Zolotov, Yu. A. ; Sultanova, Z. Kh. : "Interaction of Elements During Extraction from Thiocyanate Solutions"; Chemia Analityczna (Warsaw), 17(4), 1113-18 (1972)

- 382) Zolotov, Yu. A. ; Golovanov, V. I. : "Influence of the Concentration of a Macro-element on the Extraction of Micro-elements in the Extraction of Complex Acids"; Russian Journal of Inorganic Chemistry, 17(4), 580-83 (1972)
- 383) Zolotov, Yu. A. ; Golovanov, V. I. : "Role of Hydrogen Halide (Hydrogen Chloride) in the Suppression of the Extraction of One Element with Another"; Russian Journal of Inorganic Chemistry, 17(5), 742-44 (1972)
- 384) Zolotov, Yu. A. ; Golovanov, V. I. : "Suppression of the Extraction of Micro-elements from their Chloride Solutions in The Presence of Gallium"; Russian Journal of Inorganic Chemistry, 17(6), 888-91 (1972)
- 385) Zolotov, Yu. A. ; Golovanov, V. I. : "Suppression of the Extraction of Micro-elements by an Extractable Macro-element in their Simultaneous Extraction by Solvent Mixtures"; Russian Journal of Inorganic Chemistry, 17(6) 891-94 (1972)
- 386) Sokolov, A. B. ; Zolotov, Yu. A. : "Suppression of the Extraction of Micro-elements in the Extraction of Indium from Bromide Solutions by Tributyl Phosphate"; Russian Journal of Inorganic Chemistry, 17(4), 584-96 (1972)
- 387) Zolotov, Yu. A. ; Golovanov, V. I. : "Mutual Influence of the Elements in the Extraction of Complex Hydrogen Halogenometallates by Mixtures of Ethers."; Russian Journal of Inorganic Chemistry, 17(7), 1031-34 (1972)
- 388) Golovanov, V. I. : "Calculations of the Dissociation Constants of Hydrogen Halogenometallates in Non-Aqueous Media."; Russian Journal of Inorganic Chemistry, 17(10), 1443-46 (1972)
- 389) Golovanov, V. I. ; Zolotov, Yu. A. ; Zarinskii, V. A. : "State of Hydrogen Halogenometallates in Extracts"; Russian Journal of Inorganic Chemistry, 17(4), 578-80 (1972)
- 390) Zolotov, Yu. A. ; Golovanov, V. I. ; Vanifatova, N. G. : "Co-extraction Mechanisms During the Extraction of Metals by Ethers from Chloride Solutions"; Journal of Analytical Chemistry of the U.S.S.R., 28(1), 1-4 (1973)
- 391) Zolotov, Yu. A. ; Sultanova, Z. Kh. : "Mutual Influence of Elements in Extraction from Thiocyanate Solutions by Oxygen-Containing Solvents"; Russian Journal of Inorganic Chemistry; 18(4) 556-59 (1973)

- 392) Petrukhin, O. M. ; Spivakov, B. Ya. ; Zolotov, Yu. A. :
"Mechanism of the Extraction of Metal Halide Complexes as it
Depends on the Position of the Metals in the Periodic System
of the Elements"; Academy of Sciences of the U.S.S.R., Proceed-
ings Chemistry, 214(3), 90-93 (1974)
- 393) Zolotov, Yu. A. ; Sultanova, Z. Kh. : "The Mechanism of the
Mutual Influence of Elements in their Extraction from Thio-
cyanate Solutions"; Russian Journal of Inorganic Chemistry,
19(1), 101-104 (1974)
- 394) Zolotov, Yu. A. ; Prokoshev, A. A. ; Golovanov, V. I. : "Coextrac-
tion of Micro-elements with Macro-elements, Extracted from Halide
Solutions by Highly Polar Solvents"; Russian Journal of Inorganic
Chemistry, 19(1), 87-90, (1974)
- 395) Nikolaev, A. I. ; Il'in, E. G. ; Spivakov, B. Ya. ; Shcherbakova,
M. N. ; Babkin, A. G. ; Buslaev, Yu. A. ; Zolotov, Yu. A. :
"The Mechanism of the Extraction of Niobium and Tantalum from
Fluoride Solutions by Oxygen-containing Extractants"; Russian
Journal of Inorganic Chemistry, 20(1), 104-7 (1975)
- 396) Zolotov, Yu. A. ; Vlasov, V. S. ; Kuz'min, N. M. ; Federov, V. A. :
"The Effect of Macroamounts of Antimony(III) and (V) on the
Extraction of Microamounts of Gallium and Iron(III) from Chloride
Solutions"; Russian Journal of Inorganic Chemistry", 20(2), 256-
58 (1975)
- 397) Golovanov, V. I. ; Zolotov, Yu. A. : "Dissociation Constants and
Constants for the Extraction of Halogenometallate Acids at Various
Concentrations of Hydrogen Halide"; Russian Journal of Inorganic
Chemistry, 20(8), 1260-62 (1975)
- 398) Golovanov, V. I. ; Spivakov, B. Ya. ; Zolotov, Yu. A. : "Dissocia-
tion of Hydrogen Halogenometallates in the Organic Phase in their
Extraction by Neutral Extracting Agents"; Russian Journal of
Inorganic Chemistry, 20(9), 1346-50 (1975)
- 399) Golovanov, V. I. ; Zolotov, Yu. A. : "Solvation of Ions and Ion
Pairs in the Extraction of Halogenometallate Complex Acids";
Russian Journal of Inorganic Chemistry, 20(10), 1544-46 (1975)
- 400) Danesi, P. R. ; Chiarizia, R. ; Scibona, G. : "The Meaning of
Slope Analysis in Solvent Extraction Chemistry. The Case of
Zinc Extraction by Trilaurylammonium Chloride"; Journal of
Inorganic and Nuclear Chemistry, 32, 2349-55 (1970)

- 401) Haymore, B. L. ; Huffman, J. C. : "Low Temperature Structure of $[\text{OH}_3][\text{ClO}_4]$ Coordinated to Dicyclohexyl-18-Crown-6"; Proceedings of the Second Joint Conference of the Chemical Institute of Canada and the American Chemical Society, May 29-June 2, 1977, Montreal, paper # INOR 106
- 402) Anjum S. Khan, Chemistry Department, University of Manitoba, Winnipeg; private communication
- 403) Sargon J. Al-Bazi, Chemistry Department, University of Manitoba, Winnipeg; private communication