

A RADIOGRAPHIC STUDY OF DENTAL ERUPTION

Wilfrid H. Feasby, D.D.S.

A Thesis submitted in partial fulfillment  
of the requirements for the degree of  
Master of Science

The University of Manitoba

1970

## ABSTRACT

### A RADIOGRAPH STUDY OF DENTAL ERUPTION

W. H. FEASBY

A longitudinal study of the eruption of the mandibular canine, first and second premolars, first and second molars was conducted using the cephalometric films and dental casts of 54 untreated boys examined annually from ages 3 to 14 years.

The tangent to the lower border of the mandible derived from the lateral cephalometric projection was found to rotate at approximately  $2^{\circ}$  per year due, it is suggested, to resorption on the inferior border posterior to the first premolar. Eruption data measured on oblique films from the mandibular tangent are subject to correction due to the rotation of this reference line. The occlusal line was found to be a clinically useful but less stable reference line.

Bilateral symmetry of mandibular eruption and tooth growth data from the oblique projection was demonstrated on annual records.

The eruption rates of the canine, first and second premolars, first and second molars increased steadily following the completion of the crowns. The mean eruption rates of each tooth demonstrated a "preocclusal eruption spurt" of 4 - 7 mm per year, followed by a sharp reduction

in eruption rate. Mean annual postocclusal eruption rates of 0.5 - 1.6 mm. persisted at age 14 years.

The eruption rate data showed less variability when standardized physiologically on the year of maximum eruption.

Root growth did not correlate strongly with eruption especially during the "preocclusal eruption spurt" when the eruptive movements of the single rooted teeth were double or more the mean increase in tooth length.

Crowding measured at age 9 was associated with slower eruption rates of the canine, first and second premolars while the second premolar was more affected than the first premolar or the canine.

December 1970

## ACKNOWLEDGEMENTS

It is a pleasure to acknowledge my indebtedness and gratitude to the following individuals who have graciously and patiently provided assistance and guidance:

John F. Cleall, B.D.S., M.D.S., D.D.S. (Otago),  
F.R.C.D. (C), Head of Orthodontics, The  
University of Manitoba, Thesis Supervisor.

J. R. Burlock, Computer Programmer.

Peter B. Canham, B.S.Sc., M.Sc., Ph.D.,  
Assistant Professor of Biophysics, The  
University of Western Ontario.

W. Stuart Hunter, D.D.S., Ph.D., Chairman of  
Orthodontics, The University of Western  
Ontario.

F. Popovich, D.D.S., M.Sc. (Dent), Director,  
Burlington Orthodontic Research Centre.

A. G. Wilford, B.A., M.A., Mathematical Consultant,  
The University of Western Ontario.

This project was supported by National Health Grant  
Number 605-7-501.

London, Canada

Wilfrid H. Feasby

1970

## CONTENTS

### A RADIOGRAPHIC STUDY OF DENTAL ERUPTION

|  | Page |
|--|------|
| I INTRODUCTION                             | 1    |
| II REVIEW OF THE LITERATURE                | 2    |
| III METHODS AND MATERIALS                  |      |
| (a) The Sample                             | 10   |
| (b) The Cephalometric Technique            | 13   |
| (c) The Oblique Cephalometric Film         | 14   |
| (d) Radiographic Landmarks in the Mandible | 23   |
| (e) Data Management                        | 37   |
| i Measurement Methods                      | 37   |
| ii Error Analysis                          | 43   |
| iii Array of Data                          | 46   |
| IV RESULTS                                 |      |
| (a) Bilateral Symmetry                     | 48   |
| (b) Eruption and Growth Profiles           | 49   |
| V DISCUSSION                               | 74   |
| VI CONCLUSIONS                             | 81   |
| VII BIBLIOGRAPHY                           | 83   |
| APPENDIX                                   | 87   |

## TABLES

| <u>Table</u>   | <u>Page</u> |
|--|-------------|
| I      The Number of Boys' Annual Records Studied                                  | 11          |
| II     Enlargement Distortion for Selected Ages and Angles                         | 22          |
| III    Correction Factor by Age and Angle  | 24          |
| IV     Mandibular Tangent Rotation: Mean Annual Rotation                           | 32          |
| V      Mandibular Tangent Rotation: Mean Annual Change Related to Mandibular Teeth | 32          |
| VI     Occlusal Line - Mandibular Tangent Angle                                    | 36          |
| VII    Correlation of Annual Eruption with Increments in Root Length               | 69, 70      |
| VIII   Correlation of Maximum Eruption Rate with Crown Size                        | 72          |
| IX     Correlation of Maximum Eruption Rate with Available Arch Space              | 73          |

## FIGURES

| <u>Figure</u> |  | <u>Page</u> |
|---------------|--|-------------|
| 1             | Variables Inherent in the Oblique Projection                             | 16          |
| 2             | Grid Attached to the Mandible  | 18          |
| 3             | A 45° Oblique Film of a Skull with the Grid Attached                     | 19          |
| 4             | Image Distortion with Downward Tilt                                      | 21          |
| 5             | Paired Tracings Superimposed on Bjork Landmarks                          | 28          |
| 6             | Mandibular Tangent Rotation  | 30          |
| 7             | Mandibular Tangent Shift   | 31          |
| 8             | Measurement Instruments  | 38          |
| 9             | A Sample Tracing   | 39          |
| 10            | Eruption and Growth of the Mandibular Canine                             | 50          |
| 11            | Eruption and Growth of the Mandibular First Premolar                     | 51          |
| 12            | Eruption and Growth of the Mandibular Second Premolar                    | 52          |
| 13            | Eruption and Growth of the Mandibular First Molar                        | 53          |
| 14            | Eruption and Growth of the Mandibular Second Molar                       | 54          |
| 15            | Chronological Eruption and Growth Rate of the Mandibular Canine          | 56          |
| 16            | Chronological Eruption and Growth Rate of the Mandibular First Premolar  | 57          |
| 17            | Chronological Eruption and Growth Rate of the Mandibular Second Premolar | 58          |

| <u>Figure</u>  | <u>Page</u> |
|--|-------------|
| 18 Chronological Eruption and Growth Rate<br>of the Mandibular First Molar                                       | 59          |
| 19 Chronological Eruption and Growth Rate<br>of the Mandibular Second Molar                                      | 60          |
| 20 A Comparison of Eruption Profiles Plotted<br>on Chronologic Age, and Year of Maximum<br>Velocity              | 62          |
| 21 Eruption and Growth Rate of the Mandibular<br>Canine Standardised on the Year of<br>Maximum Velocity          | 63          |
| 22 Eruption and Growth Rate of the Mandibular<br>First Premolar Standardised on the Year<br>of Maximum Velocity  | 64          |
| 23 Eruption and Growth Rate of the Mandibular<br>Second Premolar Standardised on the Year<br>of Maximum Velocity | 65          |
| 24 Eruption and Growth Rate of the Mandibular<br>First Molar Standardised on the Year<br>of Maximum Velocity     | 66          |
| 25 Eruption and Growth Rate of the Mandibular<br>Second Molar Standardised on the Year<br>of Maximum Velocity    | 67          |



# I

## INTRODUCTION

A better understanding of eruption phenomena is important to those who assume responsibility for the developing dentition and who are therefore students of craniofacial growth. This study is concerned with eruption as a continuous process that carries a tooth from its crypt to occlusal function and maintains the tooth in occlusion.

The serial growth records of the Burlington Orthodontic Research Centre, including both cephalometric radiographs and dental casts, were employed in order to study eruption longitudinally.

The specific objectives of this study were:

1. to develop anthropometric methods applicable to the mandible as seen in the oblique cephalometric projection;
2. to determine the eruption and growth rates of the mandibular canine, first and second premolar, first and second molar teeth;
3. to investigate the relationship of tooth elongation, tooth crown diameter, and available dental arch space to dental eruption rates.

Improved predictability of eruption phenomena and a better understanding of the process of eruption should result from this study.

## REVIEW OF THE LITERATURE

Many histologic studies of eruption have been reported employing for the most part rodent incisors. Many other studies report on the time and sequence of appearance of the teeth intra-orally. However, the rate of human dental eruption has had relatively scanty attention.

In 1944, Carlson<sup>6</sup> reported a cephalometric study employing serial lateral films from five individuals of overlapping age from 3 months to 16 years 9 months. Corrections were made for enlargement and foreshortening. The eruption and tooth length of the mandibular central incisor, canine first and second premolar, and first permanent molar were measured from a tangent to the inferior border of the mandible. Carlson found that eruption proceeded more rapidly than root formation. The rapid phase of eruption that began with root formation ended when the tooth came into occlusion. From this time on the tooth erupted only as rapidly as the occlusal plane rose. The eruption rate varied from tooth to tooth within a dentition and the same tooth showed variations between individuals within the sample. The greatest rate of eruption noted for any one tooth was the lower second premolar which erupted 8 mm in six months. The greatest rate of eruption for any one-year period was that for a central incisor which erupted 12 mm while the greatest rate for any

two-year period was that for a lower canine which erupted 13mm. He noted that clinical emergence does not apparently increase the rate of eruption and that rapid eruption does not start until the crown of the tooth is fully formed.

Hatton<sup>14,16</sup> reported on a serial study of eruption of the mandibular first permanent molar from 32 to 72 months of age employing the oblique cephalometric projection and using as a base line a tangent to the inferior border of the mandible. A sample of 50 boys was divided into erupters and nonerupters depending on the appearance of the first mandibular molar at age 72 months. The average eruption over the three-year period for the erupters was 10.9mm and the nonerupters 6.7mm. In addition, it was reported that the mesio-distal width of the mandibular first permanent molars was smaller in the children with the clinically erupted teeth at age 6 years.

Hatton and Grainger<sup>15</sup> reported upon the reliability of measurements taken from tracings of oblique films. They found, in a study of 15 three-year-old children, that the single determination in tracing and measurement of points relevant to mandibular eruption was efficient and that to appreciably reduce the experimental error, the number of children rather than the number of films and tracings should be increased.

In 1960 Shumaker and El Hadary<sup>36</sup> reported on a radiographic study of eruption in 26 girls and 31 boys. A non-standardized technique (diagnostic lateral film) was used and the landmarks employed were the lower border of the mandible and the occlusal line. Eruption was not reported as an absolute figure but as a percentage of eruption towards the occlusal line. The study reported on the eruption of the mandibular canine first and second premolars, and the first and second permanent molars. It was concluded that each tooth starts to move towards occlusion when the crown is completed and approximately five years are required from crown completion until eruption into occlusion. It was also found that boys and girls have the same pattern of eruption but the girls are ahead of the boys except for the first permanent molar.

Bradley<sup>4</sup> used the "percentage of eruption" technique described by Shumaker and El Hadary<sup>36</sup> on annual diagnostic lateral radiographs from 86 boys. He found that individual variation in percentage eruption was greatest when two thirds of the root was completed (Nolla<sup>28</sup> stage 8). He also found that variation of eruption between individuals was reduced when a physiologic scale, calcification stages, was used rather than a chronologic scale. He found that the canine and premolars behaved similarly and that the eruptive movement began with the completion of the crowns. He found

low, positive correlations between arch space availability and eruption rates.

Lauterstein, Pruzansky, and Barber<sup>2,4</sup> have studied eruption phenomena in the mandible employing the oblique cephalometric projection because, in their opinion, it permitted "an unobstructed and relatively undistorted visualization of the buccal dentition." The oblique projection was that described by Barber et al<sup>1,2</sup> in which the mid-sagittal plane is rotated 45 degrees to both the central beam and the film cassette with the patient's head oriented in the Frankfort horizontal position. It should be noted that other investigators (Cartwright,<sup>7</sup> Posen,<sup>3,5</sup> and Hatton<sup>1,4</sup>) did not standardize the vertical position when employing the oblique projection. The reference line for vertical measurements used by Lauterstein<sup>2,4</sup> was a line connecting two specified points on the inferior border of the mandible. The posterior point was anatomical, being the most superior point in the antegonial notch, while the anterior point was empirically located at the intersection of the lower border of the mandible and the shadow of the ascending border of the opposite side. The empirically located anterior reference point is not comparable to landmarks employed in the other studies because it changes as the head rotates on the porionic axis.

Lauterstein et al,<sup>25</sup> studied the eruption of the canine first and second premolars using oblique cephalometric films from 242 patients of whom 78 had four or more sequential records. The eruption movement was studied by constructing a line from the cusp tip of the canine to the uppermost cusp tip of the first premolar, thence to the second premolar. The "gabling" angle formed was measured and bilateral comparisons were made. In 131 of the 242 children, the "gabling" angle differed significantly. However, it should be pointed out that while the sample did not include children with impactions ankylosis or congenitally missing teeth, it did not exclude infected teeth, pulpotomies or extractions. In addition, this study demonstrated that inter-related eruptive movements were arrhythmical with the teeth appearing to erupt in "fits and starts." By duplicating the tracings and measurements of 40 children, this study further demonstrated the reliability of the tracing and measurement techniques.

Lauterstein,<sup>23</sup> in another study, has also tested the reliability of measurements from the tracings of oblique films by employing three observers in repeated measurements on 50 tracings. "The observers rarely differed by more than 0.5mm." He reported bilateral symmetry of tooth length and incremental rate. In Lauterstein's studies, the children

were examined at intervals as short as 4 months. He demonstrated that pulpotomized primary molars resulted in the accelerated eruption of their successors.

Posen,<sup>34</sup> using Burlington material, studied the effects of premature loss of primary molars on premolar eruption. He utilized the oblique projection in which the vertical angle was not standardized. Measurements were made from cusp tip to the occlusal line. He reported that the eruption of premolar teeth is retarded or accelerated depending on whether the primary molar was extracted before or after age 8.

Radiographic cephalometry in the mandible, as in the balance of the craniofacial complex, requires the identification and validation of radiographic landmarks and points of reference. Carlson's<sup>6</sup> study, employing lateral cephalometric films used a tangent to the inferior border of the mandible. He cited vital stain studies conducted on pigs and macaque monkeys which showed little deposition on the inferior border of the mandible. However, this technique would not reveal resorption and presumably the lack of staining was interpreted as evidence of stability.

Brodie<sup>5</sup> also considered the inferior border of the mandible stable. He stated that there was "very little addition...made at the lower border. Thus, it seems legitimate to superpose on the lower and posterior border... ."

Enlow<sup>11</sup> has cast some doubt on the stability of the lower border of the mandible when he demonstrated resorption from the antegonial notch to the angle in a histologic study of ground sections.

Undoubtedly, the most reliable landmarks were those employed by Bjork<sup>3</sup>. He imbedded metallic implants at selected locations in the mandible and thereby found certain anatomic landmarks or radiographic reference points to be stable. These included the tip of the chin, the inner cortical structure of the inferior border of the symphysis, detailed structures of the mandibular canal, and the lower contour of the molar germ from the time mineralization of the crown is visible till the roots begin to form as identified in lateral cephalometric films. Bjork also stated that the inferior border of the mandible was unsuitable as a reference line for the purpose of orientation of the mandible in growth analysis.

In summary, the literature cited reveals studies of the eruption of mandibular teeth employing the oblique cephalometric projection, the lateral cephalometric projection, and lateral jaw diagnostic films. The eruption studies employed a variety of landmarks or reference lines. The tangent to the lower border of the mandible was used in most instances but an arbitrary reference line and the



occlusal line have been reported. A histologic study and one implant study were cited that questioned the stability of the inferior border of the mandible. The relationship of environmental factors to eruption; such as, pulpotomy in primary molars, extraction of primary molars, mesio-distal tooth diameter, and crowding has been reported. Root growth was found to be bilaterally symmetrical but inter-related eruptive movements were asymmetrical when examined at four month intervals. The rate of eruption derived from a very limited sample was reported while two studies recorded eruptive progress as a percentage of total eruption.

### III

#### METHODS AND MATERIALS

##### (a) The Sample

The data source for this study was the Burlington Orthodontic Research Centre, a longitudinal growth study initiated at Burlington, Ontario, in 1952.

The Research Centre was established by the Orthodontic Department of the Faculty of Dentistry, University of Toronto, with funds made available by the Federal Government through a National Health Grant. The object of the study was stated as follows:<sup>30</sup>

1. "to demonstrate the value of interceptive orthodontics...;
2. to compile a set of records on which to base intensive studies of normal growth and development...;
3. to assess the role of inheritance in determining a number of clinically significant characteristics of cranio-facial growth."

Burlington was an average town (population 8,500 in 1951) with a typical Ontario population. While the population was predominantly caucasian, there were North American indians, orientals, and negroes in the town. However, the minorities were so few in number

that, through chance, they were not represented in the sample. The samples assembled at the Centre "represent between 85 - 90 per cent of the children in the town for the age groups being studied."<sup>8</sup> The longitudinal study of boys consisted of 102 who were examined annually beginning at age 3, augmented to 163 at age 4.<sup>29</sup>

Attrition has reduced the sample so that complete records were available for 119 boys. These were classified as untreated (54), primary tooth extraction (16), permanent tooth extraction (14), orthodontically treated (28), and abnormal number of teeth (7). The present study includes the records of 54 untreated boys, 39 of whom entered the study at age 3, 14 at age 4, and one at age 5, while one left at age 10 and two at age 11 and one at age 12, and 50 remained to age 14 years.

TABLE I

## THE NUMBER OF BOYS' ANNUAL RECORDS STUDIED

| Age | 3  | 4  | 5  | 6  | 7  | 8  | 9  | 10 | 11 | 12 | 13 | 14 |
|-----|----|----|----|----|----|----|----|----|----|----|----|----|
| n   | 39 | 53 | 54 | 54 | 54 | 54 | 54 | 54 | 53 | 51 | 50 | 50 |

The serial records were obtained annually within one month of the child's birthday and include:

1. A case history which was a four-page medical and dental history.
2. A clinically based assessment of the child's facial growth and occlusion.
3. Six cephalometric radiographs including:
  - (a) a lateral film with mandible in rest position;
  - (b) a lateral film with teeth in occlusion;
  - (c) a lateral film with mandible in the open position;
  - (d) right and left oblique radiographs with mandible in rest position;
  - (e) a posteroanterior head film.
4. One wrist radiograph.
5. Dental casts with occlusion registered in wax.
6. Periapical films, where needed.
7. Height and weight record.
8. Black and white frontal and lateral view photographs.

(b) The Cephalometric Technique

The equipment included a generator capable of delivering 50 ma at 120 Kv to a rigidly mounted radiographic tube. The tube had a 10mm focal spot on a rotating anode. The Thurow cephalostat was not adjustable vertically or horizontally but the ear rods could be rotated on a vertical axis which was fixed at 60 inches from the focal spot. The central beam is precisely aligned in the centre of the ear rods and the film cassette is mounted at  $90^{\circ}$  to this axis. The film is 150mm from the centre of the cephalostat in the lateral projection and 140mm in the oblique projection. The left and right oblique projections were obtained with the midplane of the patient rotated  $45^{\circ}$  from the film plane. The lateral films were exposed with the head oriented in the Frankfort horizontal plane but in the oblique projection, the head was tilted down at a nonstandardized angle below the Frankfort horizontal plane.

The radiographic equipment included: a tube port mask, aluminum filtration, intensifying screens, and Bucky diaphragm as detailed by Cartwright and Harvold.<sup>7</sup>

The standard technique included the tracing of the structures under study on matte cellulose acetate film .003" thickness with a 4 H pencil. All tracings and the linear and angular measurements were made upon the acetate

film at room temperature.

The oblique projection had certain marked advantages which outweighed the proven value of lateral films.

1. There was no need to midline bilateral structures.
2. The right and left sides could be recorded independently. This was of particular importance when unilateral phenomena, such as dentoalveolar infection, premature extraction of primary teeth or space closure are to be considered in relation to eruption.
3. Since each side is recorded separately, there could be no superimposition of closely grouped structures such as the enamel of the permanent cusp tip, the superior border of the developmental crypt, the lamina dura in the root bifurcation and the partially resorped primary tooth root.

On the other hand, the lack of documentation of the distortion factors and the lack of radiographic landmarks was a serious disadvantage which is dealt with in Section (c) and (d) of this chapter.

#### (c) The Oblique Cephalometric Projection

As described in the preceding section, the oblique film was exposed with the cephalostat rotated so that the patient's midsagittal plane was  $45^{\circ}$  to both the central

beam and the film. Barber et al<sup>1</sup> have evaluated the oblique cephalometric film and concluded that it provided, "a valid means for documentation and research." Barber's study considered the difference in enlargement distortion between skulls of various ages and concluded that they were not significantly different. However, it must be noted that all films were taken with the skulls oriented in the Frankfort horizontal plane. The Burlington oblique films were exposed with the patient's head tilted down in order to record more maxillary posterior teeth. Unfortunately, the angle of tilt was not standardized either between colateral films or from year to year.

Some of the variables inherent in the oblique cephalogram of the mandible are illustrated in Figure 1. Growth in condylar width (A) places the mandibular posterior teeth closer to the film and reduces magnification. Increase in mandibular length (B) also tends to decrease film object distance. On the other hand, rotation downward around the porionic axis at  $45^{\circ}$  to the film tends to increase the film object distance. In addition, the angular relationship of the long axes of the teeth with the film plane will alter and affect the degree of foreshortening produced. This array of factors is more complex than those considered by Barber et al<sup>1</sup> and further investigation of the oblique film was indicated to ensure its accurate utilization.

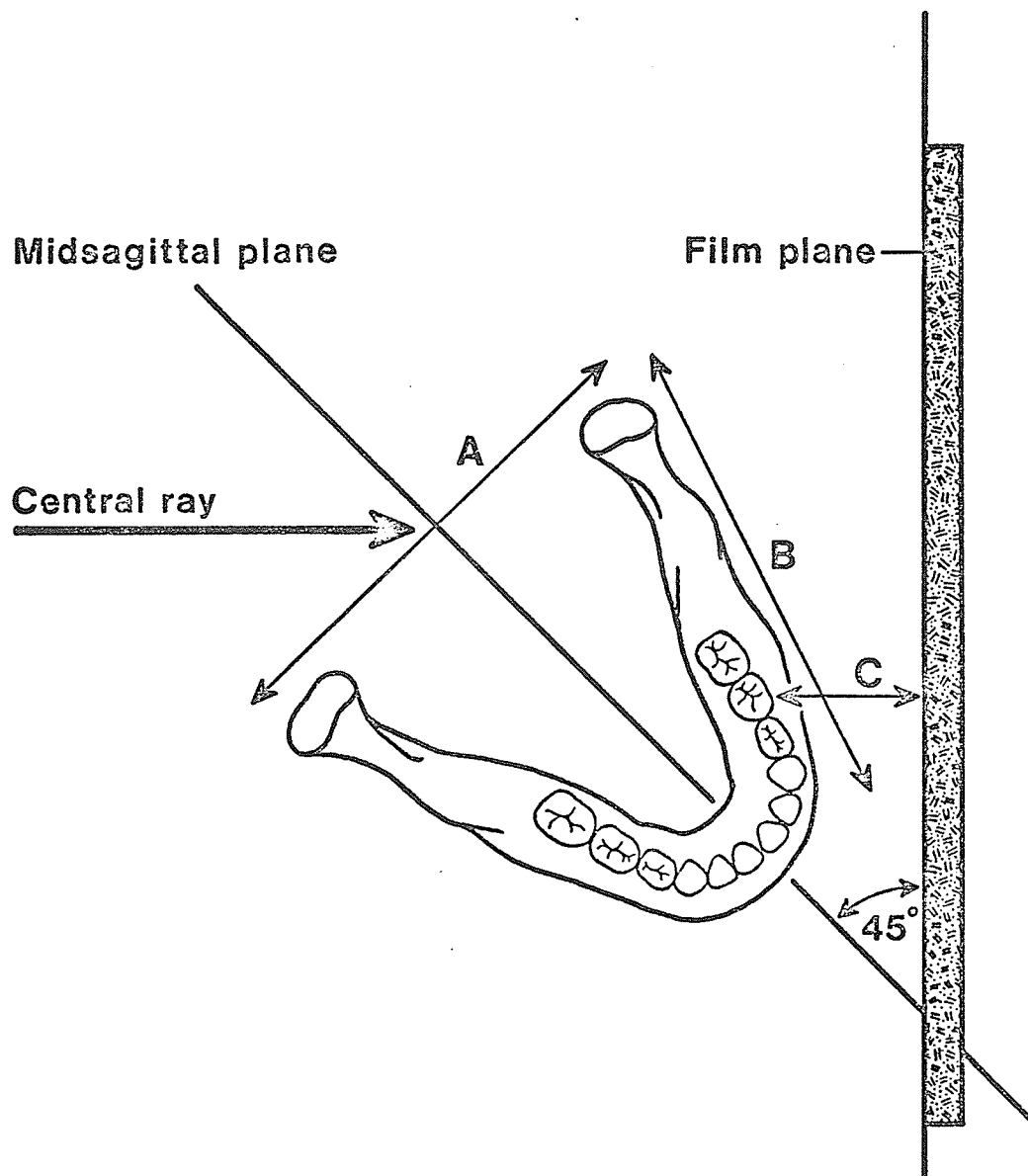

Fig. 1 Variables inherent in the oblique projection

- A - Condylar width
- B - Mandibular length
- C - Film-object distance



## ENLARGEMENT DISTORTION

A metal grid of 0.025" stainless steel wire was constructed so that each vertical bar would fall approximately in the long axis of each of the canine, first and second premolar, and distal root of the first molar. Two horizontal bars were spot welded to the vertical bars in the approximate level of the gingival margin and the root apices. The grid was adapted to the contour of the left side of the dry mandible and secured with wax (Fig. 2). Two series of films were exposed with the grid (Fig. 4) using the Burlington cephalometer.

Series 1. Multiple exposures were taken on one skull with the grid attached. The arc traced by the bar representing the canine is shown in Figure 3 through  $90^{\circ}$  of rotation.

Series 2. The grid was applied in turn to five different skulls with boys ages of 4.1 years, 4.5 years, 7.0 years, 8.1 years, and 16.5 years determined by Nolla's table of dental development.<sup>28</sup> Each skull then had five oblique films exposed at five realistic but uniformly spaced angles of downward tilt. The grid and the images were measured to the nearest tenth of a millimetre. The angle of

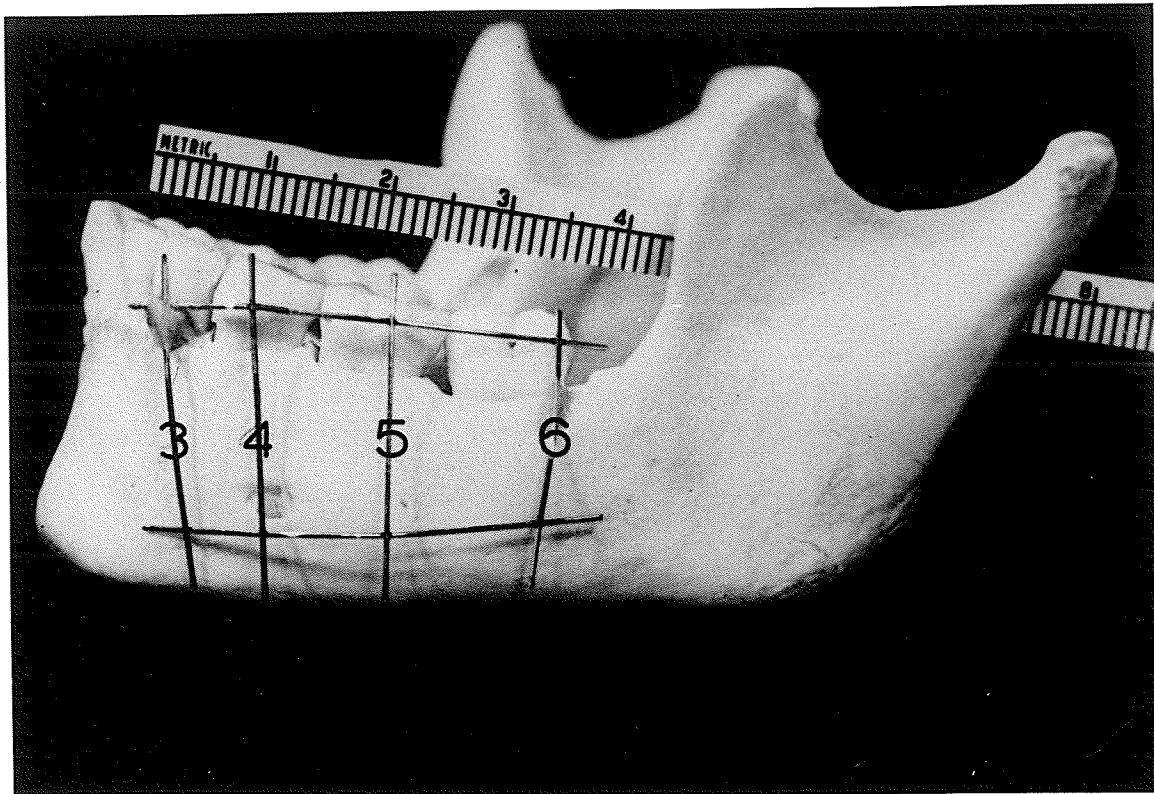

Fig. 2. Grid attached to the mandible.

The anterior vertical bar between the horizontal bars (No. 3) represents the mandibular canine. Similarly bars No. 4., 5., and 6. represent the first and second premolars and the distal root of the first permanent molar respectively.

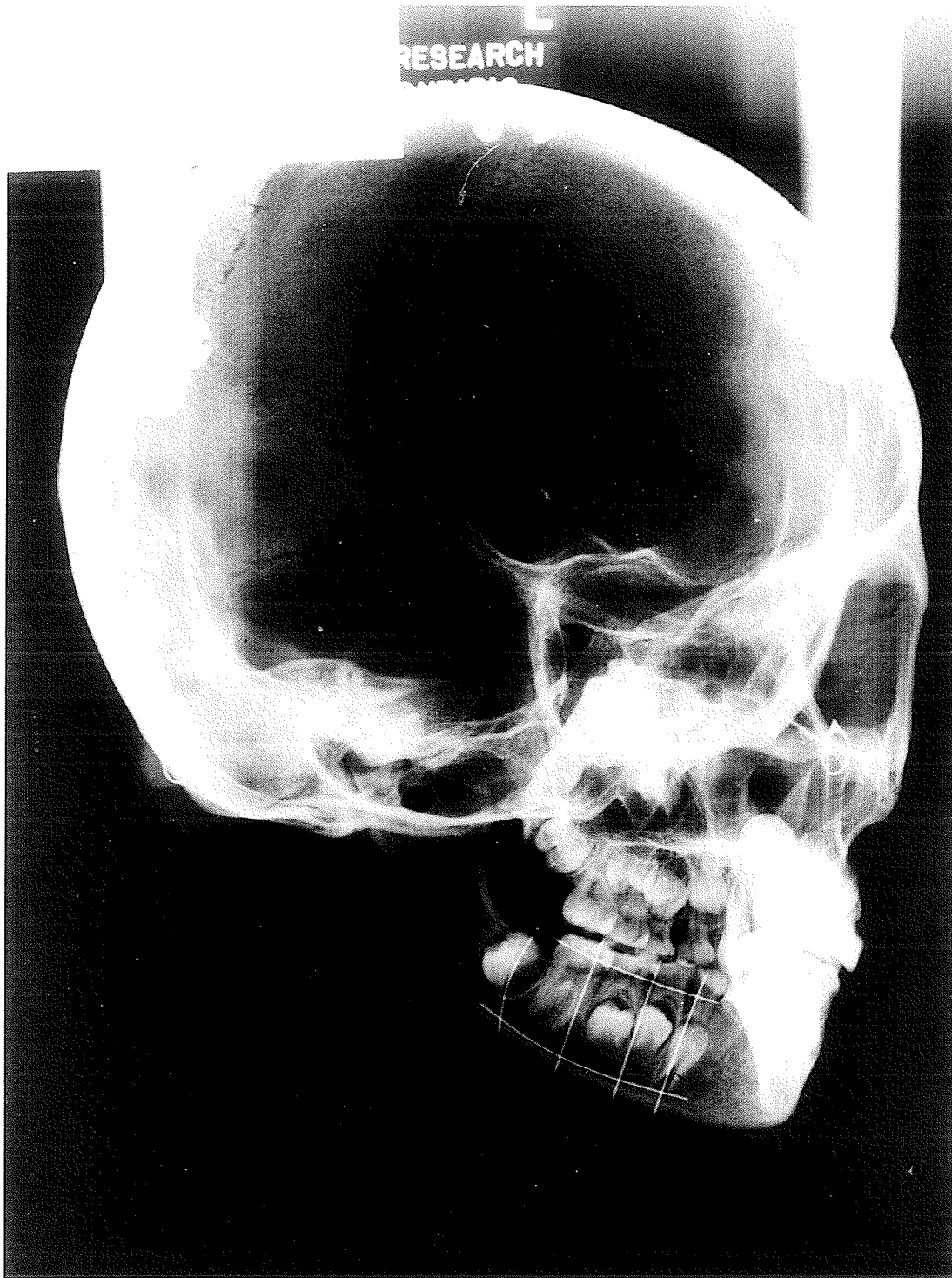

Fig. 3. A 45° oblique film of a skull with the grid attached.

tilt was measured on the film between the horizontal determined by the ear rods and the occlusal plane as defined in Section (e) of this chapter.

The multiple exposures in Series 1 indicated that the images were tracing an elliptical path as the skull was rotated. One quarter of the path of the mesial bar of the grid is illustrated in Figure 3. The length of the image of the bar shown ranged from 19.2mm in the Frankfort horizontal position ( $I_2$ ) to 17.4mm and 14.6mm in the lower positions ( $I_3$ ,  $I_4$ ) while the actual length was 18.7mm.

The exposures in Series 2 (Fig. 4), using skulls of various ages and exposed at a variety of degrees of tilt resulted in the data presented in Table II. The portion of the vertical bar of the grid between the horizontal members and over the canine was designated with the corresponding tooth number 3. Similarly, the bar over the first premolar, the second premolar, and the first permanent molar, were designated numbers 4, 5, and 6 respectively.

Since both object and image measurements were available, a correction factor (CF) for each angle at each age for each vertical bar was produced. It was assumed that the regression was linear for the age and the portion of

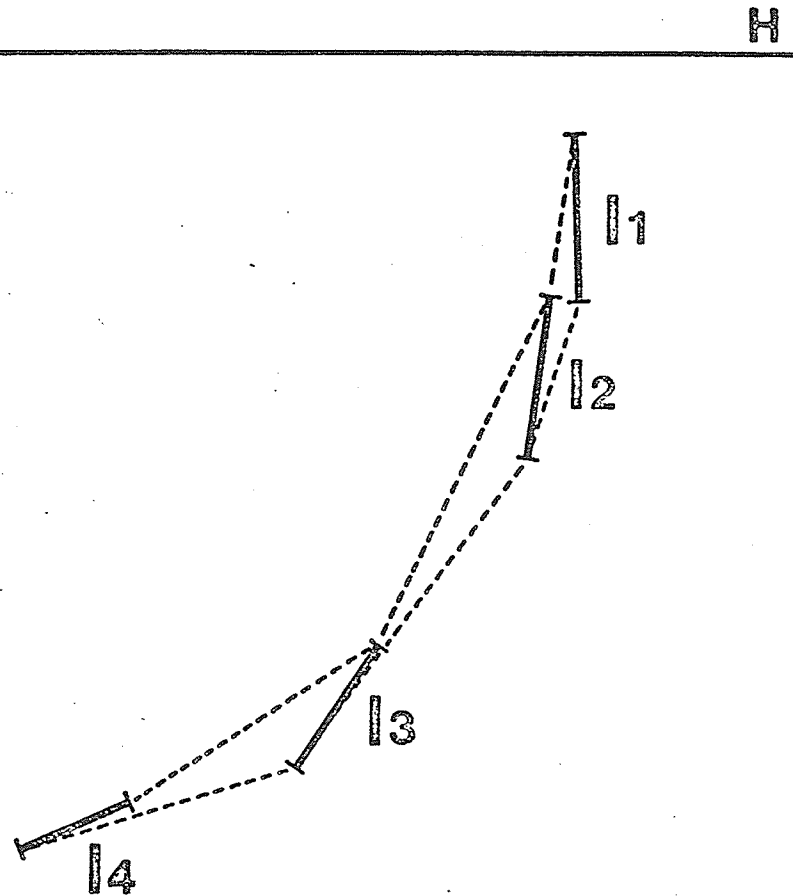

Fig. 4. Image distortion with downward tilt.

H indicates the horizontal plane.

$I_1$ ,  $I_2$ ,  $I_3$ ,  $I_4$  represent the images of grid bar 3 at various angles of tilt through approximately  $90^\circ$  of rotation of the skull around the porionic axis in the  $45^\circ$  oblique projection.

$I_1 = 19.9$  mm.;  $I_2 = 19.2$  mm.;  $I_3 = 17.4$  mm.;  $I_4 = 14.6$  mm. while grid bar 3 was 18.7 mm.

TABLE II

## ENLARGEMENT DISTORTION FOR SELECTED AGES AND ANGLES

| Age <sub>1</sub>    | OH<br>Angle <sub>2</sub> | Tooth (Grid Bar) Number |                 |      |       |      |       |      |       |
|---------------------|--------------------------|-------------------------|-----------------|------|-------|------|-------|------|-------|
|                     |                          | 3                       |                 | 4    |       | 5    |       | 6    |       |
|                     |                          | mm.                     | CF <sub>3</sub> | mm.  | CF    | mm.  | CF    | mm.  | CF    |
| 4.1 yrs             | 16                       | 18.5                    | 1.01            | 18.7 | 1.005 | 18.6 | .962  | 17.3 | .965  |
|                     | 21                       | 17.7                    | 1.056           | 18.1 | 1.038 | 18.2 | .983  | 17.5 | .954  |
|                     | 25                       | 17.5                    | 1.068           | 17.9 | 1.050 | 18.0 | .994  | 17.5 | .954  |
|                     | 33                       | 17.0                    | 1.1             | 17.2 | 1.093 | 17.6 | 1.017 | 17.3 | .965  |
|                     | 38                       | 16.6                    | 1.126           | 16.6 | 1.132 | 17.6 | 1.017 | 17.5 | .954  |
| 4.5 yrs             | 15                       | 17.9                    | 1.044           | 17.9 | 1.050 | 18.5 | .967  | 17.3 | .965  |
|                     | 23                       | 17.0                    | 1.1             | 17.6 | 1.068 | 17.9 | 1.0   | 17.5 | .954  |
|                     | 30                       | 16.3                    | 1.147           | 16.7 | 1.125 | 17.6 | 1.017 | 17.4 | .959  |
|                     | 37                       | 15.6                    | 1.198           | 15.2 | 1.236 | 16.9 | 1.059 | 17.3 | .965  |
|                     | 45                       | 16.0                    | 1.168           | 16.1 | 1.167 | 16.8 | 1.065 | 17.3 | .965  |
| 7.0 yrs             | 9                        | 19.4                    | .963            | 19.4 | .969  | 18.6 | .962  | 16.6 | 1.006 |
|                     | 13                       | 19.0                    | .984            | 19.2 | .979  | 18.6 | .962  | 17.3 | .965  |
|                     | 20                       | 18.8                    | .994            | 19.0 | .989  | 18.8 | .952  | 17.3 | .965  |
|                     | 25                       | 18.4                    | 1.016           | 18.6 | 1.01  | 18.5 | .967  | 17.5 | .954  |
|                     | 28                       | 18.2                    | 1.027           | 18.1 | 1.038 | 18.3 | .978  | 17.5 | .954  |
|                     | 36                       | 17.2                    | 1.087           | 17.3 | 1.086 | 17.8 | 1.005 | 17.6 | .948  |
| 8.1 yrs             | 15                       | 18.5                    | 1.01            | 18.4 | 1.021 | 18.7 | .957  | 17.5 | .954  |
|                     | 22                       | 18.0                    | 1.038           | 18.0 | 1.044 | 18.4 | .972  | 17.5 | .954  |
|                     | 29                       | 16.9                    | 1.106           | 17.6 | 1.068 | 18.1 | .988  | 17.1 | .976  |
|                     | 34                       | 16.6                    | 1.126           | 17.2 | 1.093 | 17.9 | 1.00  | 17.7 | .943  |
|                     | 40                       | 17.6                    | 1.062           | 17.9 | 1.050 | 18.4 | .972  | 17.9 | .932  |
| 16.5 yrs            | 18                       | 19.2                    | .973            | 19.3 | .974  | 18.9 | .947  | 16.9 | .988  |
|                     | 22                       | 19.0                    | .984            | 19.3 | .974  | 18.9 | .947  | 17.4 | .959  |
|                     | 27                       | 18.7                    | 1.0             | 19.0 | .989  | 18.7 | .957  | 17.4 | .959  |
|                     | 32                       | 18.0                    | 1.038           | 18.5 | 1.016 | 18.5 | .967  | 17.7 | .943  |
|                     | 39                       | 17.7                    | 1.036           | 18.3 | 1.027 | 18.5 | .967  | 17.7 | .943  |
| Actual Grid<br>Size |                          | 18.7                    |                 | 18.8 |       | 17.9 |       | 16.7 |       |

1. Subject age was determined from dental development according to Nolla.<sup>28</sup>
2. OH Angle is the angle between the occlusal line and the horizontal.
3. CF = correction factor.

the range of angles under consideration. A multiple linear regression analysis was performed which resulted in the correction factors shown in Table III.

The correction factor (CF) for each tooth is composed of three items: a constant value, a factor multiplied by the angle of tilt in degrees, and a factor multiplied by the age in years; i.e.,  $CF = A + B(\text{age}) + C(\text{angle})$ . All verticle linear measurements were corrected by these factors. The factors for the first permanent molar (6) were applied to the second permanent molar (7).

The variation in tilt found within the sample ranged up to 43 within one individual studied serially and up to 33 in bilateral comparisons. Such variations in tilt produce enlargement distortions up to 14% serially (eg. canine, from 3 to 13 years) and up to 12% with bilateral comparisons. The use of the correction factors (CF) was therefore obligatory if growth rates in absolute terms were to be considered from the pool of data available.

#### (d) Radiographic Landmarks

Radiographic cephalometry requires landmarks and points of reference that permit accurate and reproducible measurements. Satisfactory landmarks should represent

TABLE III

## CORRECTION FACTOR BY AGE AND ANGLE

---

Correction factor (CF) = A + B(Age) + C(Angle)

---

| Tooth No. | A     | B       | C       | R     | S.E.E. |
|-----------|-------|---------|---------|-------|--------|
| 3         | 0.983 | -0.0070 | 0.0049  | 0.878 | 0.029  |
| 4         | 0.984 | -0.0075 | 0.0047  | 0.864 | 0.032  |
| 5         | 0.955 | -0.0039 | 0.0022  | 0.870 | 0.015  |
| 6         | 0.983 | -0.0002 | -0.0008 | 0.541 | 0.012  |

---

R = Correlation Coefficient

S.E.E. = Standard Error of the Estimate



true anatomical structures which must be easily and readily located and must demonstrate minimal changes as a result of disease or normal growth (Krogman and Sassouni)<sup>22</sup> . Similarly, reference points and lines must be stable and reproducible.

This study required landmarks that could be found within the mandible. Bjork's<sup>3</sup> study, employing metallic implants, provided a means of evaluating mandibular landmarks. He suggested, as useful indicators, the tip of the chin and the following three internal structures as found in the lateral projection:

1. The inner cortical structure of the inferior border of the symphysis.
2. Detail structures of the mandibular canal.
3. The lower contour of the molar germ from the time that mineralization of the crown is visible until the roots begin to form.

Bjork pointed out that the thickening of the cortical layer at the symphysis results from apposition on the inferior surface. Thus normal growth should not substantially alter this landmark. Similarly, with regard to the molar tooth germ, he stated that, "From the onset of mineralization of the crown to the time when the

roots start to develop, the lower border of the germ is apparently stationary."<sup>3</sup> In the present study, it was not possible to identify the mandibular canal frequently enough to be useful.

Unfortunately, the oblique projection did not reveal the tip of the chin or the inner cortical structure of the inferior border of the symphysis as identified in the lateral film. Since no other landmarks available in the oblique projection have been described, an evaluation of the behaviour of the inferior border of the mandible, in relation to Bjork's indicators, was undertaken on the lateral films.

Of the total sample of 119 boys, 30 cases were selected at random. The mandible was traced from the lateral cephalometric films, using standard tracing techniques. Bilateral structures were "midlined" by tracing the images of both right and left side and constructing a new tracing midway between. The inferior border of the crypt of the last developing molar tooth was traced until root formation was identified. The second permanent mandibular molar was therefore available from age 3 or 4 years to age 7 or 8 years, while the third permanent mandibular molar was usually available from 9 years to 14 years. The inner cortical

structure at the symphysis was traced along with the cusp tip of the canine, the buccal cusp tip of the first and second premolars and the mesiobuccal cusp tip of the first permanent molar.

Since the annual changes appeared to be uniform and small, tracings were completed for each of the first and last of the observation period available for each molar crypt landmark. For example, one pair of tracings was completed for the first year for which the second permanent molar crypt was identifiable and the last year before root formation occurred. Similarly, another pair of tracings was produced, using the third molar landmark. The useful time range for the second and third molars did not overlap.

A tangent was constructed touching the inferior border of the molar crypt and the inner cortical surface at the symphysis. The tracings were then grouped in pairs for each patient--one composed of the tracings using the second permanent molar crypt and the other composed of tracings using the third molar crypt. Each pair of tracings was then superimposed on the tangent with registration on the internal cortical structure at the symphysis. (Fig. 5)

In order to quantitate the changes in the position of the inferior border of the mandible, in both an angular

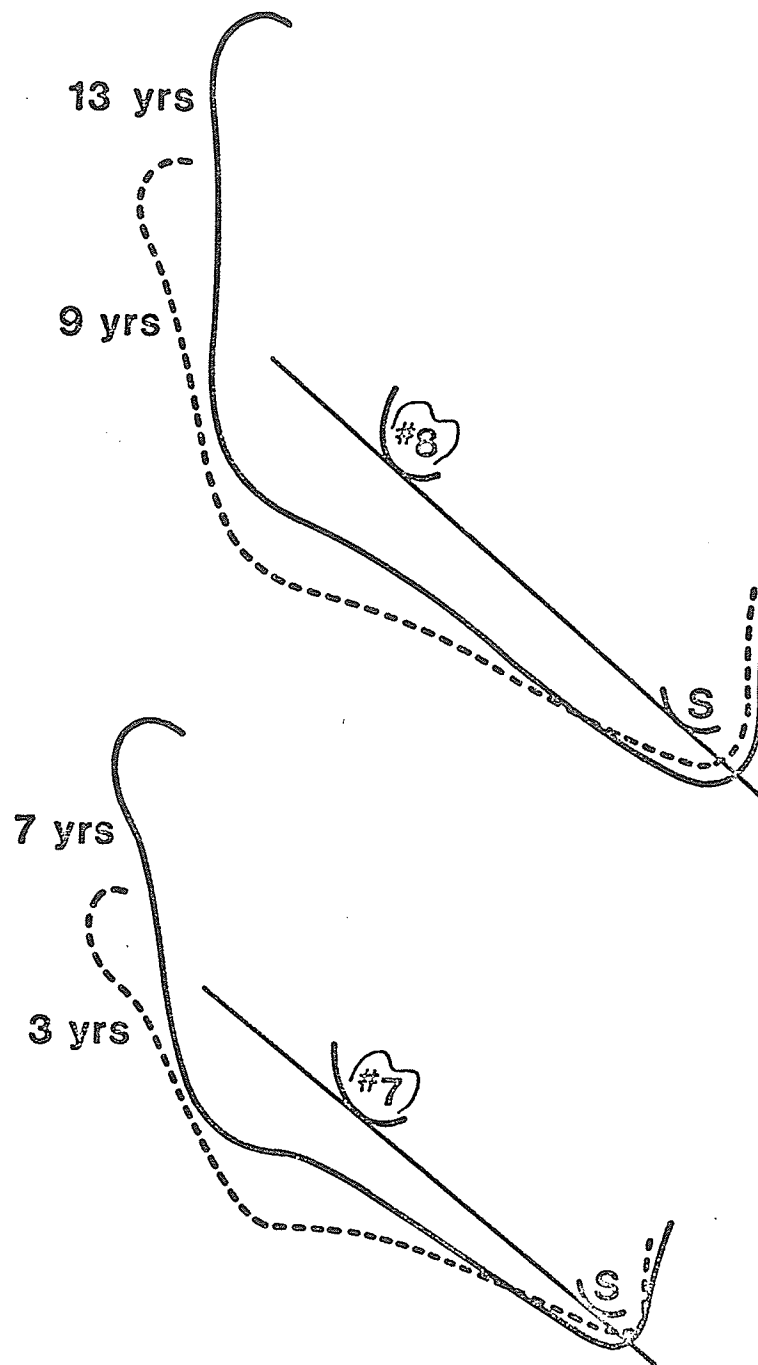

Fig. 5. Paired tracings superimposed on Bjork landmarks.

#7 - second molar crypt

#8 - third molar crypt

S - inner cortical layer at the symphysis

and linear manner, two additional steps were taken. First, a tangent was constructed to the lower border of the mandible on each tracing (mandibular tangent). The angle between these two tangents (M3, M7) was measured to the nearest degree (Fig. 6). The annual rotation of the mandibular tangent for each patient, using both crypts, was determined.

Secondly, a perpendicular was constructed from the tip of each cusp in its older position (second tracing) to the appropriate mandibular tangent and extended to the other mandibular tangent of the superimposed pair. The distance between the two planes on this line was measured to the nearest 0.1 mm (MS in Fig. 7). The annual shift subjacent to each tooth was determined for each patient using both crypts.

It was observed in each superimposition with registration on the internal cortical structure at the symphysis, that the lower border of the molar crypts coincided. In every pair of tracings, and with both landmarks, there was an upward transposition of the lower border of the mandible posterior to the first premolar. The average annual rotation of the mandibular tangent was  $2.17^{\circ}$  when the second molar was used as a landmark and  $1.78^{\circ}$  when the third molar was used as a landmark. (Table IV) The mean linear change per year, subjacent to each of the four mandibular teeth, is shown in Table V. It should

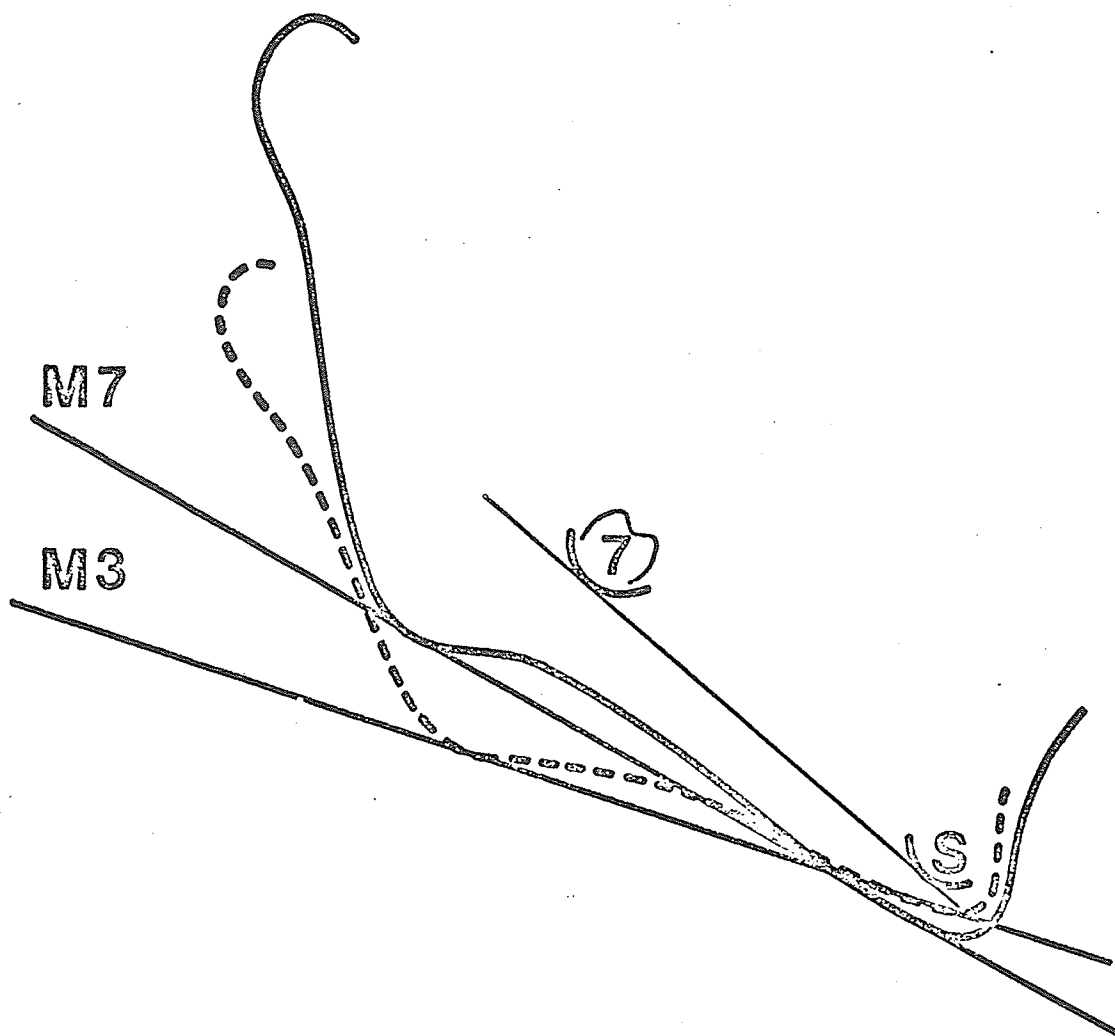

Fig. 6. Mandibular tangent rotation.

- the mandibular border at age 3 years
- M3 - the mandibular tangent at age 3 years
- \_\_\_\_\_ the mandibular border at age 7 years
- M7 - the mandibular tangent at age 7 years
- 7 - the second molar crypt
- S - the inner cortical layer

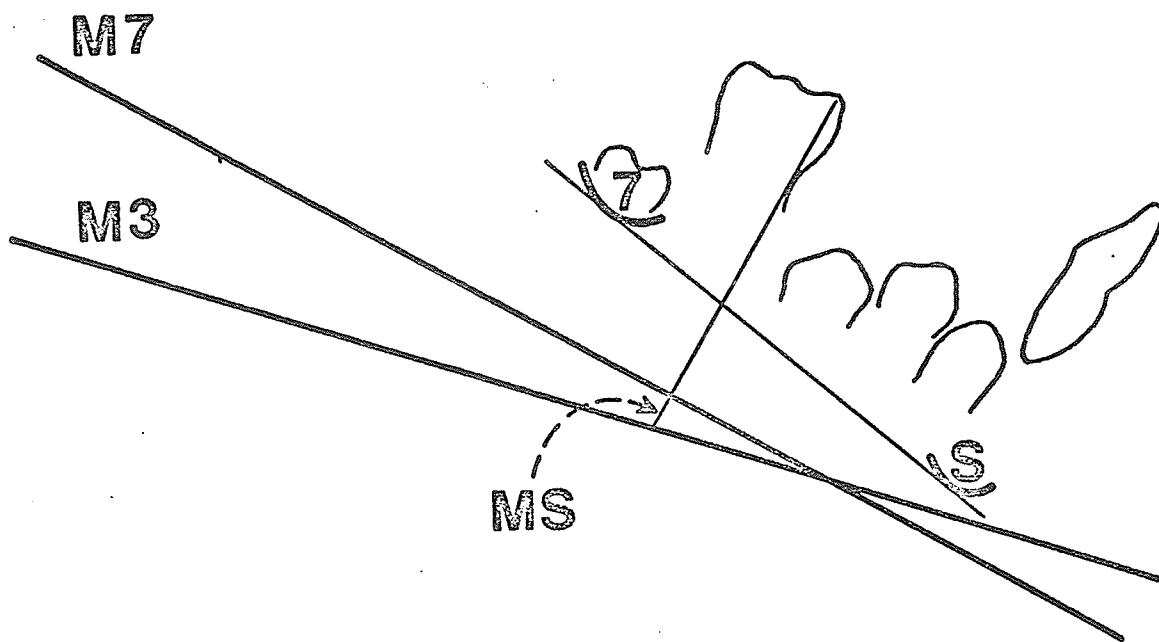

Fig. 7. Mandibular tangent shift.

M3 - Tangent to the inferior border of the mandible  
at age 3 years.

M7 - Tangent to the inferior border of the mandible  
at age 7 years.

7 - second molar crypt

S - inner cortical layer

MS - Mandibular tangent shift subjacent to the  
first molar.

TABLE IV

## MANDIBULAR TANGENT ROTATION

Mean Annual Rotation

| Landmark           | Mean     | S.D.  | S.Em. | n  |
|--------------------|----------|-------|-------|----|
| Second Molar Crypt | -2.17° * | 0.67° | 0.12° | 30 |
| Third Molar Crypt  | -1.78° * | 0.70° | 0.13° | 27 |

A Negative Sign indicates upward rotation of distal portion of the mandibular tangent such as, M3-M7 in Fig. 6.

\* Significantly different at the 5% level of confidence.

TABLE V

## MANDIBULAR TANGENT ROTATION

Mean Annual Change Related to Mandibular Teeth

| Landmark             | Second Molar Crypt |      |       | Third Molar Crypt |      |       |
|----------------------|--------------------|------|-------|-------------------|------|-------|
|                      | n = 30             |      |       | n = 27            |      |       |
| Shift Subjacent To:- | Mean<br>(mm)       | S.D. | S.Em. | Mean<br>(mm)      | S.D. | S.Em. |
| Canine               | +0.03              | 0.05 | 0.01  | -0.06             | 0.15 | 0.03  |
| First Premolar       | -0.13              | 0.17 | 0.03  | -0.19             | 0.15 | 0.03  |
| Second Premolar      | -0.36              | 0.17 | 0.03  | -0.36             | 0.14 | 0.03  |
| First Molar          | -0.60              | 0.22 | 0.04  | -0.42             | 0.21 | 0.04  |

A Negative Sign indicates upward movement of the mandibular tangent such as, a decrease in MS in Fig. 7.



be noted that the linear measurements represent an upward movement of the mandibular tangent in every instance except that subjacent to the canine when the second mandibular molar crypt is used as a landmark. In that one instance, the average movement of the mandibular plane downwards was 0.03 mm which cannot be considered as significantly different to zero.

These measurements were derived in a similar location to those employed to measure eruption rates in this study.

The validity of the observations depend on the behaviour of the molar tooth crypt used as a landmark. Since its mesiodistal stability relative to the symphysis has been demonstrated in each of the 57 superimpositions, the movement of concern is in the vertical vector. An upward movement of the crypt would tend to eliminate or reverse the observations noted. Therefore, the upward shift of the inferior border noted would have to occur at a greater rate than reported to produce the observed result. A downward movement of the crypt, on the other hand, would account for the observed changes shown in Figure 5. However, Bjork's<sup>3</sup> study, utilizing four metallic implants in the mandible, reported the relative stability of the inferior border of the molar crypt. His statement that "The germ is apparently stationary--from the onset of mineralization of the

crown to the time when the root starts to develop...", is not challenged by histologic or radiographic evidence. On the contrary, studies by Orban<sup>33</sup>, Dienst<sup>10</sup>, O'Brien<sup>31</sup>, Shumaker<sup>36</sup>, Gwinnett<sup>13</sup>, and Thomas<sup>38</sup> support Bjork's view. The observed change in the mandibular tangent could be attributed to resorption of the lower border of the mandible. This concept is supported by the histologic studies of Enlow<sup>11</sup> which demonstrated resorption of the inferior border of the mandible in the area where this study indicates a shift occurred.

The available evidence therefore indicates a resorption of the inferior border of the mandible from approximately the first premolar area to the angle. The mandibular tangent is therefore not a satisfactory base line for absolute measurements. All growth data measured from the mandibular tangent are in error by the amount the mandibular tangent shifts.

While an evaluation of the mandibular tangent has been possible in the lateral cephalometric projection, it has not been possible in the oblique because the anterior landmark suggested by Bjork, "the inner cortical structure of the inferior border of the symphysis..."<sup>3</sup> is not identifiable.

Since resorption of the inferior border of the mandible posterior to the first premolar has resulted in rotation of the mandibular tangent as seen on the lateral

projection, similar but as yet unmeasured changes should be expected in the oblique projections.

A comparison of the mandibular tangent and occlusal line was considered desirable. The mean angle between the mandibular and occlusal lines was determined for each age and recorded in Table VI (OH angle, Fig. 9). While the mean value generally increased from year to year at approximately  $1^{\circ}$  annually, the rate and direction were not constant. The annual increment decreased with the eruption of the first permanent molar between ages 6 and 7 and increased between ages 8 and 9 years just prior to the eruption of the permanent canine.

The coefficient of variation of the mean values was uniformly high at approximately 50 percent. The coefficient of variation of the mandibular tangent as evaluated on the lateral projection was 31 percent\* and 39 percent\* respectively for the second and third molar crypt landmarks. It was apparent, therefore, that both occlusal and mandibular reference lines showed considerable variation but that the mandibular tangent was more stable and consistent. Since the occlusal line is determined from points within the dentition, namely, the cusp tip of the canine, primary and permanent, and the distobuccal cusp tip of the second primary and first

\*The coefficients of variation were not significantly different at the 5% level of confidence.

TABLE VI

## OCCLUSAL LINE - MANDIBULAR TANGENT ANGLE

| Age     | Mean Angle        | S.D.             | Coefficient<br>of<br>Variation | Annual<br>Increment |
|---------|-------------------|------------------|--------------------------------|---------------------|
| 3 yrs.  | 10.3 <sup>o</sup> | 5.6 <sup>o</sup> | 54.4                           | 0.6 <sup>o</sup>    |
| 4 yrs.  | 10.9              | 5.3              | 48.6                           | 1.0                 |
| 5 yrs.  | 11.9              | 5.9              | 49.6                           | 0.2                 |
| 6 yrs.  | 12.1              | 6.3              | 52.1                           | -1.1                |
| 7 yrs.  | 11.0              | 5.7              | 51.2                           | -0.3                |
| 8 yrs.  | 10.7              | 5.2              | 48.6                           | 1.3                 |
| 9 yrs.  | 11.4              | 5.4              | 47.4                           | 1.1                 |
| 10 yrs. | 12.5              | 6.0              | 48.0                           | 0.9                 |
| 11 yrs. | 13.4              | 6.6              | 49.3                           | 1.7                 |
| 12 yrs. | 15.1              | 6.6              | 43.7                           | 1.0                 |
| 13 yrs. | 16.1              | 7.0              | 43.5                           | 0.8                 |
| 14 yrs. | 16.9              | 7.4              | 43.8                           |                     |

permanent molars in turn, measurements to this line recorded changes relative to the dentition in function. Not only does the use of this line introduce a new set of variables, but it limits continuous measurement relative to the permanent canine and the first permanent molar.

Since the annual variation of both reference lines is of a low order, short term (3 - 4 years) observations from either base line would be clinically satisfactory. While the occlusal line may be more readily available to the clinician, from a research standpoint the mandibular tangent is more reliable.

(e) Data Management

i Measurement Method

A tracing of the mandible on 0.003" matte acetate film was completed from each of the two oblique cephalometric radiographs taken annually for each patient (Fig. 9). The tracings included:

1. The outline of the radiopaque ring in the plastic ear rod.
2. The inferior border of the mandible beginning on the posterior border of the ramus and continuing to a point above pogonion.

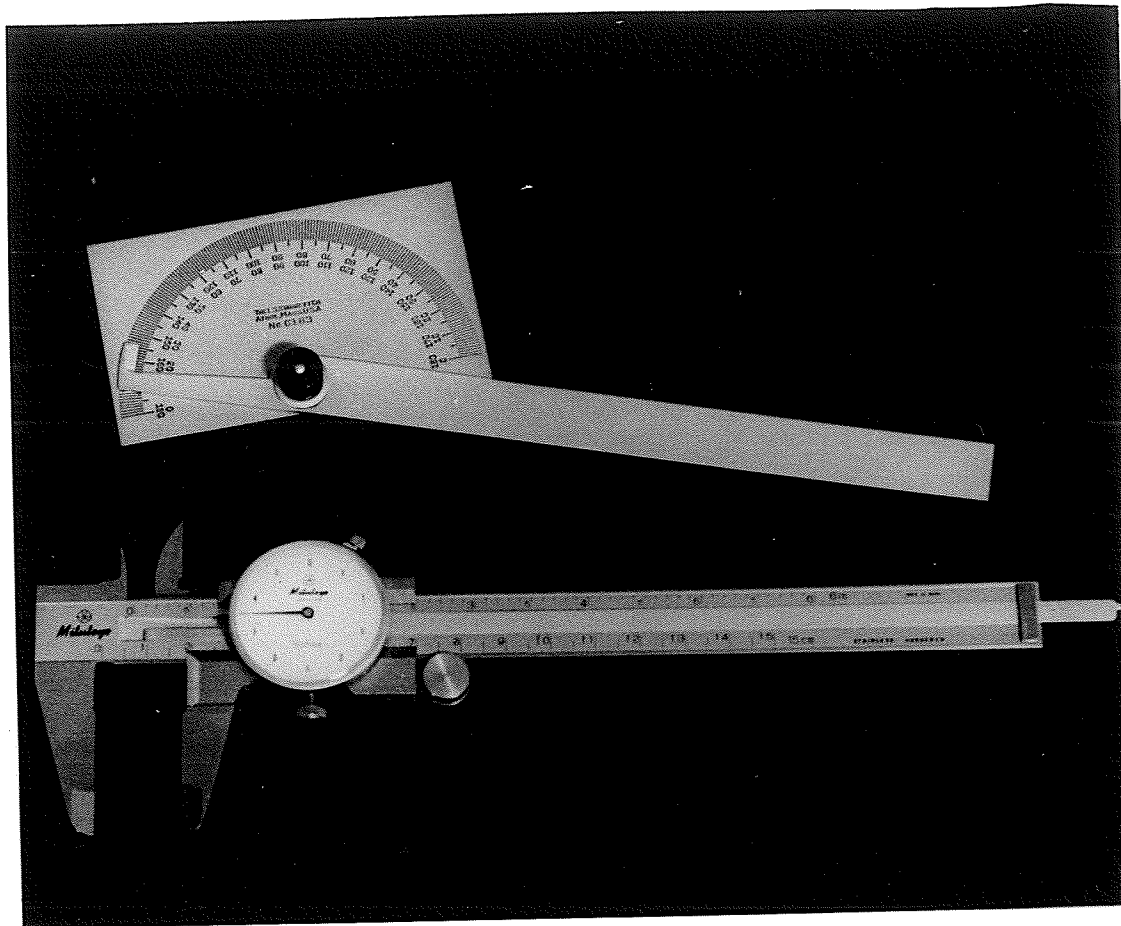

Fig. 8. Measurement Instruments.

Starrett Protractor No. 183.

MITOTOYO Dial Caliper No. 505-633.

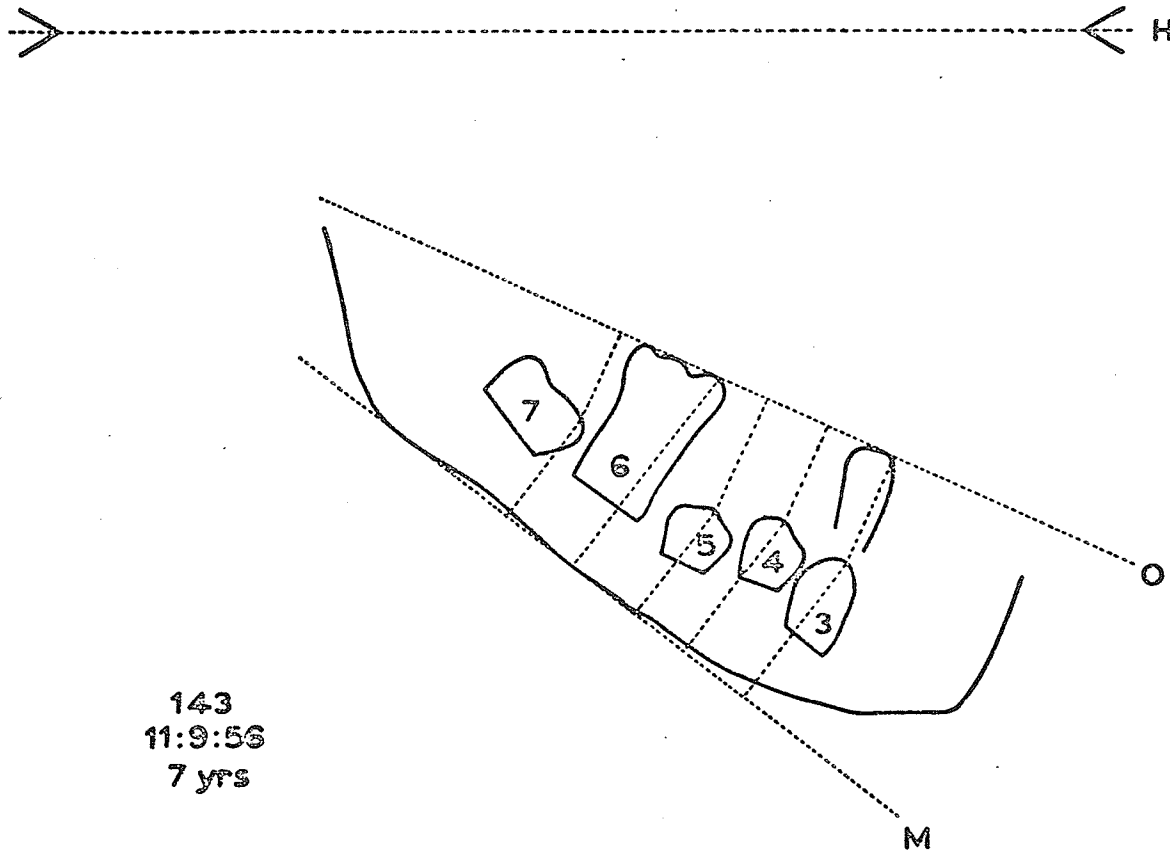

Fig. 9. A sample tracing.

- H - Horizontal line through ear rods
- O - Occlusal line
- M - Mandibular tangent

3. The crown and root outline of each of the mandibular canine, first and second premolars, first and second permanent molars.
4. Until shed, the primary canine crown was traced and until superceded by the eruption of the first permanent molar, the second primary molar was traced.

On the tracing, the following lines were constructed:

1. A horizontal line joining corresponding points in the two ear rods.
2. The occlusal line which was defined:
  - (a) in the primary dentition as from the tip of the primary canine to the tip of the distal cusp of the second primary molar;
  - (b) in the early mixed dentition as from the tip of the primary canine to the tip of the distal cusp of the first permanent molar when the first permanent molar had erupted into occlusion;
  - (c) in the late mixed dentition after the primary canine had been replaced by the permanent canine in occlusion



as from the tip of the permanent canine to the tip of the last cusp of the first permanent molar.

3. A tangent to the inferior border of the mandible at points anterior and posterior to the antegonial notch.
4. A perpendicular was constructed from the cusp tip of each single cusp permanent tooth to the mandibular tangent and to the occlusal line. In the case of multi-cusp teeth, the mesiobuccal cusp tip was selected.

Linear measurements were taken on the tracings using an MITOTOYO Dial Caliper No. 505-633 (Fig. 8) and recorded to the nearest 0.1 mm. The length of the tooth was measured in the direction of a long axis from the tip of the cusp or mesial cusp to the tip of the root apex. Incomplete roots were measured to the midpoint of the open apex. The distance from the cusp tip to the occlusal line, or mandibular tangent, was measured as constructed. When the tip of the cusp of the first molar was used to define the occlusal line, the occlusal line to cusp distance for the first molar was recorded as 0 mm. Distances above the occlusal line were recorded as negative values.

Angular measurements were made with a Starrett protractor number 183 (Fig. 8) and read to the nearest degree.

**Abbreviations:**

Teeth were numbered from mesial to distal according to the Palmer notation as follows: canine No. 3; first premolar, No. 4; second premolar, No. 5; first molar, No. 6; second molar, No. 7.

The horizontal line was indicated by H.

The occlusal line was indicated by O.

The mandibular tangent was indicated by M.

The angle formed by H and O lines was measured on each tracing and indicated by OH.

The angle formed by O and M lines was measured on each tracing and indicated by OM.

Eruption measurements in reference to the occlusal line were indicated by OE; i.e., 5 OE represents the distance from the cusp tip of the second premolar to the occlusal line. Tooth length measurements were indicated by L.

Tooth size and dental arch measurements were made from dental casts. The mesiodistal tooth diameters were taken on teeth providing good access, using the 14 or 16-year casts. However, if extractions, caries, or restorations made this difficult earlier casts were used. The measurements were made with a sharpened Boley vernier gauge and recorded to the nearest 0.1 mm. The dental arch measurements were taken from casts obtained at nine

years of age. The distance from the mesial contact area of the first molar to the distal contact area of the lateral incisor was recorded to the nearest 0.1 mm. All the data was transferred to IBM cards for processing at the University of Western Ontario, model 7040 IBM computer.

### ii Error Analysis

Since errors were inherent in measuring technique, 20 case records from the total sample were randomly selected for remeasurement. Appendix A reports the mean, the standard deviation, and the "t" value of the differences between the first and second measurements of the dental casts. Appendix B is similar data for the 360 sets of values derived from the oblique films. Since both the first and second measurements were taken from the same material, the differences represent the error in measurement of casts or the error in measuring and tracing in the recording data. The errors were analyzed in two ways, by:

1. evaluating the magnitude of the mean difference;
2. determining the statistical significance of the differences.

#### MAGNITUDE OF THE MEAN DIFFERENCE

Moorrees<sup>26</sup> found the standard deviation of the

differences in the duplicated measurements of the mesio-distal diameters on 360 permanent mandibular teeth to be 0.09 mm. Hunter and Priest<sup>21</sup>, in a similar study, using twenty-three casts and two investigators, found that the mean difference for mandibular teeth was 0.039 mm and 0.046 mm for left and right sides respectively.

Hunter<sup>18,19</sup> in an assessment of Burlington material, found in a replication sample of 20, that the mean difference in the mesiodistal tooth size ranged between 0.024 mm and -0.09 mm with a maximum standard deviation of 0.036 mm. The replication study of 20 randomly selected cases in this sample revealed a maximum difference of 0.06 mm and a maximum standard deviation of the difference of 0.23 mm. The mean difference was comparable to that found by Moorrees and Hunter but the standard deviation of the differences were higher than both. Since the measurements are recorded to the nearest 0.1 mm, the magnitude of the differences noted are within acceptable limits.

Hunter<sup>20</sup> and Lauterstein<sup>23</sup> have placed the upper limit of acceptable error in measurements from cephalometric films at 0.5 mm. Of the 360 series of paired measurements (Appendix B), 15 showed a mean difference of greater than 0.5 mm of which 7 were less than 0.6 mm. It should be noted that 7 of the mean differences greater than 0.5 mm occurred in those situations where the sample

was less than 10; i.e.,  $n = 2, 3, 5, 7, 7, 8,$  and 9. Six of the large mean differences occurred on the 7L measurement which cast some doubt on its reliability. In 21 instances, the mean difference was zero. Of the remaining 339, 171 were negative indicating no consistent tendency for the mean of the second measure to be larger or smaller than the mean of the first measure.

With the possible exception of the 7L measurements, the magnitude of the errors was considered within acceptable limits for this type of study.

#### STATISTICAL EVALUATION

A "t" test was applied to determine the significance of the difference of the mean at the 5 percent level of confidence. In examining the replicated measurements from the dental casts, it was found that the two series were not significantly different at the 5 percent level.

The 360 sets of values from the films revealed that in 51 instances where "n" was greater than 10, the differences were significant at the 5% level (Appendix B). The high "t" values occurred because of small variances rather than large differences. It should be noted that in only 4 instances were the mean differences, both statistically significant at the 5 percent level and

clinically significant at greater than 0.5 mm. All four of these measures (right side, age 5, 7L; left side, age 11, 3L; right side, age 12, 6L; right side, age 13, 7L) involve tooth length which requires more subjective interpretation of the radiograph by the examiner.

### iii Array of Data

While bilateral symmetry of mesiodistal tooth diameter was reported by Moorrees and Reed<sup>27</sup>, bilateral symmetry of mandibular tooth eruption was not found consistently by Lauterstein<sup>25</sup>. In this study, bilateral symmetry was examined by comparing the corresponding corrected right and left measurements (OE, ME, and L) of individual teeth for each patient at each age. The data from both right and left sides were then combined in subsequent computations and in effect, doubled the sample size. Mesiodistal tooth diameter as determined on dental casts were also compared.

The data were assembled in a manner that would describe the eruption and growth characteristics of the teeth involved; i.e., the eruption and growth profile. This was achieved by computing the means (also S.D. and S.E.M.) of the OE, ME, and L measures for each tooth in each age for the untreated cases. This would be expected to produce curves representing accumulated growth experience.

In addition, the mean annual increments of the OE, ME, and L measures were calculated. This would be expected to graphically represent the rate of growth on a chronologic basis. The incremental data was also arrayed on a physiologic basis, standardizing the data for each tooth by registration on the year of maximum eruption as measured from the mandibular line (ME).

In order to investigate the relationship of tooth length increase (root growth), mesiodistal tooth diameter and crowding with eruption rate, three groups of correlations were computed. The annual increments in eruption were correlated with the annual increment in tooth length. The correlation of the mesiodistal crown diameter with the maximum eruption rate was computed. In this procedure the maximum eruption rate was defined as the greatest sum of two successive increments. Finally, the correlation between the maximum eruption rate and the dental arch space available at age 9 was computed. Dental arch space available was calculated as the difference between the distance from the distal of the lateral incisor to the mesial of the first molar minus the sum of the mesiodistal diameters of the canine, first and second premolars, as described in the subsection on Measurement Methods.

## IV

### RESULTS

#### (a) Bilateral Symmetry

The bilateral symmetry of mesiodistal crown diameter as measured on casts was determined with a "t" test. It was found that there was no significant difference at the 1 percent level of confidence. (Appendix C) This is in accord with Moorrees and Reed<sup>27</sup> who reported correlation coefficients for the mesiodistal crown diameter of antimeres ranging from +0.87 to +0.93 for the mandibular teeth considered in this study. Consequently the mesiodistal tooth size measurements for antimeres were combined as one sample.

The correlation of the occlusal line-mandibular tangent (OM) angle and the corrected measurements from cusp tip to occlusal line (OE), cusp tip to mandibular tangent (ME), and tooth length (L) from both sides for each tooth (canine, first and second premolar, first and second molar) at each age (3-14 years) is recorded in Appendix D. A strong positive value (greater than +0.6) was found in 177 of the 192 correlations determined. There were 8 nil correlation values which in each instance involved nil measurements; i.e., 3 OE which is 0 mm. by definition when the canine has erupted to the plane of occlusion. Two low correlations (age 3, 5 OE and 7L)



involve samples of three and four patients for which this analysis is not appropriate. Of the remaining five low correlations, two involve very small measures similar to the measurement error. The remaining three (age 12, 6 L; age 13, 3 L; and age 14, 7 L) can be accounted for only on the basis of difficulty in radiographic interpretation or errors in recording data.

In general, the bilateral symmetry was found to be consistent and strongly positive to a degree sufficient to justify combination of measurements from the right and left side in the untreated cases comprising this study.

#### (b) Eruption Profile

The eruption and tooth growth data are tabulated in Appendix E while Figures 10, 11, 12, 13, and 14 visualize for each tooth its mean eruption in relation to the occlusal plane (Scale A), mandibular plane (Scale B), its growth in length (Scale C), and one standard deviation above and below the mean.

In general, each curve represents a flattened sigmoid curve typical of those found in growth studies. The canine, first and second premolars demonstrate a large standard deviation in the middle of the eruption curves, indicating considerable variability around the mean. The OE data (Scale A) ends in a straight line with a zero standard deviation because each tooth eventually reaches the

*ERUPTION AND GROWTH  
OF THE MANDIBULAR CANINE*

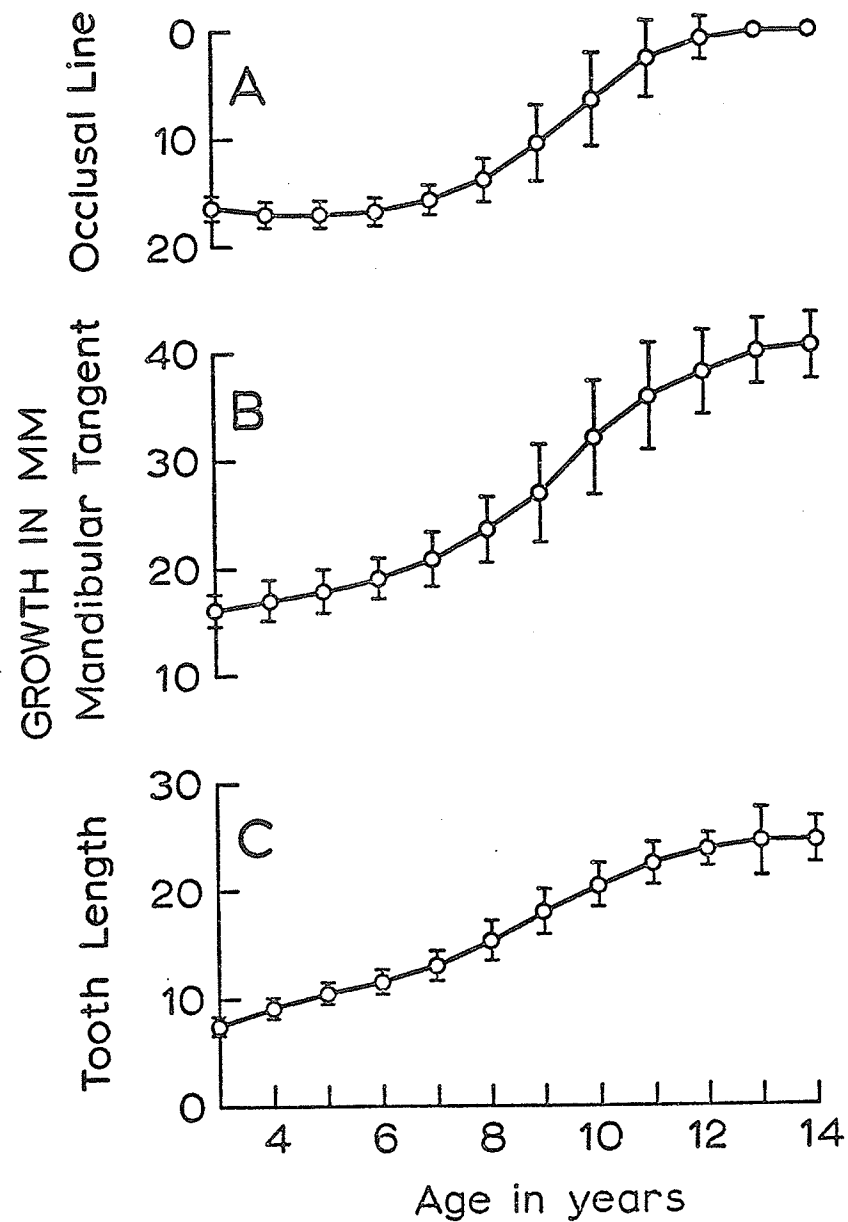

Fig. 10. Eruption and growth of the mandibular canine.

Scale A - mean distance from the occlusal line (OE).

Scale B - mean distance from the mandibular tangent (ME).

Scale C - mean tooth length (L).

Vertical bars represent  $\pm 1$  Standard Deviation.

*ERUPTION AND GROWTH  
OF THE MANDIBULAR FIRST PREMOLAR*

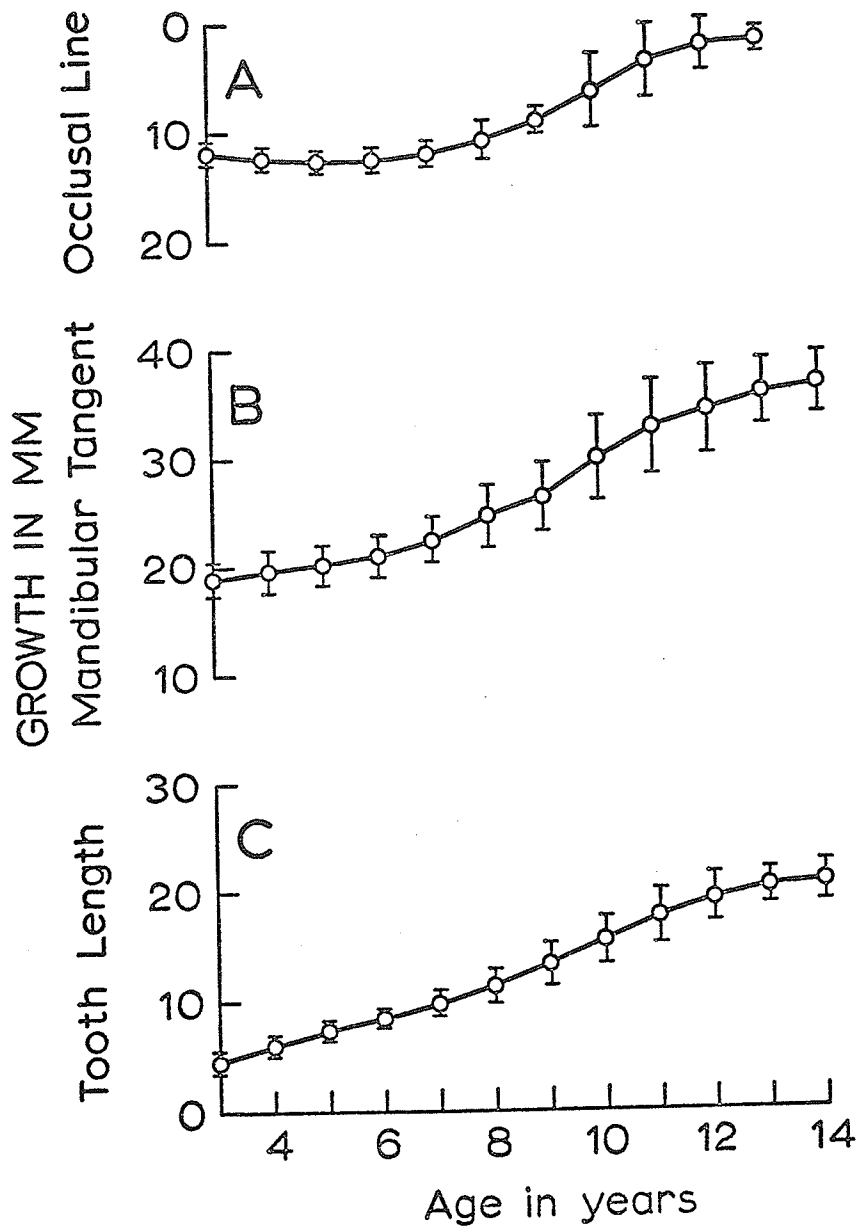

Fig. 11. Eruption and growth of the mandibular first premolar.

Scale A - mean distance from the occlusal line (OE).

Scale B - mean distance from the mandibular tangent (ME).

Scale C - mean tooth length (L).

Vertical bars represent  $\pm 1$  Standard Deviation.

*ERUPTION AND GROWTH  
OF THE MANDIBULAR SECOND PREMOLAR*

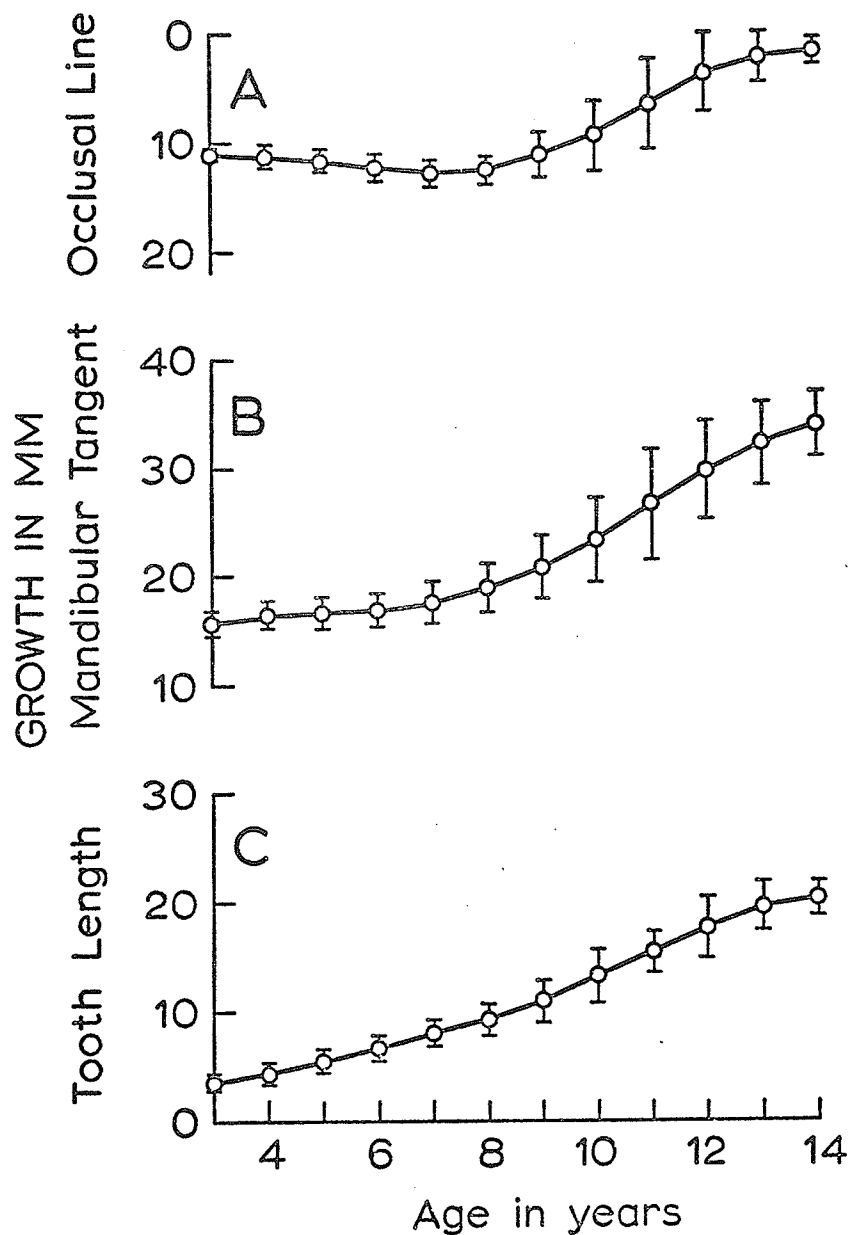

Fig. 12. Eruption and growth of the mandibular second premolar.

Scale A - mean distance from the occlusal line (OE).

Scale B - mean distance from the mandibular tangent (ME).

Scale C - mean tooth length (L).

Vertical bars represent  $\pm 1$  Standard Deviation.

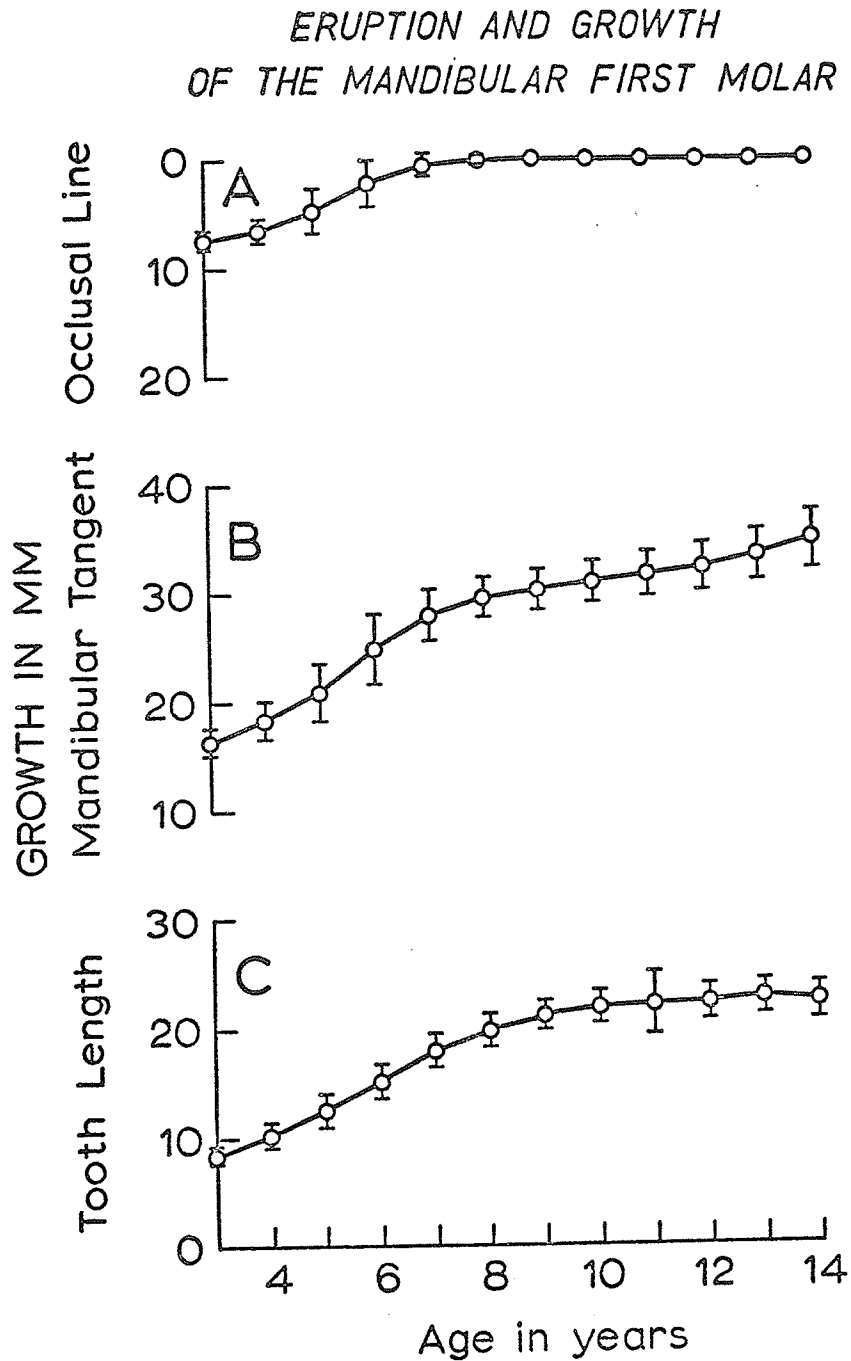

Fig. 13. Eruption and growth of the mandibular first molar.

Scale A - mean distance from the occlusal line (OE).

Scale B - mean distance from the mandibular tangent (ME).

Scale C - mean tooth length (L).

Vertical bars represent  $\pm 1$  Standard Deviation.

*ERUPTION AND GROWTH  
OF THE MANDIBULAR SECOND MOLAR*

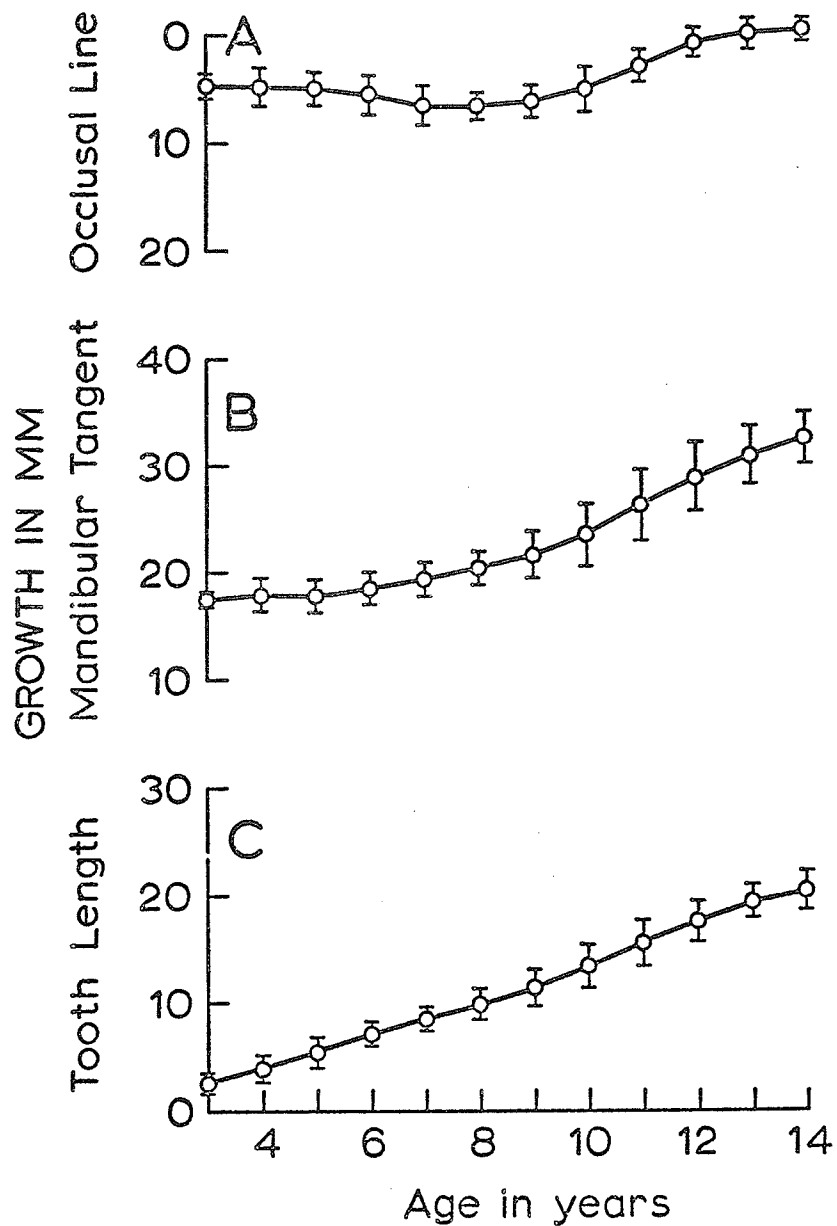

Fig. 14. Eruption and growth of the mandibular second molar.

Scale A - mean distance from the occlusal line (OE).

Scale B - mean distance from the mandibular tangent (ME).

Scale C - mean tooth length (L).

Vertical bars represent  $\pm 1$  Standard Deviation.

occlusal plane. The ME data (Scale B) produces curves that persist to age 14 and continue to demonstrate variation.

Negative curves in the OE data are shown by the canine and first premolar at ages four to five, the second premolar at age seven and the second molar at age six and seven.

The incremental data arrayed on a chronologic scale is recorded in Appendix F and visualized in Figures 15, 16, 17, 18, and 19. The incremental data are more sensitive of the changes in the rates of eruption. OE data (Scale A) and ME data (Scale B) for all teeth reveal increasing rates of eruption to a peak rate from which the rate rapidly declines. Means up to 5.0mm. per year (canine between the ages of 9 and 10 years, Fig. 15) are recorded. The maximum mean eruption rate measured from the mandibular plane (ME, Scale B) was found to occur between ages 5 and 6 for the first molar, between ages 9 and 10 years for the canine and first premolar, and between 11 and 12 years for the second premolar and the second molar. These data also demonstrate the wide variations in eruption rates when arrayed on a chronologic basis. For instance, the standard deviation for the maximum mean eruption rate (ME) of the second premolar is 3.3 mm. while the standard deviation of that mean is 2.7 mm.

CHRONOLOGICAL ERUPTION AND GROWTH RATE  
OF THE MANDIBULAR CANINE

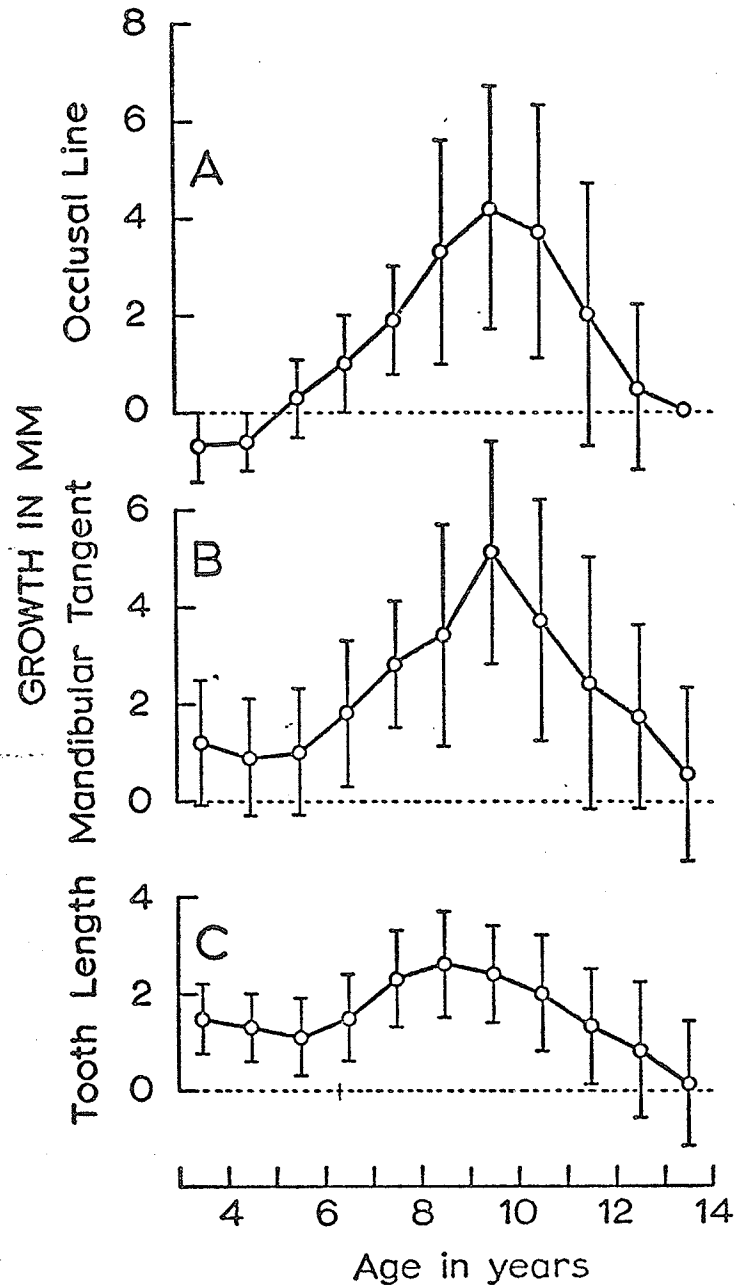

Fig. 15. Chronological eruption and growth rate of the mandibular canine.

Scale A - mean annual increments in eruption toward the occlusal line (OE).

Scale B - mean annual increments in eruption from the mandibular plane (ME).

Scale C - mean annual increments in tooth length(L).

Vertical bars represent  $\pm 1$  Standard Deviation.



CHRONOLOGICAL ERUPTION AND GROWTH RATE  
OF THE MANDIBULAR FIRST PREMOLAR

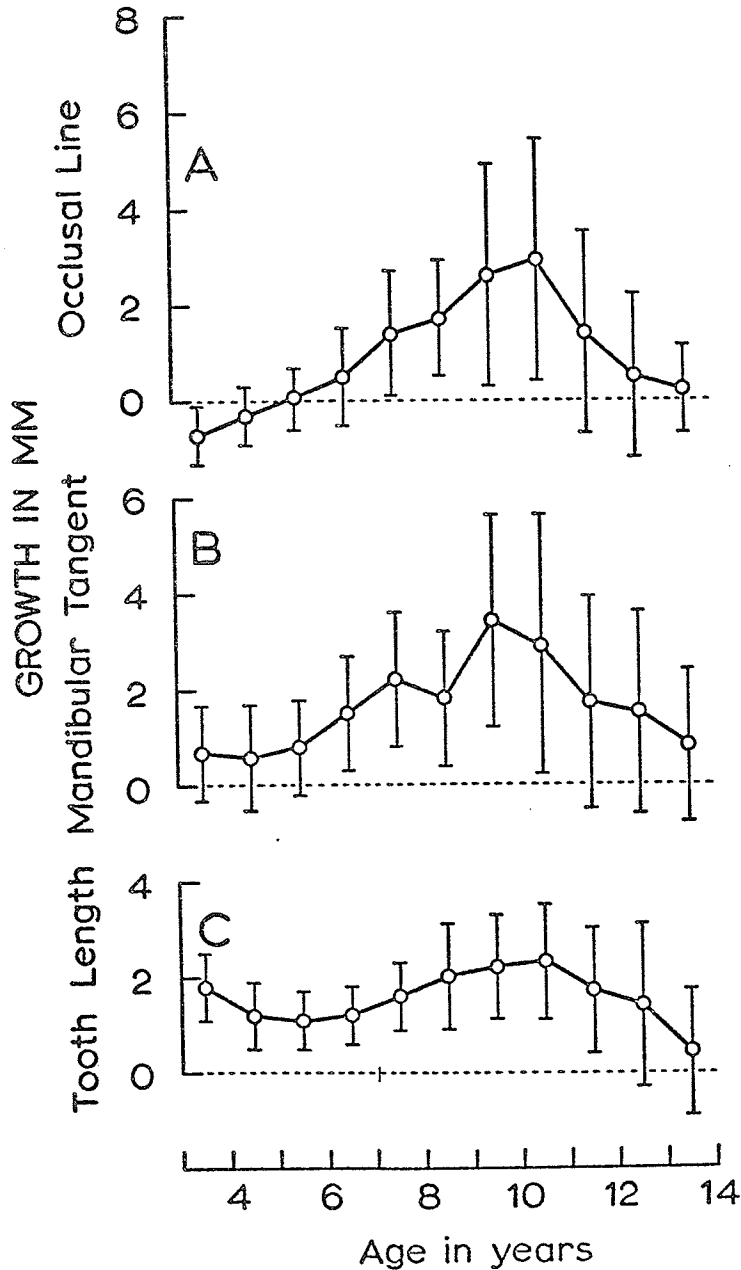

Fig. 16. Chronological eruption and growth rate of the mandibular first premolar.

Scale A - mean annual increments in eruption toward the occlusal line (OE).

Scale B - mean annual increments in eruption from the mandibular plane (ME).

Scale C - mean annual increments in tooth length (L).

Vertical bars represent  $\pm 1$  Standard Deviation.

CHRONOLOGICAL ERUPTION AND GROWTH RATE  
OF THE MANDIBULAR SECOND PREMOLAR

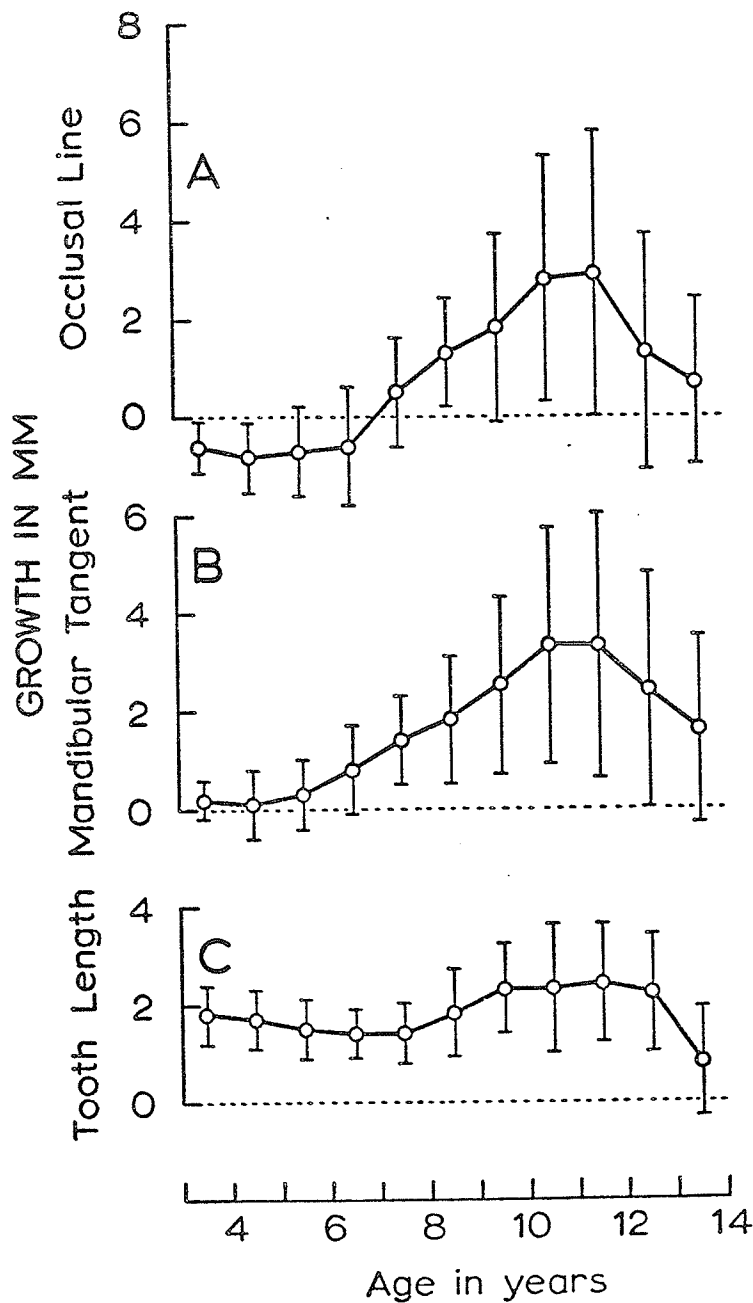

Fig. 17. Chronological eruption and growth rate of the mandibular second premolar.

Scale A - mean annual increments in eruption toward the occlusal line (OE).

Scale B - mean annual increments in eruption from the mandibular plane (ME).

Scale C - mean annual increments in tooth length (L).

Vertical bars represent  $\pm 1$  Standard Deviation.

CHRONOLOGICAL ERUPTION AND GROWTH RATE  
OF THE MANDIBULAR FIRST MOLAR

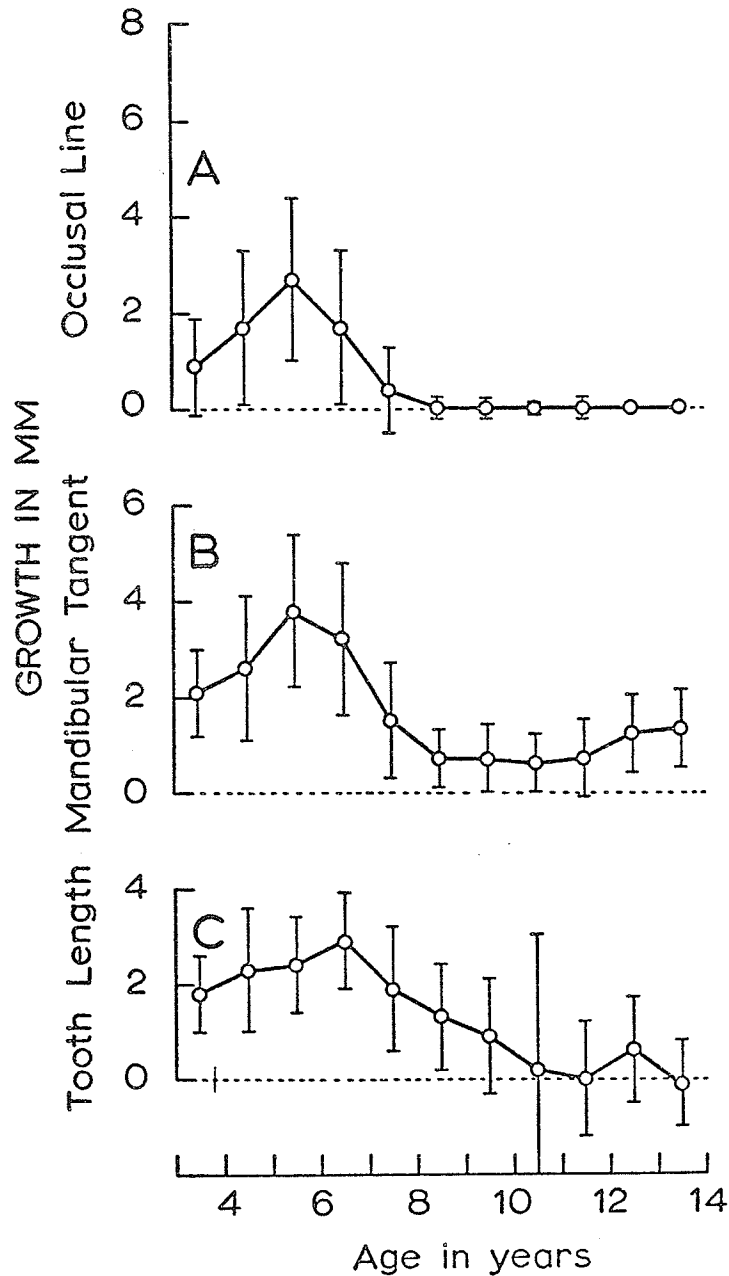

Fig. 18. Chronological eruption and growth rate of the mandibular first molar.

Scale A - mean annual increments in eruption toward the occlusal line (OE).  
 Scale B - mean annual increments in eruption from the mandibular plane (ME).  
 Scale C - mean annual increments in tooth length (L).  
 Vertical bars represent  $\pm 1$  standard Deviation.

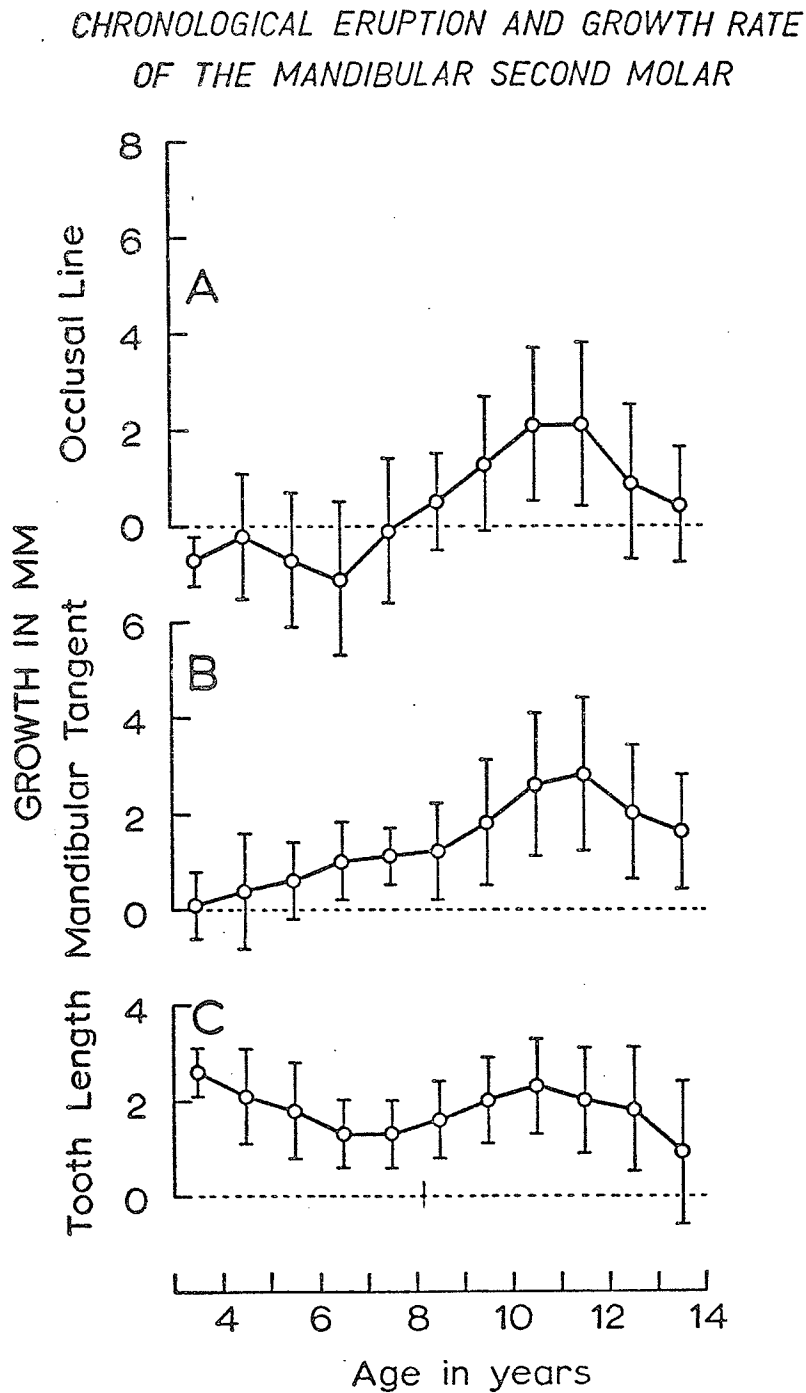

Fig. 19. Chronological eruption and growth rate of the mandibular second molar.

Scale A - mean annual increments in eruption toward the occlusal line (OE).

Scale B - mean annual increments in eruption from the mandibular plane (ME).

Scale C - mean annual increments in tooth length (L).

Vertical bars represent  $\pm 1$  Standard Deviation.

The distribution around the mean is widest between ages 9 and 12 years on canine, first and second premolars.

Another observation demonstrated by these data concerns tooth length or root growth increments. In the canine the mean root increment and mean ME eruption rate are similar until age 8 - 9 years when they differ markedly. At that time the root growth rate was found to decline when eruption was accelerating (Fig. 15, scale B and C, age 8 - 9 years). This divergence between mean root growth rate and mean eruption rate occurring with peak eruption was found with each tooth studied except the first permanent molar. It should also be noted that at age 14 years, the first and second premolars and the second permanent molars still demonstrated root growth while the canine and first permanent molars have largely ceased root growth showing zero mean increment values.

Eruption rate data were arrayed on a physiologic event - namely, the maximum ME eruption rate. (Appendix G) The comparison of the chronologic and physiologic array of data is shown for the canine in Figure 20. This illustration demonstrates a more rapid increase and decrease in rate of eruption to and from a greater mean maximum rate of 6.8 mm with a smaller variability as revealed by the standard deviation of 1.6 mm. With each of the five teeth and over the 12 years there is a general reduction in variability when the data is arrayed on a physiologic basis. (Figs. 21, 22, 23, 24, and 25)

MEAN AND STANDARDISED ERUPTION RATES  
OF THE MANDIBULAR CANINE

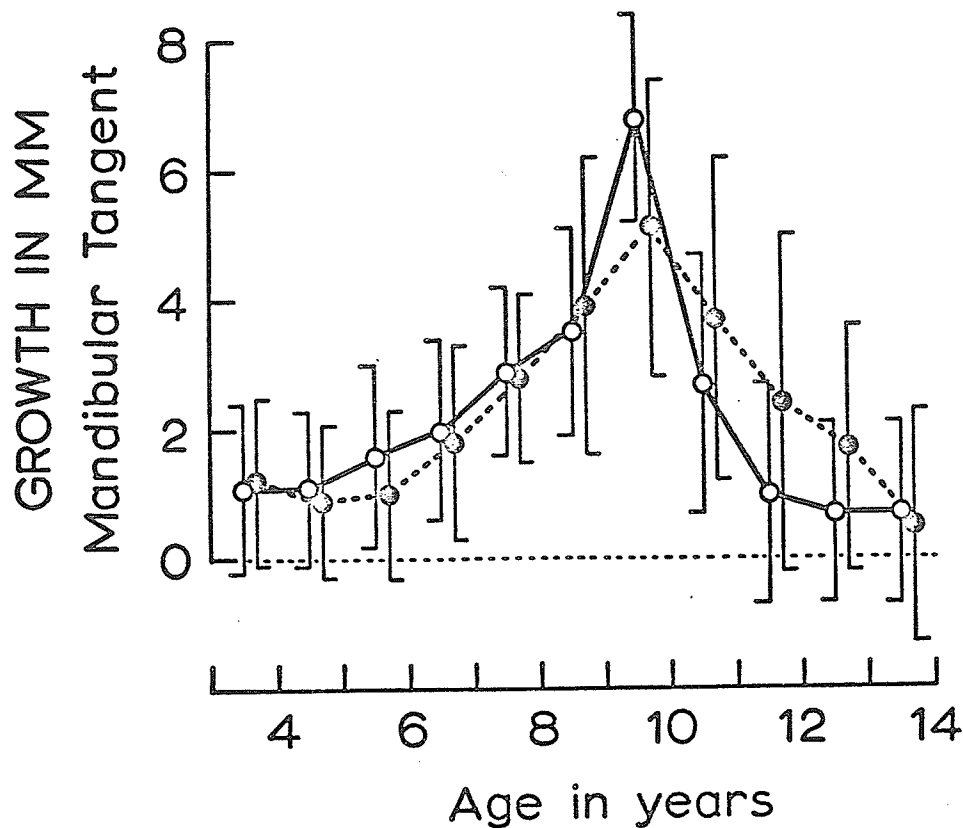

Fig. 20. A comparison of eruption profiles plotted on chronologic age, and year of maximum velocity.

- mean eruption rate (ME) arrayed on chronologic age.  
—○— mean eruption rate (ME) when each individual's data is plotted according the year of maximum velocity.  
Vertical bars represent  $\pm 1$  Standard Deviation.

STANDARDISED ERUPTION AND GROWTH RATE  
OF THE MANDIBULAR CANINE

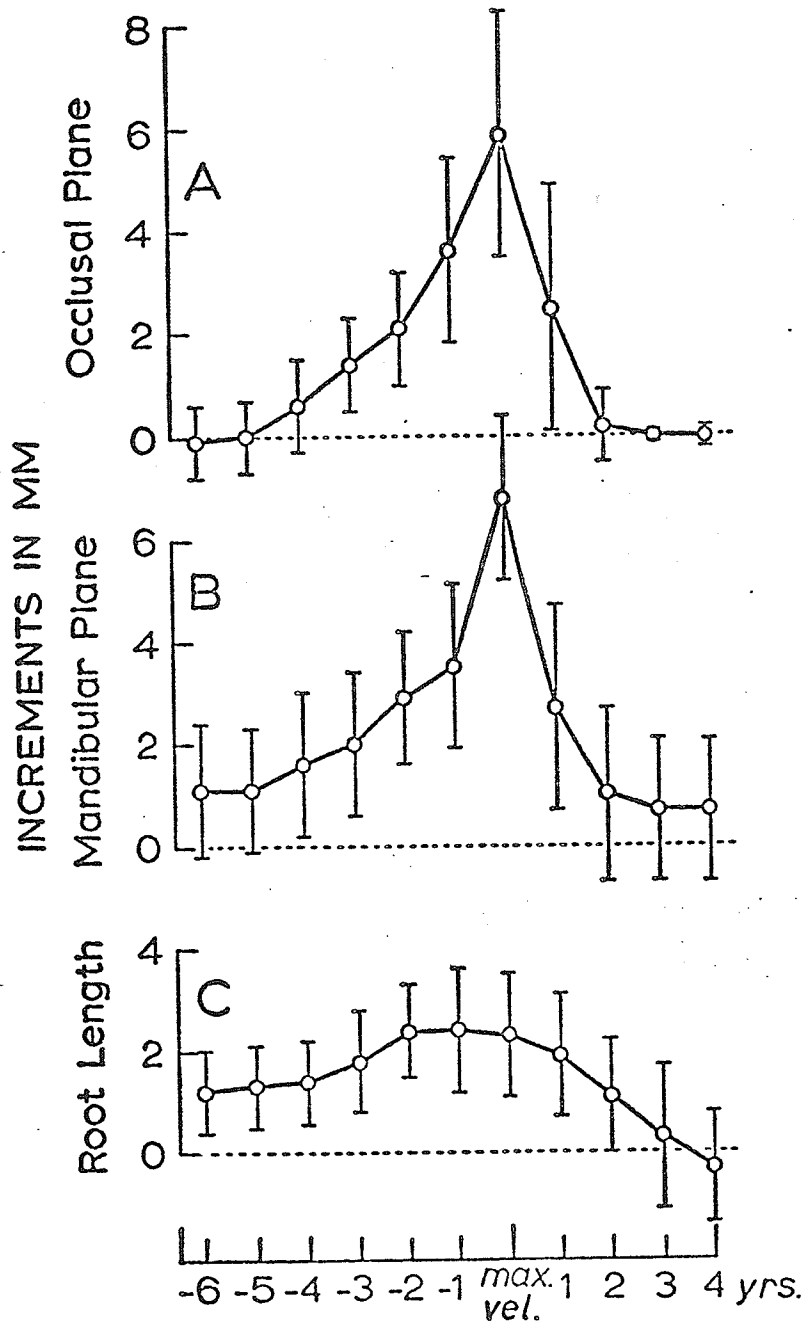

Fig. 21. Eruption and growth rate of the mandibular canine standardised on the year of maximum velocity.

Scale A - mean annual increments in eruption toward the occlusal line (OE).

Scale B - mean annual increments in eruption from the mandibular tangent (ME).

Scale C - mean annual increments in tooth length (L). Vertical bars represent  $\pm 1$  Standard Deviation.

STANDARDISED ERUPTION AND GROWTH RATE  
OF THE MANDIBULAR FIRST PREMOLAR

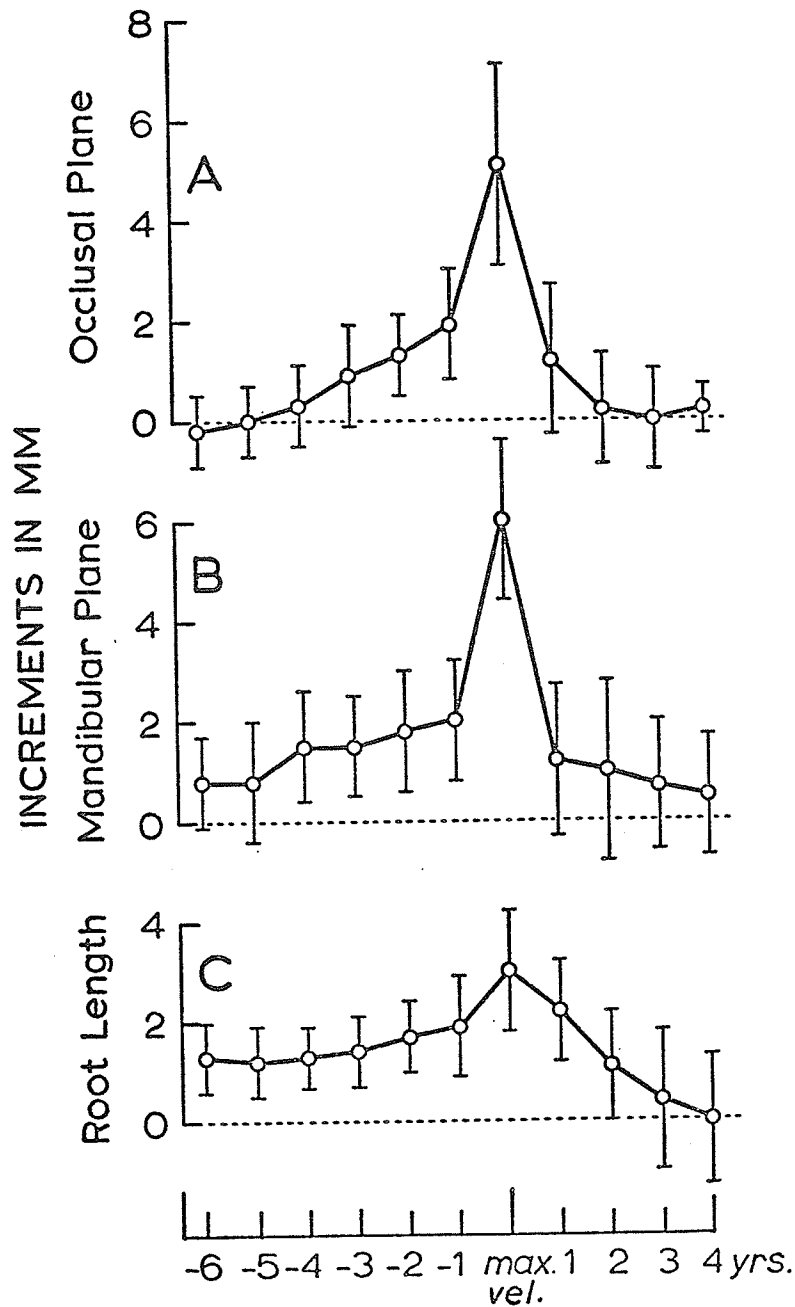

Fig. 22. Eruption and growth rate of the mandibular first premolar standardised on the year of maximum velocity.

Scale A - mean annual increments in eruption toward the occlusal line (OE).

Scale B - mean annual increments in eruption from the mandibular tangent (ME).

Scale C - mean annual increments in tooth length (L).

Vertical bars represent  $\pm 1$  Standard Deviation.



STANDARDISED ERUPTION AND GROWTH RATE  
OF THE MANDIBULAR SECOND PREMOLAR

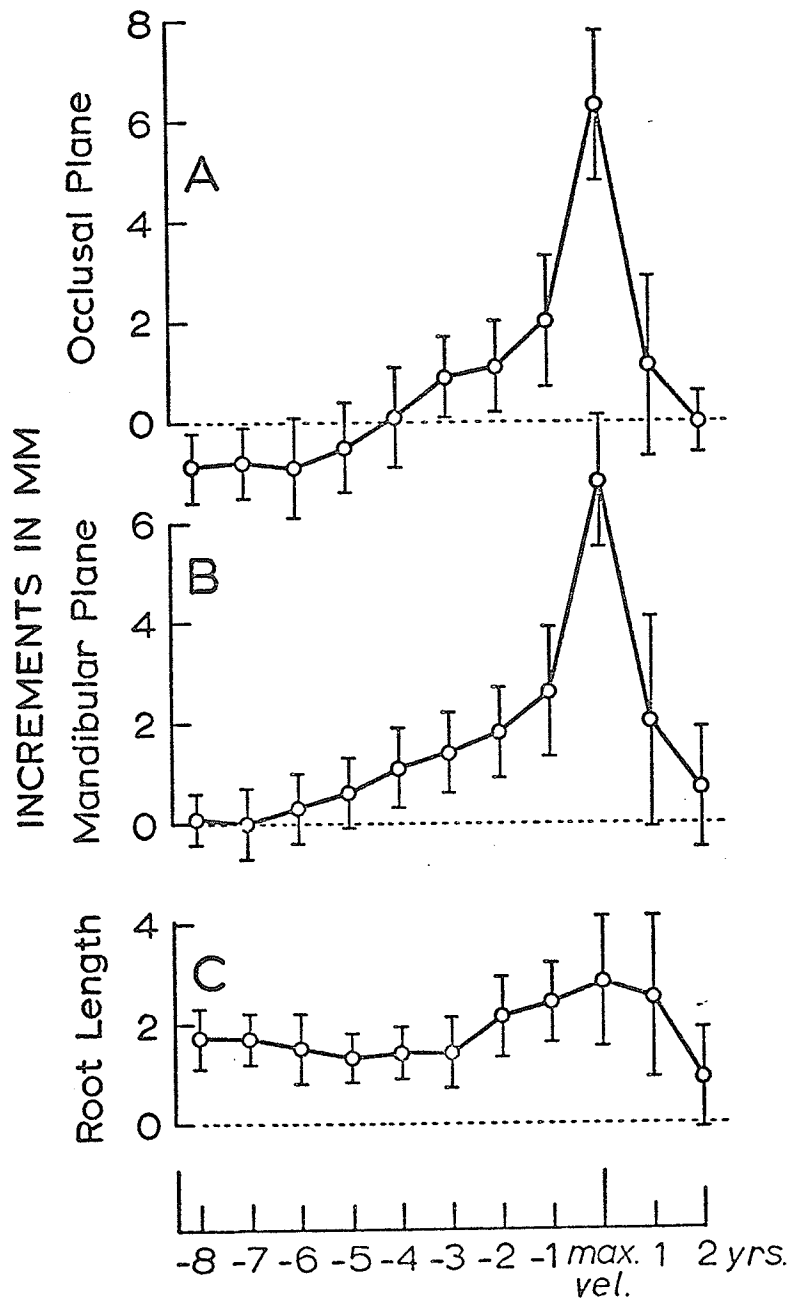

Fig. 23. Eruption and growth rate of the mandibular second premolar standardised on the year of maximum velocity.

Scale A - mean annual increments in eruption toward the occlusal line (OE).

Scale B - mean annual increments in eruption from the mandibular tangent (ME).

Scale C - mean annual increments in tooth length (L).

Vertical bars represent  $\pm 1$  Standard Deviation.

STANDARDISED ERUPTION AND GROWTH RATE  
OF THE MANDIBULAR FIRST MOLAR

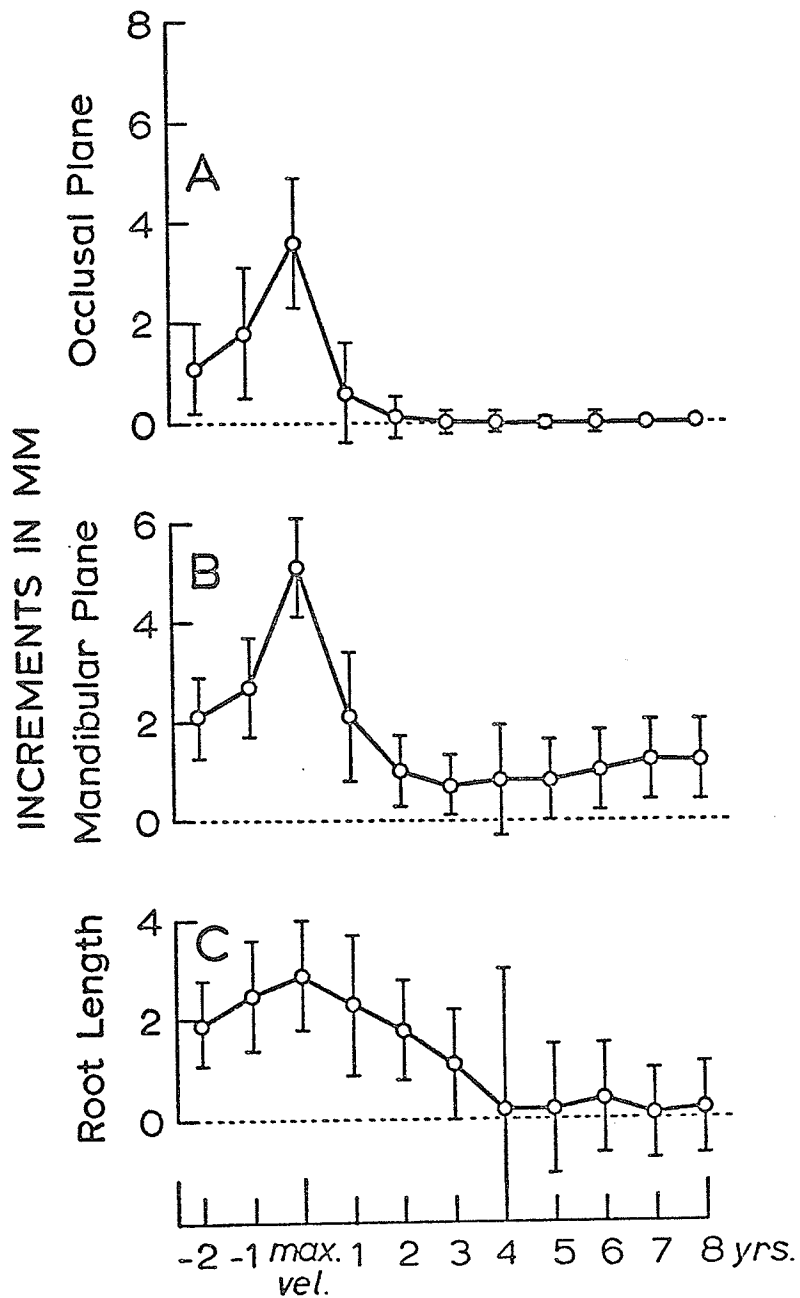

Fig. 24. Eruption and growth rate of the mandibular first molar standardised on the year of maximum velocity.

Scale A - mean annual increments in eruption toward the occlusal line (OE).

Scale B - mean annual increments in eruption from the mandibular tangent (ME).

Scale C - mean annual increments in tooth length (L).

Vertical bars represent  $\pm 1$  Standard Deviation.

STANDARDISED ERUPTION AND GROWTH RATE  
OF THE MANDIBULAR SECOND MOLAR

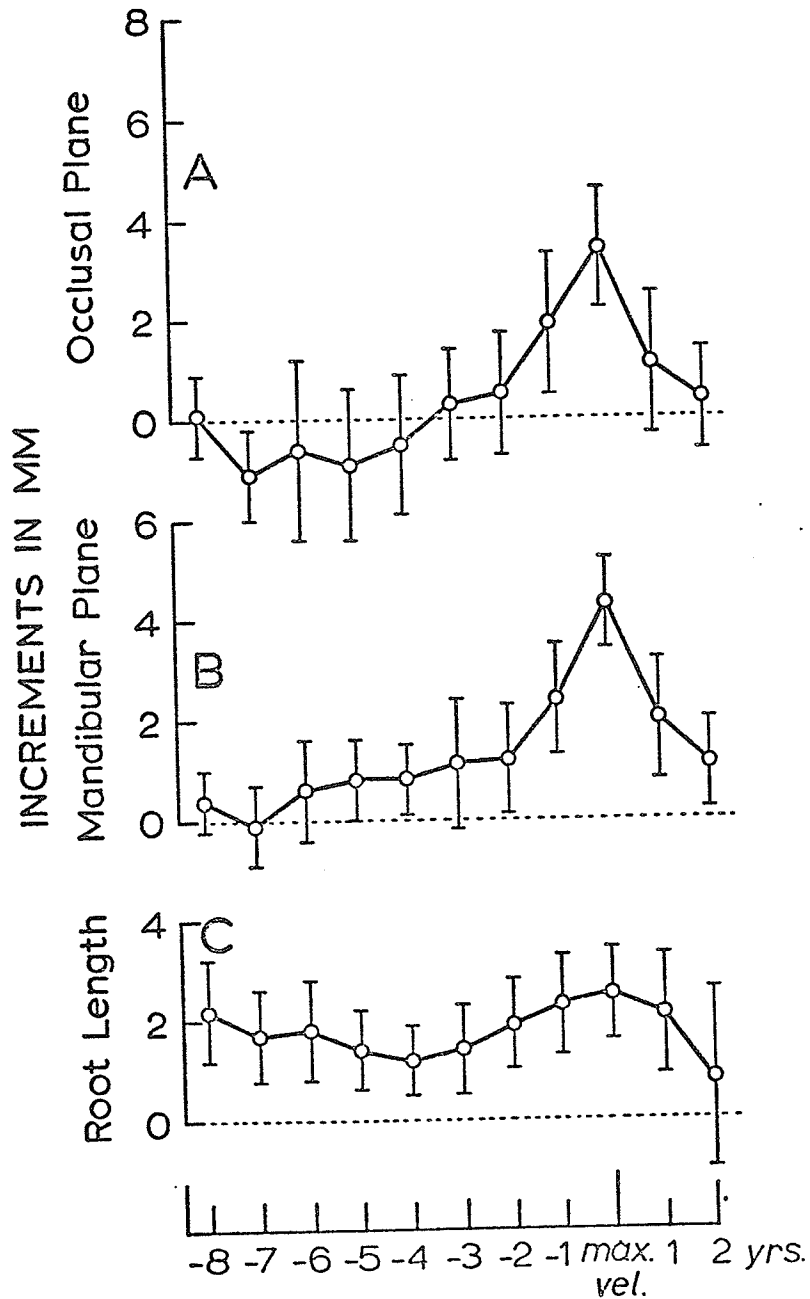

Fig. 25. Eruption and growth rate of the mandibular second molar standardised on the year of maximum velocity.

- Scale A - mean annual increments in eruption toward the occlusal line (OE).  
 Scale B - mean annual increments in eruption from the mandibular tangent (ME).  
 Scale C - mean annual increments in tooth length (L).  
 Vertical bars represent  $\pm 1$  Standard Deviation.

A sharper curve and a greater maximum ME and OE rate occurs in each instance. The bimodal curve shown in Figure 16 for the chronologic array of 5 ME (Scale B) disappears in the physiologic array (Fig. 22) and is replaced by the sharp peaked curve characteristic of the other four teeth studied. While the general character of the root growth curve remains similar in both chronologic and physiologic data, the marked divergence between eruption rates and root growth rates at the time of maximum eruption is accentuated.

It should be noted that the OE eruption rate data shows negative values in the early years for all teeth except the first molar. The tooth length increments, except for the first molar, show initially a declining rate followed by an accelerated rate of growth. The change in trend from declining rate to an increasing rate coincides with the completion of the crown and the beginning of root growth.

The relation between the rate of increase in tooth length and annual eruption increment is shown in Table VII. The increments in tooth length after crown completion represent root growth. The correlation values are all positive ranging up to +0.662. The higher values generally occur two or three years before the maximum eruption rate, i.e., during the intrabony phase of eruption. With each

TABLE VII

## CORRELATION OF ANNUAL ERUPTION WITH INCREMENTS IN ROOT LENGTH

|                 | 3-4 yrs.             | 4-5 yrs.             | 5-6 yrs.             | 6-7 yrs.             | 7-8 yrs.             | 8-9 yrs. |
|-----------------|----------------------|----------------------|----------------------|----------------------|----------------------|----------|
| Canine          | 0.530 S              | 0.243                | 0.495 S              | 0.590 S              | 0.553 S              | 0.443 S  |
| First Premolar  | 0.362 S <sup>1</sup> | 0.341 S <sup>1</sup> | 0.413 S              | 0.612 S              | 0.566 S              | 0.608 S  |
| Second Premolar | 0.553                | 0.067                | 0.076                | 0.284 S <sup>1</sup> | 0.594 S              | 0.547 S  |
| First Molar     | 0.571 S              | 0.600 S              | 0.371 S              | 0.277 S <sup>1</sup> | 0.293 S <sup>1</sup> | 0.462 S  |
| Second Molar    | 0.476                | 0.212                | 0.372 S <sup>1</sup> | 0.384 S              | 0.422 S              | 0.501 S  |

S - indicates a correlation significant at the 1% level of confidence

S<sup>1</sup> - indicates a correlation significant at the 5% level of confidence

TABLE VII cont'd.

CORRELATION OF ANNUAL ERUPTION WITH INCREMENTS IN ROOT LENGTH

|                 | 9-10 yrs. | 10-11 yrs. | 11-12 yrs.           | 12-13 yrs.           | 13-14 yrs. |
|-----------------|-----------|------------|----------------------|----------------------|------------|
| Canine          | 0.161     | 0.269      | 0.526 S              | 0.185                | 0.384      |
| First Premolar  | 0.516 S   | 0.597 S    | 0.576 S              | 0.503 S <sup>1</sup> | 0.662      |
| Second Premolar | 0.571 S   | 0.495 S    | 0.190                | 0.331                | 0.642      |
| First Molar     | 0.462 S   | 0.237      | 0.296                | 0.262                | 0.268      |
| Second Molar    | 0.587 S   | 0.407 S    | 0.422 S <sup>1</sup> | 0.366                | 0.410      |

S - indicates a correlation significant at the 1% level of confidence

S<sup>1</sup> - indicates a correlation significant at the 5% level of confidence

tooth there was a reduced correlation at the time of maximum eruption rate. The canine and second premolar showed a marked decrease from a moderately strong (+0.443 and +0.495) and significant correlations to much lower values (+0.161 and +0.19) which were not significant. Of the 55 correlations shown, 35 were statistically significant.

The relation between the mesiodistal crown diameter as measured on casts with the maximum eruption is shown in Table VIII. All of the correlation values are small ranging from -0.087 to +0.263. However, the first and second premolars and the second molar are significant at the 1 percent level of confidence.

The relationship between the maximum eruption rate of the canine, first and second premolars and the space available for these teeth between the distal of the lateral incisor and the mesial of the first molar is shown in Table IX. All values are positive, ranging up to +0.586 and are significant. There is a progression of increasingly positive correlation from the canine to the second premolar.

TABLE VIII

CORRELATION OF MAXIMUM ERUPTION RATE WITH CROWN SIZE

---

|                 |        |                   | n   |
|-----------------|--------|-------------------|-----|
| Canine          | 0.115  |                   | 98  |
| First Premolar  | 0.263  | Significant at 1% | 98  |
| Second Premolar | 0.244  | Significant at 1% | 98  |
| First Molar     | -0.087 |                   | 100 |
| Second Molar    | 0.259  | Significant at 1% | 91  |



TABLE IX

CORRELATION OF MAXIMUM ERUPTION RATE  
WITH AVAILABLE ARCH SPACE

---

|                 | R        | L                     |
|-----------------|----------|-----------------------|
| Canine          | +0.362 S | +0.246 S <sup>1</sup> |
| First Premolar  | +0.459 S | +0.391 S              |
| Second Premolar | +0.586 S | +0.513 S              |

- Eruption rate is measured from the mandibular plane (ME)
- "Available Space" is the difference between the sum of the mesiodistal crown diameters of the canine, first and second premolars and the distance from the distal contact area of the lateral incisor to the mesial contact area of the first permanent molar at age 9 years.

S - indicates significance at 1% level of confidence

S<sup>1</sup> - indicates significance at 5% level of confidence

## DISCUSSION

The consistent finding of high positive bilateral correlation values in eruption data does not agree with the findings of Lauterstein et al<sup>25</sup>. However, it should be noted that Lauterstein was comparing the simultaneous eruption of three teeth. Several environmental influences such as infection, pulpotomy, extraction, and crowding could also have affected each tooth to varying degrees and therefore influenced the relative eruption position. The present study did not include patients who had primary tooth extraction, dentoalveolar infection, or pulpotomy, as shown by examination of case history, radiographs, and casts. The present study used data from annual examinations while Lauterstein employed examinations at more frequent intervals which would tend to make his data more sensitive to the "fits and starts" of eruptive movements.

The finding of positive bilateral correlation values in root growth agrees with Lauterstein's<sup>23</sup> findings and suggests that root development is not as responsive to environmental influences as is eruptive movement and progresses more smoothly. The high correlation values reported here and the variability within the eruption data suggests that there is more variation between individuals than between right and left sides within untreated normal individuals when examined annually.

The occlusal line and mandibular tangent are not ideal reference lines. Both are subject to considerable variation and in addition the occlusal line is subject to variables present in the functioning dentition. However, it should be noted that the eruption rate data for both reference lines closely parallel each other. While the mandibular tangent is a more reliable reference, the occlusal line could serve as a useful clinical reference. It must be remembered that all eruption data measured from the mandibular tangent represent the actual advance of the tooth less the distance that the mandibular tangent moves upwards. Until the status of the mandibular tangent as found in the oblique projection has been assessed using implants in the manner of Bjork<sup>3</sup> the true eruption rate cannot be derived from these data. It must be emphasized that the more reliable (ME) data are relative--not absolute data. Eruption in each instance has been stated in relation to a moving reference line.

The eruption and growth data arrayed on a chronologic basis showed two principal characteristics--a sigmoid curve, typical of growth data, and considerable variability around the means. While variability is normal in growth data, it makes more difficult the description of the behaviour of a group and more hazardous the definition of growth standards.

The variability of eruption time is well known<sup>4, 6</sup>

Not so well known is the contribution to the variability of eruption data made by arrhythmias described by Lauterstein<sup>25</sup>. The eruption and growth data in Figures 10, 11, 12, 13, and 14 illustrate cumulative growth, while the growth rate data, organized on a chronologic basis is shown in Figures 15, 16, 17, 18, and 19. The growth rate data illustrates much more clearly the quantitative changes in the growth process.

The preeruptive phase (Weinman<sup>40</sup>) is shown as a period of no occlusal movement (A Scales, Figs. 10, 11, 12, and 14), slight occlusal movement (B Scales) and very modest increases in tooth length (C Scales). The preeruptive changes shown in the B and C Scales indicate increase in crown length. The negative movement shown on the A Scales of the canine, first and second premolars, and second molar indicate that the occlusal plane is moving away from the developing rootless tooth. The rate of elongation of a tooth is faster during root formation than during crown formation as shown by a declining or level L rate until crown completion followed by an increasing L rate as root formation progresses.

The intra-bony phase of eruption of each tooth showed a continuously increasing rate from the time the crown was completed (Nolla Stage 6<sup>28</sup>) until the eruption spurt that carried the tooth into occlusion. This continuous and

uniform increase is closely parallel to the increase in root length. The correlation between root growth and eruption is most favorable during this period. The possibility that root growth contributes to eruptive movement is supported by the data derived from the intra-bony phase. However, if during this phase root growth was the only causal factor, the correlation values should be higher.

At the end of the intra-bony phase of eruption, the eruption rate increases markedly up to mean values of 6mm per year. Eruption of 6mm per year, or 0.5mm per month represents a marked change in the physiologic activity of the tooth and its supporting structures. This pre-occlusal eruption spurt, like the prepubertal growth spurt suggests a physiologic event of considerable significance in the maturation of the system under study. The eruptive spurt, followed by a rapidly declining eruption rate is easily identified as a sharp peak on the curves of eruption increment. This maximum eruption rate is the most spectacular and most easily identifiable event in the eruption of the tooth as revealed by these data. For this reason registration or standardization of the eruption curves on the year of maximum eruption rate was attempted. The resulting eruption rate curves which are similar for each tooth demonstrate a sharper

"peak" and also a marked reduction in variability around the means.

The "preocclusal eruption spurt" was not reported by Bradley<sup>4</sup>, Carlson<sup>6</sup> or Shumaker<sup>3,6</sup>. The variability shown in the chronologic data, due to the variation of eruption time, has been removed. The standardized data therefore describes a sequence of events in the eruption of the teeth studied and therefore represent the eruption profiles of the canine first and second premolars, first and second molars much more accurately than the chronologic data.

The relation of eruption rate and tooth growth rate at the time of maximum eruption, varies considerably from that seen during the intra-bony phase. The canine, for example, shows a maximum ME rate of 6.9mm and a concomitant L rate of 2.3mm as seen on standardized data (Fig. 21, Appendix G). In so doing, the mean canine eruption movement exceeded the mean root growth by 4.6mm. Similarly, maximum eruption exceeds root growth by 3.0mm, 4.0mm, 2.2mm, and 1.8mm in the first and second premolars and first and second molars respectively. Concurrently, the correlation between root growth and eruption declines (Table VII). These observations indicate that considerable eruptive activity occurs that could not be the direct result of root elongation. The single rooted teeth in each instance demonstrated mean maximum eruption rates that were

double or more the mean increase in root length.

When the eruption rate declines following occlusal contact, it did not reach a zero value during the duration of this study. The positive ME value at age 14 represents the rate at which the occlusal line was moving away from the mandibular tangent. All teeth showed a persistence of ME rate between ages 13 and 14 of 0.5mm, 0.8mm, 1.6mm, 1.3mm, and 1.6mm for the canine first and second premolars, first and second molars respectively. These data indicate not only movement of the occlusal line away from the mandibular tangent but also that the angular relationship between these two lines was changing. It should also be noted that root elongation had ceased on the canine first premolar and first molar while eruption continued.

Hatton's study<sup>14</sup>, using Burlington data showed a relation between early eruption at 6 years and small tooth size in mandibular first molars. The current study (Table VIII) shows a negative but small correlation (-0.087) of no statistical significance between the mesiodistal crown diameter and maximum eruption rate. These findings do not show the degree of concurrence that might be expected.

It should be noted that Hatton's study varied in a number of ways from the current study. Hatton measured mesiodistal crown diameter on tracings from the oblique projection at age 3. This introduces additional measurement

errors, elongation distortion, and the question of crown completion at age 3 (Nolla<sup>28</sup>). The current study used actual tooth size measured on casts. Hatton applied no correction factors to data from the oblique projection.

The eruption rate of the canine first and second premolars and second molars showed small positive correlations with mesiodistal tooth diameter. While three of the correlations were significantly different than zero, they are of little predictive value.

The correlation between available arch space and eruption rate (Table IX) supports the clinical observation that crowded teeth erupt more slowly. The finding permitted the extension of this hypothesis when it showed that the eruption rate of the second premolar is more affected by the crowding than the canine or first premolar. This is in accord with the eruption sequence in the area. The usefulness of these findings are enhanced by the fact that the data came from casts of 9-year-old boys with intact arches which would tend to conceal the relationship shown.



## VI

### CONCLUSIONS

A longitudinal study of the eruption of the mandibular canine, first and second premolar, first and second molars was conducted using the radiographic cephalometric records of 54 untreated boys annually from ages 3 to 14 years.

The mandibular tangent from the lateral cephalometric projection was found to rotate at approximately  $2^{\circ}$  per year due, it was suggested, to resorption at the inferior border posterior to the first premolar. Eruption data measured on oblique films from the mandibular tangent are subject to correction due to the rotation of this reference line. The occlusal line was found to be a clinically useful but less stable reference line.

Strong positive bilateral correlations of mandibular eruption and tooth growth data from the oblique projection was demonstrated on annual records.

The eruption rates of the canine, first and second premolars, first and second molars increased steadily following the completion of the crowns. The mean eruption rates of each tooth demonstrated a "preocclusal eruption spurt" of 4-7 mm per year, followed by a sharp reduction in eruption rate. Mean annual postocclusal eruption rates of 0.5-1.6 mm persisted at age 14 years.

The eruption rate data showed less variability when standardized physiologically on the year of maximum eruption.

Root growth did not correlate strongly with eruption especially during the "preocclusal eruption spurt" when the eruptive movements of the single rooted teeth were double or more the mean increase in tooth length.

Crowding measured at age 9 was associated with slower eruption rates of the canine, first and second premolars while the second premolar was more affected than the first premolar or the canine.

## BIBLIOGRAPHY

1. Barber, T.K., Pruzansky, S. and Kindelsperger, R. An evaluation of the oblique cephalometric film. *J.Dent. Child.*, 28:94-105, 2nd quar., 1961.
2. Barber, T.K., Pruzansky, S., Lauterstein, A. and Kindelsperger, R. Application of roentgenographic cephalometry to pedodontic research. *J.Dent. Child.*, 27:97-106, 2nd quar., 1960.
3. Bjork, A. Variations in the growth pattern of the human mandible: longitudinal radiographic study by the implant method. *J.Dent. Res.*, 42:400-411, 1963.
4. Bradley, R.E. The relationship between eruption, calcification and crowding of certain mandibular teeth. *Angle Orthodont.*, 31:230-236, Oct. 1961.
5. Brodie, A.G. On the growth pattern of the human head from the third month to the eight year of life. *Am.J. Anat.*, 68:209-262, 1941.
6. Carlson, H. Studies on the rate and amount of eruption of certain human teeth. *Am.J. Orthodont. and Oral Surg.*, 30:575-588, 1944.
7. Cartwright, L.J. and Harvold, E. Improved radiographic results in cephalometry through the use of high kilovoltage. *Canad. Dent. A.J.*, 20:261-263, May 1954.
8. Demography of Burlington population and the status of the Burlington sample. *Burlington Orthodontic Research Centre Progress Report*, 4:12-22, 1959.
9. Description of the Records. *Burlington Orthodontic Research Centre Progress Report*, 1:10, 1956.
10. Dienststein, B. Tooth development and eruption II biometric analysis of the histologic relationship of the root of the mandibular first molar of the rat in growth and eruption to the lower border of the mandible. *J.Dent. Res.*, 35:479, June 1956.
11. Enlow, D.H. and Harris, D.B. A study of the postnatal growth of the human mandible. *Am.J. Orthodont.*, 50:25-50, Jan. 1964.

## BIBLIOGRAPHY (Cont'd)

12. Explanatory notes for landmarks in measurements.  
Burlington Orthodontic Research Centre Progress Report, 3:45-59, 1958.
13. Gwinnett, A.J. Personal communication, Nov. 3, 1969.
14. Hatton, Margaret E. A determination of tooth position and eruptive rate of the mandibular first permanent molar in relation to arch width and arch length beginning when the child is three years of age. Burlington Orthodontic Research Centre Progress Report, 1:33-35, 1956.
15. Hatton, Margaret E. and Grainger, R.M. Reliability of measurements from cephalograms at the Burlington Orthodontic Research Centre. J.Dent. Res., 37: 853-9, Sept. 1958.
16. Hatton, Margaret E. and Feasby, W.H. Some research findings from the Burlington Orthodontic Research Centre of particular interest to clinicians. Canad. Dent. A.J., 28:502-6, Aug. 1962.
17. Hatton, Margaret E. A test to determine the reliability of measurements taken from tracings of oblique cephalograms. Burlington Orthodontic Research Centre Progress Report, 1:31-83, 1956.
18. Hunter, W.S. Tooth size, spacing crowding, arch relationships, and arch dimensions in the orthodontically supervised group. Burlington Orthodontic Research Centre Progress Report, 6:31-83, 1961.
19. Hunter, W.S. Tooth size, spacing crowding, arch relationships, and arch dimensions in six nine-year-old children. Burlington Orthodontic Research Centre Progress Report, 5:78-114, 1960.
20. Hunter, W.S. Elementary principles of cephalometrics. (p.261-283), (In Enlow, D.H., The human face. New York, Harper and Row, 1968. 303p.)
21. Hunter, W.S. and Priest, W.R. Errors and discrepancies in measurement of tooth size. J.Dent. Res., 39:405-414, March-April 1960.

## BIBLIOGRAPHY (Cont'd)

22. Krogman, W.M. and Sassouni, V. Syllabus in roentgenographic cephalometry. Philadelphia, College Offset, p.363, 1957.
23. Lauterstein, A.M. and Pruzansky, S. Bilateral symmetry in mandibular apical tooth growth. Unpublished manuscript, 24 pages typed, 1967.
24. Lauterstein, A.M., Pruzansky, S. and Barber, T.K. Effect of deciduous mandibular molar pulpotomy on the eruption of succedaneous premolar. J.Dent. Res., 41:1367-72, Nov.-Dec. 1962.
25. Lauterstein, A.M. and Pruzansky, S. and Levine, N.L. Bilateral asymmetry in mandibular tooth development. J.Dent. Res., 46:279-285, Jan.-Feb. 1967.
26. Moorrees, C.F.A. Dentition of the growing child. Cambridge, Mass., Harvard Univ. Press, 245p. (79-86), 1959.
27. Moorrees, C.F.A. and Reed, R.B. Correlations among crown diameters of human teeth. Arch.Oral Biol., 9:685-697, 1964.
28. Nolla, Carmen M. The development of the permanent teeth. J.Dent. Child., 27:254-266, 4th quar., 1960.
29. Experimental design of the study. Burlington Orthodontic Research Centre Progress Report, 1:6-8, 1956.
30. The Objectives of the Burlington Orthodontic Research Centre. Burlington Orthodontic Research Centre Progress Report, 1:1-2, 1956.
31. O'Brien, C., Bhaskar, S. and Brodie, A.G. Eruptive Mechanism and movement in the first molar of the rat. J.Dent. Res., 37:467-484, June 1958.
32. Occlusal plane as related to age and occlusion. Burlington Orthodontic Research Centre Progress Report, 3:84-5, 1958.
33. Orban, G. Growth and movement of tooth germs and teeth. Am.Dent. A.J., 14:1004, June 1928.
34. Posen, A.L. The effect of premature loss of deciduous molars on premolar eruption. Angle Orthodont., 35:249-252, July 1965.

## BIBLIOGRAPHY (Cont'd)

35. Posen, A.L. Vertical height of the body of the mandible in the occlusal level of the teeth in individuals with cleft and uncleft palates. Burlington Orthodontic Research Centre Progress Report, 1:35-6, 1956.
36. Shumaker, D.B. and El Hadary, M.S. Roentgenographic study of eruption. Am. Dent. A.J., 61:535-41, Nov. 1960.
37. Study of facial growth and development. Burlington Orthodontic Research Centre Progress Report, 2:20-22, 1957.
38. Thomas, N.R. The process and mechanism of tooth eruption. Ph.D. Thesis, University of Bristol, Sept. 1965.
39. van Aken, J. Geometrical errors in lateral skull x-ray projections. Europ. Orthodont. Soc., Tr., 38:74-86, Jan. 1962.
40. Weinmann, J.P. Bone changes related to eruption of the teeth. Angle Orthodont., 11:83, 1941.

A P P E N D I X

## APPENDIX A

## ERROR ANALYSIS

Replication Differences of 20 Random Cases  
 Mesiodistal Tooth Diameter Measured on Dental Casts

|                    | m      | S.D. | "t"  |
|--------------------|--------|------|------|
| Right Second Molar | 0.05mm | 0.15 | 1.49 |
| First Molar        | 0.06   | 0.16 | 1.53 |
| Second Premolar    | -0.04  | 0.16 | .89  |
| First Premolar     | 0.05   | 0.18 | 1.24 |
| Canine             | 0.00   | 0.15 | 0.00 |
| Left Canine        | -0.04  | 0.17 | .92  |
| First Premolar     | 0.01   | 0.09 | .25  |
| Second Premolar    | -0.02  | 0.14 | .64  |
| First Molar        | -0.04  | 0.15 | 1.04 |
| Second Molar       | -0.01  | 0.23 | .25  |



## ERROR ANALYSIS

## Replication Differences of 20 Random Cases

| Side  | Age 3 | N  | M     | S.D. | "t"     |
|-------|-------|----|-------|------|---------|
| Right | 3OE   | 13 | 0.15  | 0.37 | 1.49    |
|       | 3ME   | 13 | -0.01 | 0.37 | -0.08   |
|       | 3L    | 12 | -0.03 | 0.39 | -0.29   |
|       | 4OE   | 11 | 0.07  | 0.20 | 1.23    |
|       | 4ME   | 11 | -0.01 | 0.33 | -0.09   |
|       | 4L    | 11 | -0.16 | 0.25 | -2.17   |
|       | 5OE   | 1  | 0.20  | 0.00 | 0.00    |
|       | 5ME   | 1  | 0.50  | 0.00 | 0.00    |
|       | 5L    | 1  | -0.30 | 0.00 | 0.00    |
|       | 6OE   | 16 | 0.10  | 0.45 | 0.88    |
|       | 6ME   | 16 | 0.05  | 0.44 | 0.45    |
|       | 6L    | 16 | -0.10 | 0.52 | -0.77   |
|       | 7OE   | 2  | -0.05 | 0.15 | -0.47   |
|       | 7ME   | 2  | -0.10 | 0.50 | -0.28   |
|       | 7L    | 2  | -0.90 | 0.30 | -4.24   |
| Left  | 3OE   | 14 | 0.09  | 0.52 | 0.62    |
|       | 3ME   | 15 | 0.13  | 0.50 | 0.98    |
|       | 3L    | 12 | -0.02 | 0.70 | -0.08   |
|       | 4OE   | 12 | 0.07  | 0.30 | 0.87    |
|       | 4ME   | 12 | 0.02  | 0.47 | 0.12    |
|       | 4L    | 11 | -0.35 | 0.44 | -2.58 * |
|       | 5OE   | 1  | 0.30  | 0.00 | 0.00    |
|       | 5ME   | 1  | 0.10  | 0.00 | 0.00    |
|       | 5L    | 1  | 0.00  | 0.00 | 0.00    |
|       | 6OE   | 15 | -0.07 | 0.34 | -0.75   |
|       | 6ME   | 16 | 0.01  | 0.43 | 0.06    |
|       | 6L    | 16 | -0.19 | 0.51 | -1.46   |
|       | 7OE   | 2  | -0.50 | 0.10 | -7.07   |
|       | 7ME   | 2  | 0.20  | 0.20 | 1.41    |
|       | 7L    | 2  | -0.10 | 0.10 | -1.41   |

## APPENDIX B Cont'd

## ERROR ANALYSIS (Continued)

| Side  | Age 4 | N  | M     | S.D. | "t"     |
|-------|-------|----|-------|------|---------|
| Right | 3OE   | 19 | 0.12  | 0.35 | 1.49    |
|       | 3ME   | 19 | -0.22 | 0.39 | -2.44 * |
|       | 3L    | 18 | -0.20 | 0.39 | -2.16 * |
|       | 4OE   | 18 | 0.03  | 0.24 | 0.49    |
|       | 4ME   | 18 | -0.04 | 0.54 | -0.31   |
|       | 4L    | 17 | -0.12 | 0.47 | -1.03   |
|       | 5OE   | 11 | -0.13 | 0.35 | -1.22   |
|       | 5ME   | 11 | -0.05 | 0.50 | -0.36   |
|       | 5L    | 9  | -0.22 | 0.42 | -1.60   |
|       | 6OE   | 19 | 0.13  | 0.39 | 1.42    |
|       | 6ME   | 19 | -0.11 | 0.46 | -1.00   |
|       | 6L    | 18 | -0.17 | 0.40 | -1.81   |
|       | 7OE   | 8  | -0.20 | 1.01 | -0.56   |
|       | 7ME   | 8  | 0.06  | 0.64 | 0.28    |
|       | 7L    | 7  | -0.54 | 1.25 | -1.15   |
| Left  | 3OE   | 18 | -0.07 | 0.47 | -0.65   |
|       | 3ME   | 19 | 0.03  | 0.40 | 0.29    |
|       | 3L    | 17 | -0.09 | 0.60 | -0.65   |
|       | 4OE   | 18 | 0.03  | 0.35 | 0.36    |
|       | 4ME   | 19 | -0.03 | 0.32 | -0.44   |
|       | 4L    | 17 | -0.16 | 0.48 | -1.36   |
|       | 5OE   | 11 | 0.15  | 0.44 | 1.09    |
|       | 5ME   | 12 | -0.05 | 0.37 | -0.47   |
|       | 5L    | 10 | -0.21 | 0.45 | -1.47   |
|       | 6OE   | 18 | 0.14  | 0.40 | 1.53    |
|       | 6ME   | 19 | -0.11 | 0.42 | -1.16   |
|       | 6L    | 19 | -0.15 | 0.48 | -1.33   |
|       | 7OE   | 8  | 0.30  | 1.24 | 0.68    |
|       | 7ME   | 8  | -0.00 | 0.64 | 0.00    |
|       | 7L    | 7  | -0.64 | 0.92 | -1.84   |

APPENDIX B Cont'd  
ERROR ANALYSIS (Continued)

| Side  | Age 5 | N   | M     | S.D.  | "t"     |         |
|-------|-------|-----|-------|-------|---------|---------|
| Right | 3OE   | 20  | 0.01  | 0.32  | 0.14    |         |
|       | 3ME   | 20  | 0.04  | 0.65  | 0.28    |         |
|       | 3L    | 18  | -0.08 | 0.46  | -0.77   |         |
|       | 4OE   | 20  | 0.03  | 0.26  | 0.43    |         |
|       | 4ME   | 20  | 0.03  | 0.37  | 0.31    |         |
|       | 4L    | 19  | -0.09 | 0.42  | -0.98   |         |
|       | 5OE   | 19  | -0.03 | 0.39  | -0.30   |         |
|       | 5ME   | 19  | 0.06  | 0.42  | 0.65    |         |
|       | 5L    | 18  | -0.15 | 0.48  | -1.33   |         |
|       | 6OE   | 20  | 0.07  | 0.39  | 0.81    |         |
|       | 6ME   | 20  | 0.19  | 0.95  | 0.92    |         |
|       | 6L    | 18  | -0.07 | 0.63  | -0.45   |         |
|       | 7OE   | 15  | 0.39  | 1.07  | 1.40    |         |
|       | 7ME   | 15  | -0.49 | 0.78  | -2.45*  |         |
|       | 7L    | 12  | -0.53 | 0.56  | -3.27** |         |
|       | Left  | 3OE | 20    | 0.26  | 0.31    | 3.65**  |
|       |       | 3ME | 20    | -0.06 | 0.30    | -0.81   |
|       |       | 3L  | 20    | -0.25 | 0.32    | -3.53** |
|       |       | 4OE | 20    | 0.17  | 0.50    | 1.46    |
|       |       | 4ME | 20    | 0.04  | 0.39    | 0.45    |
|       |       | 4L  | 20    | -0.09 | 0.29    | -1.37   |
| 5OE   |       | 18  | 0.14  | 0.44  | 1.34    |         |
| 5ME   |       | 18  | -0.08 | 0.43  | -0.82   |         |
| 5L    |       | 18  | -0.16 | 0.54  | -1.27   |         |
| 6OE   |       | 19  | 0.10  | 0.44  | 1.00    |         |
| 6ME   |       | 20  | 0.00  | 0.30  | 0.00    |         |
| 6L    |       | 18  | -0.19 | 0.54  | -1.54   |         |
| 7OE   |       | 15  | 0.23  | 1.11  | 0.81    |         |
| 7ME   |       | 15  | -0.48 | 0.86  | -2.16*  |         |
| 7L    |       | 14  | -0.59 | 1.06  | -2.10*  |         |

## APPENDIX B Cont'd

## ERROR ANALYSIS (Continued)

| Side  | Age 6 | N   | M     | S.D.  | "t"     |       |
|-------|-------|-----|-------|-------|---------|-------|
| Right | 3OE   | 19  | -0.08 | 0.28  | -1.31   |       |
|       | 3ME   | 20  | 0.26  | 0.47  | 2.52*   |       |
|       | 3L    | 20  | -0.10 | 0.54  | -0.82   |       |
|       | 4OE   | 19  | 0.07  | 0.24  | 1.35    |       |
|       | 4ME   | 20  | 0.02  | 0.34  | 0.33    |       |
|       | 4L    | 20  | -0.27 | 0.32  | -3.82** |       |
|       | 5OE   | 19  | 0.14  | 0.30  | 1.96    |       |
|       | 5ME   | 20  | 0.0.  | 0.21  | 0.21    |       |
|       | 5L    | 20  | -0.22 | 0.21  | -4.75   |       |
|       | 6OE   | 13  | 0.08  | 0.27  | 1.12    |       |
|       | 6ME   | 20  | 0.05  | 0.22  | 0.92    |       |
|       | 6L    | 19  | -0.06 | 0.72  | -0.35   |       |
|       | 7OE   | 19  | 0.38  | 1.09  | 1.51    |       |
|       | 7ME   | 20  | -0.33 | 0.98  | -1.51   |       |
|       | 7L    | 17  | -0.35 | 0.99  | -1.47   |       |
|       | Left  | 3OE | 20    | 0.08  | 0.31    | 1.22  |
|       |       | 3ME | 20    | -0.05 | 0.37    | -0.54 |
|       |       | 3L  | 20    | -0.12 | 0.34    | -1.65 |
|       |       | 4OE | 20    | 0.04  | 0.32    | 0.63  |
|       |       | 4ME | 20    | 0.02  | 0.39    | 0.23  |
|       |       | 4L  | 20    | -0.13 | 0.46    | -1.32 |
| 5OE   |       | 20  | 0.10  | 0.33  | 1.35    |       |
| 5ME   |       | 20  | 0.01  | 0.37  | 0.18    |       |
| 5L    |       | 20  | -0.19 | 0.35  | -2.49*  |       |
| 6OE   |       | 14  | 0.04  | 0.28  | 0.58    |       |
| 6ME   |       | 20  | -0.01 | 0.29  | -0.23   |       |
| 6L    |       | 19  | -0.23 | 0.79  | -1.27   |       |
| 7OE   |       | 18  | 0.28  | 0.73  | 1.62    |       |
| 7ME   |       | 18  | -0.11 | 0.54  | -0.83   |       |
| 7L    |       | 17  | -0.14 | 0.47  | -1.18   |       |

APPENDIX B Cont'd  
ERROR ANALYSIS (Continued)

| Side  | Age 7 | N  | M     | S.D. | "t"      |
|-------|-------|----|-------|------|----------|
| Right | 3OE   | 20 | 0.14  | 0.33 | 1.96     |
|       | 3ME   | 20 | 0.03  | 0.33 | 0.40     |
|       | 3L    | 15 | -0.12 | 0.42 | -1.09    |
|       | 4OE   | 20 | 0.14  | 0.26 | 2.29 *   |
|       | 4ME   | 20 | 0.07  | 0.25 | 1.27     |
|       | 4L    | 20 | -0.19 | 0.29 | -2.95 ** |
|       | 5OE   | 20 | -0.04 | 0.32 | -0.56    |
|       | 5ME   | 20 | 0.15  | 0.31 | 2.08     |
|       | 5L    | 20 | -0.14 | 0.29 | -2.22 *  |
|       | 6OE   | 6  | -0.03 | 0.24 | -0.35    |
|       | 6ME   | 20 | 0.13  | 0.25 | 2.42 *   |
|       | 6L    | 18 | -0.21 | 0.70 | -1.28    |
|       | 7OE   | 20 | -0.15 | 0.89 | -0.78    |
|       | 7ME   | 20 | 0.24  | 0.73 | 1.48     |
|       | 7L    | 19 | -0.09 | 0.38 | -1.07    |
| Left  | 3OE   | 20 | -0.05 | 0.38 | -0.52    |
|       | 3ME   | 20 | 0.04  | 0.41 | 0.39     |
|       | 3L    | 20 | 0.11  | 0.40 | 1.16     |
|       | 4OE   | 20 | -0.05 | 0.37 | -0.60    |
|       | 4ME   | 20 | 0.01  | 0.40 | 0.06     |
|       | 4L    | 20 | -0.03 | 0.44 | -0.31    |
|       | 5OE   | 20 | 0.06  | 0.24 | 1.01     |
|       | 5ME   | 20 | -0.07 | 0.35 | -0.83    |
|       | 5L    | 20 | -0.09 | 0.29 | -1.29    |
|       | 6OE   | 4  | 0.25  | 0.29 | 1.74     |
|       | 6ME   | 20 | -0.07 | 0.33 | -1.02    |
|       | 6L    | 17 | 0.11  | 0.77 | 0.60     |
|       | 7OE   | 20 | 0.05  | 0.61 | 0.37     |
|       | 7ME   | 20 | 0.41  | 2.35 | 0.77     |
|       | 7L    | 20 | -0.19 | 0.66 | -1.25    |

## APPENDIX B Cont'd

## ERROR ANALYSIS (Continued)

| Side  | Age 8 | N   | M     | S.D.  | "t"     |       |
|-------|-------|-----|-------|-------|---------|-------|
| Right | 3OE   | 19  | 0.03  | 0.33  | 0.42    |       |
|       | 3ME   | 20  | 0.06  | 0.46  | 0.58    |       |
|       | 3L    | 18  | -0.09 | 0.49  | -0.82   |       |
|       | 4OE   | 19  | 0.04  | 0.26  | 0.71    |       |
|       | 4ME   | 20  | 0.05  | 0.50  | 0.45    |       |
|       | 4L    | 19  | -0.24 | 0.42  | -2.52   |       |
|       | 5OE   | 19  | 0.02  | 0.24  | 0.28    |       |
|       | 5ME   | 20  | 0.06  | 0.35  | 0.83    |       |
|       | 5L    | 20  | -0.05 | 0.34  | -0.66   |       |
|       | 6OE   | 0   | 0.00  | 0.00  | 0.00    |       |
|       | 6ME   | 20  | 0.09  | 0.48  | 0.88    |       |
|       | 6L    | 16  | -0.13 | 0.88  | -0.57   |       |
|       | 7OE   | 19  | 0.07  | 0.35  | 0.86    |       |
|       | 7ME   | 20  | -0.08 | 0.40  | -0.84   |       |
|       | 7L    | 19  | -0.22 | 0.39  | -2.44 * |       |
|       | Left  | 3OE | 20    | -0.13 | 1.17    | -0.50 |
|       |       | 3ME | 20    | 0.04  | 0.40    | 0.45  |
|       |       | 3L  | 20    | -0.11 | 0.39    | -1.25 |
|       |       | 4OE | 20    | 0.03  | 0.23    | 0.68  |
|       |       | 4ME | 20    | 0.15  | 0.39    | 1.73  |
|       |       | 4L  | 20    | -0.03 | 0.48    | -0.23 |
| 5OE   |       | 20  | 0.15  | 0.30  | 2.21 *  |       |
| 5ME   |       | 20  | -0.07 | 0.27  | -1.23   |       |
| 5L    |       | 19  | -0.23 | 0.42  | -2.38 * |       |
| 6OE   |       | 1   | 0.10  | 0.00  | 0.00    |       |
| 6ME   |       | 20  | 0.03  | 0.26  | 0.52    |       |
| 6L    |       | 18  | -0.22 | 0.96  | -0.98   |       |
| 7OE   |       | 20  | -0.03 | 0.44  | -0.30   |       |
| 7ME   |       | 20  | 0.21  | 0.38  | 2.56 *  |       |
| 7L    |       | 16  | 0.01  | 0.41  | 0.12    |       |

APPENDIX B Cont'd  
ERROR ANALYSIS (Continued)

| Side  | Age 9 | N  | M     | S.D. | "t"      |
|-------|-------|----|-------|------|----------|
| Right | 3OE   | 17 | 0.14  | 0.40 | 1.44     |
|       | 3ME   | 20 | 0.11  | 0.49 | 1.00     |
|       | 3L    | 19 | -0.32 | 0.57 | -2.44 *  |
|       | 4OE   | 17 | 0.09  | 0.31 | 1.18     |
|       | 4ME   | 20 | 0.04  | 0.49 | 0.41     |
|       | 4L    | 19 | -0.41 | 0.49 | -3.68 ** |
|       | 5OE   | 17 | 0.05  | 0.35 | 0.56     |
|       | 5ME   | 20 | 0.10  | 0.50 | 0.93     |
|       | 5L    | 16 | -0.17 | 0.26 | -2.63 *  |
|       | 6OE   | 0  | 0.00  | 0.00 | 0.00     |
|       | 6ME   | 19 | 0.15  | 0.42 | 1.58     |
|       | 6L    | 15 | -0.10 | 0.90 | -0.43    |
|       | 7OE   | 17 | 0.24  | 0.44 | 2.18 *   |
|       | 7ME   | 20 | -0.11 | 0.31 | -1.51    |
|       | 7L    | 19 | -0.31 | 0.57 | -2.39 *  |
| Left  | 3OE   | 19 | -0.07 | 0.44 | -0.73    |
|       | 3ME   | 20 | -0.02 | 0.60 | -0.19    |
|       | 3L    | 19 | -0.11 | 0.55 | -0.84    |
|       | 4OE   | 19 | -0.10 | 0.56 | -0.77    |
|       | 4ME   | 20 | 0.15  | 1.25 | 0.54     |
|       | 4L    | 20 | -0.17 | 0.38 | -1.94    |
|       | 5OE   | 19 | 0.04  | 0.25 | 0.74     |
|       | 5ME   | 20 | 0.00  | 0.42 | 0.00     |
|       | 5L    | 20 | -0.12 | 0.48 | -1.08    |
|       | 6OE   | 0  | 0.00  | 0.00 | 0.00     |
|       | 6ME   | 20 | 0.01  | 0.38 | 0.12     |
|       | 6L    | 13 | -0.30 | 0.35 | -3.10 ** |
|       | 7OE   | 19 | 0.06  | 0.48 | 0.53     |
|       | 7ME   | 20 | 0.05  | 0.45 | 0.45     |
|       | 7L    | 18 | 0.07  | 1.30 | 0.24     |

APPENDIX B Cont'd  
ERROR ANALYSIS (Continued)

| Side  | Age 10 | N   | M     | S.D.  | "t"     |        |
|-------|--------|-----|-------|-------|---------|--------|
| Right | 3OE    | 18  | 0.22  | 0.85  | 1.08    |        |
|       | 3ME    | 20  | 0.02  | 0.52  | 0.17    |        |
|       | 3L     | 17  | -0.30 | 0.64  | -1.94   |        |
|       | 4OE    | 19  | 0.37  | 0.51  | 3.20**  |        |
|       | 4ME    | 20  | -0.06 | 0.45  | -0.55   |        |
|       | 4L     | 18  | -0.09 | 0.85  | -0.47   |        |
|       | 5OE    | 19  | 0.16  | 0.30  | 2.40*   |        |
|       | 5ME    | 20  | 0.01  | 0.39  | 0.17    |        |
|       | 5L     | 17  | -0.24 | 0.47  | -2.14*  |        |
|       | 6OE    | 0   | 0.00  | 0.00  | 0.00    |        |
|       | 6ME    | 20  | -0.13 | 0.27  | -2.18*  |        |
|       | 6L     | 14  | -0.11 | 0.94  | -0.43   |        |
|       | 7OE    | 19  | 0.12  | 0.37  | 1.35    |        |
|       | 7ME    | 20  | -0.02 | 0.29  | -0.31   |        |
|       | 7L     | 18  | -0.47 | 0.66  | -3.01** |        |
|       | Left   | 3OE | 18    | 0.32  | 0.47    | 2.93** |
|       |        | 3ME | 20    | -0.00 | 0.27    | -0.00  |
|       |        | 3L  | 19    | -0.27 | 0.42    | -2.77* |
|       |        | 4OE | 19    | 0.31  | 0.51    | 2.65*  |
|       |        | 4ME | 20    | 0.04  | 0.30    | 0.66   |
|       |        | 4L  | 18    | -0.24 | 0.73    | -1.41  |
| 5OE   |        | 20  | 0.18  | 0.49  | 1.67    |        |
| 5ME   |        | 20  | 0.08  | 0.30  | 1.27    |        |
| 5L    |        | 19  | -0.25 | 0.58  | -1.86   |        |
| 6OE   |        | 0   | 0.00  | 0.00  | 0.00    |        |
| 6ME   |        | 20  | -0.06 | 0.31  | -0.87   |        |
| 6L    |        | 16  | -0.34 | 0.62  | -2.22*  |        |
| 7OE   |        | 20  | 0.08  | 0.48  | 0.75    |        |
| 7ME   |        | 20  | -0.06 | 0.33  | -0.88   |        |
| 7L    |        | 18  | -0.28 | 0.84  | -1.40   |        |



APPENDIX B Cont'd  
ERROR ANALYSIS (Continued)

| Side  | Age ll | N  | M     | S.D. | "t"     |
|-------|--------|----|-------|------|---------|
| Right | 3OE    | 9  | 0.21  | 0.76 | 0.84    |
|       | 3ME    | 20 | -0.10 | 0.59 | -0.80   |
|       | 3L     | 18 | -0.38 | 0.52 | -3.11** |
|       | 4OE    | 16 | 0.21  | 0.68 | 1.22    |
|       | 4ME    | 20 | 0.01  | 0.43 | 0.10    |
|       | 4L     | 17 | -0.23 | 0.42 | -2.25*  |
|       | 5OE    | 19 | 0.44  | 1.43 | 1.35    |
|       | 5ME    | 20 | -0.03 | 0.35 | -0.38   |
|       | 5L     | 12 | -0.18 | 0.45 | -1.33   |
|       | 6OE    | 0  | 0.00  | 0.00 | 0.00    |
|       | 6ME    | 20 | -0.18 | 0.45 | -1.83   |
|       | 6L     | 14 | -0.39 | 0.85 | -1.70   |
|       | 7OE    | 18 | -0.30 | 1.27 | -1.00   |
|       | 7ME    | 20 | -0.16 | 0.54 | -1.28   |
|       | 7L     | 19 | -0.31 | 0.63 | -2.12*  |
| Left  | 3OE    | 9  | -0.29 | 1.22 | -0.71   |
|       | 3ME    | 18 | 0.06  | 0.36 | 0.65    |
|       | 3L     | 15 | -0.53 | 0.66 | -3.08** |
|       | 4OE    | 16 | -0.20 | 0.51 | -1.55   |
|       | 4ME    | 19 | -0.05 | 0.25 | -0.93   |
|       | 4L     | 14 | -0.09 | 0.62 | -0.51   |
|       | 5OE    | 16 | -0.01 | 0.54 | -0.05   |
|       | 5ME    | 19 | -0.05 | 0.24 | -0.87   |
|       | 5L     | 14 | -0.30 | 0.39 | -2.87*  |
|       | 6OE    | 0  | 0.00  | 0.00 | 0.00    |
|       | 6ME    | 19 | -0.11 | 0.46 | -1.06   |
|       | 6L     | 14 | -0.46 | 0.59 | -2.89*  |
|       | 7OE    | 17 | 0.07  | 1.20 | 0.24    |
|       | 7ME    | 19 | -0.08 | 0.56 | -0.62   |
|       | 7L     | 16 | -0.05 | 0.54 | -0.37   |

## APPENDIX B Cont'd

## ERROR ANALYSIS (Continued)

| Side  | Age 12 | N     | M     | S.D.   | "t"     |        |
|-------|--------|-------|-------|--------|---------|--------|
| Right | 3OE    | 3     | -0.53 | 0.58   | -1.59   |        |
|       | 3ME    | 20    | -0.25 | 0.65   | -1.74   |        |
|       | 3L     | 16    | -0.27 | 0.59   | -1.82   |        |
|       | 4OE    | 16    | -0.17 | 0.38   | -1.79   |        |
|       | 4ME    | 20    | 0.00  | 0.41   | -0.05   |        |
|       | 4L     | 17    | -0.22 | 0.50   | -1.80   |        |
|       | 5OE    | 20    | 0.04  | 0.22   | 0.83    |        |
|       | 5ME    | 20    | -0.06 | 0.46   | -0.58   |        |
|       | 5L     | 13    | -0.15 | 0.52   | -1.02   |        |
|       | 6OE    | 0     | 0.00  | 0.00   | 0.00    |        |
|       | 6ME    | 20    | -0.07 | 0.48   | -0.69   |        |
|       | 6L     | 13    | -0.68 | 0.57   | -4.32** |        |
|       | 7OE    | 18    | 0.45  | 0.83   | 2.30*   |        |
|       | 7ME    | 20    | 0.00  | 0.42   | 0.05    |        |
|       | 7L     | 16    | -0.29 | 0.38   | -3.09** |        |
|       | Left   | 3OE   | 1     | 0.40   | 0.00    | 0.00   |
|       |        | 3ME   | 20    | -0.29  | 1.30    | -1.00  |
|       |        | 3L    | 16    | -0.30  | 0.83    | -1.44  |
|       |        | 4OE   | 15    | 0.02   | 0.65    | 0.12   |
|       |        | 4ME   | 20    | -0.01  | 0.26    | -0.17  |
|       |        | 4L    | 16    | -0.36  | 0.63    | -2.26* |
| 5OE   |        | 16    | -0.11 | 0.46   | -0.93   |        |
| 5ME   |        | 20    | 0.11  | 0.26   | 1.92    |        |
| 5L    |        | 13    | 0.08  | 0.42   | 0.66    |        |
| 6OE   |        | 0     | 0.00  | 0.00   | 0.00    |        |
| 6ME   |        | 20    | -0.05 | 0.35   | -0.64   |        |
| 6L    |        | 14    | -1.28 | 2.42   | -1.97   |        |
| 7OE   |        | 19    | 0.15  | 0.66   | 0.98    |        |
| 7ME   |        | 20    | -0.22 | 0.35   | -2.73*  |        |
| 7L    | 16     | -0.42 | 0.64  | -2.66* |         |        |

APPENDIX B Cont'd  
ERROR ANALYSIS (Continued)

| Side  | Age 13 | N  | M     | S.D. | "t"      |
|-------|--------|----|-------|------|----------|
| Right | 3OE    | 0  | 0.00  | 0.00 | 0.00     |
|       | 3ME    | 20 | 0.09  | 0.56 | 0.68     |
|       | 3L     | 11 | -0.35 | 0.63 | -1.82    |
|       | 4OE    | 18 | 0.03  | 0.37 | 0.32     |
|       | 4ME    | 20 | 0.07  | 0.42 | 0.75     |
|       | 4L     | 8  | -0.13 | 0.68 | -0.52    |
|       | 5OE    | 18 | -0.10 | 0.58 | -0.73    |
|       | 5ME    | 20 | 0.25  | 0.57 | 1.99     |
|       | 5L     | 13 | -0.26 | 0.76 | -1.24    |
|       | 6OE    | 0  | 0.00  | 0.00 | 0.00     |
|       | 6ME    | 20 | -0.10 | 0.53 | -0.81    |
|       | 6L     | 11 | -0.55 | 0.87 | -2.07    |
|       | 7OE    | 18 | -0.03 | 0.67 | -0.21    |
|       | 7ME    | 20 | 0.09  | 0.62 | 0.69     |
|       | 7L     | 11 | -0.65 | 0.69 | -3.15 ** |
| Left  | 3OE    | 0  | 0.00  | 0.00 | 0.00     |
|       | 3ME    | 20 | -0.14 | 0.91 | -0.69    |
|       | 3L     | 9  | -0.69 | 1.10 | -1.87    |
|       | 4OE    | 18 | 0.26  | 0.44 | 2.46 *   |
|       | 4ME    | 20 | -0.16 | 0.41 | -1.76    |
|       | 4L     | 11 | -0.16 | 0.81 | -0.67    |
|       | 5OE    | 20 | -0.01 | 0.48 | -0.09    |
|       | 5ME    | 20 | -0.12 | 0.42 | -1.29    |
|       | 5L     | 12 | -0.25 | 0.87 | -0.99    |
|       | 6OE    | 0  | 0.00  | 0.00 | 0.00     |
|       | 6ME    | 20 | -0.22 | 0.48 | -2.01    |
|       | 6L     | 13 | -0.28 | 0.73 | -1.40    |
|       | 7OE    | 17 | 0.42  | 1.18 | 1.46     |
|       | 7ME    | 20 | -0.22 | 0.60 | -1.65    |
|       | 7L     | 11 | -0.44 | 0.66 | -2.20    |

APPENDIX B Cont'd  
ERROR ANALYSIS (Continued)

| Side  | Age 14 | N  | M     | S.D. | "t"    |
|-------|--------|----|-------|------|--------|
| Right | 3OE    | 0  | 0.00  | 0.00 | 0.00   |
|       | 3ME    | 19 | -0.26 | 0.79 | -1.46  |
|       | 3L     | 5  | -0.94 | 0.93 | -2.27  |
|       | 4OE    | 17 | -0.04 | 0.26 | -0.65  |
|       | 4ME    | 19 | -0.05 | 0.37 | -0.61  |
|       | 4L     | 6  | 0.13  | 0.29 | 1.14   |
|       | 5OE    | 15 | 0.07  | 0.22 | 1.17   |
|       | 5ME    | 19 | 0.08  | 0.49 | 0.70   |
|       | 5L     | 4  | -0.20 | 0.19 | -2.14  |
|       | 6OE    | 0  | 0.00  | 0.00 | 0.00   |
|       | 6ME    | 19 | -0.26 | 0.44 | -2.60* |
|       | 6L     | 8  | -0.08 | 0.35 | -0.61  |
|       | 7OE    | 14 | -0.11 | 0.68 | -0.63  |
|       | 7ME    | 19 | 0.03  | 0.56 | 0.25   |
|       | 7L     | 8  | -0.11 | 0.48 | -0.67  |
| Left  | 3OE    | 0  | 0.00  | 0.00 | 0.00   |
|       | 3ME    | 19 | -0.16 | 0.47 | -1.45  |
|       | 3L     | 8  | -0.64 | 0.93 | -1.93  |
|       | 4OE    | 17 | 0.04  | 0.33 | 0.44   |
|       | 4ME    | 19 | -0.02 | 0.68 | -0.10  |
|       | 4L     | 4  | 0.10  | 0.92 | 0.22   |
|       | 5OE    | 17 | 0.02  | 0.36 | 0.20   |
|       | 5ME    | 19 | -0.01 | 0.51 | -0.09  |
|       | 5L     | 8  | -0.24 | 0.58 | -1.16  |
|       | 6OE    | 0  | 0.00  | 0.00 | 0.00   |
|       | 6ME    | 19 | 0.08  | 0.48 | 0.77   |
|       | 6L     | 8  | -0.34 | 0.46 | -2.08  |
|       | 7OE    | 14 | 0.32  | 0.77 | 1.56   |
|       | 7ME    | 19 | -0.19 | 0.46 | -1.80  |
|       | 7L     | 7  | -0.20 | 0.52 | -1.02  |

\* Significant at the 5% level of confidence.

\*\* Significant at the 1% level of confidence.

## APPENDIX C

## A COMPARISON OF MESIODISTAL CROWN DIAMETERS OF ANTIMERES

---

| Tooth           | n   | "t"   |
|-----------------|-----|-------|
| Canine          | 98  | 0.273 |
| First Premolar  | 85  | 0.010 |
| Second Premolar | 94  | 0.011 |
| First Molar     | 112 | 0.010 |
| Second Molar    | 102 | 0.016 |

---

APPENDIX D

BILATERAL SYMMETRY OF CORRECTED MEASUREMENTS

|     | Age 3 |       | Age 4 |      | Age 5 |      | Age 6 |      | Age 7 |      | Age 8 |      |
|-----|-------|-------|-------|------|-------|------|-------|------|-------|------|-------|------|
|     | n     | r     | n     | r    | n     | r    | n     | r    | n     | r    | n     | r    |
| OM  | 37.   | 0.95  | 52.   | 0.93 | 54.   | 0.93 | 53.   | 0.93 | 54.   | 0.92 | 52.   | 0.88 |
| 3OE | 33.   | 0.75  | 51.   | 0.80 | 54.   | 0.73 | 52.   | 0.74 | 54.   | 0.72 | 52.   | 0.79 |
| 3ME | 33.   | 0.71  | 52.   | 0.72 | 54.   | 0.77 | 53.   | 0.76 | 54.   | 0.92 | 52.   | 0.93 |
| 3L  | 31.   | 0.71  | 48.   | 0.72 | 54.   | 0.71 | 50.   | 0.73 | 50.   | 0.83 | 49.   | 0.88 |
| 4OE | 25.   | 0.82  | 52.   | 0.77 | 54.   | 0.70 | 52.   | 0.66 | 54.   | 0.79 | 52.   | 0.83 |
| 4ME | 25.   | 0.68  | 53.   | 0.79 | 54.   | 0.84 | 53.   | 0.83 | 54.   | 0.93 | 52.   | 0.92 |
| 4L  | 23.   | 0.85  | 49.   | 0.71 | 54.   | 0.86 | 53.   | 0.81 | 53.   | 0.90 | 52.   | 0.89 |
| 5OE | 3.    | -0.46 | 29.   | 0.63 | 46.   | 0.77 | 51.   | 0.77 | 54.   | 0.76 | 52.   | 0.80 |
| 5ME | 3.    | 0.98  | 30.   | 0.76 | 46.   | 0.85 | 52.   | 0.86 | 54.   | 0.89 | 52.   | 0.92 |
| 5L  | 3.    | 0.86  | 27.   | 0.75 | 46.   | 0.84 | 52.   | 0.83 | 54.   | 0.89 | 51.   | 0.88 |
| 6OE | 36.   | 0.69  | 52.   | 0.72 | 54.   | 0.92 | 52.   | 0.89 | 54.   | 0.71 | 52.   | 0.69 |
| 6ME | 36.   | 0.90  | 53.   | 0.85 | 54.   | 0.95 | 53.   | 0.95 | 54.   | 0.89 | 52.   | 0.90 |
| 6L  | 36.   | 0.72  | 51.   | 0.81 | 48.   | 0.88 | 45.   | 0.80 | 40.   | 0.75 | 39.   | 0.71 |
| 7OE | 4.    | 0.76  | 19.   | 0.81 | 46.   | 0.78 | 50.   | 0.74 | 54.   | 0.77 | 52.   | 0.70 |
| 7ME | 4.    | 0.84  | 19.   | 0.68 | 46.   | 0.78 | 51.   | 0.75 | 54.   | 0.86 | 52.   | 0.89 |
| 7L  | 4.    | 0.44  | 15.   | 0.77 | 41.   | 0.84 | 46.   | 0.64 | 53.   | 0.79 | 51.   | 0.86 |

APPENDIX D      Cont'd  
BILATERAL SYMMETRY OF CORRECTED MEASUREMENTS

|     | Age 9 |       | Age 10 |       | Age 11 |       | Age 12 |       | Age 13 |       | Age 14 |       |
|-----|-------|-------|--------|-------|--------|-------|--------|-------|--------|-------|--------|-------|
|     | n     | r     | n      | r     | n      | r     | n      | r     | n      | r     | n      | r     |
| OM  | 53.   | 0.89  | 54.    | 0.91  | 51.    | 0.91  | 50.    | 0.90  | 49.    | 0.89  | 50.    | 0.93  |
| 3OE | 51.   | 0.92  | 54.    | 0.89  | 50.    | 0.77  | 50.    | 0.64  | 49.    | -0.00 | 50.    | -0.00 |
| 3ME | 53.   | 0.89  | 54.    | 0.92  | 51.    | 0.94  | 50.    | 0.88  | 49.    | 0.86  | 50.    | 0.89  |
| 3L  | 49.   | 0.80  | 51.    | 0.80  | 44.    | 0.84  | 38.    | 0.77  | 32.    | 0.20  | 20.    | 0.77  |
| 4OE | 51.   | 0.85  | 54.    | 0.85  | 49.    | 0.88  | 48.    | 0.90  | 48.    | 0.86  | 49.    | 0.64  |
| 4ME | 53.   | 0.89  | 54.    | 0.88  | 51.    | 0.92  | 50.    | 0.94  | 49.    | 0.82  | 50.    | 0.87  |
| 4L  | 49.   | 0.89  | 51.    | 0.90  | 44.    | 0.84  | 36.    | 0.79  | 25.    | 0.82  | 18.    | 0.79  |
| 5OE | 51.   | 0.92  | 54.    | 0.92  | 49.    | 0.90  | 49.    | 0.82  | 48.    | 0.81  | 48.    | 0.82  |
| 5ME | 53.   | 0.93  | 54.    | 0.95  | 51.    | 0.93  | 50.    | 0.90  | 49.    | 0.89  | 50.    | 0.91  |
| 5L  | 51.   | 0.89  | 49.    | 0.92  | 44.    | 0.79  | 36.    | 0.89  | 28.    | 0.92  | 17.    | 0.88  |
| 6OE | 53.   | -0.00 | 54.    | -0.00 | 51.    | -0.00 | 50.    | -0.00 | 48.    | -0.00 | 49.    | -0.00 |
| 6ME | 52.   | 0.86  | 54.    | 0.88  | 51.    | 0.88  | 50.    | 0.92  | 48.    | 0.90  | 49.    | 0.92  |
| 6L  | 35.   | 0.71  | 39.    | 0.71  | 32.    | 0.40  | 29.    | 0.49  | 24.    | 0.79  | 19.    | 0.69  |
| 7OE | 51.   | 0.84  | 54.    | 0.87  | 49.    | 0.90  | 49.    | 0.81  | 48.    | 0.48  | 46.    | 0.23  |
| 7ME | 53.   | 0.93  | 54.    | 0.94  | 51.    | 0.92  | 50.    | 0.93  | 49.    | 0.93  | 50.    | 0.88  |
| 7L  | 52.   | 0.89  | 49.    | 0.93  | 41.    | 0.90  | 32.    | 0.91  | 24.    | 0.71  | 21.    | 0.43  |

APPENDIX E

ERUPTION AND TOOTH GROWTH

| Age | 30E |       |      |        | 3ME |       |      |        | 3L  |       |      |        |
|-----|-----|-------|------|--------|-----|-------|------|--------|-----|-------|------|--------|
|     | n   | m     | S.D. | S.E.M. | n   | m     | S.D. | S.E.M. | n   | m     | S.D. | S.E.M. |
| 3   | 70  | 16.38 | 1.19 | 0.14   | 70  | 16.06 | 1.61 | 0.19   | 68  | 7.64  | 0.94 | 0.11   |
| 4   | 104 | 16.88 | 1.25 | 0.12   | 105 | 16.99 | 1.89 | 0.18   | 99  | 9.25  | 0.86 | 0.09   |
| 5   | 108 | 17.02 | 1.20 | 0.12   | 108 | 17.93 | 1.83 | 0.18   | 108 | 10.48 | 0.93 | 0.09   |
| 6   | 105 | 16.80 | 1.31 | 0.13   | 106 | 18.98 | 1.92 | 0.19   | 103 | 11.63 | 1.09 | 0.11   |
| 7   | 108 | 15.80 | 1.39 | 0.13   | 108 | 20.74 | 2.50 | 0.24   | 104 | 13.10 | 1.43 | 0.14   |
| 8   | 104 | 13.91 | 2.04 | 0.20   | 104 | 23.51 | 3.11 | 0.31   | 100 | 15.32 | 1.80 | 0.18   |
| 9   | 103 | 10.46 | 3.65 | 0.36   | 106 | 26.93 | 4.50 | 0.44   | 101 | 17.95 | 2.06 | 0.20   |
| 10  | 108 | 6.38  | 4.43 | 0.43   | 108 | 32.08 | 5.27 | 0.51   | 104 | 20.34 | 2.01 | 0.20   |
| 11  | 103 | 2.65  | 3.64 | 0.36   | 104 | 35.81 | 5.07 | 0.50   | 95  | 22.35 | 2.00 | 0.21   |
| 12  | 102 | 0.70  | 2.01 | 0.20   | 102 | 38.10 | 3.92 | 0.39   | 88  | 23.67 | 1.65 | 0.18   |
| 13  | 100 | 0.00  | 0.00 | 0.00   | 100 | 40.01 | 3.15 | 0.32   | 77  | 24.36 | 3.22 | 0.37   |
| 14  | 100 | 0.00  | 0.00 | 0.00   | 100 | 40.57 | 3.07 | 0.31   | 57  | 24.61 | 2.29 | 0.30   |



APPENDIX E Cont'd  
ERUPTION AND TOOTH GROWTH

| Age | 4OE |       |      | 4ME    |     |       | 4L   |        |     |       |      |        |
|-----|-----|-------|------|--------|-----|-------|------|--------|-----|-------|------|--------|
|     | n   | m     | S.D. | S.E.M. | n   | m     | S.D. | S.E.M. | n   | m     | S.D. | S.E.M. |
| 3   | 53  | 11.75 | 1.05 | 0.14   | 53  | 18.93 | 1.60 | 0.22   | 51  | 4.60  | 0.95 | 0.13   |
| 4   | 105 | 12.29 | 1.03 | 0.10   | 106 | 19.62 | 1.75 | 0.17   | 102 | 6.13  | 0.96 | 0.10   |
| 5   | 108 | 12.56 | 0.97 | 0.09   | 108 | 20.20 | 1.80 | 0.17   | 108 | 7.37  | 0.93 | 0.09   |
| 6   | 105 | 12.51 | 1.15 | 0.11   | 106 | 21.03 | 1.89 | 0.18   | 106 | 8.54  | 0.95 | 0.09   |
| 7   | 108 | 12.05 | 1.19 | 0.11   | 108 | 22.45 | 2.24 | 0.22   | 107 | 9.77  | 1.19 | 0.12   |
| 8   | 104 | 10.77 | 1.79 | 0.18   | 104 | 24.62 | 2.79 | 0.27   | 104 | 11.40 | 1.49 | 0.15   |
| 9   | 103 | 8.97  | 2.20 | 0.22   | 106 | 26.37 | 3.06 | 0.30   | 102 | 13.38 | 2.00 | 0.20   |
| 10  | 108 | 6.41  | 3.47 | 0.33   | 108 | 29.89 | 3.95 | 0.38   | 105 | 15.63 | 2.24 | 0.22   |
| 11  | 102 | 3.45  | 3.40 | 0.34   | 104 | 32.72 | 4.35 | 0.43   | 97  | 17.78 | 2.49 | 0.25   |
| 12  | 100 | 2.08  | 2.43 | 0.24   | 102 | 34.29 | 3.80 | 0.38   | 85  | 19.41 | 2.06 | 0.22   |
| 13  | 99  | 1.47  | 1.14 | 0.11   | 100 | 35.89 | 3.01 | 0.30   | 63  | 20.51 | 1.58 | 0.20   |
| 14  | 99  | 1.23  | 0.74 | 0.07   | 100 | 36.73 | 2.75 | 0.27   | 50  | 20.94 | 1.77 | 0.25   |

APPENDIX E Cont'd  
ERUPTION AND TOOTH GROWTH

| Age | 50E |       |      | 5ME |       |      | 5L  |       |      |
|-----|-----|-------|------|-----|-------|------|-----|-------|------|
|     | n   | m     | S.D. | n   | m     | S.D. | n   | m     | S.D. |
| 3   | 7   | 11.03 | 0.50 | 7   | 15.84 | 1.12 | 7   | 3.53  | 0.81 |
| 4   | 65  | 11.21 | 0.98 | 66  | 16.47 | 1.33 | 62  | 4.29  | 1.01 |
| 5   | 95  | 11.63 | 1.04 | 95  | 16.74 | 1.43 | 94  | 5.47  | 1.14 |
| 6   | 104 | 12.25 | 1.15 | 105 | 16.97 | 1.48 | 105 | 6.72  | 1.13 |
| 7   | 108 | 12.81 | 1.08 | 108 | 17.74 | 1.83 | 108 | 8.00  | 1.16 |
| 8   | 104 | 12.36 | 1.28 | 104 | 19.13 | 2.18 | 103 | 9.31  | 1.40 |
| 9   | 103 | 10.99 | 1.96 | 106 | 20.89 | 2.84 | 104 | 11.11 | 1.95 |
| 10  | 108 | 9.21  | 3.23 | 108 | 23.46 | 3.91 | 101 | 13.31 | 2.40 |
| 11  | 102 | 6.26  | 4.14 | 104 | 26.80 | 4.92 | 96  | 15.61 | 2.82 |
| 12  | 101 | 3.43  | 3.60 | 102 | 29.94 | 4.52 | 85  | 17.71 | 2.69 |
| 13  | 99  | 2.05  | 2.40 | 100 | 32.44 | 3.69 | 70  | 19.73 | 2.22 |
| 14  | 98  | 1.34  | 1.22 | 100 | 34.07 | 3.02 | 49  | 20.45 | 1.63 |

APPENDIX E Cont'd  
ERUPTION AND TOOTH GROWTH

| Age | 6OE |      |      | 6ME    |     |       | 6L   |        |     |       |      |        |
|-----|-----|------|------|--------|-----|-------|------|--------|-----|-------|------|--------|
|     | n   | m    | S.D. | S.E.M. | n   | m     | S.D. | S.E.M. | n   | m     | S.D. | S.E.M. |
| 3   | 73  | 7.37 | 0.95 | 0.11   | 73  | 16.41 | 1.28 | 0.15   | 73  | 8.57  | 0.75 | 0.09   |
| 4   | 105 | 6.47 | 1.03 | 0.10   | 106 | 18.38 | 1.66 | 0.16   | 104 | 10.33 | 1.01 | 0.10   |
| 5   | 108 | 4.85 | 1.97 | 0.19   | 108 | 20.94 | 2.69 | 0.26   | 99  | 12.57 | 1.63 | 0.16   |
| 6   | 105 | 2.20 | 2.10 | 0.21   | 106 | 24.78 | 3.21 | 0.31   | 97  | 15.12 | 1.62 | 0.16   |
| 7   | 108 | 0.53 | 0.98 | 0.09   | 108 | 27.96 | 2.41 | 0.23   | 90  | 17.92 | 1.55 | 0.16   |
| 8   | 104 | 0.11 | 0.34 | 0.03   | 104 | 29.46 | 1.81 | 0.18   | 84  | 19.73 | 1.37 | 0.15   |
| 9   | 106 | 0.06 | 0.27 | 0.03   | 105 | 30.21 | 1.82 | 0.18   | 83  | 21.13 | 1.29 | 0.14   |
| 10  | 108 | 0.01 | 0.11 | 0.01   | 108 | 30.94 | 1.91 | 0.18   | 90  | 21.75 | 1.36 | 0.14   |
| 11  | 104 | 0.04 | 0.24 | 0.02   | 104 | 31.64 | 1.98 | 0.19   | 78  | 22.01 | 2.85 | 0.32   |
| 12  | 102 | 0.00 | 0.00 | 0.00   | 102 | 32.19 | 2.12 | 0.21   | 73  | 22.18 | 1.46 | 0.17   |
| 13  | 99  | 0.00 | 0.00 | 0.00   | 99  | 33.43 | 2.34 | 0.24   | 68  | 22.79 | 1.44 | 0.17   |
| 14  | 99  | 0.00 | 0.00 | 0.00   | 99  | 34.70 | 2.63 | 0.26   | 53  | 22.45 | 1.60 | 0.22   |

APPENDIX E Cont'd

ERUPTION AND TOOTH GROWTH

| Age | 7OE |       |      | 7ME |       |      | 7L  |       |      |
|-----|-----|-------|------|-----|-------|------|-----|-------|------|
|     | n   | m     | S.D. | n   | m     | S.D. | n   | m     | S.D. |
| 3   | 8   | 4.68  | 1.02 | 8   | 17.56 | 0.66 | 8   | 2.69  | 0.77 |
| 4   | 51  | 4.69  | 1.70 | 51  | 17.99 | 1.52 | 46  | 4.05  | 1.20 |
| 5   | 95  | 4.89  | 1.55 | 95  | 17.94 | 1.52 | 90  | 5.50  | 1.41 |
| 6   | 102 | 5.49  | 1.78 | 103 | 18.48 | 1.51 | 98  | 7.24  | 1.02 |
| 7   | 108 | 6.51  | 1.80 | 108 | 19.39 | 1.53 | 107 | 8.50  | 1.04 |
| 8   | 104 | 6.62  | 1.23 | 104 | 20.48 | 1.61 | 103 | 9.80  | 1.27 |
| 9   | 103 | 6.12  | 1.54 | 106 | 21.70 | 2.15 | 105 | 11.43 | 1.71 |
| 10  | 108 | 4.84  | 2.21 | 108 | 23.54 | 2.95 | 103 | 13.38 | 1.98 |
| 11  | 102 | 2.68  | 2.51 | 104 | 26.27 | 3.31 | 91  | 15.54 | 2.12 |
| 12  | 101 | 0.56  | 2.27 | 102 | 28.92 | 3.23 | 78  | 17.54 | 1.84 |
| 13  | 99  | -0.44 | 1.40 | 100 | 30.93 | 2.74 | 62  | 19.44 | 1.52 |
| 14  | 96  | -0.78 | 1.02 | 100 | 32.49 | 2.45 | 53  | 20.35 | 1.78 |

APPENDIX F  
 CHRONOLOGICAL ERUPTION AND GROWTH INCREMENTS  
 MANDIBULAR CANINE

| Age   | 30E |        |       |        | 3ME |        |      |        | 3L  |        |      |        |
|-------|-----|--------|-------|--------|-----|--------|------|--------|-----|--------|------|--------|
|       | n   | m      | S.D.  | S.E.M. | n   | m      | S.D. | S.E.M. | n   | m      | S.D. | S.E.M. |
| 3-4   | 68  | 0.67mm | 0.70  | 0.09   | 69  | 1.16mm | 1.30 | 0.16   | 63  | 1.53mm | 0.75 | 0.10   |
| 4-5   | 103 | 0.18   | 0.61  | 0.06   | 104 | 0.95   | 1.22 | 0.12   | 98  | 1.29   | 0.71 | 0.07   |
| 5-6   | 105 | -0.26  | 0.77  | 0.08   | 106 | 1.01   | 1.27 | 0.12   | 103 | 1.10   | 0.78 | 0.08   |
| 6-7   | 105 | -1.00  | 1.02  | 0.10   | 106 | 1.82   | 1.50 | 0.15   | 100 | 1.50   | 0.86 | 0.09   |
| 7-8   | 104 | -1.93  | 1.15  | 0.11   | 105 | 2.76   | 1.28 | 0.13   | 97  | 2.28   | 0.96 | 0.10   |
| 8-9   | 100 | -3.25  | 2.32  | 0.23   | 104 | 3.43   | 2.30 | 0.23   | 96  | 2.55   | 1.09 | 0.11   |
| 9-10  | 103 | -4.15  | 2.50  | 0.25   | 106 | 5.09   | 2.26 | 0.22   | 98  | 2.42   | 1.04 | 0.11   |
| 10-11 | 103 | -3.66  | 2.63  | 0.26   | 104 | 3.70   | 2.50 | 0.25   | 94  | 1.98   | 1.19 | 0.12   |
| 11-12 | 99  | -1.98  | 2.70  | 0.27   | 100 | 2.41   | 2.63 | 0.26   | 82  | 1.32   | 1.20 | 0.13   |
| 12-13 | 99  | -0.50  | 1.66  | 0.17   | 99  | 1.73   | 1.87 | 0.19   | 68  | 0.76   | 1.44 | 0.17   |
| 13-14 | 99  | -0.00  | -0.00 | -0.00  | 99  | 0.55   | 1.47 | 0.15   | 51  | -0.12  | 1.28 | 0.18   |

APPENDIX F Cont'd  
 CHRONOLOGICAL ERUPTION AND GROWTH INCREMENTS  
 MANDIBULAR FIRST PREMOLAR

| Age   | 4OE |        |      |        | 4ME |        |      |        | 4L  |        |      |        |
|-------|-----|--------|------|--------|-----|--------|------|--------|-----|--------|------|--------|
|       | n   | m      | S.D. | S.E.M. | n   | m      | S.D. | S.E.M. | n   | m      | S.D. | S.E.M. |
| 3-4   | 52  | 0.70mm | 0.61 | 0.08   | 53  | 0.75mm | 0.99 | 0.14   | 49  | 1.76mm | 0.75 | 0.11   |
| 4-5   | 104 | 0.26   | 0.62 | 0.06   | 105 | 0.60   | 1.08 | 0.11   | 101 | 1.20   | 0.71 | 0.07   |
| 5-6   | 105 | -0.05  | 0.71 | 0.07   | 106 | 0.79   | 1.02 | 0.10   | 106 | 1.16   | 0.58 | 0.06   |
| 6-7   | 105 | -0.48  | 0.99 | 0.10   | 106 | 1.49   | 1.17 | 0.11   | 105 | 1.24   | 0.63 | 0.06   |
| 7-8   | 104 | -1.36  | 1.31 | 0.13   | 105 | 2.20   | 1.43 | 0.14   | 104 | 1.63   | 0.69 | 0.07   |
| 8-9   | 100 | -1.65  | 1.24 | 0.12   | 104 | 1.77   | 1.41 | 0.14   | 100 | 2.00   | 1.08 | 0.11   |
| 9-10  | 103 | -2.56  | 2.29 | 0.23   | 106 | 3.42   | 2.20 | 0.21   | 101 | 2.24   | 1.06 | 0.11   |
| 10-11 | 102 | -2.88  | 2.49 | 0.25   | 104 | 2.88   | 2.74 | 0.27   | 95  | 2.30   | 1.24 | 0.13   |
| 11-12 | 97  | -1.40  | 2.11 | 0.21   | 100 | 1.66   | 2.23 | 0.22   | 80  | 1.73   | 1.31 | 0.15   |
| 12-13 | 96  | -0.47  | 1.68 | 0.17   | 99  | 1.49   | 2.09 | 0.21   | 60  | 1.37   | 1.46 | 0.19   |
| 13-14 | 98  | -0.23  | 0.91 | 0.09   | 99  | 0.82   | 1.61 | 0.16   | 39  | 0.43   | 1.28 | 0.21   |

APPENDIX F Cont'd  
 CHRONOLOGICAL ERUPTION AND GROWTH INCREMENTS  
 MANDIBULAR SECOND PREMOLAR

| Age   | 5OE |        |      | 5ME    |     |        | 5L   |        |     |        |      |        |
|-------|-----|--------|------|--------|-----|--------|------|--------|-----|--------|------|--------|
|       | n   | m      | S.D. | S.E.M. | n   | m      | S.D. | S.E.M. | n   | m      | S.D. | S.E.M. |
| 3-4   | 6   | 0.63mm | 0.50 | 0.21   | 6   | 0.18mm | 0.37 | 0.15   | 6   | 1.83mm | 0.62 | 0.26   |
| 4-5   | 65  | 0.76   | 0.73 | 0.09   | 66  | 0.14   | 0.70 | 0.09   | 62  | 1.69   | 0.63 | 0.08   |
| 5-6   | 93  | 0.75   | 0.87 | 0.09   | 93  | 0.26   | 0.72 | 0.08   | 93  | 1.48   | 0.56 | 0.06   |
| 6-7   | 104 | 0.60   | 1.19 | 0.12   | 105 | 0.82   | 0.88 | 0.09   | 104 | 1.36   | 0.51 | 0.05   |
| 7-8   | 104 | -0.48  | 1.08 | 0.11   | 105 | 1.40   | 0.86 | 0.08   | 104 | 1.35   | 0.58 | 0.06   |
| 8-9   | 100 | -1.28  | 1.09 | 0.11   | 104 | 1.76   | 1.29 | 0.13   | 102 | 1.76   | 0.88 | 0.09   |
| 9-10  | 103 | -1.79  | 1.95 | 0.19   | 106 | 2.53   | 1.79 | 0.17   | 97  | 2.27   | 0.87 | 0.09   |
| 10-11 | 102 | -2.85  | 2.47 | 0.25   | 104 | 3.28   | 2.44 | 0.24   | 90  | 2.56   | 1.31 | 0.14   |
| 11-12 | 98  | -2.92  | 2.86 | 0.29   | 100 | 3.31   | 2.72 | 0.27   | 79  | 2.36   | 1.20 | 0.14   |
| 12-13 | 97  | -1.29  | 2.41 | 0.24   | 99  | 2.41   | 2.44 | 0.25   | 62  | 2.15   | 1.20 | 0.15   |
| 13-14 | 97  | -0.70  | 1.75 | 0.18   | 99  | 1.61   | 1.91 | 0.19   | 42  | 0.79   | 1.09 | 0.17   |

APPENDIX F Cont'd  
 CHRONOLOGICAL ERUPTION AND GROWTH INCREMENTS  
 MANDIBULAR FIRST MOLAR

| Age   | 60E |         |       |        | 6ME |        |      |        | 6L |        |      |        |
|-------|-----|---------|-------|--------|-----|--------|------|--------|----|--------|------|--------|
|       | n   | m       | S.D.  | S.E.M. | n   | m      | S.D. | S.E.M. | n  | m      | S.D. | S.E.M. |
| 3-4   | 72  | -0.89mm | 0.97  | 0.12   | 73  | 2.10mm | 0.90 | 0.11   | 71 | 1.83mm | 0.78 | 0.09   |
| 4-5   | 104 | -1.73   | 1.57  | 0.15   | 105 | 2.64   | 1.54 | 0.15   | 94 | 2.33   | 1.32 | 0.14   |
| 5-6   | 105 | -2.67   | 1.71  | 0.17   | 106 | 3.84   | 1.63 | 0.16   | 91 | 2.45   | 0.99 | 0.10   |
| 6-7   | 105 | -1.68   | 1.64  | 0.16   | 106 | 3.21   | 1.58 | 0.15   | 83 | 2.88   | 1.01 | 0.11   |
| 7-8   | 104 | -0.41   | 0.89  | 0.09   | 105 | 1.49   | 1.25 | 0.12   | 76 | 1.93   | 1.25 | 0.14   |
| 8-9   | 103 | -0.04   | 0.21  | 0.02   | 103 | 0.75   | 0.58 | 0.06   | 74 | 1.28   | 1.06 | 0.12   |
| 9-10  | 106 | -0.04   | 0.22  | 0.02   | 105 | 0.74   | 0.67 | 0.07   | 74 | 0.85   | 1.21 | 0.14   |
| 10-11 | 104 | 0.02    | 0.14  | 0.01   | 104 | 0.64   | 0.57 | 0.06   | 72 | 0.18   | 2.81 | 0.33   |
| 11-12 | 100 | -0.02   | 0.20  | 0.02   | 100 | 0.72   | 0.78 | 0.08   | 58 | -0.03  | 1.20 | 0.16   |
| 12-13 | 98  | -0.00   | -0.00 | -0.00  | 98  | 1.23   | 0.76 | 0.08   | 57 | 0.57   | 1.15 | 0.15   |
| 13-14 | 98  | -0.00   | -0.00 | -0.00  | 98  | 1.27   | 0.83 | 0.08   | 48 | -0.12  | 0.88 | 0.13   |



APPENDIX F Cont'd

CHRONOLOGICAL ERUPTION AND GROWTH INCREMENTS

MANDIBULAR SECOND MOLAR

| Age   | 7OE |        |      | 7ME    |     |        | 7L   |        |     |        |      |        |
|-------|-----|--------|------|--------|-----|--------|------|--------|-----|--------|------|--------|
|       | n   | m      | S.D. | S.E.M. | n   | m      | S.D. | S.E.M. | n   | m      | S.D. | S.E.M. |
| 3-4   | 7   | 0.73mm | 0.49 | 0.18   | 7   | 0.07mm | 0.66 | 0.25   | 7   | 2.55mm | 0.48 | 0.18   |
| 4-5   | 48  | 0.24   | 1.34 | 0.19   | 48  | 0.35   | 1.20 | 0.17   | 41  | 2.09   | 0.99 | 0.15   |
| 5-6   | 92  | 0.65   | 1.43 | 0.15   | 93  | 0.57   | 0.80 | 0.08   | 85  | 1.78   | 0.97 | 0.11   |
| 6-7   | 102 | 1.10   | 1.59 | 0.16   | 103 | 0.96   | 0.76 | 0.08   | 97  | 1.29   | 0.66 | 0.07   |
| 7-8   | 104 | 0.12   | 1.50 | 0.15   | 105 | 1.11   | 0.64 | 0.06   | 103 | 1.31   | 0.73 | 0.07   |
| 8-9   | 100 | -0.47  | 1.03 | 0.10   | 104 | 1.22   | 1.01 | 0.10   | 102 | 1.64   | 0.82 | 0.08   |
| 9-10  | 103 | -1.34  | 1.45 | 0.14   | 106 | 1.85   | 1.31 | 0.13   | 100 | 2.03   | 0.87 | 0.09   |
| 10-11 | 102 | -2.10  | 1.58 | 0.16   | 104 | 2.63   | 1.46 | 0.14   | 87  | 2.32   | 0.97 | 0.10   |
| 11-12 | 98  | -2.13  | 1.67 | 0.17   | 100 | 2.78   | 1.64 | 0.16   | 71  | 2.02   | 1.15 | 0.14   |
| 12-13 | 97  | -0.89  | 1.64 | 0.17   | 99  | 1.96   | 1.45 | 0.15   | 56  | 1.81   | 1.28 | 0.17   |
| 13-14 | 95  | -0.36  | 1.17 | 0.12   | 99  | 1.55   | 1.24 | 0.13   | 46  | 0.90   | 1.46 | 0.22   |

APPENDIX G

STANDARDIZED ERUPTION AND GROWTH INCREMENTS  
MANDIBULAR CANINE

| Yrs.      | 3OE |        |      |        | 3ME |        |      |        | 3L |        |      |        |
|-----------|-----|--------|------|--------|-----|--------|------|--------|----|--------|------|--------|
|           | n   | m      | S.D. | S.E.M. | n   | m      | S.D. | S.E.M. | n  | m      | S.D. | S.E.M. |
| -6        | 71  | 0.15mm | 0.73 | 0.09   | 73  | 1.11mm | 1.33 | 0.16   | 68 | 1.24mm | 0.82 | 0.10   |
| -5        | 100 | 0.04   | 0.71 | 0.07   | 100 | 1.07   | 1.18 | 0.12   | 96 | 1.32   | 0.78 | 0.08   |
| -4        | 103 | -0.59  | 0.93 | 0.09   | 104 | 1.59   | 1.36 | 0.13   | 99 | 1.44   | 0.79 | 0.08   |
| -3        | 104 | -1.36  | 0.93 | 0.09   | 105 | 2.00   | 1.45 | 0.14   | 97 | 1.80   | 0.98 | 0.10   |
| -2        | 100 | -2.13  | 1.08 | 0.11   | 103 | 2.95   | 1.28 | 0.13   | 97 | 2.44   | 0.93 | 0.09   |
| -1        | 100 | -3.58  | 1.80 | 0.18   | 104 | 3.54   | 1.59 | 0.16   | 95 | 2.37   | 1.17 | 0.12   |
| Max. Vel. | 106 | -5.90  | 2.42 | 0.24   | 107 | 6.85   | 1.62 | 0.16   | 92 | 2.31   | 1.18 | 0.12   |
| 1         | 100 | -2.53  | 2.45 | 0.25   | 100 | 2.73   | 2.03 | 0.20   | 79 | 1.92   | 1.15 | 0.13   |
| 2         | 92  | -0.19  | 0.75 | 0.08   | 92  | 1.04   | 1.72 | 0.18   | 73 | 1.13   | 1.11 | 0.13   |
| 3         | 78  | 0.01   | 0.07 | 0.01   | 78  | 0.69   | 1.38 | 0.16   | 54 | 0.25   | 1.42 | 0.19   |
| 4         | 53  | -0.02  | 0.16 | 0.02   | 53  | 0.66   | 1.41 | 0.19   | 32 | -0.26  | 1.08 | 0.19   |

Eruption and growth increments standardized on year of maximum eruption velocity.

APPENDIX G Cont'd.

STANDARDIZED ERUPTION AND GROWTH INCREMENTS  
MANDIBULAR FIRST PREMOLAR

| Yrs.      | 4OE |        |             | 4ME |        |             | 4L  |        |             |
|-----------|-----|--------|-------------|-----|--------|-------------|-----|--------|-------------|
|           | n   | m      | S.D. S.E.M. | n   | m      | S.D. S.E.M. | n   | m      | S.D. S.E.M. |
| -6        | 67  | 0.21mm | 0.73 0.09   | 69  | 0.79mm | 0.97 0.12   | 67  | 1.30mm | 0.67 0.08   |
| -5        | 97  | 0.08   | 0.68 0.07   | 97  | 0.80   | 1.19 0.12   | 96  | 1.17   | 0.72 0.07   |
| -4        | 99  | -0.28  | 0.79 0.08   | 100 | 1.48   | 1.07 0.11   | 99  | 1.32   | 0.62 0.06   |
| -3        | 104 | -0.91  | 0.99 0.10   | 105 | 1.51   | 0.97 0.10   | 104 | 1.38   | 0.69 0.07   |
| -2        | 99  | -1.28  | 0.81 0.08   | 103 | 1.78   | 1.21 0.12   | 100 | 1.73   | 0.67 0.07   |
| -1        | 98  | -1.90  | 1.07 0.11   | 104 | 1.97   | 1.24 0.12   | 101 | 1.94   | 0.97 0.10   |
| Max. Vel. | 104 | -5.10  | 2.02 0.20   | 107 | 5.96   | 1.56 0.15   | 102 | 2.98   | 1.20 0.12   |
| 1         | 98  | -1.20  | 1.48 0.15   | 99  | 1.20   | 1.54 0.16   | 80  | 2.22   | 1.04 0.12   |
| 2         | 83  | -0.20  | 1.14 0.13   | 84  | 1.01   | 1.85 0.20   | 54  | 1.07   | 1.09 0.15   |
| 3         | 70  | -0.01  | 1.03 0.12   | 70  | 0.72   | 1.31 0.15   | 31  | 0.38   | 1.40 0.25   |
| 4         | 40  | -0.17  | 0.54 0.09   | 40  | 0.52   | 1.22 0.19   | 16  | 0.02   | 1.30 0.33   |

Eruption and growth increments standardized on year of maximum eruption velocity.

APPENDIX G Cont'd.

STANDARDIZED ERUPTION AND GROWTH INCREMENTS  
MANDIBULAR SECOND PREMOLAR

| Yrs.      | 5OE |        |      |        | 5ME |        |      |        | 5L  |        |      |        |
|-----------|-----|--------|------|--------|-----|--------|------|--------|-----|--------|------|--------|
|           | n   | m      | S.D. | S.E.M. | n   | m      | S.D. | S.E.M. | n   | m      | S.D. | S.E.M. |
| -8        | 14  | 0.93mm | 0.73 | 0.20   | 14  | 0.10mm | 0.52 | 0.14   | 14  | 1.69mm | 0.56 | 0.15   |
| -7        | 35  | 0.75   | 0.68 | 0.12   | 36  | -0.04  | 0.67 | 0.11   | 36  | 1.66   | 0.48 | 0.08   |
| -6        | 80  | 0.95   | 0.99 | 0.11   | 81  | 0.32   | 0.73 | 0.08   | 77  | 1.51   | 0.67 | 0.08   |
| -5        | 98  | 0.52   | 0.93 | 0.09   | 99  | 0.60   | 0.68 | 0.07   | 97  | 1.31   | 0.53 | 0.05   |
| -4        | 100 | -0.10  | 1.02 | 0.10   | 101 | 1.14   | 0.83 | 0.08   | 100 | 1.36   | 0.48 | 0.05   |
| -3        | 102 | -0.87  | 0.84 | 0.08   | 104 | 1.43   | 0.81 | 0.08   | 103 | 1.42   | 0.68 | 0.07   |
| -2        | 102 | -1.11  | 0.93 | 0.09   | 107 | 1.82   | 0.87 | 0.08   | 102 | 2.10   | 0.77 | 0.08   |
| -1        | 95  | -2.02  | 1.31 | 0.13   | 100 | 2.59   | 1.34 | 0.13   | 93  | 2.43   | 0.77 | 0.08   |
| Max. Vel. | 91  | -6.25  | 1.48 | 0.16   | 92  | 6.82   | 1.33 | 0.14   | 72  | 2.84   | 1.28 | 0.15   |
| 1         | 76  | -1.15  | 1.78 | 0.20   | 76  | 2.01   | 2.07 | 0.24   | 52  | 2.45   | 1.63 | 0.23   |
| 2         | 48  | 0.03   | 0.58 | 0.08   | 49  | 0.72   | 1.21 | 0.17   | 27  | 0.94   | 0.99 | 0.19   |

Eruption and growth increments standardized on year of maximum eruption velocity.

APPENDIX G Cont'd.

STANDARDIZED ERUPTION AND GROWTH INCREMENTS

MANDIBULAR FIRST MOLAR

| Yrs.      | 60E |         |       |        | 6L  |        |      |        |         |        |      |      |
|-----------|-----|---------|-------|--------|-----|--------|------|--------|---------|--------|------|------|
|           | n   | m       | S.D.  | S.E.M. | n   | m      | S.D. | S.E.M. |         |        |      |      |
| -2        | 70  | -1.08mm | 0.86  | 0.10   | 72  | 2.10mm | 0.77 | 0.09   | 70      | 1.89mm | 0.84 | 0.10 |
| -1        | 98  | -1.79   | 1.29  | 0.13   | 100 | 2.73   | 0.97 | 0.10   | 93      | 2.49   | 1.11 | 0.12 |
| Max. Vel. | 104 | -3.62   | 1.35  | 0.13   | 104 | 5.07   | 1.04 | 0.10   | 84      | 2.90   | 1.10 | 0.12 |
| 1         | 105 | -0.59   | 0.98  | 0.10   | 104 | 2.09   | 1.30 | 0.13   | 80      | 2.31   | 1.42 | 0.16 |
| 2         | 102 | -0.09   | 0.38  | 0.04   | 102 | 0.91   | 0.69 | 0.07   | 73      | 1.76   | 0.98 | 0.11 |
| 3         | 103 | -0.02   | 0.20  | 0.02   | 104 | 0.70   | 0.59 | 0.06   | 71      | 1.11   | 1.11 | 0.13 |
| 4         | 107 | -0.03   | 0.19  | 0.02   | 107 | 0.76   | 1.07 | 0.10   | 72      | 0.23   | 2.78 | 0.33 |
| 5         | 100 | 0.00    | 0.14  | 0.01   | 100 | 0.80   | 0.78 | 0.08   | 65      | 0.23   | 1.27 | 0.16 |
| 6         | 91  | -0.02   | 0.21  | 0.02   | 91  | 1.03   | 0.78 | 0.08   | 54      | 0.41   | 1.14 | 0.16 |
| 7         | 74  | -0.00   | -0.00 | -0.00  | 74  | 1.17   | 0.81 | 0.09   | 35-0.08 |        | 0.89 | 0.15 |
| 8         | 36  | -0.00   | -0.00 | -0.00  | 36  | 1.20   | 0.78 | 0.13   | 19      | 0.19   | 0.90 | 0.21 |

Eruption and growth increments standardized on year of maximum eruption velocity.

APPENDIX G Cont'd.

STANDARDIZED ERUPTION AND GROWTH INCREMENTS

MANDIBULAR SECOND MOLAR

| Yrs       | 7OE |       |      |        | 7 ME |       |      |        | 7L  |      |      |        |
|-----------|-----|-------|------|--------|------|-------|------|--------|-----|------|------|--------|
|           | n   | m     | S.D. | S.E.M. | n    | m     | S.D. | S.E.M. | n   | m    | S.D. | S.E.M. |
| -8        | 9   | -0.12 | 0.75 | 0.25   | 10   | 0.36  | 0.61 | 0.19   | 10  | 2.17 | 1.04 | 0.33   |
| -7        | 32  | 1.06  | 0.93 | 0.16   | 33   | -0.11 | 0.82 | 0.14   | 30  | 1.75 | 0.90 | 0.17   |
| -6        | 72  | 0.62  | 1.76 | 0.21   | 72   | 0.60  | 0.97 | 0.12   | 66  | 1.81 | 0.99 | 0.12   |
| -5        | 92  | 0.91  | 1.53 | 0.16   | 93   | 0.85  | 0.79 | 0.08   | 88  | 1.40 | 0.77 | 0.08   |
| -4        | 101 | 0.46  | 1.39 | 0.14   | 102  | 0.85  | 0.75 | 0.07   | 98  | 1.22 | 0.68 | 0.07   |
| -3        | 101 | -0.30 | 1.10 | 0.11   | 103  | 1.15  | 1.27 | 1.13   | 96  | 1.44 | 0.87 | 0.09   |
| -2        | 102 | -0.51 | 1.17 | 0.12   | 107  | 1.19  | 1.05 | 0.10   | 102 | 1.91 | 0.93 | 0.09   |
| -1        | 95  | -1.95 | 1.37 | 0.14   | 100  | 2.44  | 1.06 | 0.11   | 90  | 2.27 | 0.97 | 0.10   |
| Max. Vel. | 91  | -3.38 | 1.20 | 0.13   | 92   | 4.31  | 0.89 | 0.09   | 67  | 2.54 | 0.89 | 0.11   |
| 1         | 75  | -1.12 | 1.39 | 0.16   | 75   | 1.99  | 1.23 | 0.14   | 48  | 2.09 | 1.21 | 0.18   |
| 2         | 45  | -0.36 | 1.03 | 0.15   | 45   | 1.07  | 0.93 | 0.14   | 25  | 0.77 | 1.79 | 0.36   |

Eruption and growth increments standardized on year of maximum eruption velocity.