

**The Design, Construction, and Testing of an Open-Ended Roof Channel
to Reduce Attic Temperature**

by

Myra Joyce Berrub

A Thesis
Submitted to the Faculty of Graduate Studies
in Partial Fulfilment of the Requirements
for the Degree of

MASTER OF SCIENCE

Department of Biosystems Engineering
University of Manitoba
Winnipeg, Manitoba, Canada

(c) August 1998



National Library
of Canada

Acquisitions and
Bibliographic Services

395 Wellington Street
Ottawa ON K1A 0N4
Canada

Bibliothèque nationale
du Canada

Acquisitions et
services bibliographiques

395, rue Wellington
Ottawa ON K1A 0N4
Canada

Your file *Votre référence*

Our file *Notre référence*

The author has granted a non-exclusive licence allowing the National Library of Canada to reproduce, loan, distribute or sell copies of this thesis in microform, paper or electronic formats.

The author retains ownership of the copyright in this thesis. Neither the thesis nor substantial extracts from it may be printed or otherwise reproduced without the author's permission.

L'auteur a accordé une licence non exclusive permettant à la Bibliothèque nationale du Canada de reproduire, prêter, distribuer ou vendre des copies de cette thèse sous la forme de microfiche/film, de reproduction sur papier ou sur format électronique.

L'auteur conserve la propriété du droit d'auteur qui protège cette thèse. Ni la thèse ni des extraits substantiels de celle-ci ne doivent être imprimés ou autrement reproduits sans son autorisation.

0-612-32901-1

**THE UNIVERSITY OF MANITOBA
FACULTY OF GRADUATE STUDIES

COPYRIGHT PERMISSION PAGE**

**THE DESIGN, CONSTRUCTION, AND TESTING OF AN
OPEN-ENDED ROOF CHANNEL TO REDUCE ATTIC TEMPERATURE**

BY

MYRA JOYCE BERRUB

**A Thesis/Practicum submitted to the Faculty of Graduate Studies of The University
of Manitoba in partial fulfillment of the requirements of the degree**

of

MASTER OF SCIENCE

Myra Joyce Berrub 1997 (c)

**Permission has been granted to the Library of The University of Manitoba to lend or sell
copies of this thesis/practicum, to the National Library of Canada to microfilm this thesis
and to lend or sell copies of the film, and to Dissertations Abstracts International to publish
an abstract of this thesis/practicum.**

**The author reserves other publication rights, and neither this thesis/practicum nor
extensive extracts from it may be printed or otherwise reproduced without the author's
written permission.**

ABSTRACT

Solar gain can cause temperatures in buildings to become extremely high. High environmental temperatures may result in decreased productivity in both humans and animals. A possible solution in reducing this heat is anabatic cooling at the building envelope. A channelled roof with continuous openings, at the eave and ridge, was designed to generate anabatic cooling. The bottom plate of the channel was traditional roof decking. The top plate was formed galvanized steel sheathing, chosen for its availability and popularity in animal housing, light-frame industrial buildings, and buildings in economically poor countries. The force behind reducing heat gain was convective flow. For testing purposes three units were constructed: one control unit with a simple roof of formed galvanized steel sheathing, one 40 mm deep channelled roof unit, and one 90 mm deep channelled roof unit. The attic temperatures in the 40 mm channelled roof unit were 0 to 3 °C lower than those in the control unit, and the attic temperatures in the 90 mm channelled roof unit were 1 to 4 °C lower than those in the control unit. The attic temperatures in the 90 mm channelled roof unit were lower than those in the 40 mm unit by 1 °C. This reduction in heat gain in the channelled roof units occurred via the roof channels. In the south roof channel, the temperatures at the ridge were greater than those at the eave. Therefore, it appeared that heat flow occurred up the roof slope by natural convection. In the north roof channel, the temperatures at the eave were greater than those at the ridge. Thus it appeared that heat flow occurred down the roof slope by forced convection, driven by wind. The influence of wind was observed for wind speeds between 15 and 39 km/hr. As wind increased from moderate to strong, heat flow in the roof

channels became more steady, flowing from the ridge to the eave. Furthermore, forced convection occurred constantly in the 90 mm channelled roof unit for the observed wind speeds, while it occurred constantly in the 40 mm unit only at high wind speeds.

ACKNOWLEDGMENTS

My appreciation goes to Manitoba Hydro and the Manitoba Department of Agriculture for research funding

Huge "thank you"s go to the laborious efforts of Dale Bourne, Henry Bergen, and Chris Bailey.

Grateful appreciation goes to the technical expertise and laborious efforts of Matt McDonald and Jack Putnam

Sincere gratitude goes to Ron Britton.

Humble gratitude goes to Braam Berrub

TABLE OF CONTENTS

ABSTRACT	ii
ACKNOWLEDGMENTS	iv
TABLE OF CONTENTS	v
LIST OF FIGURES	viii
LIST OF TABLES	xi
LIST OF APPENDICES	xii
1 INTRODUCTION	1
1.1 Solar Heat Gain and Building Overheating	1
1.1.1 Solar heat gain in animal housing	2
1.1.2 Solar heat gain in light-frame industrial buildings	2
1.1.3 Solar heat gain in homes	2
1.1.4 Solar heat gain in buildings in economically poor countries	3
1.2 A Potential Solution to the Problem of Solar Heat Gain	3
1.3 Objectives	4
2 LITERATURE REVIEW	5
2.1 Thermal Comfort of Humans and Animals	5
2.1.1 Homeostasis and thermoneutrality	5
2.1.2 Defensive mechanisms and adverse effects on humans due to high environmental temperatures	6
2.1.2. Defensive mechanisms and adverse effects on animals due to high environmental temperatures	7
2.2 Ventilation and Radiant Barrier Systems for Reducing Solar Heat Gain	9
2.2.1 Ventilation	9

2.2.2.	Radiant barrier	9
2.2.3	Combining ventilation and radiant barrier systems	10
2.3	Convection: The Force Behind the Double Roof System	11
2.3.1	The nature of convection	11
2.3.2	Wind effects on convection	12
3	EXPERIMENTAL DESIGN	14
3.1	Guidelines for the System Design	14
3.2	Specifics of the System Design	14
3.2.1	The test units	14
3.2.2	Test unit construction	15
3.2.3	Test site layout	18
3.2.4	Basis for design decisions	19
3.3	Instrumentation	23
4	RESULTS AND DISCUSSION	27
4.1	Introduction to Results and Discussion	27
4.2	Common Elements of All Test Units	29
4.3	Heat Sources, Heat Sinks, and General Direction of Heat Transfer	30
4.3.1	Thermal isolation of the room and the attic	31
4.3.2	Roof system divisions: the EAC, RAC, and AC sections	36
4.4	Observations for the Control Unit	37
4.5	The Control Unit Versus the Channelled Roof Units	38
4.6	Observations for the Channelled Roof Units	39
4.7	Observations for the South Roof Slopes	41
4.7.1	Heat transfer within the EACS, RACS, and ACS sections	44
4.7.2	The 40 versus 90 mm channelled south roof unit	45
4.8	Observation for the North Roof Slopes	50
4.8.1	Heat transfer within the EACN, RACN, and ACN sections	52
4.8.2	The 40 versus 90 mm channelled north roof unit	53
4.8.3	Observations correlated with wind data	54

4.8.4	Supporting evidence of wind effects from the <i>National Building Code of Canada</i>	62
5	CONCLUSIONS	64
6	RECOMMENDATIONS	65
	REFERENCES	66
	APPENDICES	69

LIST OF FIGURES

Figure 1	Simplified representation of Kleiber’s curve, where metabolizable energy is that which the animal can consume, sensible and latent energies are losses, and the area within the curves represents gained energy (adapted from Teeter et al. 1973)	8
Figure 2	External peak pressure coefficients around a gable-roof building (<i>Supplement to the National Building Code of Canada 1995</i>).	13
Figure 3	Cross-section of the experimental design of the channelled roof units (dimensions in mm).	16
Figure 4	Cross-sectional diagram of the ridge cap (dimensions in mm).	17
Figure 5	Plan view of site layout and locations of test units for the experiments	18
Figure 6	Diagram showing the locations of temperature measurements for all test units	25
Figure 7	Temperatures for the control unit, for 1997 06 09, illustrate the general trend of data for each of the test units, and each of the tests. The perforated lines indicate periods of interest for purposes of analysis.	28
Figure 8	Temperatures for the 40 mm channelled roof unit, for 1997 06 10, illustrate the general relative trend of data between the ceiling, the attic, and the room for each of the test units, and each of the tests	30
Figure 9	a) Room and b) attic temperatures for all three test units, for 1997 06 21, illustrate the general relative trend of data between the test units, for each of the tests	33
Figure 10	Temperatures for the 90 mm channelled roof unit, for 1997 06 09, illustrate the general trend of temperature differences for each of the test units, and each of the tests	36
Figure 11	Side view of the roof system division into the EAC, AC, and RAC sections for clarity of discussion	37
Figure 12	Attic temperatures for all three test unit, for 1997 08 24, illustrate the general relative trend of data between the test units, for each of the tests	38

Figure 13	South and north roof temperatures for the 40 mm channelled roof unit, for 1997 08 24, illustrate the general relative trend of data between the test units, for each of the tests	39
Figure 14	Side view diagram of part of the roof structure for the channelled roof units, illustrating the locations of the thermocouples	40
Figure 15	South metal roof temperatures for all three test units, for 1997 07 30, illustrate the general relative trend of data for each of the test units, and each of the tests	41
Figure 16	Temperatures for the 40 mm channelled roof unit, for 1997 06 10, illustrate the general relative trend of data between the ambient air, the roof, the EACS40, the RACS40, and the attic for the channelled roof units, and each of the tests	42
Figure 17	Temperature differences between the south roof and the attic for all three test units, for 1997 08 07, illustrate the general trend of data for each of the test units, and each of the tests	43
Figure 18	Temperature differences between the RACS and the attic for the channelled roof units, for 1997 07 30, illustrate the general trend of data for the channelled roof units, and each of the tests	46
Figure 19	Temperature differences between the RACS and the ambient air for the channelled roof units, for 1997 06 10, illustrate the general trend of data for the channelled roof units, and each of the tests	48
Figure 20	Temperature differences between the RACS and the south roof for the channelled roof units, for 1997 06 09, illustrate the general trend of data for the channelled roof units, and each of the tests	49
Figure 21	Temperatures for the 90 mm channelled roof unit, for 1997 06 21, illustrate the general trend of data between the ambient air, the roof, the EACN90, the RACN90, and the attic for the channelled roof units, and each of the tests	51
Figure 22	a) Maximum and b) minimum air channel temperatures for the 90 and 40 mm channelled roof units, for 1997 06 09 and 06 10, respectively, illustrate the data for the extreme ends of influential wind speeds	55
Figure 23	Air channel temperatures for the 40 mm channelled roof unit, for 1997 08 24, illustrate the trend of data for the channelled roof units corresponding to winds, south, south-east, and south-south-east	56

Figure 24	Air channel temperatures for the a) 40 and b) 90 mm channelled roof units, for 1997 06 21, illustrate the trend of data for the channelled roof units corresponding to winds more west than south.....	57
Figure 25	Air channel temperatures for the a) 40 and b) 90 mm channelled roof units, for 1997 07 30, illustrate the trend of data for the channelled roof units corresponding to moderate winds, south, south-west, and south-south-west	58
Figure 26	Air channel temperatures for the a) 40 and b) 90 mm channelled roof units, for 1997 08 07 and 06 10, respectively, illustrate the trend of data for the channelled roof units corresponding to increasingly moderate winds, south to south-south-west	60
Figure 27	Air channel temperatures for the 40 mm channelled roof unit, for 1997 06 09, illustrate the trend of data for the channelled roof units corresponding to strong winds, south to south-south-east	61
Figure 28	Side view of channelled roof unit illustrating wind and pressure patterns which may have induced negative pressure at the north eave	62
Figure 28	Side view of channelled roof unit illustrating inferred path of air flow within the air channels	63

LIST OF TABLES

Table 1	Descriptions of thermocouple locations	24
Table 2	Nomenclature used for purposes of discussion for data points in the air channels	40

LIST OF APPENDICES

APPENDIX A: THERMONEUTRAL ZONE OF SOME UNGULATES	70
APPENDIX B: DETAILED DRAWINGS OF EXPERIMENTAL DESIGN	71
APPENDIX C: SAMPLE OF TABULATED AVERAGE DATA	73
APPENDIX D: WEATHER SUMMARIES FOR DAYS CHOSEN FOR ANALYSIS	76
APPENDIX E: ALL GRAPHS FROM THE RESULTS AND DISCUSSION SECTION, GENERATED FOR 1997 06 09	77
APPENDIX F: WIND SUMMARIES FOR DAYS CHOSEN FOR ANALYSIS	91

1. INTRODUCTION

High environmental temperatures increase stress on humans and animals. This results in decreased productivity. Prolonged exposure to ambient air temperatures above 42 to 43 °C can be fatal (*1993 ASHRAE Handbook: Fundamentals*; Bligh 1985). Therefore, the need to control extremely high building temperatures is apparent.

1.1. Solar Heat Gain and Building Overheating

Solar heat gain can be a large contributor to increased building temperatures. Solar energy is transferred into buildings based on the thermal and optical properties of the building materials, the time of day, the day of the year, solar radiation intensity, building orientation, surrounding environment, and geographic location. The solar constant, or the solar radiation received in space at the earth's mean distance from the sun, is 1353 W/m² (Duffie and Beckman 1974). If one considers animal housing and light-frame industrial buildings, the ratio of the building footprint to the height is large. Therefore, the ratio of the solar radiation on the roof to that on the walls can be large. In these situations roofs receive a great amount of solar gain, and consequently, attic temperatures can reach extremes. Heyer (1963, cited in Walker and Wooste 1992) reported temperatures at the interface of the roof covering and sheathing as high as 77 °C. Anecdotal information in Manitoba during the summer of 1996

suggests attic temperatures approaching 100°C. High attic temperatures produce large temperature differences across the ceiling, with corresponding large heat gains into the room below

1.1.1. Solar heat gain in animal housing In animal housing ventilation of the living space using outside air, combined with ceiling insulation and attic ventilation are typically used to cope with high building temperatures. This attempt to substantially reduce heat build-up requires further input to provide animal thermal comfort. Coupled with a desire to avoid the expense of mechanical cooling, the task becomes difficult. In some situations evaporative cooling has been used to alleviate heat from building occupants; however, it is only effective in dry climates and environments.

1.1.2. Solar heat gain in light-frame industrial buildings Typically in light-frame industrial buildings, there are no attics and only little, if any, insulation to thwart solar energy gain. Depending on their use these buildings may be air conditioned, but because of the large building volume the associated energy demand is usually very high. Here the task is to reduce solar heat gain to decrease the heat load on the occupants and, in buildings with air conditioning, to decrease the cooling load.

1.1.3. Solar heat gain in homes Solar heat gain also applies to homes. In North America though the cooling demand has a short season, home owners typically deal with solar heat gain by using air conditioning. In the late 1970's, in the United States of America, the energy

used for summer cooling in residential and commercial buildings accounted for 42% of the total summer consumption for these buildings (Anderson 1977). In the southern United States of America, the attic typically uses 10 to 20% of the total air conditioning load on homes (Sklar and Sheinkopf 1991). The goal, then, is to reduce the electrical loads incurred by air conditioning.

1.1.4. Solar heat gain in buildings in economically poor countries Light-frame industrial buildings and homes in economically poor countries are another area of concern. These countries are typically located in tropical zones. Here, though acclimatization and long term adaptation have allowed people to experience thermal comfort at higher ambient temperatures, building overheating is still a problem. Because of limitations of financial resources and resistance of people to change, extra care must be taken to introduce new technologies within the existing social framework.

1.2. A Potential Solution to the Problem of Solar Heat Gain

In light of the problem - solar gain through the roof which enters the building - attention is directed towards preventing heat transfer into the occupied building space. Generating anabatic cooling by incorporating full ridge and eave ventilation and radiant barrier systems into the building envelope is one solution to the problem. The force behind this system is convection. Convective flow can be encouraged by an open-ended air channel created at the building envelope. Such a system was designed, constructed, and tested.

1.3. Objectives

The following are the objectives of this thesis:

- 1 to determine whether an open-ended air channel at a building's roof will reduce solar heat gain into the building
- 2 to quantify the reduction in solar heat gain, if any

2. LITERATURE REVIEW

2.1. Thermal Comfort of Humans and Animals

2.1.1. Homeostasis and thermoneutrality On a very basic level ASHRAE defines thermal comfort in humans as the state of mind when humans express satisfaction with the thermal environment. Acceptable thermal environment is that in which at least 80% of normally clothed women and men living in Canada and the United States of America, while engaged in indoor sedentary or near sedentary activities, would express thermal comfort (*ASHRAE Standard 55-92: Thermal Environmental Conditions for Human Occupancy*, 1992).

On a physiological level humans and animals are homeostatic; that is to say that they have individual core body temperatures that are relatively constant and mostly independent of environmental temperature. The thermal environment, however, influences their heat dissipation. Homeostasis in humans and animals is a physiological control system by means of which the body adapts to its thermal environment. The optimum thermal environment for humans and animals, the thermoneutral zone, occurs when heat is dissipated to the environment without adjustment by the homeostatic mechanisms from the optimum point.

Thermoneutrality is dependent on a variety of factors, including species, age, weight, sex, health, nutrition, and acclimatization. Thermal comfort of humans and animals is highly complex and individual specific. Simplification of this study has been undertaken, however, by disregarding environmental effects such as relative humidity, ambient air movement, and barometric pressure, and physiological effects such as individual metabolic rate. Air

temperature alone has been examined. It is the major variable describing thermal environment since sensible heat dissipation is a function of the difference between ambient air and body temperatures. The following section identifies defence mechanisms against, and adverse effects of, heat stress on humans and animals.

2.1.2. Defensive mechanisms and adverse effects on humans due to high environmental temperatures There is a neutral mid-point temperature which exists for humans. For healthy humans body temperature remains relatively constant at 37°C. Disregarding air velocity this corresponds to an environmental temperature of 24±4°C (*Solar Heat and The Overheating of Buildings*, 1975). As environmental temperature increases the human body enters regulatory zones which work to maintain the core body temperature. First, when heat loss to the environment becomes restricted, blood flow to the skin is increased. Subsequently, heat transfer from the skin to the environment is increased. If this is not sufficient to balance the restricted heat loss, the body begins to sweat. Sweating provides a means for evaporative cooling. If evaporation is not sufficient to balance the restricted heat loss, core body temperature begins to increase. Humans begin to lose their efficiency when core body temperature becomes greater than 2°C above 37°C (*ASHRAE Handbook: Fundamentals*, 1993)

Through understanding the human body's first line of defence against high environmental temperatures, the potential for adverse effects is already evident. In an attempt to increase blood flow, heart rate is increased. If the rate becomes too fast to fill the heart with blood completely, it may actually decrease the amount of blood pumped from the heart.

Consequently, blood pressure and supply to the brain may be decreased or blood supply to the skin may be decreased, or both. Heat exhaustion may occur resulting in loss of consciousness.

Another problem, hyperventilation, occurs in hot-wet conditions. This causes too much carbon dioxide to be flushed from the blood. It can result in tingling and numbness in the skin, and vasoconstriction in the brain. Again, the result may be loss of consciousness.

Core body temperatures above 41°C may result in the damage of proteins in the brain which function to regulate body temperature (ibid.). Heat stroke may occur resulting in inappropriate vasoconstriction, cessation of sweating, increase of heat production by shivering, or some combination of these. Often, the damage is irreversible and may result in death. Body temperatures above 43°C may result in death after a few minutes (ibid.).

2.1.3. Defensive mechanisms and adverse effects on animals due to high environmental temperatures For domestic animals there is a thermal range in which maximum productivity and maximum efficiency of feed conversion occurs. The body temperatures of animals remain relatively constant at 36 to 38°C (Kleiber 1975). For corresponding thermoneutral ambient air temperatures for some ungulates, see Appendix A. There is an optimum zone, within the thermoneutral zone, in which optimum productivity, performance, and efficiency is demonstrated. As environmental temperature increases above the thermoneutral zone the animals' bodies enter similar regulatory zones as humans. First, heat is lost to the environment via increased blood flow to the skin. Second, evaporative cooling occurs at the surface of the body by sweating, or in the respiratory tract by ventilation.

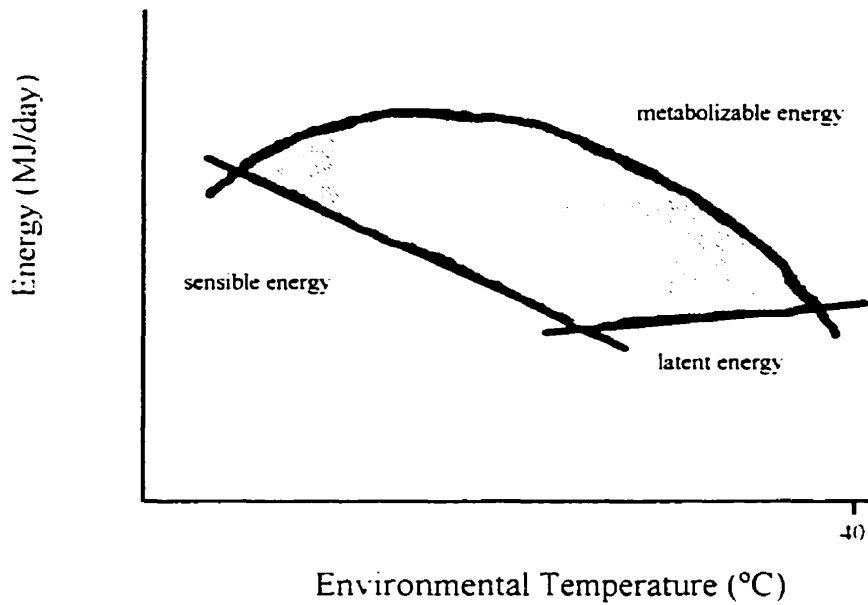

Figure 1 Simplified representation of Kleiber's curve, where metabolizable energy is that which the animal can consume, sensible and latent energies are losses, and the area within the curves represents gained energy (adapted from Teeter et al. 1973).

As a result of increased environmental temperature heat production within the animal decreases. Heat production is a result of feed consumption and a by-product of growth and productivity. In an attempt to maintain core body temperature when environmental temperature increases, animals reduce feed consumption to decrease heat production, and consequently, growth and productivity are decreased as well. Figure 1 shows the curve developed by Max Kleiber which illustrates this balance of energy.

Failure to renew homeostasis can result in diarrhea, general weakness, convulsions, and ultimately, death. Body temperatures exceeding 42 to 43°C may cause damage to the central nervous system with fatal consequences (ibid.). Other adverse effects of heat stress

will vary depending on the species. In pigs reproduction is decreased due to a decrease in libido (Curtis 1985). In poultry, egg size, quality, and quantity are diminished (Austic 1985). In cattle milk production declines (Johnson 1985). In sheep short-term exposure to heat stress can reduce wool growth rate by up to 20% (Thwaites 1985).

2.2. Ventilation and Radiant Barrier Systems for Reducing Solar Heat Gain

2.2.1. Ventilation Attic ventilation is standard in buildings to allow the escape of hot air and to prevent heat build-up and transfer into the living space. According to ASHRAE (*ASHRAE Handbook: Heating, Ventilating, and Air Conditioning: Systems and Equipment*, 1996), during periods of heating, a well designed ventilation system can, at best, maintain an area to 2 °C above the incoming air temperature. In tests, conducted at the University of Illinois Building Research Council, comparing an unvented cathedral ceiling, an unvented attic, a vented cathedral ceiling, and a vented attic, sheathing temperatures of 180, 175, 170, and 165 °F (82, 79, 77, and 74 °C), respectively, were recorded (Cushman 1996). In a study by Lear et al (1987) comparing standard and full venting, where the former met the minimum required attic ventilation with soffit and gable vents, and the latter had continuous soffit and ridge vents plus standard gable vents, a decrease in the ceiling heat flux of approximately 30% was realized through the use of full venting.

2.2.2. Radiant barrier Another method of dealing with unwanted solar heat gain is through the installation of a radiant barrier. Generally, this is a layer of aluminum foil placed in an

attic, parallel to the roof deck, along the bottom side of the top chord. As the name suggests a radiant barrier blocks radiant heat transfer. Research done at the Florida Solar Energy Center showed that a radiant barrier reduced approximately 95% of solar radiation otherwise entering the attic insulation and subsequently conducting into the living space (Sklar and Sheinkopf 1991). Furthermore, these studies showed that heat conduction through the ceiling was reduced by approximately 45%, or approximately 8 to 12% of the cooling bill. Returning to the results of Lear et al. (1987), the addition of a radiant barrier decreased the ceiling heat flux by a further 40% relative to full venting.

2.2.3. Combining ventilation and radiant barrier systems The problem is solar gain through the roof which is transferred into the building. Therefore, the first line of defence against solar heat gain is the building envelope. By using the building envelope to lower solar heat gain, building occupants and any building services will have less heat to cope with. By incorporating ventilation and radiant barrier systems into the building envelope, anabatic cooling can result. With a radiant barrier, solar gain is blocked. With ventilation, solar gain is redirected away from the building. Design guidelines, for variations of a double roof with a ventilation channel open at the eave and ridge, are presented and recommended as advances in passive solar cooling (Bourke 1997; Bowen 1984; Karaman 1983; Karamchandani and Amin 1983; Passive-Cooling Concept House in Cook 1984; Sawyerville House in Argue 1980) However, little quantitative documentation exists on the effectiveness of these systems in reducing solar heat loads. This study will attempt to quantify the effect of an open-ended roof channel on reducing attic temperatures.

2.3. Convection: The Force Behind the Double Roof System

2.4.1. The nature of convection Within an air channel, between two parallel plates, heat flow can occur. When a temperature difference exists between at least one of the plates and the air, the heat transfer that occurs between the plate and the air is called convection. Convection heat transfer is a combination of random molecular motion and bulk fluid motion. In particular, during natural convection, fluid flow arises from gravity. Air in contact with a plate of warmer temperature will itself increase in temperature. This results in a decrease in the density of the air. This lighter air is acted upon by buoyancy forces to induce a vertical motion of the now warm air, which is replaced by cooler air (Incropera and DeWitt 1990; Kays and Crawford 1993). On a calm day, because of the very nature of natural convection, air flow occurs up the slope of the air channel, from the eave to the ridge between the two parallel plates of the double roof. The top plate, or roof sheathing, is heated by solar radiation. The temperature difference between this and the air in the channel causes convective heat flow within the air channel. Rising warmed air leaves the channel at the ridge and is replaced by cooler air entering the channel at the eave. When the air in the channel is influenced by wind, heat transfer results from forced convection.

Besides being influenced by properties of the air, such as density, humidity, viscosity, specific heat, and thermal conductivity, convection flow within an open-ended roof channel is affected by the depth of the air channel, the sizes of the inlet and outlet of the air channel, the inclination of the roof, and the dimensions of the roof (in particular, the length).

There has been little study done on the performance of convection, as it applies to the

particular case of a double roof with an open-ended air channel, where complications of non-smooth surfaces, due to purlins, cause turbulent air flow. To confound matters, as temperatures increase, turbulence increases. Regardless, the following study has been undertaken, not as a comprehensive study of convection flow, but, assuming simplified situations of convection, to gain a basic understanding of the nature and effectiveness of an open-ended roof channel for reducing heat build-up in buildings.

2.4.2. Wind effects on convection The presence of wind may affect the performance of convection. The *Supplement to the National Building Code of Canada 1995* shows that when wind is present, pressure will act on a building. General pressure distributions due to wind around a gable-roof building are shown in Figure 2.

When wind flow is parallel to the ridge of a building, one would anticipate little influence on flow within a roof channel open at the eave and the ridge. When wind flow is perpendicular to the ridge of a building, one would anticipate greater influence on flow within the same roof channel. When this occurs - when wind flow is in the direction of the air channel - one might speculate that the effects of the wind would overpower free convection. One might speculate further that the wind would cause forced convective flow in the air channel. Moreover, pressure is greatest at the edges of a building. Therefore, negative pressure, or suction, occurring at one end of the air channel might encourage forced convection. Negative pressure occurring at the eave would cause air flow to occur down the roof slope, from the ridge to the eave.

Load case A winds generally perpendicular to ridge

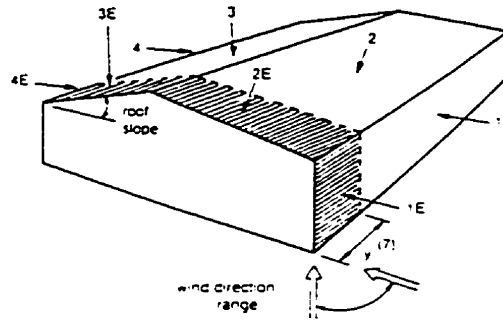

Roof slope	Building surfaces							
	1	1E	2	2E	3	3E	4	4E
0 TO 5°	0.75	1.15	-1.3	-2.0	-0.7	+1.0	+0.55	-0.8
20°	1.0	1.5	-1.3	-2.0	-0.9	+1.0	+0.8	-1.2
30 TO 45°	1.05	1.3	0.4	0.5	-0.8	+1.0	+0.9	-0.9
90°	1.05	1.3	1.05	1.3	-0.7	-0.9	-0.7	-0.9

Load case B winds generally parallel to ridge

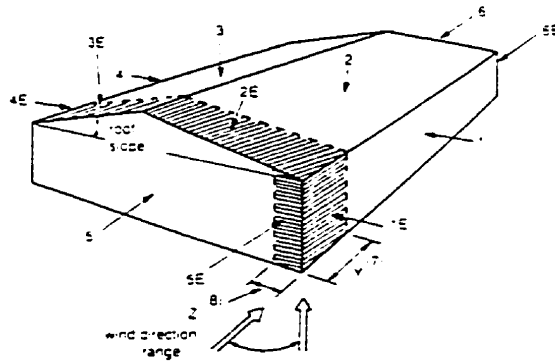

Roof slope	Building surfaces											
	1	1E	2	2E	3	3E	4	4E	5	5E	6	6E
0 TO 90°	-0.85	-0.9	+1.3	-2.0	-0.7	+1.0	-0.8	-0.9	0.75	1.15	+0.55	-0.8

Figure 2 External peak pressure coefficients around a gable-roof building (Supplement to the National Building Code of Canada 1995).

3. EXPERIMENTAL DESIGN

3.1. Guidelines for the System Design

As basic guidelines for any new system to be used to reduce solar heat gain in buildings, the system should use simple principles, be easily constructed with minimal hardware, and be easily maintained. Practically, the system should be of realistic cost. As this was a preliminary study, however, the main concern was not to optimize the system design, but rather, to conclude whether or not an open-ended roof channel is effective in reducing solar heat gain. Furthermore, minimizing cost was not of concern because there are many ways to create a plenum, and subsequently, many considerations for design optimization - far too many for the scope of this study. It can be seen that the selected design minimizes or eliminates the influence of solar energy gain by making use of the building fabric. The cost of this design is based on initial costs and not operating nor maintenance costs. No new construction was required, only retro-fit inputs were needed.

3.2 Specifics of the System Design

3.2.1. The test units A basic stud-frame test unit, 1830 mm x 7320 mm x 2440 mm, was designed to model a section of gable-roof building. Three variations of the unit were built. The first unit was the control. The second unit had a channelled roof with an air channel depth of 40 mm. The third unit had a channelled roof with an air channel depth of 90 mm.

In the channelled roof units an air channel was created at the roof between a top plate of formed galvanized steel sheathing and a bottom plate of oriented strand board. This was done to generate convection. The eaves and the ridge were left open to encourage convection flow via the air channel and to allow a path of escape for the heated air.

3.2.2. Test unit construction Besides the differences in air channel depth and relative position to other test units, the units were identical. Each unit was 1830 mm wide at the eave end, 7320 mm long at the gable end, and 2440 mm high from the ground to the ceiling. The stud frames were sheathed with 11 mm oriented strand board and no insulation was provided to the walls. No ventilation was provided to the room of any of the test units, and the only opening was a door on the south end to provide access to each unit. Each ceiling was 11 mm oriented strand board with an overlying vapour barrier. Above this, insulation was blown into each attic with a rating of $R.S I = 10 \text{ m}^2 \cdot \text{K} \cdot \text{W}^{-1}$. No gable vents were installed in any of the attics, however, a continuous soffit opening of $542 \times 10^3 \text{ mm}^2$ was provided at each eave. A kingpin truss was used to support the 4/12 pitch roof. There was no roof overhang at the gable ends. Figure 3 shows a cross-section of the experimental design of the channelled roof units, for a more detailed drawing of the design, see Appendix B.

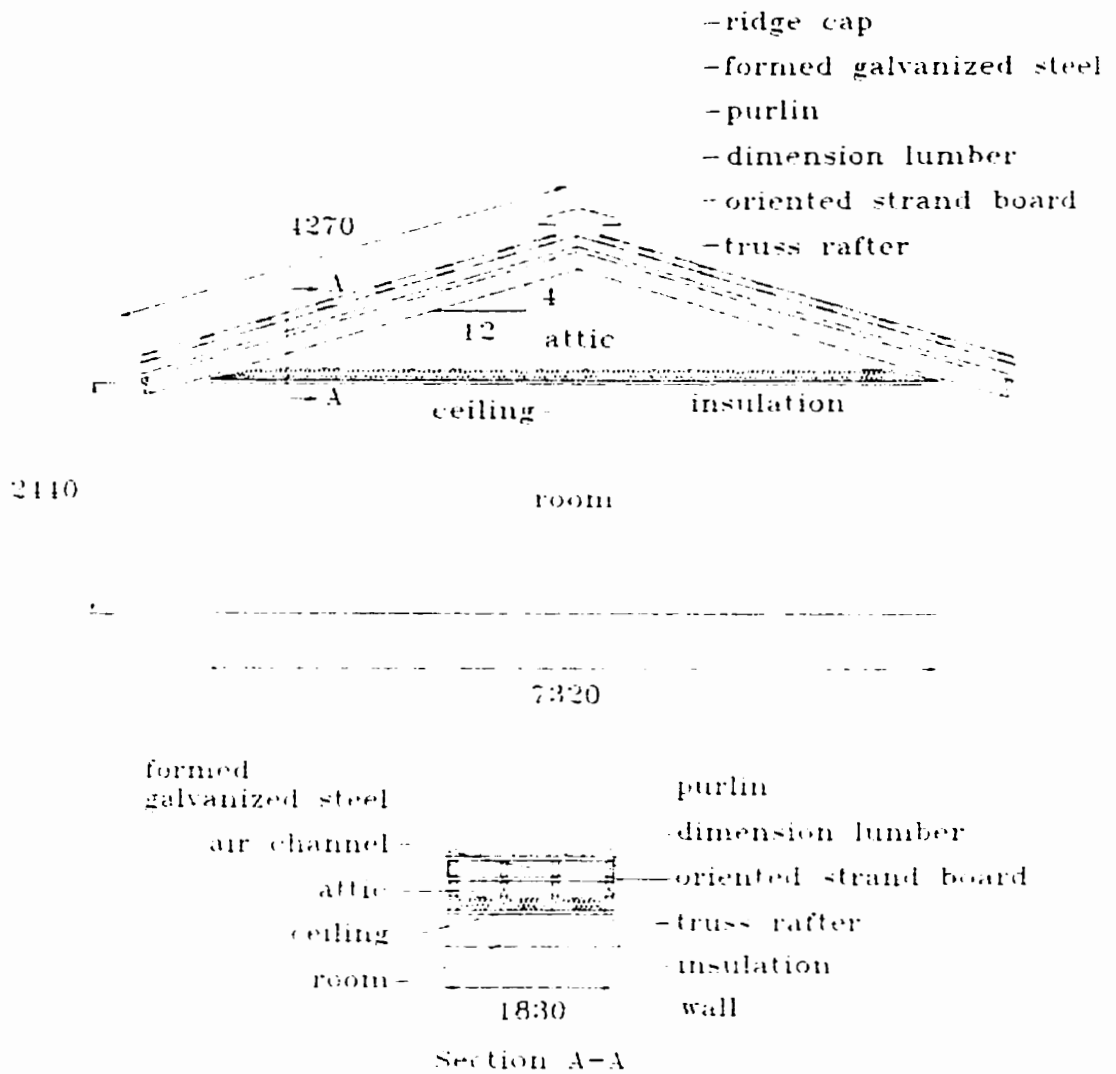

Figure 3 Cross-section of the experimental design of the channelled roof units (dimensions in mm)

The differences in the test units start at the roof layer, above the top chord of the roof truss. Above the top chord of the control unit 0.358 mm (29 gauge) formed galvanized steel sheathing rested on supporting purlins. The channelled roof units were more complex.

Above the top chord of the channelled roof units lay oriented strand board¹. Affixed to this was dimension lumber, spaced at 610 mm on centre, running up the slope of the roof. This 2 x 4 dimension lumber was on its side for the 40 mm deep air channel, and on edge for the 90 mm deep air channel. Purlins perpendicular to this lumber, spaced at 610 mm on centre, supported the top plate of 0.358 mm (29 gauge) formed galvanized steel sheathing. The eave and ridge ends of the air channel were left open. Each eave opening was 130 mm in width, providing an open area of $238 \times 10^3 \text{ mm}^2$. The full ridge opening was 150 mm in width, providing a total open area of $275 \times 10^3 \text{ mm}^2$. For protection from rain and snow a ridge cap constructed of 0.358 mm (29 gauge) formed galvanized steel sheathing was installed above the ridge opening (see Figure 4). The ridge cap was open on the eave ends, each end providing an open area of $238 \times 10^3 \text{ mm}^2$.

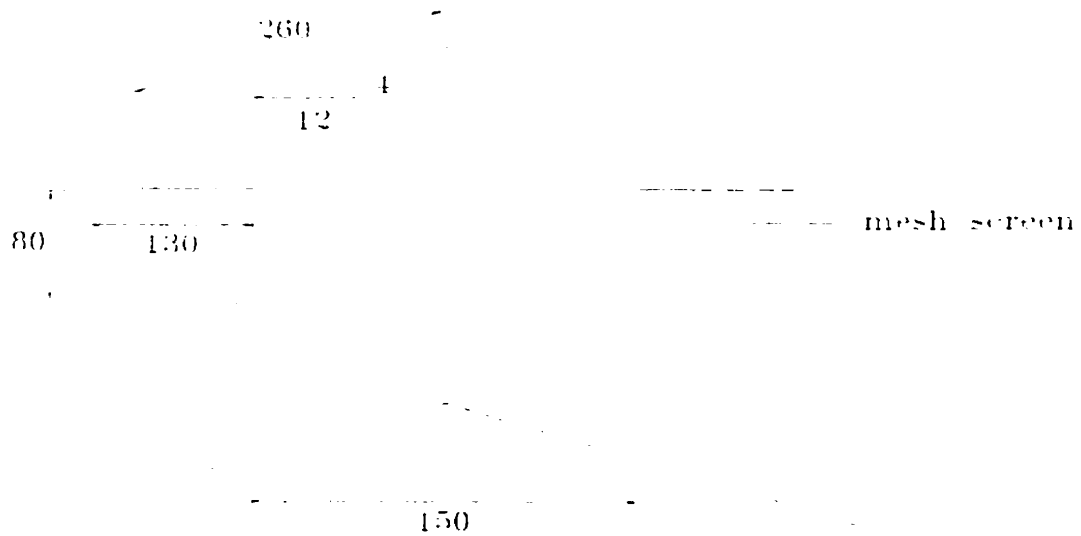

Figure 4 Cross-sectional diagram of the ridge cap (dimensions in mm).

¹ It should be noted that this was not considered a radiant barrier as defined in the Literature Review section, because oriented strand board has a high emissivity value.

3.2.3. Test site layout

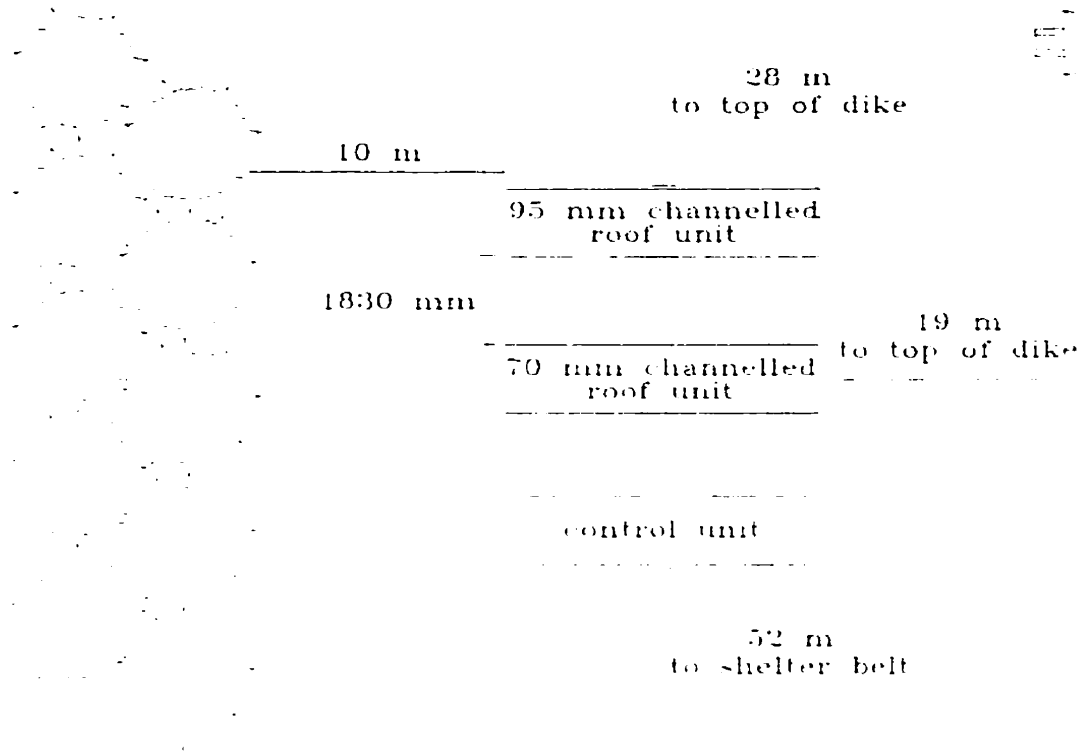

Figure 5 Plan view of site layout and locations of test units.

The layout of the test site is diagrammed in Figure 5. The test units were oriented with the roof slopes in the north-south direction; in other words, the ridges were perpendicular to the north-south direction. They were equally spaced at 1830 mm between the walls, in the east-west direction. The east test unit was the control. The middle test unit was the channelled roof unit with a channel depth of 40 mm. The west test unit was the channelled roof unit with a channel depth of 90 mm. The test site was located on a plot of levelled land at the Glenlea Research Station, which is approximately 10 km south of

Winnipeg A dike ran along the north and west sides of the test units. To the north the top of the dike was approximately 19 m away from the north walls of the test units. To the west the dike was approximately 28 m away from the west wall of the west test unit. Shelter belts ran along the south and east sides of the test units. To the south the shelter belt consisted of a stand of dead evergreen trees, two trees wide (approximately 3 m from trunk to trunk), and approximately 7 to 10 m in height. This was approximately 10 m away from the south walls of the test units. To the east the shelter belt consisted of a single row of deciduous trees, an average of 10 to 13 m in height. This was approximately 52 m away from the east wall of the east test unit. The aforementioned plot of land was a site of little activity for the duration of the tests. Furthermore, there were no occupants in the test units, and consequently, no internal heat generation.

3.2.4. Basis for design decisions

Roof type Given that gable roofs are most common in agricultural and light-frame industrial buildings, this configuration was selected. The shape of the gable roof also allowed for the observation of both the north- and south-facing roof slopes. From this it could be determined if the design was practically applicable, and further, whether success required one south-facing channelled slope or both south- and north-facing channelled slopes.

Dimensions of test units The dimensions of the test units were chosen for their convenience and to meet experimental data collection objectives. The 7320 mm length was not too long

to manage, and also, though not typical, it is not uncommon in agricultural and light-frame industrial buildings. The 1830 mm width was chosen so that three 610 mm wide air channels would be created at the roof of each test unit and the “isolated” middle air channel could be observed. The air channels were interconnected by purlins. The middle air channel was affected on either side by the other channels, and not by gable wall temperatures. The 2440 mm height was chosen to facilitate the use of typical sheathing panel dimensions and to have sufficient space for movement within the test units. It should be noted here that there have been some problems reported in using small models for measuring irradiation. Hahn et al. (1962) found that roof temperatures measured on full-scale buildings are higher than those measured on smaller model units². Therefore, the use of other-than-full-scale test units might result in lower measured roof temperatures.

Wall insulation The walls were left uninsulated due to cost. Also, because summer irradiation is greatest on horizontal surfaces, and because of the large roof-to-wall ratio of the test units, the insulation through the walls was assumed insignificant compared to that through the roof. The wall sheathing of 11 mm oriented strand board gave a rating of $R S I 0.1 \text{ m}^2 \cdot \text{K} \cdot \text{W}^{-1}$.

Attic insulation To allow for ventilation via soffit vents, section 9.19.1.3 of the *National Building Code of Canada 1995* states that not less than 63 mm of space be provided between

² This temperature difference is due to the various stages of build-up of the boundary layer over the roof as it is affected by roof size and wind.

the top of the insulation and the underside of the roof sheathing. In compliance with this cellulose was blown into the attic to fill a depth of 410 mm. This provided a rating of $R S I = 10 \text{ m}^2 \cdot \text{K} \cdot \text{W}^{-1}$.

Attic ventilation The attic was not fitted with gable vents in order to test a worst case scenario. Additionally, due to the width of the test units, any gable vents in the attic would have had the potential to create excessive and unrealistic ventilation rates. The attic, however, had continuous soffit venting at both eaves. As a general rule the recommended minimum ventilation area is one square unit to every three hundred square units of insulated ceiling area (section 9.19.1.2, *National Building Code of Canada 1995*). The insulated ceiling area in each unit was $13.4 \times 10^6 \text{ mm}^2$, giving a recommended minimum ventilation area of $44.6 \times 10^3 \text{ mm}^2$. Continuous soffit venting amounted to a total ventilation area of $1084 \times 10^3 \text{ mm}^2$. This was much larger than the recommended minimum ventilation area. However, because the vents were at an equal height, ventilation was not thermally driven. Any ventilation that occurred was due to wind.

Roof pitch A 4/12 roof pitch was chosen as it is the most common pitch for gable-roof agricultural and light-frame industrial buildings. It should be noted that this relatively shallow roof pitch is not ideal for convection. Maximum convection flow occurs over vertical plates. A steeper slope would mean increased cost and a greater attic volume which would be wasted space.

Roof material composition Though perhaps not the most traditional of materials 0.358 mm (29 gauge) formed galvanized steel roofs have grown in popularity and availability in economically poor countries. This material is also often found in animal housing and light-frame industrial buildings. For these reasons 0.358 mm (29 gauge) formed galvanized steel sheathing was used for the outer roof layer of each of the test units. When new, galvanized steel has an absorptivity of 0.65 (Incropera and Dewitt 1990)³. The top chords of the channelled roof trusses were sheathed with oriented strand board to serve as the bottom plate of the air channel. Oriented strand board was absent from the roof of the control unit because most buildings typically have only one sheathing layer at the roof. Although this decision created greater R.S.I.-values in the roofs of the channelled roof units, it also simulated real life situations.

Channelled roofs' air channel depths Air channel depths of 40 and 90 mm were chosen because they are the depth of 2 x 4 dimension lumber on its side and edge, respectively. This facilitated the use of typical lumber dimensions.

Ridge cap As the ridge was left open to promote air flow in the channelled roof units, ridge caps were installed to prevent rain and snow from entering the air channels. The absence of rain and snow from the air channels simplified the analysis.

³ Galvanized steel has an absorptivity of 0.80 when oxidized and weathered (Incropera and Dewitt 1990).

Orientation of test units The north-south orientation of the test units allowed the attribution of the greatest possible solar gain from the south-facing slope. Generally this accounted for the greatest amount of heat gain in the test units. It also allowed an evaluation of the contribution, if any, of insolation from the north-facing slope.

Spacing between test units The 1830 mm spacing between the test units did not allow for the avoidance of solar shadow throughout the day. However, the most critical time of testing was when the greatest amount of solar gain occurred. Maximum solar energy gain occurs when the sun is directly overhead. At this time solar shadow is minimized and all three test units would receive equal solar exposure. Solar shadow was, therefore, assumed to be inconsequential. This spacing also disallowed for the avoidance of wind shadow.

3.3. Instrumentation

Copper-Constantan thermocouples, accurate to $\pm 0.5^{\circ}\text{C}$, were used to take temperature readings⁴. Given meteorological variability, the heat source for all points monitored in this study and the degree of thermal sensitivity of humans and animals, greater data accuracy was not sought. Locations of temperature measurements are described in Table 1 and diagrammed in Figure 6.

⁴ Calibration of the thermocouples was not done as this study was interested in observing temperature differences. At the onset of the tests, each thermocouple was tested for precision using an Omega thermocouple indicator, Model HH23, with a resolution of 0.1°C .

Table 1 Descriptions of thermocouple locations.

Identifier	Unit	Multiplexer Channel	Location
ambient air	not applicable	24	suspended 650 mm above ground inside a 150 mm capped steel cylinder, 3.4 m north of middle unit
room	east, middle, west	5, 23, 14	suspended in centre of room
ceiling	east, middle, west	4, 22, 13	attached to underside of ceiling, in centre
attic	east, middle, west	3, 21, 12	suspended in centre of attic
roof, south	east, middle, west	2, 10, 19	attached to underside of south steel roof, in centre
roof, north	east, middle, west	1, 7, 16	attached to underside of north steel roof, in centre
eave air channel, south (EACS)	middle, west	20, 11	suspended in centre of south air channel, 610 mm from eave
eave air channel, north (EACN)	middle, west	15, 6	suspended in centre of north air channel, 610 mm from eave
ridge air channel, south (RACS)	middle, west	18, 9	suspended in centre of south air channel, 152 mm from ridge
ridge air channel, north (RACN)	middle, west	17, 8	suspended in centre of north air channel, 152 mm from ridge

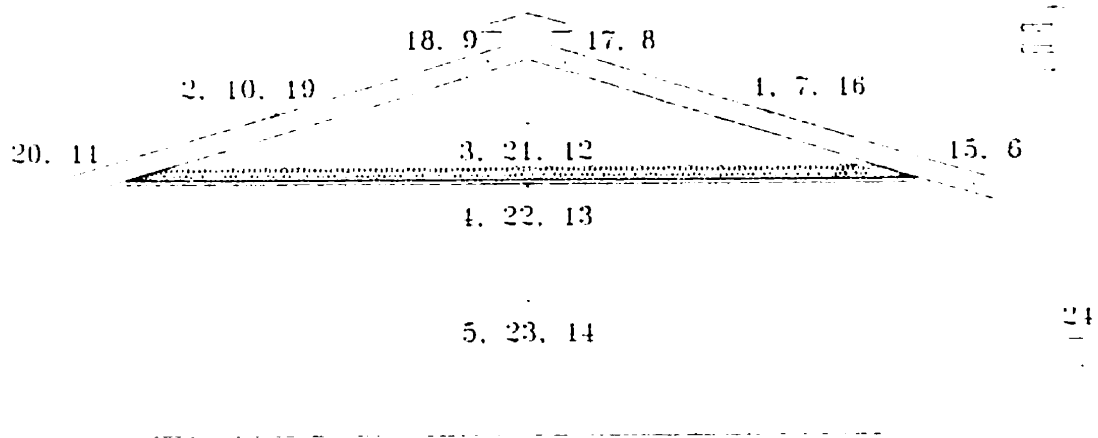

Figure 6 Diagram showing the locations of temperature measurements for all test units.

A data acquisition system and a computer were installed in the middle test unit to collect and store temperature data. Heating effects of this system were assumed negligible compared to the summer ambient temperatures. The data were logged to a UNISYS 300 (an 80286 PC) by a sampling program written by Matt McDonald, an electronics technician in the Department of Biosystems Engineering at the University of Manitoba. Every hour, on the hour, three successive temperature readings were taken for each location. It should be noted that velocity measurements for the convecting air were not measured. It was assumed that heat transfer could be determined from temperature data alone.

Tests were begun in the late summer of 1996 with an HP 3852A data acquisition system. As it was on loan, a change was made to a Keithley DAS-1800ST/HR data acquisition system before the summer's end. This second data acquisition system did not have the required

sensitivity and subsequently received interference from a nearby microwave tower and gave erroneous data. Due to this interference only two days of proper data were logged for the summer of 1996. For the tests undertaken in the summer of 1997 another system was used; an HP 34401A multimeter with a custom multiplexer.

4. RESULTS AND DISCUSSION

4.1. Introduction to Results and Discussion

The purpose of these tests was not to design for the climate of a specific locale (i.e., Winnipeg), but rather to assess overall design behaviour in warmer climates. Therefore, the data of importance to this thesis were those in which the ambient air temperature was high. This corresponded to the greatest potential for heat build-up in the test units. For this reason, although data were collected continuously, it was deemed unnecessary that it all be analysed. Intervals with high ambient air temperatures were chosen for analysis, rather than intervals of average ambient air temperatures. Data were first collected for the fall of 1996. These data were discarded because of uncertainty associated with the instrumentation (see the Experimental Design section). However, even at moderate temperatures and in spite of instrumentation difficulties, these first tests demonstrated a drop in attic temperatures with the inclusion of an open-ended roof channel. This indicated a need for more data, especially at higher temperatures, and data were collected during the summer of 1997⁵. The days chosen for analysis were the 9th, 10th, and 21st of June, the 30th of July, and the 7th and 24th of August. June 21, the summer solstice, was chosen for observation as it is the day of the year with the longest potential for incoming solar radiation. Although ambient air temperature only reached a maximum of approximately 30°C, it was generally a sunny day.

⁵ All logged data are available on 3.5 inch diskettes. All data for 1997 06 09 have been tabulated in Appendix C.

The remainder of the days were chosen for analysis because of their high ambient air temperatures, with maximums ranging from approximately 33 to 36°C. Moreover, the main part of each of these days was clear and sunny⁶.

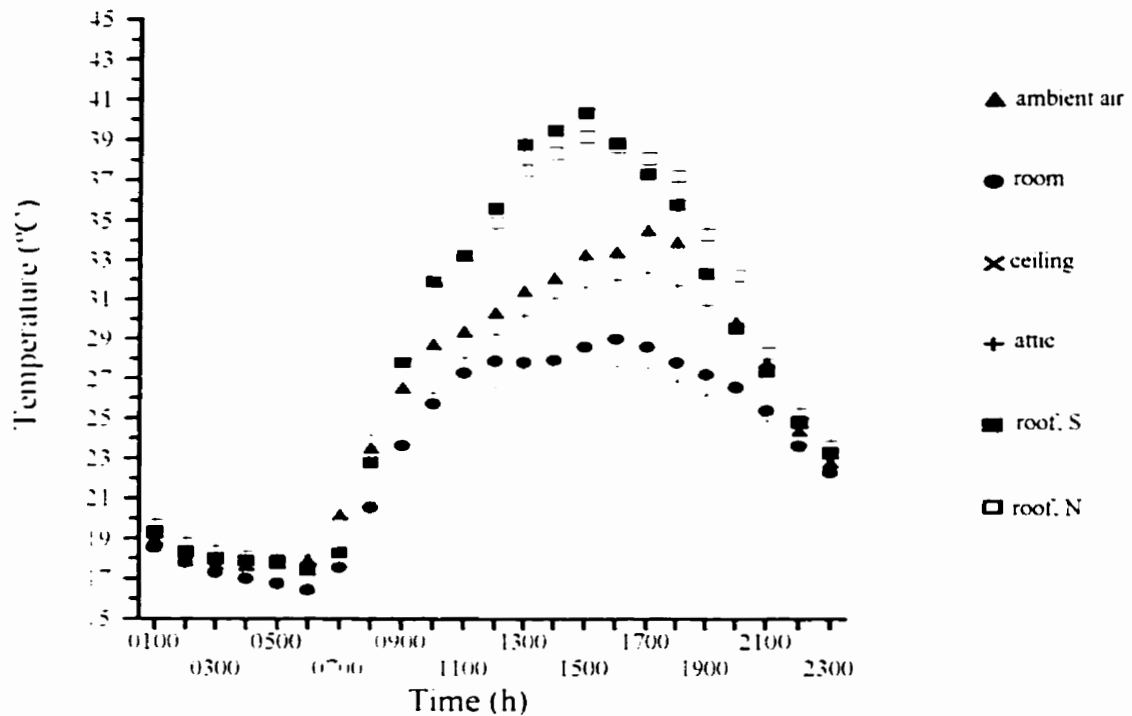

Figure 7 Temperatures for the control unit, for 1997 06 09, illustrate the general trend of data for each of the test units, and each of the tests. The perforated lines indicate periods of interest for purposes of analysis⁷.

⁶ Weather summaries were obtained for the days chosen for analysis from Environment Canada (see Appendix D).

⁷ All graphs in the Results and Discussion section have been generated for 1997 06 09 in Appendix E).

Individual tests were designated by separating the data into days from midnight to midnight. In this way the data points monitored for each test unit began, and ended, in a more or less steady state (see Figure 7). Thus each day, or test, began with all the data points at approximately equal values. As the day progressed the influence of the sun caused an increase in ambient air and roof temperatures, and consequently, an increase in attic and room temperatures. At the close of each day, this solar heat gain decreased and all the data points converged, to approximately the same temperature.

While each day generally followed a gradual rise and fall in temperatures, specifics varied due to the constant variation in ambient air temperature, cloud cover, and wind speed and direction. For this reason no statistical analysis was undertaken. Although observation was mainly quantitative, inferences were qualitative.

4.2. Common Elements of All Test Units

First, the common elements for all test units were examined. The following can be noted by looking at the typical trend of a day's data in Figure 7. At night all test unit temperatures were approximately equal to ambient air temperatures. As the sun rose heat gain by the test units commenced, and temperature differences between the ambient air and the room, and the ambient air and the attic developed and increased. Generally this occurred between 0800 and 1900 h. It was this period of time, when temperature differences occurred, that was of interest. The period of interest, for performance observation, was restricted even further to

the interval between 1300 and 1800 h when temperature differences remained relatively stable

4.3. Heat Sources, Heat Sinks, and General Direction of Heat Transfer

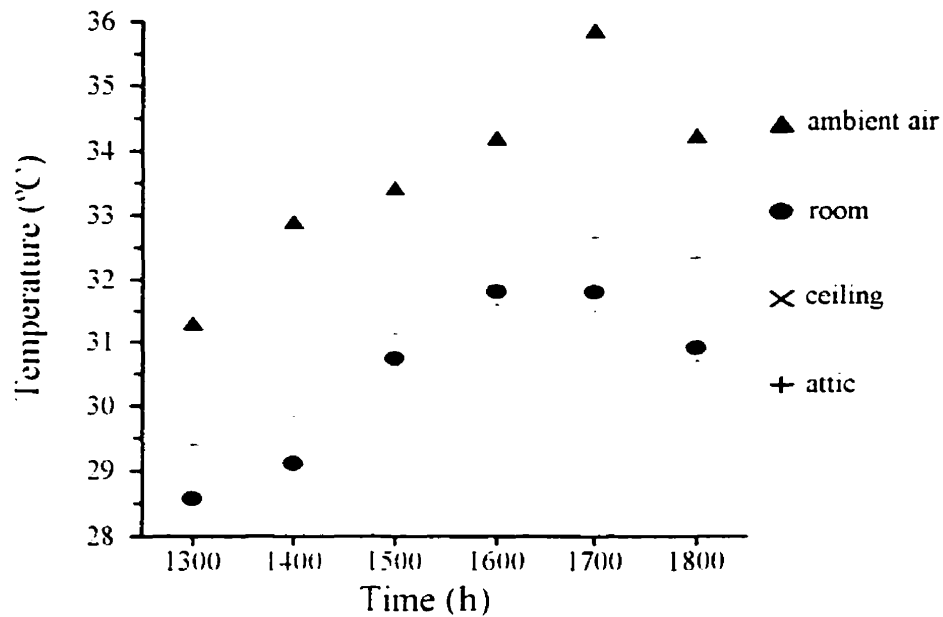

Figure 8: Temperatures for the 40 mm channelled roof unit, for 1997 06 10, illustrate the general relative trend of data between the ceiling, the attic, and the room for each of the test units, and each of the tests.

Overall, attic temperatures were lower than ambient air temperatures. One would have anticipated the reverse due to attic heat build-up. This unexpected observation may be due to the effectiveness of the galvanized steel roof as a shade against radiation. Another unexpected observation was that for each test unit, the temperature of the ceiling was almost always lower than the temperatures of both the room and the attic. A typical trend of the

relative temperatures of the ceiling, the attic, and the room can be seen in Figure 8. Although these temperature differences were small, typically 0 to 2°C and not larger than approximately 6°C, they did exist⁸. One would have expected the temperature of the room to be lower than the temperature of the ceiling, and both to be lower than the temperature of the attic. This would have indicated heat transfer from the attic, through the ceiling, into the room. The observed data indicate, however, that the ceiling acted as a barrier, and the room and the attic were thermally isolated. Therefore, when making temperature comparisons the temperature of the attic, rather than that of the room, was used.

4.3.1. Thermal isolation of the room and the attic Four suppositions can be made as to the cause of the thermal isolation of the room and the attic. First, soffit ventilation may have provided sufficient heat removal to reduce attic temperatures. Recall from the Experimental Design section that the actual soffit ventilation was far greater than the recommended minimum attic ventilation. Therefore, an excess capacity for ventilation existed. This soffit ventilation might have been large enough that, with sufficient wind, it created a flow channel through the middle of the attic, reducing the attic heat. This, however, is not a defensible speculation as soffit ventilation must be wind driven and it is unlikely that wind was sufficient to cause constant ventilation. If this theory explains the observation of lower attic temperatures, constant ventilation would have had to occur. Furthermore, recall from the

x

Recall from the Experimental Design section that Copper-Constantan thermocouples are accurate to 0.5°C. Furthermore, their precision was tested before installation to be $\pm 0.2^\circ\text{C}$. For this reason temperature differences as small as 0.5°C were considered to be of importance.

Literature Review section that ASHRAE suggests that, during periods of heating, a well designed ventilation system will, at best, maintain the ventilated area's temperature to within 2 °C above that of the supply air (*ASHRAE Handbook: Heating, Ventilating, and Air Conditioning: Systems and Equipment*, 1996).

Secondly, air leakage may have occurred out of the attic. If the attic air was stagnant and layering occurred, the temperature of the layer along the underside of the roof would have correlated with that of the roof, while the temperature of the layer along the upper side of the ceiling would have correlated with that of the ceiling. In other words, the top layer would have had a higher temperature than the bottom layer. Leakage occurring at the attic's peak would have caused an increasing temperature gradient from the bottom to the top of the attic. This idea lends itself to the inference that a middle layer existed, the temperature of which was an average of the top and bottom layers. As the attic temperature was measured at this middle layer, it may not have been indicative of the true attic temperature, but rather was lower. Temperature variations within the attic, therefore, cannot be established, and subsequently, neither can the true average attic temperature nor heat flow patterns.

A third speculation as to the cause of thermal isolation between the attic and the room is that heat gain, through the uninsulated south wall, may be greater than the insubstantial amount originally anticipated in the Experimental Design section. This influence is supported by an observation comparing the room temperatures of the three test units over time (see Figure 9a)

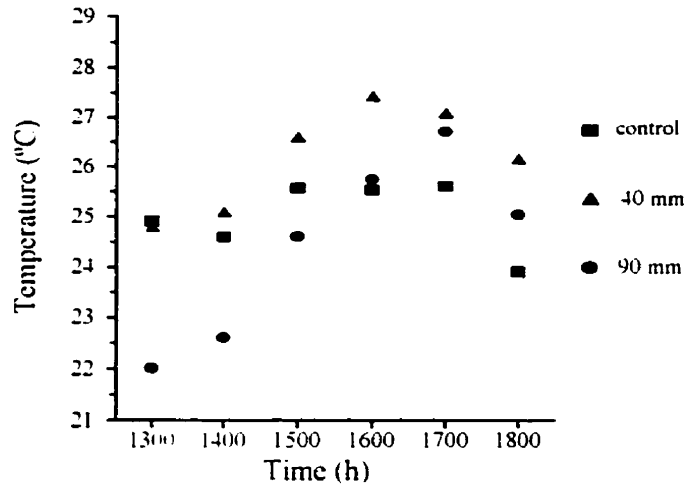

a) room temperatures

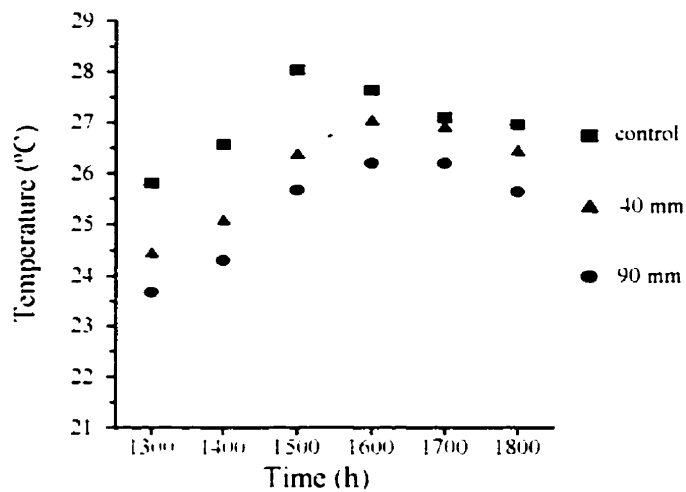

b) attic temperatures

Figure 9: a) Room and b) attic temperatures for all three test units, for 1997 06 21, illustrate the general relative trend of data between the test units, for each of the tests.

Before 1600 h the room temperature of the 90 mm channelled roof unit was lower than that of the control unit, and both were lower than that of the 40 mm channelled roof unit.

For example, their temperatures at 1500 h were approximately 24.5, 25.5, and 26.5°C, respectively. After 1600 h the room temperature of the control unit was lower than that of the 90 mm channelled roof unit, and both were lower than that of the 40 mm channelled roof unit. For example, at 1700 h, their temperatures were approximately 25.5, 26.5, and 27.0°C, respectively.

These observations do not correspond to the attic temperatures of the test units. The attic temperature of the 90 mm channelled roof unit was lower than that of the 40 mm channelled roof unit, and both were lower than that of the control unit (see Figure 9b). The cross-over for room temperatures was probably due to solar gain through the walls, and subsequent heat storage. Furthermore, remember that the sun follows an east-rising and west-setting path. In the morning the sun had a greater influence on the east unit (i.e., the control unit). In the evening the sun had a greater influence on the west unit (i.e., the 90 mm channelled roof unit).

A fourth approach might be taken to understand the inferred thermal isolation. It is possible that the measured ceiling temperature was an anomaly. Only one data point was monitored for the ceiling, in the middle of its underside. Had an average of ceiling data points been taken, it might have indicated that the ceiling temperature was between the attic and room temperatures. This would indicate heat transfer from the attic, through the ceiling into the room, as was originally anticipated. The theory of heat transfer, from the attic to the room, is reinforced by the previous observation that the room temperature was consistently higher in the 40 mm channelled roof unit, than in both the control and 90 mm channelled roof units. In fact, based on the previous theory of heat gain through the south walls, one would

anticipate that the room temperature in the 40 mm channelled roof unit would be the lowest. This unit, the middle unit, would not have received as much morning nor evening sun as the east and west units would have received, respectively. Because this unit's room temperature was the highest, it can be deduced that it received heat gain from somewhere other than the walls. The only plausible source of this heat is from the attic, through the ceiling.

The first three theories as to the cause of thermal isolation of the room and the attic, can also be used to speculate as to why, as a general observation, the attic temperature was always lower than the ambient air temperature. Due to heat storage in the attic, as a consequence of heat transfer from the ambient air, or the roof, or both, one would have anticipated the attic temperature to be higher than the ambient air temperature in all three test units. This was not the case, however. Therefore, one might theorize that the attic temperature was lower than the ambient air temperature due to soffit ventilation, attic air leakage, south wall heat gain, or some combination of the three.

Figure 10 illustrates observations regarding the source of heat for various locations in the test units. Again, these observations are typical and common to all three test units. The room temperature was lower than the ambient air temperature, typically by 4 to 5°C. Therefore, heat was transferred from the ambient air into the room. Because heat did not continue to build-up in the room to become warmer than the ambient air temperature, one might speculate that the soil, which was the foundation for each test unit, acted as a heat sink. The soil was shaded by the test units. As a result, the capacity of the soil to act as a heat sink was great. This might account for the relatively low temperatures in the rooms of the test units.

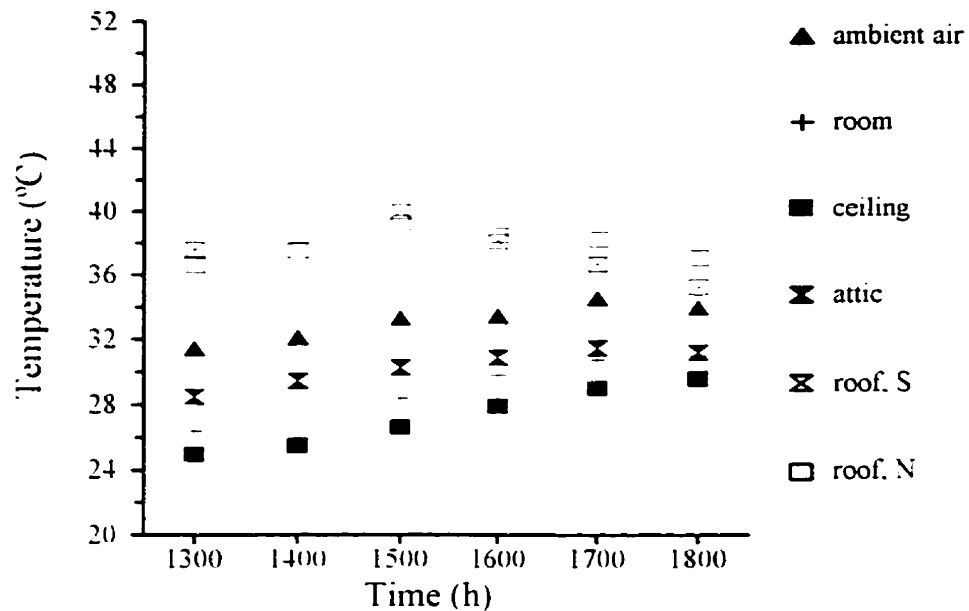

Figure 10: Temperatures for the 90 mm channelled roof unit. for 1997 06 09. illustrate the general trend of temperature differences for each of the test units, and each of the tests.

Finally, the attic temperature was lower than the roof temperatures of both the south and north slopes. It appears that heat transfer occurred from the roof into the attic.

4.3.2. Roof system divisions: the EAC, RAC, and AC sections For remaining purposes of discussion and to facilitate a better understanding of the directions of heat transfer, the roof system has been divided into three sections, as shown in Figure 11. The Eave Air Channel or EAC section, the Ridge Air Channel or RAC section, and that between the two, the Air Channel or AC section. These acronyms will be appended with an "S" or an "N" to designate south or north roof slope, respectively.

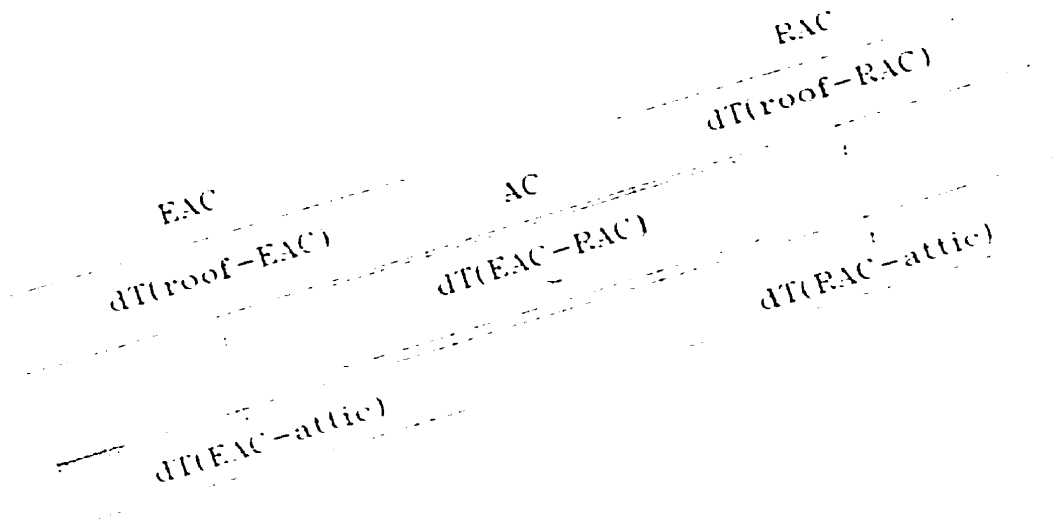

Figure 11 Side view of the roof system division into the EAC, AC, and RAC sections for clarity of discussion.

4.4. Observations for the Control Unit

Before making any comparisons between the three different test units, the trends observed for the control unit will be analysed. Attic temperatures were lower than both ambient air and roof temperatures. These temperature differences were approximately 1 to 2°C and typically 7 to 10°C, respectively. These temperature differences infer that heat transfer occurred into the attic, from the roof. The relatively large magnitude of the temperature difference, between the attic and the roof, suggests that a large amount of heat gain into the control unit was a result of the high roof temperatures. These high roof temperatures were a result of incoming solar radiation. Therefore, the contribution of solar radiation to heat gain in the control unit was large.

4.5. The Control Unit Versus the Channelled Roof Units

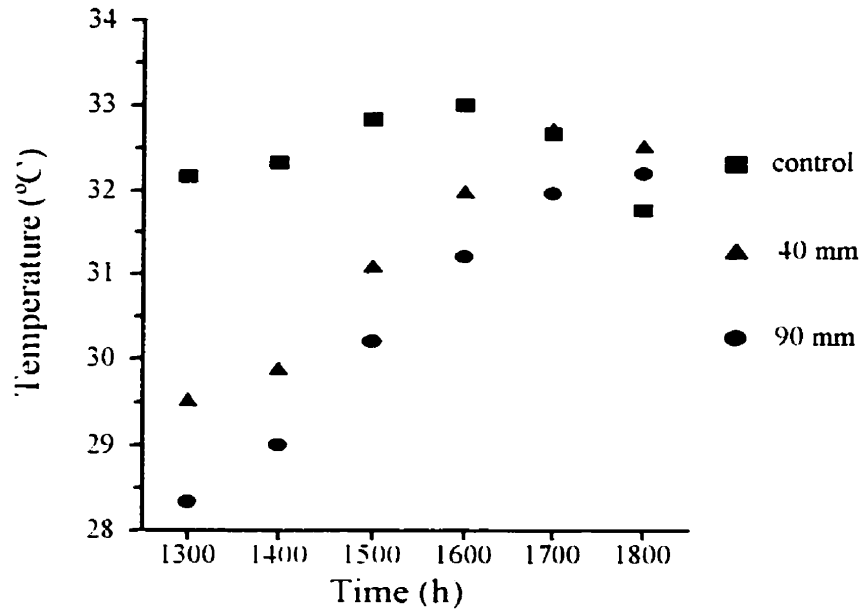

Figure 12: Attic temperatures for all three test units, for 1997 08 24, illustrate the general relative trend of data between the test units, for each of the tests.

A graph of the attic temperatures of each of the test units indicates that, overall, attic temperature was higher for the control unit than for the channelled units (see Figure 12). For this particular day, between 1300 and 1700 h, a temperature difference existed between the control and the 40 mm channelled roof units, of 3°C dropping to 0°C. A temperature difference existed between the control and the 90 mm channelled roof units, of 4°C dropping to 1°C. A temperature difference of 1°C existed between the 40 and 90 mm channelled roof units. One can infer that the reduction of heat gain occurred to a greater extent in the channelled roof units than in the control unit.

4.6. Observations for the Channelled Roof Units

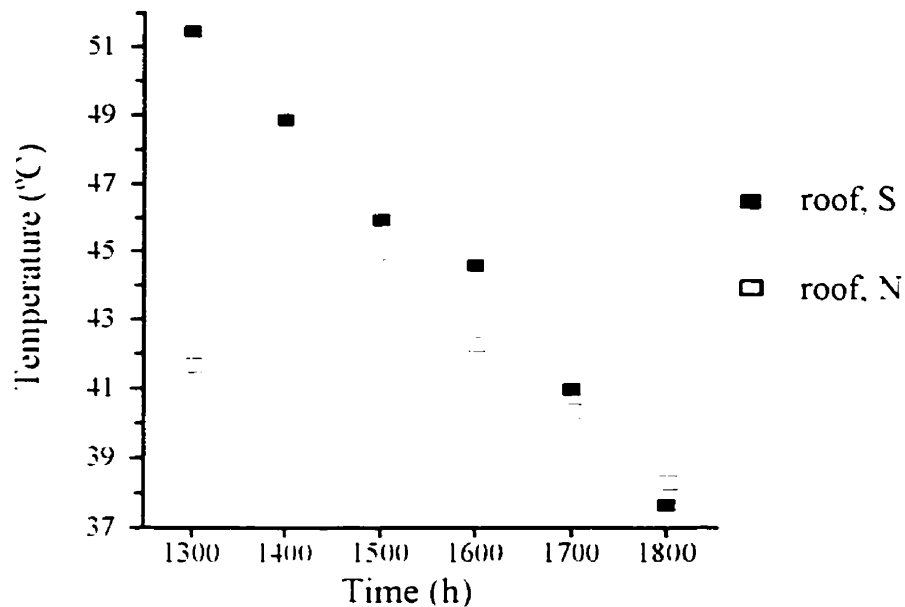

Figure 13: South and north roof temperatures for 40 mm channelled roof unit, for 1997 08 24, illustrate the general relative trend of data between the test units, for each of the tests.

One would anticipate that the south and north roof slopes would receive different effects from the sun and wind, due to solar angle and roof tilt, thereby generating different effects of heat gain on the test units. As Figure 13 shows, this was the case. Temperatures on the south and north roofs were not equal. For this reason the south and north roof slopes were analysed separately.

Before continuing the locations of the data points corresponding to the roof system divisions of Figure 11 units will be restated. Part of Figure 6 has been reproduced in Figure 14 for this

purpose. Corresponding data point nomenclature are given in Table 2.

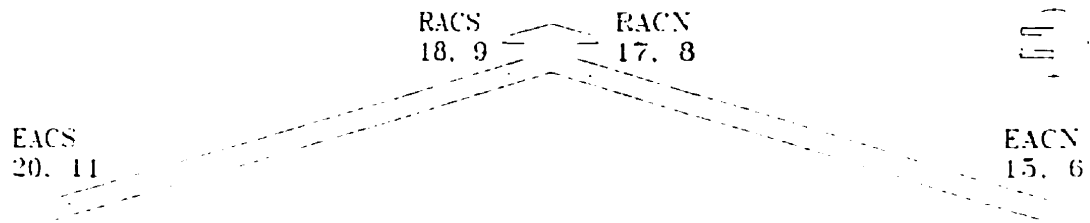

Figure 14: Side view diagram of part of the roof structure for the channelled roof units, illustrating the locations of the thermocouples.

Table 2: Nomenclature used for purposes of discussion for data points in the air channels.

Channelled Roof Unit	Thermocouple Number	Symbol
40 mm (middle)	20	EACS40
90 mm (west)	11	EACS90
40 mm (middle)	15	EACN40
90 mm (west)	6	EACN90
40 mm (middle)	18	RACS40
90 mm (west)	9	RACS90
40 mm (middle)	17	RACN40
90 mm (west)	8	RACN90

4.7. Observations for the South Roof Slopes

As was mentioned previously, the metal roof was a substantial heat source for the test units. The heat gain at the roof was due to solar radiation. This was common to all three test units, as was indicated by the relatively equal metal roof temperatures (see Figure 15). Variations, of up to 4°C , in south metal roof temperatures may have been due to wind and subsequent metal cooling, on both the upper- and under-sides of the metal.

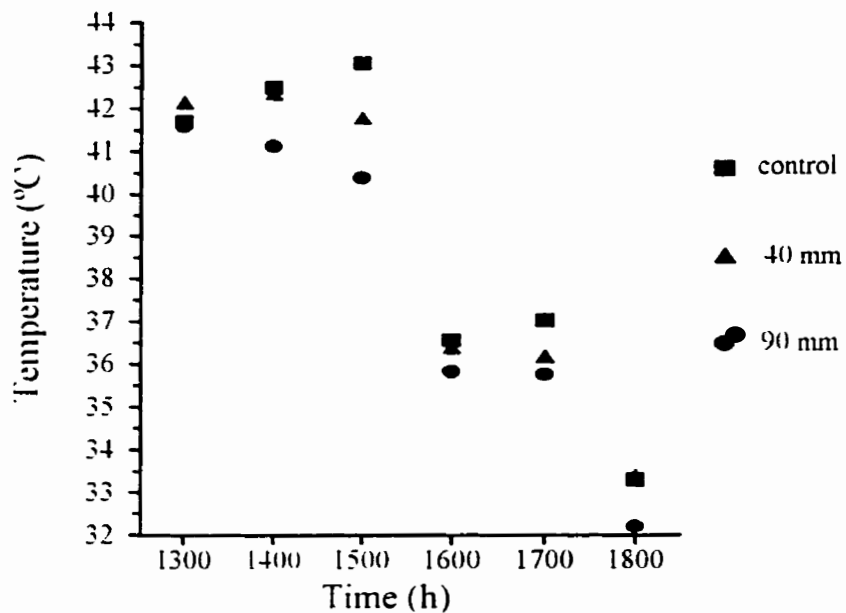

Figure 15: South metal roof temperatures for all three test units, for 1997 07 30, illustrate the general relative trend of data for each of the test units, and each of the tests.

Figure 16 illustrates typical temperature data for the south air channels. For both channelled units, the attic and EACS temperatures were approximately the same. One would have

expected the EACS temperature to be equal to or higher than the ambient air temperature, due to heat gain and build-up, as the ambient air and the roof were the source of heat to the EACS. However, the EACS temperature was, in fact, lower than the ambient air temperature by approximately 2°C. Therefore, there appears to have been a cooling effect from some unknown source. One speculates that this cooling source is the same as that mentioned previously for the explanation that attic temperatures were lower in the channelled units than in the control unit. When compared to the RACS temperature, however, the ambient air temperature was lower, as one would have expected.

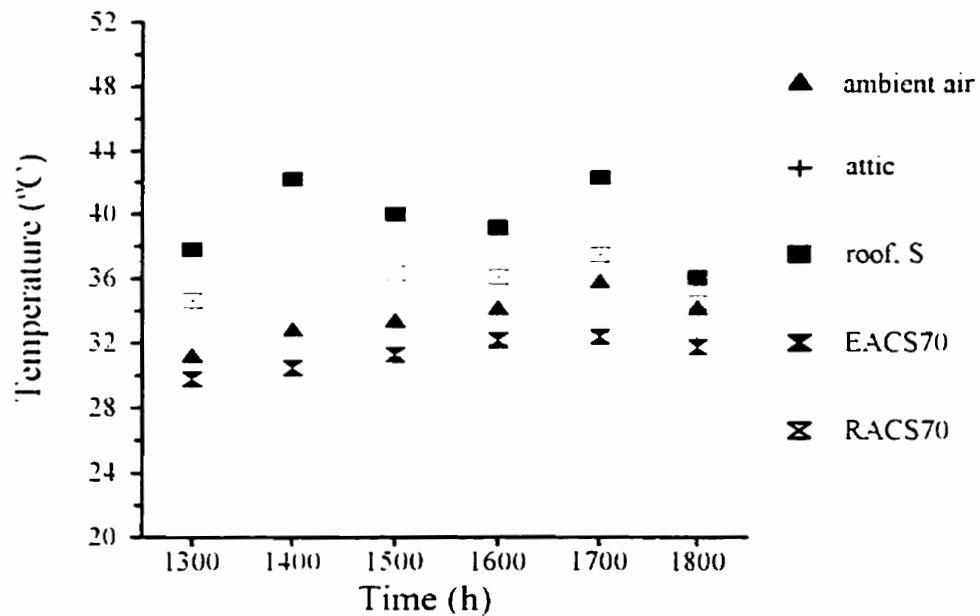

Figure 16: Temperatures for the 40 mm channelled roof unit, for 1997 06 10, illustrate the general relative trend of data between the ambient air, the roof, the EACS40, the RACS40, and the attic for the channelled roof units, and each of the tests.

Additionally, one observes, from Figure 16, that the EACS temperature was lower than the RACS temperature. Heating must have occurred within the air channel. Moreover, both the EACS and RACS temperatures were less than the roof temperature. This suggests that heat transfer occurred from the roof into the air channel, at both the eave and ridge ends of the air channel. Also, recall that the attic temperature was less than the roof temperature. Therefore, it appears that heat transfer occurred from the roof to the attic through the air channel. However, air channel temperatures were higher than the attic temperature and not equal to them. Therefore, one can infer that the maximum potential for heat transfer, into the attic, was not reached.

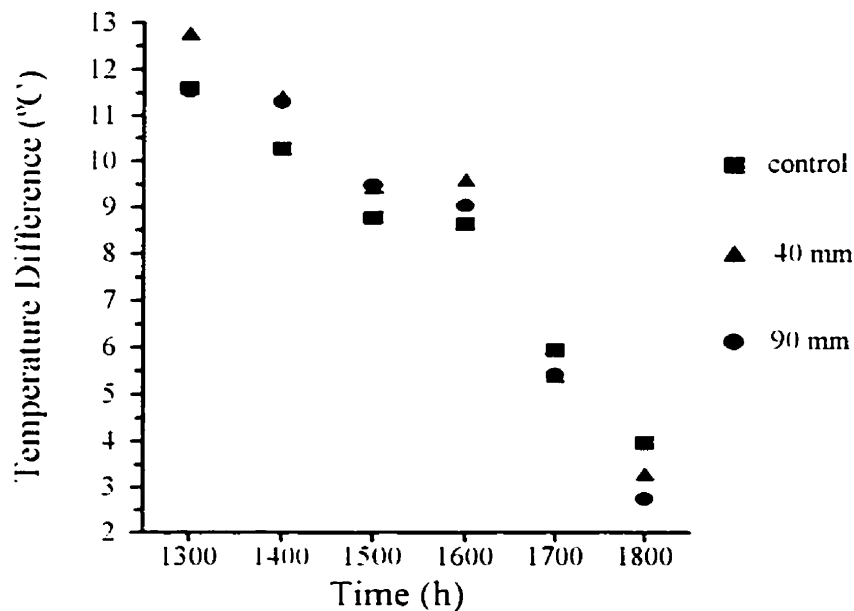

Figure 17: Temperature differences between the south roof and the attic for all three test units, for 1997 08 07, illustrate the general trend of data for each of the test units, and each of the tests.

The temperature difference between the south roof and the attic was relatively large, typically between 3 and 13°C (see Figure 17). Therefore, one can infer, as was done previously, that there was a substantial amount of heat transfer to the attic, from the roof. From this one might infer an increase in attic temperature as a consequence of heat transfer and storage. However, this attic temperature increase did not occur. Thus, there must have been a reduction in the heat gain that transferred from the roof to the attic.

For the south roof slopes of each channelled unit, the temperature difference between the roof and the EACS was much greater than the temperature difference between the EACS and the attic. Furthermore, the temperature difference between the RACS and the EACS was much greater than the temperature difference between the EACS and the attic. Therefore, one could infer that most of the heat of the EACS flowed into the RACS. In other words, heat was built up in the air channel. This acted as a heat sink which was constantly being replenished by heat from the steel roof. Similarly, due to the temperature differences between the roof and the RACS, and the RACS and the attic, one could infer that heat was transferred from the roof to the RACS to the attic. This is better understood by considering the EACS, RACS, and ACS sections defined previously in Figure 11.

4.7.1. Heat transfer within the EACS, RACS, and ACS sections Refer again to Figure 16. Looking at the EACS section, the temperature difference between the roof and the EACS was approximately 7 to 10°C. That between the EACS and the attic was approximately 0°C. Therefore, it could be surmised that there was little, if any, heat transfer into the attic within

the EACS section of the system. Furthermore, observing the ACS section, the temperature difference between the EACS and the RACS was approximately 5 to 7°C. Therefore, because the heat from the EACS section did not go into the attic, and because of the existence of a temperature difference, it can be deduced that there was a relatively large amount of heat which flowed from the EACS into the RACS, or rather, that there was a large amount of heat build-up within the air channel. This establishes the idea that heat flowed within the air channel from the eave to the ridge. In other words, it appears that natural convection flow occurred within the air channel. Finally, analysing the RACS section, the temperature difference between the roof and the RACS was approximately 3 to 5°C. The temperature difference between the RACS and the attic was approximately 4 to 7°C. Therefore, it was supposed that there was a great deal of heat transfer into the attic within the RACS section of the system. The source of this heat was that which built up in the air channel from the EACS section, and that which entered the air channel from the roof.

4.7.2. The 40 versus 90 mm channelled south roof unit For the 40 mm channelled roof unit, the temperature difference between the air channel (namely the RACS) and the attic was greater than that for the 90 mm unit, by 1 to 3°C (see Figure 18). Therefore, one may infer that a slightly greater amount of heat was transferred to the attic from the air channel for the 40 mm channelled roof unit than for the 90 mm unit. This might be attributable to the fact that the 90 mm air channel has a greater volume. This will be elaborated on later.

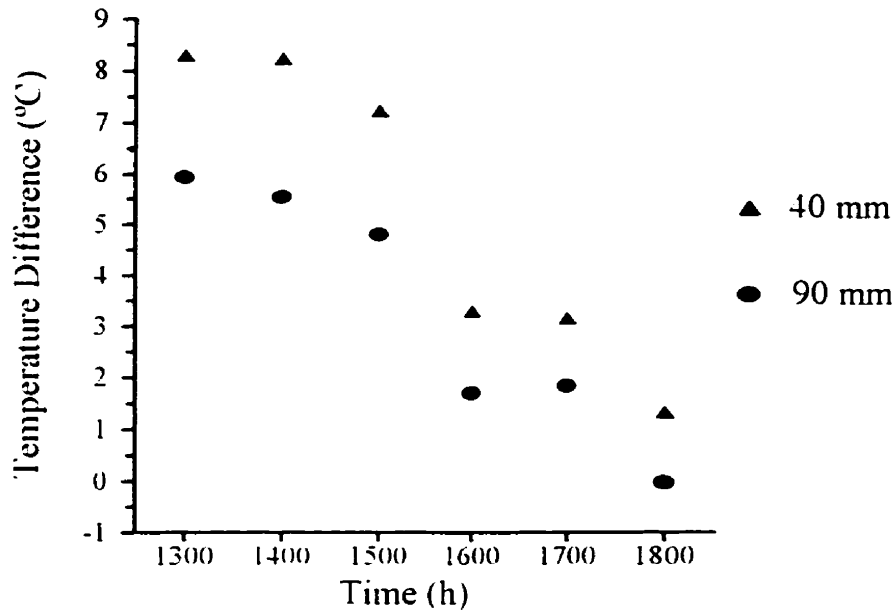

Figure 18: Temperature differences between the RACS and the attic for the channelled roof units, for 1997 07 30, illustrate the general trend of data for the channelled roof units, and each of the tests.

The heat which flowed up the slope of the air channel did not all remain in the RACS section. Some of the heat was transferred into the attic, as was previously indicated. Some of the heat remained in the RACS. However, because the roof system was open at the ridge, one might speculate that some of the heated air continued its natural convection flow, out into the ambient air. While assessing the 40 mm channelled roof unit, it was observed that the ambient air temperature was less than the RACS temperature. Figure 16 shows the typical temperature differences between the ambient air and the RACS of 2 to 4°C. Therefore, heat flow occurred from the RACS to the ambient air. Assessing the 90 mm channelled roof unit, it was observed that, at times, the ambient air temperature was lower than the RACS temperature, and at times, it was higher than the RACS temperature. From this alone no

inferences can be drawn regarding the existence, nor the direction, of air flow. However, it was previously observed that the EACS temperature was less than the RACS temperature. Recall also the direction of heat flow within the EAC and RAC sections. This establishes the existence of air flow up the slope of the air channel, from the eave to the ridge. In other words, as was deduced previously, it appears that natural convection flow occurred within the air channel removing heat from the channelled roof units. The oscillating nature of the temperature differences between the ambient air and the RACS, for the 90 mm channelled roof unit, was likely caused by wind. From this, one may infer that the 90 mm channelled roof unit was influenced more greatly by wind than the 40 mm unit. This hypothesis will be developed in the section, Observations for the North Roof Slopes.

As was stated in the preceding paragraph, the temperature difference between the RACS and the ambient air was greater for the 40 mm channelled roof unit than for the 90 mm unit, typically by 1 to 3°C (see Figure 19). From this observation, one might conclude that the 40 mm air channelled roof was more effective in preventing high attic temperatures. However, the temperature difference between the attic and the roof was almost equal for both 40 and 90 mm channelled roof units. Furthermore, if heat flow and removal occurred via natural convection, up the slope of the channel, the following argument holds. The area of the 40 mm air channel is less than that of the 90 mm air channel. Therefore, the volume of the 40 mm air channel is less than that of the 90 mm air channel. From this, one may gather that the 90 mm air channel heated up more slowly than the 40 mm air channel. Also, at any given velocity the mass movement within the 40 mm air channel is less than that within the 90 mm air channel. At any given mass movement the velocity within the 40 mm air channel

is less than that within the 90 mm air channel. From this, one may infer that more heat was accumulated in the 40 mm air channel, while more heat was removed out of the 90 mm air channel. This is supported by the observation that the RACS temperature for the 40 mm air channel was higher than that for the 90 mm air channel. This argument can be used to clarify the observation that the temperature differences between the ambient air and the RACS were greater for the 40 mm channelled roof unit than for the 90 mm unit.

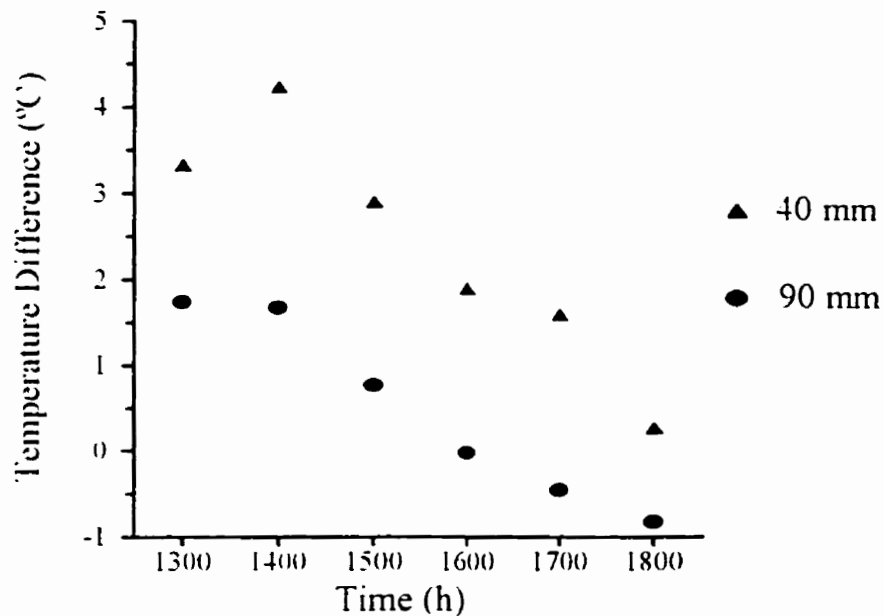

Figure 19: Temperature differences between the RACS and the ambient air for the channelled roof units, for 1997 06 10, illustrate the general trend of data for the channelled roof units, and each of the tests.

Similarly, the temperature difference between the RACS and the roof was greater for the 90 mm channelled roof unit than for the 40 mm unit, typically by 1 to 2 °C (see Figure 20). The roof temperatures for the two channelled units were approximately the same, and the

RACS temperature was less than the roof temperature. From this it can be inferred, as it was observed, that the RACS temperature was higher for the 40 mm channelled roof unit than for the 90 mm unit. Therefore, it appears that the 40 mm channelled roof unit received greater heat than the 90 mm unit. Also, recall the observation that the temperature difference between the attic and the RACS was greater for the 40 mm channelled roof unit than for the 90 mm unit. This confirms that there was greater heat transfer to the attic for the 40 mm channelled roof unit. As an overall observation, the temperature of the attic in the 40 mm channelled roof unit was typically 1 °C higher than that in the 90 mm unit.

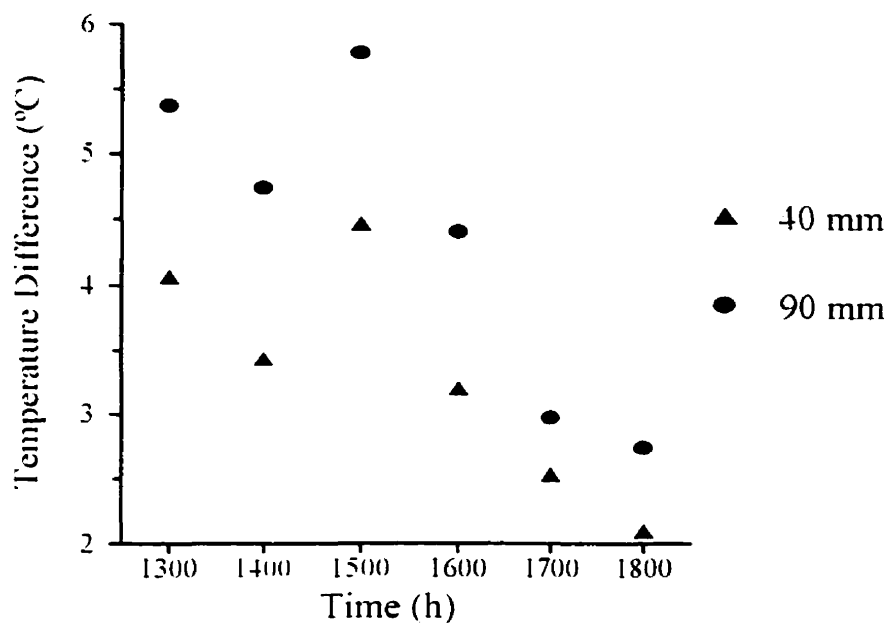

Figure 20: Temperature differences between the RACS and the south roof for the channelled roof units, for 1997 06 09, illustrate the general trend of data for the channelled roof units, and each of the tests.

Overall, the attic temperature of the 90 mm channelled roof unit was lower than that of the 40 mm channelled roof unit, and both were lower than that of the control unit. Therefore, the effectiveness in preventing high attic temperatures was greater in a test unit with an air channel than one without one. Furthermore, the 90 mm deep air channel was more effective in preventing high attic temperatures than the 40 mm deep air channel⁹.

4.8. Observation for the North Roof Slopes

One would anticipate similar behaviour for the north roof slope to that of the south. Upon initial observation, however, it appeared that there was no trend in the north roof slope temperature data. At times the RACN temperature was higher than the EACN temperature. At other times, the reverse was true. This is illustrated in Figure 21. At 1300 h, the RACN90 temperature was higher than the EACN90 temperature. From 1400 to 1500 h, the reverse was true. At 1600 h, the RACN90 temperature was again higher than the EACN90 temperature. At 1400 h, the temperature gradient reversed again. At 1800 h, the temperature gradient reversed once again. This oscillating nature was typical of the north roof slopes for winds bearing south, south-west, and south-south-west. Similar oscillations occurred between the air channel and attic temperatures. Therefore, no trend was apparent for the north roof slopes.

⁹ Recall that the inference was based on attic temperature as a guide, rather than room temperature, due to the apparent thermal isolation of the two spaces.

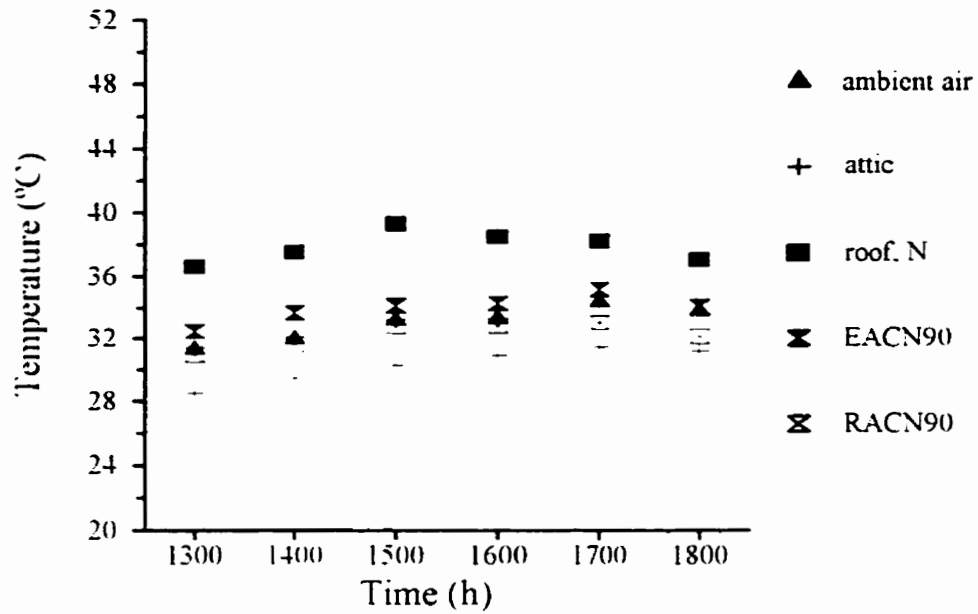

Figure 21: Temperatures for the 90mm channelled roof unit, for 1997 06 21, illustrate the general trend of data between the ambient air, the roof, the EACN90, the RACN90, and the attic for the channelled roof units, and each of the tests.

Although there were no obvious trends in the data, some basic observations can still be made for the north roof slope. Many of these observations are the same as those observed for the south roof slope. The roof temperature was higher than the air channel temperature, which was higher than the attic temperature. Therefore, as for the south roof slope, it appears that heat transfer occurred from the roof to the attic through the air channel. Also, air channel temperatures were higher than the attic temperature and not equal to them. Therefore, one can speculate that the maximum potential for heat transfer, into the attic, was not reached.

The temperature differences between the north roof and the attic were relatively large,

typically between 6 and 12°C. One may thus infer, as was done for the south roof slope, that there was a substantial amount of heat transfer to the attic, from the roof. One might subsequently infer an increase in attic temperature as a consequence of heat transfer and storage. The attic temperature did not, however, increase above the ambient air temperature. Therefore, again, there must have been a reduction in the heat gain that transferred from the roof to the attic.

For both channelled units, the temperature difference between the north roof and the air channel (both the EACN and the RACN) was much greater than the temperature difference between the air channel and the attic. Therefore, one may deduce that most of the heat gain from the roof was transferred into the air channel, but not into the attic. As in the south roof slope, the air channel acted as a heat sink which was constantly being replenished by heat from the steel roof.

As the ambient air and the roof were the sources of heat to the air channel one would have expected, as was anticipated for the south roof slope, that the air channel temperature would be equal to or higher than the ambient air temperature. This was typically the case for the EACN temperature. It was generally 0 to 2°C higher than the ambient air. For the RACN temperature, however, it was typically equal to or lower than the ambient air, by up to 2°C.

4.8.1. Heat transfer within the EACN, RACN, and ACN sections For the south roof it was speculated that heat reduction occurred via natural convection flow, within the air

channel, from the eave to the ridge. For the north roof slope the EACN temperature was generally higher than, or equal to, the RACN temperature, with the ambient air temperature falling in between the two. Therefore, one can infer that heat flowed from the ridge to the eave. This direction of flow (in other words, down the roof slope) is not consistent with the theory of natural convection flow. Natural convection will occur up inclined parallel plates, but not down them. Therefore, some other means, other than natural convection, caused heat reduction within the north roof slope. The fact remains, however, that heat reduction did occur.

4.8.2. The 40 versus 90 mm channelled north roof unit Comparison of the two channelled roof units reveals the observation that the EACN temperature was higher than the RACN temperature was more typical of the 90 mm channelled roof unit, and that the observation that the EACN and RACN temperatures were equal was more typical of the 40 mm channelled roof unit. Furthermore, the EACN, RACN, and attic temperatures for the 40 mm channelled roof unit generally lie in a range within the limits of the 90 mm unit's temperatures. Also, where the EACN temperature was higher than the RACN temperature in the 40 mm channelled roof unit, the temperature differences were less than those for the 90 mm unit. Therefore, as with the south roof slope, one can speculate that the 90 mm channelled roof unit was more effective in preventing attic heat build-up than the 40 mm unit.

The temperature difference between the attic and the roof was greater for the 40 mm channelled roof unit than for the 90 mm unit, typically by 1 to 2°C. From this, one might

infer that the 40 mm channelled roof unit was more effective than the 90 mm unit in preventing high attic temperatures. Again, this can be understood by the greater volume of the 90 mm channel, allowing for greater heat removal.

Overall, the attic temperature in the 90 mm channelled roof unit was typically 1 °C lower than that in the 40 mm. Therefore, the 90 mm air channel unit was more effective than the 40 mm air channel unit in preventing high attic temperatures; however, this prevention did not occur via natural convection within the air channel.

4.8.3. Observations correlated with wind data Upon examination, a trend appears when correlating temperature and wind data¹⁰. When the EACN temperature was higher than the RACN temperature, corresponding winds bearings were south, south-west, and south-south-west, between 15 and 39 km/hr. Figure 22 illustrates data from both ends of this wind speed range. In Figure 22a wind speeds ranging from 35 to 39 km/hr are illustrated. Figure 22b illustrates wind speeds ranging from 15 to 28 km/hr. When the wind was at least 15 km/hr bearing south, south-west, or south-south-west, it appears that the influence of wind on air flow within the channel was greater than that of natural convection. One may infer that convection flow occurred within the air channel, however, the presence of wind as a driving force for air flow indicates that this convection flow was forced, not natural.

¹⁰Wind summaries were obtained for analysis from Environment Canada (see Appendix E).

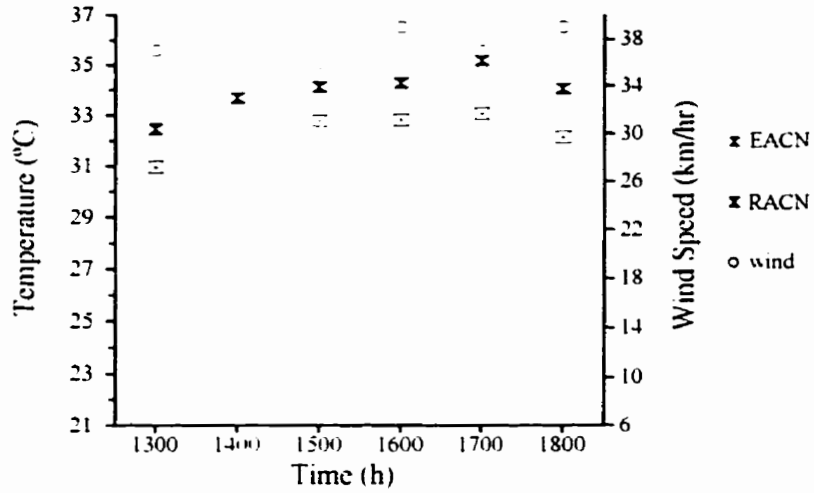

a) maximum wind speeds

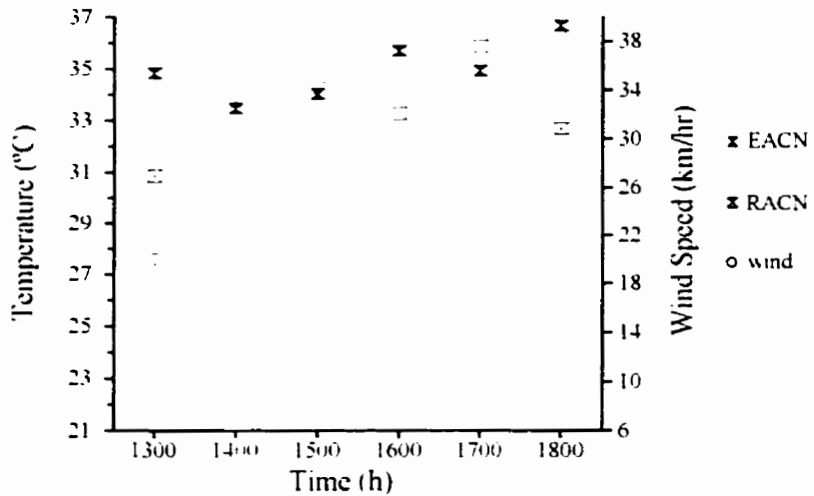

b) minimum wind speeds

Figure 22: a) Maximum and b) minimum air channel temperatures for the 90 and 40 mm channelled roof units, for 1997 06 09 and 06 10, respectively, illustrate the data for the extreme limits of influential wind speeds.

It should be noted that south and south-east winds did not appear to have a similar effect. Of the six days chosen for analysis, one day, 1997 08 24, had winds in the south,

south-east. and south-south-east direction. As Figure 23 illustrates, the overall trend of temperatures for this particular day followed that of the south roof slope. The EACN temperature was lower than the RACN temperature, and it appears that heat was removed by natural convection flow in the air channel.

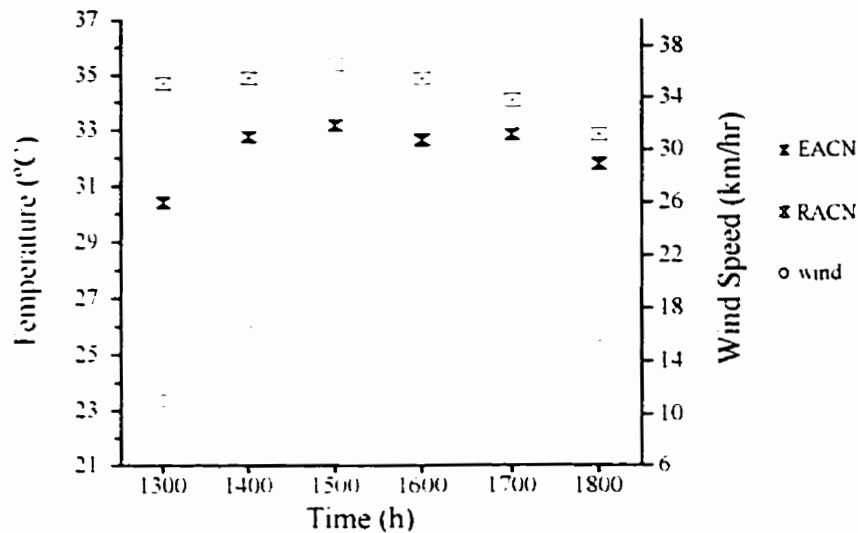
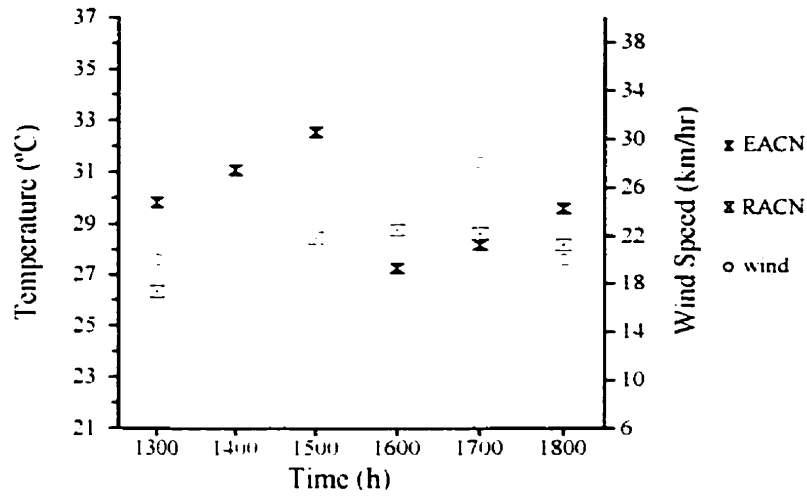

Figure 23: Air channel temperatures for the 40 mm channelled roof unit, for 1997 08 24, illustrate the trend of data for the channelled roof units corresponding to winds, south, south-east, and south-south-east.

When winds were more west than south, for example west-south-west, as for 1997 06 21, although wind speeds were moderate, 7 to 28 km/hr, temperature differences between the EACN and the RACN oscillated for both the 40 and 90 mm air channels (see Figure 24). Therefore, it was deduced that west winds did not have a large effect on air channel flow. The lack of correlation between wind and air flow may have been due to the

relatively low ambient air temperatures on this day, reaching a maximum of 30°C, as compared with other test days' maximums of 33 to 36°C.



a) 40 mm channelled roof unit

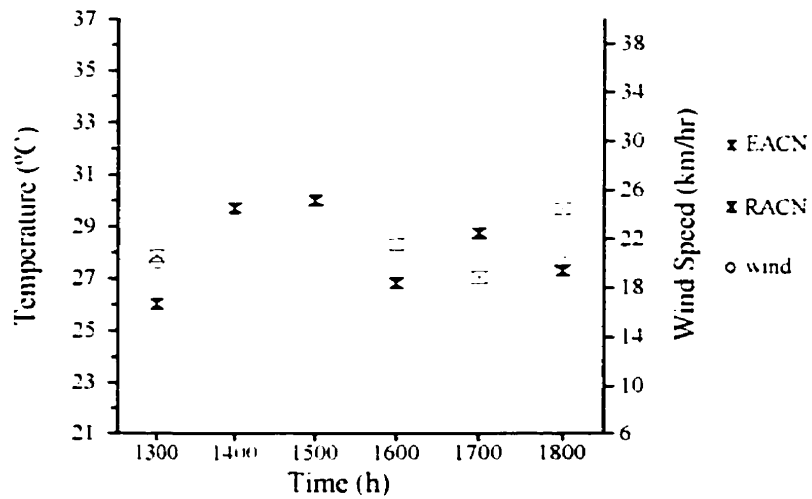

b) 90 mm channelled roof unit

Figure 24: Air channel temperatures for the a) 40 and b) 90 mm channelled roof units, for 1997 06 21, illustrate the trend of data for the channelled roof units corresponding to winds more west than south.

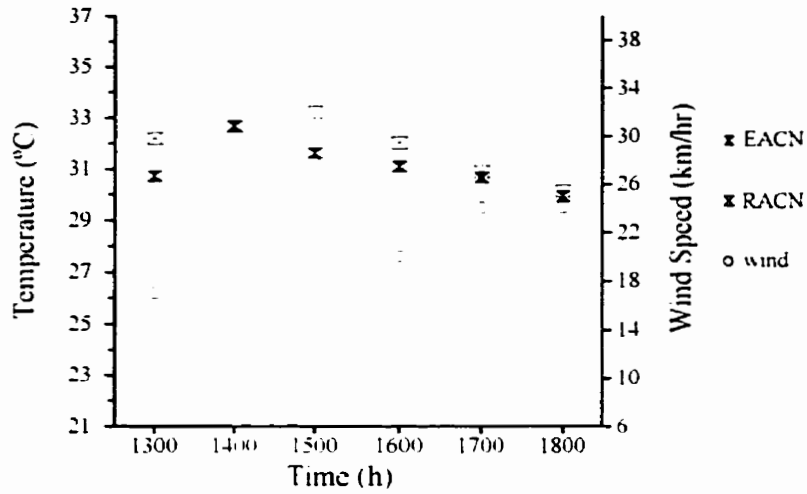

a) 40 mm channelled roof unit

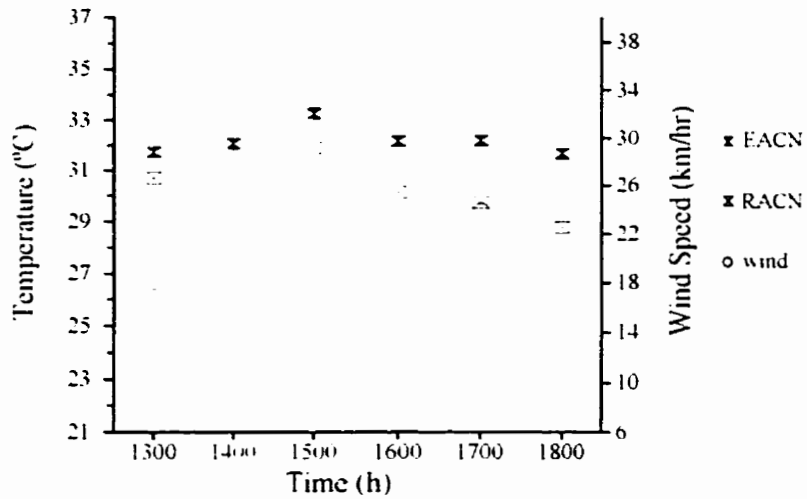

b) 90 mm channelled roof unit

Figure 25: Air channel temperatures for the a) 40 and b) 90 mm channelled roof units, for 1997 07 30, illustrate the trend of data for the channelled roof units corresponding to moderate winds, south, south-west, and south-south-west.

Based on the strong influence of winds on air flow within the air channel, additional analysis was warranted. Because only south, south-west, and south-south-west winds appeared influential, data from 1997 06 21 and 1997 08 24 were not included in the following analysis. Wind is defined as light, moderate, and strong by Environment Canada. Of the data chosen for analysis, wind was never "light". When wind was "moderate" or "strong", several observations can be made.

Between wind speeds of 17 to 24 km/hr, as for 1997 07 30 (see Figure 25) the EACN temperature was lower than the RACN temperature, in the 40 mm air channel. Therefore, it appears that air flow moved from the EAC section to the RAC section, natural convection flow having occurred. In the 90 mm air channel the EACN temperature was higher than the RACN temperature. It appears, then, that air flow occurred in the reverse direction. From this it can be deduced that air flow occurred due to wind and forced convection flow overpowered natural convection flow in the 90 mm air channel.

For the strong moderate wind speeds of 24 to 35 km/hr and 15 to 28 km/hr, as for 1997 08 07 and 1997 06 10, respectively (see Figure 26), the EACN temperature was at times higher than, and at times lower than, the RACN temperature in the 40 mm air channel. For the 90 mm air channel, the EACN temperature was higher than the RACN temperature. Thus it can be inferred, that for moderate winds, air flow occurred from the RACN section to the EACN section, and forced convection flow was dominant for the 90 mm air channel.

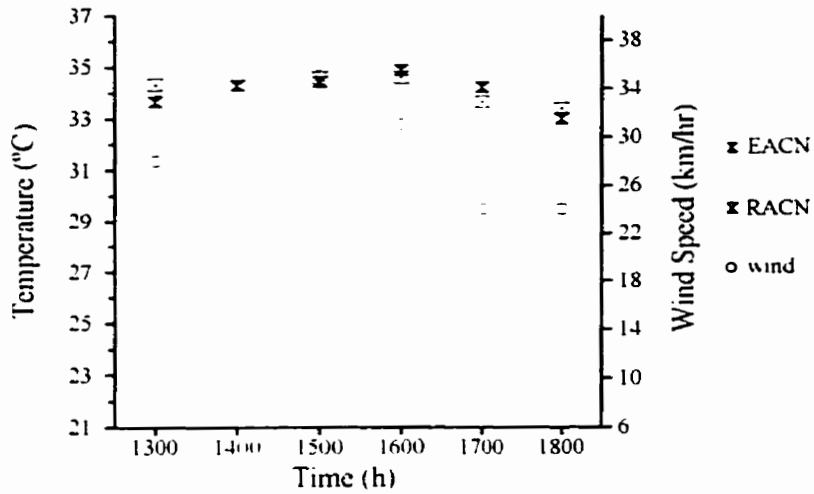

a) 40 mm channelled roof unit

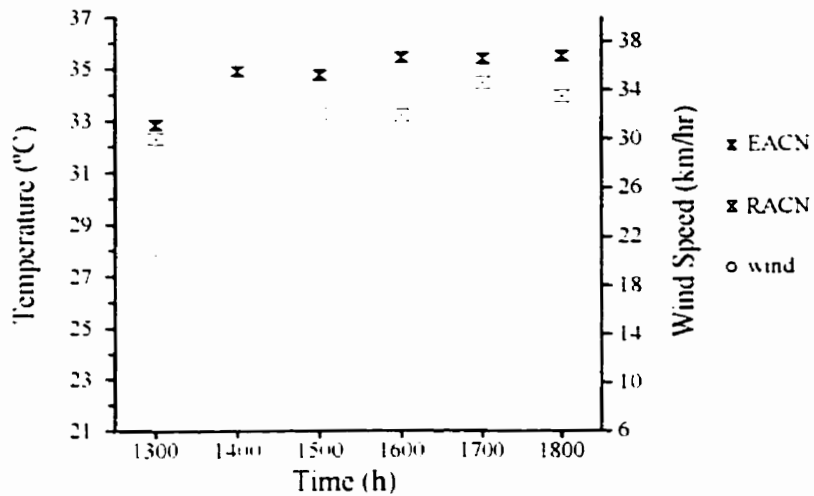

b) 90 mm channelled roof unit

Figure 26: Air channel temperatures for the a) 40 and b) 90 mm channelled roof units, for 1997 08 07 and 06 10, respectively, illustrate the trend of data for the channelled roof units corresponding to strong moderate winds, south to south-south-west.

When wind was "strong", as for 1997 06 09 when wind speed ranged from 35 to 39 km/hr, the EACN temperature was consistently higher than the RACN temperature

for both the 40 and 90 mm air channels (see Figures 27 and 22a). Therefore, it can be inferred that for strong winds, air flow occurred from the RACN section to the EACN section, and natural convection was overpowered by forced convection.

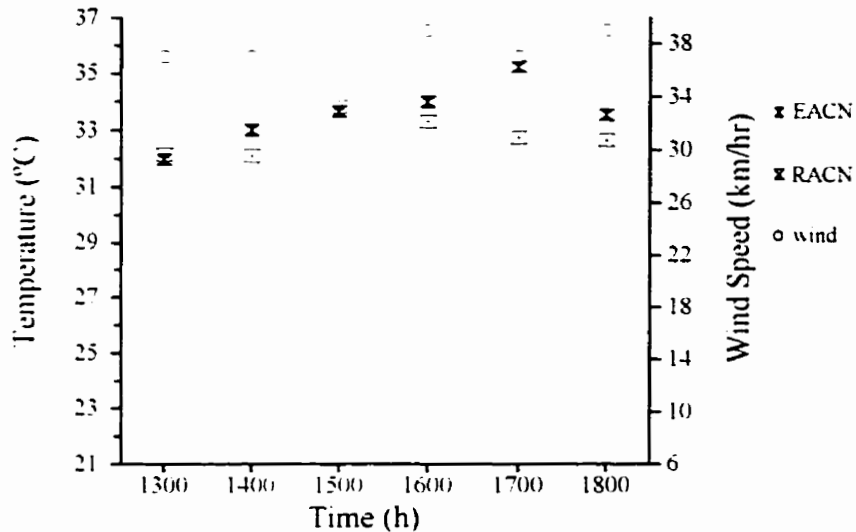

Figure 27: Air channel temperatures for the 40 mm channelled roof unit, for 1997 06 09, illustrate the trend of data for the channelled roof units corresponding to strong winds, south to south-south-west.

Overall, for the 40 mm air channel, as wind speed increased from moderate to strong, bearing south, south-west, or south-south-west, so too did its influence on air flow. For the 90 mm air channel, both moderate and strong winds consistently influenced air flow¹¹. Therefore, the 90 mm air channel was affected to a larger degree by wind bearing south, south-west, and south-south-west.

¹¹ It should be noted that no observations can be made regarding the influence of light wind on channel air flow.

4.8.4. Supporting evidence of wind effects from the *National Building Code of Canada*

Recall Figure 3, showing generalized pressure distributions due to wind around a gable-roof building. These are applied to the shape of the channelled units in Figure 28 to illustrate how wind, and subsequent pressure, might induce air flow within the north roof slope air channel. It can be seen from the enlarged view of the eave section that the air flow down the north roof slope may have been caused by negative pressure, or suction, at the eave. This suction could have been produced by a combination of air flow out of the soffit vents, eddying underneath the soffit due to edge effects, and pressure of in-line vectors from the north roof and the wall.

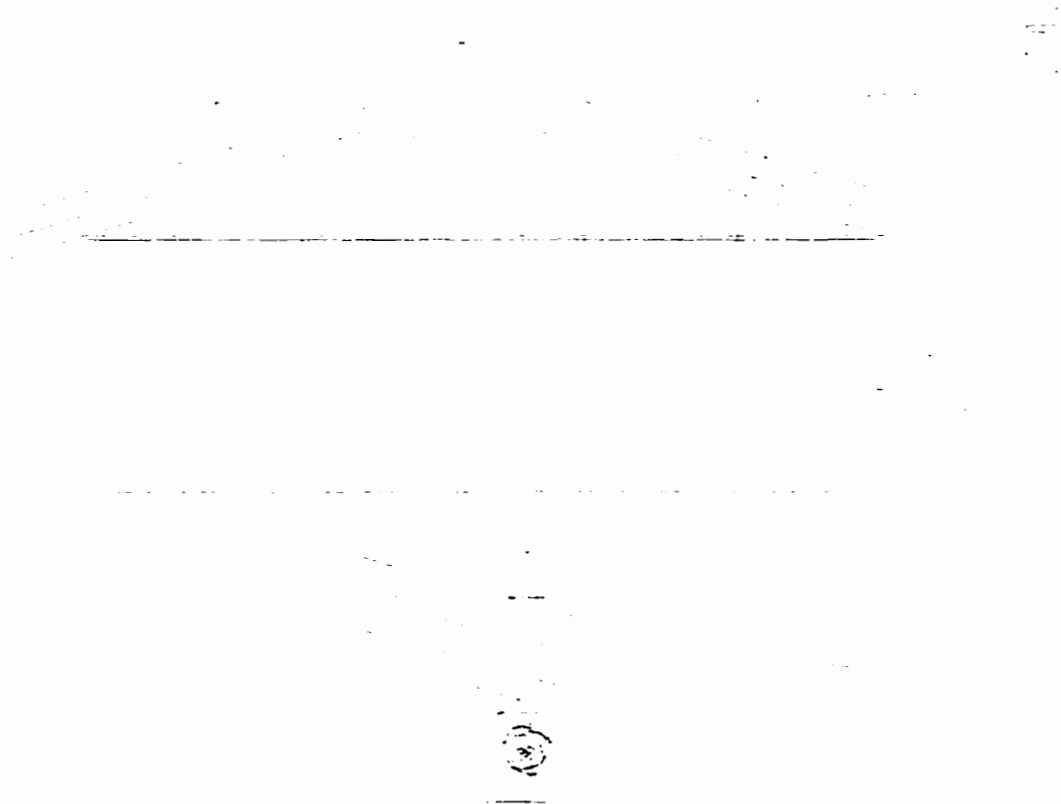

Figure 28 Side view of channelled roof unit illustrating wind and pressure patterns which may have induced negative pressure at the north eave.

Other supporting evidence shows that the velocity of the exhaust air, from the plenum of a double roof, appears to be more sensitive to wind speed than to ambient air temperature or insolation (Faris 1982). Faris also observed that the highest velocities of exhaust air coincided with wind gusting. As a further explanation of the path of flow within the air channels, referring back to the data, it was observed that the RACS temperature did not equal that of the RACN. Furthermore, it was observed that the RACN temperature did not equal that of the ambient air. Therefore, it seems that a short circuit of the air flow occurred at the ridge. This is depicted in Figure 29.

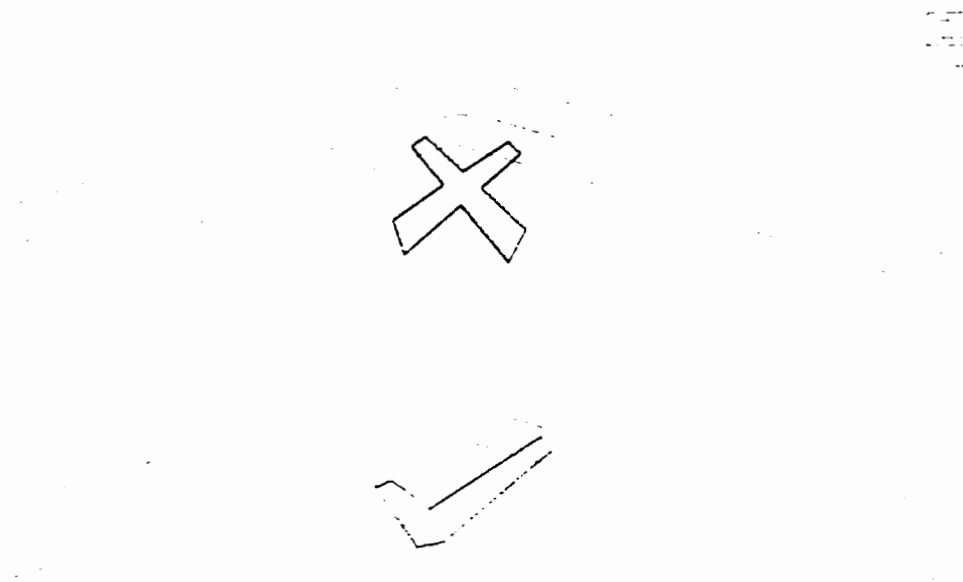

Figure 29 Side view of channelled roof unit illustrating surmised path of air flow within the air channels.

5. CONCLUSIONS

Based on the research reported herein, the following conclusions can be drawn:

- 1 an open-ended air channel at a building's roof will reduce solar heat gain into the building
- 2 during periods of high ambient air temperatures, attics of the channelled roof units were, at minimum, 1 °C lower than the attic of the control unit
- 3 the 90 mm deep channelled roof unit was more effective than the 40 mm deep channelled roof unit in reducing solar heat gain: the former was consistently 1 °C lower than the latter
- 4 the south and north roof channels behaved differently: flow which occurred in the south roof channel appeared to be due to natural convection, flow which occurred in the north roof channel appeared to be due to forced convection
- 5 the 90 mm channel was more influenced by wind than the 40 mm channel

6. RECOMMENDATIONS

In this study, the effectiveness of an open-ended roof channel for reducing attic temperatures was determined. Recommendations for further study are as follows:

- 1 monitor the temperatures of data points on the walls of the test units
- 2 re-size the test units to ensure a more representative scale; at present wall area is much greater than the roof area and the length is much greater than the width
- 3 insulate the walls to reduce solar gain through the walls
- 4 monitor the temperatures of a greater number of data points in the attic, the ceiling, and the room of the test units to gain a more comprehensive representation of the temperature gradients and heat transfer patterns
- 5 monitor the air flow in the roof channels to determine the actual flow patterns
- 6 determine the influence on convection flow of increasing the air channel depth
- 7 determine the influence on convection flow of changing the sizes of the channel openings
- 8 determine the influence on convection flow of increasing the roof slope
- 9 determine the influence on convection flow of increasing the roof length
- 10 re-design the ridge cap to take advantage of the influence of negative wind pressure to increase convection flow

REFERENCES

- Argue, R. 1980. *The Well-Tempered House: Energy-Efficient Building for Cold Climates*. Toronto, ON: Renewable Energy in Canada.
- Anderson, B. 1977. *Solar Energy: Fundamentals in building design*. New York, NY: McGraw-Hill Book Company.
- ASHRAE. *Handbook: Heating, Ventilating, and Air Conditioning: Systems and Equipment*. 1996. Atlanta, GA: American Society of Heating, Refrigeration and Air-Conditioning Engineers, Inc.
- ASHRAE. *Handbook: Fundamentals*. 1993. Atlanta, GA: American Society of Heating, Refrigeration and Air-Conditioning Engineers, Inc.
- ASHRAE. *Standard 55-92: Thermal Environmental Conditions for Human Occupancy*. 1992. Atlanta, GA: American Society of Heating, Refrigeration and Air-Conditioning Engineers, Inc.
- Austic, R. E. 1985. Chapter 4: Feeding Poultry in Hot and Cold Climates. In *Stress Physiology in Livestock: Volume III: Poultry*, ed. M.K. Yousef, 123-136. Boca Raton, FL: CRC Press, Inc.
- Bligh, J. A. 1985. Chapter 8 Temperature Regulation. In *Stress Physiology in Livestock: Volume I: Basic Principles*, ed. M.K. Yousef, 75-96. Boca Raton, FL: CRC Press, Inc.
- Bourke, P. Energy-Efficient Cathedral Ceilings. *Journal of Light Construction* February 1997:26-29.
- Bowen, A. 1984. Design Guidelines on Vertical Airflow in Buildings and Urban Areas. In *Passive and Low Energy Ecotechniques, Proceedings of the Third International PLEA Conference*, ed. A. Bowen and S. Yannas, 178-209. Mexico City, Mexico. August 6-11, 1985. Oxford, England: Pergamon Press.
- Cook, J. 1984. *Award-Winning Passive Solar Designs: Professional Edition*. New York, NY: McGraw-Hill Book Company.
- Curtis, S. E. 1985. Chapter 9 Physiological Responses and Adaptations of Swine. In *Stress Physiology in Livestock: Volume II: Ungulates*, ed. M.K. Yousef, 129-139. Boca Raton, FL: CRC Press, Inc.

- Cushman, T. 1996. Vented vs. Unvented Roofs: The Great Debate. *Journal of Light Construction* January 1996:41-44.
- Dufie, J. A. and W.A. Beckman. 1974. *Solar energy thermal processes*. New York, NY: John Wiley and Sons.
- Faris, R. 1982. Natural Double Roof Cooling in Three Climates. In *Passive and Low Energy Alternatives I, The First International PLEA Conference*, ed. A. Bowen and R. Vagner, 4.1-4.7. Bermuda. September 13-15, 1982. New York, NY: Pergamon Press.
- Hahn, L. C.F. Kelly, A.A. McKillop, and T.E. Bond. 1962. The relation of roof size to temperatures of irradiated metal roof sections exposed to forced convection. ARS-42 ARS, USDA. Beltsville, MD: U.S. Department of Agriculture.
- Heyer, O. C. 1963. Study of temperature in wood parts of houses throughout the United States. Res. Note-012. Department of Agriculture, Forest Service, Forest Products Laboratory. Madison, Wisconsin: U.S. Department of Agriculture, Forest (cited in Walker and Wooste 1992).
- Incropera, F. and D. Dewitt. 1990. *Fundamentals of Heat and Mass Transfer: 3rd Edition*. New York, NY: John Wiley and Sons.
- Johnson, H.D. 1985. Chapter I: Physiological Responses and Productivity of Cattle. In *Stress Physiology in Livestock: Volume II: Ungulates*, ed. M.K. Yousef, 3-23. Boca Raton, FL: CRC Press, Inc.
- Karaman, A. 1983. The ecology of the vernacular housing in turkey toward designing for "Locus". In *Passive and Low Energy Alternatives, Proceedings of the Second International PLEA Conference*, ed. S. Yannas, 273-280. Rethimnon, Crete. June 28-July 1, 1983. Oxford, England: Pergamon Press.
- Karamchandani, A. and N. Amin. 1983. Ventilation and landscaping: design implication for hot humid climates. In *Passive and Low Energy Alternatives, Proceedings of the Second International PLEA Conference*, ed. S. Yannas, 491-498. Rethimnon, Crete. June 28-July 1, 1983. Oxford, England: Pergamon Press.
- Kays, W. M. and M.E. Crawford. 1993. *Convective Heat and Mass Transfer: 3rd Edition*. New York, NY: McGraw-Hill, Inc.
- Kennedy, W.K. 1978. Central Africa: An appraisal of solar building prospects in Central Africa. In *Solar technology for building, Proceedings of the First International Conference on Solar building technology*, ed. C. Stambolis, 554-558. The Royal

- Institute of British Architects, London. July 25-29, 1977. London, England: RIBA Publications Limited.
- Kleiber, M. 1975. *The Fire of Life: an introduction to animal energetics*. Huntington, NY: Robert E. Krieger Publishing Company.
- Lear, Jr., W.E., T.E. Barrup, and K.E. Davis. Preliminary Study of a Vented Attic Radiant Barrier System in Hot, Humid Climates, Using Side-By-Side, Full-Scale Test Houses. In *Proceedings of the 12th Passive Solar Conference*, ed. D.A. Andrejko and J. Hayes, 240-244. July 11-16, 1987. Portland, OR: American Solar Energy Society, Inc
- National Building Code of Canada 1995*. 1995. Associate Committee on the National Building Code, National Research Council of Canada. Ottawa: ON: National Research Council of Canada
- Sklar, S and K. Sheinkopf. 1991. *Consumer Guide to Solar Energy: Easy and Inexpensive Applications for Solar Energy*. Chicago, IL: Bonus Books, Inc.
- Solar Heat and The Overheating of Buildings*. 1975. Directorate of Building Development, Department of the Environment, Property Services Agency. London, England: Her Majesty's Stationery Office
- Supplement to the National Building Code of Canada 1995*. 1995. Associate Committee on the National Building Code, National Research Council of Canada. Ottawa: ON: National Research Council of Canada.
- Teeter, N.C., J.A. DeShazer, and T.L. Thompson. 1973. Operational characteristics of meat animals: Part I - Swine, Part II - Beef, Part III - Broilers, and Part IV - Turkeys. Transactions of the ASAE. 16(1):157-159, 16(4):740-742, 16(6):1165-1167-, and 19(4):724-727, respectively. St. Joseph, MI: American Society of Agricultural Engineers.
- Thwaites, C.J. 1985. Chapter 2: Physiological Responses and Productivity in Sheep. In *Stress Physiology in Livestock: Volume II: Ungulates*, ed. M.K. Yousef, 25-38. Boca Raton, FL: CRC Press, Inc.
- Walker, J and R.E. Wooste. 1992. *Post Frame Building Design*. ASAE, Monograph No. 11. St. Joseph, MI: American Society of Agricultural Engineers.
- Yousef, M.K. 1985. Chapter 7: Thermoneutral Zone. In *Stress Physiology in Livestock: Volume I: Basic Principles*, ed. M.K. Yousef, 67-74. Boca Raton, FL: CRC Press, Inc

APPENDICES

APPENDIX A: THERMONEUTRAL ZONE OF SOME UNGULATES

Table A-1 Thermoneutral Zone (TNZ) of Some Ungulates Expressed in Terms of Ambient Temperature (adapted from Yousef 1985).

	Animal	TNZ (°C)
cattle:	calf	13 to 25
	cow	0 to 16
sheep:	newborn lamb	29 to 30
	ewe	-2 to 20
swine:	piglet	32 to 33
	sow	0 to 15
goats:	Egyptian Araby (desert), adult	20 to 30
	Egyptian Zariaby (Nile Delta), adult	10 to 25

APPENDIX B: DETAILED DRAWINGS OF EXPERIMENTAL DESIGN

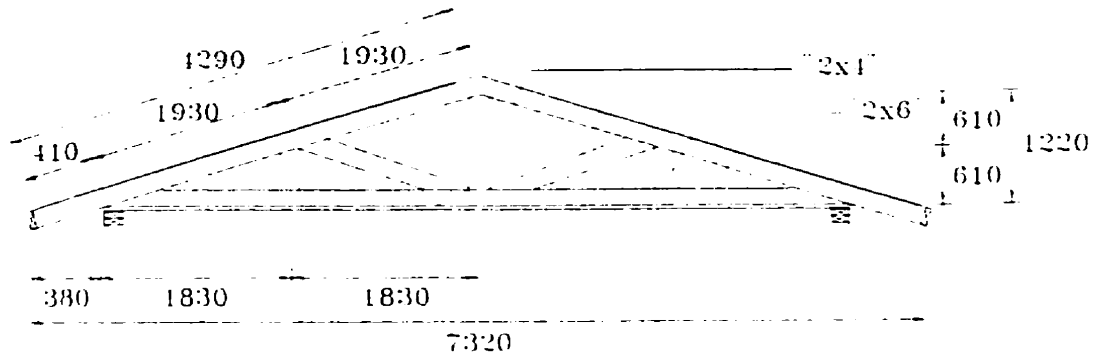

Figure B-1 Interior truss drawing of test units indicating dimensions (in mm) and materials.

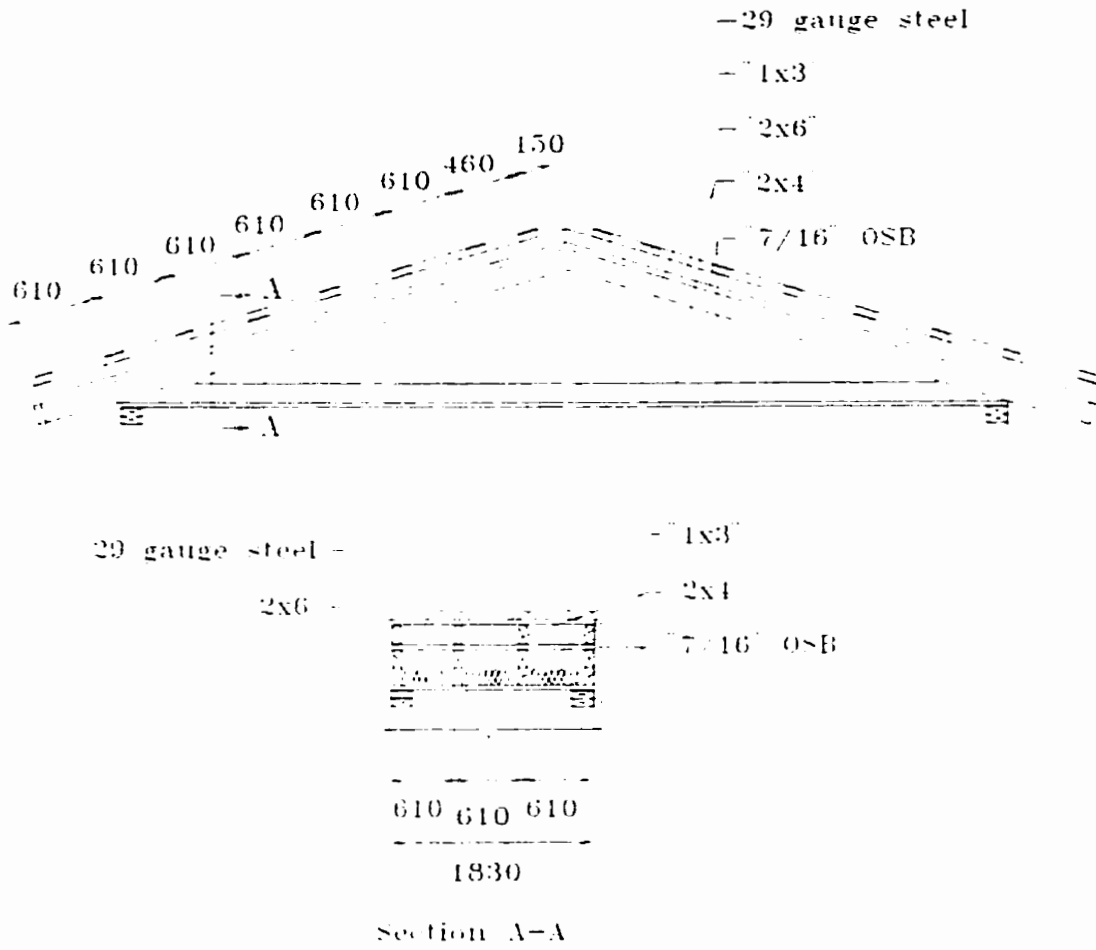

Figure B-2 Channelled roof drawing indicating dimensions (in mm) and materials.

APPENDIX C: SAMPLE OF TABULATED AVERAGE DATA

Table C-1 Average temperature measurements ($^{\circ}\text{C}$) for 1997 06 09¹².

Time (h)	Thermocouple Number				
	1	2	3	4	5
0100	19.30	19.30	19.90	18.90	18.53
0200	18.33	18.33	19.00	18.17	17.80
0300	18.00	18.03	18.60	17.57	17.30
0400	17.80	17.90	18.37	17.20	17.00
0500	17.77	17.87	18.17	16.87	16.77
0600	17.87	17.43	17.63	16.53	16.43
0700	19.77	18.30	18.20	17.30	17.57
0800	23.87	22.80	20.80	19.57	20.53
0900	28.13	27.80	23.70	22.43	23.63
1000	31.60	31.90	26.27	24.53	25.73
1100	32.70	33.23	28.03	26.00	27.27
1200	34.93	35.63	29.20	26.53	27.87
1300	37.50	38.80	30.17	26.57	27.80
1400	38.37	39.50	31.07	26.60	27.90
1500	39.20	40.40	31.63	27.10	28.60
1600	38.70	38.87	32.03	27.60	29.00
1700	38.10	37.33	32.37	27.53	28.60
1800	37.23	35.83	31.73	26.90	27.80
1900	34.33	32.37	30.70	26.23	27.20
2000	32.27	29.57	29.40	25.77	26.57
2100	28.30	27.37	27.70	24.90	25.40
2200	24.83	24.83	25.50	23.53	23.63
2300	23.27	23.30	23.90	22.40	22.30

¹²All data were compiled on a 3.5 inch diskette using Quattro Pro 8.0.

Average temperature measurements (C) for 1997 06 09. continued ...

Time (h)	Thermocouple Number								
	6	7	8	9	10	11	12	13	14
0100	19.67	19.40	19.90	19.73	19.33	19.73	20.20	19.50	18.90
0200	18.70	18.40	18.83	18.77	18.30	18.67	19.20	18.53	18.03
0300	18.33	18.07	18.50	18.37	18.07	18.50	18.73	17.87	17.47
0400	18.13	17.90	18.30	18.20	17.90	18.27	18.40	17.43	17.20
0500	17.97	17.80	18.13	18.03	17.80	18.13	18.17	17.03	16.83
0600	18.00	17.87	17.60	17.50	17.37	17.47	17.60	16.70	16.47
0700	19.43	19.97	18.40	18.30	18.57	17.97	17.93	16.80	16.80
0800	22.10	23.80	20.83	21.17	22.33	20.30	19.73	17.30	17.60
0900	25.03	27.20	23.67	24.47	26.77	22.80	22.33	18.43	19.27
1000	27.83	31.17	26.53	27.60	31.37	25.37	24.73	20.20	21.23
1100	29.47	32.03	28.17	29.07	32.47	26.87	26.57	22.70	24.00
1200	31.10	34.23	29.53	30.47	34.57	27.97	27.70	24.33	25.80
1300	32.47	36.60	30.97	32.23	37.60	29.20	28.50	24.93	26.40
1400	33.70	37.50	31.63	32.80	37.53	30.00	29.47	25.47	26.90
1500	34.13	39.30	32.80	34.23	40.00	31.00	30.27	26.60	28.40
1600	34.30	38.50	32.83	33.70	38.10	31.17	30.90	27.90	29.80
1700	35.20	38.23	33.07	33.73	36.70	31.77	31.47	29.00	30.73
1800	34.07	37.07	32.13	32.50	35.23	30.97	31.20	29.57	31.00
1900	32.57	34.43	31.03	30.97	32.20	30.37	30.63	29.67	30.80
2000	31.17	32.00	29.60	29.47	29.50	29.17	29.73	29.13	30.03
2100	28.80	28.50	27.80	27.60	27.40	27.47	28.10	27.63	28.00
2200	25.53	25.07	25.47	25.27	24.90	25.17	25.90	25.30	24.83
2300	23.87	23.47	23.87	23.70	23.30	23.60	24.30	23.50	23.00

Average temperature measurements (C) for 1997 06 09, continued ...

Time (h)	Thermocouple Number									
	15	16	17	18	19	20	21	22	23	24
0100	19.47	19.23	19.87	19.70	19.30	19.70	20.30	19.83	20.43	19.00
0200	18.47	18.23	18.87	18.77	18.30	18.73	19.40	19.00	19.53	17.93
0300	18.07	17.87	18.47	18.30	17.97	18.40	18.87	18.40	18.93	17.73
0400	17.93	17.73	18.27	18.17	17.90	18.30	18.60	18.10	18.60	17.67
0500	17.73	17.60	18.10	18.07	17.80	18.17	18.37	17.73	18.27	17.77
0600	17.73	17.83	17.83	17.50	17.37	17.50	17.80	17.30	17.80	17.97
0700	19.17	20.33	18.83	18.37	18.40	18.00	18.10	17.60	18.07	20.20
0800	21.43	24.50	21.60	21.83	22.67	20.40	20.07	18.60	18.90	23.57
0900	24.97	28.87	24.43	25.67	27.43	23.10	22.87	20.57	20.83	26.57
1000	27.37	32.60	27.17	28.80	31.63	25.70	25.20	22.90	23.20	28.77
1100	29.40	33.40	28.43	30.27	32.50	27.23	26.93	25.93	26.13	29.40
1200	30.00	36.10	30.27	32.00	34.97	28.33	27.97	27.60	27.30	30.37
1300	31.97	38.97	32.13	34.33	38.40	29.77	28.80	28.00	27.80	31.47
1400	33.00	39.60	32.10	34.83	38.27	30.47	29.73	28.60	28.37	32.13
1500	33.67	41.17	33.83	36.20	40.67	31.57	30.60	29.77	29.87	33.33
1600	34.00	40.13	33.30	35.13	38.33	31.53	31.20	30.70	30.80	33.47
1700	35.23	39.23	32.73	34.83	37.37	32.07	31.77	30.53	30.77	34.57
1800	33.53	38.60	32.63	33.47	35.57	31.23	31.50	29.83	30.07	33.97
1900	32.23	35.37	31.37	31.50	32.33	30.47	30.73	29.03	29.30	32.37
2000	30.97	32.97	30.17	29.60	29.57	29.23	29.70	28.27	28.70	29.90
2100	28.70	28.77	28.03	27.70	27.47	27.57	28.10	27.10	27.60	27.83
2200	25.10	24.90	25.50	25.27	24.83	25.13	26.03	25.27	25.83	24.43
2300	23.50	23.30	23.87	23.73	23.17	23.50	24.43	23.80	24.37	22.83

APPENDIX D: WEATHER SUMMARIES FOR DAY CHOSEN FOR ANALYSIS

Table D-1. Written weather description for days chosen for analysis (adapted from Environment Canada monthly meteorological summaries for June, July, and August 1997).

Date	Description
1997 06 09	Sunny. Temperatures well above normal. Winds moderate, occasionally strong late morning to late afternoon.
1997 06 10	Sunny. Maximum temperature well above normal, minimum above normal. Winds light to moderate overnight, decreasing to light by early evening.
1997 06 21	Sunny, becoming cloudy with showers and thundershowers late afternoon to mid evening. Maximum temperature slightly above normal, minimum near normal. Winds light, occasionally moderate during thunderstorms.
1997 07 30	Mainly sunny. Maximum temperature slightly above normal, minimum slightly below normal. Winds light except for a period of moderate late afternoon to early evening.
1997 08 07	Mainly sunny. Maximum temperature well above normal, minimum above normal. Winds light increasing to moderate by noon.
1997 08 24	Mainly sunny, becoming overcast early evening. Maximum temperature above normal, minimum near normal. Winds light, increasing to moderate mid evening.

APPENDIX E: ALL GRAPHS FROM THE RESULTS AND DISCUSSION SECTION, GENERATED FOR 1997 06 09¹³

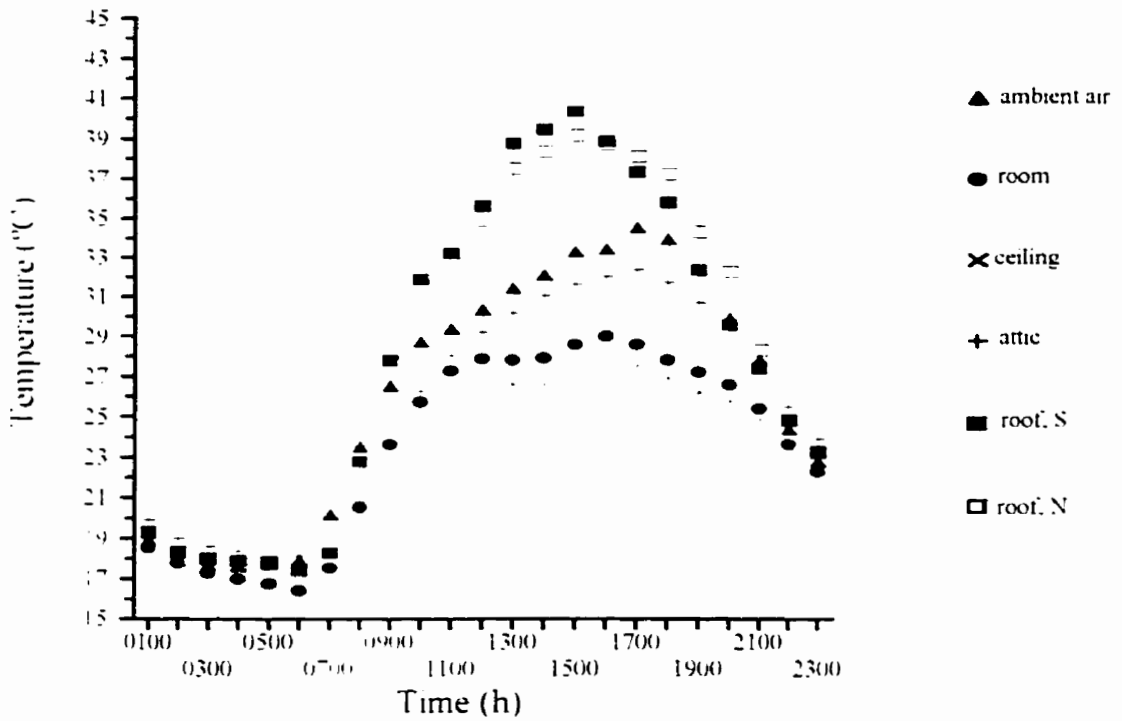

Figure E-1 Temperatures for the control unit illustrate the general trend of data for each of the test units, and each of the tests. The perforated lines indicate periods of interest for purposes of analysis.

¹³All graphs were generated from data compiled on a 3.5 inch diskette using Quattro Pro 8.0.

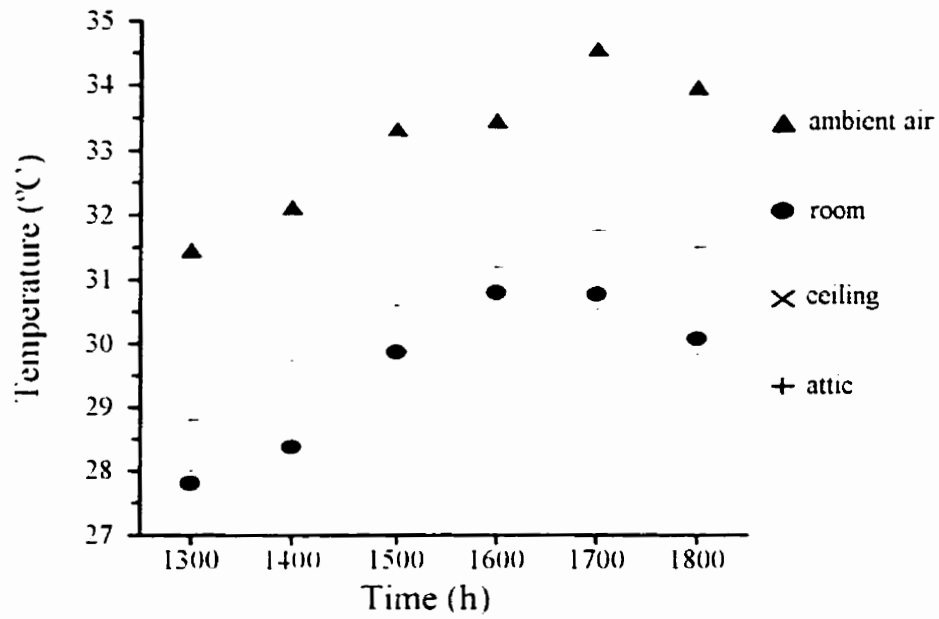
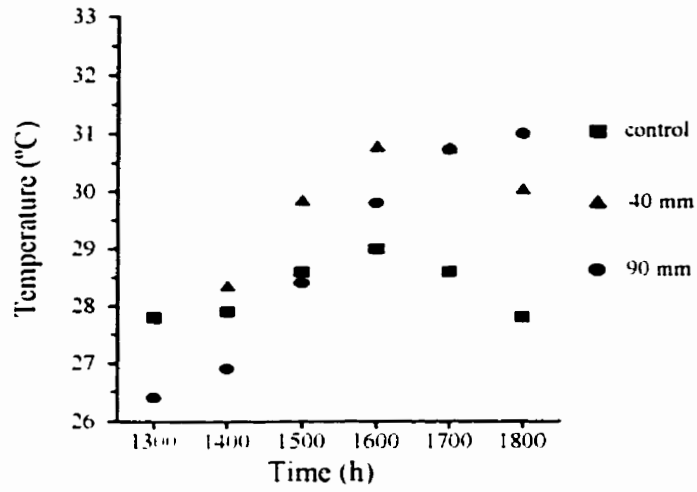
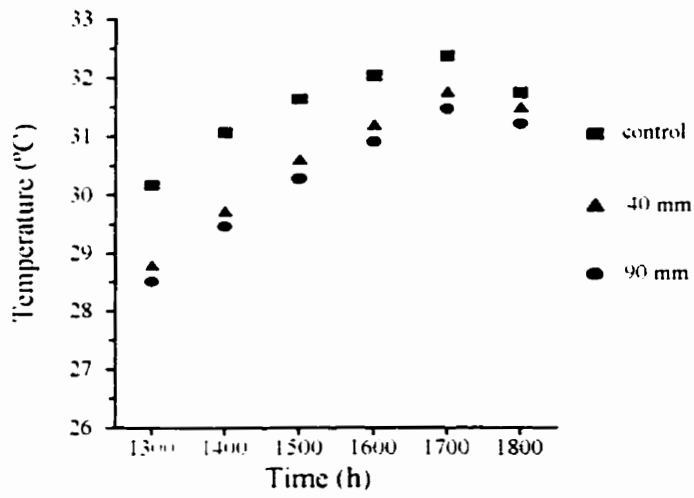

Figure E-2: Temperatures for the 40 mm channelled roof unit illustrate the general relative trend of data between the ceiling, the attic, and the room for each of the test units, and each of the tests.



a) room temperatures



b) attic temperatures

Figure E-3: a) Room and b) attic temperatures for all three test units illustrate the general relative trend of data between the test units, for each of the tests.

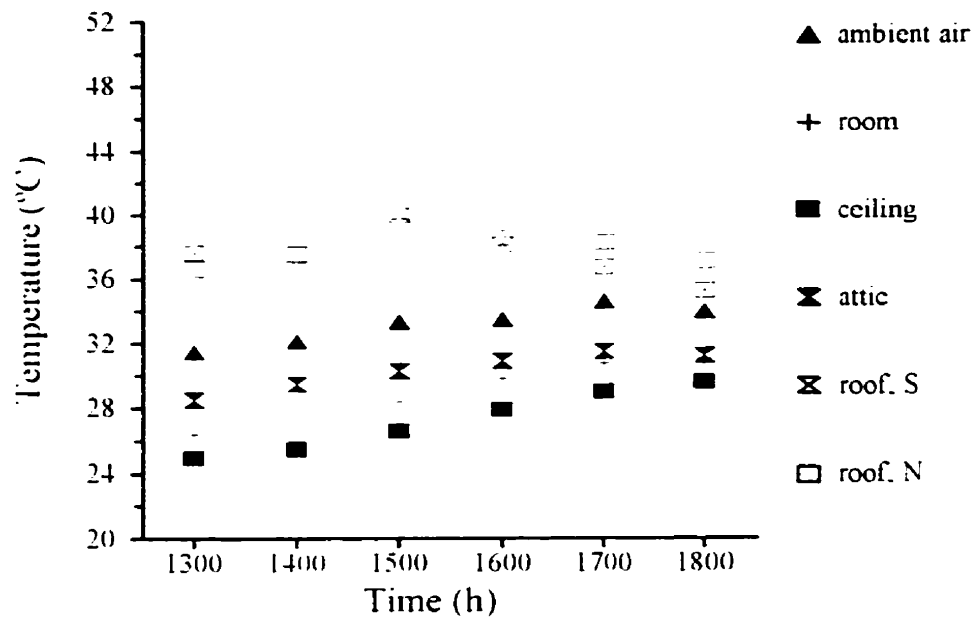

Figure E-4: Temperatures for the 90 mm channelled roof unit illustrate the general trend of temperature differences for each of the test units, and each of the tests.

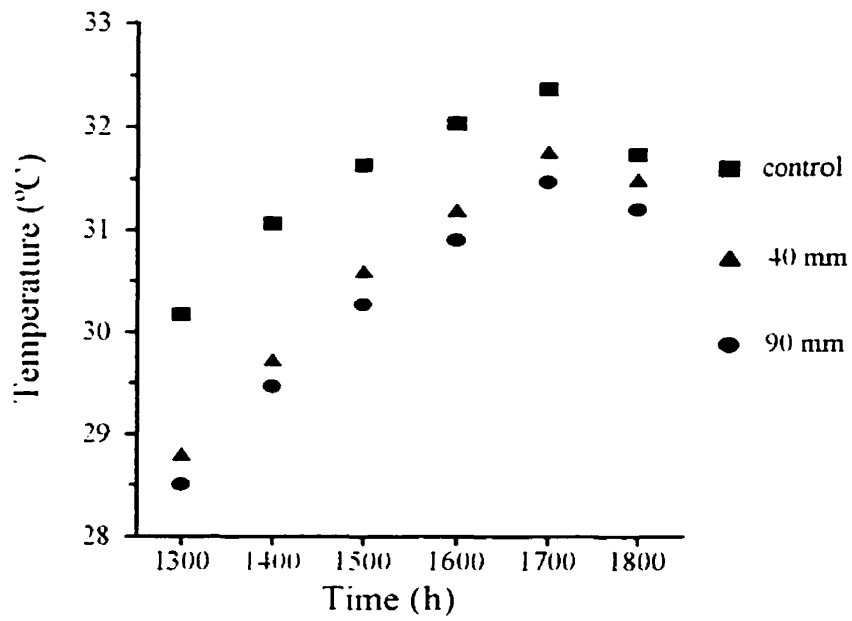

Figure E-5: Attic temperatures for all three test units illustrate the general relative trend of data between the test units, for each of the tests.

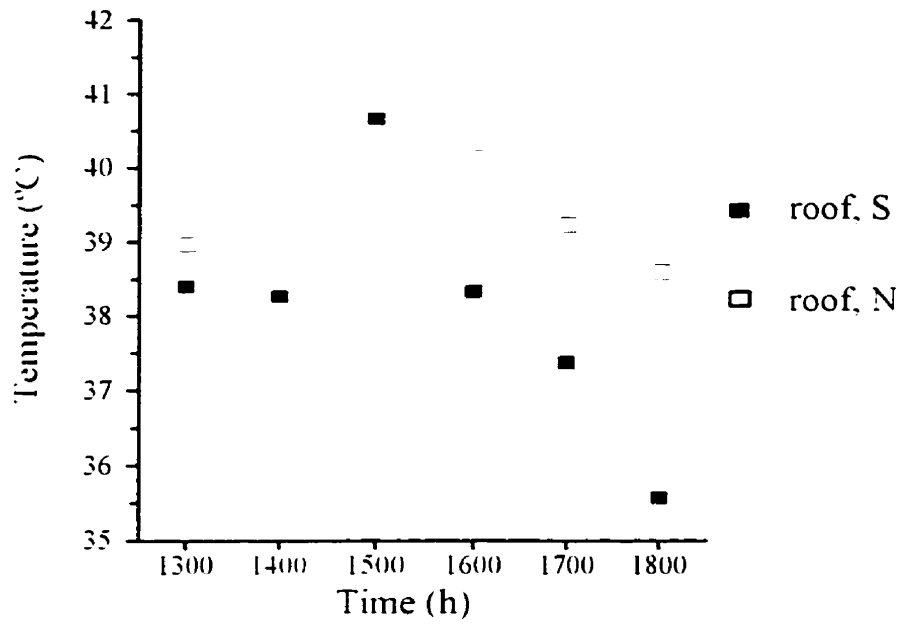

Figure E-6: South and north roof temperatures for 40 mm channelled roof unit illustrate the general relative trend of data between the test units, for each of the tests.

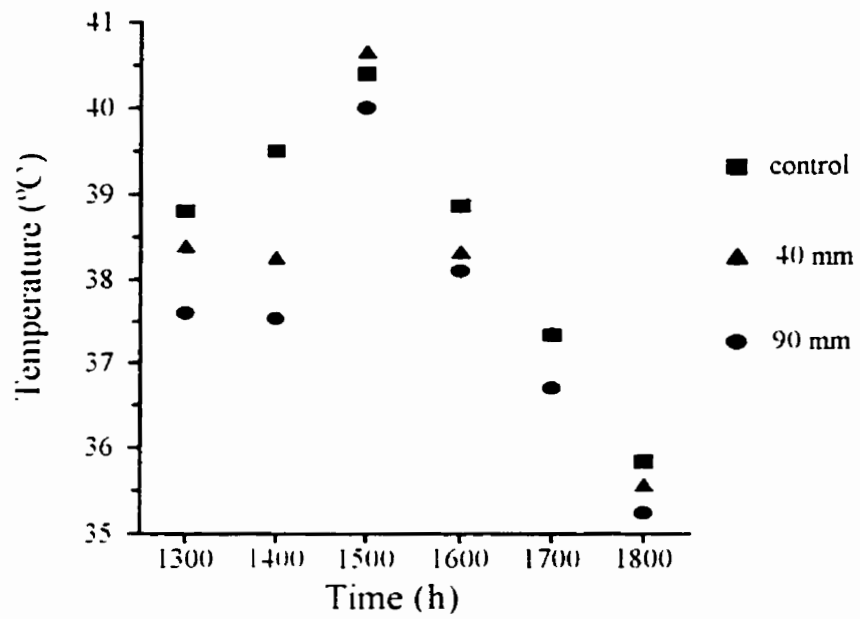

Figure E-7: South metal roof temperatures for all three test units illustrate the general relative trend of data for each of the test units and each of the tests.

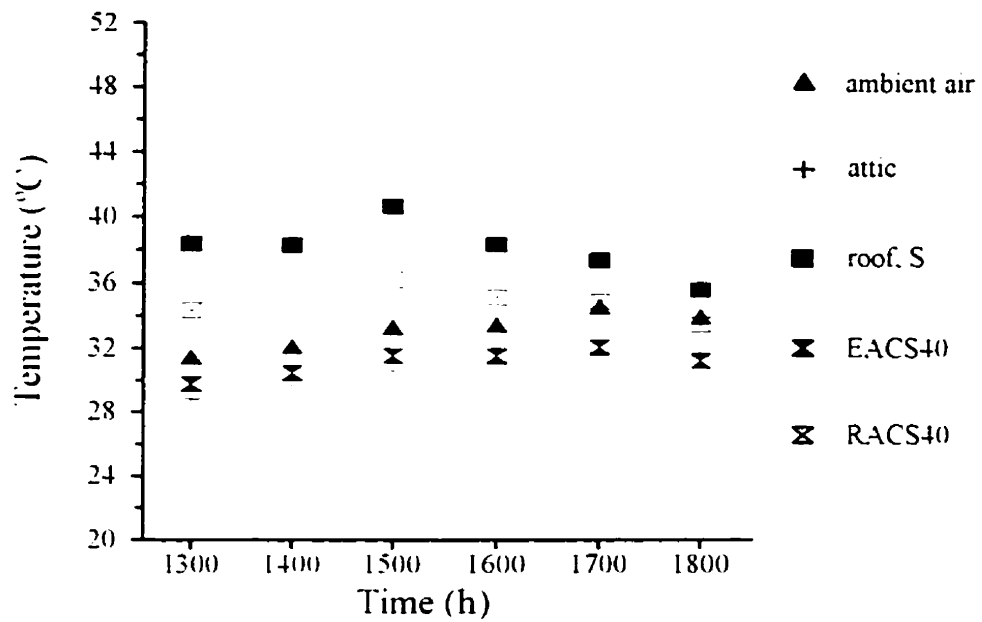

Figure E-8: Temperatures for the 40 mm channelled roof unit illustrate the general relative trend of data between the ambient air, the roof, the EACS40, the RACS40, and the attic for the channelled roof units, and each of the tests.

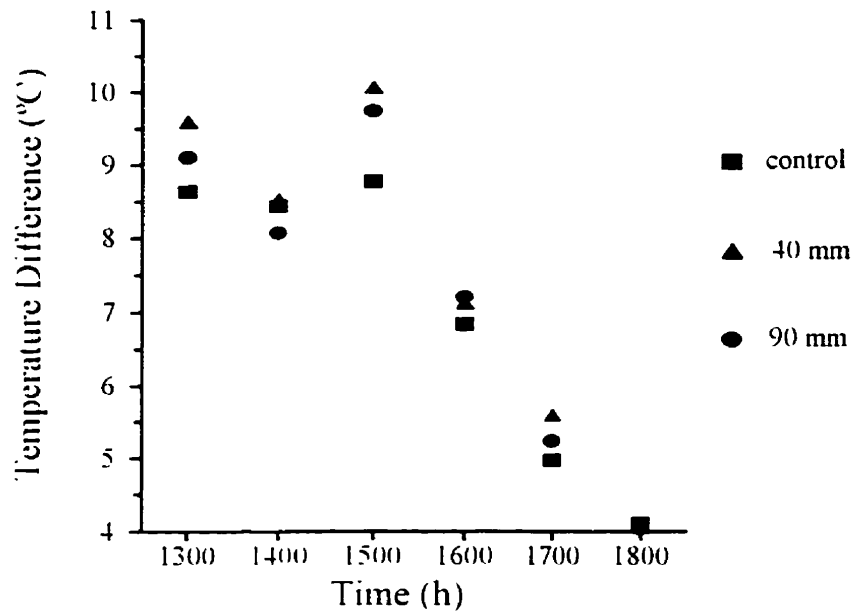

Figure E-9: Temperature differences between the south roof and the attic for all three test units illustrate the general trend of data for each of the test units, and each of the tests.

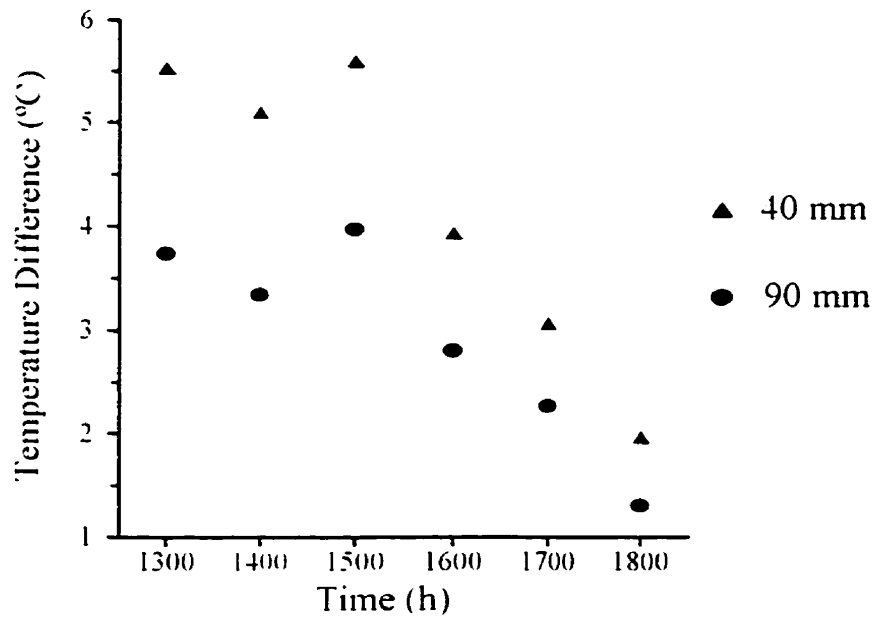

Figure E-10: Temperature differences between the RACS and the attic for the channelled roof units illustrate the general trend of data for the channelled roof units, and each of the tests.

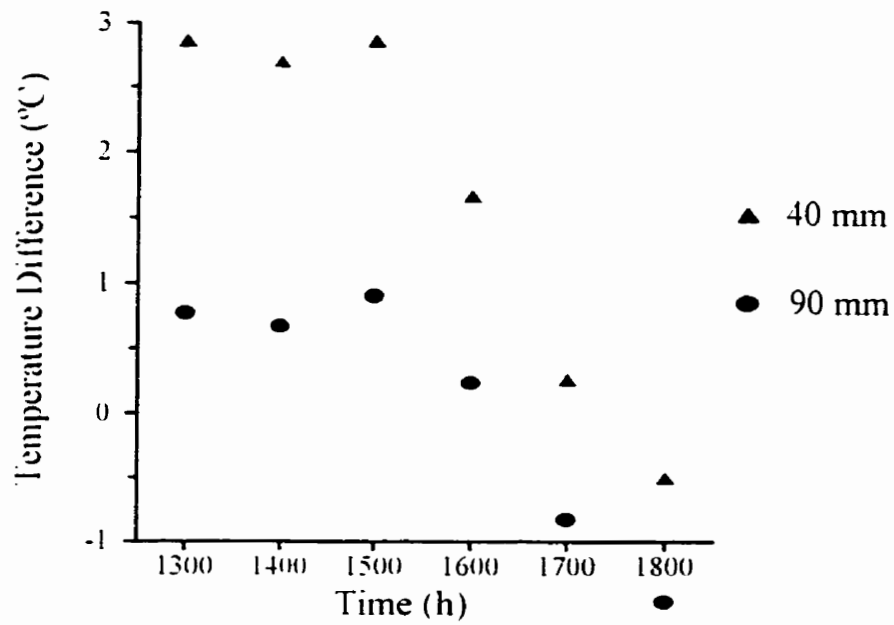

Figure E-11: Temperature differences between the RACS and the ambient air for the channelled roof units illustrate the general trend of data for the channelled roof units, and each of the tests.

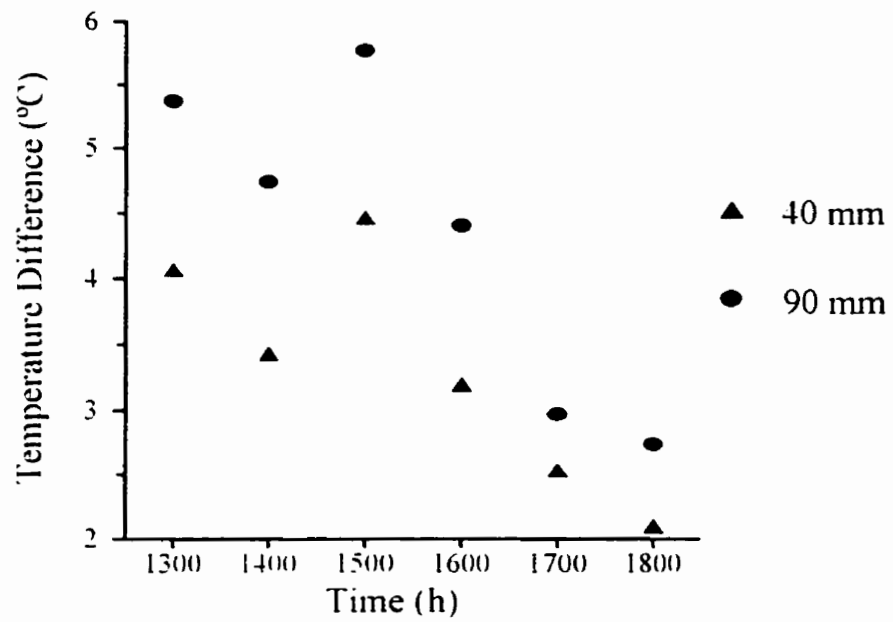

Figure E-12: Temperature differences between the RACS and the south roof for the channelled roof units illustrate the general trend of data for the channelled roof units and each of the tests.

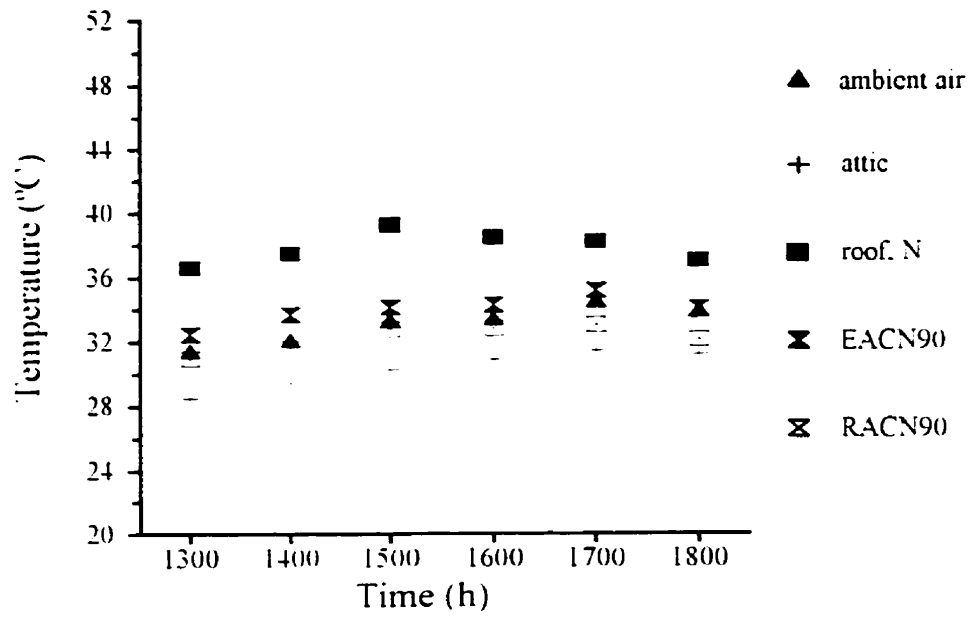
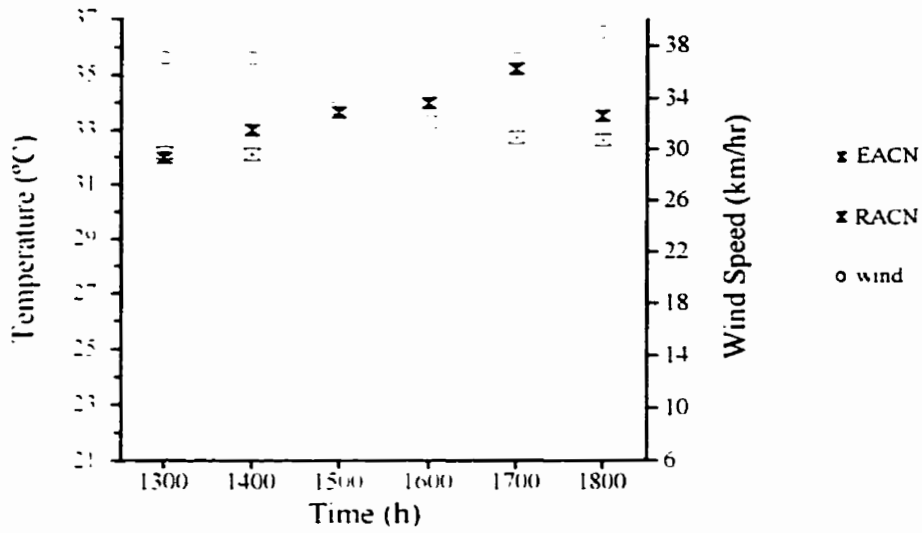
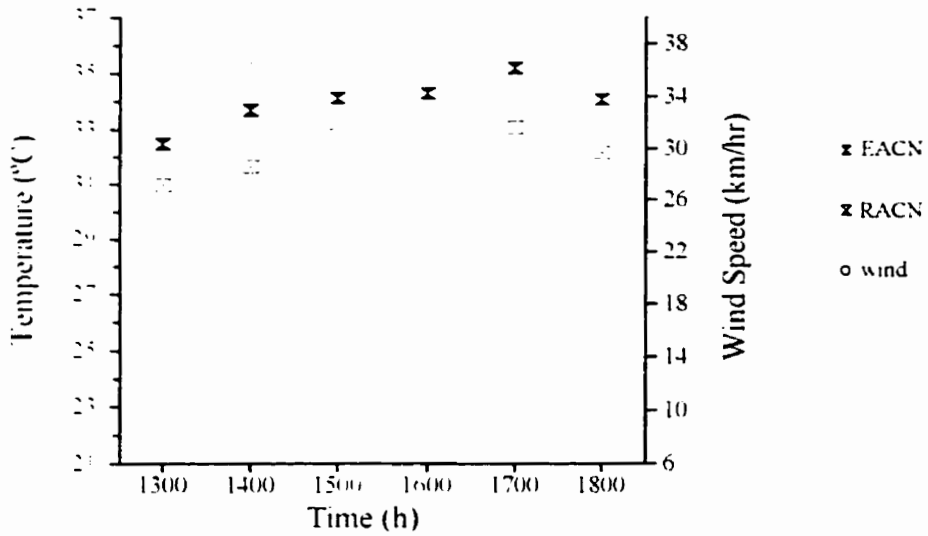

Figure E-13: Temperatures for the 90 mm channelled roof unit illustrate the general trend of data between the ambient air, the roof, the EACN90, the RACN90, and the attic for the channelled roof units, and each of the tests.



a) 40 mm channelled roof unit



b) 90 mm channelled roof unit

Figure E-14: Air channel temperatures for the a) 40 and b) 90 mm channelled roof units illustrate the trend of data for the channelled roof units corresponding to winds, south, south-east, and south-south-east.

APPENDIX F: WIND SUMMARIES FOR DAYS CHOSEN FOR ANALYSIS

Table F-1 Wind summaries (km/hr) for period of interest of days chosen for analysis (adapted from the monthly meteorological summaries for June, July, and August 1997, from Environment Canada).

Date	Time (h)					
	1300	1400	1500	1600	1700	1800
1997 06 09	S 37	S 37	SSW 35	SSW 39	S 37	SSW 39
1997 06 10	SSW 20	SW 22	SSW 28	SSW 22	SSW 19	S 15
1997 06 21	WSW 20	SW 15	SW 7	SSW 26	WSW 28	WNW 20
1997 07 30	SSW 17	SW 17	S 22	SSW 20	S 24	S 24
1997 08 07	SSW 28	SSW 31	SSW 35	SW 31	S 24	S 24
1997 08 24	SE 11	SSE 17	S 20	SSE 20	SSE 19	SSE 15

IMAGE EVALUATION TEST TARGET (QA-3)

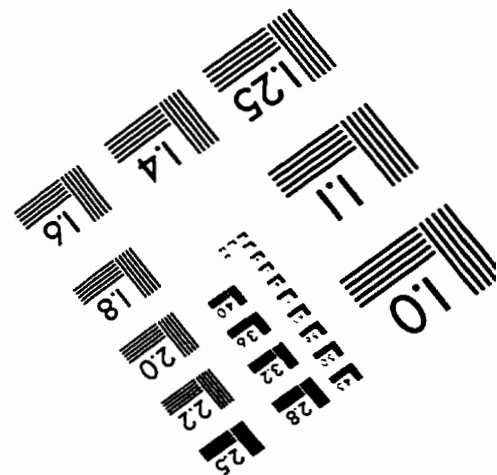
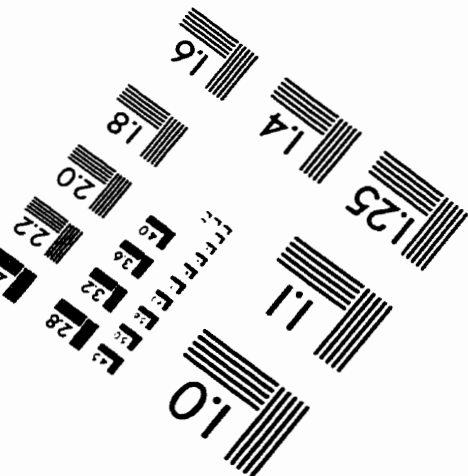
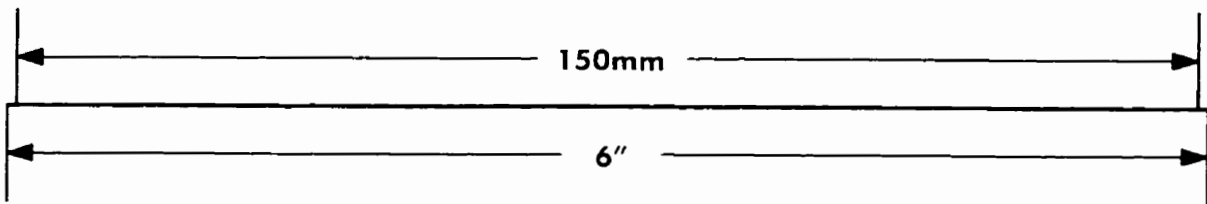
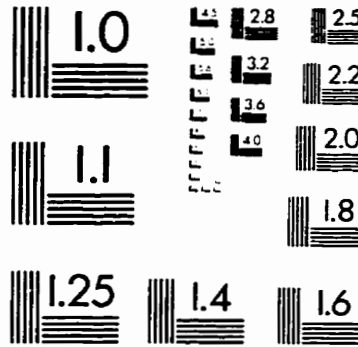
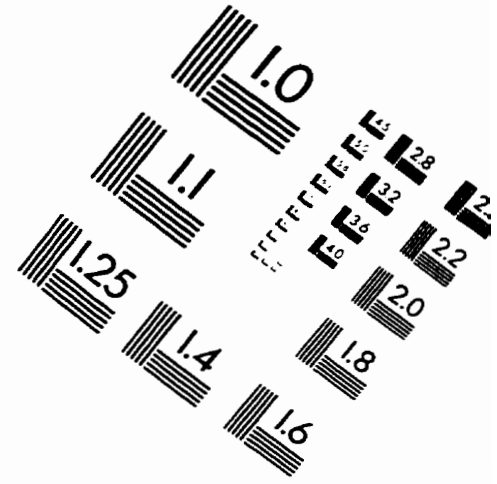
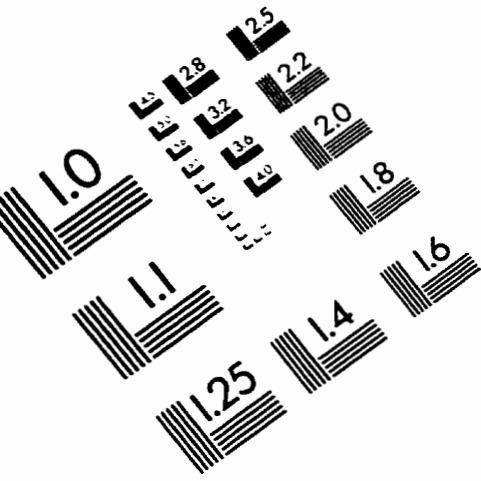

APPLIED IMAGE, Inc
1653 East Main Street
Rochester, NY 14609 USA
Phone: 716/482-0300
Fax: 716/288-5989

© 1993, Applied Image, Inc., All Rights Reserved