

FAULT ISOLATION IN LINEAR ELECTRONIC CIRCUITS
BY UTILIZING THE FREQUENCY RESPONSE AND
THE MOEBIUS TRANSFORMATION

A thesis presented to the
Faculty of Graduate Studies and Research
The University of Manitoba

In partial fulfillment of
the requirements for the degree
Master of Science

by

John David Dyck

October, 1970



ABSTRACT

FAULT ISOLATION IN LINEAR ELECTRONIC CIRCUITS BY UTILIZING THE FREQUENCY RESPONSE AND THE MOEBIUS TRANSFORMATION

A method of isolating (diagnosing) a single fault in a conventional linear electronic circuit, where only the input and output terminals are available for test measurements, is described.

A faulty circuit element is identified by comparing the measured magnitude and phase response of the faulty circuit, at a selected set of test frequencies, with a precomputed set of curves corresponding to all possible single fault conditions. These curves are shown to be arcs of circles, where the straight line is considered to be the special case of a circle with an infinite radius. Although the state equation approach is used in calculating the n-port parameters required for the precomputed curves, other methods such as topological formulas, ECAP (Electronic Circuit Analysis Program, supplied by IBM), or laboratory measurements could also be utilized.

The success of the Moebius transformation method, in identifying faults, was demonstrated by laboratory measurements and digital computer simulations. The results of fault diagnosis in several test circuits are presented.

This new approach to fault diagnosis provides a visual (graphical) identification of the faulty component and a precise evaluation of the faulty component value.

ACKNOWLEDGEMENTS

The author would like to extend his thanks to Dr. G. O. Martens for his help during the preparation of this thesis and to the National Research Council for its financial assistance.

TABLE OF CONTENTS

	PAGE
I. INTRODUCTION	1
Motivation for the development of a new fault isolation technique	1
Statement of the problem and inherent assumptions	1
Review of previous work	2
Significance of the new technique	6
An outline of the diagnosis technique	7
II. APPLICATION OF THE MOEBIUS TRANSFORMATION TO N-PORT PARAMETERS	9
The Moebius transformation	9
Application to n-port parameters	12
III. FAULT DIAGNOSIS	15
Test frequency selection	15
Identification of the faulty circuit parameter	17
Calculation of the value of the faulty circuit parameter	18
Example # 1	18
IV. CIRCUIT ANALYSIS TECHNIQUES	24
The measurement method	24
A method for simulating the change in a transistor parameter	25
Computer methods	26

	PAGE
V. EXPERIMENTAL RESULTS	29
Test circuit # 1	29
Test circuit # 2	36
Test circuit # 3	47
VI. COMPARISON OF VARIOUS FAULT ISOLATION TECHNIQUES	55
VII. CONCLUSIONS AND RECOMMENDATIONS FOR FURTHER WORK	59
BIBLIOGRAPHY	61
APPENDIX A	62
The fault diagnosis computer program	62
APPENDIX B	64
Computer output for Example # 1	64
Computer output for test circuit # 1	67
Computer output for test circuit # 2	74
Computer output for test circuit # 3	84

INTRODUCTION

Motivation for the development of new fault isolation techniques

Prior to the introduction of a wide variety of complex electronic equipment, a technician could acquire adequate experience with the circuitry of the equipment in order to repair it effectively. However, with today's rapid change in circuitry, it is difficult for technicians to gain this experience and other methods must be introduced as an aid to the technician.

Another difficulty experienced in the fault diagnosis of a circuit is due to high packaging density of modern equipment. The procedure of probing the signal path has become difficult even in the discrete component circuitry. In an integrated circuit, however, once the device has failed, it is impossible to probe the signal path unless test points have been provided. Test points are generally undesirable since they cause a deterioration in the high frequency performance and, consequently, are usually not provided. Although an integrated circuit cannot be repaired, the manufacturer may want to identify the fault in order to modify the manufacturing process.

Statement of the problem and inherent assumptions

The problem that will be considered is the one of identifying a single fault in a linear, lumped, time-invariant network with a known topology and a set of known nominal component values. Identification of a fault requires that the faulty element and the value of the ele-

ment be determined. If test points are required for unique fault identification, only a minimum number will be permitted; if possible, only the normal input and output terminals of the network will be used for test purposes.

The solution of the problem is based on the following assumptions:

(i) The fault is not intermittent, or the fault persists throughout the test measurement period.

(ii) Only those catastrophic failures, having a non-zero response at some terminal, can be identified uniquely, except in the case where a zero response at all terminals is unique to one fault.

(iii) Mutual inductance and the transformer turns ratio cannot be isolated as faults, since they violate the single element fault assumption. However, circuits, with mutual inductance and/or transformers with turns ratios, can be diagnosed if these parameters are excluded as possible faults.

If the value of the faulty parameter is not required, assumption (i) above can be relaxed and restated as:

(iv) The fault persists long enough to permit one significant test measurement.

A violation of assumption (ii), above, will be observable during the initial analysis of the circuit, and test points could be inserted into the circuit to satisfy the assumption.

Review of previous work

Seshu and Waxman⁶ have given a solution to the problem by recognizing that the transfer function magnitude will change at some frequency

if a circuit element changes. In terms of the Bode plot, this will be observable by a change in the location of the break frequencies, or the gain constant, or both. Thus by precomputing the gain between the break frequencies for all possible fault conditions, a fault dictionary of gain signatures is obtained. The magnitude response of the faulty circuit is then measured and compared to the list in the fault dictionary, and the faulty element is identified.

Since the number of transfer functions that must be evaluated for a reasonably complete fault dictionary is large, the symbolic transfer function is derived by topological formulas, and then, the fault signatures are calculated simply by substituting the appropriate values. This technique is necessary to shorten the computation time of the digital computer.

The method of Seshu and Waxman was investigated by Maenpaa, Stehman, and Stahl² and apparently proved to be quite successful. However, some of the problems encountered were: (i) the computation time and storage space required in the digital computer becomes quite large as the network size increases; (ii) no method is provided for interpolating between fault values, if a measured fault happens to fall between values listed in the dictionary.

Neu⁴ has developed a method whereby a quantity $k(x_i)$ remains invariant from one n-port parameter to another if x_i is the circuit element that has changed. If x_j is another circuit element (i.e. one which could not produce the observed changes in the n-port parameters), $k(x_j)$ will be different for different n-port parameters. The quantity $k(x_i)$ is defined as:

$$k(x_i) = \frac{\frac{\partial T(x_i)}{\partial x_i}}{\Delta T}$$

where

$k(x_i)$ = the "constant" of Neu's method

x_i = circuit element i

T = the n -port parameter

ΔT = the amount T has changed from its nominal value

To isolate a fault, $\frac{\partial T(x_i)}{\partial x_i}$ must be computed for all circuit

elements and for two or more n -port parameters. The change in the corresponding n -port parameters due to the fault is then measured and $k(x_i)$ is computed. That circuit element x_i , for which all the $k(x_i)$ are constant, is then the faulty component.

The amount Δx_i , that the faulty component x_i has changed from its nominal value, can then be calculated from the equation:

$$\Delta x_i = \frac{Q \cdot x_i}{k(Q \cdot x_i) - 1}$$

where Q is either the Thevenin immittance or transmittance at x_i .

Neu only discusses resistive networks, although the procedure could probably be extended to include capacitors and inductors by using phasor analysis. The evaluation and measurement of several n -port parameters is still required, however, and a technique based on a single n -port parameter would probably be preferable.

Moroz³ has shown that the coefficient of each power of s , the Laplace transform variable, of a transfer or driving point function can be written as:

$$k = \frac{ax_i + b}{cx_i + d} \quad (1.1)$$

where: k is any power of s of the transfer function (or driving point function),

x_i is any network parameter other than mutual inductance or a transformer turns ratio, and

a, b, c, d are real constants independent of x_i .

The constants $a, b, c,$ and d must be computed for each power of s , for each circuit component. If the symbolic transfer function is used, the constants can be obtained directly by substitution. If a numerical circuit analysis technique is used, $a, b, c,$ and d can be calculated by solving equation (1.1) for four values of k corresponding to four values of x_i . Three solutions are adequate in obtaining the ratio of three of the constants to the fourth one. The array of all coefficients $a, b, c,$ and d is known as the coefficient signature.

The coefficients of the transfer function of the faulty network must be computed from test measurements and a curve fitting procedure. The measured coefficients are then used in solving equation (1.1) for x_i . This produces as many solutions for each x_i as there are independent coefficients in the transfer function polynomial ratio. If x_i is the faulty component, which caused the nominal transfer function to change to the new value, the solutions for x_i will all be constant and equal to the new value of x_i . If x_i is not the faulty component, the

solutions for x_i will vary. As was suggested by Moroz, the solutions of the faulty x_i are not exactly constant, due to errors in the measurement procedure and in the curve fitting method. The x_i , which exhibits the least variance in the solution, is then chosen as the faulty component.

Significance of the new technique

One of the problems associated with the fault dictionary isolation technique is that of interpolating between the listed entries (gain signatures) in the dictionary when a fault falls between those listed. Since each element could fail with any value between zero and infinity, it is impossible to list all possible faults, and interpolation between the discrete steps of listed faults will often be required. The new technique, which is developed in the next section, permits a direct calculation of the value of the faulty component; the gain signature need not be evaluated and, therefore, the interpolation problem associated with the fault signature method is avoided.

It is shown that the use of the Moebius transformation method substantially reduces the number of n-port parameters that must be evaluated. Consequently, it becomes practical to use numerical evaluation of the n-port parameters by the state equation technique, rather than by the topological approach, without an increase in computer computation time. Since the state equation method requires much less storage than the topological formula method, the new technique also eliminates the large storage problem of the fault dictionary diagnosis.

If the network which is being investigated has two or more ports,

more than one n-port parameter describing its behaviour exists. A two-port, for example, could be described by:

$$\begin{bmatrix} V_1 \\ I_2 \end{bmatrix} = \begin{bmatrix} h_{11} & h_{12} \\ h_{21} & h_{22} \end{bmatrix} \begin{bmatrix} I_1 \\ V_2 \end{bmatrix}$$

where, in general, the hybrid parameters: h_{11} , h_{12} , h_{21} , h_{22} , all differ. Seshu and Waxman⁶ use only one of the h-parameters, in the above case, to determine a faulty element. However, in some cases, the same frequency signature exists for several different faults. Although a fault dictionary for another of the h-parameters might identify the fault uniquely, the computation time, required to compute the h-parameter and compile the additional fault dictionary, would increase significantly. The state equation technique of circuit analysis, which is impractical to use for compiling a fault dictionary, generates all n-port parameters simultaneously. Consequently, the new technique of fault diagnosis, which is suitable for state equation circuit analysis, can be used to investigate all of the h-parameters with only a small amount of additional computation.

An outline of the diagnosis technique

It is shown that the locus of an n-port parameter of a linear electronic network, as an element varies from zero to infinity, is an arc of a circle. This holds for all components except mutual inductances and transformer turns ratios. Since a circle is uniquely determined by any three points on the circle, we must evaluate or measure the n-port parameter for three values of each circuit element at each test frequency. Although any method may be used to evaluate the n-port para-

meter (e.g. ECAP, topological formula, state equations or laboratory measurements), the state equation approach was chosen as the most suitable, for reasons discussed in part IV. After the n-port parameters have been evaluated for three values of each component, the coefficients of the Moebius transformation are used in calculating the loci of the n-port parameters. The loci of the n-port parameters, at the test frequencies, are then plotted on graphs with one test frequency plot per graph.

The magnitude and phase of the n-port parameter of the faulty circuit are measured at the test frequencies and plotted on the $T(x_i)$ graphs. The plots are examined and the component x_i , which corresponds to the n-port parameter arc on which the measured n-port parameter of the faulty circuit falls, is the faulty component. After the faulty element has thus been detected, the coefficients of the Moebius transformation are used to calculate the value of the faulty component.

II

APPLICATION OF THE MOEBIUS TRANSFORMATION TO N-PORT PARAMETERS

Some of the properties of the well known Moebius transformation^{1,8} are developed in the following section. The development, which is not essential for an understanding of the fault diagnosis technique, is included for completeness and ease of reference. The results of the development are used in the fault isolation computer program which is included in Appendix A.

The Moebius transformation

The Moebius transformation, which is also known by the names, bilinear transformation, fractional linear transformation and linear substitution, is a transformation of the form:

$$w = \frac{Az+B}{Cz+D} \quad AD-BC \neq 0 \quad (2.1)$$

where A, B, C, D are complex numbers and z is a complex variable. The condition $AD-BC \neq 0$ is necessary, as otherwise w will reduce to a constant. In general, the transformation depends on three essential constants, namely, the ratio of any three of the constants A, B, C, D to the fourth one. If we choose three w_i corresponding to three z_i ,

then

$$\frac{(w-w_1)(w_2-w_3)}{(w-w_3)(w_2-w_1)} = \frac{(z-z_1)(z_2-z_3)}{(z-z_3)(z_2-z_1)} \quad (2.2)$$

The R.H.S. fraction is known as the cross ratio of four numbers z, z_1, z_2, z_3 and the L.H.S. is the cross ratio of w, w_1, w_2, w_3 . Thus, if we know w and three w_i corresponding to three z_i we can solve for z . To do this we note that there is a one to one correspondence between equation (2.2) and the following equation:

$$Sw = Tz$$

where
$$S = \begin{bmatrix} w_2 - w_3 & -w_1(w_2 - w_3) \\ w_2 - w_1 & -w_3(w_2 - w_1) \end{bmatrix}$$

and
$$T = \begin{bmatrix} z_2 - z_3 & -z_1(z_2 - z_3) \\ z_2 - z_1 & -z_3(z_2 - z_1) \end{bmatrix}$$

then
$$z = T^{-1}Sw$$

where
$$T^{-1} = \begin{bmatrix} -z_3(z_2 - z_1) & z_1(z_2 - z_3) \\ -(z_2 - z_1) & (z_2 - z_3) \end{bmatrix}$$

Then by the one to one correspondence:

$$z = \frac{aw + b}{cw + d} \quad (2.3)$$

where
$$\begin{bmatrix} a & b \\ c & d \end{bmatrix} = T^{-1}S$$

Solving (2.1) for z and equating to (2.3) we get:

$$z = \frac{Dw - B}{-Cw + A} = \frac{aw + b}{cw + d}$$

If z is real, $z = \bar{z}$, where \bar{z} is the complex conjugate of z ;

that is
$$\frac{aw + b}{cw + d} = \overline{\left(\frac{aw + b}{cw + d}\right)}$$

Cross multiplying and simplifying we get:

$$(a\bar{c} - c\bar{a})|w|^2 + (a\bar{d} - c\bar{b})w + (b\bar{c} - d\bar{a})\bar{w} + (b\bar{d} - d\bar{b}) = 0 \quad (2.4)$$

Multiplying the numerator and denominator of the last term by $(\bar{a}c - \bar{c}a)$:

$$(a\bar{c} - c\bar{a})|w|^2 + (a\bar{d} - c\bar{b})w + (b\bar{c} - d\bar{a})\bar{w} + \frac{\bar{a}c(b\bar{d} - d\bar{b}) - \bar{c}a(b\bar{d} - d\bar{b})}{(\bar{a}c - \bar{c}a)} = 0$$

Adding and subtracting $b\bar{b}c\bar{c}$ and $\bar{a}a\bar{d}d$ to the numerator of the last term and regrouping terms we get:

$$(a\bar{c} - c\bar{a})|w|^2 + (a\bar{d} - c\bar{b})w + (b\bar{c} - d\bar{a})\bar{w} + \frac{(\bar{a}d - \bar{c}b)(a\bar{d} - c\bar{b})}{(\bar{a}c - \bar{c}a)} = \frac{(ad - bc)(\bar{a}d - \bar{c}b)}{(\bar{a}c - \bar{c}a)}$$

Dividing by $\bar{a}\bar{c}-\bar{c}\bar{a}$, provided $\bar{a}\bar{c}-\bar{c}\bar{a} \neq 0$:

$$|w|^2 + \frac{(\bar{a}\bar{d}-\bar{c}\bar{b})w}{(\bar{a}\bar{c}-\bar{c}\bar{a})} + \frac{(\bar{a}\bar{d}-\bar{c}\bar{b})\bar{w}}{(\bar{a}\bar{c}-\bar{c}\bar{a})} + \frac{(\bar{a}\bar{d}-\bar{c}\bar{b})(\bar{a}\bar{d}-\bar{c}\bar{b})}{(\bar{a}\bar{c}-\bar{c}\bar{a})(\bar{a}\bar{c}-\bar{c}\bar{a})} = \frac{(ad-bc)(\bar{a}\bar{d}-\bar{c}\bar{b})}{(\bar{a}\bar{c}-\bar{c}\bar{a})(\bar{a}\bar{c}-\bar{c}\bar{a})}$$

Therefore:

$$\left(w + \frac{(\bar{a}\bar{d}-\bar{c}\bar{b})}{(\bar{a}\bar{c}-\bar{c}\bar{a})}\right)\left(\bar{w} + \frac{(\bar{a}\bar{d}-\bar{c}\bar{b})}{(\bar{a}\bar{c}-\bar{c}\bar{a})}\right) = \frac{(ad-bc)(\bar{a}\bar{d}-\bar{c}\bar{b})}{(\bar{a}\bar{c}-\bar{c}\bar{a})(\bar{a}\bar{c}-\bar{c}\bar{a})}$$

But since $(w+m)(\bar{w}+\bar{m}) = (w+m)(\overline{w+m}) = |w+m|^2$

we have:

$$\left|w + \frac{(\bar{a}\bar{d}-\bar{c}\bar{b})}{(\bar{a}\bar{c}-\bar{c}\bar{a})}\right|^2 = \left|\frac{ad-bc}{\bar{a}\bar{c}-\bar{c}\bar{a}}\right|^2$$

After taking the square root of both sides we note that we have the equation of a circle:

$$\left|w + \frac{(\bar{a}\bar{d}-\bar{c}\bar{b})}{(\bar{a}\bar{c}-\bar{c}\bar{a})}\right| = \left|\frac{ad-bc}{\bar{a}\bar{c}-\bar{c}\bar{a}}\right| \quad (2.5)$$

with centre: $\frac{(\bar{a}\bar{d}-\bar{c}\bar{b})}{(\bar{a}\bar{c}-\bar{c}\bar{a})}$

and radius: $\frac{(ad-bc)}{(\bar{a}\bar{c}-\bar{c}\bar{a})}$

However, if $\bar{a}\bar{c}-\bar{c}\bar{a} = 0$, (2.6)

equation (2.4) becomes:

$$(\bar{a}\bar{d}-\bar{c}\bar{b})w + (\bar{b}\bar{c}-\bar{d}\bar{a})\bar{w} + (\bar{b}\bar{d}-\bar{d}\bar{b}) = 0, \quad (2.7)$$

which is a straight line in w .

The initial assumption that $ad-bc \neq 0$ implies:

- (i) $\bar{a}\bar{d} \neq \bar{b}\bar{c}$
- (ii) a and c are not both zero
- (iii) \bar{a} and \bar{c} are not both zero
- (iv) d and b are not both zero
- (v) \bar{d} and \bar{b} are not both zero

$$\text{Assume that } \overline{ad} - \overline{cb} = 0 \quad (2.8)$$

Then, since \overline{d} and \overline{b} are not both equal to zero we can write:

$$a = \frac{\overline{cb}}{\overline{d}} \quad (2.9)$$

$$\text{or } c = \frac{\overline{ad}}{\overline{b}} \quad (2.10)$$

Because of points (ii) and (iii) above, (2.6) can be rewritten as:

$$a = \frac{\overline{ac}}{\overline{c}} \quad (2.11)$$

$$\text{or } c = \frac{\overline{ac}}{\overline{a}} \quad (2.12)$$

A substitution of (2.11) or (2.12) into (2.9) or (2.10) depending which equations exist, produces equations of the form:

$$\frac{\overline{a}}{\overline{c}} = \frac{\overline{b}}{\overline{d}} \quad (2.13)$$

$$\text{or } \frac{\overline{ad}}{\overline{cb}} = 1. \quad (2.14)$$

But since the initial assumption that $\overline{ad} \neq \overline{bc}$ implies that $\overline{ad} \neq \overline{bc}$, equations (2.13) and (2.14) are invalid, and therefore the assumption (2.8) that $\overline{ad} - \overline{cb} = 0$ is incorrect.

Equation (2.7) can then be solved for the real and imaginary axis intercepts of w , written as w_R and w_I respectively:

$$w_R = \frac{-\text{Imag}(b\overline{d})}{\text{Imag}(u)} \quad \text{where } u = \overline{ad} - \overline{cb} \neq 0 \quad (2.15)$$

$$w_I = \frac{-\text{Imag}(b\overline{d})}{\text{Real}(u)} \quad \text{where } u = \overline{ad} - \overline{cb} \neq 0 \quad (2.16)$$

Application to n-port parameters

Many authors 3,5,7 have used the Moebius representation of the n-port parameters of linear active networks:

$$T = \frac{Ax_1 + B}{Cx_1 + D} \quad (2.17)$$

where T is the n -port parameter as a function of the Laplace transformation variable s ,

x_1 is any circuit element (excluding mutual inductance and the turns ratio of transformers) value or the multiplier of a dependent source, and A, B, C, D are polynomials in s and any of the network components other than x_1 .

After the well known substitution of $s = j\omega$, A, B, C, D and T become complex numbers and x_1 is a real number. It is noted that equation (2.17) is equation (2.1) with T and x_1 corresponding to w and z respectively.

Since the circuit parameter, x_1 , can only have positive values (except, perhaps, in certain, special cases such as negative resistance), only the portion of the locus of T corresponding to values of x_1 between zero and infinity, is of interest. Thus, from equation (2.17) we get:

$$T(0) = B/D$$

$$T(\infty) = A/C$$

where $T(0)$ is the limit of $T(x_1)$ as x_1 approaches zero and $T(\infty)$ is the limit of $T(x_1)$ as x_1 approaches infinity.

Summarizing the procedure used in determining the circles (the straight lines are considered as being circles with an infinite radius and a centre at infinity):

(i) At each test frequency some method is used to obtain three values T_1, T_2, T_3 of an n -port parameter corresponding to the three values x_1, x_2, x_3 of the circuit parameter x_1 .

(ii) The coefficients a , b , c , and d for x_1 are computed from:

$$\begin{bmatrix} a & b \\ c & d \end{bmatrix} = \begin{bmatrix} -x_3(x_2-x_1) & x_1(x_2-x_3) \\ -(x_2-x_1) & (x_2-x_3) \end{bmatrix} \begin{bmatrix} T_2-T_3 & -T_1(T_2-T_3) \\ T_2-T_3 & -T_3(T_2-T_3) \end{bmatrix} \quad (2.18)$$

(iii) The arc of the circle of T or the straight line of T is calculated: if $a\bar{c}-c\bar{a} \neq 0$, we have a circle centered at $\frac{\bar{a}d-\bar{c}b}{\bar{a}c-\bar{c}a}$ and radius

of $\frac{ad-bc}{\bar{a}c-\bar{c}a}$ with the ends of the arcs of interest at $T(0) = -b/a$, and

$T(\infty) = -d/c$; however, if $a\bar{c}-c\bar{a} = 0$, we have a straight line with the real axis intercept $T_R = \frac{-\text{Imag}(b\bar{d})}{\text{Imag}(a\bar{d}-c\bar{b})}$ and the imaginary axis in-

tercept $T_I = \frac{-\text{Imag}(b\bar{d})}{\text{Real}(a\bar{d}-c\bar{b})}$.

(iv) Steps i, ii, iii are repeated for all of the circuit parameters, x_j , which are not mutual inductances or turns ratios.

The digital computer program, used in steps ii, iii and iv, above, is included in Appendix A.

III

FAULT DIAGNOSIS

Test frequency selection

As was pointed out by Seshu and Waxman⁶, a change in a circuit parameter causes a shift in one or more of the breakpoints (poles or zeroes) and/or a shift in the gain constant of the n-port parameter. At complex poles or zeroes, a change in a circuit parameter may result in no change of gain or location of the breakpoint but only in the value of the resonant dip or peak. In order to detect the change corresponding to any possible change in the breakpoint, or gain, we can choose test frequencies as follows: one test frequency below the lowest non-zero breakpoint, one frequency above the highest finite breakpoint, and at least one frequency between successive breakpoints. In addition, there must be at least one test frequency at each complex pole or zero. Generally the test frequencies between successive breakpoints are chosen at the logarithmic midpoint between the breakpoints.

Although the above scheme of choosing test frequencies is sufficient in detecting all unique faults (except perhaps if we require a certain amount of redundancy), fewer test frequencies may be sufficient to diagnose the faults. Since, generally, the number of poles of a circuit equals the number of reactive components, the poles should be adequate in identifying the reactive elements. One or two additional test frequencies should be sufficient in detecting the components which are not frequency dependent. The sufficiency condition for the test frequency selection is: the test frequencies must be chosen in such a

manner that, at least at one frequency, a change in any circuit parameter produces a significant change in the n-port parameter. A significant change is here defined as one which is readily distinguishable from a change in another component or from no change at all. Examples of non-significant loci are shown in Figures 1 to 3. For example, in Fig. 1, the locus of $T(x_1)$, as x_1 varies from zero to infinity, is almost a point coinciding with the nominal value of the n-port parameter, and cannot be distinguished from the nominal value.

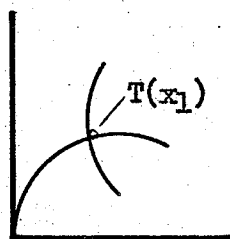

Fig.1. $T(x_1)$
a "point"

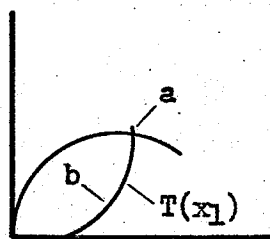

Fig.2. Part of $T(x_1)$
a "point"

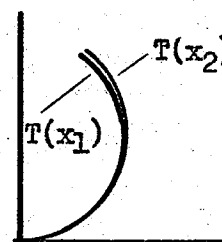

Fig.3. Two $T(x_i)$
almost coinciding

That part of the $T(x_1)$ locus in Fig. 2 denoted by "a" is very short and a value of $T(x_1)$ on that part of the curve could not be distinguished from the nominal $T(x_1)$. Thus the curve could not be used to identify a fault of x_1 , that corresponds to a faulty n-port parameter T_F , which is on part "a" of the locus. The loci of $T(x_1)$ and $T(x_2)$ in Fig. 3 nearly coincide and, since a change in x_1 could not be distinguished from a change in x_2 , loci of this form are not considered significant. In some cases $T(x_1)$ and $T(x_2)$ coincide at all frequencies and a different n-port parameter must be chosen to distinguish between faults of x_1 and x_2 . Sometimes no distinction may be obtainable regardless of the n-port parameter chosen. An example of this is a cir-

cuit with parallel resistors. In these cases we must resort to test points in order to isolate all faults.

Since the plots of $T(x)$ indicate whether the test frequencies which have been chosen are adequate for isolating all faults, we need not rely on a method that computes the critical frequencies of a network. We can choose a set of frequencies, plot the loci of $T(x_i)$, and, if some are of no significance, disregard them. An examination of the loci also indicates whether we have chosen the test points so that all faults can be isolated. Although this trial and error method may not be appealing if an analytical solution can be readily used, the method could be used if no means is available to compute the critical frequencies or for large networks where the problem of finding the poles and zeroes becomes difficult.

Test frequencies were selected by the criteria of Seshu and Waxman. The graphs were plotted and examined for significant changes of each element. If some of the test frequencies were not required for fault diagnosis, they were disregarded.

Identification of the faulty circuit parameter

The curves of $T(x_i)$ $i = 1, 2, \dots, n$, (where n is the number of circuit parameters), are plotted for each test frequency. The n -port parameter of the faulty circuit is then measured and plotted for each test frequency. Since it is assumed that only one fault has occurred, T_F , the faulty n -port parameter, will only satisfy those $T(x_i)$ where some value of that x_i could produce T_F , i.e. some circuit parameters can be eliminated as possible faults and

in some cases there is only one possible faulty parameter.

Calculation of the value of the faulty circuit parameter

After the faulty component has been identified, its value can be calculated using equation (2.3):

$$x_F = \frac{aT_F + b}{cT_F + d} \quad (3.1)$$

where T_F is the measured n-port parameter,
 x_F is the value of the faulty component and
 a, b, c, d , are given by equation (2.18).

Example # 1

Digital computer simulation was used in fault isolation of the network shown in Fig. 4. The critical frequencies of the nominal Z_{11} are:

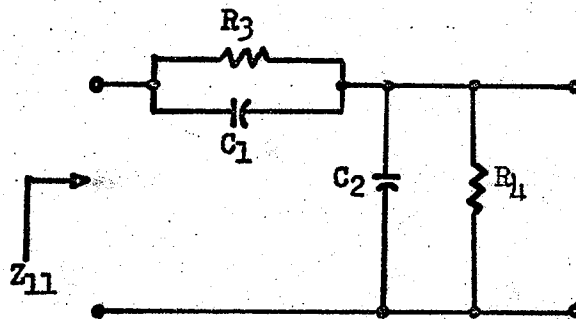

Element No.

- | | | | | |
|---|---|-------|---|--------------|
| 1 | - | C_1 | = | 10f |
| 2 | - | C_2 | = | 1f |
| 3 | - | R_3 | = | 1 Ω |
| 4 | - | R_4 | = | 0.1 Ω |

Fig. 4. Circuit for Example # 1

zeroes: -1.
 poles: -0.1, -10.

The test frequencies of 0.01, 0.3, 3.0, and 100. radians/second were chosen, and the resulting Z_{11} loci were computed and plotted in Graphs I to IV. The Z_{11} for the simulated fault $C_1 = 12f$ was calculated and plotted as "X" on the graphs. Graphs I, II, and III identify C_1 as be-

GRAPH I

$Z_{ii}(x)$ FOR E.G.#1

$\omega = 0.01$ RAD/SEC

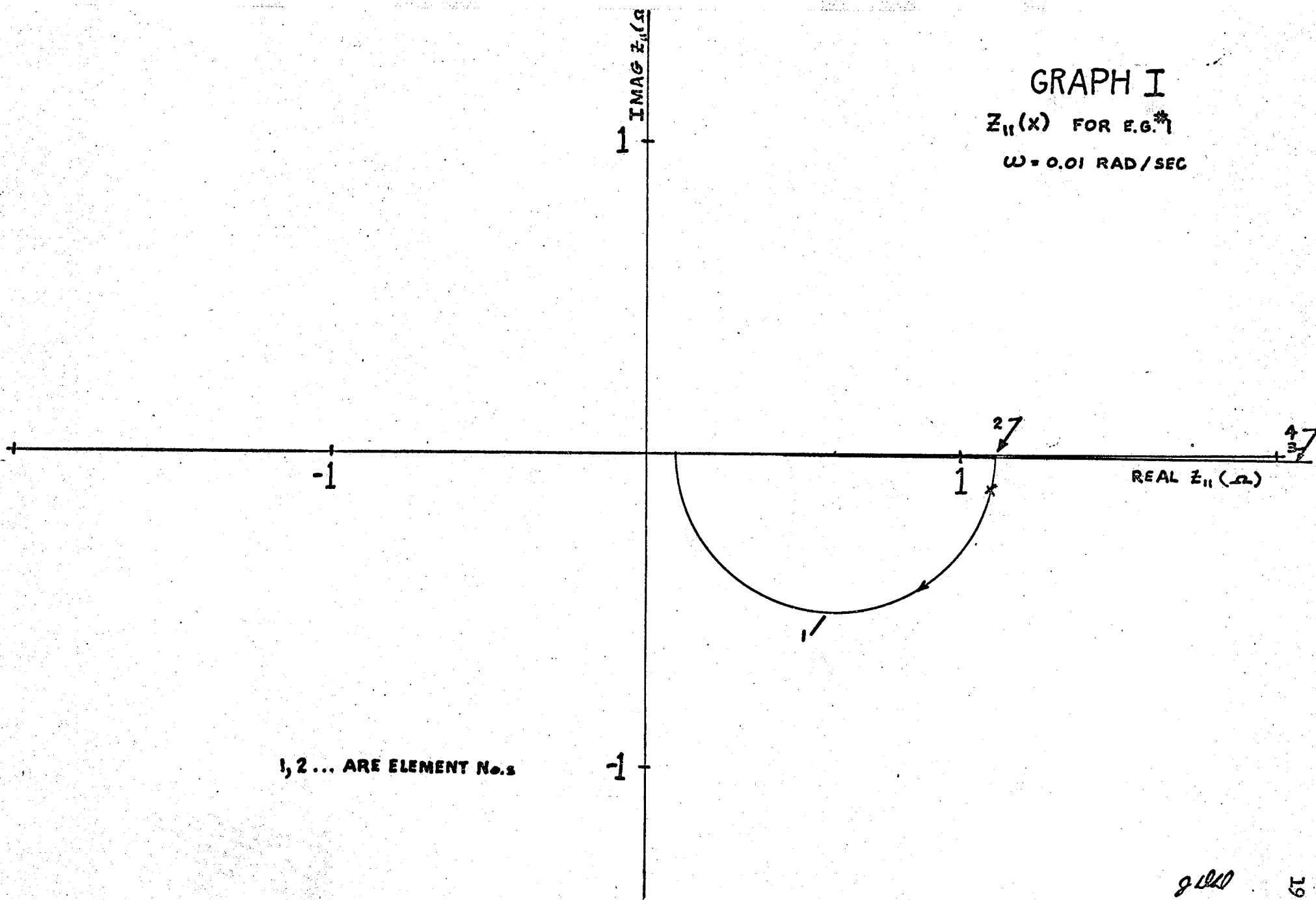

1, 2 ... ARE ELEMENT No.s

g lld
Aug 170

GRAPH II
 $Z_{11}(x)$ FOR E.O.#1
 $\omega = 0.3$ RAD/SEC

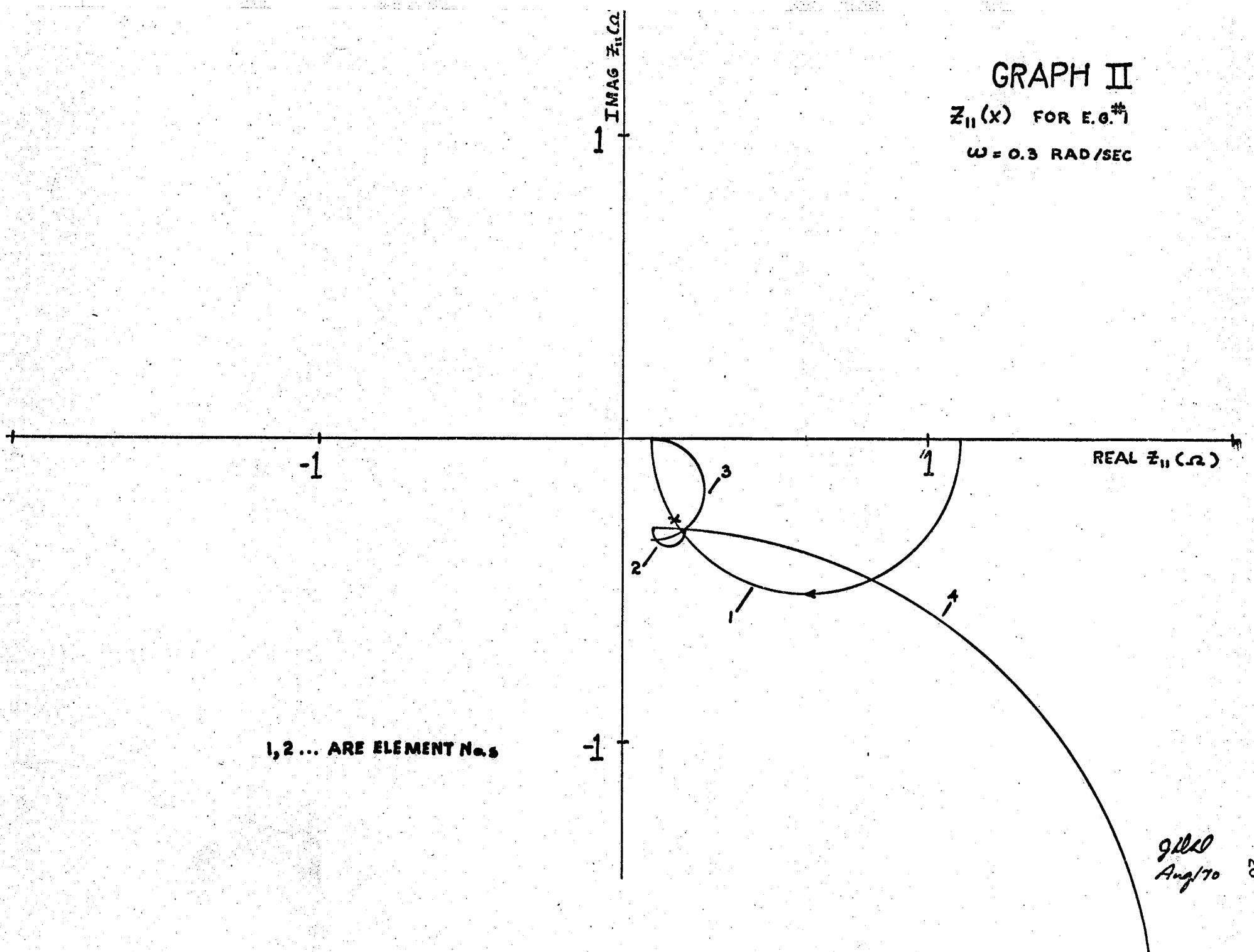

GRAPH III

$Z_{ii}(x)$ FOR E.G.#7

$\omega = 3.0 \text{ RAD/SEC}$

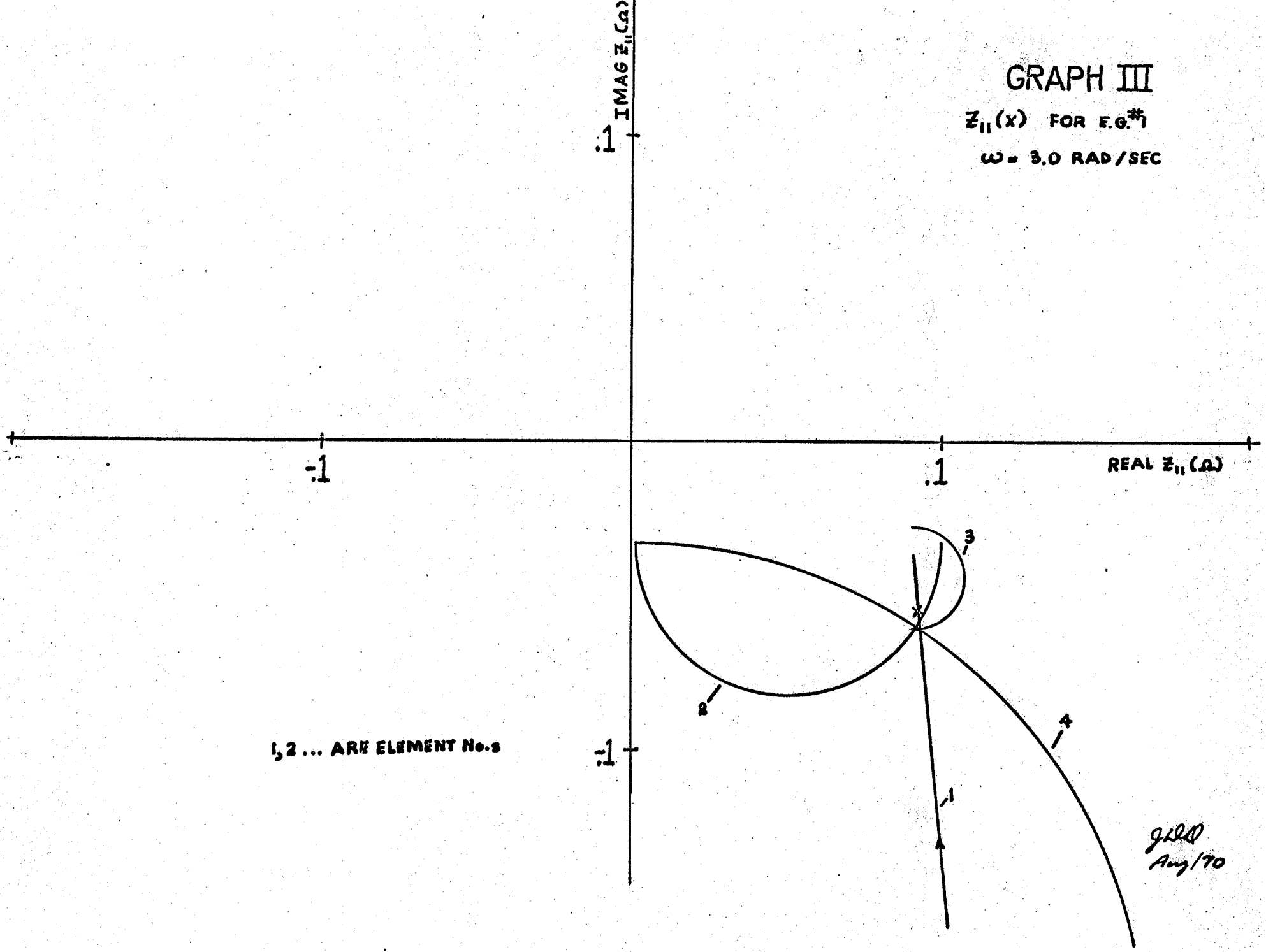

gld
Aug/70

GRAPH IV
 $Z_{11}(x)$ FOR EG #1
 $\omega = 100$ RAD/SEC

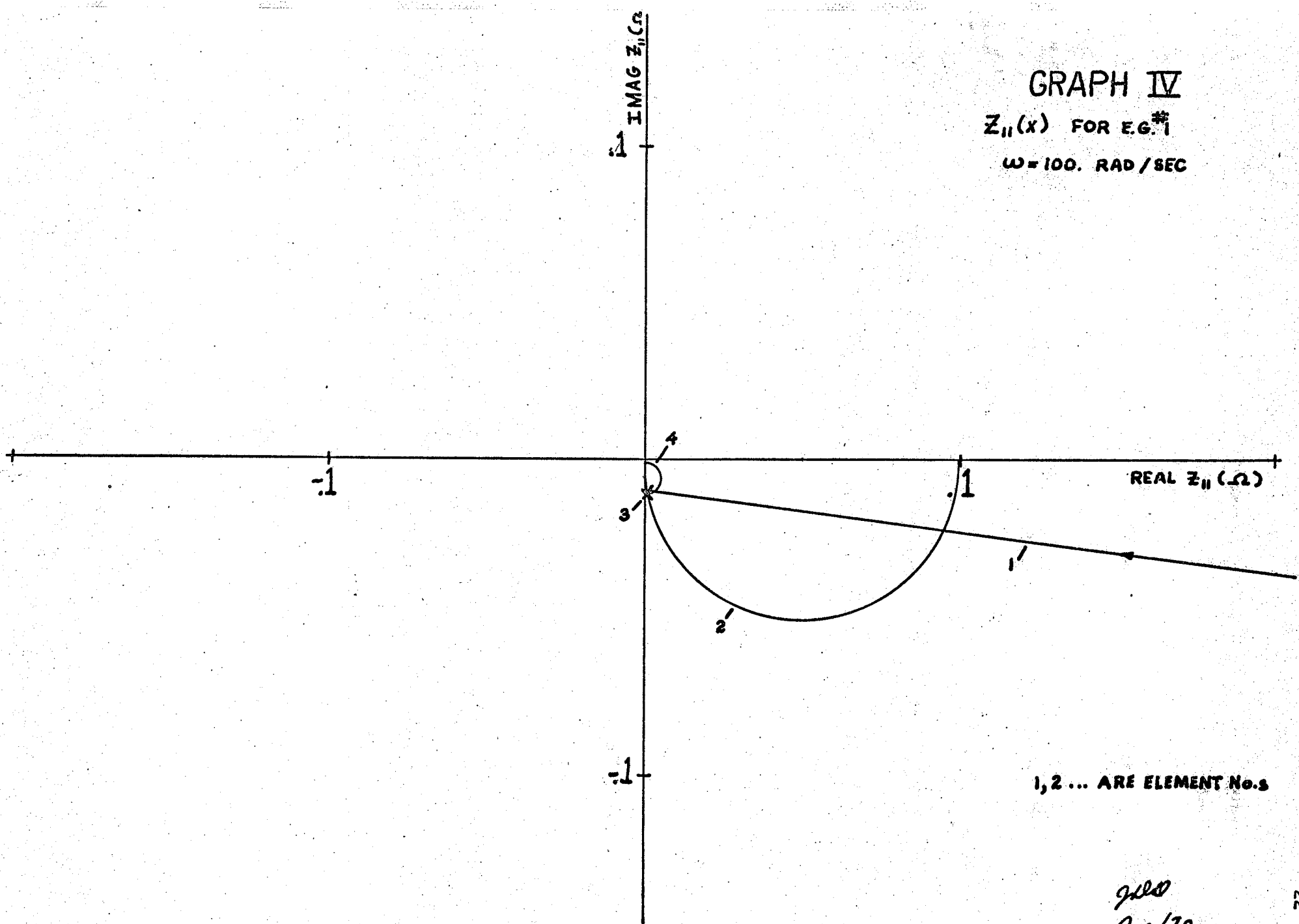

1, 2 ... ARE ELEMENT No.s

Jill
Aug/70

ing faulty, but Graph IV is not useful since the difference between the nominal Z_{11} and the faulty Z_{11} cannot be distinguished. Graph I identifies C_1 the most distinctly, since this is the test frequency at which the "X" is farthest from the other $T(x_i)$ loci. The value of C_1 is determined by solving equation (3.1) with the following data:

$$x_1 = 5.$$

$$x_2 = 15.$$

$$x_3 = 10.$$

$$T_1 = .11084 - j.13256$$

$$T_2 = .098727 - j.055678$$

$$T_3 = .10064 - j.075143$$

The solution of (3.1) is $x_F = 12.0$, as expected.

Although the four test frequencies may be useful in obtaining good definition in the fault detection, (e.g. Graph I defined the fault of C_1 most clearly), the choice of Graphs II and III would be adequate in locating all faults. Graph II would indicate faults above and below the nominal value for components C_1 , R_3 , R_4 , but could not distinguish between one end point of the C_2 locus and the nominal Z_{11} . Similarly, Graph III is adequate for faults of C_1 , C_2 , and R_4 but not for R_3 . Thus the test frequencies of 0.3 and 3.0 radians/second would be selected as the test frequencies for fault isolation in this circuit.

IV

CIRCUIT ANALYSIS TECHNIQUES

The n-port parameter of a circuit must be measured or computed for three values of every circuit element, if the Moebius transformation technique of fault isolation is used. Although, in theory, any method of circuit analysis can be used, hand computations are impractical for large networks. The practicality of using measurements and the digital computer analysis techniques of ECAP, topological formulas, and state equations, is examined in the following sections.

The measurement method

The n-port parameter circles can be determined by varying each of the circuit components and measuring the n-port parameters at the test frequencies. The technique of measuring the n-port parameters corresponding to three values of each component is feasible, though tedious. The calculations, that must then be performed, are simple and small in number -- a small computer or even a desk calculator can be used. Stray elements are accounted for in this way and, provided that the measurements are made precisely, the coefficients of the Moebius transformation are more accurate than those obtained by analyzing a model of the circuit.

Any circuit which has only physically accessible components presents no problems in the measurement procedure. However, devices such as transistors have inaccessible internal parameters such as: transconductance, resistance, and capacitance. In order to vary

these parameters, a model of the transistor must be constructed and the dependent generators must be replaced by independent sources which are regulated manually according to the dependence condition.

A method for simulating the change in a transistor parameter

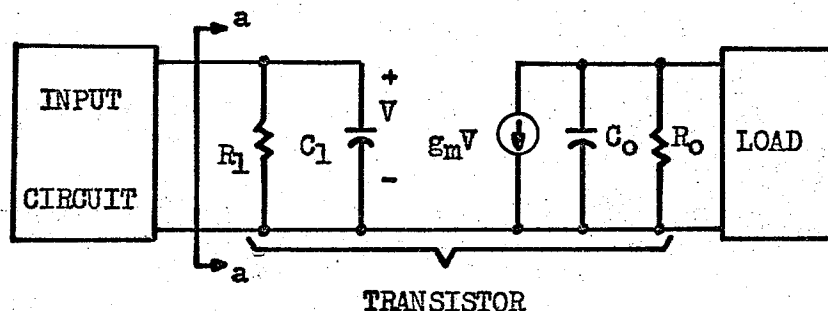

Fig. 5. Transistor equivalent circuit

The components R_1 , C_1 , R_o , C_o , in the transistor equivalent circuit shown above, can be varied by placing external elements in parallel with them, but g_m must be varied by modelling the transistor with accessible components. This is achieved by breaking the circuit at a-a and inserting additional components as shown below. The components C_1 and R_1 are used to load the input cir-

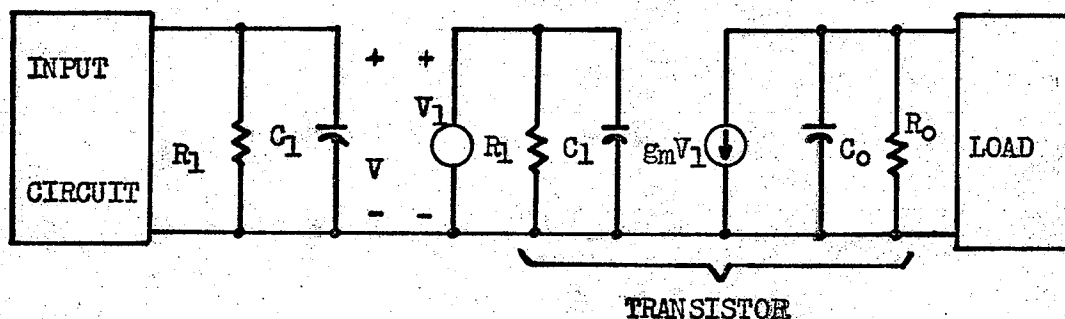

Fig. 6. Circuit for simulating a change in g_m

cuit the same way that the transistor would. The voltage V is measured and the independent source V_1 is adjusted to the value kV . Thus, if $k = 1$, the circuit is unchanged; changing k has the same effect as changing g_m . Although a more elaborate transistor model would make this technique more difficult, a similar procedure could still be applied.

For integrated circuit networks the above method would not be applicable, although the external components used in a circuit could be analyzed by the measurement method.

Computer methods

If the measurement method of obtaining the coefficients of the Moebius transformation is not used, such computer methods as ECAP, topological formulas, and state equations must be considered as possible alternatives. Of prime importance in choosing an analysis method are: (i) the computation time used by the computer in calculating the necessary n -port parameters; (ii) the computer storage space required in the solution.

The number of n -port parameters that must be evaluated will be a factor in estimating the computation time. For the Moebius transformation method, $N_M = (2n-1)N_{TF}$ n -port parameters must be determined, where N_M is the number of times the n -port parameter is calculated, n is the number of network parameters, and N_{TF} is the number of test frequencies used. Although it was previously stated that three values of each x_i are required at each test frequency in order to obtain the coefficients of the Moebius transformation, if one value of each x_i

is the nominal circuit value, only two additional values of x_i are required. Therefore, the number of n-port parameters is $(2n-1)N_{TF}$ as previously stated, rather than $3nN_{TF}$.

The number of n-port parameters required for the fault dictionary technique of Seshu and Waxman is $N_S = hnN_{TF}$, where N_S is the number of times the n-port parameter is calculated for the fault dictionary technique, and h is the number of faults listed in the fault dictionary for each component. Since h is generally larger than two (e.g. an h of nine is typical), the fault dictionary technique requires the evaluation of more n-port parameters than the Moebius transformation technique. For large networks, h (the number of discrete faults listed per component) must be increased, because the shunting effect of many elements make the n-port parameter, $T(x_i)$, less sensitive to a change in x_i . Thus the difference between N_M and N_S increases with an increase in network size.

If ECAP is used in finding the N_M n-port parameter values, then N_M separate calculations must be made, since ECAP calculates the response at a fixed frequency only. If the network is not too large, and if the available computer storage is small, ECAP is a suitable analysis technique.

An increase in the size of the circuit increases the N_S of the fault dictionary technique considerably. The computation time may then be reduced by finding the symbolic n-port parameter, using topological formulas and making the required substitutions for circuit elements and test frequencies. The topological solution requires a

large amount of storage since all trees of the network must be listed. Only one of the n-port parameters is generated per calculation, thus, if two or more n-port parameters are required for distinguishing between faults, the solution (except for the tree generation) must be repeated for each n-port parameter.

The state equation approach of analyzing a network overcomes the problem of large storage requirement and the single n-port generation feature of the topological solution. All of the n-port parameters are generated numerically in each solution, and substitution can be used for the different test frequencies. The time, required in finding the two solutions for each circuit element by the state equation method, would, generally, be less than that required in finding the symbolic n-port parameter by topological formula and then substituting the two component values. Thus, the state equation approach is superior to the topological solution in the analysis of the network as required in the Moebius transform fault identification.

EXPERIMENTAL RESULTS

The response of several faulty circuits was simulated on a digital computer, and the fault diagnosis technique was applied. Laboratory measurements were also performed on several circuits. A state equation computer program, written in Fortran IV, was used for circuit analysis. Simulation of the performance of a circuit with a faulty component was done by evaluating the magnitude and phase response of the transfer (or driving point) function, which was computed by the state analysis program, at the desired test frequencies. Laboratory measurements were made using a Wavetek Model 750 phase meter, two Hewlett Packard Model 400E AC voltmeters and an Advance Instruments Model TC9A frequency meter. Component values were measured at 1 KHz., with a General Radio Type 1650-A impedance bridge.

Test Circuit # 1

The voltage transfer function, $A_V = \frac{V_2}{V_1}$, was selected for diagnosing faults in the R-C network shown below.

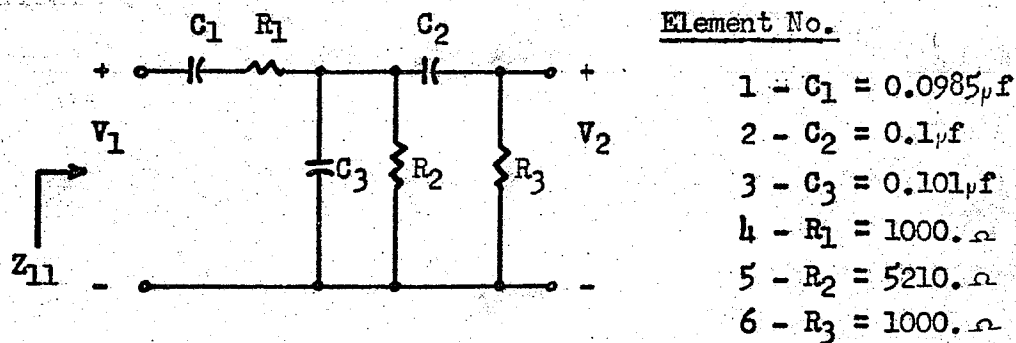

Fig. 7. Experimental Circuit # 1

The frequency was scaled by a factor of 10^{-5} . A root-finding program was used in finding the following roots of the nominal voltage transfer function:

zeroes: 0,0

poles: -0.0277, -0.00466, -0.00152

For laboratory test purposes R_3 was changed from 5210 ohms to 3820 ohms, to represent a change in R_3 of 7.5%. The voltage transfer function, A_v , was measured at the test frequencies, 18.4, 39.9, 143.6 and 2027. Hertz (which corresponds to the scaled radian frequencies, 0.00115, 0.0025, 0.009 and 0.127 radians/second). The loci of $A_v(x_i)$, $i = 1, 2, \dots, 6$, at the above test frequencies were calculated, and the results were plotted on Graphs V to VIII. The measured transfer function of the faulty circuit was plotted as "X" on the graphs.

An examination of Graphs VI and VII, immediately eliminates all x_i , except x_2 and x_6 , although a phase measurement error of 5% could result in the incorrect conclusion that x_1 or x_5 is the faulty element. Graph VI indicates that x_2 is the faulty component and Graph VII indicates x_6 as faulty. Since the graphs of the voltage transfer function did not provide a clear-cut fault identification, the driving point impedance, Z_{11} , was chosen for test purposes. The plot of the loci of $Z_{11}(x_i)$ at the radian test frequency of 15 radians/second, which is shown in Graph IX, identifies x_6 as the faulty component.

The value of x_6 was calculated using the coefficients corresponding to Graph VII, since it was on this graph that the "X" came closest to coinciding with the $T(x_6)$ locus. The computed value of x_6 is $3820. + j52.$ ohms, as compared to the measured value of $3820. + j0.$

GRAPH V

A_v FOR TEST CCT. # 1
1, 2 ... ARE ELEMENT No.s
 $\omega = 0.0015$ RAD/SEC

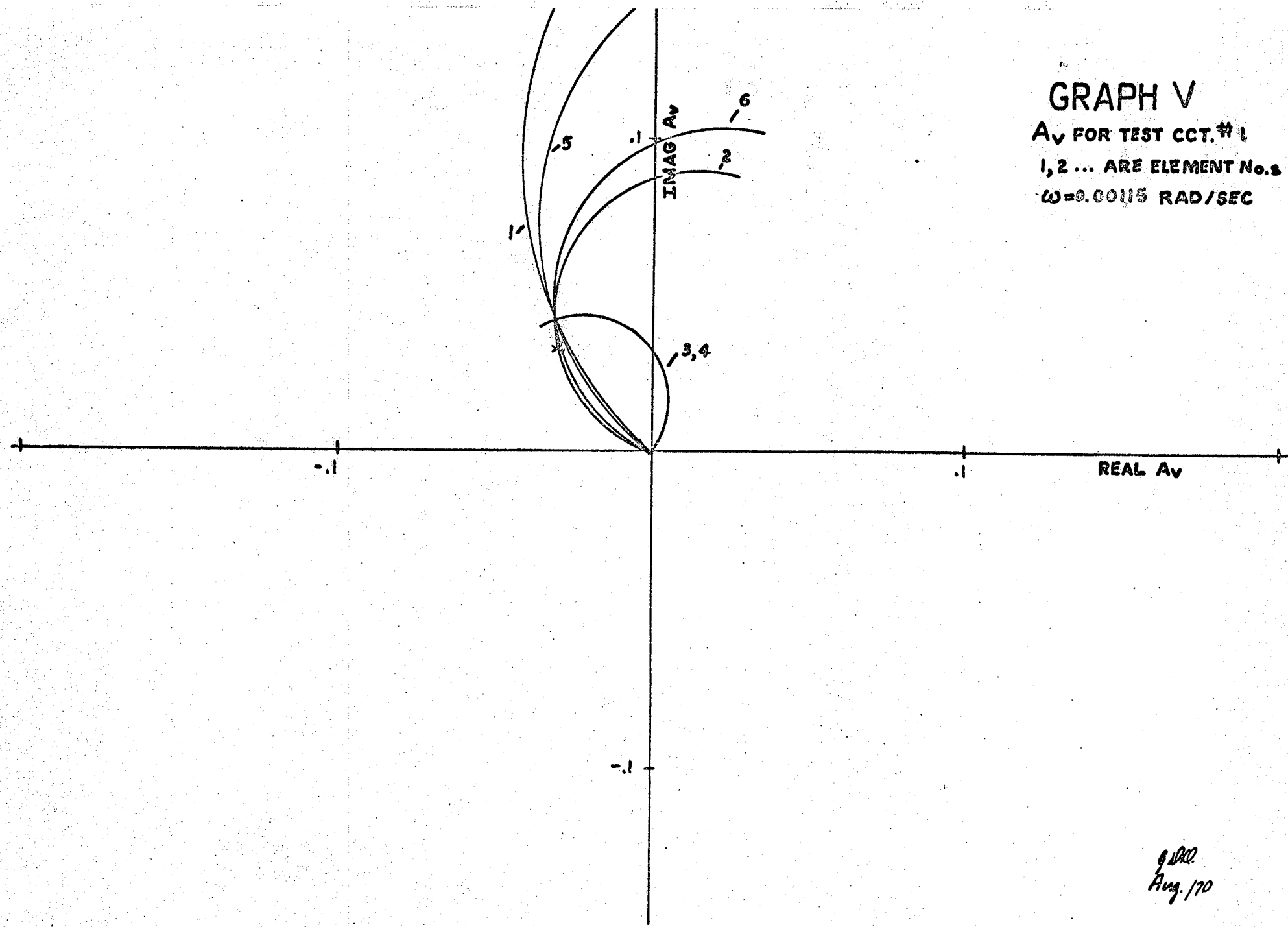

g. B. C.
Aug. 170

GRAPH VI
 A_v FOR TEST CCT. # 1
1, 2 ... ARE ELEMENT No.s
 $\omega = 0.0025$ RAD/SEC

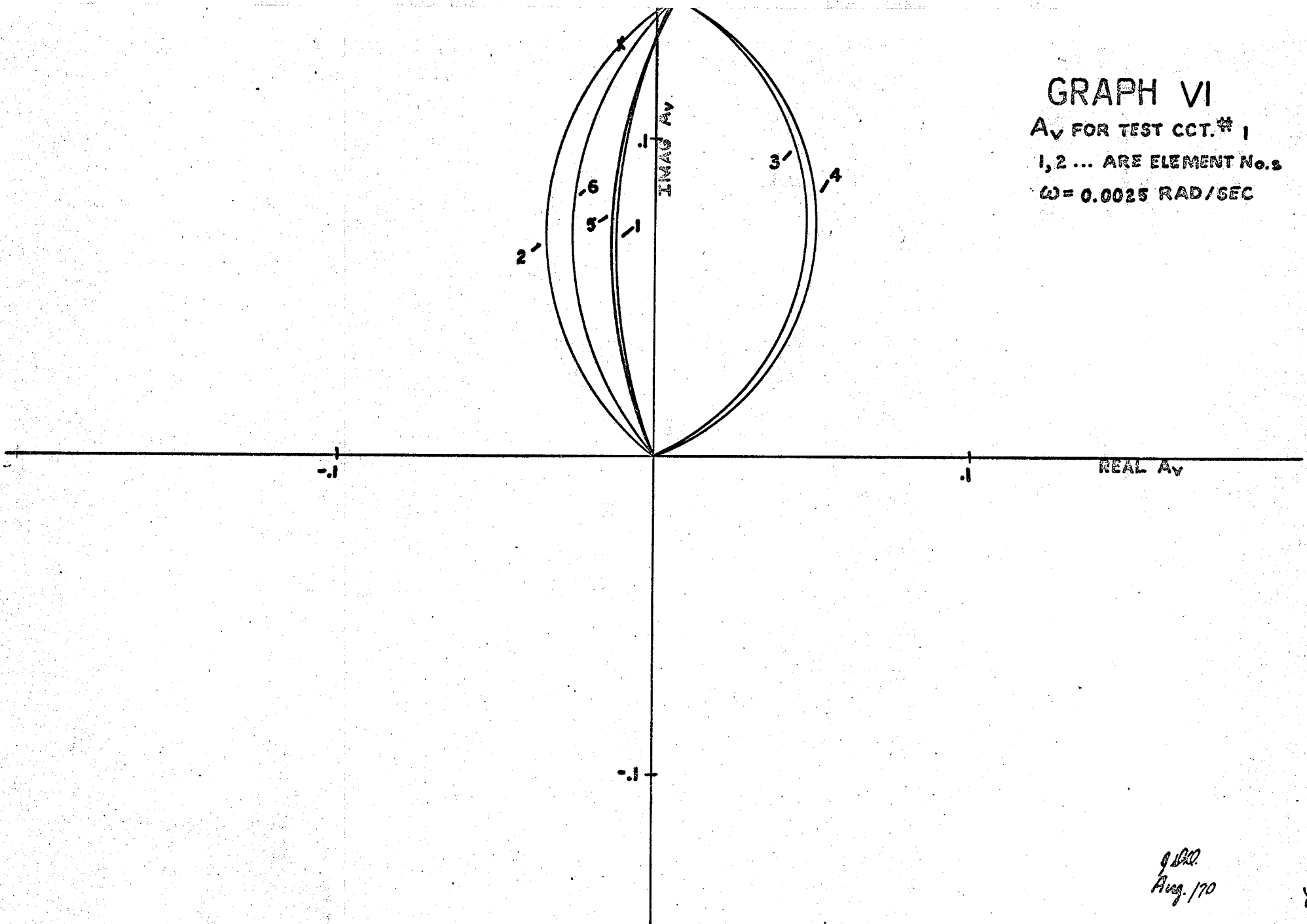

g. B. C.
Aug. 1970

GRAPH VII

A_v FOR TEST CCT. # 1

1, 2 ... ARE ELEMENT No.s

$\omega = 0.0090$ RAD/SEC

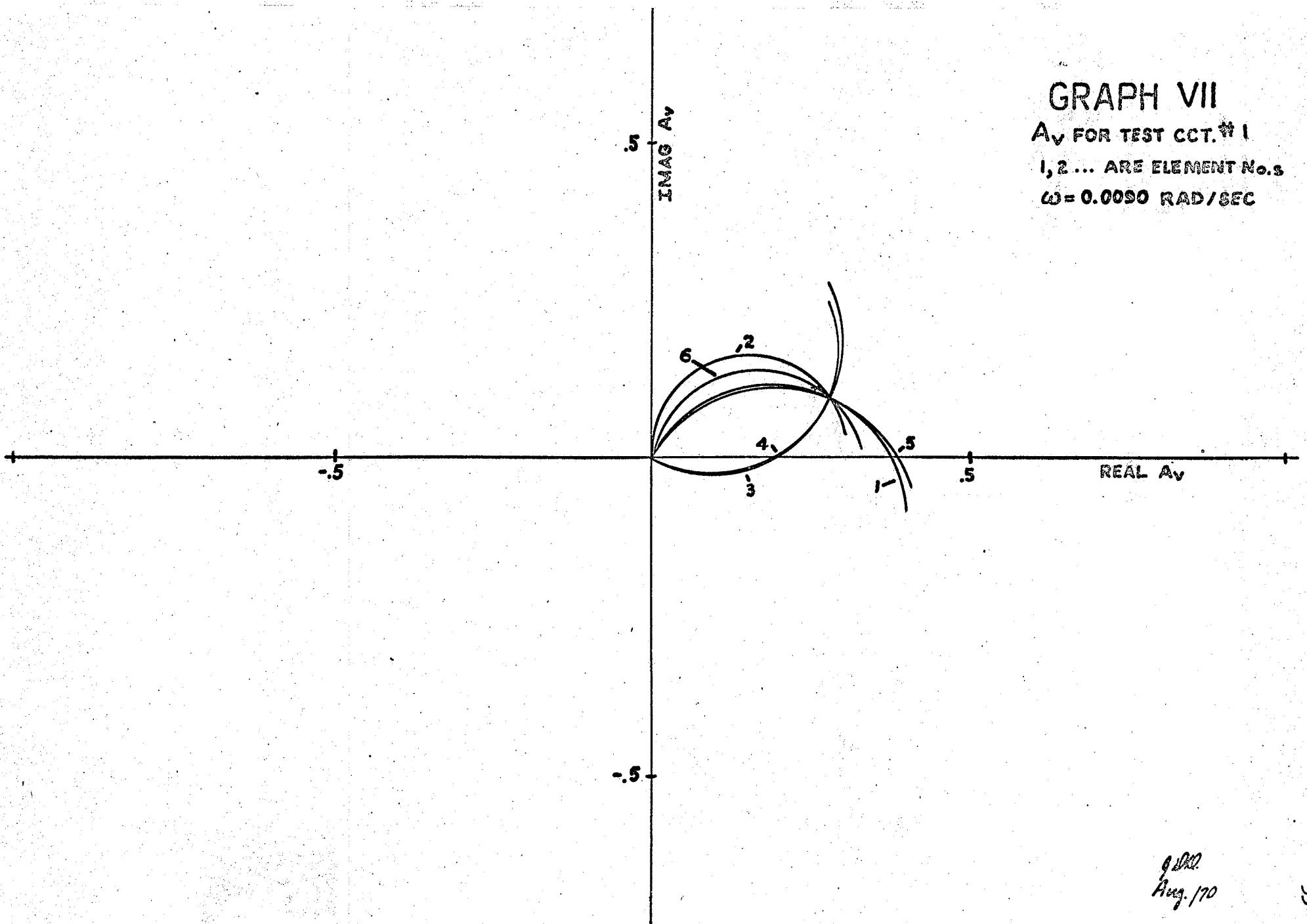

Q. D. R.
Aug. 170

GRAPH VIII
A_v FOR TEST CCT. #1.
1, 2 ... ARE ELEMENT No.s
 $\omega = 0.127$ RAD/SEC

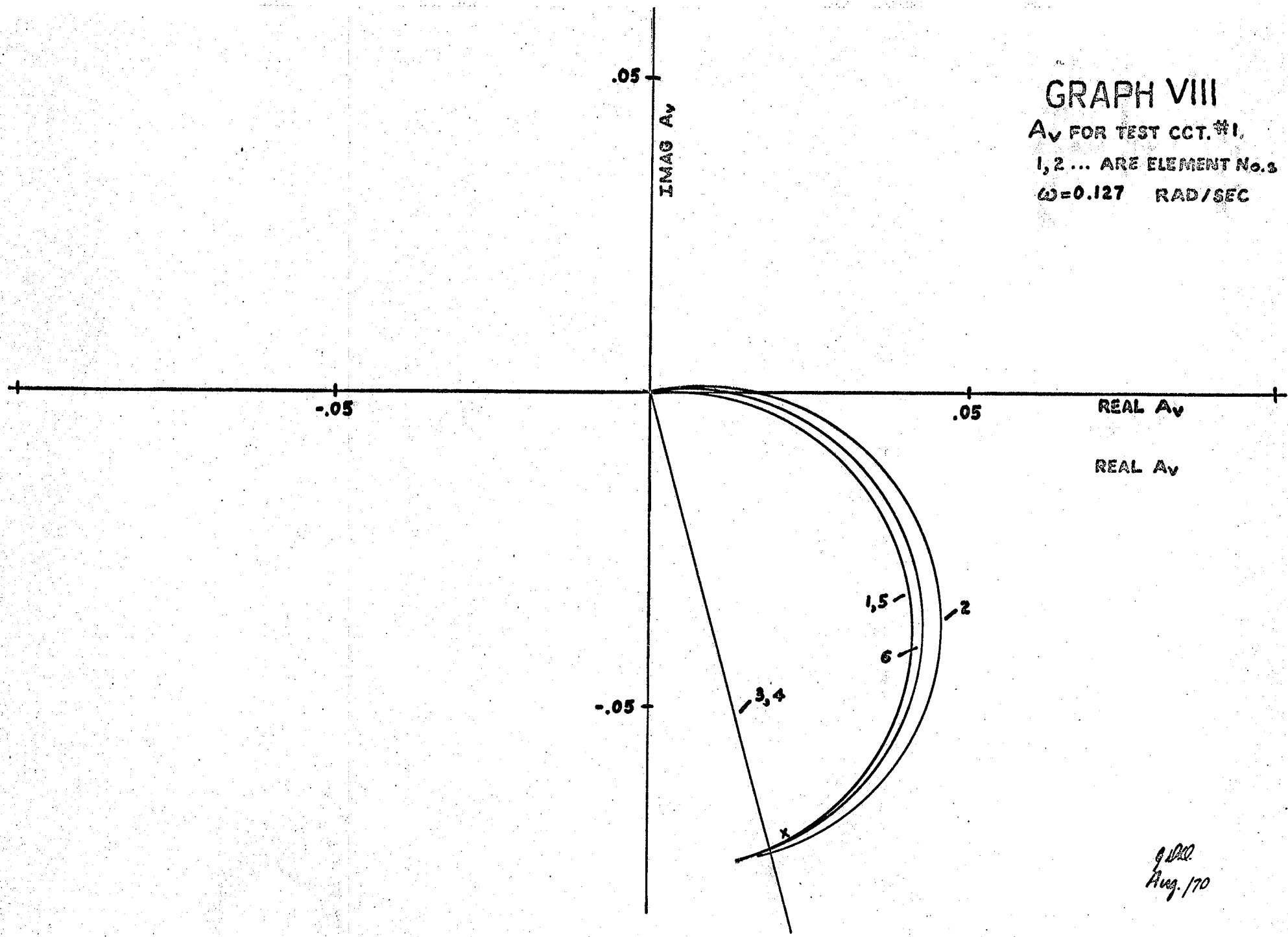

g dcl
Aug. 170

GRAPH IX
 \bar{A}_v FOR TEST CCT. # 1
1, 2 ... ARE ELEMENT No.s
 $\omega = 0.00094$ RAD/SEC

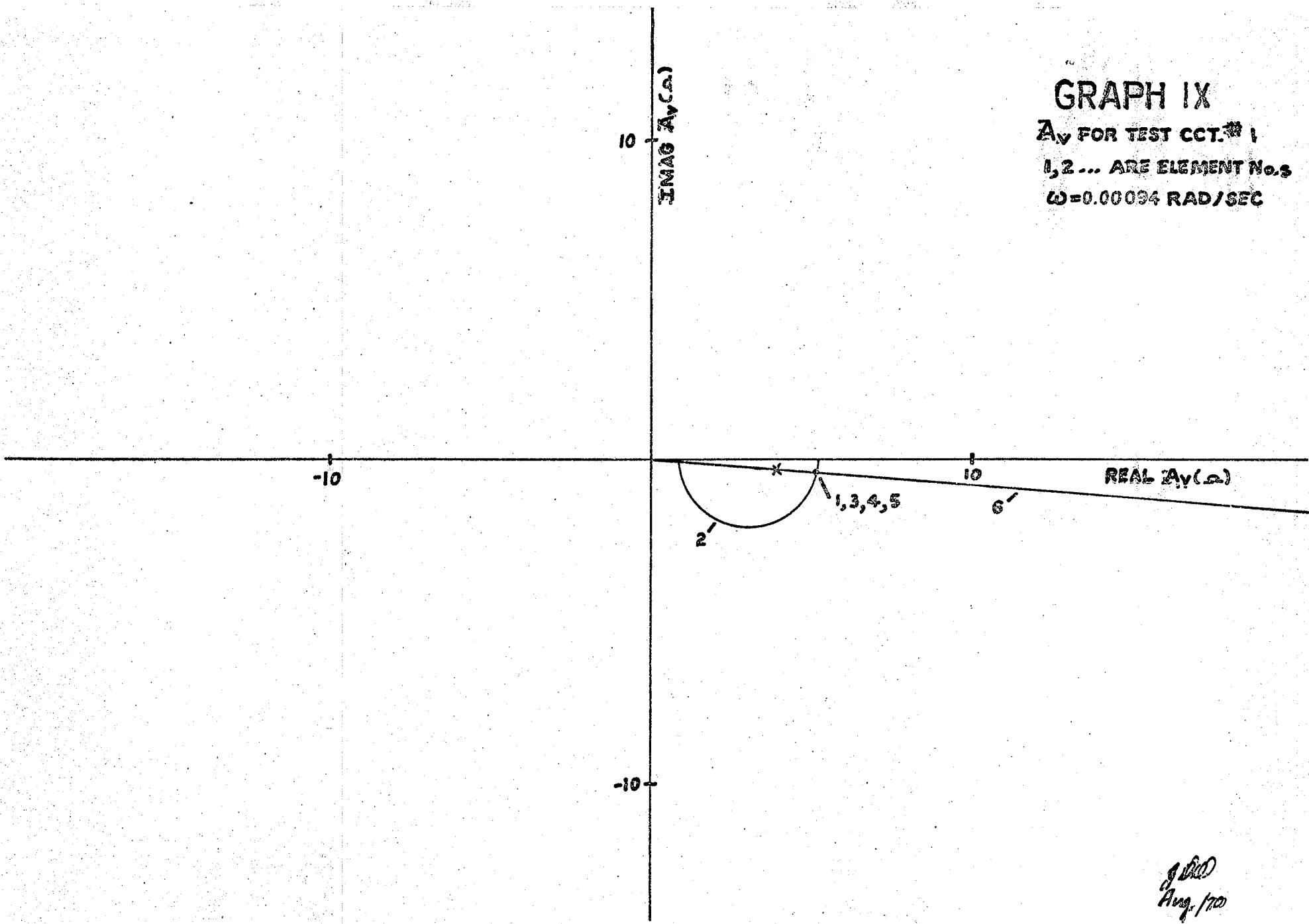

J. D. D.
Aug. 1970

ohms. The non-zero imaginary part in the solution is present because some of the circuit components other than x_6 are not at their nominal value, or because the measured value of A_V does not quite lie on the $T(x_6)$ locus. If we assume the latter, we can "correct" the A_V measurement so that it is on $T(x_6)$ and recalculate the value of x_6 . The values of x_6 computed at the other test frequencies are: $4184. + j118.$, $4042. + j162.$ and $2027. - j618.0$. The disagreement between the computed and measured values of x_6 can be expected since the measured values of A_V do not lie on the $T(x_6)$ loci in Graphs V, VI and VIII.

The results of the computer analysis of this example are included in Appendix B. The components of this example were used in a transistor amplifier circuit which was tested more extensively; see test circuit #2.

Test Circuit # 2

The voltage transfer function, $A_V = \frac{V_2}{V_1}$, was selected for di-

agnosing faults in the transistor amplifier circuit shown below.

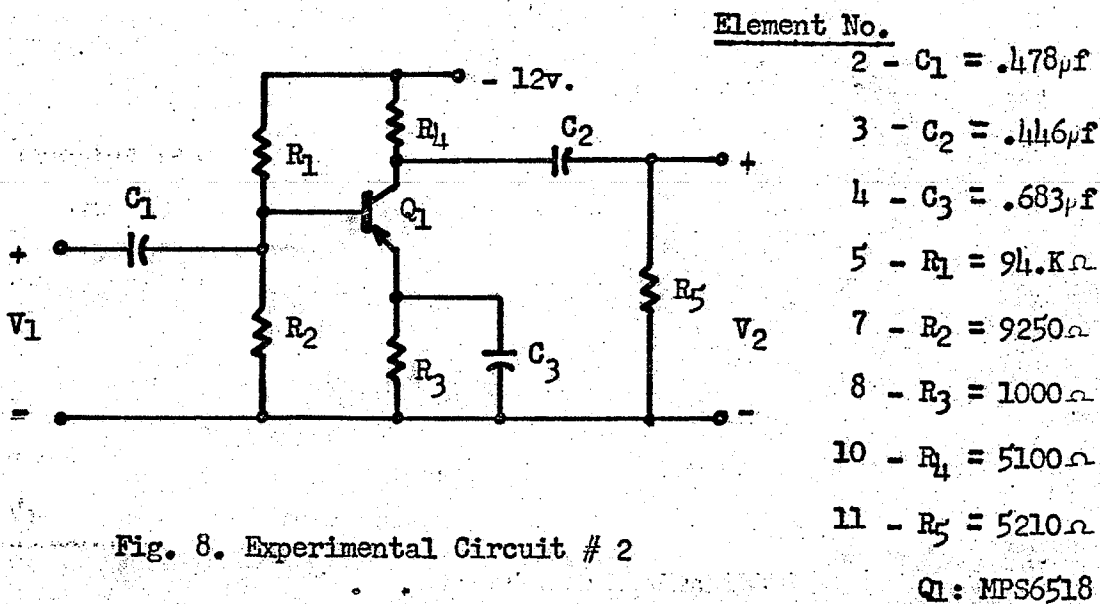

Fig. 8. Experimental Circuit # 2

The transistor equivalent circuit that was used is shown in Fig. 9.

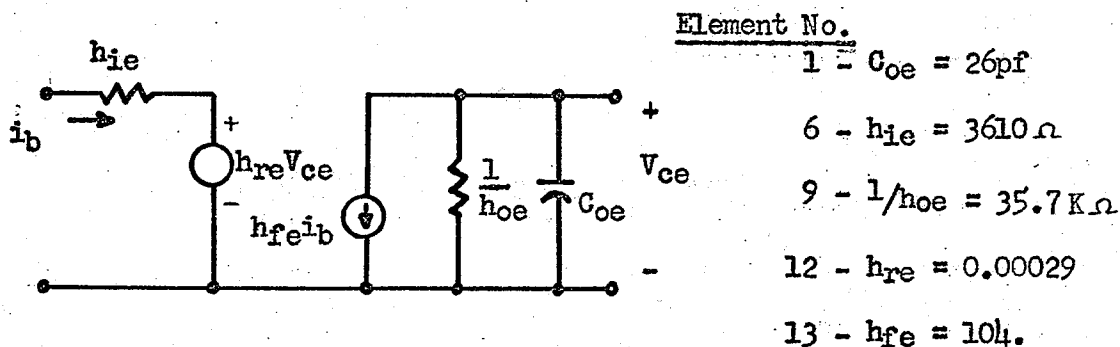

Fig. 9. Transistor equivalent circuit

The frequency was scaled by 10^{-5} . A root-finding program was used in finding the following roots of the nominal voltage transfer function:

$$\begin{aligned} \text{zeros: } & 0, 0, -0.01464 \\ \text{poles: } & -0.002236, -0.002604, -0.4280, -156.4. \end{aligned}$$

In the digital computer simulation, R_5 was changed from 5210 ohms to 3820 ohms. The test frequencies of 3.18, 38.4, 98.5, 1270, 5.8×10^5 and 25.4×10^6 (which correspond to the scaled radian frequencies of 0.0002, 0.00242, 0.0062, 0.080, 36.4 and 1600. radians/second) were used. The loci of $A_V(x_i)$, $i = 1, \dots, 13$, at the above test frequencies were calculated, and the results were plotted on Graphs X to XIV. The transfer function of the faulty circuit was plotted as "X" on the graphs.

An examination of Graphs XII and XIII, immediately eliminate all x_i except x_{10} and x_{11} . The other graphs show that we cannot distinguish between a fault in x_{10} and x_{11} at any test frequency. This is reasonable, since the components R_4 and R_5 (x_{10} and x_{11}) of the amplifier are effectively parallel load resistors. At the test frequency of 0.08 radians/second, the two possible fault solutions are:

GRAPH X
A_v FOR TEST CCT. #2
1, 2 ... ARE ELEMENT No.s
 $\omega = 0.0002$ RAD/SEC

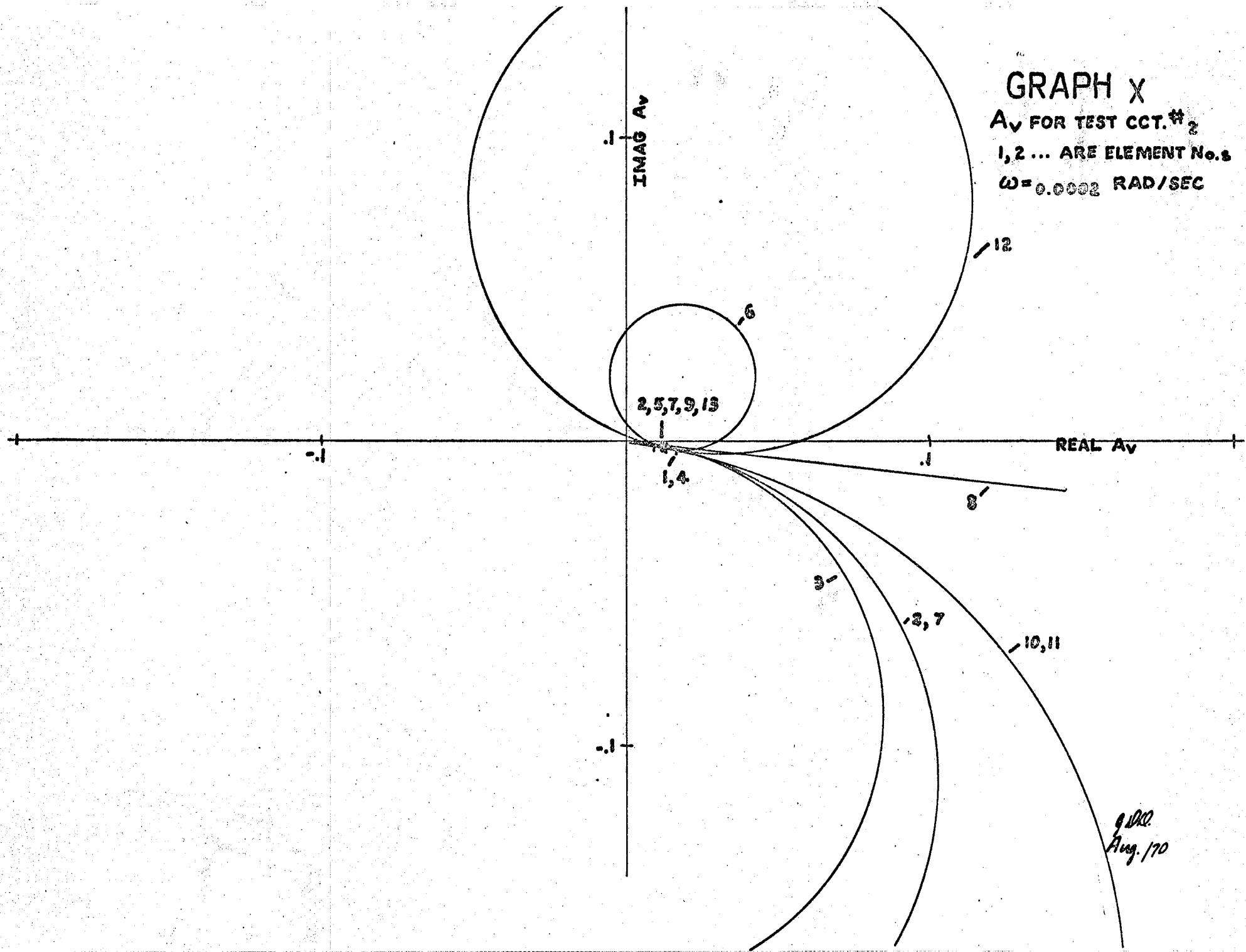

g. DRC
Aug. 170

GRAPH XI
 A_v FOR TEST CCT. # 2
1, 2 ... ARE ELEMENT No.s
 $\omega = 0.0024$ RAD/SEC

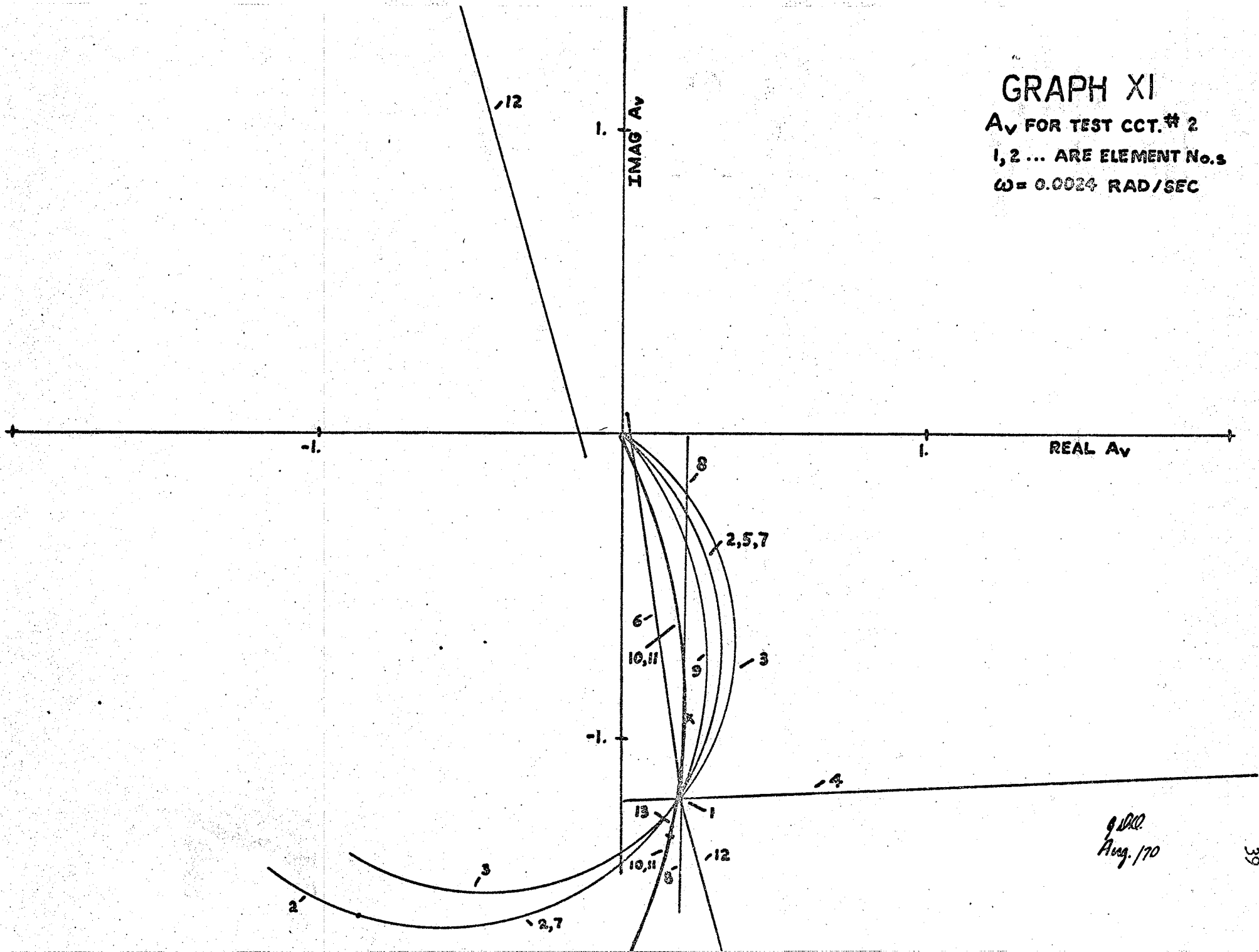

g. D. C.
 Aug. 170

GRAPH XII
 A_v FOR TEST CCT. # 2
1, 2 ... ARE ELEMENT No.s
 $\omega = 0.0062$ RAD/SEC

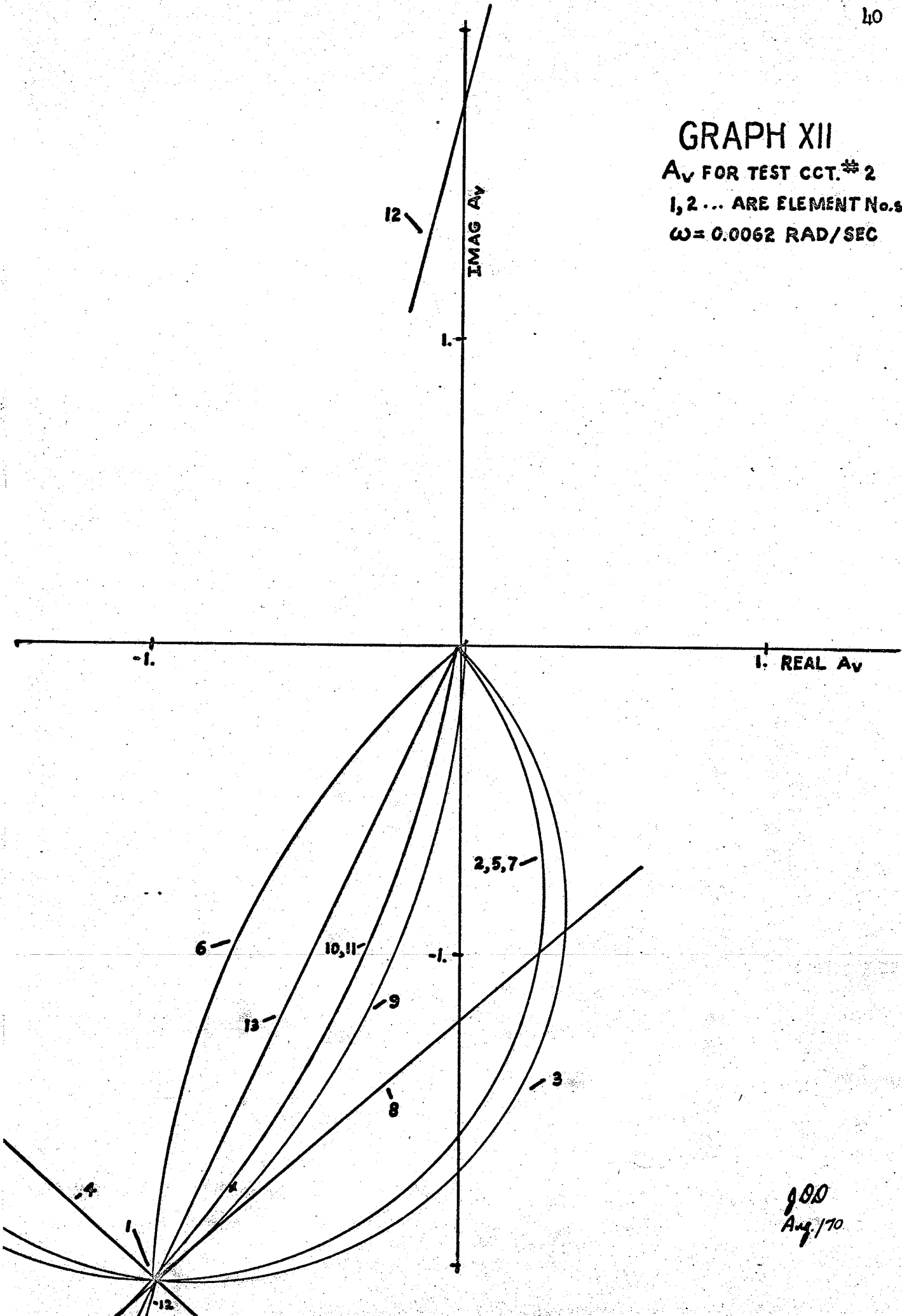

900
Aug. 170

GRAPH XIII

A_v FOR TEST CCT. # 2

1, 2 ... ARE ELEMENT No.s

$\omega = 0.080$ RAD/SEC

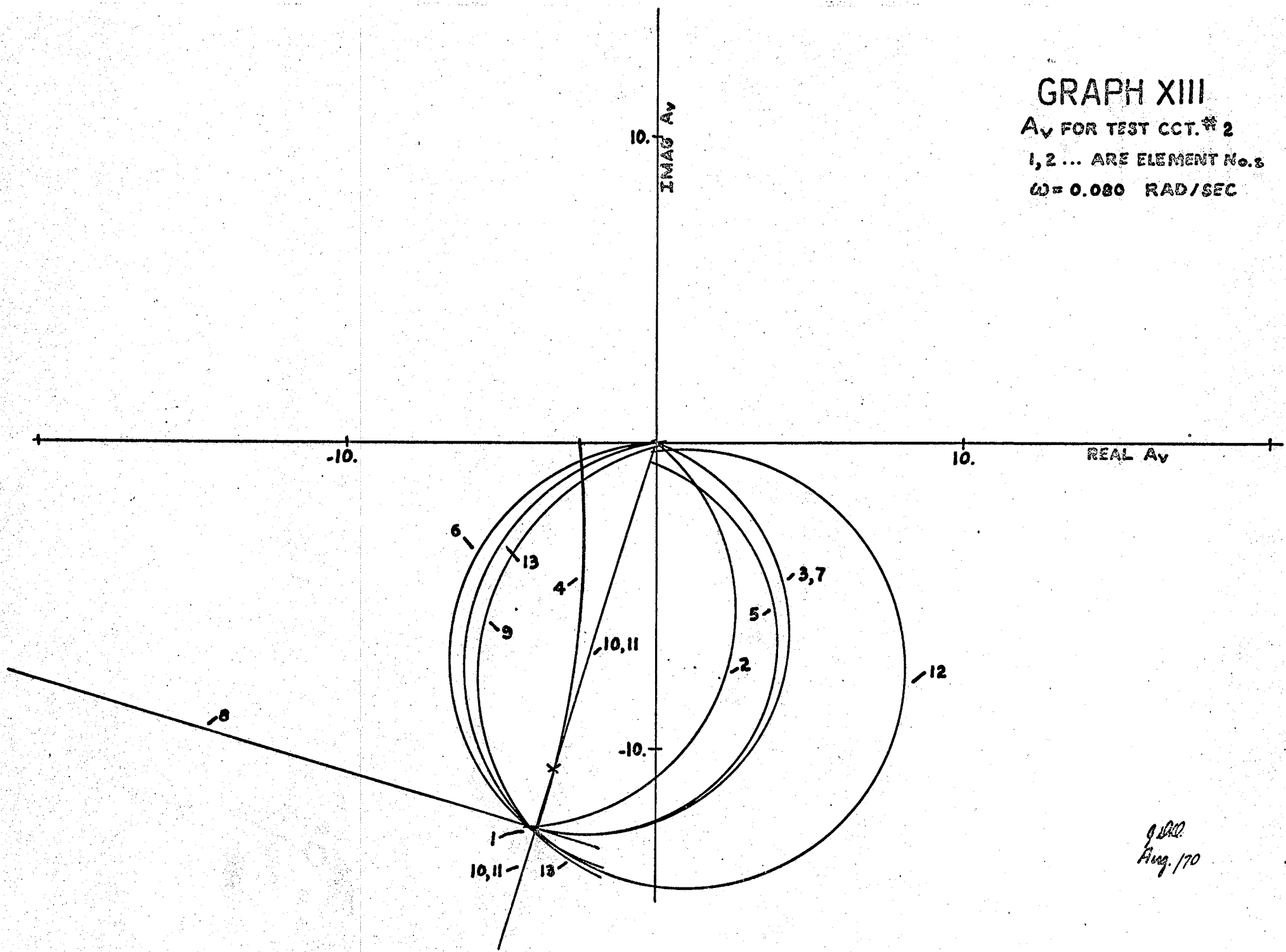

Q. D. D.
Aug. 170

GRAPH XIV

A_v FOR TEST CCT. # 2

1, 2 ... ARE ELEMENT No.s

$\omega = 36.4$ RAD/SEC

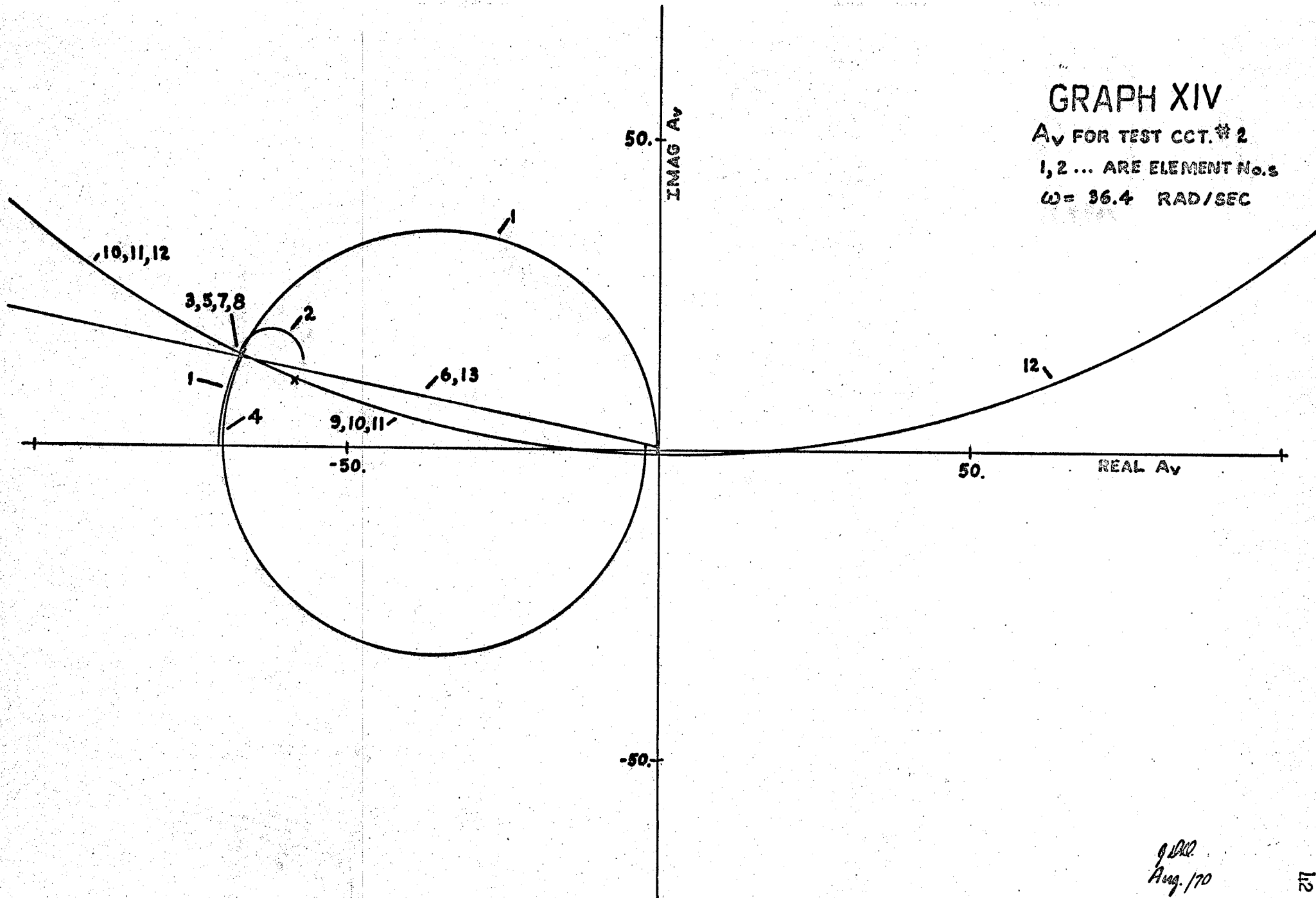

9 Dec
Aug. 170

GRAPH XV

A_v FOR TEST CCT. #2

1, 2 ... ARE ELEMENT No.s

$\omega = 1600$. RAD/SEC

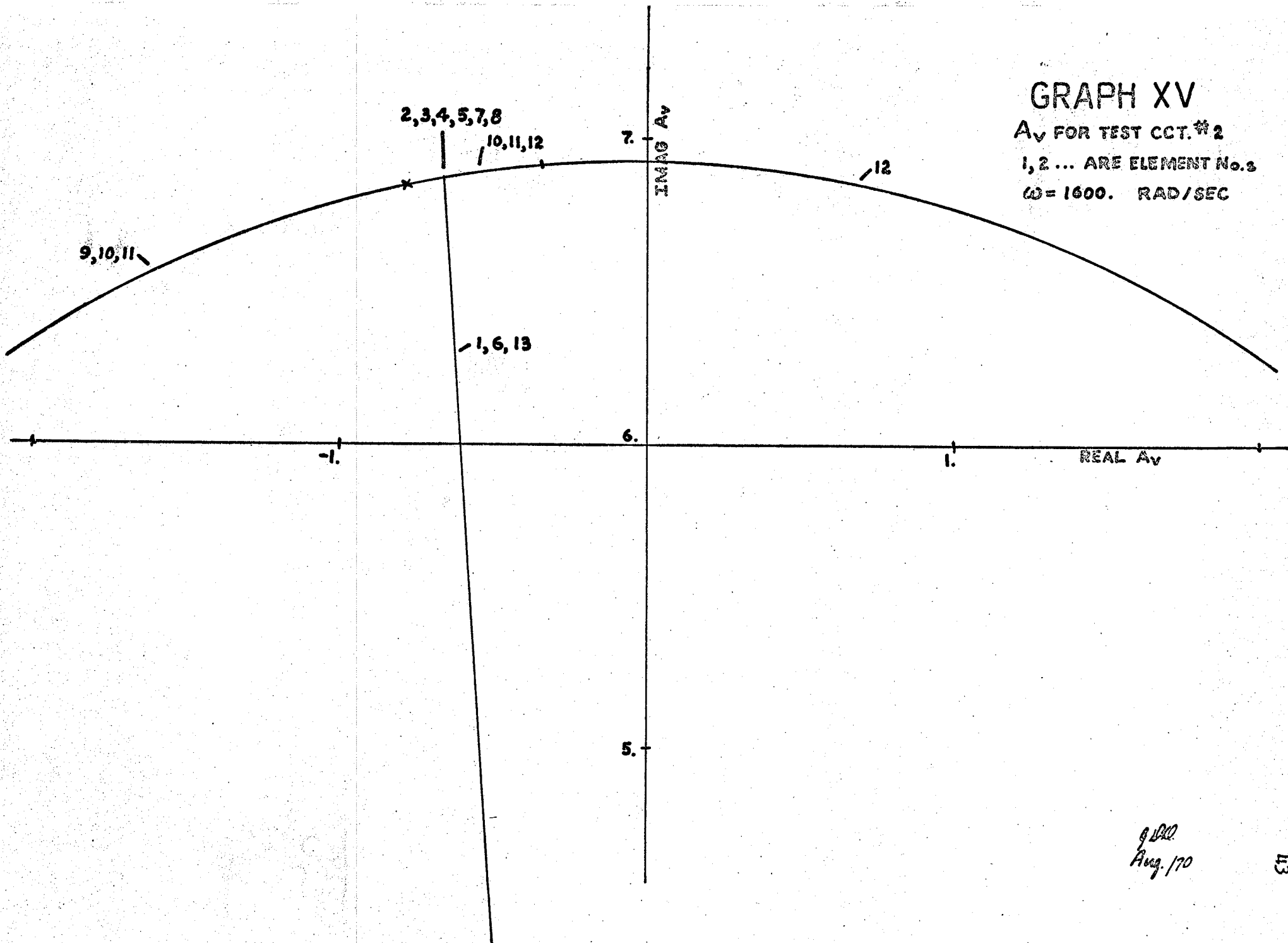

g DSD
Aug. 170

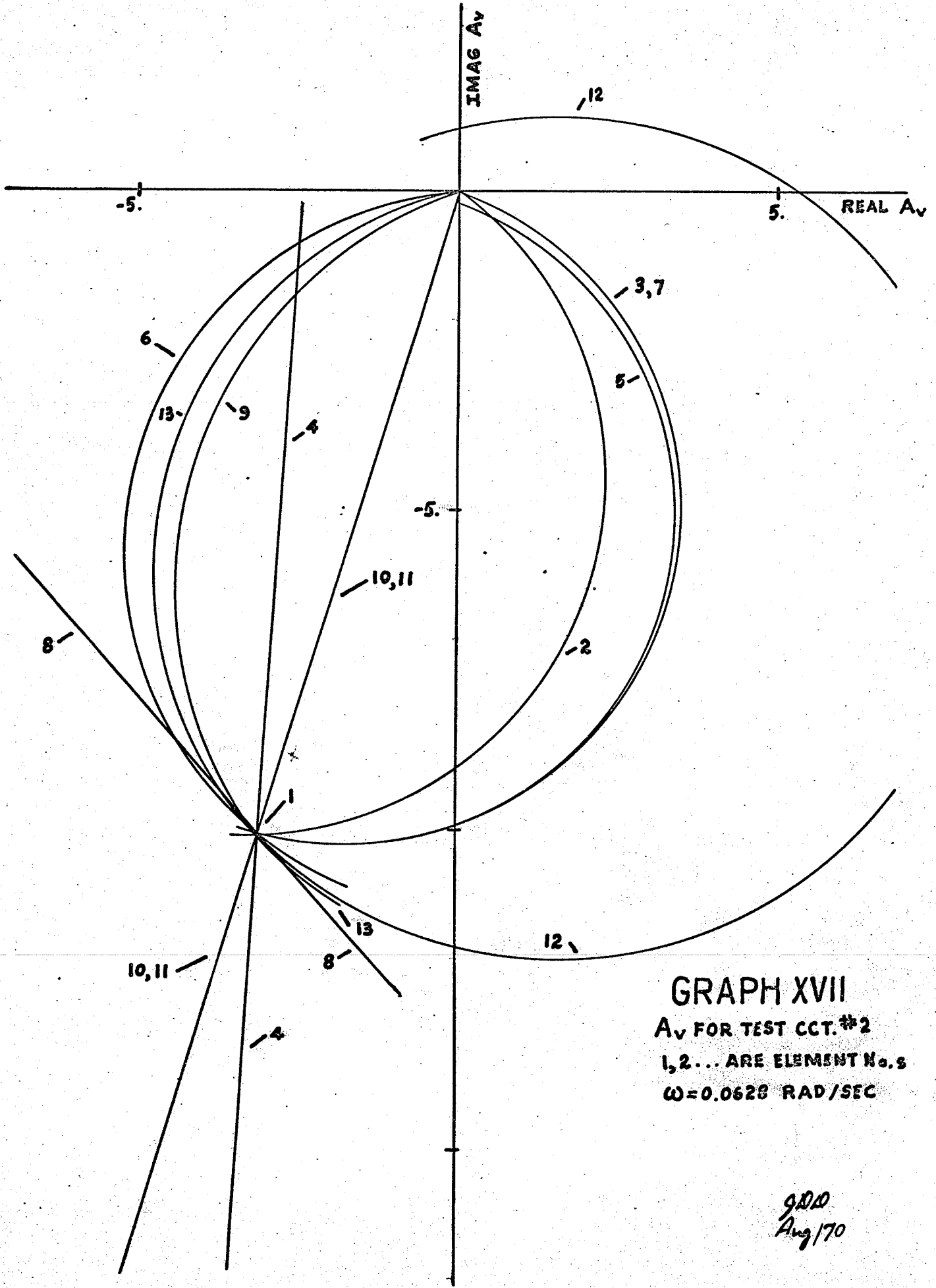

GRAPH XVII
A_v FOR TEST CCT. #2
1,2... ARE ELEMENT No.s
 $\omega = 0.0628$ RAD/SEC

9000
Aug/70

$R_4 = 3760$ ohms, and $R_5 = 3820$ ohms. Thus, the simulated fault is correctly identified, but the identification is not unique, and another n-port parameter must be chosen for a unique fault diagnosis.

At a low frequency ($\omega = .0002$ rad/sec), the loci of $T(x_1)$ and $T(x_4)$ are a "point", as is indicated on Graph X. The loci of $T(x_2)$, $T(x_3)$, $T(x_4)$, $T(x_5)$, $T(x_7)$ and $T(x_8)$ are "points" at the high frequency of 1600. radians/second. These results, that C_{0e} and C_3 have little effect at low frequencies, and that C_1 , C_2 , C_3 and consequently R_1 , R_2 , R_3 have little effect at high frequencies, allow the test designer to simplify the circuit model at some frequencies.

The circuit was tested in the laboratory for the faults (i) $C_2 = 0.25$ f, (ii) $C_3 = 0.465$ f, (iii) $C_3 = 1.0$ f and (iv) $R_5 = 3820$ ohms. Graphs XII and XIII, for the simulated tests, show that test frequencies (unscaled) of 79.9 and 1000. Hertz are adequate for isolating the above mentioned faults. The loci of $T(x_i)$, at the test frequencies, are plotted in Graphs XVI and XVII. Fault (iv) is marked on the Graphs with an "X". The faulty transfer functions were measured as:

<u>Frequency</u>	<u>T_F for Fault No.</u>			
	(i)	(ii)	(iii)	(iv)
79.9 Hertz	$1.88/\underline{-100^0}$	$2.03/\underline{-115.2}$	$2.24/\underline{-102.7}$	$1.72/\underline{-108}$
1000 Hertz	$10.96/\underline{-102.9}$	$7.7/\underline{-107.5}$	$15.7/\underline{-104.2}$	$9.23/\underline{-106}$

The faulty component can be uniquely identified from the plots in each of the cases. The computed values of the components are:

<u>Frequency</u>	<u>Value of Fault No.</u>			
	(i)	(ii)	(iii)	(iv)
79.9 Hertz	$.289-j.001$	$.487+j.002$	$1.03-j0.043$	$3847-j83$
1000 Hertz	$.129+j.052$	$.485+j.021$	$1.05+j0.053$	$3954+j208$

The measured and calculated results agree quite well, except that the computed value of C_2 at 1000 Hz. is $.129 - j.129$ instead of $.25 - j0$. This difference can be expected, since T_F , the measured transfer function, and A_V on Graph XVII, do not coincide.

Test Circuit # 3

The voltage transfer function, $A_V = V_2/V_1$, was selected for digital computer simulation of the fault diagnosis technique of the FM I.F. amplifier shown below. The transistor equivalent circuit that

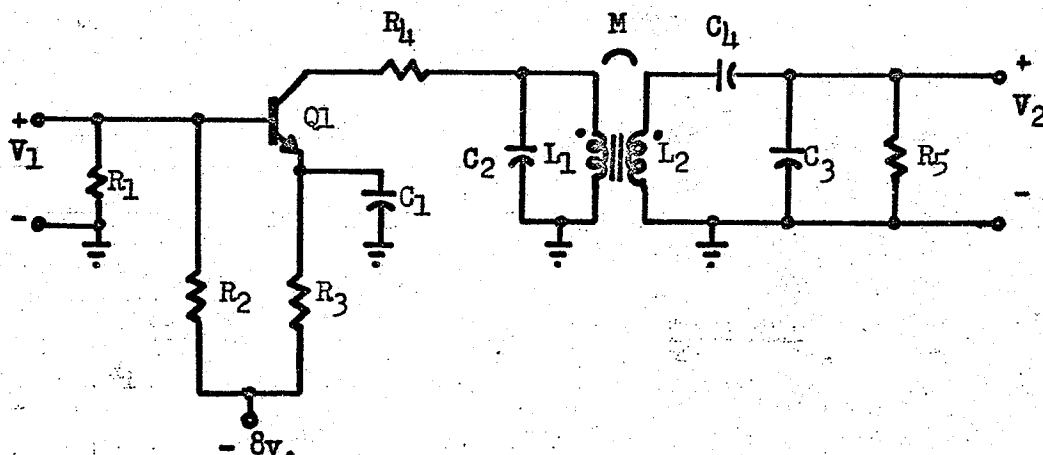

Element No.

- $C_1 = .01 \text{ f}$
 1 - $C_2 = 80\text{pf}$
 2 - $C_3 = 1008.2\text{pf}$
 5 - $C_4 = 80\text{pf}$
 *
 6 - $R_1 = 12\text{K}$
 6* - $R_2 = 2.7\text{K}$

Q1: 40245

Element No.

- $R_3 = 220$
 8 - $R_4 = 220$
 9 - $R_5 = 892$
 $L_1 = 2.7 \text{ H}$
 $L_2 = 2.7 \text{ H}$
 $M = 0.33 \text{ H}$

Fig. 10. Experimental Circuit # 3

* R_1 , R_2 and h_{ie} are parallel resistors for A.C. analysis and are combined.

was used is shown in Fig. 11.

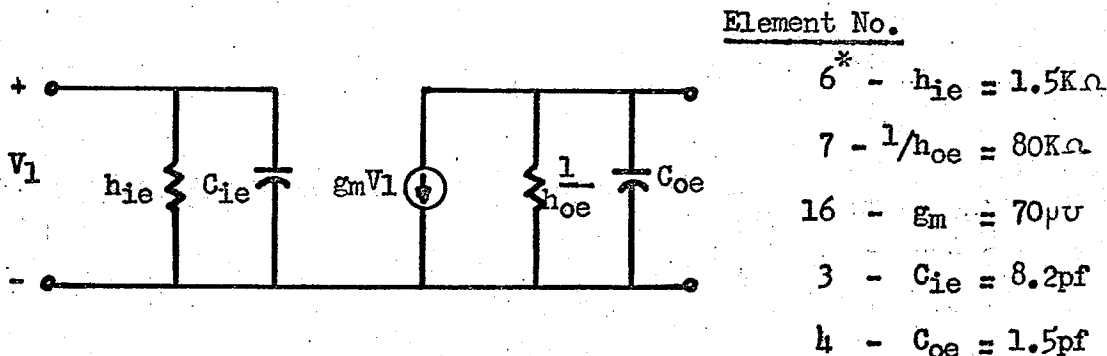

Fig. 11 Transistor equivalent circuit

Faults, which would affect the operation of the circuit near the I.F. frequency of 10.7 MHz, were analyzed by computer simulations. Since, as noted from Graph XV of the previous test circuit, the coupling capacitor acts as a short circuit at high frequencies, the emitter resistor is neglected in analyzing the circuit. Frequency scaling of 10^{-7} was used and the roots of the voltage transfer function were found to be:

zeros: 0,0

poles: $-.103$, $-.0043-j5.13$, $-.0043+j5.13$, $-.0088-j6.82$,
 $-.0088+j6.82$, -310 .

The test frequencies chosen were: 0.01, 1.0, 5.13, 6.0 and 6.82 radians/second. The loci of $T(x_i)$, which are plotted on Graphs XVIII to XXII, do not appear to isolate many faults uniquely, since the loci of two or more $T(x_i)$ are almost the same in many cases. However, if the graphs are examined systematically, the fault separation can be improved. For example, if a transfer function measurement, T_F , corresponding to $T(x_9)$ with x_9 faulty at $\omega = 5.13$ radians/second (Graph XX), is found to be near the loci $T(x_7)$, $T(x_9)$ and $T(x_{16})$, then the faulty component is either x_7 , x_9 or x_{16} , but Graph XX does not indi-

GRAPH XVIII

A_v FOR TEST CCT. # 3

1, 2 ... ARE ELEMENT No.s

$\omega = 0.01$ RAD/SEC

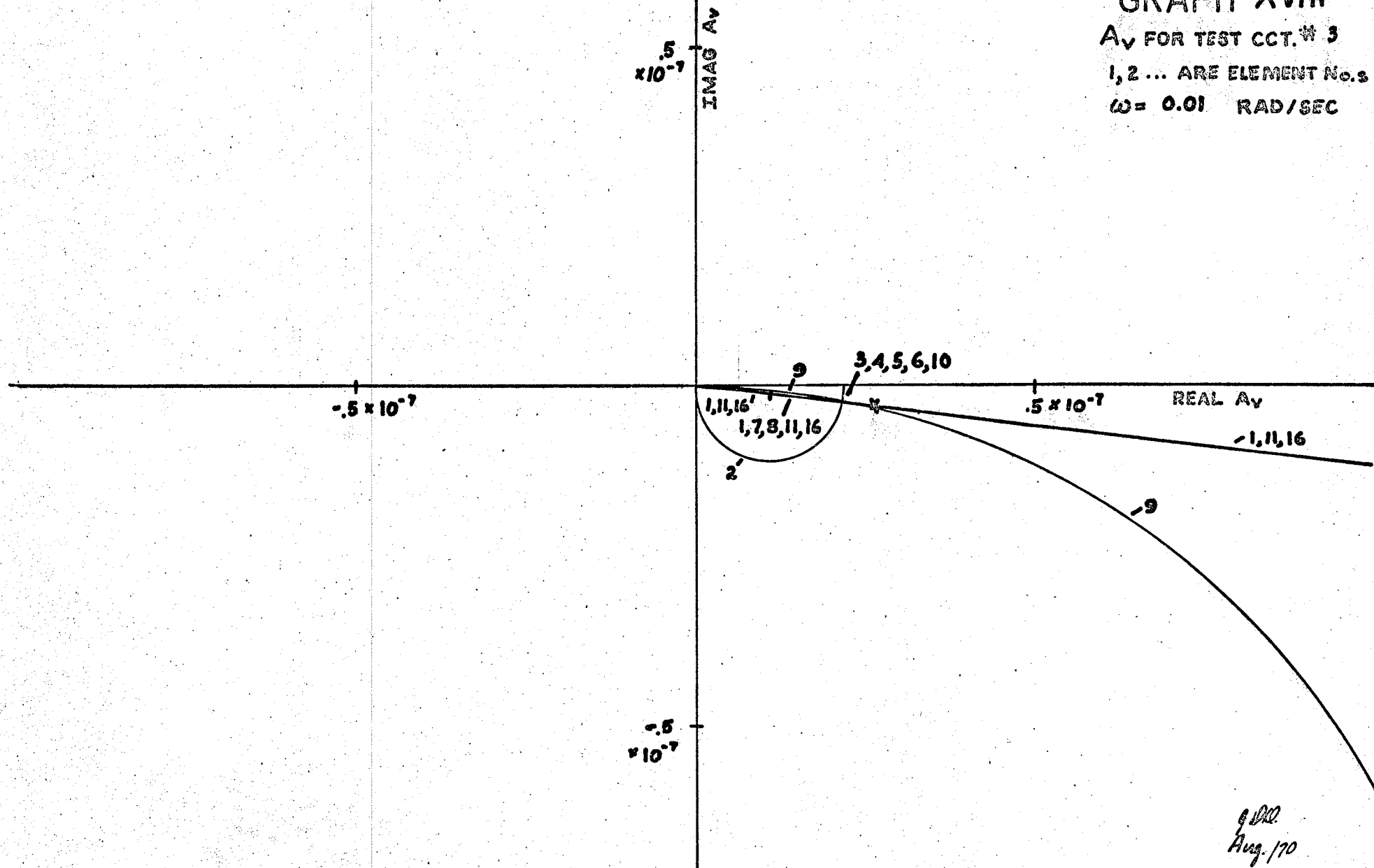

GRAPH XIX

A_v FOR TEST CCT. # 3

1, 2 ... ARE ELEMENT No.s

$\omega = 1.0$ RAD/SEC

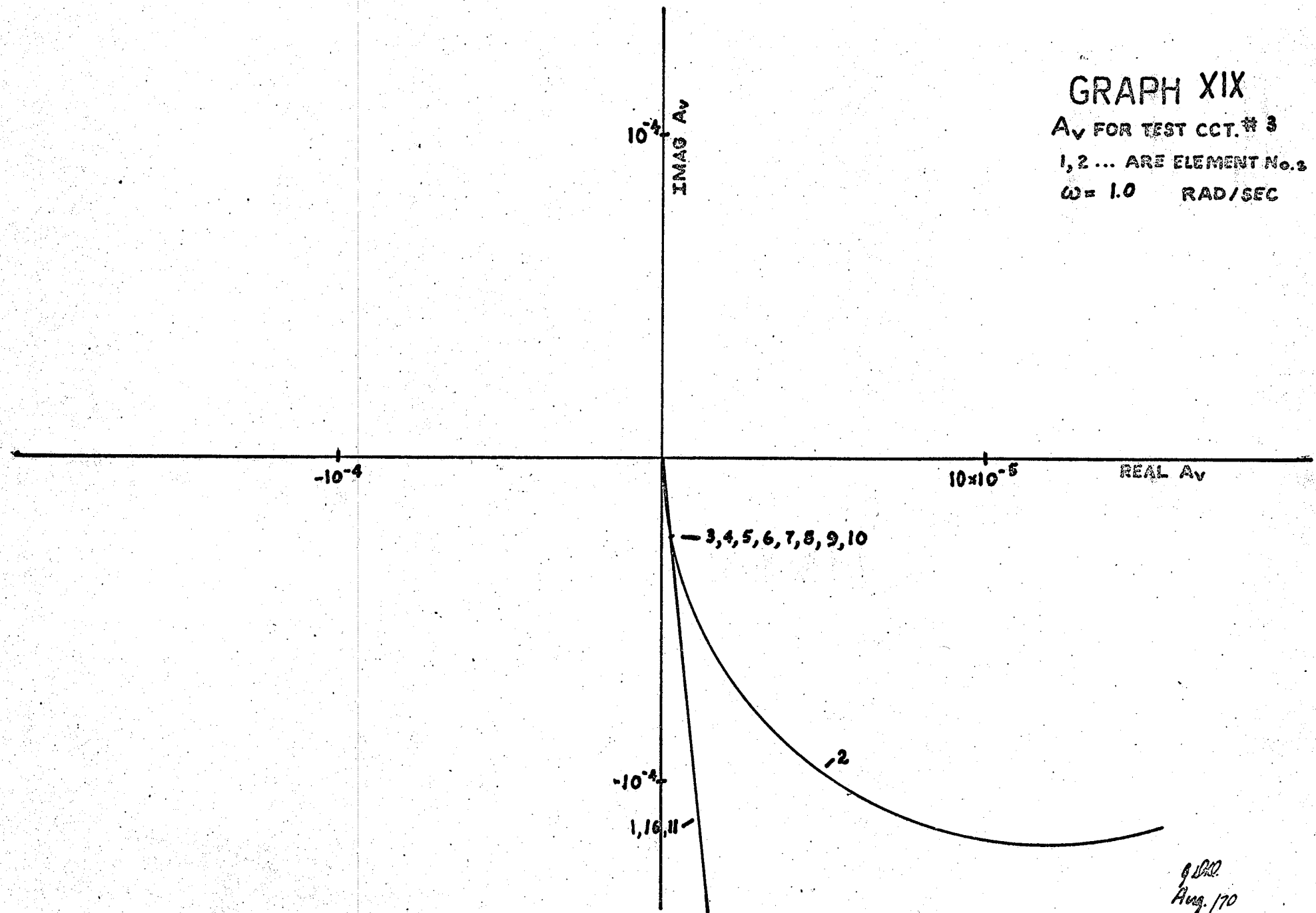

GRAPH XX
 A_v FOR TEST CCT. # 3
 1, 2 ... ARE ELEMENT No.s
 $\omega = 5.13$ RAD/SEC

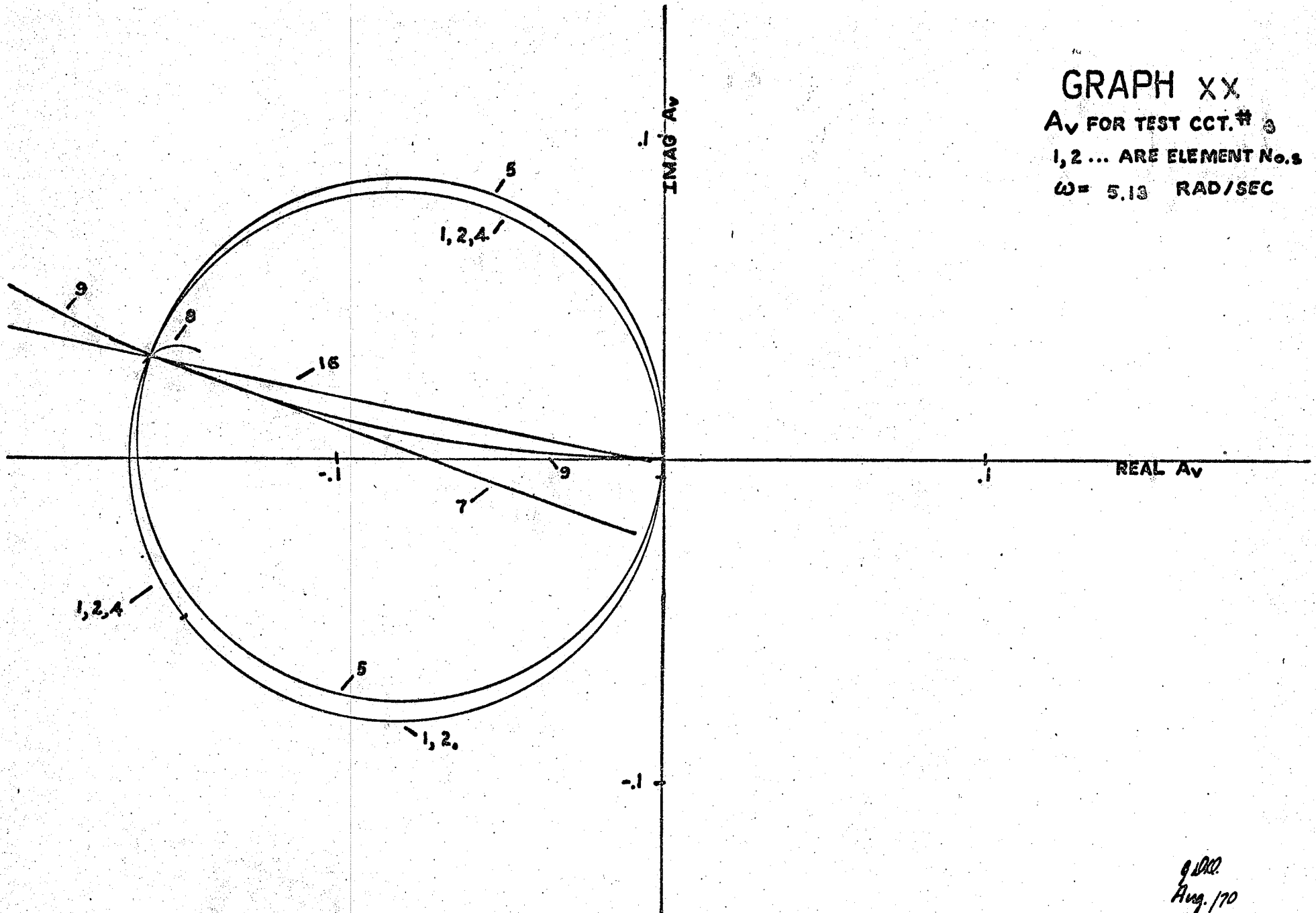

9 Dec
 Aug. 170

2nd Oct 9, 10

GRAPH XXII

A_v FOR TEST CCT. # 3

1, 2 ... ARE ELEMENT No.s

$\omega = 6.02$ RAD/SEC

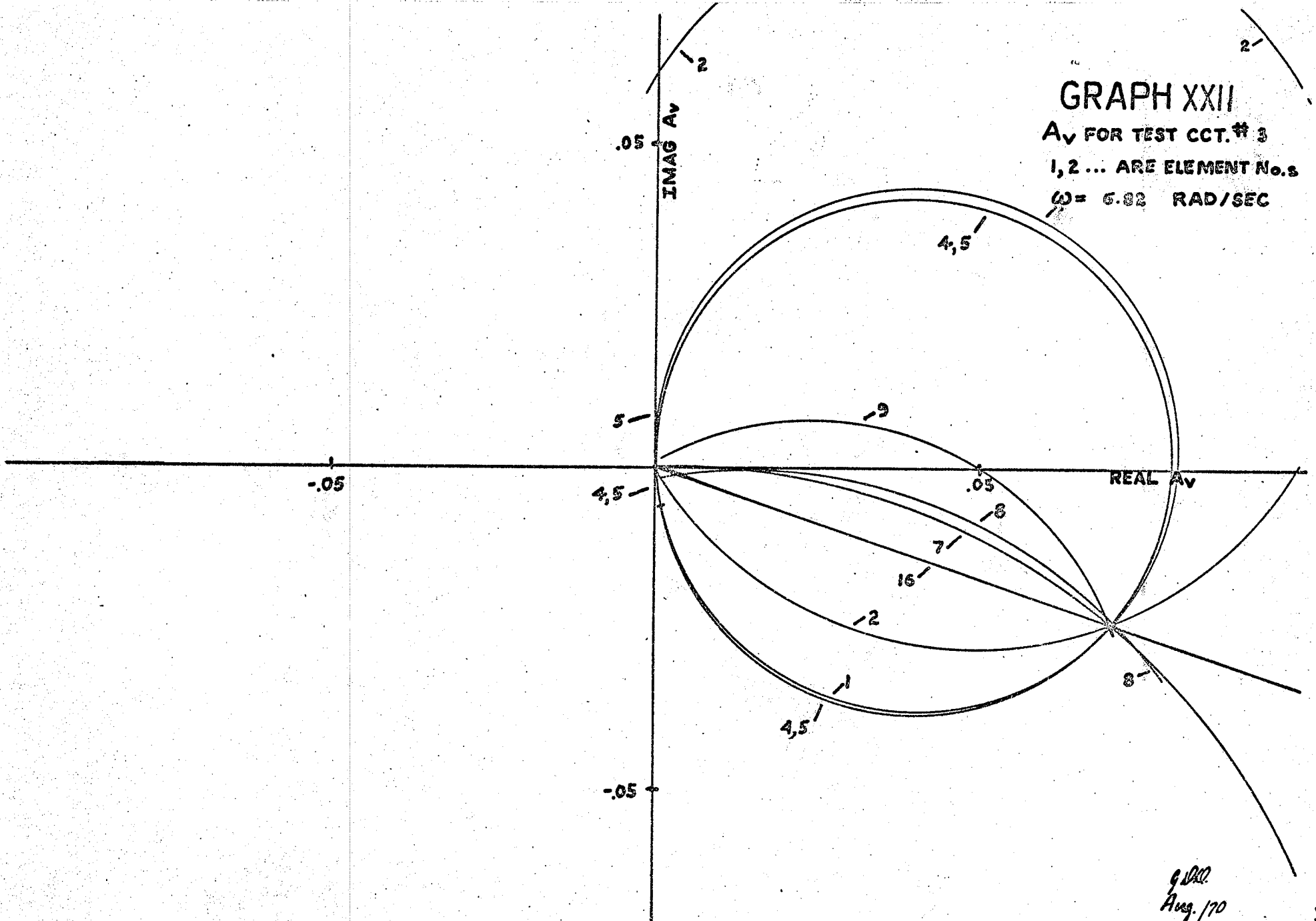

g. d. c.
Aug. 1970

cate which one. An examination of Graph XXI allows us to eliminate x_{16} (if T_F is not near the nominal transfer function point). An examination of Graph XXII is then used to eliminate x_7 , leaving us with the unique identification: x_9 is faulty. Similar methods must be employed in isolating other faults of this circuit. The computer output of this example is included in Appendix B.

COMPARISON OF THE VARIOUS FAULT ISOLATION TECHNIQUES

Of the four methods of fault isolation considered, none appears to surpass the others in every aspect.

The Neu method was presented only for resistive networks, and a complete comparison with the other three methods must be based partly on conjecture, since the addition of frequency dependent elements might alter some of the procedures. The Neu method is the only method based on more than one of the n-port parameters. Generally the other methods have the advantage of being based on analysis of only one of the transfer or driving point functions, although as was pointed out, previously, additional ones may be required on occasion. The Neu method, as well as the coefficient signature and the Moebius transform methods permit the value of the fault to be calculated directly and are not subject to the interpolation problem of the faulty dictionary technique.

The coefficient signature method of Moroz³, which was studied in some detail, did not appear as favourable as the Moebius transform method. One of the problems, encountered, was that of fitting a ratio of polynomials to the measured data. Several methods of curve fitting were examined, and, although the linear programming method appeared to be adequate, this method (or probably any curve fitting method) requires that a large computer be available after the fault diagnosis measurements have been completed. However, the method could be attractive for large firms or integrated circuit manufacturers having access to suitable computer facilities. The fault dictionary

method, presented by Seshu and Waxman⁶ is the only method which isolates faults on the basis of the magnitude response measurement only. This reduction in the number of test measurements is counter-balanced by an increase in the analysis requirements.

The new method presented in this thesis, is the only one which presents a graphical picture of the behaviour of the n-port parameter for all possible faults. Some of the advantages of this graphical approach include: (i) the response of the network for the extremes of parameter behaviour (short circuit or open circuit) is immediately available; (ii) the graphs indicate whether the test points which were selected are adequate in isolating all the faults or whether some of the test frequencies are redundant; this permits the test designer to choose the required test frequencies without finding the poles and zeroes of the circuit to be tested, and to reduce the number of test frequencies to a minimum by eliminating the redundant frequencies; (iii) the graphs show the test measurement error which is permissible for correct fault detection; (iv) if the fault is intermittent in such a manner that the value of the faulty component changes in value between test measurements, the faulty component could still be identified (although not evaluated) since the graphical technique is based on the comparison of the $T(x_i)$ loci (rather than a specific $T(x_i)$ points) with the faulty $T_F(x)$.

Although both phase and magnitude measurements must be used for the new method of fault diagnosis, this disadvantage is offset by a reduction in the number of test measurements that must be performed. For example, if in Example #1 (page 18) the test frequency of Graph # 1

had been selected for the first measurement, the fault $C_1 = 12f$ would have been isolated immediately and the remaining test frequencies would have been unnecessary. It was pointed out, previously, that N_M , the number of transfer or driving point functions that must be evaluated for the new technique, is typically less than 20% of N_S , the number required for the fault dictionary technique. The coefficient signature method of Moroz also requires N_M transfer functions, and it would appear that the method of Neu would require more transfer function calculations since it is based on more than a single driving point or transfer function.

The reduction in the number of transfer function calculations permits the use of the state equation technique of circuit analysis without an increase in the computation time. The previously discussed advantages of this analysis technique, namely, a decrease in computer storage, and a simultaneous solution of all n-port parameters, are of significance.

The method described in this thesis is the only one of the four which is feasible for implementation without the use of a large computer. Measurements and simple calculations can be used for the fault diagnosis precomputations.

The value of a faulty component is calculated precisely in each of the methods, except in the fault dictionary method where the value can only be determined as to the nearest discrete value listed in the dictionary. Thus the Moebius transform method avoids the interpolation problem associated with the fault dictionary method.

Although certain applications may favor the use of any one of

the fault diagnosis methods considered, the versatility in the implementation of the new method presented in this thesis, and the advantages in its use, should make the Moebius transformation method the most widely used.

VII

CONCLUSIONS AND RECOMMENDATIONS FOR FURTHER WORK

The results of simulations and laboratory measurements indicate that this new procedure of isolating faults in linear circuits is practical. An attractive feature is the variety of methods that can be used in the initial computation procedure: ECAP, topological formulas, or state equations may be used in analyzing the equivalent circuit of the network; the actual circuit may be analyzed by performing measurements if most of the elements are accessible, as in the case of discrete component networks. The calculations in the new fault isolation technique can be done with a small digital computer (or even a desk calculator) if the circuit is analyzed by laboratory measurements. However, a computer analysis of the equivalent circuit of the network is preferable if a large computer is available.

The visual indication of the behaviour of the network function with a variation of parameters is highly desirable. It provides a method of setting a confidence limit for the diagnosed faults, and provides an indication as to possible modifications to the circuit for a desired response. The graphs indicate which test frequencies are significant, and thus provide a means of eliminating redundant tests.

The precomputed coefficients of the Moebius transformation permit a direct computation of the fault value with a desk calculator or even a slide rule. This solves the interpolation problem of the fault dictionary method.

The problem of isolating a fault which also changes the value

of a bias dependent parameter remains to be solved, as does the problem of those faults which cause non-linear circuit operation such as oscillation or clipping. The effect of allowing the components, which are not faulty, to assume any value within their tolerance limits, rather than holding them at their nominal value, should be investigated.

This new method for fault isolation allows the manufacturer to include a relatively simple trouble-shooting guide with a piece of equipment in order to aid in fault diagnosis. The calculations required in compiling the guide are fewer than those of any other known technique and can be performed in a variety of ways. This method is also applicable to the fault diagnosis in integrated circuits and could be an aid to the manufacturer for process correction. Other applications, such as circuit modification and fault analysis in remote equipment, may aid in giving this new method widespread use.

BIBLIOGRAPHY

1. Ahlfors, L.V., Complex Analysis, McGraw-Hill Book Company, Inc., New York, 1953, pp. 22-26.
2. Maenpaa, J.H., Stehman, C.J., and Stahl, W.J., "Fault Isolation in Conventional Linear Systems: A Progress Report," IEEE Trans. Reliability, vol R-18, pp. 12-14, February 1969.
3. Moroz, D.F., "Fault Isolation in Active Linear Networks by Transfer Function Analysis," Masters Thesis, University of Manitoba, October 1968.
4. Neu, E.C., "A New n-Port Network Theorem," Proc. of the 13-th Midwest Sym. on Circuit Theory, pp. IV.5.1-IV.5.10, May 7-8, 1970.
5. Parker, S.R., Peskin, E., Chirlan, P.M., "Application of a Bilinear Theorem to Network Sensitivity," IEEE Trans. Circuit Theory (Correspondence), vol. CT-12, pp. 448-450, September 1965.
6. Seshu, S., and Waxman, R., "Fault Isolation in Conventional Linear Systems - A Feasibility Study," IEEE Trans. Reliability, vol. R-15, pp. 11-16, May 1966.
7. Sorensen, E.V., "General Relations Governing the Exact Sensitivity of Linear Networks," Proc. IEE, London, vol. 114, pp.1209-1212, September 1967.
8. Wylie, C.R., Advanced Engineering Mathematics, McGraw-Hill Book Company, Inc., New York, 1951, pp. 391-395.

APPENDIX A

The fault diagnosis computer program

The Fortran IV computer program, shown below, was used for the fault diagnosis computations.

page 1 of 3

```

DIMENSION PIX(2,2),S(2,2),PI(2,2),T(20),T1(20),T2(20),T3(20),
1 WORK(5,5),W(20),XNUM(20),XDEN(20),X(20,20),EL(20),XMAGI(20),
1 TANGI(6),F(20)
COMPLEX S,T1,T2,T3,X,PIX,T,QI,DTX,DEN,CENTRE,RADIUS,TZERO,TINFIN
COMMON PIX,PI,S
READ(5,1) NRTFCN,NCTFCN
READ(5,2) Z,Y,TOLZER
READ(5,1) NFREQ
1 FORMAT(2I2)
READ(5,2) (F(I),I=1,NFREQ)
2 FORMAT(G15.8)
C MAGN. OF TR. FCN. IS READ AS XNUM AND PHASE AS XDEN
READ(5,40) (XNUM(I),XDEN(I),I=1,NFREQ)
40 FORMAT(2G10.4)
DO 41 I=1,NFREQ
W(I)=2.*3.14159*F(I)
XDEN(I)=.01745329*XDEN(I)
41 T(I)=CMPLX(XNUM(I)*COS(XDEN(I)),XNUM(I)*SIN(XDEN(I)))
C READING THE COMPUTED TRANSFER FCNS. FROM STATEEQ PROG. FOR ELEMENT
C VALUES OF X1,X2,X3
READ(3,3) NOELEM
3 FORMAT(I2)
READ(5,4) (EL(I),I=1,NOELEM)
DO 21 L=1,NOELEM
X1=Z*EL(L)
X2=Y*EL(L)
X3=EL(L)
DO 29 LL=1,3
IF(L.GT.1.AND.LL.EQ.3) GO TO 13
READ(3,1) NR,M
IDEG=M+1
DO 5 K=1, IDEG
READ(3,4) ((WORK(I,J),I=1,NR),J=1,NR)
4 FORMAT(G15.8)
5 XNUM(IDEG-K+1)=WORK(NRTFCN,NCTFCN)
READ(3,4) (XDEN(M-K+1),K=1,M)
XDEN(IDEG)=1.
DO 6 I=1,NFREQ
W1=W(I)
CALL MAG(XNUM,XDEN,M,W1,XR,XI, XMAG,IER)
7 IF(IER.EQ.1) WRITE(6,7) LL,I
FORMAT(' MAGNITUDE OF T',I1,' (' ,I2,' ) IS INFINITE')
IF(IER.NE.1.AND.LL.EQ.1) T1(I)=CMPLX(XR,XI)
IF(IER.NE.1.AND.LL.EQ.2) T2(I)=CMPLX(XR,XI)
IF(IER.NE.1.AND.LL.EQ.3) T3(I)=CMPLX(XR,XI)
XMAGI(I)=XMAG
6 CONTINUE
WRITE(6,28)
28 FORMAT(' MAGNITUDE OF TR. FCN. IS')
WRITE(6,12) (XMAGI(I),I=1,NFREQ)
29 CONTINUE
13 WRITE(6,14)
14 FORMAT(4X,' REAL T1',7X,' IMAG T1',7X,' REAL T2',7X,' IMAG T2',
1 7X,' REAL T3',7X,' IMAG T3',7X,' REAL T ',7X,' IMAG T ')
WRITE(6,12) (T1(I),T2(I),T3(I),T(I),I=1,NFREQ)
12 FORMAT(8(3X,G12.5))
DO 21 I=1,NFREQ
C TO SEE IF THE TR.FCN.IS INDEPENDENT OF ELEMENT(J)
IF(ABS(REAL(T1(I)-T2(I))).LT.TOLZER.AND.ABS(AIMAG(T1(I)-T2(I))).LT
1 .TOLZER.OR.ABS(REAL(T2(I)-T3(I))).LT.TOLZER.AND.ABS(AIMAG(T2(I)
2 -T3(I))).LT.TOLZER) GO TO 20
PI(2,1)=X1-X2
PI(2,2)=X2-X3

```

```

PI(1,1)=PI(2,1)*X3
PI(1,2)=PI(2,2)*X1
S(1,1)=T2(1)-T3(1)
S(1,2)=-S(1,1)*T1(1)
S(2,1)=T2(1)-T1(1)
S(2,2)=-S(2,1)*T3(1)
CALL MULTCX
WRITE (6,15) I,L
15  FORMAT (' PIX(W=',12,' ) FOR ELEMENT',12)
C   PIX(1,1)=D, PIX(1,2)=-B, PIX(2,1)=-C, PIX(2,2)=A IF WE WRITE T=
C   (AX+B)/(CX+D)
WRITE (6,22) ((PIX(K,J),J=1,2),K=1,2)
22  FORMAT (2(3X,G15.8))
    Q1=PIX(1,1)-PIX(2,1)*EL(L)
    IF (ABS(REAL(Q1)).LT.TOLZER.AND.ABS(AIMAG(Q1)).LT.TOLZER) GO TO 18
    DTX=(PIX(1,1)*PIX(2,2)-PIX(1,2)*PIX(2,1))/Q1**2
    Q1=-PIX(2,1)/Q1
    GO TO 42
18  Q1=CMPLX(10.**20,10.**20)
    DTX=CMPLX(10.**20,10.**20)
42  DEN=CONJG(PIX(1,1)*PIX(2,1)-CONJG(PIX(2,1))*PIX(1,1))
    RADIUS=PIX(1,1)*PIX(2,2)-PIX(1,2)*PIX(2,1)
    IF(CABS(RADIUS)*TOLZER.GT.CABS(DEN)) GO TO 30
    CENTRE=(CONJG(PIX(1,1))*PIX(2,2)-CONJG(+PIX(2,1))*PIX(1,2))/(-DEN)
    RADIUS=CMPLX(CABS(RADIUS/DEN),0.)
    TZERO=-PIX(1,2)/PIX(1,1)
    TINFIN=-PIX(2,2)/PIX(2,1)
    WRITE(6,34) CENTRE,RADIUS,TZERO,TINFIN
34  FORMAT (40X,' CENTRE AT',2(3X,G12.5),' RADIUS OF',2(3X,G12.5),/
1    1 40X,' TZERO= ',2(3X,G12.5),' TINFIN= ',2(3X,G12.5))
    GO TO 19
C   TO GET REAL + IMAG AXIS INTERCEPTS
30  DEN=PIX(1,1)*CONJG(PIX(2,2))-PIX(2,1)*CONJG(+PIX(1,2))
    A=AIMAG(+PIX(1,2)*CONJG(PIX(2,2)))
    YINT=-A/REAL(DEN)
    XINT=-A/AIMAG(DEN)
    WRITE(6,38) XINT,YINT
38  FORMAT (' REAL + IMAG. AXIS INTERCEPTS IN THE T-PLANE ARE:',
1    1 2(3X,G12.5))
C
19  WRITE (6,17) I,Q1
17  FORMAT (' THE 1/(Q+X) IN NEUS K AT W=',12,' IS ',2(3X,G12.5))
    DTXMAG=CABS(DTX)
    WRITE (6,24) I,DTX,DTXMAG
24  FORMAT (' PARTIAL OF T W.R.T. X AT W',12,' IS',3(3X,G12.5))
    X(L,1)=(PIX(1,1)*T(1)+PIX(1,2))/(PIX(2,1)*T(1)+PIX(2,2))
    GO TO 21
20  X(L,1)=-1.
21  CONTINUE
33  WRITE (6,16)
16  FORMAT (' THE COMPLEX SOLNS FOR X(W,ELEMENT) ARE:')
    WRITE (6,23) ((X(I,J),J=1,NFREQ),I=1,NOELEM)
23  FORMAT (2(3X,G12.5))
    WRITE (6,27) NRTFCN,NCTFCN,Z,Y,TOLZER
27  FORMAT (' TR.FCN.,Z,Y,TOLZER ARE:',212,3(3X,G12.5))
    WRITE (6,25)
25  FORMAT (' NOM. CCT.ELEMENTS ARE:')
    WRITE (6,26) (EL(I),I=1,NOELEM)
26  FORMAT (/10G12.5)
    WRITE(6,26) (I(I),I=1,NFREQ)
    CALL EXIT
    END

```

```

SUBROUTINE MAG (A,B,N,OMEGA,VREAL,VIMAG,VMAG,IER)
DIMENSION A(10),B(10)
IER=0
C   COMPUTE REAL PART OF NUMERATOR AND DENOMINATOR
AREAL=A(1)
BREAL=B(1)
S=1.
DO 100 J=2,N,2
JA=J+1
S=-S
CREAL=S*OMEGA**J
AREAL=AREAL+A(JA)*CREAL
BREAL=BREAL+B(JA)*CREAL
100 C   COMPUTE IMAGINARY PART OF NUMERATOR AND DENOMINATOR
AIMAG=0.
BIMAG=0.
S=1.
DO 105 J=1,N,2
JA=J+1
S=-S
CIMAG=S*OMEGA**J
AIMAG=AIMAG-A(JA)*CIMAG
BIMAG=BIMAG-B(JA)*CIMAG
105 C   TEST TO SEE IF FUNCTION IS INFINITE
DENOM=BREAL**2+BIMAG**2
IF (DENOM) 110,115,110
115 WRITE (6,120) OMEGA
120 FORMAT (1H0,29HMAGNITUDE IS INFINITE, OMEGA=',1PE15.8/)
IER=1
RETURN
C   COMPUTE MAGNITUDE OF FUNCTION
110 VREAL=(AREAL*BREAL+AIMAG*BIMAG)/DENOM
VIMAG=(AIMAG*BREAL-AREAL*BIMAG)/DENOM
VMAG=SQRT(VREAL**2+VIMAG**2)
RETURN
END
SUBROUTINE MULTCX
COMPLEX A,C
COMMON A,B,C
DIMENSION A(2,2),B(2,2),C(2,2)
A(1,1)=B(1,1)*C(1,1)+B(1,2)*C(2,1)
A(1,2)=B(1,1)*C(1,2)+B(1,2)*C(2,2)
A(2,1)=B(2,1)*C(1,1)+B(2,2)*C(2,1)
A(2,2)=B(2,1)*C(1,2)+B(2,2)*C(2,2)
RETURN
END

```

APPENDIX B

In order to relate the computer output to the description used in this thesis, the significant output for Example # 1 will be listed. The coefficients a, b, c and d, of the Moebius transformation, are listed as real and imaginary parts under the heading PIX. For example, at test frequency # 1, the a, b, c, d corresponding to x_1 are:

$$\begin{aligned} a &= 0.7225 + j2.348 \\ b &= -0.795 - j2.583 \\ c &= 0.2347 - j.0072 \\ d &= -0.2338 + j.00072 \end{aligned}$$

The centre of the arc of $T(x_1)$ is at $0.5998 - j.000064$; the radius of the circle is 0.50018 ; $T(0)$ is $1.1 - j.0000995$, and $T(\infty)$ is at $.0999 - j.002998$.

Computer output for Example # 1

The following output was obtained at the test frequencies 0.01, 0.3, 3.0 and 100. radians/second for the driving point impedance, Z_{11} , of Example # 1.

```

PIX# 1 1 FOR ELEMENT 1
  0.72252750      2.3483419
-0.79501563     -2.5831099
  0.23474693E-01 -0.72252750E-03
-0.23382902E-02  0.72312355E-03
                                CENTRE AT  0.59983      -0.64054E-04 RADIUS OF  0.50018      0.0
                                TZERO=    1.1000      -0.99335E-04 TINF=  0.99650E-01  -0.13314E-03
THE 1/(Q+X) IN NEUS K AT W= 1 IS  0.99045E-03  0.98975E-02
PARTIAL OF T W.R.T. X AT W 1 IS -0.19606E-02 -0.97049E-02  0.99010E-02
PIX# 2 1 FOR ELEMENT 1
  -2.221350      -2.5791845
  1.3515081      2.8331965
-0.77375710     0.35651719
  0.76207280E-01 -0.38938522E-01
                                CENTRE AT  0.59991      -0.29970E-02 RADIUS OF  0.50000      0.0
                                TZERO=    1.0999      -0.29890E-02 TINF=  0.99910E-01  -0.29981E-02
THE 1/(Q+X) IN NEUS K AT W= 2 IS  0.90000E-01  0.30000E-01
PARTIAL OF T W.R.T. X AT W 2 IS -0.18000E-01  0.24000E-01  0.30000E-01
PIX# 3 1 FOR ELEMENT 1
-0.3658347E-01  -0.44927597E-02
  0.40136874E-01  0.38004087E-02
-0.13493595E-01  0.10095150
  0.17882660E-02  -0.10458715E-01
                                CENTRE AT  0.59164      -0.27532E-01 RADIUS OF  0.49990      0.0
                                TZERO=    1.0915      -0.27377E-01 TINF=  0.91743E-01  -0.27523E-01
THE 1/(Q+X) IN NEUS K AT W= 3 IS  0.99889E-01  0.33303E-02
PARTIAL OF T W.R.T. X AT W 3 IS -0.22172E-03  0.33222E-02  0.33296E-02
PIX# 4 1 FOR ELEMENT 1
-0.33393735E-04  0.13969839E-05
  0.33349497E-04  -0.20989633E-06
-0.12227101E-04  0.33334450E-02
-0.32992510E-04  -0.34215045E-05
                                CENTRE AT  0.50012      -0.99031E-02 RADIUS OF  0.49913      0.0
                                TZERO=    0.99719      0.35431E-01 TINF=  0.99010E-03  -0.99010E-02
PIX# 1 1 FOR ELEMENT 2
-0.95367432E-06  0.25123358E-04
-0.14478710E-05  -0.27481425E-04
-0.95367432E-06  0.11929292E-06
  0.1032847E-05  -0.22446329E-06
                                CENTRE AT  1.0914      -0.99107E-01 RADIUS OF  0.13115E-02  0.0
                                TZERO=    1.0901      -0.99010E-01 TINF=  1.0927      -0.98782E-01
THE 1/(Q+X) IN NEUS K AT W= 1 IS -0.47676E-02  -0.38141E-01
PARTIAL OF T W.R.T. X AT W 1 IS  0.19700E-06  -0.10004E-03  0.10004E-03
PIX# 2 1 FOR ELEMENT 2
  0.47070127E-04  0.74594683E-03
-0.23721374E-03  -0.1243781E-03
  0.22143126E-04  -0.17583370E-05
-0.16649719E-05  0.67919027E-05
                                CENTRE AT  0.14946      -0.29996      RADIUS OF  0.50544E-01  0.0
                                TZERO=    0.20000      -0.30000      TINF=  0.98924E-01  -0.29887
THE 1/(Q+X) IN NEUS K AT W= 2 IS  0.57022E-03  0.29647E-01

```

PARTIAL OF T W.R.T. X AT W 3 IS 0.82565E-01 0.27522
 PARTIAL OF T W.R.T. X AT W 3 IS -0.15150E-01 -0.22978E-01 0.27523E-01
 PIX(W= 4) FOR ELEMENT 2
 -0.30329777E-03 -0.11540577E-03
 0.30445153E-04 0.11238893E-04
 -0.1152156E-02 0.30329898E-02
 -0.30320516E-05 -0.11572993E-05
 CENTRE AT 0.51108E-01 -0.33295E-01 RADIUS OF 0.50002E-01 0.0
 TZERO= 0.10111 -0.33296E-03 TINFIN= -0.11051E-02 -0.33295E-01
 THE 1/(Q*X) IN NEUS K AT W= 3 IS 0.82565E-01 0.27522
 PARTIAL OF T W.R.T. X AT W 3 IS -0.15150E-01 -0.22978E-01 0.27523E-01
 PIX(W= 4) FOR ELEMENT 2
 -0.30329777E-03 -0.11540577E-03
 0.30445153E-04 0.11238893E-04
 -0.1152156E-02 0.30329898E-02
 -0.30320516E-05 -0.11572993E-05
 CENTRE AT 0.50001E-01 -0.99990E-03 RADIUS OF 0.50000E-01 0.0
 TZERO= 0.10000 -0.99990E-03 TINFIN= 0.99989E-06 -0.10001E-02
 THE 1/(Q*X) IN NEUS K AT W= 4 IS 0.99010 0.99009E-01
 PARTIAL OF T W.R.T. X AT W 4 IS -0.19606E-02 0.57049E-02 0.99009E-02
 MAGNITUDE OF TR. FCN. IS 0.59928 0.34502 0.11186 0.10946E-01
 MAGNITUDE OF TR. FCN. IS 1.5824 0.36316 0.11070 0.10946E-01
 REAL T1 IMAG T1 REAL T2 IMAG T2 REAL T3 IMAG T3 REAL T IMAG T
 0.59875 -0.25039E-01 1.5670 -0.22015 1.0901 -0.99110E-01 1.0858 -0.11840
 0.25376 -0.23377 0.17050 -0.32064 0.19991 -0.30300 0.17154 -0.26088
 0.93955E-01 -0.60709E-01 0.92483E-01 -0.60840E-01 0.92853E-01 -0.60819E-01 0.92514E-01 -0.55279E-01
 0.99210E-03 -0.10901E-01 0.99076E-03 -0.10901E-01 0.99110E-03 -0.10901E-01 0.99079E-03 -0.10734E-01
 PIX(W= 1) FOR ELEMENT 3
 -0.23483467 -0.72261274E-01
 0.23477197E-01 -0.72498322E-02
 0.72250366E-02 0.23483515E-01
 -0.23555696 0.69913149E-01
 CENTRE AT 0.99996E-01 -5.0001 RADIUS OF 5.0000 0.0
 TZERO= 0.10000 -0.99727E-04 TINFIN= 0.99558E-01 -10.000
 THE 1/(Q*X) IN NEUS K AT W= 1 IS 0.98966E-02 0.99010E-01 0.99010
 PARTIAL OF T W.R.T. X AT W 1 IS 0.97049 -0.19606 0.99010
 PIX(W= 2) FOR ELEMENT 3
 0.8592250E-02 -0.40723532E-02
 -0.84675848E-03 0.43262076E-03
 -0.12217283E-01 -0.25791734E-01
 0.98951757E-02 -0.15321933E-02
 CENTRE AT 0.99909E-01 -0.16966 RADIUS OF 0.16667 0.0
 TZERO= 0.99911E-01 -0.29950E-02 TINFIN= 0.99910E-01 -0.33633
 THE 1/(Q*X) IN NEUS K AT W= 2 IS 0.90000 0.30000
 PARTIAL OF T W.R.T. X AT W 2 IS -0.80000E-01 -0.60000E-01 0.10000E 00
 PIX(W= 3) FOR ELEMENT 3
 0.1490161E-05 -0.12211502E-04
 0.19094482E-06 0.11610391E-05
 -0.3665096E-03 -0.44964254E-04
 0.36361016E-04 -0.18179184E-04
 CENTRE AT 0.91743E-01 -0.44182E-01 RADIUS OF 0.16674E-01 0.0
 TZERO= 0.91721E-01 -0.27508E-01 TINFIN= 0.91743E-01 -0.60856E-01
 THE 1/(Q*X) IN NEUS K AT W= 3 IS 0.99891 0.33280E-01 0.11098E-02
 PARTIAL OF T W.R.T. X AT W 3 IS -0.11074E-02 -0.73893E-04
 PIX(W= 4) FOR ELEMENT 3
 0.0 0.18626451E-03
 -0.20638158E-10 -0.18429702E-11
 -0.3334348E-06 0.3725902E-08
 0.28950264E-09 -0.36382177E-08
 CENTRE AT 0.99077E-03 -0.10991E-01 RADIUS OF 0.89536E-04 0.0
 TZERO= 0.98944E-03 -0.11080E-01 TINFIN= 0.99010E-03 -0.10901E-01
 THE 1/(Q*X) IN NEUS K AT W= 4 IS 1.00000 -0.55864E-02

PARTIAL OF T W.R.T. X AT W 4 IS -0.10004E-05 0.36901E-08 0.10004E-05
 MAGNITUDE OF TR. FCN. IS 1.0948 0.33608 0.64435E-01 0.10788E-01
 MAGNITUDE OF TR. FCN. IS 1.1444 0.39552 0.15439 0.10976E-01
 REAL T1 IMAG T1 REAL T2 IMAG T2 REAL T3 IMAG T3 REAL T IMAG T
 1.0401 -0.9103E-01 1.1401 -0.99235E-01 1.0901 -0.99110E-01 1.0858 -0.11840
 0.14999 -0.30075 0.24970 -0.30674 0.19991 -0.30300 0.17154 -0.26088
 0.50910E-01 -0.40631E-01 0.12585 -0.89429E-01 0.92853E-01 -0.60819E-01 0.92514E-01 -0.55279E-01
 0.19241E-02 -0.10615E-01 0.66472E-03 -0.10956E-01 0.99110E-03 -0.10901E-01 0.99079E-03 -0.10734E-01
 PIX(W= 4) FOR ELEMENT 4
 -0.25000283E-03 0.75057011E-06
 0.24745381E-03 0.25495945E-04
 -0.48428774E-07 0.25063728E-05
 -0.25019050E-03 -0.17371494E-05
 CENTRE AT 0.99037 -49.973 RADIUS OF 49.874 0.0
 TZERO= 0.99010 -0.99010E-01 TINFIN= -1.2352 -99.798
 THE 1/(Q*X) IN NEUS K AT W= 1 IS -0.21376E-03 0.10025E-01 0.99999
 PARTIAL OF T W.R.T. X AT W 1 IS 0.99999 -0.19997E-02 0.99999
 PIX(W= 2) FOR ELEMENT 4
 -0.24859793E-03 0.22426364E-04
 0.18132007E-04 -0.76822238E-04
 0.67129731E-05 0.74604061E-04
 -0.27164770E-03 0.16974984E-04
 CENTRE AT 0.10003 -1.9661 RADIUS OF 1.6661 0.0
 TZERO= 0.10000 -0.30000 TINFIN= 0.99301E-01 -3.6323
 THE 1/(Q*X) IN NEUS K AT W= 2 IS 0.89292E-02 0.29983
 PARTIAL OF T W.R.T. X AT W 2 IS 0.99730 -0.59893E-01 0.99910
 PIX(W= 3) FOR ELEMENT 4
 -0.14036936E-03 0.16410921E-03
 -0.53082586E-05 -0.8559450E-05
 0.8230992E-03 0.42110542E-03
 -0.15499567E-03 0.18002954E-03
 CENTRE AT 0.11094E-02 -0.19996 RADIUS OF 0.16667 0.0
 TZERO= 0.11101E-02 -0.33296E-01 TINFIN= 0.11079E-02 -0.36663
 THE 1/(Q*X) IN NEUS K AT W= 3 IS 0.82565 2.7523
 PARTIAL OF T W.R.T. X AT W 3 IS 0.76593 -0.50501 0.91743
 PIX(W= 4) FOR ELEMENT 4
 0.11542488E-06 -0.30329409E-06
 0.30313529E-09 0.11576162E-09
 -0.30329684E-04 -0.11542046E-04
 -0.12899257E-06 -0.33361442E-06
 CENTRE AT 0.99242E-06 -0.59999E-02 RADIUS OF 0.50000E-02 0.0
 TZERO= 0.11438E-05 -0.99991E-03 TINFIN= 0.99899E-06 -0.11000E-01
 THE 1/(Q*X) IN NEUS K AT W= 4 IS 0.99010 -0.19606E-02 0.99010E-02
 PARTIAL OF T W.R.T. X AT W 4 IS -0.19606E-02 0.57049E-02 0.99010E-02
 THE COMPLEX SOLNS FOR (X,W,ELEMENT) ARE:
 12.000 0.33456E-04
 12.000 0.37037E-05
 12.000 0.23310E-04
 12.000 -0.16004E-04
 6.9380 -24.008
 -19.719 -2.7063
 0.82911 -0.11406
 1.0168 -0.33866E-02
 0.99960 -0.19991E-01
 0.73530 -0.44118
 0.27049E-01 -0.16216
 0.13236E-03 -0.11587E-01
 0.95742E-01 -0.19299E-01
 0.97862E-01 0.40151E-01
 0.9454E-01 0.47814E-02
 0.94242E-01 -0.15295E-01
 TR.FCN.,Z,Y,TCLZER ARE: 1 1 0.50000 1.5000 0.10000E-11
 NOM. CCT.ELEMENTS ARE:
 10.000 1.0000 1.0000 0.10000E 00
 0.10000E-01 0.30000 3.0000 100.00

Computer output for test circuit # 1

The following output was obtained at the scaled test frequencies: 0.00115, 0.0025, 0.009, and 0.127 radians/ second for the voltage transfer function A_v of test circuit # 1.

```

MAGNITUDE OF TR. FCN. IS
  C.27023E-01  0.79203E-01  0.21037  0.74800E-01
MAGNITUDE OF TR. FCN. IS
  C.76165E-01  0.19537  0.33761  0.76200E-01
MAGNITUDE OF TR. FCN. IS
  C.52629E-01  0.14499  0.29864  0.75920E-01
  REAL T1      IMAG T1      REAL T2      IMAG T2      REAL T3      IMAG T3      REAL T      IMAG T
-0.18049E-01  0.20174E-01  -0.38599E-01  0.65684E-01  -0.30932E-01  0.42578E-01  -0.30111E-01  0.33442E-01
-0.11045E-01  0.78426E-01  0.38263E-01  0.19159  0.65327E-02  0.14484  -0.10693E-01  0.13006
  0.17516  0.11652  0.33166  0.63111E-01  0.28288  0.95737E-01  0.26248  0.11358
  C.24909E-01  0.70566E-01  0.17818E-01  -0.76088E-01  0.19654E-01  -0.73332E-01  0.21759E-01  -0.70729E-01
PIXEL= 1 1 FOR ELEMENT 1
  0.2453994E-04  -0.11362956E-03
  0.22759576E-11  0.15461410E-10
-0.25690376E-03  -0.31281030E-04
  0.32133679E-04  0.56262026E-04
  CENTRE AT  0.83978E-01  0.93532E-01  RADIUS OF  0.12570  0.0
  TZERO=    0.11679E-06  -0.89255E-07  TINFIN=   0.14953  0.20079
  THE 1/(10*x) IN NEUS K AT W= 1 IS  0.63566  2.0373
  PARTIAL OF T W.R.T. X AT W 1 IS  -0.20782  0.46822  0.51219
PIXEL= 2 1 FOR ELEMENT 1
-0.18820152E-33  -0.17904514E-03
-0.29103430E-10  0.14551915E-10
-0.59590542E-03  0.96891820E-03
  0.39586924E-03  -0.19415686E-03
  CENTRE AT  0.17493  0.64680E-01  RADIUS OF  0.18650  0.0
  TZERO=    -0.42562E-07  3.4236  0.11781E-06  TINFIN=  0.32569  0.17447
  THE 1/(10*x) IN NEUS K AT W= 2 IS  2.0376  1.1530  1.2770
  PARTIAL OF T W.R.T. X AT W 2 IS  0.54889
PIXEL= 3 1 FOR ELEMENT 1
-0.93579409E-34  0.18701050E-03
  0.29103830E-10  -0.81229246E-10
  0.29027201E-02  0.59349431E-03
-0.12160440E-02  0.30575329E-05
  CENTRE AT  0.19006  0.40955E-06  -0.95807E-01  RADIUS OF  0.21285  0.0
  TZERO=    6.3754  3.7141  -0.49528E-07  TINFIN=  0.40246  -0.81954E-01
  THE 1/(10*x) IN NEUS K AT W= 3 IS  6.3754  -0.68942  1.5811
  PARTIAL OF T W.R.T. X AT W 3 IS  1.4228
PIXEL= 4 1 FOR ELEMENT 1
  0.95409273E-36  -0.12078336E-05
-0.45474735E-11  -0.36375780E-11
-0.15335315E-23  -0.93988850E-04
  0.97437205E-25  -0.10920605E-04
  CENTRE AT  0.41192E-02  -0.38194E-01  RADIUS OF  0.38419E-01  0.0
  TZERO=    10.030  0.78448  0.39161E-05  TINFIN=  0.14003E-01  -0.75320E-01
  THE 1/(10*x) IN NEUS K AT W= 4 IS  10.030  -0.55130E-01  0.60278E-01
  PARTIAL OF T W.R.T. X AT W 4 IS  -0.55130E-01  0.24374E-01
MAGNITUDE OF TR. FCN. IS
  C.30586E-01  0.19455  C.28036  0.75878E-01
MAGNITUDE OF TR. FCN. IS
  C.65184E-01  0.15999  0.30297  0.75930E-01
  REAL T1      IMAG T1      REAL T2      IMAG T2      REAL T3      IMAG T3      REAL T      IMAG T
-0.23905E-01  0.19080E-01  -0.27918E-01  0.60011E-01  -0.30932E-01  0.42578E-01  -0.30111E-01  0.33442E-01
-0.29372E-01  0.10062  C.32755E-01  0.15660  0.65327E-02  0.14484  -0.10693E-01  0.13006
  0.24574  0.13497  0.29253  0.78841E-01  0.28288  0.95737E-01  0.26248  0.11358
  0.23742E-01  -0.72989E-01  0.19290E-01  -0.73439E-01  0.19654E-01  -0.73332E-01  0.21759E-01  -0.70729E-01
PIXEL= 1 1 FOR ELEMENT 2
-0.40167783E-04  -0.72002818E-04
  0.63644629E-11  0.99949470E-11
-0.59201430E-03  0.30325470E-03
  0.40466155E-04  0.35924139E-04
  CENTRE AT  0.15216E-01  0.43578E-01  RADIUS OF  0.46158E-01  0.0
  TZERO=    4.5714  -0.13692E-07  TINFIN=  0.27386E-01  0.58103E-01
  THE 1/(10*x) IN NEUS K AT W= 1 IS  3.4118  0.42192  0.42202
  PARTIAL OF T W.R.T. X AT W 1 IS  -0.91440E-02

```

PIXEL# 2 1 FOR ELEMENT 2
 -0.1094099E-03 0.22350680E-04
 -0.29103839E-10 0.0
 -0.43498667E-03 0.16230715E-02
 0.19273537E-03 -0.23049086E-03

CENTRE AT 0.55825E-01 0.70051E-01 RADIUS OF 0.89575E-01 0.0
 TZERO= -0.25535E-06 -0.52166E-07 TINFIN= 0.10289 0.14627

THE 1/(Q*X) IN NEUS K AT W= 2 IS 6.8349
 PARTIAL OF T W.R.T. X AT W 2 IS 0.65239 0.42998 0.78133

PIXEL# 3 1 FOR ELEMENT 2
 0.20455234E-04 0.28645198E-04
 -0.14551915E-10 -0.23283064E-09
 0.13742819E-02 -0.11166951E-02
 -0.46522124E-03 0.28492743E-03

CENTRE AT 0.15396 0.10888E-01 RADIUS OF 0.15434 0.0
 TZERO= 0.56234E-05 0.35076E-05 TINFIN= 0.30537 0.40801E-01

THE 1/(Q*X) IN NEUS K AT W= 3 IS 9.5126
 PARTIAL OF T W.R.T. X AT W 3 IS 0.31635 -0.48065 0.57541

PIXEL# 4 1 FOR ELEMENT 2
 0.18580067E-07 -0.54388693E-07
 0.24556357E-10 0.81894523E-11
 -0.36121681E-04 -0.11828518E-04
 0.15413689E-05 -0.24406081E-05

CENTRE AT 0.88106E-02 -0.37165E-01 RADIUS OF 0.37757E-01 0.0
 TZERO= -0.31489E-05 -0.45053E-03 TINFIN= 0.18556E-01 -0.73643E-01

THE 1/(Q*X) IN NEUS K AT W= 4 IS 9.9958
 PARTIAL OF T W.R.T. X AT W 4 IS -0.10930E-01 -0.32772E-02 0.11411E-01

MAGNITUDE OF TR. FCN. IS 0.34137 0.14507

PIXEL# 1 1 FOR ELEMENT 3
 0.53354E-01 0.15081 0.34137 0.14507
 MAGNITUDE OF TR. FCN. IS 0.51791E-01 0.13860 0.25970 0.51114E-01
 REAL T1 IMAG T1 REAL T2 IMAG T2 REAL T3 IMAG T3 REAL T IMAG T
 -0.33526E-01 0.41504E-01 -0.28321E-01 0.43362E-01 -0.30932E-01 0.42578E-01 -0.30111E-01 0.33442E-01
 -0.67977E-02 0.15066 0.17681E-01 0.13747 0.65327E-02 0.14484 -0.10693E-01 0.13006
 0.29459 0.1548 0.25503 0.49023E-01 0.28288 0.95737E-01 0.26248 0.11358
 0.58934E-01 -0.13256 0.10502E-01 -0.50024E-01 0.19654E-01 -0.73332E-01 0.21759E-01 -0.70729E-01

PIXEL# 1 1 FOR ELEMENT 3
 -0.13358090E-04 -0.32553244E-05
 -0.61231475E-06 0.41873103E-06
 -0.82702953E-06 0.14470717E-06
 0.82764018E-10 0.17644197E-09

CENTRE AT -0.21752E-01 0.16731E-01 RADIUS OF 0.27429E-01 0.0
 TZERO= -0.36058E-01 0.40134E-01 TINFIN= -0.11675E-04 0.62940E-05

THE 1/(Q*X) IN NEUS K AT W= 1 IS 0.51687E-01 0.99985
 PARTIAL OF T W.R.T. X AT W 1 IS 0.51687E-01 0.18356E-01 0.54850E-01

PIXEL# 2 1 FOR ELEMENT 3
 -0.51293281E-04 0.41579566E-04
 0.52790047E-05 0.88224897E-05
 0.11018524E-03 0.78694429E-04
 -0.13387762E-08 0.43659746E-10

CENTRE AT -0.32293E-01 0.74021E-01 RADIUS OF 0.80767E-01 0.0
 TZERO= -0.22024E-01 0.15413 TINFIN= 0.78587E-05 -0.60899E-05

THE 1/(Q*X) IN NEUS K AT W= 2 IS 0.84164
 PARTIAL OF T W.R.T. X AT W 2 IS 0.24278 -0.13310 0.27687

PIXEL# 3 1 FOR ELEMENT 3
 0.1732886E-03 0.1795315E-03
 -0.29832518E-05 -0.94645889E-04
 0.6135203E-03 -0.11629947E-02
 0.13242243E-08 -0.30267984E-08

CENTRE AT 0.98813E-01 0.17381 RADIUS OF 0.19994 0.0
 TZERO= 0.28161 0.25479 TINFIN= -0.25059E-05 0.18333E-06

THE 1/(Q*X) IN NEUS K AT W= 3 IS 2.7577
 PARTIAL OF T W.R.T. X AT W 3 IS -0.48360 -1.1401 1.2384

PIXEL# 4 1 FOR ELEMENT 3
 -0.30147625E-04 -0.22728162E-04
 0.1300716E-04 0.13194496E-04

THE 1/(Q*X) IN NEUS K AT W= 4 IS 2.7577
 PARTIAL OF T W.R.T. X AT W 4 IS -0.48360 -1.1401 1.2384

PIXEL# 1 1 FOR ELEMENT 4
 -1340.9768 -429.18970
 -65.270462 37.715363
 -3228.312E-01 0.15302849
 0.47683716E-06 0.10728836E-05

CENTRE AT -0.20025E-01 0.17982E-01 RADIUS OF 0.26906E-01 0.0
 TZERO= -0.35986E-01 0.39643E-01 TINFIN= -0.60840E-05 0.43983E-05

THE 1/(Q*X) IN NEUS K AT W= 1 IS 0.22852E-04
 PARTIAL OF T W.R.T. X AT W 1 IS 0.52520E-05 0.23288E-05 0.57452E-05

PIXEL# 2 1 FOR ELEMENT 4
 -5758.3967 4361.3281
 516.96582 990.06250
 1.2237282 1.1070366
 -0.12397766E-04 0.28610229E-05

CENTRE AT -0.27290E-01 0.73796E-01 RADIUS OF 0.78688E-01 0.0
 TZERO= -0.25701E-01 0.15247 TINFIN= 0.44084E-05 -0.63260E-05

THE 1/(Q*X) IN NEUS K AT W= 2 IS 0.83275E-04
 PARTIAL OF T W.R.T. X AT W 2 IS 0.28045E-04 -0.19737E-03 0.31061E-04

PIXEL# 3 1 FOR ELEMENT 4
 19534.141 17665.766
 -734.13579 -10283.621
 6.1663361 -14.763718
 -0.15258789E-04 -0.45778367E-04

CENTRE AT 0.94316E-01 0.18710 RADIUS OF 0.20953 0.0
 TZERO= 0.28215 0.27994 TINFIN= -0.22725E-05 0.19827E-05

THE 1/(Q*X) IN NEUS K AT W= 3 IS 0.32513E-03
 PARTIAL OF T W.R.T. X AT W 3 IS -0.60352E-04 -0.12455E-03 0.13841E-03

PIXEL# 4 1 FOR ELEMENT 4
 -2806.3789 -2416.3047
 1307.3806 1274.7839
 -14.566968 18.564072
 0.66757202E-05 0.38146973E-05

CENTRE AT 0.24537 0.26465E-01 RADIUS OF 0.24680 0.0
 TZERO= 0.49213 0.30515E-01 TINFIN= 0.47463E-07 0.32236E-06

THE 1/(Q*X) IN NEUS K AT W= 4 IS 0.96942E-03
 PARTIAL OF T W.R.T. X AT W 4 IS -0.30119E-04 0.68123E-04 0.74485E-04

MAGNITUDE OF TR. FCN. IS 0.21678 0.74764E-01

PIXEL# 1 1 FOR ELEMENT 5
 0.27964E-01 0.86451E-01 0.21678 0.74764E-01
 MAGNITUDE OF TR. FCN. IS 0.73414E-01 0.18585 0.33501 0.76218E-01
 REAL T1 IMAG T1 REAL T2 IMAG T2 REAL T3 IMAG T3 REAL T IMAG T
 -0.19352E-01 0.29186E-01 -0.35796E-01 0.64096E-01 -0.30932E-01 0.42578E-01 -0.30111E-01 0.33442E-01
 -0.12764E-01 0.83481E-01 0.34916E-01 0.18254 0.65327E-02 0.14484 -0.10693E-01 0.13006
 0.16483 0.11332 0.32753 0.70424E-01 0.28288 0.95737E-01 0.26248 0.11358
 0.24643E-01 -0.70586E-01 0.17875E-01 -0.74092E-01 0.19654E-01 -0.73332E-01 0.21759E-01 -0.70729E-01

PIXEL# 1 1 FOR ELEMENT 5
 753.07031 -10540.387
 0.73242188E-03 0.2441403E-03
 -3.3580017 0.43765750
 0.34023911 0.51459378

CENTRE AT 0.56662E-01 0.73688E-01 RADIUS OF 0.92954E-01 0.0

THE 1/(Q+X) IN NEUS K AT W= 1 IS
PARTIAL OF T W.R.T. X AT W 1 IS
PIXIM= 2 1 FOR ELEMENT 5

-14663.605	-12931.305
-0.12451172E-01	0.14648438E-02
-4.5435181	11.833649
3.9091782	-1.8883371

CENTRE AT 0.15078 0.65769E-01 RADIUS OF 0.16450 0.0
TZERO= 0.13539E-03 0.25520E-03
TZERO= -0.15878E-04 0.44708E-04 0.47443E-04

THE 1/(Q+X) IN NEUS K AT W= 2 IS
PARTIAL OF T W.R.T. X AT W 2 IS
PIXIM= 3 1 FOR ELEMENT 5

-89.77975	14586.926
0.31250000E-01	-0.14892578E-01
26.710709	3.8626059
-11.119814	-0.36230795

CENTRE AT 0.19520 0.16367E-05 RADIUS OF 0.22453 0.0
TZERO= 0.31626E-03 0.42240E-06 TINFIN= 0.23830 0.20505
TZERO= 0.53090E-04 0.96842E-04 0.11044E-03

THE 1/(Q+X) IN NEUS K AT W= 3 IS
PARTIAL OF T W.R.T. X AT W 3 IS
PIXIM= 4 1 FOR ELEMENT 5

0.74298584	-115.97583
0.33569336E-03	0.18310547E-03
-1.6047840	-0.99262524
0.97543359E-01	-0.10685271

CENTRE AT 0.36377E-02 -0.38326E-01 RADIUS OF 0.38496E-01 0.0
TZERO= 0.98732E-03 0.75109E-04
TZERO= 0.65674E-03 0.30565E-03 0.13726E-03

THE 1/(Q+X) IN NEUS K AT W= 4 IS
PARTIAL OF T W.R.T. X AT W 4 IS
MAGNITUDE OF TR. FCN. IS
MAGNITUDE OF TR. FCN. IS

0.49357E-01	0.16712	0.31050	0.75994E-01				
REAL T1	IMAG T1	REAL T2	IMAG T2	REAL T3	IMAG T3	REAL T	IMAG T
-0.22428E-01	0.19527E-01	-0.30077E-01	0.61384E-01	-0.30932E-01	0.42578E-01	-0.30111E-01	0.33442E-01
-0.22797E-01	0.94676E-01	0.33953E-01	0.16364	0.65327E-02	0.14484	-0.10693E-01	0.13006
0.22591	0.13108	0.30109	0.75870E-01	0.28288	0.95737E-01	0.26248	0.11358
0.21719E-01	-0.72469E-01	0.18953E-01	-0.73593E-01	0.19654E-01	-0.73332E-01	0.21759E-01	-0.70729E-01

PIXIM= 1 1 FOR ELEMENT 6

-75102.063	-224428.50
0.78125000E-02	0.23437500E-01
-24.377823	11.058014
2.0131350	2.1105528

CENTRE AT 0.23410E-01 0.49531E-01 RADIUS OF 0.54785E-01 0.0
TZERO= 0.10356E-06 -0.15407E-09 TINFIN= 0.35918E-01 0.10287
TZERO= 0.52850E-04 0.76167E-04

THE 1/(Q+X) IN NEUS K AT W= 1 IS
PARTIAL OF T W.R.T. X AT W 1 IS
PIXIM= 2 1 FOR ELEMENT 6

-359201.06	-42193.875
-0.27734375	-0.78125000E-02
4.9723816	81.726257
12.527688	-11.293242

CENTRE AT 0.78657E-01 0.69022E-01 RADIUS OF 0.10465 0.0
TZERO= 0.10934E-03 0.79349E-04
TZERO= 0.12033E-04 0.11446E-04 0.16607E-04

THE 1/(Q+X) IN NEUS K AT W= 2 IS
PARTIAL OF T W.R.T. X AT W 2 IS
PIXIM= 3 1 FOR ELEMENT 6

2196.063	164645.75
0.48700000	-0.36332125
103.31097	-46.304855
-34.915527	10.853562

CENTRE AT 0.16728 -0.28498E-01 RADIUS OF 0.16969 0.0
TZERO= 0.16818E-03 0.43918E-05 TINFIN= 0.32889 0.23254E-01
TZERO= 0.10927E-04 -0.10167E-04 0.14926E-04

PIXIM= 4 1 FOR ELEMENT 6

292.30078	-528.65625
0.46142578E-01	0.78125000E-02
-3.5472908	-1.5658989
0.17818272	-0.23531759

CENTRE AT 0.59815E-02 -0.37733E-01 RADIUS OF 0.38134E-01 0.0
TZERO= -0.24768E-04 -0.74057E-04 TINFIN= 0.17531E-01 -0.74076E-01
TZERO= 0.19135E-03 0.56481E-05

THE 1/(Q+X) IN NEUS K AT W= 4 IS
PARTIAL OF T W.R.T. X AT W 4 IS
THE COMPLEX SOLNS FOR (W-ELEMENT) ARE:

0.82102E-01	0.61341E-02
0.93423E-01	0.73939E-02
0.33999E-01	0.44614E-02
0.53208E-01	-0.10144E-01
0.79737E-01	0.59332E-03
0.75598E-01	0.10569E-04
0.57165E-01	-0.41592E-02
0.23404E-01	-0.10599E-01
0.32747E-01	-0.19331
0.59357E-01	-0.94918E-01
0.92107E-01	-0.21051E-01
0.10292	-0.42476E-02
217.21	-1695.5
579.52	-694.60
929.95	-192.11
1019.6	-41.752
821.65	53.495
825.56	73.438
836.58	56.411
632.94	-100.62
418.0	117.77
4042.1	162.35
3820.5	52.483
2027.0	-617.78

TR. FCN. L.V. TOLZER ARE: 1 2 0.50000 1.5000 0.10000E-08
NOM. CCT. ELEMENTS ARE:

0.98500E-01	0.10000E 00	0.10100	1000.0	1000.0	5210.0
0.11561E-02	0.25070E-02	0.90226E-02	0.12736		

The following output was obtained at the scaled test frequencies: 0.00015, 0.0021, 0.0037, 0.009, 0.022, and 0.28 radians/sec-
ond for the driving point impedance, Z_{11} , of test circuit # 1.

```

MAGNITUDE OF TR. FCN. IS
3899.0
2894.3
2246.6
1301.3
691.75
70.841
MAGNITUDE OF TR. FCN. IS
5188.1 3398.2 2475.7 1424.0 720.98 70.814
MAGNITUDE OF TR. FCN. IS
5188.2 3424.3 2486.9 1321.3 700.41 70.872
MAGNITUDE OF TR. FCN. IS
5188.1 3401.3 2492.6 1359.2 703.99 70.858
REAL T1 IMAG T1 REAL T2 IMAG T2 REAL T3 IMAG T3 REAL T IMAG T
5172.4 -403.53 5172.4 -403.44 5172.4 -403.48 3883.3 -226.82
2567.6 -2190.0 2585.3 -2245.4 2582.1 -2213.9 2409.8 -1603.1
1529.3 -1863.9 1550.1 -1944.8 1591.2 -1918.6 1618.0 -1558.6
722.44 -1238.7 627.44 -1162.8 646.22 -1195.7 701.48 -1096.0
245.53 -677.88 270.40 -646.11 260.94 -653.84 282.80 -631.30
3.4290 -70.731 3.4466 -70.789 3.4412 -70.774 3.7632 -70.741
PIXI# 1 1 FOR ELEMENT 1
-0.56849907E-04 -0.29015569E-03
0.37482351 1.0123472
0.0 0.72143972E-04
-0.28943062E-01 -0.37324524
CENTRE AT 5177.2 -404.48 RADIUS OF 4.8796 0.0
TZERO= 5172.4 -403.57 TINFIN= 5173.6 -401.18
THE 1/(10*x) IN NEUS K AT W= 1 IS
PARTIAL OF T W.R.T. X AT W 1 IS 0.32373 0.88794E-01
PIXI# 2 1 FOR ELEMENT 1
0.1226402E-01 0.14674503
-366.64961 -346.27637
0.37698383 -0.11968613
-1082.9922 1606.6719
CENTRE AT 2472.7 -2240.8 RADIUS OF 112.64 0.0
TZERO= 2539.4 -2150.0 TINFIN= 2431.0 -2345.5
THE 1/(10*x) IN NEUS K AT W= 2 IS
PARTIAL OF T W.R.T. X AT W 2 IS 1.5971 3.1054
PIXI# 3 1 FOR ELEMENT 1 167.11 -679.31 699.56
0.20484034 0.57782326E-01
-441.33130 273.38428
0.14839935 -1.4043207
2444.7031 2199.5081
CENTRE AT 1492.9 -1809.4 RADIUS OF 146.97 0.0
TZERO= 1636.6 -1779.0 TINFIN= 1367.0 -1865.3
THE 1/(10*x) IN NEUS K AT W= 3 IS
PARTIAL OF T W.R.T. X AT W 3 IS -866.03 -780.16 1165.6
PIXI# 4 1 FOR ELEMENT 1
0.31262935E-03 -0.13516208
164.92269 113.50562
-1.8436508 0.49728489
632.20947 -2264.0430
CENTRE AT 754.93 -1111.9 RADIUS OF 137.30 0.0
TZERO= 836.95 -1222.0 TINFIN= 628.42 -1056.5
THE 1/(10*x) IN NEUS K AT W= 4 IS
PARTIAL OF T W.R.T. X AT W 4 IS -623.36 808.15 1020.6
PIXI# 5 1 FOR ELEMENT 1
-0.31397905E-01 0.20282269E-02
7.2564240 -24.420380
0.29370469 0.80296844
-597.70361 -51.622070
CENTRE AT 306.74 -700.18 RADIUS OF 65.148 0.0
TZERO= 240.18 -759.67 TINFIN= 296.84 -635.79
THE 1/(10*x) IN NEUS K AT W= 5 IS
PARTIAL OF T W.R.T. X AT W 5 IS 8.3103 2.6943 351.06
249.69 246.77

```

```

PIXI# 6 1 FOR ELEMENT 1
0.49548659E-05 0.17764978E-05
-0.13709049E-03 0.34770789E-03
0.43473952E-03 -0.14007858E-02
0.97701192E-01 0.35620645E-01
CENTRE AT 2.8395 -70.922 RADIUS OF 0.61951 0.0
TZERO= 2.2220 -70.972 TINFIN= 3.4503 -70.818
10.123 0.36790
0.10846 -0.44274 0.45583
THE 1/(Q*X) IN NEUS K AT W= 6 IS
PARTIAL OF T W.R.T. X AT W 6 IS
MAGNITUDE OF TR. FCN. IS
5204.5 4457.2 3691.3 2204.5 1115.2 106.52
MAGNITUDE OF TR. FCN. IS
5161.3 2685.7 1912.0 1051.5 566.25 58.970
REAL T1 IMAG T1 REAL T2 IMAG T2 REAL T3 IMAG T3 REAL T3 IMAG T3
5209.5 -203.10 5126.4 -598.66 5172.4 -603.88 3883.3 3883.3
3992.1 -202.3 1847.2 -1945.6 2582.1 -2213.9 2409.8 -1603.1
2872.9 -2317.9 1149.1 -1528.2 1591.2 -1918.6 1618.0 -1558.6
1189.7 -1855.9 512.40 -918.18 646.22 -1195.7 701.48 -1096.0
399.89 -1041.1 228.45 -518.12 260.94 -653.84 282.80 -631.30
4.6550 -106.42 3.1452 -58.888 3.4412 -70.774 3.7632 -70.741
PIXI# 2 1 FOR ELEMENT 2
0.27482384 0.96289486
-1431.8333 -5616.6875
0.89531136 -0.26025391
-744.06641 236.81250
CENTRE AT 3023.6 0.73604E-01 RADIUS OF 2186.4 0.0
TZERO= 5210.0 0.0 TINFIN= 837.21 -21.137
0.90365E-01 0.92227
-744.38 -3963.7 4033.0
THE 1/(Q*X) IN NEUS K AT W= 1 IS
PARTIAL OF T W.R.T. X AT W 1 IS
PIXI# 2 1 FOR ELEMENT 2
2.0121536 -2.5118055
-10453.301 13086.465
-33.251831 -23.799088
30563.438 5294.2500
CENTRE AT 2963.5 -0.14625E-01 RADIUS OF 2246.5 0.0
TZERO= 5210.0 0.47587E-02 TINFIN= 730.14 -243.07
6.1161 4.6101 20713.
-20413. 3516.1
THE 1/(Q*X) IN NEUS K AT W= 2 IS
PARTIAL OF T W.R.T. X AT W 2 IS
PIXI# 3 1 FOR ELEMENT 2
0.11184788 -1.9299231
-82.60312 1054.887
-41.975708 0.44425944
24866.188 -13547.563
CENTRE AT 2892.0 -0.64654E-02 RADIUS OF 2318.0 0.0
TZERO= 5210.0 -0.17276E-01 TINFIN= 595.74 -316.44
8.0897 3.6032 16704.
-13826. 9373.9
THE 1/(Q*X) IN NEUS K AT W= 3 IS
PARTIAL OF T W.R.T. X AT W 3 IS
PIXI# 4 1 FOR ELEMENT 2
-0.35508060 -0.43106937
1849.9756 2245.8647
-20.483337 15.132980
1409.8438 -12937.656
CENTRE AT 2771.5 -0.12501E-03 RADIUS OF 2438.5 0.0
TZERO= 5210.0 -0.16290E-01 TINFIN= 351.83 -302.98
9.5106 1.8681 9111.0
-4467.5 7940.5
THE 1/(Q*X) IN NEUS K AT W= 4 IS
PARTIAL OF T W.R.T. X AT W 4 IS
PIXI# 5 1 FOR ELEMENT 2
-0.10366040 -0.49839973E-01
540.06982 259.64307
-5.3226156 12.575718
-2029.3320 -3617.5664
CENTRE AT 2692.2 -0.14939E-01 RADIUS OF 2517.7 0.0
TZERO= 5209.9 -0.17708 TINFIN= 186.04 -240.11
9.8905 0.82877 4173.1
-1083.7 4030.0
THE 1/(Q*X) IN NEUS K AT W= 5 IS
PARTIAL OF T W.R.T. X AT W 5 IS
PIXI# 6 1 FOR ELEMENT 2
-0.91378927E-03 -0.36716461E-04
4.2397003 0.19237202
-0.45883933E-01 1.180522
-61.582504 -4.8373566
CENTRE AT 2606.2 -0.16886E-02 RADIUS OF 2603.7 0.0
TZERO= 5209.9 1.3311 TINFIN= 2.7159 -35.105
9.9991 0.68506E-01 356.74
-9.6967 356.61
THE 1/(Q*X) IN NEUS K AT W= 6 IS
PARTIAL OF T W.R.T. X AT W 6 IS
MAGNITUDE OF TR. FCN. IS
5188.1 3363.6 2439.6 1340.1 740.86 105.11
MAGNITUDE OF TR. FCN. IS
5188.2 3435.4 2530.2 1353.9 661.00 59.210
REAL T1 IMAG T1 REAL T2 IMAG T2 REAL T3 IMAG T3 REAL T3 IMAG T3
5172.4 -403.53 5172.4 -403.44 5172.4 -403.48 3883.3 3883.3
2556.8 -2195.6 2601.4 -2243.7 2582.1 -2213.9 2409.8 -1603.1
1592.9 -1947.7 1576.5 -1979.1 1591.2 -1918.6 1618.0 -1558.6
725.55 -1126.6 572.49 -1226.9 646.22 -1195.7 701.48 -1096.0
391.21 -629.16 184.60 -634.70 260.94 -653.84 282.80 -631.30
11.832 -104.45 1.7787 -59.183 3.4412 -70.774 3.7632 -70.741
PIXI# 1 1 FOR ELEMENT 3
-0.59771424E-04 -0.22102956E-03
0.39836383 1.1191359
0.0 0.36988407E-04
-0.14741898E-01 -0.19139099
CENTRE AT 5182.7 -404.63 RADIUS OF 10.292 0.0
TZERO= 5172.4 -403.57 TINFIN= 5174.3 -398.55
0.15370 0.440872E-01 0.84134
0.93663E-01 0.83611
THE 1/(Q*X) IN NEUS K AT W= 1 IS
PARTIAL OF T W.R.T. X AT W 1 IS
PIXI# 2 1 FOR ELEMENT 3
-0.83069205E-01 0.15584338
-126.99156 -573.02710
0.37444241 0.74010849E-01
-913.93311 614.47656
CENTRE AT 2392.5 -2357.8 RADIUS OF 237.98 0.0
TZERO= 2525.4 -2160.3 TINFIN= 2371.2 -2594.8
0.67691 1.9327 729.50
440.98 -561.12
THE 1/(Q*X) IN NEUS K AT W= 2 IS
PARTIAL OF T W.R.T. X AT W 2 IS
PIXI# 3 1 FOR ELEMENT 3
0.19838479 0.78213477
-670.28906 -252.70654
0.65771979 -0.52351761
398.29688 1978.9766
CENTRE AT 1283.6 -1875.7 RADIUS OF 310.59 0.0
TZERO= 1575.8 -1770.4 TINFIN= 1104.7 -2129.6
1.2965 2.1257 1320.4
-182.34 -1307.8
THE 1/(Q*X) IN NEUS K AT W= 3 IS
PARTIAL OF T W.R.T. X AT W 3 IS
PIXI# 4 1 FOR ELEMENT 3
0.36173970 0.62675238E-01
-346.37598 314.82666
-0.29318691 -1.9117250
2095.9141 132.32031
CENTRE AT 495.57 -942.60 RADIUS OF 294.56 0.0
TZERO= 783.23 -1006.0 TINFIN= 226.65 -1062.8
2.7527 3.0939 1822.7
-1566.3 -932.18
THE 1/(Q*X) IN NEUS K AT W= 4 IS
PARTIAL OF T W.R.T. X AT W 4 IS
PIXI# 5 1 FOR ELEMENT 3
0.25187236 -0.20944273
-35.045364 225.55649
-2.7229261 -2.2135887
1105.7595 -1141.1953
CENTRE AT 261.91 -408.47 RADIUS OF 246.26 0.0
TZERO= 522.50 -461.03 TINFIN= 39.366 -451.11
5.2768 4.0597 1999.5
-1992.3 170.24
THE 1/(Q*X) IN NEUS K AT W= 5 IS
PARTIAL OF T W.R.T. X AT W 5 IS
PIXI# 6 1 FOR ELEMENT 3
-0.86786076E-02 -0.28074384E-02

```

4.0676899 0.95863230
-0.33977419 1.1151047
-39.740189 -12.407211

CENTRE AT 228.46 -32.583 RADIUS OF 228.24 0.0
TZERO= 456.65 -37.260 TINFIN= 0.24479 -35.713

THE 1/(Q*X) IN NEUS K AT W= 6 IS
PARTIAL OF T W.R.T. X AT W 6 IS
MAGNITUDE OF TR. FCN. IS
5191.1 3401.0
MAGNITUDE OF TR. FCN. IS
5180.1 3396.8 2473.2 1358.9 731.91 70.928
REAL T1 IMAG T1 REAL T2 IMAG T2 REAL T3 IMAG T3 REAL T IMAG T
9172.4 -403.48 5172.4 -403.48 5172.4 -403.48 3883.3 -226.82
2291.1 -2213.9 2575.3 -2213.9 2582.1 -2213.9 2409.8 -1603.1
1608.2 -1933.1 1580.0 -1902.8 1591.2 -1918.6 1618.0 -1558.6
611.84 -1235.0 679.24 -1177.0 646.22 -1195.7 701.48 -1096.0
217.00 -628.56 277.84 -677.12 260.94 -653.84 282.80 -631.30
4.6092 -70.399 3.0375 -70.863 3.4412 -70.774 3.7632 -70.741

PIKIN= 2 I FOR ELEMENT 4
3364257.0 209499.19
-0.91961958E 10 0.68825825E 10
-68.117188 -654.41895
1589160.0 1515342.0

CENTRE AT 2572.4 -2174.3 RADIUS OF 40.815 0.0
TZERO= 2595.8 -2207.7 TINFIN= 2539.4 -2150.3

THE 1/(Q*X) IN NEUS K AT W= 2 IS
PARTIAL OF T W.R.T. X AT W 2 IS
MAGNITUDE OF TR. FCN. IS
4187317.0 -8237549.0
PIKIN= 3 I FOR ELEMENT 4
0.91790664E 10 0.21573247E 11
-2879.8516 -666.01563
5891543.0 -4026112.0

CENTRE AT 1654.2 -1861.9 RADIUS OF 84.723 0.0
TZERO= 1631.0 -1943.4 TINFIN= 1636.6 -1779.0

THE 1/(Q*X) IN NEUS K AT W= 3 IS
PARTIAL OF T W.R.T. X AT W 3 IS
MAGNITUDE OF TR. FCN. IS
-16166192.0 -4230271.0
0.15105348E 11 -0.18536825E 11
683.47266 10267.699
-13118752.0 -7758208.0

CENTRE AT 728.68 -1302.6 RADIUS OF 135.00 0.0
TZERO= 593.68 -1302.0 TINFIN= 836.93 -1222.0

THE 1/(Q*X) IN NEUS K AT W= 4 IS
PARTIAL OF T W.R.T. X AT W 4 IS
MAGNITUDE OF TR. FCN. IS
-1689252.0 11133361.
-0.69927690E 10 -0.25596355E 10
13521.367 -1006.9570
-3024018.0 10553696.0

CENTRE AT 193.13 -720.86 RADIUS OF 95.337 0.0
TZERO= 131.58 -648.06 TINFIN= 280.22 -759.65

THE 1/(Q*X) IN NEUS K AT W= 5 IS
PARTIAL OF T W.R.T. X AT W 5 IS
MAGNITUDE OF TR. FCN. IS
10816.500 -27126.313
1444436.0 663488.00
-392.11548 -143.22662
11013.526 -26806.543

CENTRE AT 1.3626 -62.304 RADIUS OF 8.7215 0.0
TZERO= 0.87206 -53.596 TINFIN= 2.2160 -70.984

THE 1/(Q*X) IN NEUS K AT W= 6 IS
PARTIAL OF T W.R.T. X AT W 6 IS
MAGNITUDE OF TR. FCN. IS
5191.1 3401.4
2372.4 1218.0 631.72 70.678

5195.2 3450.8 2614.4 1434.7 731.61 70.903
REAL T1 IMAG T1 REAL T2 IMAG T2 REAL T3 IMAG T3 REAL T IMAG T
5175.4 -404.15 5169.5 -402.69 5172.4 -403.48 3883.3 -226.82
2449.4 -2360.0 2714.5 -2140.2 2582.1 -2213.9 2409.8 -1603.1
1370.7 -1936.4 1731.1 -1959.1 1591.2 -1918.6 1618.0 -1558.6
344.91 -1099.3 677.26 -1264.8 646.22 -1195.7 701.48 -1096.0
252.35 -579.13 255.50 -685.54 260.94 -653.84 282.80 -631.30
4.6513 -70.525 3.0327 -70.839 3.4412 -70.774 3.7632 -70.741

PIKIN= 1 I FOR ELEMENT 5
1461607.0 -430907.89
-0.72900118E 10 0.28115615E 10
-23.437500 -63.720703
138891.00 324430.00

CENTRE AT 5188.8 -337.93 RADIUS OF 67.570 0.0
TZERO= 5178.4 -404.69 TINFIN= 5190.9 -270.39

THE 1/(Q*X) IN NEUS K AT W= 1 IS
PARTIAL OF T W.R.T. X AT W 1 IS
MAGNITUDE OF TR. FCN. IS
-6132080.0 -18748464.0
PIKIN= 2 I FOR ELEMENT 5
0.20546611E 12 -0.12711979E 12
139.68750 36194.438
-87295232.0 -0.12226861E 09

CENTRE AT 2907.5 -2642.8 RADIUS OF 536.32 0.0
TZERO= 2371.4 -2594.5 TINFIN= 3387.4 -2398.8

THE 1/(Q*X) IN NEUS K AT W= 2 IS
PARTIAL OF T W.R.T. X AT W 2 IS
MAGNITUDE OF TR. FCN. IS
-49770928.0 34844832.
-0.19221250E 11 -0.14448873E 12
40326.563 29163.086
-0.15166610E 09 37412352.0

CENTRE AT 1520.9 -2422.8 RADIUS OF 509.06 0.0
TZERO= 1104.8 -2129.6 TINFIN= 2029.3 -2395.2

THE 1/(Q*X) IN NEUS K AT W= 3 IS
PARTIAL OF T W.R.T. X AT W 3 IS
MAGNITUDE OF TR. FCN. IS
2049184.0 25206800.
-0.27253471E 11 -0.35553027E 10
35135.453 -18678.938
3840208.0 64386496.0

CENTRE AT 361.73 -1365.0 RADIUS OF 331.06 0.0
TZERO= 226.65 -1062.8 TINFIN= 674.33 -1474.0

THE 1/(Q*X) IN NEUS K AT W= 4 IS
PARTIAL OF T W.R.T. X AT W 4 IS
MAGNITUDE OF TR. FCN. IS
6235484.0 5096544.0
-0.25443901E 10 0.26125394E 10
7022.3438 -21505.859
14644128.0 10688773.0

CENTRE AT 72.172 -637.71 RADIUS OF 189.46 0.0
TZERO= 39.327 -451.12 TINFIN= 222.15 -753.48

THE 1/(Q*X) IN NEUS K AT W= 5 IS
PARTIAL OF T W.R.T. X AT W 5 IS
MAGNITUDE OF TR. FCN. IS
3852.8125 -13996.090
499047.00 141104.00
-430.78833 -92.399597
7440.4531 -28227.230

CENTRE AT 0.81551E-03 0.23985E-03 RADIUS OF 0.90885E-01 0.0
TZERO= 39.327 -451.12 TINFIN= 222.15 -753.48

THE 1/(Q*X) IN NEUS K AT W= 6 IS
PARTIAL OF T W.R.T. X AT W 6 IS
MAGNITUDE OF TR. FCN. IS
2601.5 2187.6
MAGNITUDE OF TR. FCN. IS
7748.5 4017.0 2749.6 1413.3 715.30 70.873

CENTRE AT 0.48815 -53.373 RADIUS OF 17.650 0.0
TZERO= 0.24757 -35.724 TINFIN= 2.2100 -70.939

REAL T1	• IMAG T1	REAL T2	IMAG T2	REAL T3	IMAG T3	REAL T	IMAG T
2599.5	-101.45	7696.1	-899.99	5172.4	-403.48	3883.3	-226.82
1986.7	-915.82	2569.2	-3088.0	2582.1	-2213.9	2409.8	-1603.1
1513.1	-1042.9	1452.5	-2334.6	1591.2	-1918.6	1618.0	-1558.6
760.41	-908.52	570.92	-1292.8	646.22	-1195.7	701.48	-1096.0
316.37	-56.61	236.66	-675.01	260.94	-653.84	282.60	-631.30
4.3983	-79.668	3.1213	-70.804	3.4412	-70.774	3.7632	-70.741

PIXI(W= 1) FOR ELEMENT 6
 -0.33916330E 11 0.80582369E 10
 0.23488102E 09 0.0
 12398.00 56694.00
 -0.33916211E 11 0.80582328E 10

CENTRE AT -0.19429E-01 -33356. RADIUS OF 33356.0
 TZERO= 0.65533E-02 0.15575E-02 TINFIN= 997.78 -66697.0

THE 1/(Q*X) IN NEUS K AT W= 1 IS
 PARTIAL OF T W.R.T. X AT W 1 IS
 0.97964 -0.15377 0.99163

PIXI(W= 2) FOR ELEMENT 6
 0.43046625E 10 0.89850225E 10
 0.15099494E 09 0.13421773E 09
 1584914.0 -1104660.0
 0.43047281E 10 0.89851208E 10

CENTRE AT -0.14620E-01 -2612.7 RADIUS OF 2612.8
 TZERO= -0.18698E-01 0.78473E-02 TINFIN= 831.37 -5089.7

THE 1/(Q*X) IN NEUS K AT W= 2 IS
 PARTIAL OF T W.R.T. X AT W 2 IS
 0.65057E-01 -0.42121 0.42620

PIXI(W= 3) FOR ELEMENT 6
 0.31534723E 10 0.25257206E 10
 -2621400.0 -19922944.0
 564740.63 -1197647.0
 0.33534653E 10 0.25257108E 10

CENTRE AT 0.25037E-02 -1619.2 RADIUS OF 1619.2
 TZERO= 0.76428E-02 0.34088E-04 TINFIN= 645.11 -3104.2

THE 1/(Q*X) IN NEUS K AT W= 3 IS
 PARTIAL OF T W.R.T. X AT W 3 IS
 0.7580614E 09 28379648.0
 -19922944.0 14811136.0
 -101307.56 -495147.19
 0.75806310E 09 28376768.0

CENTRE AT 0.13203E-01 -772.49 RADIUS OF 772.47
 TZERO= 0.25513E-01 -0.20493E-01 TINFIN= 355.66 -1458.2

THE 1/(Q*X) IN NEUS K AT W= 4 IS
 PARTIAL OF T W.R.T. X AT W 4 IS
 0.37288E-01 -0.56933E-01 0.68057E-01

PIXI(W= 5) FOR ELEMENT 6
 0.10475955E 09 -38875648.0
 1081344.0 -4194304.0
 -86317.313 -125212.38
 0.10476360E 09 -38858048.0

CENTRE AT 0.30634E-01 -379.02 RADIUS OF 378.95
 TZERO= -0.77688E-01 -0.68860E-01 TINFIN= 180.61 -712.18

THE 1/(Q*X) IN NEUS K AT W= 5 IS
 PARTIAL OF T W.R.T. X AT W 5 IS
 -0.13241E-01 -0.12571E-01 0.18258E-01

PIXI(W= 6) FOR ELEMENT 6
 19346.000 -116904.13
 -14528.000 3328.0000
 -1659.7529 -199.81882
 19274.891 -117105.01

CENTRE AT -0.90711E-02 -35.413 RADIUS OF 35.530
 TZERO= 0.46817E-01 0.11693 TINFIN= 2.4804 -70.855

THE 1/(Q*X) IN NEUS K AT W= 6 IS
 PARTIAL OF T W.R.T. X AT W 6 IS
 -0.18410E-03 -0.17963E-04 0.18497E-03

THE COMPLEX SOLNS FOR K(W.ELEMENT) ARE:
 -2.7710 0.79284
 -0.63135E-01 0.18376
 -0.64289E-01 0.50337E-01
 -0.15262E-02 -0.15948

0.26800	0.17428
0.85970E-03	0.17336E-01
0.11329	-0.45970
0.11167	-0.36519E-01
0.10961	-0.23450E-01
0.10597	-0.12190E-01
0.10359	-0.69815E-02
0.10004	-0.70587E-03
-5.9634	1.6384
-0.15347	0.28447
-0.15395E-01	0.67429E-01
0.45586E-01	-0.16594E-01
0.99956E-01	-0.10976E-01
0.10093	-0.92977E-03
-1.9009	0.0
-1324.4	5609.2
-1041.2	5348.0
1696.7	1134.7
922.80	342.45
794.14	25.874
903.55	22119.
900.18	1193.4
759.73	659.73
732.20	317.71
775.77	151.82
793.24	12.399
3900.0	0.89585E-03
3900.0	0.72100E-03
3900.0	0.16840E-02
3900.0	-0.84028E-02
3900.0	-0.18717E-01
3900.0	-0.52120E-01

TR.FCN.,Z,V,TOLZER ARE: 1 1 0.50000 1.5000 0.10000E-11
 NOM. CCY.ELEMENTS ARE:
 0.98500E-01 0.10000E 00 0.10100 1000.0 1000.0 5210.0
 0.15000E-03 0.21000E-02 0.37000E-02 0.90000E-02 0.22000E-01 0.28000

Computer output for test circuit # 2

The following output was obtained at the scaled test frequencies:
 0.0002, 0.00242, 0.0062, 0.080, 36.4, 1600, 0.00502 and 0.0628 radians/-
 second for the voltage transfer function A_v of test circuit # 2.

```

    . . . . . 01 43 = 0.389300-C3
    MAGNITUDE OF TR. FCN. IS
    0.16540E-01
    1.2190
    2.2850
    13.239
    69.096
    6.9019
    MAGNITUDE OF TR. FCN. IS
    0.16333E-01 1.2189 2.2850 13.238 70.379 13.611
    MAGNITUDE OF TR. FCN. IS
    0.14544E-01 1.2190 2.2850 13.239 67.054 4.6134
    MAGNITUDE OF TR. FCN. IS
    0.16540E-01 1.2190 2.2850 13.239 69.096 6.9019
    REAL T1 IMAG T1 REAL T2 IMAG T2 REAL T3 IMAG T3 REAL T4 IMAG T4
    0.14544E-01 -0.24908E-02 0.16333E-01 -0.25157E-02 0.16347E-01 -0.25150E-02 0.16347E-01 -0.25150E-02
    0.19702 -1.2029 0.19701 -1.2030 0.19702 -1.2030 0.19702 -1.2030
    -0.97503 -2.0665 -0.97506 -2.0665 -0.97506 -2.0665 -0.97506 -2.0665
    -3.9847 -12.624 -3.9857 -12.625 -3.9852 -12.625 -3.9852 -12.625
    -6.997 7.3225 -6.548 21.397 -67.473 14.889 -67.473 14.889
    -2.6181 13.357 -0.30082 4.6036 -0.67323 6.8690 -0.67323 6.8690
    PIXEL= 1 I FOR ELEMENT 1
    0.32190725E-15 -0.54024913E-16
    -0.51322769E-17 0.16967781E-17
    0.25702103E-09 -0.43681455E-10
    -0.41271717E-11 0.13630139E-11
    . . . . .
    CENTRE AT -0.44118E-02 -0.12568 RADIUS OF 0.12491 0.0
    TZERO= 0.16366E-01 -0.25181E-02 TINFIN= 0.16356E-01 -0.25165E-02
    THE 1/(10*x) IN NEUS K AT W= 1 IS 0.10000E 21 0.10000E 21 0.14142E 21
    PARTIAL OF T W.R.T. X AT W 1 IS 0.10000E 21 0.10000E 21 0.14142E 21
    PIXEL= 2 I FOR ELEMENT 1
    0.43314684E-17 -0.16660606E-15
    0.1988593E-15 0.37915603E-16
    -0.23245815E-12 -0.13265607E-09
    0.15963371E-09 0.2585276E-10
    CENTRE AT 0.19694 -1.2030 RADIUS OF 0.94985E-04 0.0
    TZERO= 0.19701 -1.2030 TINFIN= 0.19701 -1.2030
    THE 1/(10*x) IN NEUS K AT W= 2 IS 0.10000E 21 0.10000E 21 0.14142E 21
    PARTIAL OF T W.R.T. X AT W 2 IS 0.10000E 21 0.10000E 21 0.14142E 21
    PIXEL= 3 I FOR ELEMENT 1
    -0.19932258E-16 -0.29010759E-16
    0.42466931E-16 -0.65339883E-16
    -0.23665687E-10 -0.17356866E-10
    0.12597197E-10 -0.6626220E-10
    CENTRE AT -0.97505 -2.0665 RADIUS OF 0.17337E-04 0.0
    TZERO= -0.97507 -2.0665 TINFIN= -0.97506 -2.0665
    THE 1/(10*x) IN NEUS K AT W= 3 IS 0.10000E 21 0.10000E 21 0.14142E 21
    PARTIAL OF T W.R.T. X AT W 3 IS 0.10000E 21 0.10000E 21 0.14142E 21
    PIXEL= 4 I FOR ELEMENT 1
    0.17196939E-14 0.13522241E-14
    -0.10218910E-13 0.27097021E-13
    -0.12396750E-11 -0.11157963E-10
    0.13568879E-09 -0.61209704E-10
    CENTRE AT -4.0295 -12.570 RADIUS OF 0.70467E-01 0.0
    TZERO= -3.9842 -12.624 TINFIN= -4.0842 -12.614
    THE 1/(10*x) IN NEUS K AT W= 4 IS 0.10000E 21 0.10000E 21 0.14142E 21
    PARTIAL OF T W.R.T. X AT W 4 IS 0.10000E 21 0.10000E 21 0.14142E 21
    PIXEL= 5 I FOR ELEMENT 1
    -0.15628693E-10 -0.20209084E-10
    -0.10974845E-09 -0.14426478E-08
    -0.18193768E-05 0.13757672E-05
    0.13969839E-08 -0.23283064E-08
    CENTRE AT -35.383 -0.22223E-01 RADIUS OF 35.384 0.0
    TZERO= -70.759 -0.81085 TINFIN= 0.11042E-02 -0.44478E-03
    THE 1/(10*x) IN NEUS K AT W= 5 IS 0.25385E 07 0.54629E 07 0.60239E 07
    PARTIAL OF T W.R.T. X AT W 5 IS 0.25385E 07 0.54629E 07 0.60239E 07
    PIXEL= 6 I FOR ELEMENT 1
    0.13987743E-11 0.52048643E-12
    0.7879658E-10 0.36860154E-10
    0.20442421E-05 -0.54895991E-05
    0.29103830E-05 0.29103830E-05
    CENTRE AT -35.384 -0.52241E-03 RADIUS OF 35.384 0.0
    TZERO= -70.769 -0.18617E-01 TINFIN= 0.29222E-05 -0.63898E-05
    THE 1/(10*x) IN NEUS K AT W= 6 IS 0.38097E 06 0.25917E 07 0.26420E 07
    PARTIAL OF T W.R.T. X AT W 6 IS 0.51292E 06 -0.25917E 07 0.26420E 07
    MAGNITUDE OF TR. FCN. IS
    0.92853E-02 0.74594 1.8721 13.046 69.096 6.9019
    MAGNITUDE OF TR. FCN. IS
    0.24722E-01 1.4685 2.4004 13.301 69.096 6.9019
    REAL T1 IMAG T1 REAL T2 IMAG T2 REAL T3 IMAG T3 REAL T4 IMAG T4
    0.82298E-02 -0.95768E-03 0.24281E-01 -0.46508E-02 0.16347E-01 -0.25150E-02 0.16347E-01 -0.25150E-02
    0.33641 -0.66577 -0.53396E-01 -1.9475 0.19702 -1.2030 0.19702 -1.2030
    -0.26685 -1.4530 -1.2485 -2.0253 -0.97506 -2.0665 -0.97506 -2.0665
    -3.4939 -12.570 -4.1532 -12.636 -3.9852 -12.625 -3.9852 -12.625
    -67.476 14.873 -67.471 14.894 -67.473 14.889 -67.473 14.889
    -0.67326 6.8690 -0.67321 6.8690 -0.67323 6.8690 -0.67323 6.8690
    PIXEL= 1 I FOR ELEMENT 2
    -0.99584728E-05 0.27704609E-05
    -0.48449957E-10 0.22627231E-10
    0.43937999E-05 0.13826706E-04
    -0.30259434E-05 0.12043174E-05
    CENTRE AT -0.88452E-02 -0.11190 RADIUS OF 0.11224 0.0
    
```

THE 1/(Q+X) IN NEUS K AT W= 1 IS
PARTIAL OF T W.R.T. X AT W 1 IS
PIXI= 2 1 FOR ELEMENT 2
0.3448974E-01 0.14632009E-03
0.2328304E-08 -0.61118044E-09
0.26533306E-02 -0.65193474E-02
0.12443196E-01 -0.37163754E-02

CENTRE AT -0.58491 -0.71343 RADIUS OF 0.92255 0.0
TZERO= -0.50455E-05 0.38612E-05 TINFIN= -1.1555 -1.4384

THE 1/(Q+X) IN NEUS K AT W= 2 IS
PARTIAL OF T W.R.T. X AT W 2 IS
PIXI= 3 1 FOR ELEMENT 2
0.13257493E-03 -0.19261033E-03
-0.69849193E-09 -0.44556123E-08
-0.4335049E-02 -0.60879290E-01
-0.76503828E-02 -0.27236236E-01

CENTRE AT -0.96868 -0.80622 RADIUS OF 1.2603 0.0
TZERO= -0.14711E-04 0.13752E-04 TINFIN= -1.8876 -1.6687

THE 1/(Q+X) IN NEUS K AT W= 3 IS
PARTIAL OF T W.R.T. X AT W 3 IS
PIXI= 4 1 FOR ELEMENT 2
0.46722279E-05 -0.12761258E-04
0.15110709E-06 -0.59604645E-07
-0.77500939E-02 -0.10561248E-02
-0.2147604E-01 -0.10275251

CENTRE AT -4.5318 -5.5172 RADIUS OF 7.1287 0.0
TZERO= -0.85300E-02 -0.73812E-02 TINFIN= -4.4493 -12.646

THE 1/(Q+X) IN NEUS K AT W= 4 IS
PARTIAL OF T W.R.T. X AT W 4 IS
PIXI= 5 1 FOR ELEMENT 2
-0.17433194E-07 0.59872036E-08
-0.71013499E-06 0.58324076E-06
0.53243944E-04 0.248882890E-03
0.73010139E-02 0.15594683E-01

CENTRE AT -62.284 13.764 RADIUS OF 5.3090 0.0
TZERO= -56.977 13.888 TINFIN= -67.469 14.905

THE 1/(Q+X) IN NEUS K AT W= 5 IS
PARTIAL OF T W.R.T. X AT W 5 IS
PIXI= 6 1 FOR ELEMENT 2
-0.10658141E-13 0.54474691E-09
0.37408867E-08 0.36675374E-09
0.5691946E-06 0.69378313E-07
0.85328275E-06 -0.38680546E-05

CENTRE AT -0.67326 6.8681 RADIUS OF 0.89668E-03 0.0
TZERO= -0.67312 6.8672 TINFIN= -0.67319 6.8690

THE 1/(Q+X) IN NEUS K AT W= 6 IS
PARTIAL OF T W.R.T. X AT W 6 IS
MAGNITUDE OF TR. FCN. IS
0.92944E-02 0.7933 1.9809 13.221 69.095 6.9019
MAGNITUDE OF TR. FCN. IS
0.24690E-01 1.4093 2.3582 13.243 69.096 6.9019
REAL T1 IMAG T1 REAL T2 IMAG T2 REAL T3 IMAG T3 REAL T4 IMAG T4
0.92469E-02 -0.88757E-03 0.24199E-01 -0.48479E-02 0.16347E-01 -0.25150E-02 0.16347E-01 -0.25150E-02
-0.32436 -0.48891 -0.43762E-01 -1.4087 0.19702 -1.2030 0.19702 -1.2030
-3.6350 -12.712 -4.1010 -2.0118 -0.97506 -2.0665 -0.97506 -2.0665
-67.473 14.884 -67.473 14.889 -67.473 14.889 -67.473 14.889
-0.67324 6.8690 -0.67322 6.8690 -0.67323 6.8690 -0.67323 6.8690

PIXI= 1 1 FOR ELEMENT 3
-0.76861324E-05 0.26711305E-05
-0.37346126E-10 0.12562396E-10
0.55336859E-05 0.15733051E-04
-0.27974329E-05 0.11694738E-05

CENTRE AT -0.55895E-02 -0.90729E-01 RADIUS OF 0.90901E-01 0.0
TZERO= -0.48421E-05 -0.48331E-07 TINFIN= -0.10495E-01 -0.18150

THE 1/(Q+X) IN NEUS K AT W= 1 IS
PARTIAL OF T W.R.T. X AT W 1 IS
PIXI= 2 1 FOR ELEMENT 3
0.27051987E-03 0.56096585E-04
0.13968339E-08 -0.24738256E-09
0.13922751E-02 -0.66558234E-02
0.10440912E-01 -0.40628389E-02

CENTRE AT -0.44841 -0.69108 RADIUS OF 0.82380 0.0
TZERO= -0.47654E-05 0.19035E-05 TINFIN= -0.89921 -1.3806

THE 1/(Q+X) IN NEUS K AT W= 2 IS
PARTIAL OF T W.R.T. X AT W 2 IS
PIXI= 3 1 FOR ELEMENT 3
0.5950871E-04 -0.13766113E-03
-0.20954758E-08 -0.43132257E-09
-0.47636709E-02 -0.37331081E-02
-0.84881857E-02 -0.21451429E-01

CENTRE AT -0.85048 -0.86198 RADIUS OF 1.2109 0.0
TZERO= -0.25044E-06 0.15328E-04 TINFIN= -1.7024 -1.7226

THE 1/(Q+X) IN NEUS K AT W= 3 IS
PARTIAL OF T W.R.T. X AT W 3 IS
PIXI= 4 1 FOR ELEMENT 3
-0.14091638E-05 -0.63906336E-05
0.15739352E-06 -0.58440492E-07
-0.3274801E-02 0.13971761E-02
-0.37626427E-01 -0.60256675E-01

CENTRE AT -2.2178 -6.2545 RADIUS OF 6.6110 0.0
TZERO= -0.35417E-02 -0.25410E-01 TINFIN= -4.3308 -12.519

THE 1/(Q+X) IN NEUS K AT W= 4 IS
PARTIAL OF T W.R.T. X AT W 4 IS
PIXI= 5 1 FOR ELEMENT 3
0.75879143E-09 -0.28503564E-08
0.48345828E-06 -0.30596857E-06
0.23818902E-05 0.69139052E-04
0.11755447E-02 0.45620352E-02

CENTRE AT -68.380 14.903 RADIUS OF 0.90783 0.0
TZERO= -69.109 14.363 TINFIN= -67.472 14.894

THE 1/(Q+X) IN NEUS K AT W= 5 IS
PARTIAL OF T W.R.T. X AT W 5 IS
PIXI= 6 1 FOR ELEMENT 3
-0.56319038E-09 0.94850039E-09
0.61358598E-08 0.45070010E-08
0.25919002E-06 0.85067484E-07
0.75881610E-06 -0.17231077E-05

CENTRE AT -0.67320 6.8689 RADIUS OF 0.12054E-03 0.0
TZERO= -0.67325 6.8688 TINFIN= -0.67321 6.8690

THE 1/(Q+X) IN NEUS K AT W= 6 IS
PARTIAL OF T W.R.T. X AT W 6 IS
MAGNITUDE OF TR. FCN. IS
0.1451E-01 1.2110 2.1636 7.0713 69.250 6.9021
MAGNITUDE OF TR. FCN. IS
0.16529E-01 1.2347 2.4778 19.153 69.043 6.9019
REAL T1 IMAG T1 REAL T2 IMAG T2 REAL T3 IMAG T3 REAL T4 IMAG T4
0.16311E-01 -0.26106E-02 0.16352E-01 -0.24142E-02 0.16347E-01 -0.25150E-02 0.16347E-01 -0.25150E-02
-1.0623 -1.2063 0.28724 -1.2009 0.19702 -1.2030 0.19702 -1.2030
-1.2628 -1.7569 -0.69668 -2.3778 -0.97506 -2.0665 -0.97506 -2.0665
-2.6504 -6.5558 -6.2679 -18.098 -3.9852 -12.625 -3.9852 -12.625
-67.778 14.199 -67.368 15.117 -67.473 14.889 -67.473 14.889
-0.67330 6.8692 -0.67320 6.8689 -0.67323 6.8690 -0.67323 6.8690

PIXI= 1 1 FOR ELEMENT 4
0.25119949E-07 -0.24126075E-06
0.24927247E-09 0.39879886E-08
0.10663443E-05 -0.17852744E-06
-0.16336379E-07 0.53203165E-08

CENTRE AT 0.16028E-01 -0.24491E-02 RADIUS OF 0.32599E-03 0.0
TZERO= 0.16250E-01 -0.26878E-02 TINFIN= 0.15715E-01 -0.23583E-02

THE 1/(Q+X) IN NEUS K AT W= 1 IS
0.12561 1.5370 0.33623 -0.77440E-01 0.34503

CENTRE AT -0.6172

PARTIAL OF T W.R.T. X AT W 1 IS 0.60803E-03 0.29483E-02 0.30103E-02
PIX(W= 2) FOR ELEMENT 4
-0.2007054E-03 -0.3738076E-05
0.76492433E-05 -0.25394722E-03
0.19229949E-04 0.38397586E-04
-0.60898648E-03 -0.18119812E-04

CENTRE AT 0.41974 -8.6071 RADIUS OF 7.4075 0.0
TZERO= 0.16888E-01 -1.2107 TINFIN= 6.7275 -12.491

THE 1/(Q*X) IN NEUS K AT W= 2 IS 0.96485E-01 0.17898
PARTIAL OF T W.R.T. X AT W 2 IS 2.6504 0.79726E-01 2.6516

PIX(W= 3) FOR ELEMENT 4
-0.63841185E-03 0.72809123E-03
-0.20910247E-02 0.21040743E-03
0.31881779E-03 0.57350844E-04
0.13057739E-02 0.12719672E-01

CENTRE AT -17.221 -16.874 RADIUS OF 21.981 0.0
TZERO= -1.5589 -1.4492 TINFIN= -10.919 -37.932

THE 1/(Q*X) IN NEUS K AT W= 3 IS 0.17594 0.27986
PARTIAL OF T W.R.T. X AT W 3 IS 8.2878 -9.0930 12.303

PIX(W= 4) FOR ELEMENT 4
0.64294115E-02 0.12071241E-01
0.13966620E-01 0.30572653E-01
0.32387408E-01 -0.20345692E-01
2.4464979 -1.1176100

CENTRE AT -36.424 -2.3091 RADIUS OF 34.039 0.0
TZERO= -2.4530 -0.14953 TINFIN= -69.736 -9.3058

THE 1/(Q*X) IN NEUS K AT W= 4 IS 0.69008 2.6208
PARTIAL OF T W.R.T. X AT W 4 IS -54.072 -170.03 170.42

PIX(W= 5) FOR ELEMENT 4
-0.10712305E-04 0.77416189E-05
-0.23465604E-04 0.18996649E-04
0.68575032E-02 0.15791802E-01
0.70636475 0.95368713

CENTRE AT -36.406 0.71196 RADIUS OF 34.148 0.0
TZERO= -2.2631 0.10047 TINFIN= -67.153 15.569

THE 1/(Q*X) IN NEUS K AT W= 5 IS 14.675 0.16150
PARTIAL OF T W.R.T. X AT W 5 IS 4.9792 10.034 11.030

PIX(W= 6) FOR ELEMENT 4
-0.13207000E-08 -0.22245672E-08
-0.16142621E-07 0.76100832E-08
0.16629992E-05 -0.35824723E-05
-0.23488014E-04 -0.13836418E-04

CENTRE AT -0.66395 6.8738 RADIUS OF 0.10461E-01 0.0
TZERO= -0.65598 6.8671 TINFIN= -0.67315 6.8688

THE 1/(Q*X) IN NEUS K AT W= 6 IS 14.720 -0.11711
PARTIAL OF T W.R.T. X AT W 6 IS 0.11345E-02 -0.21717E-02 0.24502E-02

MAGNITUDE OF TR. FCN. IS 2.2550 13.238 69.096 6.9019
MAGNITUDE OF TR. FCN. IS 0.17004E-01 1.2377 2.2947 13.239 69.096 6.9019

REAL T1 IMAG T1 REAL T2 IMAG T2 REAL T3 IMAG T3 REAL T IMAG T
0.15123E-01 -0.22396E-02 0.16801E-01 -0.26207E-02 0.16347E-01 -0.25150E-02 0.16347E-01 -0.25150E-02
0.23112 -1.1414 0.18309 -1.2241 0.19702 -1.2030 0.19702 -1.2030
-0.90166 -2.0669 -0.99993 -2.0654 -0.97506 -2.0665 -0.97506 -2.0665
-3.9502 -12.634 -3.9969 -12.622 -3.9852 -12.625 -3.9852 -12.625
-67.473 14.889 -67.473 14.889 -67.473 14.889 -67.473 14.889
-0.67323 6.8690 -0.67323 6.8690 -0.67323 6.8690 -0.67323 6.8690

PIX(W= 1) FOR ELEMENT 5
-302043.00 92046.563
56.962500 -17.480469
36.214279 -7.9755096
-0.62140566 0.24535835

CENTRE AT -0.90478E-02 -0.11255 RADIUS OF 0.11292 0.0
TZERO= 0.18749E-03 -0.73690E-06 TINFIN= 0.17788E-01 -0.28576E-02

THE 1/(Q*X) IN NEUS K AT W= 1 IS 0.97568E-05 0.64000E-07
PARTIAL OF T W.R.T. X AT W 1 IS 0.14084E-07 -0.32506E-08 0.14454E-07

PIX(W= 2) FOR ELEMENT 5
12513676. 3800384.0
2720.0000 -192.00000
-142.3992 -1902.5439
2564.0500 -1031.3749

CENTRE AT -0.57127 -0.71124 RADIUS OF 0.91219 0.0
TZERO= -0.19474E-03 0.74486E-04 TINFIN= 0.15208 -1.2670

THE 1/(Q*X) IN NEUS K AT W= 2 IS 0.10153E-04 0.43554E-06
PARTIAL OF T W.R.T. X AT W 2 IS -0.42837E-05 -0.66923E-06 0.79459E-06

PIX(W= 3) FOR ELEMENT 5
2690689.0 -6532770.0
-9264.0000 1536.0000
-2281.1594 -34.020432
-2329.5006 -4738.5508

CENTRE AT -0.93167 -0.82292 RADIUS OF 1.2443 0.0
TZERO= 0.70038E-03 0.11296E-02 TINFIN= -1.0502 -2.0616

THE 1/(Q*X) IN NEUS K AT W= 3 IS 0.10502E-04 0.31799E-06
PARTIAL OF T W.R.T. X AT W 3 IS -0.79089E-06 0.27592E-07 0.79137E-06

PIX(W= 4) FOR ELEMENT 5
-67440.000 -303360.00
223232.00 -66560.000
-1098.3352 298.60864
-8182.5313 -12655.113

CENTRE AT -2.3140 -6.5887 RADIUS OF 6.2633 0.0
TZERO= -0.53190E-01 -0.74769 TINFIN= -4.0202 -12.615

THE 1/(Q*X) IN NEUS K AT W= 4 IS 0.10637E-04 0.30856E-07
PARTIAL OF T W.R.T. X AT W 4 IS -0.37253E-06 0.10314E-06 0.38654E-06

PIX(W= 5) FOR ELEMENT 5
33708.688 -64773.000
1459280.0 -6197760.0
3.5858154 12.371063
426.14185 781.31567

CENTRE AT -67.479 14.890 RADIUS OF 0.61466E-02 0.0
TZERO= -0.70922E-05 14.884 TINFIN= -67.472 -14.889

THE 1/(Q*X) IN NEUS K AT W= 5 IS 0.10257E-04 -0.38953E-06
PARTIAL OF T W.R.T. X AT W 5 IS 0.83129E-09 0.47159E-08 0.47886E-08

PIX(W= 6) FOR ELEMENT 5
-921.66577 0.0
-626.69268 6330.9180
0.19609928E-01 0.0
0.13201885E-01 -0.13470060

REAL + IMAG. AXIS INTERCEPTS IN THE T-PLANE ARE: -7.3333 7.3333
THE 1/(Q*X) IN NEUS K AT W= 6 IS 0.70922E-05 0.0
PARTIAL OF T W.R.T. X AT W 6 IS 0.11975E-10 0.11975E-10 0.16935E-10

MAGNITUDE OF TR. FCN. IS 2.3267 13.655 141.28 13.807
MAGNITUDE OF TR. FCN. IS 0.16756E-01 1.2411 2.2446 12.749 45.730 4.6009

REAL T1 IMAG T1 REAL T2 IMAG T2 REAL T3 IMAG T3 REAL T IMAG T
0.14251E-01 1.977 2.2446 12.749 45.730 4.6009
0.16562E-01 -0.25428E-02 0.16062E-01 -0.24749E-02 0.16347E-01 -0.25150E-02 0.16347E-01 -0.25150E-02
0.20415 -1.2242 0.19025 -1.1825 0.19702 -1.2030 0.19702 -1.2030
-0.97735 -2.1115 -0.97221 -2.0231 -0.97506 -2.0665 -0.97506 -2.0665
-2.9954 -13.344 -4.8676 -11.783 -3.9852 -12.625 -3.9852 -12.625
-139.16 29.528 -44.635 9.9499 -67.473 14.889 -67.473 14.889
-1.3195 13.744 -0.45181 4.5787 -0.67323 6.8690 -0.67323 6.8690

PIX(W= 1) FOR ELEMENT 6
2084.3787 -299.98486
-34.103638 10.361451
0.12682241 -0.22022128E-01
-0.22353865E-02 0.7386989E-03

CENTRE AT 0.19479E-01 0.20853E-01 RADIUS OF 0.23576E-01 0.0
TZERO= 0.16730E-01 -0.25632E-02 TINFIN= 0.18092E-01 -0.26831E-02

THE 1/(Q*X) IN NEUS K AT W= 1 IS -0.78335E-04 0.29341E-05
PARTIAL OF T W.R.T. X AT W 1 IS -0.13619E-06 0.18253E-07 0.13741E-06

PIX(W= 2) FOR ELEMENT 6

42789.398 -131091.06
154247.56 81066.313
-0.64988159 1.1029779
0.85418701E-01 0.14907837E-01

CENTRE AT 3.5167 -0.95916E-01 RADIUS OF 3.4995
TZERO= 0.21168 -1.2460 TINFIN= 0.20758E-01 0.0
0.93920E-05 0.17406E-05
-0.38540E-05 0.11557E-04 0.12182E-04

THE 1/(Q*X) IN NEUS K AT W= 2 IS
PARTIAL OF T W.R.T. X AT W 2 IS
PIX(W= 3) FOR ELEMENT 6

-20307.145 -278664.56
57223.88 -314651.49
-0.79293413 2.9326019
-0.10498047E-01 -0.14633179E-01

CENTRE AT 2.0608 -2.2441 RADIUS OF 3.0410
TZERO= -0.97903 -2.1582 TINFIN= 0.33892E-02 0.0
0.99746E-05 0.40377E-05 0.24558E-04

THE 1/(Q*X) IN NEUS K AT W= 3 IS
PARTIAL OF T W.R.T. X AT W 3 IS
PIX(W= 4) FOR ELEMENT 6

5059733.0 -5863324.0
89561056. 56678800.
-373.76343 -219.61230
-0.41015625 0.25390625

CENTRE AT 0.45564 -7.0847 RADIUS OF 7.1003
TZERO= -1.6235 -13.874 TINFIN= -0.51903E-03 0.0
0.15184E-04 0.49461E-04 0.70238E-03

THE 1/(Q*X) IN NEUS K AT W= 4 IS
PARTIAL OF T W.R.T. X AT W 4 IS
PIX(W= 5) FOR ELEMENT 6

7062528.0 577936.00
-0.19555463E 11 0.88162140E 10
86249.063 -17484.840
-3.0000000 -4.0000000

CENTRE AT 0.45564 -7.0847 RADIUS OF 7.1003
TZERO= -1.6235 -13.874 TINFIN= -0.51903E-03 0.0
0.15184E-04 0.49461E-04 0.70238E-03

THE 1/(Q*X) IN NEUS K AT W= 5 IS
PARTIAL OF T W.R.T. X AT W 5 IS
PIX(W= 6) FOR ELEMENT 6

0.28346E-03 -1207.1 -5310.0 RADIUS OF 5445.4
0.12153E-01 -2649.0 -1465.1 TINFIN= 0.24379E-04 0.0
0.17984E-05 -0.40991E-02 0.19587E-01

THE 1/(Q*X) IN NEUS K AT W= 6 IS
PARTIAL OF T W.R.T. X AT W 6 IS
MAGNITUDE OF TR. FCN. IS
MAGNITUDE OF TR. FCN. IS

0.9200E-02 0.80134 1.9516 13.221 69.096 6.9019
0.22867E-01 1.4227 2.3757 13.243 69.096 6.9019
0.87663E-02 -0.1070E-02 0.22493E-01 -0.41198E-02 0.16347E-01 -0.25150E-02 0.16347E-01 -0.25150E-02
0.34083 -0.72525 -0.31494E-03 -1.4227 0.19702 -1.2030 0.19702 -1.2030
-0.34605 -1.9207 -1.2345 -2.0298 -0.97506 -2.0665 -0.97506 -2.0665
-3.6273 -12.713 -4.1036 -12.591 -3.9852 -12.625 -3.9852 -12.625
-67.473 14.885 -67.473 14.889 -67.473 14.889 -67.473 14.889
-0.67324 6.8690 -0.67322 6.8690 -0.67323 6.8690 -0.67323 6.8690

PIX(W= 1) FOR ELEMENT 7

-236512.88 72094.688
1.9414063 -0.52587891
5.7119141 0.74358463
-0.49341303 0.19386888

CENTRE AT -0.87427E-02 -0.11117 RADIUS OF 0.11152
TZERO= 0.81307E-05 0.25497E-06 TINFIN= 0.80599E-01 0.0
0.18235E-04 0.66799E-05 0.14898E-05

THE 1/(Q*X) IN NEUS K AT W= 1 IS
PARTIAL OF T W.R.T. X AT W 1 IS
PIX(W= 2) FOR ELEMENT 7

9586754.0 3875471.0

-117.000000 -74.000000
247.50537 -1193.8132
2095.6177 -631.32568

CENTRE AT -0.57134 -0.71120 RADIUS OF 0.91228
TZERO= 0.12724E-04 0.25753E-05 TINFIN= -0.85597 0.0
0.58025E-04 0.44974E-04 0.82057E-04

THE 1/(Q*X) IN NEUS K AT W= 2 IS
PARTIAL OF T W.R.T. X AT W 2 IS
PIX(W= 3) FOR ELEMENT 7

1192400.0 -5471114.0
-50.000000 16.000000
-1709.3438 -843.79272
-1481.8093 -4491.5742

CENTRE AT -0.93170 -0.82366 RADIUS OF 1.2436
TZERO= 0.67963E-05 0.66355E-05 TINFIN= -1.7400 0.0
0.93983E-04 0.32859E-04 0.81725E-04

THE 1/(Q*X) IN NEUS K AT W= 3 IS
PARTIAL OF T W.R.T. X AT W 3 IS
PIX(W= 4) FOR ELEMENT 7

-2831.000 -286758.00
2704.0000 -1088.0000
-1108.1641 251.99902
-7961.7695 -12776.973

CENTRE AT -2.2194 -6.2460 RADIUS OF 6.6188
TZERO= -0.16489E-02 -0.97908E-02 TINFIN= -4.3384 0.0
0.10800E-03 0.30152E-05 0.39914E-04

THE 1/(Q*X) IN NEUS K AT W= 4 IS
PARTIAL OF T W.R.T. X AT W 4 IS
PIX(W= 5) FOR ELEMENT 7

-979.18359 -204.00000
-68629.000 593.00000
2.7523041 12.914668
378.04224 830.38184

CENTRE AT -67.191 14.827 RADIUS OF 0.28802
TZERO= -67.051 14.575 TINFIN= -67.472 0.0
0.10024E-06 0.45253E-06 0.46350E-06

THE 1/(Q*X) IN NEUS K AT W= 5 IS
PARTIAL OF T W.R.T. X AT W 5 IS
PIX(W= 6) FOR ELEMENT 7

-34.424561 224.39658
1518.2000 387.53052
0.26740134E-01 0.30875266E-01
0.23008335 -0.16289192

CENTRE AT -0.67323 6.8690 RADIUS OF 0.69163E-05
TZERO= -0.67322 6.8690 TINFIN= -0.67322 0.0
0.11335E-03 0.84956E-04 0.11752E-08

THE 1/(Q*X) IN NEUS K AT W= 6 IS
PARTIAL OF T W.R.T. X AT W 6 IS
MAGNITUDE OF TR. FCN. IS
MAGNITUDE OF TR. FCN. IS

0.29718E-01 2.2429 4.1146 13.427 69.095 6.9019
0.11457E-01 0.84707 1.6870 13.264 69.096 6.9019
0.29367E-01 -0.45508E-02 0.11331E-01 -0.16897E-02 0.16347E-01 -0.25150E-02 0.16347E-01 -0.25150E-02
0.26624 -2.2271 0.19084 -0.82529 0.19702 -1.2030 0.19702 -1.2030
-2.3426 -3.3826 -0.47441 -1.6189 -0.97506 -2.0665 -0.97506 -2.0665
-6.0485 -11.988 -3.2696 -12.855 -3.9852 -12.625 -3.9852 -12.625
-67.473 14.889 -67.473 14.889 -67.473 14.889 -67.473 14.889
-0.67323 6.8690 -0.67323 6.8690 -0.67323 6.8690 -0.67323 6.8690

PIX(W= 1) FOR ELEMENT 8

505.80469 -110.00195
-71.635513 24.029648
-4.022192 0.40527891
0.27537346E-03 0.99670514E-03

CENTRE AT 0.19981 1.1282 RADIUS OF 1.1455
TZERO= 0.14482 -0.15982E-01 TINFIN= 0.30445E-04 0.0
0.88659E-03 0.64047E-05 0.23501E-05

THE 1/(Q*X) IN NEUS K AT W= 1 IS
PARTIAL OF T W.R.T. X AT W 1 IS
PIX(W= 2) FOR ELEMENT 8

-12673.211 -27281.500
421691.94 22601.688

0.88659E-03 0.64047E-05 0.23501E-05

-31.523422 323.15894
 3.8200684 -69.117752

THE 1/(10*x) IN NEUS K AT W= 2 IS
 PARTIAL OF T W.R.T. X AT W 2 IS
 PIX(W= 3) FOR ELEMENT 8
 -33600.375 -6644.5000
 -114614.75 -1346911.0
 433.44606 434.28667
 -570.39600 48.168213

CENTRE AT 13.921 -0.78968 RADIUS OF 13.730 0.0
 TZERO= 6.5873 -12.397 TINFIN= 0.21301 -0.89574E-02
 0.92432E-03 0.40235E-04
 -0.33261E-04 0.11043E-02

THE 1/(10*x) IN NEUS K AT W= 3 IS
 PARTIAL OF T W.R.T. X AT W 3 IS
 PIX(W= 4) FOR ELEMENT 8
 -20889.750 13099.188
 -1578546.0 718710.00
 673.83569 -203.68269
 3926.8203 8625.6445

CENTRE AT 22.568 -27.897 RADIUS OF 34.950 0.0
 TZERO= -10.911 -37.928 TINFIN= 0.60114 -0.71343
 0.95486E-03 0.28390E-04
 0.14666E-02 0.13367E-02

THE 1/(10*x) IN NEUS K AT W= 4 IS
 PARTIAL OF T W.R.T. X AT W 4 IS
 PIX(W= 5) FOR ELEMENT 8
 -11.444092 3.0994415
 -726.03125 379.53662
 -0.99182129E-01 0.43392181E-01
 -8.0460234 4.4045191

CENTRE AT -43.193 -135.92 RADIUS OF 129.38 0.0
 TZERO= -69.742 -9.2943 TINFIN= -1.7943 -13.343
 0.96724E-03 0.86193E-05
 0.21294E-02 -0.67588E-03

THE 1/(10*x) IN NEUS K AT W= 5 IS
 PARTIAL OF T W.R.T. X AT W 5 IS
 MAGNITUDE OF TR. FCN. IS
 0.16237E-01 1.2066
 MAGNITUDE OF TR. FCN. IS
 2.2707 13.142 64.844 6.8972
 0.16643E-01 1.2232 2.2898 13.271 70.637 6.9034
 REAL T1 IMAG T1 REAL T2 IMAG T2 REAL T3 IMAG T3 REAL T IMAG T
 0.16051E-01 -0.24474E-02 0.16448E-01 -0.25383E-02 0.16347E-01 -0.25150E-02 0.16347E-01 -0.25150E-02
 0.20249 -1.1895 0.19513 -1.2076 0.19702 -1.2030 0.19702 -1.2030
 -0.96327 -2.0562 -0.97903 -2.0699 -0.97506 -2.0665 -0.97506 -2.0665
 -4.0948 -12.488 -3.9477 -12.670 -3.9852 -12.625 -3.9852 -12.625
 -63.504 13.110 -68.901 15.561 -67.473 14.889 -67.473 14.889
 -0.71849 6.8597 -0.65810 6.8720 -0.67323 6.8690 -0.67323 6.8690
 PIX(W= 1) FOR ELEMENT 9
 -2278.3750 702.64844
 -0.61401367 0.27514648
 3.4788904 -0.79193139
 -0.65588951E-01 0.22184968E-01

CENTRE AT -67.470 14.895 RADIUS OF 0.64165E-02 0.0
 TZERO= -67.474 14.890 TINFIN= -67.473 -14.889
 0.11211E-02 0.20294E-04
 -0.23887E-06 0.10379E-06

THE 1/(10*x) IN NEUS K AT W= 1 IS
 PARTIAL OF T W.R.T. X AT W 1 IS
 PIX(W= 2) FOR ELEMENT 9
 5952.000 42878.000
 1840.0000 -800.0000
 -64.007950 -160.02997
 206.95512 -47.272720

CENTRE AT -0.91751E-02 -0.11348 RADIUS OF 0.11386 0.0
 TZERO= -0.28010E-03 0.34382E-04 TINFIN= 0.16654E-01 -0.25860E-02
 0.27487E-04 0.37989E-07
 0.84315E-08 -0.19393E-08

THE 1/(10*x) IN NEUS K AT W= 2 IS
 PARTIAL OF T W.R.T. X AT W 2 IS
 PIX(W= 3) FOR ELEMENT 9
 42917.000 13381.000
 -58.00000 -1920.0000
 -139.49823 -121.93411

CENTRE AT -0.88103 -0.75866 RADIUS OF 1.1660 0.0
 TZERO= -0.14937E-01 0.22062E-01 TINFIN= 0.19126 -1.2167
 0.27527E-04 0.17676E-06
 -0.15709E-06 -0.36111E-06

115.54436 -410.06738

THE 1/(10*x) IN NEUS K AT W= 3 IS
 PARTIAL OF T W.R.T. X AT W 3 IS
 PIX(W= 4) FOR ELEMENT 9
 -99320.00 -106128.00
 57600.000 -5274.000
 1286.3367 -1629.7107
 25776.164 10106.527

CENTRE AT -2.8732 0.12480 RADIUS OF 2.8991 0.0
 TZERO= 0.24562E-01 0.37079E-01 TINFIN= -0.98704 -2.0768
 0.27627E-04 0.75940E-07
 -0.33280E-06 -0.28828E-06

THE 1/(10*x) IN NEUS K AT W= 4 IS
 PARTIAL OF T W.R.T. X AT W 4 IS
 PIX(W= 5) FOR ELEMENT 9
 0.10134733E 09 -76113664.
 -524288.00 393216.00
 -45486.293 19754.059
 -2925400.0 2194104.0

CENTRE AT 2.0877 -7.6442 RADIUS OF 7.8541 0.0
 TZERO= 0.51730E-01 -0.58625E-01 TINFIN= -3.8709 -12.761
 0.27797E-04 -0.31464E-06
 0.31343E-05 -0.36210E-05

THE 1/(10*x) IN NEUS K AT W= 5 IS
 PARTIAL OF T W.R.T. X AT W 5 IS
 PIX(W= 6) FOR ELEMENT 9
 -39184.000 128637.00
 18736.000 5952.0000
 538.11621 112.78905
 1113.5437 -3630.1760

CENTRE AT -0.99635E-01 159.88 RADIUS OF 159.88 0.0
 TZERO= 0.51707E-02 0.33668E-05 TINFIN= -71.936 17.048
 0.26167E-04 0.40576E-06
 -0.11766E-03 0.54675E-04

THE 1/(10*x) IN NEUS K AT W= 6 IS
 PARTIAL OF T W.R.T. X AT W 6 IS
 MAGNITUDE OF TR. FCN. IS
 0.83295E-02 0.70009
 MAGNITUDE OF TR. FCN. IS
 2.8012 15.906 81.454 6.9116
 REAL T1 IMAG T1 REAL T2 IMAG T2 REAL T3 IMAG T3 REAL T IMAG T
 0.24575E-01 1.5983 0.24204E-01 -0.42569E-02 0.16347E-01 -0.25150E-02 0.16347E-01 -0.25150E-02
 0.20753 -0.66862 0.91006E-01 -1.5957 0.19702 -1.2030 0.19702 -1.2030
 -0.49119 -1.3749 -1.3511 -2.4538 -0.97506 -2.0665 -0.97506 -2.0665
 -2.5538 -8.4286 -4.8937 -15.135 -3.9852 -12.625 -3.9852 -12.625
 -46.794 6.7891 -78.734 20.873 -67.473 14.889 -67.473 14.889
 -0.98584 6.7920 -0.56688 6.8883 -0.67323 6.8690 -0.67323 6.8690
 PIX(W= 1) FOR ELEMENT 10
 -100665.25 24688.133
 -4.7368164 1.6577148
 0.59220886 0.79845715
 -0.32310903 0.11753702

CENTRE AT -0.14175E-01 3.5399 RADIUS OF 3.3937 0.0
 TZERO= -0.17418E-02 0.14618 TINFIN= -0.62778 6.8777
 0.27982E-04 0.19075E-06
 0.12701E-05 0.25143E-06

THE 1/(10*x) IN NEUS K AT W= 1 IS
 PARTIAL OF T W.R.T. X AT W 1 IS
 PIX(W= 2) FOR ELEMENT 10
 1999594.0 4185419.0
 136.00000 9.6875000
 243.50342 -361.36182
 1451.3022 54.143906

CENTRE AT -0.20315E-01 -0.18647 RADIUS OF 0.18758 0.0
 TZERO= -0.48195E-04 0.46478E-05 TINFIN= 0.98659E-01 -0.33149
 0.40214E-05 0.85004E-05
 0.31274E-05 -0.62328E-06

THE 1/(10*x) IN NEUS K AT W= 2 IS
 PARTIAL OF T W.R.T. X AT W 2 IS
 PIX(W= 3) FOR ELEMENT 10
 4189321.0 3058254.0
 -99.000000 16.000000
 -274.93994 -775.99487
 1773.7302 -3606.9807

CENTRE AT -1.7127 -0.89812 RADIUS OF 1.9339 0.0
 TZERO= -0.14524E-04 0.25555E-04 TINFIN= -1.7582 -2.8315
 0.54013E-04 0.47182E-04
 -0.28771E-04 -0.18021E-03

THE 1/(Q*X) IN NEUS K AT W = 3 IS
PARTIAL OF T W.R.T. X AT W 3 IS
PIX(W = 3) FOR ELEMENT10

CENTRE AT -4.2603 0.74694 RADIUS OF 4.3253 0.0
TZERO= 0.13597E-04 -0.13745E-04 TINFIN= -3.4102 -3.4940

0.86742E-04 0.29943E-04
-0.16849E-03 -0.19074E-03 0.25903E-03

813360.0 21676352.
-1280.0000 1280.0000
-1333.6484 -4300.2422
96059.625 -71739.688

CENTRE AT -184.70 51.360 RADIUS OF 191.70 0.0
TZERO= -0.31401E-04 -0.71238E-04 TINFIN= -8.8990 -25.098

0.97423E-04 0.34085E-05
-0.43619E-03 -0.12319E-02 0.13069E-02

85221056 -64055216.
-28672.000 0.0
-24013.574 5396.5625
-2480380.0 1817898.0

CENTRE AT -1.8354 152.01 RADIUS OF 152.02 0.0
TZERO= 0.21499E-03 0.16159E-03 TINFIN= -114.52 49.967

0.10639E-03 0.20929E-04
-0.57397E-02 0.27474E-02 0.63633E-02

-41683.000 124335.44
-30.000000 40.000000
326.00220 147.19133
1203.2092 -3586.5547

CENTRE AT -0.92854E-03 3.4673 RADIUS OF 3.4674 0.0
TZERO= -0.41976E-03 -0.10056E-03 TINFIN= -0.35188 6.9170

0.19518E-03 0.91548E-05
0.62283E-04 0.12309E-04 0.63487E-04

0.82649E-02 0.70044 1.4679 8.8669 47.602 6.8641
MAGNITUDE OF TR. FCN. IS
0.24753E-01 1.5955 2.7904 15.842 81.150 6.9114
REAL T1 IMAG T1 REAL T2 IMAG T2 REAL T3 IMAG T3 REAL T IMAG T
0.81954E-02 -0.10675E-02 0.24372E-01 -0.43254E-02 0.16347E-01 -0.25150E-02 0.16347E-01 -0.25150E-02
0.21244 -0.66745 0.82578E-01 -1.5934 0.19702 -1.2030 0.19702 -1.2030
-0.46787 -1.3045 -4.8760 -15.073 -3.9852 -2.0665 -0.97506 -2.0665
-2.6800 -8.469 -4.8760 -15.073 -3.9852 -12.625 -3.9852 -12.625
-67.102 6.8845 -78.462 20.713 -67.473 14.889 -67.473 14.889
-0.97938 6.7939 -0.56913 6.8879 -0.67323 6.8690 -0.67323 6.8690

PIX(W = 1) FOR ELEMENT11
-108054.63 27034.328
-0.1098191 2.1879883
0.32997131 0.94557190
-0.33493298 0.12277710

THE 1/(Q*X) IN NEUS K AT W = 1 IS
PARTIAL OF T W.R.T. X AT W 1 IS
PIX(W = 2) FOR ELEMENT11

CENTRE AT -0.18986E-01 -0.17782 RADIUS OF 0.17883 0.0
TZERO= -0.57979E-04 0.57431E-05 TINFIN= -0.55597E-02 -0.35615

0.12216E-05 0.88598E-05
0.31064E-05 -0.62609E-06 0.31689E-05

2225075.0 4313051.0
161.00000 2.4375000
257.93408 -378.20190
1484.2427 34.127121

CENTRE AT -1.6187 -0.88272 RADIUS OF 1.8437 0.0
TZERO= -0.15656E-04 0.29252E-04 TINFIN= -1.7652 -2.7206

0.52383E-04 0.48336E-04
-0.31092E-04 -0.17625E-03 0.17897E-03

4350743.0 3004724.0
-65.000000 32.000000
-289.35669 -799.91162
1748.4094 -3665.9194

CENTRE AT -4.0607 0.65272 RADIUS OF 4.1128 0.0

THE 1/(Q*X) IN NEUS K AT W = 3 IS
PARTIAL OF T W.R.T. X AT W 3 IS
PIX(W = 4) FOR ELEMENT11

CENTRE AT 0.86663E-04 0.66761E-05 -0.11966E-04 TINFIN= -3.3534 -3.3988
-0.16556E-03 -0.18787E-03 0.25041E-03

8517686.0 21752320.
-1280.0000 1536.0000
-1371.3242 -4402.8789
96315.438 -72137.875

CENTRE AT -176.57 48.794 RADIUS OF 183.18 0.0
TZERO= -0.41247E-04 0.74996E-04 TINFIN= -8.7245 -24.593

0.97319E-04 0.38216E-05
-0.42027E-03 -0.11809E-02 0.12535E-02

85481904.0 -42257120.
-8192.0000 8192.0000
-24439.191 5678.8281
-2487838.0 1823498.0

CENTRE AT -1.8365 152.01 RADIUS OF 152.02 0.0
TZERO= 0.10726E-03 -0.15204E-04 TINFIN= -113.03 48.349

0.10600E-03 0.20057E-04
-0.55002E-02 0.26329E-02 0.60978E-02

-42409.000 124385.31
-67.000000 32.000000
526.36035 146.36133
1201.0859 -3587.9534

CENTRE AT -0.92895E-03 3.4672 RADIUS OF 3.4676 0.0
TZERO= -0.39343E-03 -0.40704E-03 TINFIN= -0.35871 6.9163

0.19108E-03 0.87724E-05
0.59684E-04 0.11795E-04 0.60838E-04

0.16526E-01 1.2182 2.2837 13.227 68.426 6.9012
MAGNITUDE OF TR. FCN. IS
0.16534E-01 1.2182 2.2863 13.250 69.778 6.9026
REAL T1 IMAG T1 REAL T2 IMAG T2 REAL T3 IMAG T3 REAL T IMAG T
0.16334E-01 -0.25127E-02 0.16360E-01 -0.25173E-02 0.16347E-01 -0.25150E-02 0.16347E-01 -0.25150E-02
0.19697 -1.2022 0.19707 -1.2038 0.19702 -1.2030 0.19702 -1.2030
-4.0039 -2.0653 -0.97548 -2.0677 -0.97506 -2.0665 -0.97506 -2.0665
-66.850 14.602 -68.106 -12.643 -3.9852 -12.625 -3.9852 -12.625
-0.68000 6.9677 -0.66645 6.8703 -0.67323 6.8690 -0.67323 6.8690

PIX(W = 1) FOR ELEMENT12
-0.56730147 0.99079978E-13
0.90107094E-14 -0.30616164E-14
-0.63199224E-10 0.10735857E-10
0.95820574E-12 -0.31716296E-12

THE 1/(Q*X) IN NEUS K AT W = 1 IS
PARTIAL OF T W.R.T. X AT W 1 IS
PIX(W = 2) FOR ELEMENT12

CENTRE AT 0.30615E-01 0.79114E-01 RADIUS OF 0.82866E-01 0.0
TZERO= 0.16322E-01 -0.25106E-02 TINFIN= 0.15565E-01 -0.23744E-02

0.10000E 21 0.10000E 21
0.10000E 21 0.10000E 21 0.14142E 21

-0.21228465E-11 0.33505171E-10
-0.3935954E-10 -0.91481493E-11
0.17283952E-10 0.13830004E-09
0.13187673E-10 0.16882495E-10

CENTRE AT -3.3396 -1.4274 RADIUS OF 3.5437 0.0
TZERO= 0.19691 -1.2014 TINFIN= -0.13193 0.78868E-01

-4.0833 0.77612
0.34829 -5.4896 5.5007

0.17783069E-10 0.51871854E-10
-0.89739799E-10 0.87240853E-10
0.60481398E-10 0.13830004E-09
0.16194690E-09 -0.41836756E-10

CENTRE AT -19.795 4.732 RADIUS OF 19.891 0.0
TZERO= -0.97421 -2.0640 TINFIN= -0.17594 1.0940

THE 1/(Q*X) IN NEUS K AT W = 3 IS
PARTIAL OF T W.R.T. X AT W 3 IS
PIX(W = 4) FOR ELEMENT12
-0.78992812E-09 0.75181106E-09
-0.12641955E-07 -0.69202706E-08
-0.13531471E-07 -0.56688805E-08
0.93566815E-08 0.58207661E-09

CENTRE AT 1.0094 -7.4151 RADIUS OF 7.2173 0.0
TZERO= -4.0224 -12.589 TINFIN= 0.60293 -0.20927

THE 1/(Q*X) IN NEUS K AT W = 4 IS
PARTIAL OF T W.R.T. X AT W 4 IS
PIX(W = 5) FOR ELEMENT12
0.26867017E-07 -0.12615732E-07
0.15989426E-05 -0.12206446E-05
0.15974365E-05 -0.12203382E-05
-0.67055225E-07 0.59604649E-07

CENTRE AT -0.36112E-01 160.13 RADIUS OF 160.13 0.0
TZERO= -66.238 14.322 TINFIN= 0.44507E-01 -0.33122E-02

THE 1/(Q*X) IN NEUS K AT W = 5 IS
PARTIAL OF T W.R.T. X AT W 5 IS
PIX(W = 6) FOR ELEMENT12
-0.2850466E-09 -0.5582063E-10
-0.57948979E-09 0.19190942E-08
-0.55292728E-09 0.17976731E-08
-0.81581675E-09 -0.25738700E-09

CENTRE AT 0.43487E-01 3.2420 RADIUS OF 3.6971 0.0
TZERO= -0.68677 6.8663 TINFIN= 0.32717E-02 -0.45482

THE 1/(Q*X) IN NEUS K AT W = 6 IS
PARTIAL OF T W.R.T. X AT W 6 IS
MAGNITUDE OF TR. FCN. IS
0.14667E-01 1.1127
MAGNITUDE OF TR. FCN. IS
0.17274E-01 1.2589

REAL T1 1.2589 REAL T2 2.3389 REAL T3 10.479 REAL T4 10.354
IMAG T1 -0.21654E-02 IMAG T2 0.17069E-01 IMAG T3 -0.26566E-02 IMAG T4 0.16347E-01
0.14596E-01 -0.21654E-02 0.17069E-01 -0.26566E-02 0.16347E-01 -0.25150E-02
0.20821 -1.0929 0.19106 -1.2443 0.19702 -1.2030 0.19702 -1.2030
-0.89372 -1.9413 -1.0053 -2.1118 -0.97506 -2.0665 -0.97506 -2.0665
-5.3396 -10.724 -3.3294 -13.219 -3.9852 -12.625 -3.9852 -12.625
-33.348 7.4663 -102.40 22.259 -67.473 14.889 -67.473 14.889
-0.33999 3.4338 -0.99970 10.306 -0.67323 6.8690 -0.67323 6.8690

PIX(W = 1) FOR ELEMENT13
-0.87246895 0.20343781
-0.81300735E-04 0.27447939E-04
0.58243692E-01 -0.10813359E-01
-0.10579268E-02 0.37658960E-03

CENTRE AT -0.23618E-01 -0.20803 RADIUS OF 0.20937 0.0
TZERO= -0.9337E-04 0.92299E-05 TINFIN= 0.18719E-01 -0.29904E-02

THE 1/(Q*X) IN NEUS K AT W = 1 IS
PARTIAL OF T W.R.T. X AT W 1 IS
PIX(W = 2) FOR ELEMENT13
16.402054 37.476807
0.13354492 -0.1559482E-01
-0.30384445 -3.5767555
0.8286228 0.22026300

CENTRE AT -1.8807 -0.92471 RADIUS OF 2.0962 0.0
TZERO= -0.95963E-03 0.31434E-02 TINFIN= 0.17500 -1.3351

THE 1/(Q*X) IN NEUS K AT W = 2 IS
PARTIAL OF T W.R.T. X AT W 2 IS
PIX(W = 3) FOR ELEMENT13
25.374023 28.778564
0.24414083E-01 -0.31445313
-0.456967 -0.1572189
0.3343248 -10.321203

CENTRE AT -7.6690 2.3698 RADIUS OF 8.0305 0.0
TZERO= 0.57267E-02 0.58976E-02 TINFIN= -1.0713 -2.2084

THE 1/(Q*X) IN NEUS K AT W = 3 IS

PARTIAL OF T W.R.T. X AT W 3 IS
PIX(W = 4) FOR ELEMENT13
-1.6581600 -316.73047
3.1875000 -4.9687500
36.321212 -67.917648
1027.3301 401.28833

CENTRE AT 1.3698 -7.3759 RADIUS OF 7.4986 0.0
TZERO= 0.13024E-02 -0.32453E-02 TINFIN= -1.6961 -14.219

THE 1/(Q*X) IN NEUS K AT W = 4 IS
PARTIAL OF T W.R.T. X AT W 4 IS
PIX(W = 5) FOR ELEMENT13
191046.00 -39716.809
-29.000000 18.000000
41.674072 2.7258301
-115407.56 52681.633

CENTRE AT -1259.5 -5547.2 RADIUS OF 5688.4 0.0
TZERO= 0.16428E-03 -0.60065E-04 TINFIN= 2675.2 -1439.1

THE 1/(Q*X) IN NEUS K AT W = 5 IS
PARTIAL OF T W.R.T. X AT W 5 IS
PIX(W = 6) FOR ELEMENT13
1747.2671 -18589.094
0.25000000 0.58593750E-01
-0.35171509 -0.73242188E-01
1215.7249 238.10406

CENTRE AT 1726.3 172.66 RADIUS OF 1734.9 0.0
TZERO= 0.18714E-05 -0.13625E-04 TINFIN= 3448.0 -41.045

THE 1/(Q*X) IN NEUS K AT W = 6 IS
PARTIAL OF T W.R.T. X AT W 6 IS
THE COMPLEX SOLNS FOR (W,ELEMENT) ARE:
0.25980E-05 -0.90911E-09
0.25416E-05 0.76076E-07
0.25620E-05 -0.20531E-06
0.25985E-05 -0.58600E-08
0.26000E-05 -0.26323E-11
0.26000E-05 0.0
0.47800E-01 0.21092E-07
0.47800E-01 0.29659E-07
0.47800E-01 -0.10985E-07
0.47800E-01 -0.91707E-06
0.47758E-01 0.81246E-04
0.47164E-01 0.68861E-03
0.44600E-01 0.29092E-08
0.44600E-01 -0.14947E-07
0.44600E-01 0.37429E-07
0.44601E-01 0.41933E-07
0.44655E-01 -0.19513E-04
0.39581E-01 -0.87370E-03
0.68301E-01 -0.92852E-04
0.68300E-01 0.63843E-06
0.68300E-01 -0.63529E-06
0.68300E-01 -0.47445E-07
0.68301E-01 0.31916E-05
0.67896E-01 -0.71040E-03
94001. 0.97851
94001. 2.1604
94000. -6.1018
93992. -14.712
97557. -275.9
21299. -42598.
3604.9 -0.11351E-01
3605.1 0.35448E-01
3604.9 0.15173E-01
3605.0 0.99731E-02
3605.0 -0.20402E-02
3605.0 0.11771E-02
9250.0 0.0

9250.0	0.28419E-02								
9250.0	-0.38523E-01								
9249.7	0.46984E-01								
9294.6	-114.07								
8391.0	1512.4								
1000.0	-0.22027E-03								
1000.0	0.60807E-04								
1000.0	0.10621E-03								
1000.0	0.24591E-02								
964.47	-71.193								
-1.0000	0.0								
35715.	0.83509								
35714.	0.64633								
35708.	0.74276								
35715.	-0.77005								
35714.	-0.13491								
35717.	6.1462								
5100.0	-0.62501E-03								
5100.0	-0.79023E-03								
5100.0	0.23546E-03								
5100.0	0.59428E-03								
5100.0	-0.67564E-02								
5100.1	0.11591								
5210.0	0.41507E-03								
5210.0	0.28712E-02								
5210.0	0.11883E-02								
5210.0	0.0								
5210.0	-0.11252E-01								
5210.1	0.14039								
0.28990E-03	-0.10631E-06								
0.28997E-03	0.62187E-07								
0.29004E-03	-0.14772E-06								
0.28997E-03	0.40589E-07								
0.29000E-03	-0.40768E-09								
0.29012E-03	0.27036E-06								
104.00	0.13143E-04								
104.00	0.42978E-04								
104.00	-0.73399E-03								
104.00	-0.22481E-03								
104.00	0.25394E-04								
104.00	0.0								
TR. FCN. 1 Y. TOLIER ARE: 1 2	0.50000	1.5000	0.10000E-11						
NUM. CCT.ELEMENTS ARE:									
0.26000E-05	0.47800E-01	0.44600E-01	0.68300E-01	94000.	3605.0	9250.0	1000.0	35714.	5100.0
5210.0	0.29000E-03	104.00							
0.20000E-03	0.24000E-02	0.62000E-02	0.80000E-01	36.400	1600.0				

MAGNITUDE OF TR. FCN. IS
2.0797 10.563
PARTIAL OF T W.R.T. X AT W 1 IS
2.0797 10.564
MAGNITUDE OF TR. FCN. IS
2.0797 10.563

REAL T1	IMAG T1	REAL T2	IMAG T2	REAL T3	IMAG T3	REAL T	IMAG T
-0.72704	-1.9501	-0.72211	-1.9503	-0.72211	-1.9503	-0.32646	-1.8514
-3.1016	-10.098	-3.1022	-10.098	-3.1019	-10.098	-2.4468	-10.683

PIXIM= 1) FOR ELEMENT 1
-0.19642707E-16 -0.45127851E-16
0.73829178E-16 -0.70897902E-16
-0.21817484E-10 -0.34713732E-10
0.47615661E-10 -0.79320744E-10

CENTRE AT -0.72211 -1.9503 RADIUS OF 0.29174E-04 0.0
TZERO= -0.72213 -1.9503 TINFIN= -0.72212 -1.9503

THE 1/(Q+X) IN NEUS K AT W= 1 IS
PARTIAL OF T W.R.T. X AT W 1 IS
0.10000E 21 0.10000E 21
PIXIM= 2) FOR ELEMENT 1
0.8976348E-15 0.61406119E-15
-0.3442340E-14 0.10887677E-13
-0.99187894E-11 -0.18596680E-10
0.15692869E-09 -0.15611352E-09

CENTRE AT -3.1111 -10.085 RADIUS OF 0.15680E-01 0.0
TZERO= -3.1014 -10.097 TINFIN= -3.1155 -10.100

THE 1/(Q+X) IN NEUS K AT W= 2 IS
PARTIAL OF T W.R.T. X AT W 2 IS
0.10000E 21 0.10000E 21 0.14142E 21

MAGNITUDE OF TR. FCN. IS
1.6047 10.398
MAGNITUDE OF TR. FCN. IS
2.2281 10.615

REAL T1	IMAG T1	REAL T2	IMAG T2	REAL T3	IMAG T3	REAL T	IMAG T
-0.5771E-01	-1.6038	-1.0705	-1.9540	-0.72211	-1.9503	-0.32646	-1.8514
-2.6233	-10.061	-3.2652	-10.101	-3.1019	-10.098	-2.4468	-10.683

PIXIM= 1) FOR ELEMENT 2
0.21528662E-03 -0.19157799E-03
0.36961865E-08 -0.25611371E-08
-0.76462440E-02 -0.81936594E-02
-0.61043701E-03 -0.26719276E-01

CENTRE AT -0.90890 -0.77233 RADIUS OF 1.1927 0.0
TZERO= -0.15489E-04 -0.18871E-05 TINFIN= -1.7802 -1.5868

THE 1/(Q+X) IN NEUS K AT W= 1 IS
PARTIAL OF T W.R.T. X AT W 1 IS
16.113 8.5570
-20.160 -3.1967 20.412

PIXIM= 2) FOR ELEMENT 2
0.6494123E-05 -0.15671831E-04
0.38649887E-07 -0.20954758E-07
-0.75354092E-02 -3.89141728E-01
-0.18012954E-01 -0.78932166E-01

CENTRE AT -3.2878 -4.5147 RADIUS OF 5.5841 0.0
TZERO= -0.20133E-02 -0.16319E-02 TINFIN= -3.5965 -10.092

THE 1/(Q+X) IN NEUS K AT W= 2 IS
PARTIAL OF T W.R.T. X AT W 2 IS
20.606 0.91351
-10.197 -0.33956 10.202

MAGNITUDE OF TR. FCN. IS
1.7114 10.542
MAGNITUDE OF TR. FCN. IS
2.1779 10.568

REAL T1	IMAG T1	REAL T2	IMAG T2	REAL T3	IMAG T3	REAL T	IMAG T
-0.8319E-01	-1.7094	-1.0110	-1.9291	-0.72211	-1.9503	-0.32646	-1.8514
-2.7448	-10.179	-3.2199	-10.065	-3.1019	-10.098	-2.4468	-10.683

PIXIM= 1) FOR ELEMENT 3
0.11325884E-03 -0.15154142E-03
0.21245796E-08 -0.30267984E-08
-0.70055896E-02 -0.5047111E-02
-0.26920261E-02 -0.21945402E-01

CENTRE AT -0.78407 -0.81855 RADIUS OF 1.1335 0.0
TZERO= -0.12536E-04 0.50252E-06 TINFIN= -1.5700 -1.6353

THE 1/(Q+X) IN NEUS K AT W= 1 IS
PARTIAL OF T W.R.T. X AT W 1 IS
18.861 8.2074
-18.578 -1.0171 18.606

PIXIM= 2) FOR ELEMENT 3
-0.1470111E-05 -0.0200000E-05
0.42375177E-07 -0.23050234E-07
-0.53326488E-02 0.10772943E-02
-0.29180828E-01 -0.49564004E-01

CENTRE AT -1.7581 -4.9882 RADIUS OF 5.2833 0.0
TZERO= -0.17167E-02 -0.54533E-02 TINFIN= -3.4535 -0.9921

THE 1/(Q+X) IN NEUS K AT W= 2 IS
PARTIAL OF T W.R.T. X AT W 2 IS
22.390 0.77839
-7.9545 2.0920 8.2250

MAGNITUDE OF TR. FCN. IS
2.6070 5.7598
MAGNITUDE OF TR. FCN. IS
2.2000 15.314

REAL T1	IMAG T1	REAL T2	IMAG T2	REAL T3	IMAG T3	REAL T	IMAG T
-0.97377	-1.7550	-0.47657	-1.9477	-0.72211	-1.9503	-0.32646	-1.8514
-2.4155	-5.2288	-4.4261	-14.660	-3.1019	-10.098	-2.4468	-10.683

PIXIM= 1) FOR ELEMENT 4
-0.56556030E-03 0.46284427E-03
-0.14194616E-02 -0.31339809E-03
0.20911917E-03 0.70441514E-01
-0.15730038E-02 0.71277842E-02

CENTRE AT -12.214 -16.496 RADIUS OF 18.537 0.0
TZERO= -1.2316 -1.5619 TINFIN= -3.5559 -32.887

THE 1/(Q+X) IN NEUS K AT W= 1 IS
PARTIAL OF T W.R.T. X AT W 1 IS
0.16298 0.25023
7.2794 -5.7513 9.2772

PIXIM= 2) FOR ELEMENT 4
0.38324429E-02 0.10284044E-01
0.74286441E-02 0.25912486E-01
0.21790014E-01 -0.10468900E-01
1.6284256 -0.46681788

CENTRE AT -36.307 -2.9336 RADIUS OF 33.969 0.0
TZERO= -2.4488 -0.19022 TINFIN= -69.104 -11.782

THE 1/(Q+X) IN NEUS K AT W= 2 IS
PARTIAL OF T W.R.T. X AT W 2 IS
0.50663 2.0882
-29.920 -138.68 141.87

MAGNITUDE OF TR. FCN. IS
2.0415 10.562
MAGNITUDE OF TR. FCN. IS
2.0922 10.564

REAL T1	IMAG T1	REAL T2	IMAG T2	REAL T3	IMAG T3	REAL T	IMAG T
-0.64428	-1.9372	-0.74887	-1.9536	-0.72211	-1.9503	-0.32646	-1.8514
-3.0662	-10.107	-3.1138	-10.095	-3.1019	-10.098	-2.4468	-10.683

PIXIM= 1) FOR ELEMENT 5
542464.0 -723404.0
3728.0000 -6656.0000
-2430.1707 -462.65991
-1022.3784 -5972.2693

CENTRE AT -0.87885 -0.78378 RADIUS OF 1.1770 0.0
TZERO= -0.83625E-03 0.11177E-03 TINFIN= -0.80355 -1.9584

THE 1/(Q+X) IN NEUS K AT W= 1 IS
PARTIAL OF T W.R.T. X AT W 1 IS
0.10446E-04 0.36336E-06
-0.84774E-06 -0.11391E-06 0.85536E-06

PIXIM= 2) FOR ELEMENT 5
-89280.000 -377088.00
51456.000 -38144.000
-1120.3882 283.68262
-6377.2305 -10412.832

CENTRE AT -1.7959 -5.0603 RADIUS OF 5.2040 0.0
TZERO= -0.69061E-01 -0.15112 TINFIN= -3.1376 -10.088

THE 1/(Q+X) IN NEUS K AT W= 2 IS
PARTIAL OF T W.R.T. X AT W 2 IS
0.10637E-04 0.37709E-07
-0.37992E-06 0.98501E-07 0.39249E-06

MAGNITUDE OF TR. FCN. IS
2.1176 10.663
MAGNITUDE OF TR. FCN. IS
2.0431 10.248

RFAL T1	IMAG T1	REAL T2	IMAG T2	REAL T3	IMAG T3	REAL T	IMAG T
-0.72337	-1.9902	-0.72044	-1.9118	-0.72211	-1.9503	-0.32646	-1.8514
-2.4207	-10.569	-3.6764	-9.5660	-3.1019	-10.098	-2.4468	-10.683
PIXIWM= 1 FOR ELEMENT 6							
-19275.101	-245577.38						
490071.56	-202675.00						
-0.74830151	2.5492706						
0.19531250E-01	-0.34103394E-01						
THE 1/(Q+X) IN NEUS K AT W= 1 IS							
PARTIAL OF T W.R.T. X AT W 1 IS		CENTRE AT	2.5656	-2.0740	RADIUS OF	3.2901	0.0
MAGNITUDE OF TR. FCN. IS		TZERO=	-0.72416	-2.0316	TINFIN=	0.14387E-01	0.34384E-02
MAGNITUDE OF TR. FCN. IS		0.98826E-05	0.33068E-05				
PIXIWM= 2 FOR ELEMENT 6							
3386406.0	-3652400.0						
45555616.	31090240.						
-192.36546	-109.37646						
-0.70129000E-02	-0.58593750E-01						
THE 1/(Q+X) IN NEUS K AT W= 2 IS							
PARTIAL OF T W.R.T. X AT W 2 IS		CENTRE AT	0.46470	-5.6682	RADIUS OF	5.6870	0.0
MAGNITUDE OF TR. FCN. IS		TZERO=	-1.6411	-10.951	TINFIN=	-0.10021E-03	-0.24765E-03
MAGNITUDE OF TR. FCN. IS		0.15714E-04	0.39358E-04				
PIXIWM= 1 FOR ELEMENT 7							
5540656.0	-5554283.0						
-120.00000	32.000000						
-1465.9197	-1230.1431						
-263.02002	-4481.9531						
THE 1/(Q+X) IN NEUS K AT W= 1 IS							
PARTIAL OF T W.R.T. X AT W 1 IS		CENTRE AT	-0.87892	-0.78342	RADIUS OF	1.1774	0.0
MAGNITUDE OF TR. FCN. IS		TZERO=	0.13690E-04	0.79483E-05	TINFIN=	-1.6108	-1.7057
MAGNITUDE OF TR. FCN. IS		0.86187E-04	0.37512E-04				
PIXIWM= 2 FOR ELEMENT 7							
-70053.000	-372539.00						
1776.0000	-800.00000						
-1131.1704	223.03369						
-6143.9336	-10529.168						
THE 1/(Q+X) IN NEUS K AT W= 2 IS							
PARTIAL OF T W.R.T. X AT W 2 IS		CENTRE AT	-1.7754	-4.9826	RADIUS OF	5.2844	0.0
MAGNITUDE OF TR. FCN. IS		TZERO=	-0.12083E-02	-0.49945E-02	TINFIN=	-3.4616	-9.9907
MAGNITUDE OF TR. FCN. IS		0.10794E-03	0.38352E-05				
PIXIWM= 1 FOR ELEMENT 8							
1.4996	10.528						
-1.7096	-3.3638						
-5.2417	-9.6536						
-33400.063	-12007.500						
27552.31	-1140593.0						
326.88843	463.16286						
-391.01953	-94.788086						
THE 1/(Q+X) IN NEUS K AT W= 1 IS							
PARTIAL OF T W.R.T. X AT W 1 IS		CENTRE AT	21.609	-19.594	RADIUS OF	28.460	0.0
MAGNITUDE OF TR. FCN. IS		TZERO=	-3.5660	-32.867	TINFIN=	0.53433	-0.46712
MAGNITUDE OF TR. FCN. IS		0.95011E-03	0.32445E-04				
PIXIWM= 2 FOR ELEMENT 8							
-22735.125	10857.563						
-1699044.0	482250.00						
698.10571	-140.83755						
THE 1/(Q+X) IN NEUS K AT W= 2 IS							
PARTIAL OF T W.R.T. X AT W 2 IS		CENTRE AT	-32.618	-146.90	RADIUS OF	139.95	0.0
MAGNITUDE OF TR. FCN. IS		TZERO=	-69.102	-11.789	TINFIN=	-0.82298	-10.609
MAGNITUDE OF TR. FCN. IS		0.96676E-03	0.80677E-05				
PIXIWM= 1 FOR ELEMENT 9							
2.0844	10.586						
-0.71020	-1.9598						
-3.1686	-10.005						
49244.000	10340.000						
1773.0000	-4105.0000						
-140.87862	-125.37416						
142.40878	-368.30957						
THE 1/(Q+X) IN NEUS K AT W= 1 IS							
PARTIAL OF T W.R.T. X AT W 1 IS		CENTRE AT	-2.1626	-0.31185	RADIUS OF	2.1817	0.0
MAGNITUDE OF TR. FCN. IS		TZERO=	0.17720E-01	0.87010E-01	TINFIN=	-0.73426	-1.9609
MAGNITUDE OF TR. FCN. IS		0.27819E-04	0.19276E-06				
PIXIWM= 2 FOR ELEMENT 9							
-529760.00	6080.0000						
-3584.0000	-14544.000						
784.39746	-1101.4941						
13603.398	4652.7773						
THE 1/(Q+X) IN NEUS K AT W= 2 IS							
PARTIAL OF T W.R.T. X AT W 2 IS		CENTRE AT	2.1876	-6.2128	RADIUS OF	6.5629	0.0
MAGNITUDE OF TR. FCN. IS		TZERO=	-0.64494E-02	-0.27528E-01	TINFIN=	-3.0327	-10.190
MAGNITUDE OF TR. FCN. IS		0.27818E-04	-0.24494E-06				
PIXIWM= 1 FOR ELEMENT 10							
1.3068	7.0247						
2.5728	12.694						
-0.31381	-1.2686						
-1.9225	-4.7620						
4092410.0	3180592.0						
23.000000	-26.000000						
-159.12158	-743.25709						
1971.5393	-2862.4802						
THE 1/(Q+X) IN NEUS K AT W= 1 IS							
PARTIAL OF T W.R.T. X AT W 1 IS		CENTRE AT	-3.5464	0.20421	RADIUS OF	3.5523	0.0
MAGNITUDE OF TR. FCN. IS		TZERO=	-0.42562E-06	0.66837E-05	TINFIN=	-3.1395	-3.3247
MAGNITUDE OF TR. FCN. IS		0.82063E-04	0.34905E-04				
PIXIWM= 2 FOR ELEMENT 10							
6771507.0	17317924.						
768.00000	48.000000						
-1034.8059	-3441.1133						
61706.250	-45063.117						
THE 1/(Q+X) IN NEUS K AT W= 2 IS							
PARTIAL OF T W.R.T. X AT W 2 IS		CENTRE AT	-127.63	33.680	RADIUS OF	132.00	0.0
MAGNITUDE OF TR. FCN. IS		TZERO=	-0.17446E-04	0.37527E-04	TINFIN=	-7.0642	-20.056
MAGNITUDE OF TR. FCN. IS		0.97327E-04	0.39547E-05				
PIXIWM= 1 FOR ELEMENT 11							
1.3131	7.0247						
2.5633	12.643						
-0.30878	-1.2762						
-1.9827	-4.7888						
4284714.0	3136533.0						
-17.000000	-9.0000000						
-169.55322	-769.31226						

1958.2507 -2924.8928

CENTRE AT -3.3776 0.14171 RADIUS OF 3.3805 0.0
TZERO= 0.35844E-05 -0.52342E-06 TINFIN= -3.0908 -3.2267

THE 1/(Q+X) IN NEUS K AT W= 1 IS
PARTIAL OF T W.R.T. X AT W 1 IS
PIX(W= 2) FOR ELEMENT11
0.497540.0 17374592.
254.00000 656.00000
-1004.8613 -3523.2969
61860.219 -45336.387

CENTRE AT -121.70 31.860 RADIUS OF 125.80 0.0
TZERO= -0.37691E-04 -0.16390E-06 TINFIN= -6.9283 -19.651

THE 1/(Q+X) IN NEUS K AT W= 2 IS
PARTIAL OF T W.R.T. X AT W 2 IS
MAGNITUDE OF TR. FCN. IS
2.0785 10.556
MAGNITUDE OF TR. FCN. IS
2.0809 10.571

REAL T1	IMAG T1	REAL T2	IMAG T2	REAL T3	IMAG T3	REAL T	IMAG T
-0.72174	-1.9492	-0.72248	-1.9515	-0.72211	-1.9503	-0.32646	-1.8514
-3.1136	-10.086	-3.0901	-10.110	-3.1019	-10.098	-2.4468	-10.683

PIX(W= 1) FOR ELEMENT12
0.15656046E-10 0.48202539E-10
-0.82606713E-10 0.65270248E-10
0.60481398E-10 0.0
0.38403414E-09 -0.12926193E-09

CENTRE AT -4.1989 -0.81943 RADIUS OF 3.6561 0.0
TZERO= -0.72137 -1.9480 TINFIN= -6.3496 2.1372

THE 1/(Q+X) IN NEUS K AT W= 1 IS
PARTIAL OF T W.R.T. X AT W 1 IS
PIX(W= 2) FOR ELEMENT12
-0.49636184E-09 0.49620130E-09
-0.65500885E-08 -0.34496181E-08
-0.70522219E-08 -0.15215846E-08
-0.61263563E-08 0.46129571E-08

CENTRE AT 1.5995 -5.4191 RADIUS OF 6.6328 0.0
TZERO= -3.1253 -10.074 TINFIN= -0.69522 0.80411

THE 1/(Q+X) IN NEUS K AT W= 2 IS
PARTIAL OF T W.R.T. X AT W 2 IS
MAGNITUDE OF TR. FCN. IS
1.9377 9.7094
MAGNITUDE OF TR. FCN. IS
2.1317 10.839

REAL T1	IMAG T1	REAL T2	IMAG T2	REAL T3	IMAG T3	REAL T	IMAG T
-0.64516	-1.8272	-0.75124	-1.9949	-0.72211	-1.9503	-0.32646	-1.8514
-3.9867	-8.8532	-2.6984	-10.498	-3.1019	-10.098	-2.4468	-10.683

PIX(W= 1) FOR ELEMENT13
28.266846 28.417725
0.10473633 -0.25585938
-2.4865179 -4.0878906
6.5148649 -8.5312853

CENTRE AT -4.7600 0.65794 RADIUS OF 4.8070 0.0
TZERO= 0.26829E-02 0.63543E-02 TINFIN= -0.81576 -2.0899

THE 1/(Q+X) IN NEUS K AT W= 1 IS
PARTIAL OF T W.R.T. X AT W 1 IS
PIX(W= 2) FOR ELEMENT13
-0.80660986 -119.83203
2.9609375 -3.3554688
25.028214 -43.914474
535.73218 205.55446

CENTRE AT 1.4022 -5.9589 RADIUS OF 6.1170 0.0
TZERO= 0.27922E-02 -0.41903E-02 TINFIN= -1.7150 -11.222

THE 1/(Q+X) IN NEUS K AT W= 2 IS
PARTIAL OF T W.R.T. X AT W 2 IS
THE COMPLEX SOLNS FOR X(W,ELEMENT) ARE:
0.10678E-05 0.28978E-06

-0.44817E-04	0.21884E-04
0.32703E-01	0.95527E-03
0.16308E-01	0.97032E-02
0.28892E-01	-0.10349E-03
0.12995E-01	0.41955E-02
0.96608E-01	0.34977E-01
0.71283E-01	0.53596E-02
14200.	829.58
3412.8	1989.2
5754.4	-20639.
1727.8	234.81
5960.9	145.71
2719.6	1074.4
1192.6	-147.46
1396.2	-394.52
1002.9	731.42
-5525.4	869.04
3944.6	857.67
5365.3	821.58
4011.9	866.26
5472.1	959.64
-0.23054E-01	0.41139E-01
0.76341E-02	-0.55661E-04
22.102	18.833
211.93	5.5639

TR. FCN. 2-Y. TOLZER ARE: 1 2 0.50000 1.5000 0.10000E-08
NDM. CCT. ELEMENTS ARE:

0.26000E-05 0.47800E-01 0.44600E-01 0.68300E-01 94000. 3605.0 9250.0 1000.0 35714. 5100.0
5210.0 0.29000E-03 104.00
0.50203E-02 0.62825E-01

Computer output for test circuit # 3

The following output was obtained at the scaled test frequencies: 0.01, 1.0, 5.13, 6.0 and 6.82 radians/second, for the voltage transfer function A_v of test circuit # 3.

```

MAGNITUDE OF TR. FCN. IS
0.22173E-07
0.24254E-04
0.15906
0.16580E-02
0.74760E-01
MAGNITUDE OF TR. FCN. IS
0.11090E-07 0.12354E-04 0.30732E-03 0.13743E-02 0.47062E-02
MAGNITUDE OF TR. FCN. IS
0.33248E-07 0.35722E-04 0.92052E-03 0.95537E-03 0.12738E-01
MAGNITUDE OF TR. FCN. IS
0.22173E-07 0.24254E-04 0.15906 0.16580E-02 0.74760E-01
REAL T1      IMAG T1      REAL T2      IMAG T2      REAL T3      IMAG T3      REAL T      IMAG T
0.11042E-07 -0.10324E-08 0.33080E-07 -0.33303E-08 0.22069E-07 -0.21430E-08 0.22069E-07 -0.21430E-08
0.12641E-05 -0.12289E-04 0.33791E-05 -0.35562E-04 0.23931E-05 -0.24136E-04 0.23931E-05 -0.24136E-04
-0.4334E-06 -0.30731E-03 -0.53355E-05 0.92051E-03 -0.15590 0.31547E-01 -0.15590 0.31547E-01
-0.24754E-04 -0.13741E-02 0.91291E-05 0.95533E-03 0.11614E-04 0.16580E-02 0.11614E-04 0.16580E-02
-0.50354E-04 0.47059E-02 0.28671E-02 -0.12411E-01 0.70890E-01 -0.23742E-01 0.70890E-01 -0.23742E-01
PIX(W= 1 ) FOR ELEMENT 1
-0.35211551E-14 0.39227091E-15
0.23981372E-27 -0.37865321E-28
0.62456719E-14 0.10366853E-13
-0.96289011E-19 0.19586044E-19
CENTRE AT -0.14043E-06 -0.15609E-05 RADIUS OF 0.15672E-05 0.0
TZERO= 0.68455E-13 -0.31275E-14 TINF= -0.31221E-05
0.10000E 21 0.10000E 21
THE 1/(10*x) IN NEUS K AT W= 1 IS 0.10000E 21 0.10000E 21 0.14142E 21
PARTIAL OF Y W.R.T. X AT W 1 IS 0.10000E 21 0.10000E 21 0.14142E 21
PIX(W= 2 ) FOR ELEMENT 1
-0.29520955E-12 0.35892487E-11
0.66174445E-22 0.26469780E-22
0.5318497E-10 -0.16804336E-09
0.11133233E-12 0.21314883E-13
CENTRE AT -0.14362E-02 -0.15441E-03 RADIUS OF 0.14445E-02 0.0
TZERO= -0.58190E-11 0.18915E-10 TINF= -0.75317E-04 -0.63861E-03
10.108
0.26336E-02 -0.29082E-01 0.29201E-01
THE 1/(10*x) IN NEUS K AT W= 2 IS 46.045
PARTIAL OF Y W.R.T. X AT W 2 IS 0.26336E-02 -0.29082E-01 0.29201E-01
PIX(W= 3 ) FOR ELEMENT 1
-0.99774354E-07 0.19797632E-07
0.1387788E-16 0.83266727E-16
-0.12471901E-03 0.24992609E-04
0.75975386E-08 0.39314319E-07
CENTRE AT -0.61150E-01 -0.10366E-04 RADIUS OF 0.81150E-01 0.0
TZERO= -0.25499E-10 0.82949E-09 TINF= -0.61908E-06 0.30708E-03
94837.
0.12979E 06 0.63435E 06
THE 1/(10*x) IN NEUS K AT W= 3 IS 40067.
PARTIAL OF Y W.R.T. X AT W 3 IS 40067. 0.10295E 06
PIX(W= 4 ) FOR ELEMENT 1
0.7011519E-11 0.2239238E-09
0.25478751E-17 -0.21345230E-18
0.15541055E-07 0.14938751E-05
0.77234397E-09 -0.16646420E-10
CENTRE AT -0.13771 0.17937E-02 RADIUS OF 0.13773 0.0
TZERO= 0.23312E-09 0.31001E-08 TINF= 0.57640E-05 0.51707E-03
16.601
-0.45057E-02 -4.5727 4.5727
THE 1/(10*x) IN NEUS K AT W= 4 IS 4007.9
PARTIAL OF Y W.R.T. X AT W 4 IS -0.45057E-02 -4.5727 4.5727
PIX(W= 5 ) FOR ELEMENT 1
0.44001396E-07 -0.99900248E-08
0.19428903E-15 -0.12490009E-15

```

0.44887244E-04 -0.15911004E-04
0.39914703E-07 0.25654327E-06

CENTRE AT 0.40353E-01 0.27850E-02 RADIUS OF 0.40449E-01 0.0
TZERO= -0.48119E-08 0.17461E-08 TINFIN= 0.45734E-01 -0.44499E-02

THE 1/(Q*X) IN NEUS K AT W= 5 IS 9007.0
PARTIAL OF T W.R.T. X AT W 5 IS -995.30
MAGNITUDE OF TR. FCN. IS -1145.8 1517.7

0.22247E-07 0.44500E-04 0.76796E-02 0.40150E-02 0.11164
MAGNITUDE OF TR. FCN. IS

0.27054E-07 0.16698E-04 0.76362E-02 0.10445E-02 0.40815E-01
REAL T1 IMAG T1 REAL T2 IMAG T2 REAL T3 IMAG T3 REAL T IMAG T

0.22217E-07 -0.11583E-08 0.21835E-07 -0.31023E-08 0.22069E-07 -0.21430E-08 0.22069E-07 -0.21430E-08
0.31825E-05 -0.43741E-04 0.11056E-05 -0.16601E-04 0.23901E-05 -0.24136E-04 0.23901E-05 -0.24136E-04
-0.52359E-C3 -0.77520E-02 -0.21784E-03 0.76332E-02 -0.15590 0.31547E-01 -0.15590 0.31547E-01
-0.95721E-04 0.40138E-02 0.15892E-04 0.10444E-02 0.11614E-04 0.16580E-02 0.11614E-04 0.16580E-02
0.75601E-01 0.82151E-01 0.32155E-01 -0.25139E-01 0.70890E-01 -0.23742E-01 0.70890E-01 -0.23742E-01

PIX(W= 1) FOR ELEMENT 2
0.13979469E-13 0.48111217E-13
-0.31909098E-21 -0.10694837E-20
0.42812021E-12 -0.12775718E-12
0.26366382E-23 -0.25849394E-24

CENTRE AT 0.11134E-07 0.11158E-13 RADIUS OF 0.11141E-07 0.0
TZERO= 0.22276E-07 -0.15977E-09 TINFIN= -0.58205E-11 -0.11331E-11

THE 1/(Q*X) IN NEUS K AT W= 1 IS 0.10000E 21 0.10000E 21
PARTIAL OF T W.R.T. X AT W 1 IS 0.10000E 21 0.10000E 21 0.14142E 21

PIX(W= 2) FOR ELEMENT 2
-0.49274973E-10 -0.76196383E-10
0.16215944E-13 0.59887770E-14
-0.22724596E-07 0.60849231E-07
0.17347235E-17 0.86736174E-18

CENTRE AT 0.11869E-03 -0.43216E-06 RADIUS OF 0.11870E-03 0.0
TZERO= 0.15246E-03 -0.11422E-03 TINFIN= -0.31660E-11 0.29691E-10

THE 1/(Q*X) IN NEUS K AT W= 2 IS 90.654
PARTIAL OF T W.R.T. X AT W 2 IS -0.44140E-03 0.21658E-02 0.22103E-02

PIX(W= 3) FOR ELEMENT 2
-0.15817350E-06 0.28217601E-05
-0.13564566E-07 -0.60701552E-07
-0.15680885E-02 0.31865924E-03
0.32741809E-10 0.11732482E-09

CENTRE AT -0.80827E-01 0.15656E-02 RADIUS OF 0.80842E-01 0.0
TZERO= -0.16762E-03 0.38676E-02 TINFIN= 0.54504E-08 0.75928E-07

THE 1/(Q*X) IN NEUS K AT W= 3 IS 733.85
PARTIAL OF T W.R.T. X AT W 3 IS 241.42 604.45 650.88

PIX(W= 4) FOR ELEMENT 2
0.24743496E-08 -0.13091551E-07
0.12513859E-09 -0.39469773E-11
0.53398202E-06 -0.87827939E-05
0.63948846E-13 -0.71054274E-14

CENTRE AT -0.37350E-01 0.10907E-02 RADIUS OF 0.37366E-01 0.0
TZERO= -0.14533E-02 -0.92841E-02 TINFIN= -0.12471E-08 -0.72053E-08

THE 1/(Q*X) IN NEUS K AT W= 4 IS 116.50
PARTIAL OF T W.R.T. X AT W 4 IS 0.29332E-02 -0.19318 0.19320

PIX(W= 5) FOR ELEMENT 2
0.28332543E-05 -0.25843783E-05
-0.14390045E-06 -0.16712869E-06
0.17151418E-03 -0.52676070E-03
-0.50931703E-09 -0.63737389E-08

CENTRE AT 0.49549E-01 0.30259E-01 RADIUS OF 0.58065E-01 0.0
TZERO= -0.18201E-02 0.57328E-01 TINFIN= -0.10659E-04 0.44363E-05

THE 1/(Q*X) IN NEUS K AT W= 5 IS 144.10
PARTIAL OF T W.R.T. X AT W 5 IS -13.096 -5.1757 14.082

MAGNITUDE OF TR. FCN. IS
0.22173E-07 0.24254E-04 0.15906 0.16580E-02 0.74760E-01
MAGNITUDE OF TR. FCN. IS 0.15906 0.16580E-02 0.74760E-01
REAL T1 IMAG T1 REAL T2 IMAG T2 REAL T3 IMAG T3 REAL T IMAG T

0.22069E-07 -0.21430E-08 0.22069E-07 -0.21430E-08 0.22069E-07 -0.21430E-08 0.22069E-07 -0.21430E-08
0.23901E-05 -0.24136E-04 0.23901E-05 -0.24136E-04 0.23901E-05 -0.24136E-04 0.23901E-05 -0.24136E-04
-0.15590 0.31547E-01 -0.15590 0.31547E-01 -0.15590 0.31547E-01 -0.15590 0.31547E-01
0.11614E-04 0.16580E-02 0.11614E-04 0.16580E-02 0.11614E-04 0.16580E-02 0.11614E-04 0.16580E-02
0.70890E-01 -0.23742E-01 0.70890E-01 -0.23742E-01 0.70890E-01 -0.23742E-01 0.70890E-01 -0.23742E-01

MAGNITUDE OF TR. FCN. IS
0.22173E-07 0.24254E-04 0.16142 0.16125E-02 0.24849E-01
MAGNITUDE OF TR. FCN. IS

0.22173E-07 0.24258E-04 0.14770 0.17060E-02 0.20261E-01
REAL T1 IMAG T1 REAL T2 IMAG T2 REAL T3 IMAG T3 REAL T IMAG T

0.22069E-07 -0.21430E-08 0.22069E-07 -0.21430E-08 0.22069E-07 -0.21430E-08 0.22069E-07 -0.21430E-08
0.24293E-05 -0.24127E-04 0.23508E-05 -0.24144E-04 0.23901E-05 -0.24136E-04 0.23901E-05 -0.24136E-04
-0.16113 -0.95757E-02 -0.13395 0.62241E-01 -0.15590 0.31547E-01 -0.15590 0.31547E-01
-0.34446E-05 0.16125E-02 0.31739E-04 0.17057E-02 0.11614E-04 0.16580E-02 0.11614E-04 0.16580E-02
0.67897E-02 0.23904E-01 0.58996E-02 -0.19383E-01 0.70890E-01 -0.23742E-01 0.70890E-01 -0.23742E-01

PIX(W= 2) FOR ELEMENT 4
0.44225493E-17 0.97652394E-18
-0.34448279E-22 0.19429030E-21
0.38890332E-15 -0.12005371E-14
0.60979755E-20 0.18396497E-20

CENTRE AT 0.26527E-06 -0.14706E-04 RADIUS OF 0.96663E-05 0.0
TZERO= 0.24685E-05 -0.24117E-04 TINFIN= -0.10232E-06 -0.50462E-05

THE 1/(Q*X) IN NEUS K AT W= 2 IS 0.10000E 21 0.10000E 21
PARTIAL OF T W.R.T. X AT W 2 IS 0.10000E 21 0.10000E 21 0.14142E 21

PIX(W= 3) FOR ELEMENT 4
-0.34108775E-11 -0.28664415E-11
-0.36403611E-12 -0.57856861E-12
-0.12543438E-06 0.78217965E-07
0.12241230E-09 0.19878144E-09

CENTRE AT -0.80925E-01 0.11140E-02 RADIUS OF 0.80918E-01 0.0
TZERO= -0.14610 33569. 5432.7

THE 1/(Q*X) IN NEUS K AT W= 3 IS 6653.6
PARTIAL OF T W.R.T. X AT W 3 IS 2043.2 5033.8

PIX(W= 4) FOR ELEMENT 4
-0.23899331E-14 -0.54917584E-14
-0.8705644E-17 0.36163476E-17
-0.15931700E-10 -0.16587620E-10
-0.18995222E-15 -0.91615084E-17

CENTRE AT 0.20896E-02 0.80957E-03 RADIUS OF 0.22445E-02 0.0
TZERO= -0.22500E-04 0.15691E-02 TINFIN= -0.60087E-05 0.56807E-05

THE 1/(Q*X) IN NEUS K AT W= 4 IS 0.10000E 21 0.10000E 21
PARTIAL OF T W.R.T. X AT W 4 IS 0.10000E 21 0.10000E 21 0.14142E 21

PIX(W= 5) FOR ELEMENT 4
0.14572746E-10 -0.34155006E-11
-0.61367144E-13 -0.11144278E-12
0.9681794E-06 -0.39002765E-06
-0.62172489E-12 -0.27249314E-11

CENTRE AT 0.39946E-01 0.15694E-02 RADIUS OF 0.39977E-01 0.0
TZERO= 0.13777E-02 0.12089E-01 TINFIN= -0.42300E-06 0.26441E-05

THE 1/(Q*X) IN NEUS K AT W= 5 IS 0.15194E 06 0.40075E 06
PARTIAL OF T W.R.T. X AT W 5 IS -20287. -24801. 32042.

MAGNITUDE OF TR. FCN. IS
0.22173E-07 0.23985E-04 0.12070E-01 0.65697E-03 0.43571E-03

MAGNITUDE OF TR. FCN. IS 0.11790E-01 0.31649E-02 0.43412E-03

0.22173E-07 0.24528E-04 0.11790E-01 0.31649E-02 0.43412E-03
REAL T1 IMAG T1 REAL T2 IMAG T2 REAL T3 IMAG T3 REAL T IMAG T

0.22069E-07 -0.21430E-08 0.22069E-07 -0.21430E-08 0.22069E-07 -0.21430E-08 0.22069E-07 -0.21430E-08
0.23637E-05 -0.23868E-04 0.246170E-05 -0.24409E-04 0.23901E-05 -0.24136E-04 0.23901E-05 -0.24136E-04
-0.14071E-02 -0.11988E-01 -0.37058E-03 0.11784E-01 -0.15590 0.31547E-01 -0.15590 0.31547E-01
0.62292E-06 0.65697E-03 0.70185E-04 -0.31641E-02 0.11614E-04 0.16580E-02 0.11614E-04 0.16580E-02
0.43471E-05 0.43569E-03 0.46528E-06 -0.43412E-03 0.70890E-01 -0.23742E-01 0.70890E-01 -0.23742E-01

PIX(W= 2) FOR ELEMENT 5
-0.87215459E-14 0.88403514E-13
-0.20665379E-17 -0.41226455E-18
-0.23500846E-12 -0.24049535E-11
0.38963510E-18 0.11223187E-18

CENTRE AT -0.13314E-01 -0.13384E-02 RADIUS OF 0.13384E-01 0.0
 TZERO= 0.23379E-05 -0.23607E-04 TINFIN= -0.30549E-06 0.16506E-06
 THE 1/(Q*X) IN NEUS K AT W= 2 IS
 PARTIAL OF T W.R.T. X AT W 2 IS
 PIX(W= 3) FOR ELEMENT 5
 0.00000E 21 0.10000E 21 0.14142E 21
 -0.29374006E-07 0.16452031E-07
 -0.14584671E-09 -0.58774874E-09
 -0.12401029E-03 0.25319488E-04
 0.62527761E-12 0.0

CENTRE AT -0.80441E-01 0.33675E-02 RADIUS OF 0.80532E-01 0.0
 TZERO= -0.47544E-03 -0.59932E-02 TINFIN= 0.48040E-08 0.98827E-09
 THE 1/(Q*X) IN NEUS K AT W= 3 IS
 PARTIAL OF T W.R.T. X AT W 3 IS
 PIX(W= 4) FOR ELEMENT 5
 5225.5 32832. 5288.0
 1850.5 4953.6 5288.0
 -0.24354004E-10 0.24747591E-08
 0.10137594E-11 0.11352932E-13
 -0.19032445E-07 0.23292314E-05
 -0.10214052E-13 -0.97144515E-16

CENTRE AT 0.82636E-01 0.25017E-03 RADIUS OF 0.82636E-01 0.0
 TZERO= -0.22482E-06 0.40964E-03 TINFIN= 0.58746E-11 -0.43852E-08
 THE 1/(Q*X) IN NEUS K AT W= 4 IS
 PARTIAL OF T W.R.T. X AT W 4 IS
 PIX(W= 5) FOR ELEMENT 5
 -389.1 38.215 6.3159
 0.10760 6.3150 6.3159
 0.45388655E-07 -0.15055921E-07
 -0.3341138E-11 -0.98509994E-11
 0.56710051E-04 -0.18993858E-04
 -0.35527137E-14 0.14210855E-13

CENTRE AT 0.39364E-01 -0.17489E-03 RADIUS OF 0.39364E-01 0.0
 TZERO= 0.15689E-05 0.21765E-03 TINFIN= 0.13179E-09 -0.20645E-09
 THE 1/(Q*X) IN NEUS K AT W= 5 IS
 PARTIAL OF T W.R.T. X AT W 5 IS
 MAGNITUDE OF TR. FCN. IS
 -1923.6 -2573.9 32131.
 0.22173E-07 0.24254E-04 0.15906 0.16580E-02 0.74760E-01
 MAGNITUDE OF TR. FCN. IS
 0.22173E-07 0.24254E-04 0.15906 0.16580E-02 0.74760E-01
 REAL T1 REAL T2 REAL T3 IMAG T3 REAL T IMAG T
 0.22069E-07 -0.21430E-08 0.22069E-07 -0.21430E-08 0.22069E-07 -0.21430E-08 0.22069E-07 -0.21430E-08
 0.23901E-05 -0.24136E-04 0.23901E-05 -0.24136E-04 0.23901E-05 -0.24136E-04 0.23901E-05 -0.24136E-04
 -0.15590 0.31547E-01 -0.15590 0.31547E-01 -0.15590 0.31547E-01 -0.15590 0.31547E-01
 0.11614E-04 0.16580E-02 0.11614E-04 0.16580E-02 0.11614E-04 0.16580E-02 0.11614E-04 0.16580E-02
 0.70890E-01 -0.23742E-01 0.70890E-01 -0.23742E-01 0.70890E-01 -0.23742E-01 0.70890E-01 -0.23742E-01
 MAGNITUDE OF TR. FCN. IS
 0.22112E-07 0.24187E-04 0.14703 0.16528E-02 0.42564E-01
 MAGNITUDE OF TR. FCN. IS
 0.22112E-07 0.24187E-04 0.14703 0.16528E-02 0.42564E-01
 REAL T1 REAL T2 REAL T3 IMAG T3 REAL T IMAG T
 0.22009E-07 -0.21372E-08 0.22089E-07 -0.21449E-08 0.22069E-07 -0.21430E-08 0.22069E-07 -0.21430E-08
 0.23754E-05 -0.24070E-04 0.23950E-05 -0.24157E-04 0.23901E-05 -0.24136E-04 0.23901E-05 -0.24136E-04
 -0.14452 0.27051E-01 -0.16013 0.32231E-01 -0.15590 0.31547E-01 -0.15590 0.31547E-01
 0.24465E-04 0.14234E-02 0.72873E-05 0.16597E-02 0.11614E-04 0.16580E-02 0.11614E-04 0.16580E-02
 0.41993E-01 0.69514E-02 0.8864E-01 0.42390E-01 0.70890E-01 -0.23742E-01 0.70890E-01 -0.23742E-01
 PIX(W= 1) FOR ELEMENT 7
 -0.52863359E-03 0.45120716E-04
 0.3833781E-11 -0.63105077E-12
 0.1606469E-05 -0.1593022E-06
 -0.35177485E-13 0.68543160E-14

CENTRE AT 0.89907E-07 0.70519E-06 RADIUS OF 0.71058E-06 0.0
 TZERO= 0.73002E-08 -0.57064E-09 TINFIN= 0.22130E-07 -0.21488E-08
 THE 1/(Q*X) IN NEUS K AT W= 1 IS
 PARTIAL OF T W.R.T. X AT W 1 IS
 PIX(W= 2) FOR ELEMENT 7
 0.12449E-04 -0.53622E-09 0.76071E-15
 0.75723E-15 -0.72623E-16
 -0.17317200 0.53550720
 -0.38491562E-05 -0.13501849E-05
 0.38973661E-03 -0.17351704E-02
 0.41056015E-07 0.13605025E-07

CENTRE AT 0.93361E-04 -0.36328E-05 RADIUS OF 0.93253E-04 0.0
 TZERO= 0.12451E-04 -0.44497E-08
 0.18447E-12 -0.81848E-12 0.83901E-12

CENTRE AT 0.90191 2.6918 RADIUS OF 2.8629 0.0
 TZERO= -0.77248E-02 -0.22693E-01 TINFIN= -0.16934 -0.36931E-01
 THE 1/(Q*X) IN NEUS K AT W= 3 IS
 PARTIAL OF T W.R.T. X AT W 3 IS
 PIX(W= 4) FOR ELEMENT 7
 0.11450E-04 0.28953E-07 0.16577E-06
 0.15404E-06 0.61252E-07
 704.30003 137.83594
 36188.000 40211.000
 -286.12134 112.49081
 -44.297897 29.616119
 -0.69473267E-01 -0.47688457E-01
 -0.34100479 0.14398247
 0.23898265E-03 0.56736171E-03

CENTRE AT -0.37135E-03 0.72105E-03 RADIUS OF 0.10122E-02 0.0
 TZERO= 0.34176E-03 0.27491E-05 TINFIN= -0.14299E-05 0.16632E-02
 THE 1/(Q*X) IN NEUS K AT W= 4 IS
 PARTIAL OF T W.R.T. X AT W 4 IS
 PIX(W= 5) FOR ELEMENT 7
 0.12443E-04 -0.86372E-07 0.17484E-09
 -0.16184E-09 0.66152E-10
 -39080240 62646032
 -270.00000 -10031.000
 444.92725 74.312500
 -49.347107 72.279907

CENTRE AT 0.44047E-02 -0.10491 RADIUS OF 0.10492 0.0
 TZERO= 0.11333E-03 -0.75008E-04 TINFIN= 0.81504E-01 -0.17607
 THE 1/(Q*X) IN NEUS K AT W= 5 IS
 PARTIAL OF T W.R.T. X AT W 5 IS
 MAGNITUDE OF TR. FCN. IS
 0.33000E-05 0.35009E-05 0.73461E-06
 0.56829E-06 -0.46551E-06
 0.22203E-07 0.24287E-04 0.15991 0.16608E-02 0.79636E-01
 MAGNITUDE OF TR. FCN. IS
 0.22142E-07 0.24220E-04 0.15825 0.16550E-02 0.70375E-01
 REAL T1 IMAG T1 REAL T2 IMAG T2 REAL T3 IMAG T3 REAL T IMAG T
 0.22099E-07 -0.21456E-08 0.22039E-07 -0.21404E-08 0.22069E-07 -0.21430E-08 0.22069E-07 -0.21430E-08
 0.24331E-05 -0.24165E-04 0.23473E-05 -0.24106E-04 0.23901E-05 -0.24136E-04 0.23901E-05 -0.24136E-04
 -0.15695 0.31547E-01 -0.15494 0.32233E-01 -0.15590 0.31547E-01 -0.15590 0.31547E-01
 0.56461E-05 0.16008E-02 0.28750E-04 0.16548E-02 0.11614E-04 0.16580E-02 0.11614E-04 0.16580E-02
 0.74648E-01 -0.27740E-01 0.67344E-01 -0.20431E-01 0.70890E-01 -0.23742E-01 0.70890E-01 -0.23742E-01
 PIX(W= 1) FOR ELEMENT 8
 0.73070703E-06 -0.62179197E-07
 -0.16036844E-13 0.29456896E-14
 -0.13287149E-10 0.10991208E-11
 0.90142834E-19 -0.18330322E-19

CENTRE AT 0.29772E-06 0.32391E-05 RADIUS OF 0.32529E-05 0.0
 TZERO= 0.22130E-07 -0.21482E-08 TINFIN= 0.68514E-08 -0.81280E-09
 THE 1/(Q*X) IN NEUS K AT W= 1 IS
 PARTIAL OF T W.R.T. X AT W 1 IS
 PIX(W= 2) FOR ELEMENT 8
 0.10333038E-02 -0.71276445E-03
 0.14685874E-07 0.26764660E-07
 -0.22309905E-07 -0.12805685E-07
 0.14692414E-12 0.45519144E-13
 -22.409622 -13.737778
 -3.9467745 -1.5106688
 0.87463856E-02 0.23789048E-01
 0.20245947E-02 0.30878671E-02
 CENTRE AT 0.96247E-05 -0.13554E-04 RADIUS OF 0.12818E-04 0.0
 TZERO= 0.88950E-05 0.24762E-05 -0.24194E-04 TINFIN= 0.58345E-05 -0.13086E-05
 THE 1/(Q*X) IN NEUS K AT W= 2 IS
 PARTIAL OF T W.R.T. X AT W 2 IS
 PIX(W= 3) FOR ELEMENT 8
 -22.409622 -13.737778
 -3.9467745 -1.5106688
 0.87463856E-02 0.23789048E-01
 0.20245947E-02 0.30878671E-02
 CENTRE AT -0.14779 0.20987E-01 RADIUS OF 0.13314E-01 0.0
 TZERO= -0.15805 0.29477E-01 TINFIN= -0.14191 0.32931E-01
 THE 1/(Q*X) IN NEUS K AT W= 3 IS
 CENTRE AT 0.69760E-03 0.43375E-03

PARTIAL OF T W.R.T. X AT W 3 IS 0.91607E-05 0.70342E-05 0.11550E-04
 PIX(W= 4) FOR ELEMENT 8
 -0.41327374 0.80815673E-01
 0.12491213E-03 0.68918359E-03
 0.13385201E-04 0.36214479E-04
 -0.31944949E-04 0.16825452E-04

CENTRE AT -0.14063E-03 0.78834E-03 RADIUS OF 0.88285E-03 0.0
 TZERO= -0.23015E-04 0.16633E-02 TINFIN= 0.24529E-04 -0.78934E-04

THE 1/(Q+X) IN NEUS K AT W= 4 IS 0.16427E-04 0.89894E-07
 PARTIAL OF T W.R.T. X AT W 4 IS 0.15635E-06 -0.27372E-07 0.15873E-06
 PIX(W= 5) FOR ELEMENT 8
 83.254318 -71.784912
 -4.2020197 8.3539181
 -0.23328066E-01 0.75702310E-01
 -0.16360730E-01 -0.63534551E-04

CENTRE AT 0.15153E-01 -0.79895E-01 RADIUS OF 0.79119E-01 0.0
 TZERO= 0.78574E-01 -0.32592E-01 TINFIN= 0.15831E-03 -0.22100E-02

THE 1/(Q+X) IN NEUS K AT W= 5 IS 0.56013E-03 -0.29602E-03
 PARTIAL OF T W.R.T. X AT W 5 IS -0.33245E-04 0.32999E-04 0.46842E-04
 MAGNITUDE OF TR. FCN. IS 0.1125E-07 0.23883E-04 0.84314E-01 0.16568E-02 0.73279E-01
 MAGNITUDE OF TR. FCN. IS 0.33067E-07 0.24324E-04 0.22446 0.16582E-02 0.75258E-01
 REAL T1 IMAG T1 REAL T2 IMAG T2 REAL T3 IMAG T3 REAL T IMAG T
 0.1112E-07 -0.23973E-09 0.32722E-07 -0.47655E-08 0.22069E-07 -0.21430E-08 0.22069E-07 -0.21430E-08
 0.7202E-05 -0.24611E-04 0.15732E-05 -0.24273E-04 0.23901E-05 -0.24136E-04 0.23901E-05 -0.24136E-04
 -0.83761E-01 0.96416E-02 -0.21606 0.60839E-01 -0.15590 0.31547E-01 -0.15590 0.31547E-01
 -0.24434E-04 0.16566E-02 0.23648E-04 0.16581E-02 0.11614E-04 0.16580E-02 0.11614E-04 0.16580E-02
 0.70070E-01 -0.21654E-01 0.71171E-01 -0.24466E-01 0.70890E-01 -0.23742E-01 0.70890E-01 -0.23742E-01

PIX(W= 1) FOR ELEMENT 9
 0.41774044E-02 0.12440751E-02
 0.19428903E-15 -0.41633363E-16
 0.13558747E-06 0.45459456E-06
 -0.10432773E-12 0.31123392E-13

CENTRE AT -0.41852E-11 -0.11475E-06 RADIUS OF 0.11475E-06 0.0
 TZERO= 0.45439E-13 0.35874E-14 TINFIN= -0.13311E-10 -0.22950E-06

THE 1/(Q+X) IN NEUS K AT W= 1 IS 0.10462E-04 0.10780E-03
 PARTIAL OF T W.R.T. X AT W 1 IS 0.24279E-10 -0.47591E-11 0.24741E-10
 PIX(W= 2) FOR ELEMENT 9
 -0.2375796E-01 -0.61834433E-01
 0.98225428E-10 0.20089883E-10
 -0.67490945E-03 -0.26151398E-03
 0.63160535E-08 -0.16478172E-07

CENTRE AT -0.44218E-07 -0.12191E-04 RADIUS OF 0.12190E-04 0.0
 TZERO= -0.25379E-09 -0.14902E-08 TINFIN= -0.88772E-07 -0.24381E-04

THE 1/(Q+X) IN NEUS K AT W= 2 IS 0.11094E-02 0.13955E-03
 PARTIAL OF T W.R.T. X AT W 2 IS -0.27220E-08 -0.55475E-09 0.27780E-08
 PIX(W= 3) FOR ELEMENT 9
 21548.277 -13121.809
 2.995920 4.29426
 -5.3451080 -3.2937012
 -4.2359390 2.7154446

CENTRE AT 0.10428E-01 0.44957 RADIUS OF 0.44990 0.0
 TZERO= -0.12880E-04 -0.20722E-03 TINFIN= -0.34749 0.72215

THE 1/(Q+X) IN NEUS K AT W= 3 IS 0.13453E-03 0.17722E-03
 PARTIAL OF T W.R.T. X AT W 3 IS -0.14818E-03 0.58954E-04 0.15946E-03
 PIX(W= 4) FOR ELEMENT 9
 -0.10816574E-01 0.20813394
 0.15320256E-06 0.14901161E-07
 0.10710010E-01 0.55202455E-03
 0.40402836E-06 -0.17780592E-04

CENTRE AT 0.24195E-04 0.82922E-03 RADIUS OF 0.82884E-03 0.0
 TZERO= -0.33251E-07 0.73780E-06 TINFIN= 0.47720E-04 0.16577E-02

THE 1/(Q+X) IN NEUS K AT W= 4 IS 0.11205E-02 0.24413E-04
 PARTIAL OF T W.R.T. X AT W 4 IS 0.40464E-07 0.61431E-09 0.40469E-07
 PIX(W= 5) FOR ELEMENT 9
 8.3112793 16.842529
 0.16734123E-01 -0.21530151E-01
 0.2689384 -0.60819620
 -0.34947842E-02 0.50592136E-01

CENTRE AT 0.24779E-01 -0.42022E-01 RADIUS OF 0.49602E-01 0.0
 TZERO= 0.63371E-03 0.13063E-02 TINFIN= 0.71708E-01 -0.25957E-01

THE 1/(Q+X) IN NEUS K AT W= 5 IS 0.10981E-02 0.26150E-05
 PARTIAL OF T W.R.T. X AT W 5 IS 0.95608E-06 -0.24116E-05 0.25942E-05
 MAGNITUDE OF TR. FCN. IS 0.22173E-07 0.23984E-04 0.20589E-01 0.63225E-03 0.41909E-03
 MAGNITUDE OF TR. FCN. IS 0.22173E-07 0.24529E-04 0.19938E-01 0.26627E-02 0.41761E-03
 REAL T1 IMAG T1 REAL T2 IMAG T2 REAL T3 IMAG T3 REAL T IMAG T
 0.22069E-07 -0.21430E-08 0.22069E-07 -0.21430E-08 0.22069E-07 -0.21430E-08 0.22069E-07 -0.21430E-08
 0.23677E-05 -0.23867E-04 0.24129E-05 -0.24410E-04 0.23901E-05 -0.24136E-04 0.23901E-05 -0.24136E-04
 -0.41029E-02 -0.20177E-01 -0.10516E-02 0.19910E-01 -0.15590 0.31547E-01 -0.15590 0.31547E-01
 -0.53896E-06 0.63225E-03 0.69469E-04 -0.26618E-02 0.11614E-04 0.16580E-02 0.11614E-04 0.16580E-02
 0.30034E-05 0.41909E-03 0.14418E-05 -0.41761E-03 0.70890E-01 -0.23742E-01 0.70890E-01 -0.23742E-01

PIX(W= 2) FOR ELEMENT 10
 -0.83503974E-05 0.10080260E-03
 -0.23597944E-08 -0.43355652E-09
 -0.54536713E-08 0.81571670E-07
 0.17168824E-13 0.39690473E-14

CENTRE AT -0.74811E-03 -0.86572E-04 RADIUS OF 0.75309E-03 0.0
 TZERO= 0.23457E-05 -0.23604E-04 TINFIN= -0.34433E-07 0.21275E-06

THE 1/(Q+X) IN NEUS K AT W= 2 IS -0.82615E-03 0.13423E-04
 PARTIAL OF T W.R.T. X AT W 2 IS 0.16762E-08 -0.20148E-07 0.20217E-07
 PIX(W= 3) FOR ELEMENT 10
 -11.91386 15.730932
 -0.31598032 -1.1172419
 -4.1320906 0.85379136
 0.76368451E-06 0.17285347E-05

CENTRE AT -0.79977E-01 0.57583E-02 RADIUS OF 0.80184E-01 0.0
 TZERO= -0.13927E-02 -0.10179E-01 TINFIN= 0.94355E-07 0.43782E-06

THE 1/(Q+X) IN NEUS K AT W= 3 IS 0.78661E-01 0.57330
 PARTIAL OF T W.R.T. X AT W 3 IS 0.29570E-01 0.87055E-01 0.91940E-01
 PIX(W= 4) FOR ELEMENT 10
 -0.2930899E-01 2.5393534
 0.99181803E-03 0.14129088E-04
 -0.61584241E-03 0.72030723E-01
 0.29103830E-10 -0.90949470E-12

CENTRE AT 0.65277E-01 0.37177E-03 RADIUS OF 0.65278E-01 0.0
 TZERO= -0.10559E-05 0.39059E-03 TINFIN= 0.16080E-10 0.40391E-09

THE 1/(Q+X) IN NEUS K AT W= 4 IS -0.12039 0.15291E-02
 PARTIAL OF T W.R.T. X AT W 4 IS 0.39334E-05 0.19959E-03 0.19963E-03
 PIX(W= 5) FOR ELEMENT 10
 31.486160 -17.092148
 -0.3625517E-02 -0.10762967E-01
 1.9104223 -0.6398545
 -0.46566129E-09 -0.69849193E-09

CENTRE AT 0.39393E-01 -0.72757E-04 RADIUS OF 0.39393E-01 0.0
 TZERO= 0.94314E-06 0.20936E-03 TINFIN= 0.10906E-09 0.40215E-09

THE 1/(Q+X) IN NEUS K AT W= 5 IS 4.1879 12.583
 PARTIAL OF T W.R.T. X AT W 5 IS -0.59561 -0.79266 0.99150
 MAGNITUDE OF TR. FCN. IS 0.11086E-07 0.11894E-04 0.27896E-03 0.10893E-02 0.75010E-02
 MAGNITUDE OF TR. FCN. IS 0.33259E-07 0.37105E-04 0.83573E-03 0.90077E-03 0.18774E-01
 REAL T1 IMAG T1 REAL T2 IMAG T2 REAL T3 IMAG T3 REAL T IMAG T
 0.11034E-07 -0.10715E-08 0.33103E-07 -0.32145E-08 0.22069E-07 -0.21430E-08 0.22069E-07 -0.21430E-08
 0.11740E-05 -0.11836E-04 0.36503E-05 -0.36925E-04 0.23901E-05 -0.24136E-04 0.23901E-05 -0.24136E-04
 -0.84450E-06 -0.27896E-03 -0.32119E-05 0.83572E-03 -0.15590 0.31547E-01 -0.15590 0.31547E-01
 -0.19470E-06 -0.10891E-02 0.90085E-05 0.90072E-03 0.11614E-04 0.16580E-02 0.11614E-04 0.16580E-02
 -0.20432E-03 0.74782E-02 0.63872E-02 -0.17654E-01 0.70890E-01 -0.23742E-01 0.70890E-01 -0.23742E-01

PIX(W= 1) FOR ELEMENT 11
 -0.87395979E-09 0.84865059E-10

0.2444970E-22 -0.41359031F-23
-0.10698141E-13 0.11102230E-14
-0.4800344E-16 0.941140C4E-17

CENTRE AT -0.31552E-01 -0.32493 RADIUS OF 0.32645 0.0
TZERO= 0.3040E-13 -0.1774E-14 TINFIN= -0.45466E-02 0.40942E-03

THE 1/(Q*X) IN NEUS K AT W= 1 IS
PARTIAL OF T W.R.T. X AT W 1 IS
PIX(W= 2) FOR ELEMENT11
-0.10156452E-05 0.10324002E-05
0.4143363E-16 0.14745150E-16
-0.8906668E-08 0.97619704E-07
0.59681942E-10 0.11913122E-10

CENTRE AT -0.37885E-01 -0.37638E-02 RADIUS OF 0.38072E-01 0.0
TZERO= -0.10216E-10 0.41332E-10 TINFIN= -0.66398E-04 0.61715E-03

THE 1/(Q*X) IN NEUS K AT W= 2 IS
PARTIAL OF T W.R.T. X AT W 2 IS
PIX(W= 3) FOR ELEMENT11
-0.24695039E-01 0.49089844E-02
0.45474735E-11 0.28194336E-10
-0.62048089E-01 0.12445051E-01
0.34622399E-05 0.17298735E-04

CENTRE AT -0.81120E-01 0.10610E-03 RADIUS OF 0.81120E-01 0.0
TZERO= -0.41180E-10 0.11335E-08 TINFIN= -0.11443E-06 0.27877E-03

THE 1/(Q*X) IN NEUS K AT W= 3 IS
PARTIAL OF T W.R.T. X AT W 3 IS
PIX(W= 4) FOR ELEMENT11
0.15404739E-05 0.19875074E-03
0.62527741E-12 -0.58619774E-13
0.67041774E-05 0.69136454E-03
0.32823056E-06 -0.69976380E-08

CENTRE AT -0.12635 0.17141E-02 RADIUS OF 0.12637 0.0
TZERO= 0.27054E-09 0.31481E-08 TINFIN= 0.55090E-05 0.47073E-03

THE 1/(Q*X) IN NEUS K AT W= 4 IS
PARTIAL OF T W.R.T. X AT W 4 IS
PIX(W= 5) FOR ELEMENT11
0.10478519E-01 -0.19603588E-02
0.31013769E-09 -0.29831426E-08
0.26983812E-01 -0.74281618E-02
0.12923689E-04 0.19297558E-03

CENTRE AT 0.41052E-01 0.48703E-02 RADIUS OF 0.41340E-01 0.0
TZERO= -0.80057E-07 0.26971E-06 TINFIN= 0.13848E-02 -0.67703E-02

THE 1/(Q*X) IN NEUS K AT W= 5 IS
PARTIAL OF T W.R.T. X AT W 5 IS
MAGNITUDE OF TR. FCN. IS
MAGNITUDE OF TR. FCN. IS
PIX(W= 1) FOR ELEMENT12
0.44314E-07 0.46782E-04 0.61392E-03 0.78833E-03 0.87412E-02
0.14785E-07 0.16370E-04 0.61486E-03 0.16036E-01 0.95928E-02
0.44075E-07 -0.45944E-08 0.14719E-07 -0.13943E-08 0.22069E-07 -0.21430E-08 0.22069E-07 -0.21430E-08
0.42470E-05 -0.46589E-04 0.16576E-05 -0.14286E-04 0.23901E-05 -0.24136E-04 0.23901E-05 -0.24136E-04
-0.23985E-05 0.61392E-03 -0.22532E-05 -0.61486E-03 -0.15590 0.31547E-01 -0.15590 0.31547E-01
0.80109E-05 0.78829E-03 -0.11420E-02 -0.15996E-01 0.11614E-04 0.16580E-02 0.11614E-04 0.16580E-02
0.15405E-02 -0.86043E-02 0.47901E-03 0.95808E-02 0.70890E-01 -0.23742E-01 0.70890E-01 -0.23742E-01

CENTRE AT -0.14043E-06 -0.15609E-05 RADIUS OF 0.15672E-05 0.0
TZERO= -0.22471E-08 -0.31220E-05 TINFIN= 0.19731E-13 0.48287E-14

THE 1/(Q*X) IN NEUS K AT W= 1 IS
PARTIAL OF T W.R.T. X AT W 1 IS
PIX(W= 2) FOR ELEMENT12
0.67410255E-09 -0.21690312E-08
0.14360830E-11 0.26717951E-12
-0.50038466E-07 0.64987955E-06

0.5511151E-16 0.43368087E-17

CENTRE AT -0.14363E-02 -0.15441E-03 RADIUS OF 0.14446E-02 0.0
TZERO= -0.75313E-04 -0.63868E-03 TINFIN= -0.95826E-13 0.85425E-10

THE 1/(Q*X) IN NEUS K AT W= 2 IS
PARTIAL OF T W.R.T. X AT W 2 IS
PIX(W= 3) FOR ELEMENT12
-0.12348788E-02 0.25232346E-03
0.76719516E-07 0.37936508E-06
-0.13875045E-01 0.28077576E-02
0.3664629E-11 0.22737368E-10

CENTRE AT -0.81151E-01 -0.10078E-04 RADIUS OF 0.81151E-01 0.0
TZERO= -0.61898E-06 0.30708E-03 TINFIN= 0.12223E-09 0.16635E-08

THE 1/(Q*X) IN NEUS K AT W= 3 IS
PARTIAL OF T W.R.T. X AT W 3 IS
PIX(W= 4) FOR ELEMENT12
0.69801976E-05 0.10659693E-03
0.55078093E-07 -0.41615849E-08
0.51494164E-04 0.82427938E-03
0.36379788E-11 -0.45474735E-10

CENTRE AT -0.13772 0.17937E-02 RADIUS OF 0.13773 0.0
TZERO= -0.57639E-05 0.51707E-03 TINFIN= 0.27490E-09 0.44307E-08

THE 1/(Q*X) IN NEUS K AT W= 4 IS
PARTIAL OF T W.R.T. X AT W 4 IS
PIX(W= 5) FOR ELEMENT12
0.5562262E-03 -0.22793541E-03
0.7059313E-06 0.2627375E-05
0.67193312E-02 -0.21564537E-02
-0.43655746E-10 -0.43655746E-10

CENTRE AT 0.40353E-01 0.27849E-02 RADIUS OF 0.40449E-01 0.0
TZERO= 0.55735E-03 -0.44557E-02 TINFIN= 0.40934E-08 0.84387E-08

THE 1/(Q*X) IN NEUS K AT W= 5 IS
PARTIAL OF T W.R.T. X AT W 5 IS
MAGNITUDE OF TR. FCN. IS
MAGNITUDE OF TR. FCN. IS
PIX(W= 1) FOR ELEMENT13
0.22180E-07 0.25206E-04 0.76700E-02 0.15246E-02 0.54407E-01
0.22165E-07 0.23370E-04 0.78029E-02 0.18170E-02 0.77021E-01
0.22084E-07 -0.20656E-08 0.22054E-07 -0.22202E-08 0.22069E-07 -0.21430E-08 0.22069E-07 -0.21430E-08
0.25850E-05 -0.25073E-04 0.22161E-05 -0.23265E-04 0.23901E-05 -0.24136E-04 0.23901E-05 -0.24136E-04
-0.19894E-03 0.76474E-02 -0.54458E-03 -0.77839E-02 -0.15590 0.31547E-01 -0.15590 0.31547E-01
0.13692E-04 0.15245E-02 0.84499E-05 0.18170E-02 0.11614E-04 0.14580E-02 0.11614E-04 0.14580E-02
0.38880E-01 -0.38052E-01 0.72556E-01 0.25846E-01 0.70890E-01 -0.23742E-01 0.70890E-01 -0.23742E-01

CENTRE AT 0.10942E-07 0.39361E-10 RADIUS OF 0.11338E-07 0.0
TZERO= 0.22098E-07 -0.19881E-08 TINFIN= -0.39521E-09 -0.94147E-10

THE 1/(Q*X) IN NEUS K AT W= 1 IS
PARTIAL OF T W.R.T. X AT W 1 IS
PIX(W= 2) FOR ELEMENT13
0.64764860E-09 -0.33148948E-08
0.84651904E-13 0.26190055E-13
-0.93240615E-09 0.29742750E-08
0.2862937E-16 0.43368087E-17

CENTRE AT 0.11863E-03 -0.44554E-06 RADIUS OF 0.11863E-03 0.0
TZERO= 0.28044E-05 -0.26085E-04 TINFIN= 0.14193E-08 0.91786E-08

THE 1/(Q*X) IN NEUS K AT W= 2 IS
PARTIAL OF T W.R.T. X AT W 2 IS
PIX(W= 3) FOR ELEMENT13
-0.12312678E-02 0.28094510E-03
0.10720350E-05 0.47487583E-05
-0.13842165E-01 0.28128985E-02
0.33469405E-09 0.17607817E-08

CENTRE AT -0.80791E-01 0.17412E-02 RADIUS OF 0.80810E-01 0.0

THE 1/(Q*X) IN NEUS K AT W = 3 IS
PARTIAL OF T W.R.T. X AT W 3 IS
PIX(W = 3) FOR ELEMENT13

0.14681270E-07 -0.68043022E-06
-0.96031427E-09 -0.10478106E-10
0.48331060E-07 -0.11388556E-05
-0.12612134E-11 0.67723605E-13

CENTRE AT -0.33815E-01 0.10644E-02 RADIUS OF 0.33832E-01 0.0
TZERO= 0.15045E-04 0.14110E-02 TINFIN= 0.10627E-06 0.11029E-05

THE 1/(Q*X) IN NEUS K AT W = 4 IS
PARTIAL OF T W.R.T. X AT W 4 IS
PIX(W = 4) FOR ELEMENT13

0.53480879E-04 -0.25624813E-03
0.77284785E-05 0.73847968E-05
0.13500499E-02 -0.15698313E-02
-0.23559551E-07 -0.24796464E-07

CENTRE AT 0.40128E-01 0.21133E-02 RADIUS OF 0.40184E-01 0.0
TZERO= 0.21056E-01 -0.33257E-01 TINFIN= -0.16608E-05 0.16436E-04

THE 1/(Q*X) IN NEUS K AT W = 5 IS
PARTIAL OF T W.R.T. X AT W 5 IS
MAGNITUDE OF TR. FCN. IS

0.11086E-07 0.12125E-04 0.14078E-01 0.89171E-03 0.92732E-02
MAGNITUDE OF TR. FCN. IS 0.32663E-07 0.36387E-04 0.39422E-01 0.23236E-02 0.32740E-01

REAL T1 IMAG T1 REAL T2 IMAG T2 REAL T3 IMAG T3 REAL T IMAG T
0.11034E-07 -0.10715E-08 0.32510E-07 -0.31569E-08 0.22069E-07 -0.21430E-08 0.22069E-07 -0.21430E-08
0.11949E-05 -0.12086E-04 0.35856E-05 0.38861E-01 -0.23901E-05 -0.24136E-04 0.23901E-05 -0.24136E-04
-0.23492E-02 -0.13881E-01 -0.66280E-02 0.38861E-01 -0.15590 0.31547E-01 -0.15590 0.31547E-01
0.67415E-05 0.89149E-03 0.15156E-04 0.23236E-02 0.11614E-04 0.16580E-02 0.11614E-04 0.16580E-02
0.21426E-02 -0.90223E-02 0.92252E-02 0.31414E-01 0.70890E-01 -0.23742E-01 0.70890E-01 -0.23742E-01

PIX(W = 1) FOR ELEMENT14
-0.40178416E-10 0.39014911E-11
-0.25075686E-19 0.50342729E-20
0.26393998E-10 -0.25629915E-11
-0.10734410E-16 0.21045609E-17

CENTRE AT 0.21709E-01 0.22356 RADIUS OF 0.22461 0.0
TZERO= -0.64513E-09 0.62654E-10 TINFIN= 0.41057E-06 -0.39868E-07

THE 1/(Q*X) IN NEUS K AT W = 1 IS
PARTIAL OF T W.R.T. X AT W 1 IS
PIX(W = 2) FOR ELEMENT14

0.47356004E-08 0.47826841E-07
0.43369087E-17 0.92157185E-18
-0.1509463E-10 0.13189896E-09
0.12838472E-10 0.25678123E-11

CENTRE AT -2.1791 -0.21580 RADIUS OF 2.1898 0.0
TZERO= -0.10191E-10 0.91686E-10 TINFIN= 0.82378E-02 0.71269E-01

THE 1/(Q*X) IN NEUS K AT W = 2 IS
PARTIAL OF T W.R.T. X AT W 2 IS
PIX(W = 3) FOR ELEMENT14

0.11908696E-02 0.46508605E-04
0.39381121E-09 0.14697434E-08
-0.11475768E-01 0.16960779E-02
0.22183129E-04 0.10597202E-03

CENTRE AT -0.79452E-01 0.63762E-02 RADIUS OF 0.80107E-01 0.0
TZERO= 0.28206E-06 0.12452E-05 TINFIN= -0.89380E-04 0.13789E-01

THE 1/(Q*X) IN NEUS K AT W = 3 IS
PARTIAL OF T W.R.T. X AT W 3 IS
PIX(W = 4) FOR ELEMENT14

0.11394430E-07 -0.24367992E-05
-0.78159701E-13 0.44408921E-14
0.59192416E-07 0.44797634E-05
0.52818919E-07 -0.68036332E-09

CENTRE AT -0.69057 0.56658E-02 RADIUS OF 0.69059 0.0
TZERO= 0.16724E-08 0.32083E-07 TINFIN= -0.39165E-05 0.11791E-01

THE 1/(Q*X) IN NEUS K AT W = 4 IS
PARTIAL OF T W.R.T. X AT W 4 IS
PIX(W = 5) FOR ELEMENT14

0.50247158E-03 -0.35681040E-03
-0.15188562E-09 -0.42291504E-09
0.58033392E-02 -0.3109462E-02
-0.32533455E-04 -0.60042978E-04

CENTRE AT 0.41093E-01 0.49935E-02 RADIUS OF 0.41395E-01 0.0
TZERO= -0.19638E-06 0.70222E-06 TINFIN= 0.48556E-04 0.10372E-01

THE 1/(Q*X) IN NEUS K AT W = 5 IS
PARTIAL OF T W.R.T. X AT W 5 IS
MAGNITUDE OF TR. FCN. IS

0.44346E-07 0.60680E-04 0.55735E-03 0.73331E-03 0.13171E-01
MAGNITUDE OF TR. FCN. IS 0.15179E-07 0.15961E-04 0.55812E-03 0.63495E-02 0.15464E-01

REAL T1 IMAG T1 REAL T2 IMAG T2 REAL T3 IMAG T3 REAL T IMAG T
0.44138E-07 -0.42860E-08 0.15108E-07 -0.14671E-08 0.22069E-07 -0.21430E-08 0.22069E-07 -0.21430E-08
0.49572E-05 -0.42860E-08 0.15108E-07 -0.14671E-08 0.22069E-07 -0.21430E-08 0.22069E-07 -0.21430E-08
0.78196E-05 0.55735E-03 -0.26498E-05 -0.55811E-03 -0.15590 0.31547E-01 -0.15590 0.31547E-01
0.36196E-02 -0.12665E-01 0.10824E-02 0.15426E-01 0.70890E-01 -0.23742E-01 0.70890E-01 -0.23742E-01

PIX(W = 1) FOR ELEMENT15
-0.23493429E-11 0.22812481E-12
-0.11540005E-17 0.22625044E-18
-0.67231531E-09 0.65284583E-10
0.11540003E-17 -0.22624631E-18

CENTRE AT 0.94780E-02 0.97606E-01 RADIUS OF 0.98065E-01 0.0
TZERO= -0.49588E-06 0.48153E-07 TINFIN= 0.17328E-08 -0.16826E-09

THE 1/(Q*X) IN NEUS K AT W = 1 IS
PARTIAL OF T W.R.T. X AT W 1 IS
PIX(W = 2) FOR ELEMENT15

0.23923974E-09 0.26603857E-08
0.16258271E-11 0.32429240E-12
-0.77950347E-07 0.79422830E-06
-0.69388939E-16 -0.17347235E-16

CENTRE AT -0.37904E-01 -0.37657E-02 RADIUS OF 0.38090E-01 0.0
TZERO= -0.66389E-04 0.61709E-03 TINFIN= 0.13140E-10 -0.88656E-10

THE 1/(Q*X) IN NEUS K AT W = 2 IS
PARTIAL OF T W.R.T. X AT W 2 IS
PIX(W = 3) FOR ELEMENT15

0.12348789E-02 0.25269908E-03
0.70137048E-07 0.34628019E-06
-0.13875070E-01 0.28077496E-02
0.45474735E-11 0.23646862E-10

CENTRE AT -0.81136E-01 0.10611E-03 RADIUS OF 0.81136E-01 0.0
TZERO= -0.11429E-06 0.27877E-03 TINFIN= -0.16457E-10 0.17009E-08

THE 1/(Q*X) IN NEUS K AT W = 3 IS
PARTIAL OF T W.R.T. X AT W 3 IS
PIX(W = 4) FOR ELEMENT15

0.15355172E-05 0.49373004E-04
0.23232754E-07 -0.99480491E-09
0.11614567E-04 0.39726822E-03
0.32400749E-11 -0.25224267E-12

CENTRE AT -0.12636 0.17141E-02 RADIUS OF 0.12637 0.0
TZERO= 0.55090E-05 0.47073E-03 TINFIN= 0.39616E-09 0.81675E-08

THE 1/(Q*X) IN NEUS K AT W = 4 IS
PARTIAL OF T W.R.T. X AT W 4 IS
PIX(W = 5) FOR ELEMENT15

0.4792897E-03 -0.25401870E-03
0.9650483E-06 0.4062418E-05
0.81001405E-02 -0.22358519E-02
-0.17462298E-09 -0.17171260E-08

CENTRE AT 0.41052E-01 0.48706E-02 RADIUS OF 0.41340E-01 0.0
TZERO= 0.13849E-02 -0.67706E-02 TINFIN= -0.65718E-07 0.25740E-06

THE 1/(Q*X) IN NEUS K AT W = 5 IS
PARTIAL OF T W.R.T. X AT W 5 IS
MAGNITUDE OF TR. FCN. IS

0.49189E-07 0.50342729E-20
0.26393998E-10 -0.25629915E-11
-0.10734410E-16 0.21045609E-17

CENTRE AT -49.678 -105.18 RADIUS OF 1019.6 0.0
TZERO= 6.0189 6.2768 TINFIN= 8.6962

