

THE DAT AS A PREDICTOR OF SUCCESS IN HIGH SCHOOL MATHEMATICS COURSES  
AND AN AID IN MATHEMATICS COURSE SELECTION

Joanne L. Tipping

A Major Thesis

Presented to

The Faculty of Graduate Studies and Research

The University of Manitoba

In Partial Fulfillment

of the Requirements for the Degree

Master of Education

in Counselling

April, 1979



THE DAT AS A PREDICTOR OF SUCCESS IN HIGH SCHOOL MATHEMATICS COURSES  
AND AN AID IN MATHEMATICS COURSE SELECTION

BY

JOANNE L. TIPPING

A dissertation submitted to the Faculty of Graduate Studies of  
the University of Manitoba in partial fulfillment of the requirements  
of the degree of

MASTER OF EDUCATION

© 1979

Permission has been granted to the LIBRARY OF THE UNIVERSITY OF MANITOBA to lend or sell copies of this dissertation, to the NATIONAL LIBRARY OF CANADA to microfilm this dissertation and to lend or sell copies of the film, and UNIVERSITY MICROFILMS to publish an abstract of this dissertation.

The author reserves other publication rights, and neither the dissertation nor extensive extracts from it may be printed or otherwise reproduced without the author's written permission.

### Acknowledgements

The writer wishes to express her gratitude to Allin and Alberta Pybus for their help and support. The writer also wishes to thank her advisers, Dr. R. Henjum, Dr. R. Hudson, and Dr. L. Sandals. A special thanks to Dr. J. Rogan for all her statistical help.

## Table of Contents

	Page
Approval Page .....	ii
Acknowledgements .....	iii
List of Figures .....	vii
List of Tables .....	viii
Abstract .....	x
I INTRODUCTION TO THE STUDY .....	1
Background and Purpose of the Study .....	1
Problems in Course Selection .....	2
Flexibility .....	2
Standards .....	4
Policy Regarding Failure .....	6
Significance of the Study .....	7
II REVIEW OF RELATED LITERATURE .....	9
The Use of Standardized Tests in Educational Prediction .....	9
Criticisms Concerning Test Development .....	9
Criticisms Concerning Test Administration .....	9
Criticisms Concerning Use of Test Results .....	11
Need for Testing in Prediction .....	13
Problems of Prediction .....	14
Intelligence Tests .....	15
Aptitude Tests .....	16
The Differential Aptitude Test .....	18
An Overview .....	18
Validity .....	19

	Page
Reliability .....	20
Revision .....	20
Pretest Orientation .....	21
The DAT Versus High School Performance as a Predictor .	22
Value of the DAT .....	23
III METHOD .....	25
The Problem .....	25
Definition of Terms .....	25
Data-Gathering Procedure .....	27
Samples .....	28
Instrumentation .....	30
Differential Aptitude Tests .....	30
Dominion Tests .....	31
Henmon-Nelson Tests .....	31
Otis Tests .....	31
Mathematics Examinations .....	32
Research Hypotheses .....	32
Null Test Hypotheses .....	32
Statistical Analysis .....	34
IV RESULTS .....	37
Sample I .....	37
Math 100 .....	37
Math 101 .....	41
Math 102 .....	41
Sample II .....	46
Math 100 .....	46

	Page
Math 101 .....	46
Math 102 .....	49
V DISCUSSION .....	53
Sample I .....	53
Sample II .....	54
Implications of the Study .....	56
References .....	66
Reference Notes .....	75
Footnotes .....	76
Appendix A: 1977 and 1978 Mathematics Cumulative Examinations	
Used to Determine Math Mark in Math 100 and Math 101 .....	77
Appendix B: Raw Data Samples I, II, and III .....	103
Appendix C: Supplementary Tables .....	114

## List of Figures

	Page
1. Computer Printout Plot for Math 101, Mixed, Sample II, of Standardized Residual (down) and Predicted Math Mark (across) .....	36
2. Sample II Regression Line for Math 100 Mark Predicted from VR + NA .....	57
3. Sample II Regression Line for Math 101 Mark Predicted from NA .....	58
4. Sample II Regression Line for Math 102 Mark Predicted from NA .....	59

List of Tables

	Page
1. Expectations of Sample I Variables' Contribution to Prediction of Math Marks .....	33
2. Standard Errors of the Estimate For Equations Predicting Mathematics Marks .....	38
3. Correlation Matrix for Test Scores and Math 100 Marks, Sample I .....	39
4. Summary of the Multiple Regression Analysis of Test Scores and Math 100 Marks, Sample I .....	40
5. Correlation Matrix for Test Scores and Math 101 Marks, Sample I .....	42
6. Summary of the Multiple Regression Analysis of Test Scores and Math 101 Marks, Sample I .....	43
7. Correlation Matrix for Test Scores and Math 102 Marks, Sample I .....	44
8. Summary of the Multiple Regression Analysis of Test Scores and Math 102 Marks, Sample I .....	45
9. Correlation Matrix for SR, VR + NA, and Math 100 Mark, Sample II (Computed for Mixed, Female, and Male Samples) .....	47
10. Summary of the Multiple Regression Analysis of VR + NA, SR, and Math 100 Mark, Sample II (Computed for Mixed, Female, and Male Samples) .....	48



	Page
11. Summary of the Regression Analysis of NA and Math 101 Mark, Sample II (Computed for Mixed, Female, and Male Samples) .....	50
12. Summary of the Regression Analysis of NA and Math 102 Mark, Sample II (Computed for Mixed, Female, and Male Samples) .....	51
13. Breakdown of Total Number of Students Passing Each Mathematics Course According to NA .....	60
14. Breakdown of Total Number of Students Passing Math 100 According to VR + NA and SR .....	63
A. Raw Data Sample I .....	103
B. Raw Data Sample II .....	109
C. Raw Data Sample III .....	112
D. Calculations Testing Significance of Differences between Sexes for Correlation Coefficients between Math Mark and DAT Subtest Scores .....	114
E. Breakdown of Total Number of Males Passing Math 100 According to VR + NA and SR .....	115
F. Breakdown of Total Number of Females Passing Math 100 According to VR + NA and SR .....	116
G. Breakdown of Males and Females Passing Math 102 According to NA .....	117

## ABSTRACT

This is a study of the relative contribution of scores on various tests to the prediction of mathematics (math) marks. Specifically, the following tests were investigated: Differential Aptitude Tests (DAT) Form S subtests Verbal Reasoning (VR), Numerical Ability (NA), composite Verbal Reasoning and Numerical Ability (VR + NA), Space Relations (SR), and Abstract Reasoning (AR); Quick-Scoring Group Test of Learning Capacity: Dominion Tests, Intermediate, Form A (DOM); Henmon-Nelson Tests of Mental Ability, Form A (HN); and Otis Quick Scoring Mental Ability Tests, Alpha, Short Form (OTIS). Math mark was defined as the percentage mark on a final, uniform, cumulative examination for Math 100 and 101, and as the final mark based on the year's work for Math 102.

Sample I consisted of 267 grade ten students of Sisler High School, Winnipeg, that school's total grade ten population with scores available on all variables. Data for each math course were subjected to a stepwise forward inclusive multiple regression analysis with all variables allowed to enter the regression equation freely.

The multiple correlation coefficients between math mark and scores on the variables were:  $.638$ ,  $F(7, 127) = 12.422$ ,  $p < .001$ , for Math 100;  $.570$ ,  $F(8, 78) = 4.684$ ,  $p < .001$  for Math 101; and  $.614$ ,  $F(5, 29) = 3.511$ ,  $p < .05$ , for Math 102. Sample I was used as a screening device to reduce the number of variables to be

considered to those with correlation coefficients significant at the .05 level. If no variable were to be found significant at that level, the one correlating most highly with math mark would be considered.

The significant variables for Math 100 Sample I were: VR + NA,  $R = .574$ ,  $F(1, 126) = 6.058$ ,  $p < .05$ ; and SR,  $R = .620$ ,  $F(1, 126) = 12.407$ ,  $p < .001$ . The significant variable for Math 101 Sample I was NA,  $R = .495$ ,  $F(1, 78) = 4.605$ ,  $p < .05$ . No variable was found to be sufficiently significant for Math 102. NA, which correlated most highly with Math 102 mark, was therefore chosen for Math 102 Sample II.

Sample II consisted of 344 Sisler students with scores available on VR + NA and SR for Math 100 and NA for Math 101 and Math 102. Data for each math course, females only, males only, and total sample were subjected to stepwise forward inclusive multiple regression analyses with variables allowed to enter the regression equation freely ( $p < .01$ ).

The multiple correlation coefficient between Math 100 mark and scores on VR + NA and SR was  $.616$ ,  $F(2, 159) = 48.670$ ,  $p < .001$  for total sample. The correlation coefficients between math mark and score on NA were:  $.473$ ,  $F(1, 130) = 37.490$ ,  $p < .001$  for Math 101 total sample; and  $.519$ ,  $F(1, 48) = 17.705$ ,  $p < .001$  for Math 102 total sample. The differences between correlation coefficients computed for females and males were not found to be statistically significant. Regression equations were derived to predict math marks for Math 100, 101 and 102. Tables were constructed so that students in grade nine could see the success or failure in math courses of previous students with similar DAT scores.

Although other factors, such as goals, values, motivation, and background, must be considered in math course selection, it is suggested that these be considered in addition to rather than in lieu of DAT scores. The research conducted in this study indicates that, of all test scores available to Winnipeg educators, DAT scores, specifically VR + NA, SR, and NA, contribute most to prediction of success in math and thus aid math course selection.

## CHAPTER I

### INTRODUCTION TO THE STUDY

#### Background and Purpose of the Study

The Differential Aptitude Test (DAT) was administered to all grade nine students in Winnipeg School Division #1 from 1963 to 1972. In 1972, when the school division discontinued the position of a Guidance Coordinator, individual school counsellors were suddenly faced with having to decide whether or not to continue administration of the DAT to their junior-high students. A few counsellors decided not to administer it. Their reasons given usually consisted of statements beginning with, "I think." Opposing arguments in favour of retaining the DAT were often equally unscientific and also began with, "I think." This type of reasoning, of course, left the issue unresolved. Those who favoured the use of the DAT and who argued with, "Researchers state . . . ," were countered with, "But now . . . ," or, "But here . . . ," leaving the issue still unresolved.

If the DAT is not a useful tool in helping students to choose courses, mathematics in particular, then many counsellors are wasting a great deal of time. For instance, counsellors at Sisler High School, the locale of this study, not only spend several class periods explaining the use and relevancy of the DAT, and several class periods interpreting the DAT generally, but they also spend approximately 20 minutes with each student interpreting scores and discussing

course selection for the following year. If, on the other hand, the DAT is a useful tool, what a great disservice is being done to students who are not given the opportunity to benefit from such scores when choosing their courses.

During numerous debates on usefulness of test scores, the author has expressed the "thought" that DAT scores, in particular those from Numerical Ability and Space Relations subtests, are useful as a predictor of level of success in various mathematics courses and therefore as an aid in mathematics course selection. Opponents in the continuing debate counter with the "thought" that they are not useful. This type of debate might best be settled by objective analysis. The author proposes in this study to determine the extent to which various DAT subtest scores, as well as scores from three additional tests: Dominion, Henmon-Nelson, and Otis, predict mathematics marks of grade ten students at Sisler High School.

#### Problems in Course Selection

A grade nine student faces the problem of choosing, wisely, a grade ten mathematics course which is most appropriate to his needs and abilities. However, three main factors contributing to the problem are flexibility, standards, and policy regarding failure.

#### Flexibility

Flexibility, a recent characteristic of most high schools, offers many advantages to students. Because of flexibility, however, students face problems in course selection which were not encountered a generation ago.

Formerly, a grade nine student's only option on entering grade

ten was whether or not to take French and/or Latin. This choice often was made by teachers without student participation in the decision. Today, students must choose from five different mathematics courses at the grade ten level. The courses are designed to provide prerequisite knowledge for a student to be eligible to continue in that program of mathematics or any easier program in grade eleven. The student cannot choose a more difficult program of mathematics in grade eleven. For example, a student with standing in grade ten Mathematics 100 may choose from the following courses listed in descending order of difficulty, Mathematics 200, 201, 202, 203, or 204. A student with standing in Mathematics 102, however, may choose only Mathematics 202, 203, or 204. One's choice of mathematics course can restrict one's choices, not only for subsequent mathematics courses, but for related courses, postsecondary programs, and, eventually, careers. It seems crucial that each student choose the best possible grade ten mathematics course. Too difficult a program might lead to failure, whereas too easy a program might lead to unnecessary future restrictions.

In an attempt to be flexible, many schools now offer as many as 114 different options for high school students. Ironically, this very flexibility has resulted in more rigid timetabling for students. Change from one program of mathematics to another, should an incorrect course choice have been made, may lead to a change of teachers for all other courses. These changes may impose an undue hardship on the student, because different teachers may use not only different methods but also different texts, perhaps with different content. Thus, the student may be considerably disadvantaged, if he were unable to make correct grade ten course choices while in grade nine.

## Standards

Many of the controls which once served to help teachers set standards have disappeared.

In the past, grade nine marks were considered good predictors of success in high school. Today, though, standards vary among areas of the city, among schools, and among teachers. The disparity of these standards has increased drastically because of a number of factors.

Uniform examinations at the grade nine level were written in Winnipeg until 1970. This practice meant that all Winnipeg students in any given course wrote the same examination and were able to compare their scores to those of others. Today, many schools do not administer uniform examinations. Others do not use examinations at all. Also, some have switched from percentage grades to letter grades, while others have switched from letter grades to "pass" or "fail" and, in some schools, passing seems to be determined by attendance or personality.

A standard curriculum once existed in Winnipeg. Concepts to be developed in each course were listed, and copies of the lists were distributed to each teacher. Today, a curriculum guide exists, but is set forth only as a guideline to be interpreted to the letter or loosely, or to be totally ignored. Whereas experienced teachers may appreciate the freedom to develop their courses, new teachers may find that the lack of standards in course content is confusing.

Various "schools of thought" regarding aims of education have led junior high schools to set varying standards. One school may state that, to pass grade nine, the student has to master specific



concepts which are prerequisite for grade ten programs. Another school may favour community involvement to such an extent that it freely admits to having "passed" grade nine students who, on a standardized test, functioned at a grade five or six level. Both may send their students to the same high school.

The confusion over standards among schools may also be increased by the continual emergence of new programs in Winnipeg schools. For example, at Sisler High School, a grade nine student in level Beta Four<sup>1</sup> with a mathematics mark of "A" would probably be capable of doing the same level of mathematics as a grade nine student in level Alpha One<sup>2</sup> with a mathematics mark of "E". As a counsellor at Sisler, the author is cognizant of these standards and their implications, but would counsellors from other schools assess accurately the mathematics ability and knowledge of students transferring from Sisler to their schools?

The problem of different standards is magnified by the fact that society as a whole has become extremely mobile. Because moving from one school to another may mean changing from one set of standards to another, a student's marks may not provide a good basis for course selection at the new school.

Parental advice on course selection is often not forthcoming because parents find today's high schools so drastically different from those they attended. The judgement of the parents who do try to contribute may be biased by the standards underlying the marks the student has been given in the past.

School Inspectors were discontinued in Winnipeg as of 1970. Previous to that date, teams of these qualified, experienced educators

travelled from school to school evaluating the educational process and helping teachers to maintain specific and consistent standards. Principals and teachers were able to learn how their standards compared with those of other Winnipeg schools. In contrast, at present teachers and their standards are evaluated by a principal (who may or may not have any training or competency in particular subject areas), by co-workers (who may or may not be aware of what is happening in other schools), by students (who may merely be rating personality), or by some other method. The choice of evaluative method is that of each individual school.

A reorganization of the school division into areas in 1975 meant that teachers had less opportunity to meet and compare standards with those still in the same division but who now worked in other areas.

The aforementioned changes have made it very difficult, if not impossible, for some students to judge their abilities and knowledge in particular subject areas. As a result, it is increasingly difficult for students, teachers, or counsellors to assess student competency in mathematics, and then make wise choices of grade ten mathematics courses.

#### Policy Regarding Failure

School board policy in Winnipeg has been "against failing." Perhaps this means that students will be taught for mastery, that is, students would master each concept in a course before going on to the next. Although individual students might take different lengths of time to complete courses, or grades, all would master subject material and eventually "pass." Unfortunately, the result of this policy has not been universal teaching for mastery. The practice often followed is that all students proceed from one concept, chapter, grade, and

school to the next at the same time, whether they completed the prerequisite work or not. In other words, by refusing to retain students, educators may be guaranteeing future failure for some. Students are "passed" into courses for which they may not have the basic skills, because educators have not insisted that they first master the basic prerequisites.

Because of this policy and its ramifications, such as the trend away from Special Education classes, mathematics teachers have had to develop new courses for grade ten students who could not cope with existing programs. However, these courses benefit students only if they correctly choose them. Unfortunately, some students lacking basic skills were always "passed" in mathematics and, based on this assessment, sometimes the only information they had received on their mathematical ability from educators, they tend to overestimate their ability and knowledge. They may choose the most difficult of the grade ten mathematics courses. Although students have the freedom to change courses, the change may come too late. They may be transferring to courses which they could have handled, had they been in them from the beginning of the course. Starting a month or two behind other students in the course may lead to failure. The time factor is considerably more important in a semestered school.

#### Significance of the Study

Students face ever increasing difficulties in mathematics course selection. Factors such as interests, motivation, past performance, and goals should all be considered, but the aptitude of the student for mathematics is a factor which must be taken into account, although this is often an unknown factor, more so today than ever before.

Some counsellors who do use the DAT as an aid in mathematics course selection do so intuitively, simply by "eyeballing" DAT scores and making educated guesses. This, however, is a most difficult skill to pass on to others.

Tools are needed to help students make their choices easily and wisely. The DAT is therefore being proposed and investigated in this study as such a tool. Because many Winnipeg counsellors now have the responsibility for deciding whether or not to use the DAT, this study could have significance to them. It could also have significance for counsellors outside of Winnipeg, to students, to parents, and to educators generally.

## CHAPTER II

### REVIEW OF RELATED LITERATURE

#### The Use of Standardized Tests in Educational Prediction

Current literature (Bedal, 1976; Mussio, 1976) indicates that, unless the public drastically changes its mind about standards and accountability, educators will undoubtedly be seeing more tests of one kind or another in schools. Along with the tests, educators will be facing the problems inherent in any testing program.

#### Criticisms Concerning Test Development

Some criticisms aimed at standardized tests have been concerned with test development and are specific to each particular test. General criticisms in this area concern reliability, validity, norms, and revisions. An unreliable test gives inconsistent results. An invalid test does not measure what the test purports to measure. The norms may or may not be relevant to the person being tested. A revision may or may not be equivalent to the original in those areas assumed to be equivalent.

#### Criticisms Concerning Test Administration

Other criticisms aimed at standardized tests have been concerned with the administration of the tests. Variables which have come under attack are competence of examiners, timing, clarity of directions, physical setting, guessing, pretest orientation, machine accuracy, and format of answer sheets.

The competence of the examiners may vary significantly. An examiner unfamiliar with testing or instructions for a particular test may inadvertently invalidate the results. Obviously, inaccurate timing, unclear directions, or lack of direction regarding guessing may distort the results of any test.

Physical setting consists of a variety of factors such as lighting, size of group, familiarity of surroundings, time of day, day of week, temperature, noise level, and physical comfort. Each of these factors, in some circumstances, has the potential to lower students' scores.

Researchers have extensively investigated the aspect of guessing. Cronbach's research (1942) indicates a tendency toward choosing the true response in true-false questions. The research of Rapaport and Berg (1955) indicates a tendency toward choosing alternatives located in a middle position with multiple choice items. These tendencies are elicited by the relatively difficult test items. Stricker's research (1965) shows that the later an item appears in a test, the more susceptible it is to these tendencies.

Information on pretest orientation is given in very few research studies. Jacobson's (1975) research stresses the importance of the pretest orientation. There is a vast difference between a student's "hearing" that a test and its results are important and relevant to him and a student's "believing" that the test and its results are important and relevant. The difference is reflected in the student's effort and corresponding score. Test anxiety has been found to correlate negatively with aptitude test scores (Grooms & Endler, 1960; Walter, Denzler, & Sarason, 1964). Perhaps a thorough pretest

orientation might reduce test anxiety.

A problem common to all machine-scored answer sheets is the lack of accuracy of the marks made by students on the answer sheets. Durost (1954) reported that it was necessary to erase or darken marks on from 10 to 50% of the student-marked answer sheets before they could be put through an IBM 805. Burack (1961) reported that when Strong Vocational Interest Blanks answer sheets were rescored by the same agency, 96% of the sheets showed change. More recent studies (Merwin, Bradley, Johnson, & John, 1965; Spencer, 1966; Weigel, Roehlke, & Poe, 1965) suggest that errors are few and those that do exist are seldom large enough to affect profile interpretation. Womer (1969) found that in a comparison between hand and machine scoring, machines made no errors, whereas the human hand made 11.

More important than the problem of machine accuracy is the problem of answer-sheet format. The Differential Aptitude Tests manual (Bennett, Seashore, & Wesman, 1966) presents different norms for the Clerical Speed and Accuracy Test for IBM 805, MRC, IBM 1230, and Digi-tek answer sheets. A study of different answer sheets available for use with the General Aptitude Test Battery showed significant differences between the different types of sheets (Bell & Hoft, 1964). Research indicates that examiners must not use an answer medium different from the one on which a test has been standardized without evidence of the comparability of norms.

#### Criticisms Concerning Use of Test Results

Most criticisms aimed at standardized tests have been concerned with how the results have been or may be used. Many people fear that test results have been or may be used: to exclude students from

something (rather than to help place students appropriately); to categorize students (rather than to improve understanding); to criticize educational attainments (rather than to aid in educational evaluation); or to analyze a student to such an extent that other information is ignored (rather than to be a part of an evaluation).

Fear that students will, by test results, be unfairly denied something is widespread. One of the most prevalent criticisms about using standardized tests is not that they will not satisfactorily predict achievement, but that they can seriously underestimate potential or intellectual ability (Baldwin, 1977).

Safran (1976) warns that "one must be careful of culturally loaded tests. They undoubtedly reflect on the achievement of a culturally different or a foreign-born individual" (p. 26). Prudence must be exercised in the interpretation of test scores and in prescriptions for instructional strategies and content so that decisions made on the basis of test results do not unfairly deny some students admittance to certain courses, programs, schools, colleges, or universities.

Labelling or "pigeon-holing" of students is an inherent danger in testing. "Too much reliance placed on the labels 'slow', 'minimal brain dysfunction', and 'retarded' can undermine treatment that helps the individual back to the normal stream" (Safran, 1976, p. 26).

To many lay persons, and unfortunately to some educators, numbers or test scores are magic symbols. To many they suggest "goodness" or "badness" whereas, in fact, they represent only a quantity of something. The counsellor requires considerable knowledge to understand the true statistical meanings of tests. Many counsellors will read a manual of directions but fail to comprehend the technical and statistical



jargon which describes the test.

Will teachers, principals, or schools be compared unfairly? To prevent unethical comparisons, standardized tests are sometimes not administered, or if administered, the results are kept from principals, teachers, and students. The result may be that educators "operate in a vacuum" with little knowledge of how other students, classes, or schools compare with theirs.

There is a concern that people will rely solely on test results to the exclusion of other pertinent information. Kerr (1976) finds a "tendency for the counsellor to become overconcerned with test results and less accepting of the student's own view points and values" (p. 34). Tests could replace clinical observation on the part of counsellors. Safran (1976) concludes that "tests should never be more than an adjunct to clinical observations of educators, counsellors, or administrators" (p. 26).

#### Need for Testing in Prediction

As Mowat (1966) explained:

Education is essentially a selective process. . . . Such selection can only be done (a) by chance or (b) by "examinations" using the term "examination" here to include oral (as well as written) examination, interviews and practical examinations of any sort. The prospective engineers, lawyers, truck-drivers, steel-workers, dentists, clerks or trombone players must be selected either (a) by drawing their names out of a hat or by some such more or less irrelevant criterion such as the colour of their hair, the length of their nose, or the size of father's bank roll, or (b) they must be selected in some more rational manner which will take account of their abilities and talents and the types of instruction available. It is evident that we have a long way to go in the search for improved means of selection; it is also evident that the search must go on and be intensified. (p. 18)

Criticisms aimed at testing are numerous. The crucial point is that, while many of these criticisms are valid, they are directed at

the misuse rather than the use of tests. The fact that tests may be criticized is not sufficient grounds to stop testing. Morris (1976) advocates that:

Updating, careful planning, and purposeful responsible instituting of a testing program could put tests to a positive use, in their proper perspective as a part (but only a part) of a counselling program. (p. 31)

In order to fulfil its educational obligation to students, a school should include a testing program as part of its counselling service. According to Holmes (1976):

If a school is genuinely to give young adults choices, then they must be provided with the grounds for making those choices wisely. Certainly they must be aware of the prejudices and traditions that characterize our society, but they must, above all, be aware of the opportunities that are available and of their own particular capabilities. (p. 8)

"The information a student receives about his interests and aptitudes must therefore be as accurate as possible, if he is to make a wise decision in planning a vocation" (Kerr, 1976, p. 34). If, as Kerr's 1976 study suggests, students are receiving poor information, albeit with good intentions, considerable and perhaps very serious damage is being done to the young people whose career decisions are being based on faulty information. "The effectiveness of vocational counselling depends largely upon the extent to which a counsellor has access to accurate information and is able to communicate it to the student" (Kerr, 1976, p. 33). "Educational and vocational guidance is concerned with predicting what will occur when individuals are exposed to different treatments" (Michael, 1969, p. 984).

#### Problems of Prediction

Various problems arise in the area of prediction which must be taken into account when evaluating literature or prediction studies.

One set of difficulties involved in the prediction of academic performance includes the poor standardization of the predictors and the fact that different predictors are often not independent of one another.

An important problem regarding the interpretation of relationships between predictors and criteria of academic performance involves the question of causality. A significant relationship between predictor and criterion does not necessarily establish that the predictor is a causal determinant of the criterion.

The assumption of linearity in prediction is a problem. Most studies assume a linear relationship without ruling out the possibility of increase, decrease, or threshold characteristics of intelligence in relation to performance at different segments of the intelligence range (Lavin, 1965, p. 38).

In most studies, correlations between predictors and criteria are computed for both sexes combined. Where correlations are computed separately, a sex difference is often found (Abelson, 1952; Boyd, 1955; Jackson, 1955; Klugh & Bierley, 1959; Scannell, 1960). Correlations tend to be higher for females than for males in differential prediction studies (Carter, 1959; Cronbach, 1949; Fredhoff, 1955; Gough, 1953; Jacobs, 1959; Nason, 1958; Travers, 1956). Of all educational levels, the highest correlations are obtained for the high school level. The college level ranks next, and the graduate level is lowest (Lavin, 1965).

#### Intelligence Tests

The most widely used intelligence test in the Winnipeg #1 School Division junior high schools (grades seven through nine) is the

Quick-Scoring Group Test of Learning Capacity: Dominion Tests - Intermediate, Form A. The Department of Educational Research, Ontario College of Education, University of Toronto, is the developer, distributor, and marking centre for the tests. As of 1976, only 22.3% of Ontario intermediate schools (grades one through eight) were administering the tests (Wahlstrom & Weinstein, 1976). Because of its limited use, there is a scarcity of research on these tests. According to Holmes (1976) it is not justifiable to exclude IQ results from a pupil placement process. Thus, a study of the predictive power of this test will be included in this investigation.

Originally called the Group Test of Learning Capacity, in 1934, the test was revised in 1950, and the norms were revised in 1952. The 1958 Quick Scoring Edition represents a change from a test booklet to a conventional multiple choice form with a separate answer sheet. The 1963 version has been shortened from 75 to 70 items.

Ferguson (1965) finds these to be "well constructed tests of a conventional kind" (p. 769). Black (1965), on the other hand, criticizes the lack of reliability data for the most recent tests, the lack of evidence of item analysis, lack of evidence regarding representativeness of norms, and the lack of instructions regarding guessing.

#### Aptitude Tests

In 1976 Price and Kim reported that, for the preceding two decades or more, many college administrators had accepted the aptitude test scores of high school students as one of the most important indicators of academic success in undergraduate education. However, this use of aptitude test scores has given rise to two important areas

of concern. The first relates to the decline of predictive validity of tests and the second involves the decline or submergence of the really brilliant scholar.

Michael and Jones (1963) and Dalton (1976) reported a decline in the predictive validity of aptitude tests. Perhaps this decline may be tied in with the lowering of standards. As the standards become lower, weak students by sheer dint of determination may succeed, and brighter students may succeed so easily that they put forth little effort. The achievement of both these groups may, therefore, be less highly correlated with their aptitudes than was the case some years ago.

As for the disappearance of scholarship, Price and Kim (1976) found the decline in aptitude test scores of college bound students for the preceding eleven years to be a strong indication that the really brilliant scholar may be an ever-diminishing community. This apparent decrease in brilliancy might be tied in with the lowering of standards. Perhaps the students capable of becoming brilliant scholars are not being sufficiently challenged to develop to their full academic potential.

It may be that both these criticisms of aptitude tests as predictors could be resolved if the standards in education were redirected upwards. Regardless of their possible lessened ability to predict, aptitude tests have provided consistently high and remarkably stable validity coefficients when used to predict academic success (Larsen & Scontrino, 1976; Ryan & French, 1976; Taylor, Brown, & Michael, 1976).

Most scholastic aptitude tests involving language and mathematics

abilities have been shown rather consistently to be related to success in academic programs (Michael, 1969, p. 985). From the various aptitude tests, Quereshi (1972) comments on the Differential Aptitude Tests' technical superiority over its competitors. Herman and Gallo (1973) recommend one instrument to administrators and counsellors attempting to help students in their selection of educational programs: the Differential Aptitude Test.

### The Differential Aptitude Test

#### An Overview

Since the time of its first publication in 1947, the Differential Aptitude Test (DAT) has been used for a great number of purposes, many of which were probably outside the realm of possibilities considered by its creators. Bennett and others (1966) constructed the DAT:

to provide an integrated, scientific and well standardized procedure for measuring the abilities of boys and girls in grades eight through twelve for purposes of educational and vocational guidance. . . . They were designed to meet the expressed needs of guidance counselors and consulting psychologists. (p. 1-1)

Studies have been made trying to connect the DAT with a number of variables. The following examples will serve to indicate the scope of the literature available on the DAT. Researchers have used the DAT, or parts thereof, with varying degrees of success to correlate with success in particular junior high, high school, vocational and university courses (Cumming, Davies, Nagle, & Thompson, 1966; Setwart, Note 1); success in employment (Seashore, 1955); level of schooling (Cheong, 1970); and alternative test scores such as Australian Council of Educational Research Form AQ (Cheong, 1970), Safram Student Interest Inventory (Nichols, 1971), Iowa Algebra Aptitude Test (Mogull &

Rosengarten, 1974), General Aptitude Test Battery (Perry, 1976), and Preadmission and Classification Examination (Miller & Schill, 1974). The DAT has been used to predict choice of, and success in, various programs in high school, vocational schools, and universities (Bennett et al., 1966; Cheong, 1970; Crosby, Fremont, & Mitzel, 1960; Kim & Kang, 1970; Nichols, 1971) and graduates versus drop outs (Cumming et al., 1966; Seashore, 1955; Urdal, Cech, Hamreus, & Workman, 1963). The DAT has been employed to evaluate methods of teaching instruction (Crosby et al., 1960), programs, such as science, mathematics, or guidance, and alternative tests and batteries of tests, and to determine acceptability of applicants to licensed practical nursing programs (Miller & Schill, 1974) and educability of students in the visualization of objects in space (Carpenter, Brinkman, & Lirones, 1965). Counsellors have used the DAT extensively to counsel students regarding their future academic and vocational success (Herman & Gallo, 1973).

#### Validity

The DAT manual was revised in 1952, 1959, and 1966 to incorporate results of an overwhelming amount of validity data, including more than 4,000 correlation coefficients. Most of the data are concerned with predictive validity in terms of high school and college achievement. The validity of the tests is based on correlations between DAT scores and scores on other tests of a similar nature and on several longitudinal follow-up studies. Validity coefficients are statistically significant. Many of the coefficients are high, even with intervals as long as three years between test and criterion data. Critics are in agreement in their praise of the test's validity.

For instance, Hanna (1974), in referring to the DAT, cites the "accumulated wealth of predictive validity findings meriting the highest praise" (p. 147).

### Reliability

Reliability coefficients for the tests, as found by its creators, range from .85 through .93 for boys and from .71 through .92 for girls. Froehlich and Hoyt (1959) concluded that a counsellor working with grade nine students can with reasonable assurance assume that their scores will be about the same when they are in grade twelve (p. 121). A seven year follow-up study on the DAT concluded that "the characteristics of high school students, measured by the DAT, bear important relations to their subsequent careers as reported almost eight years later" (Seashore, 1955, p. 14).

### Revision

The early edition of the DAT is open to various criticisms. Schutz (1965) criticized the authors for failing to come to grips with operational problems in interpreting test results, for not presenting sufficient correlations with other tests, and for not providing enough white space on each page of the Numerical Ability subtest. Keats (1965) argued that no evidence is presented to justify subtracting wrong responses in the scoring of the test. Carroll (1959) commented on the obsolete norms of English usage upon which the Language Usage subtest was based.

All of these criticisms have been resolved by subsequent revisions of the DAT. Merwin (1972) described the changes in the second edition, Forms L and M, 1962, as being desirable but leaving the two editions enough alike so that the findings of the extensive research that has



been conducted on the earlier edition will be applicable to the second edition. The revisions in the 1972 edition, Forms S and T, were rated by Hanna (1974) as superb--minor enough to enable some continued reliance on research based on earlier editions, yet substantial enough to render the content entirely contemporary.

Most authors rated the norms as being far better than those available for most tests (Humphreys, 1953) and these have been further improved in subsequent revisions by controlling for the variable of socio-economic status (Hanna, 1974).

One major criticism has survived all revisions of the DAT. From the results of his own factor analysis, Quereshi (1972) concluded:

A number of tests (e.g., VR, LU-I, and LU-II) have equally high loadings on the same factor, evidencing undue redundancy in measurement. A judicious selection (e.g., VR, NA, CSA, MR, and SR) from the current conglomerate can do the job as effectively as the whole battery. The DAT, represents a substantial degree of inessential duplication of time, effort, and expense. (p. 1052)

#### Pretest Orientation

Jacobson's (1975) research stressed the importance of the pretest orientation, emphasizing the relevance of the orientation to "encourage students to do their best on the test and also to make sure they understand the purpose and individual benefit to them by taking the test" (p. 17). The DAT manual does instruct examiners as follows, "Try to put the students at ease by explaining briefly why the tests are being administered. This may be done a day or so in advance" (Bennett et al., 1966, p. 2-5). While the orientation is suggested by the DAT manual, it may not have been sufficiently stressed. The presence, absence, or depth of such an orientation could have a marked influence on the resulting DAT scores. Few

researchers have explained the details of the orientation relating to the DAT scores used in their research.

#### The DAT Versus High School Performance as a Predictor

The results of Anderson's (1971) study indicated that high school performance was a better predictor of academic success in vocational programs in health careers than any score obtained from the DAT for the sample that was used. Similarly, research of Mogull and Rosen-garten (1974) demonstrated a preference for grade eight mathematics averages over the DAT for predicting success in grade nine Elementary Algebra. These findings are consistent with those of Malone (1966) that high school performance was the most valid predictor of success in post high vocational education programs in Iowa, and with Lunne-borg and Lunneborg (1969) who found high school grade-point average in a sample of 2800 students to be as good a predictor of vocational courses as of traditional university courses. Travers (1956) and Garrett (1949), in reviewing studies of student achievement at an earlier date, also concluded that the best single predictor of general academic success in college is the student's high school grade-point average.

Herman and Gallo (1973) point out that, although standings in grade nine and grade twelve matriculation exams once had high pre-dictive validity for post-secondary education, this may no longer be the case today:

Since courses in Grade IX may now differ significantly in content and educational experience from one school to another, administrators and counselors have to attempt to help students in their selection processes of educational programs without the aid of validated predictive measures. Therefore instruments given to Grade IX students, other than the Grade IX Examinations, could well be used for

predictive purposes. One such instrument that appears to fulfill these purposes is the Differential Aptitude Test. (p. 233)

#### Value of the DAT

The lack of usefulness sometimes attributed to the DAT should perhaps be attributed to certain studies of the DAT and the misuse of the DAT rather than to the DAT itself. Most reviewers and researchers do indeed credit the DAT with great usefulness.

In 1951, the authors received recognition from the Council of Guidance and Personnel Associations for the superior job they had done in presenting information about the tests. Berdie (1953) commented that "this is unquestionably the best test manual published" (p. 679). The manual was described by Carroll (1959) as "a model of organization, comprehensiveness and clarity" (p. 672), and by Frederiksen (1959) as a "model which other publishers might well emulate" (p. 676).

Herman and Gallo (1973) found that the DAT battery, with the exception of the Clerical Speed and Accuracy subtest, had good predictive validity in terms of high school achievement. Perry (1976) stated:

Membership in postsecondary vocational training program groups is significantly related to DAT scores obtained as early as the 8th through 10th grades . . . the relationships are very much the same as those found for GATB scores obtained at the end of 12th grade or later. (pp. 107-108)

Bechtoldt (1953) recommended the DAT "to vocational counsellors for use in educational guidance or educational research programs" (p. 678). Results from research of Herman and Gallo (1973) also indicated that the "DAT has good predictive power and can be used effectively on a

selective basis for counselling and predictive purposes in high school" (p. 232).

Carroll's (1959) conclusion perhaps sums up the findings of a great number of reviewers and researchers when he stated:

The DAT constitutes the best available foundation battery for measuring the chief intellectual abilities and learned skills which one needs to take account of in high school counselling. (p. 605)

Many studies have been conducted (usually at the university level) using the DAT to predict success in academic courses. However, nowhere in the literature has the author been able to locate evidence of studies utilizing the DAT as an aid in mathematics course selection at the grade ten level. Because of changes in education, such an aid is now needed.

## CHAPTER III

### METHOD

This chapter presents the methodology used in this study. Details are given concerning the problem, definition of terms, data-gathering procedure, samples, instrumentation, hypotheses (both research and null test), and statistical analyses in order to promote a clear understanding of the procedure.

#### The Problem

The main purpose of the study was to investigate the relative contribution of scores on various tests, given to students before grade ten, to prediction of success in grade ten mathematics courses. Specifically, the predictive power of scores on the following tests was investigated: DAT Verbal Reasoning (VR), DAT Numerical Ability (NA), DAT combined Verbal Reasoning and Numerical Ability (VR + NA), DAT Space Relations (SR), DAT Abstract Reasoning (AR), Quick-Scoring Group Tests of Learning Capacity: Dominion Tests, Intermediate, Form A (DOM), Henmon-Nelson Tests of Mental Ability (HN), and Otis Quick-Scoring Mental Ability Tests (OTIS). Also, the difference in predictability of math marks for males and females was investigated.

#### Definition of Terms

The following definitions are reported in order to help the reader comprehend possibly confusing terms related to this investigation.

Math 100: Previously known as University Entrance Math, this course deals primarily with geometry.

Math 101: Previously known as General Math, this course deals primarily with algebra.

Math 102: Also known as Business Math, this course deals primarily with problems involving fractions, decimals, and percent and contains neither algebra nor geometry.

Math 104<sup>3</sup>: This course is not the Occupational Entrance Math 104, but refers specifically to a course developed by W. Korytowski and J. Pascoe, teachers at Sisler High School, for those students who "try" very hard but do not have the basic skills needed to cope with existing mathematics programs. Rather than being cumulative, the content deals lightly with a variety of topics.

Cumulative examination mark: Mathematics students in either Math 100 or 101 write cumulative examinations, one before each reporting period, counting for 40% of that term's mark. Regardless of teacher, all students in a given mathematics program write an identical examination set by one of the mathematics teachers and reviewed or revised by the other mathematics teachers. The cumulative examination mark referred to in this study is based on the June examination which covers the year's work. All mathematics teachers meet prior to marking examinations to determine how to mark each question uniformly. All marks are reported as percentage scores.

Final math mark: Students' marks for the three terms are averaged to determine the final mark for the year. All marks are reported as percentage scores.

Math mark: For the sake of simplicity, math mark in this study is the cumulative examination mark for students in Math 100 and 101 and the final mark for students in Math 102 and 104. Because one teacher taught all 104 students and another teacher taught all 102 students, it was felt that these final marks would not be affected by differences between individual teachers as might the final marks of students in Math 100 and 101 where four different teachers were involved.

Success in mathematics: The student's success in mathematics is defined as his math mark. A student with a mark of 75 would, by definition, be more successful than a student with a mark of 70. A student with a mark lower than 50 or a withdrawal, by definition, would be unsuccessful.

Aptitude: The term aptitude is used synonymously with the terms ability, intelligence, and mental ability. Aptitude is defined by Bingham (cited in Bennett, Seashore, and Wesman, 1966) as "a condition or set of characteristics regarded as symptomatic of an individual's ability to acquire, with training some (usually specified) knowledge, skill, or set of responses (p. 1-2)."

#### Data Gathering Procedure

Math marks for students in Math 100 and 101 were obtained from original mark sheets or photostats submitted by all teachers teaching Math 100 or 101 as of June 1977 or 1978 (see Appendix A for mathematics examinations). Math marks for students in Math 102 and 104 were obtained from cardex cards which serve as official school records. These cardex cards were also the source of information for scores on the DAT, Dominion, Henmon-Nelson, and Otis tests. The

sex of the student was noted from each student's cardex. The math marks and other data were obtained in June through November of 1977 and 1978 (see Appendix B for raw data).

### Samples

Sisler High School is a grade-seven-through-twelve school which averages 1200 students per year. Students reside in a middle- to lower-class area located in what is referred to as "core" or inner-city Winnipeg. The original sample consisted of 483 Sisler students who, in June 1977 or 1978, were enrolled in Math 100, 101, 102, or 104. The sample was further restricted to 460 students who completed their mathematics program in June. Students who had transferred from one mathematics course to another during the year were removed from the sample because of the effect their late entry into the program might have had on their math marks, lowering the sample to 438. Of this number, only those students for whom scores were available on the following tests were included, lowering the sample as indicated by numbers in parentheses: DAT (349), DOM (307), HN (272), and OTIS (262). This first sample, designated I, consisting of 262 students (135 Math 100 students, 87 Math 101 students, 35 Math 102 students, and 5 Math 104 students) was used for the first stage of the study. Sample I data was used as a screening device to reduce the number of variables to be considered in the prediction of math marks.

A second sample, designated II, was formed by using those Sisler students for whom scores were available on those variables found to contribute significantly ( $p < .05$ ) to prediction of math marks in the Sample I procedure. If no variable in the Sample I procedure were found to contribute significantly, then the variable with the



highest correlation to math mark was chosen for Sample II. The level of significance specified was .05, instead of .01, because of the small sizes of Sample I subgroups; because of the large number of variables considered in Sample I; and because of the inclusion of the composite score, VR + NA, as well as both individual scores, VR and NA, in the variable list. Both composite and individual scores were included because it was not known in advance which would contribute more to prediction of math mark. Because of the overlap, the significance of one of these variables might be underestimated by multiple regression analyses of Sample I data. Sample II data would not likely include both composite and individual scores and would, therefore, present a more accurate analysis. Sample II would hopefully be large enough so that it might be further subdivided into large subgroups for investigating the predictability of math marks of males and of females and would, by correlation with fewer variables, reduce the effect of the "regression law of diminishing returns" (Kerlinger, 1973, p. 625).

The ranges of Math 100 and 101 marks used in Sample II were unusually narrow because of the method of determining standing at Sisler High School. Because marks for the three terms in the school year were averaged, some students found themselves in the position of needing an extremely high mark in the third term to compensate for low first- and second-term marks. Many of these students unrealistically assumed that they could double their marks in the final term. By June, many realized that it was improbable to attain a sufficiently high mark so they withdrew prior to the examinations. Thus they excluded themselves from inclusion in Sample II. Sample II, therefore, is lacking many marks which would have been lower

than 50, had the students written the examinations. At the opposite end of the scale, students who had marks above 75 in both first and second term were already guaranteed a "pass" in that course, regardless of their third term mark. Some students may have taken advantage of this fact and spent less time and effort on mathematics in order to concentrate on raising their averages in other courses. Thus, students capable of achieving higher final math marks may not have done so.

A Sample III therefore was created, which consisted of those students who withdrew from a mathematics course. They were included in this study so as to show a more complete picture of student data and to provide information for charts but not for multiple regression analyses.

### Instrumentation

#### Differential Aptitude Tests

Differential Aptitude Tests, Form S, by G. K. Bennett,

H. G. Seashore, and A. G. Wesman, are:

an integrated battery of aptitude tests designed for educational and vocational guidance in junior and senior high schools. The battery yields nine reliable scores including an index of scholastic ability. The Differential Aptitude Tests provide a profile of the relative strengths and weaknesses of each student in these eight abilities: verbal reasoning, numerical ability, abstract reasoning, space relations, mechanical reasoning, clerical speed and accuracy, spelling and language usage. The ninth score, an index of scholastic ability, is obtained by summing the verbal reasoning and numerical ability scores.

(Tests & Instructional Aids, 1976, p. 14)

Sisler High grade nine students were given a DAT pretest orientation lasting approximately two hours. The test was administered to all grade nine students, simultaneously, in the school lunchroom, one

afternoon and the following morning in October. Grade percentile range scores, based on norms for the entire Winnipeg School Division, were used in this study.

#### Dominion Tests

Quick-scoring Group Test of Learning Capacity: Dominion Tests, Intermediate, Form A, by the Ontario Institute for Studies in Education consists of 70 questions without internal timing. This thirty minute test is in a conventional multiple choice form with a separate answer sheet. Constructed for grades seven, eight, and nine, this test appears in two parallel forms, A and B. "It comprises opposites, analogies, number series, arithmetic problems, 'does not belong', synonyms and a few of miscellaneous type" (Emmett, 1953, p. 395). The tests were administered to students while in grade seven. Grade percentile range scores, based on norms for the entire Winnipeg School Division, were used in this study.

#### Henmon-Nelson Tests

Henmon-Nelson Tests of Mental Ability, Form A, by V. A. C. Henmon and M. J. Nelson, and revised by T. A. Lamke and M. J. Nelson, are:

designed to measure those aspects of mental ability which are important for success in academic work and in similar endeavors outside the classroom. Each form consists of 90 test items arranged in order of increasing difficulty. A variety of items is used to test different manifestations of mental ability. (Lamke & Nelson, 1957, p. 3)

The tests were administered to students while in grade five. IQ scores, based on norms for the entire Winnipeg School Division, were used in this study.

#### Otis Tests

Otis Quick Scoring Mental Ability Tests, Alpha, Short Form, by A. S. Otis are:

a widely used measure of general mental ability. It provides for the assessment of general mental ability, or scholastic aptitude, by sampling a broad range of cognitive abilities. (Tests & Instructional Aids, 1976, p. 19)

The tests were administered to students while in grade three. IQ scores, based on norms for the entire Winnipeg School Division, were used in this study.

#### Mathematics Examinations

Math 100 and 101 examination questions for both the 1977 and 1978 school years are located in Appendix A.

#### Research Hypotheses

Two research hypotheses directed this investigation:

1) Knowledge of scores on VR, NA, VR + NA, SR, AR, DOM, HN, and OTIS contributes to prediction of grade ten marks in Math 100, 101, 102, and 104. The multiple correlation coefficient between math mark ( $\underline{Y}$ ) and the eight variables is not equal to zero (See Table 1 for author's expectations).

$$H_1: R_{\underline{y}.12345678} \neq 0$$

2) Knowledge of scores on those variables found to be significant ( $p < .05$ ) for Sample I contributes to prediction of grade ten marks in Math 100, 101, 102, and 104. The multiple correlation coefficient between math mark ( $\underline{Y}$ ) and the  $\underline{n}$  variables is not equal to zero.

$$H_2: R_{\underline{y}.1-n} \neq 0$$

Hypothesis two was tested for males only, females only, and mixed (males and females).

#### Null Test Hypotheses

Two null test hypotheses gave direction to statistical analyses:

Table 1  
 Expectations of Sample I Variables'  
 Contribution to Prediction of Math Marks

	Math 100	Math 101	Math 102	Math 104
	<u>n</u> = 135	<u>n</u> = 87	<u>n</u> = 35	<u>n</u> = 5
Expected	1) NA	1) NA	1) NA	1) NA
Significance	2) SR			
*****				
Possible	VR + NA	VR + NA	VR + NA	VR + NA
Significance	AR	AR	AR	AR
-----				
Expected	VR	SR	SR	SR
Non-significance	DOM	VR	VR	VR
	OTIS	DOM	DOM	DOM
	HN	OTIS	OTIS	OTIS
		HN	HN	HN

Note. Order of contribution to prediction of math mark is not specified for variables listed below starred line (\*\*\*\*\*). Variables listed below dotted line (-----) are not expected to contribute significantly\* to prediction of math mark.

\*p < .01

1) The multiple correlation coefficient between math mark and scores on the variables VR, NA, VR + NA, SR, AR, DOM, HN, and OTIS equals zero.

$$H_{01}: R_y \cdot 12345678 = 0 \quad \alpha = .01$$

2) The multiple correlation coefficient between math mark and either scores on the variables found to be significant in Sample I ( $p < .05$ ) or scores on the variable with highest correlation to math mark equals zero.

$$H_{02}: R_y \cdot 1-n = 0 \quad \alpha = .01$$

#### Statistical Analyses

Each sample,  $n_1 = 262$ ,  $n_2 = n$  (determined by analysis of data), was divided into four subgroups according to math course. Statistical analyses were performed separately for each subgroup. Sample II was further studied with males only, females only, and mixed (males and females). The subgroup, Math 104, was eliminated because only 5 students were enrolled. The small number precluded appropriate analyses (Kerlinger, 1973, p. 619). Data for each subgroup (see Appendix B for raw data) were subjected to a stepwise forward inclusive multiple regression analysis (Nie, Hull, Jenkins, Steinbrenner, & Bent, 1975, p. 180) with the variables: VR, NA, VR + NA, SR, AR, DOM, HN, and OTIS, and criterion math mark. All variables were allowed to enter the regression equation freely, a standard regression method (Nie et al., 1975, p. 336).

The parameter values of  $\underline{n}$  (the maximum number of variables that will be permitted to enter the regression equation),  $\underline{F}$  (the  $\underline{F}$  ratio associated with a given variable that would be obtained in order for that variable to be allowed into the regression equation on

the next step), and  $t$  (the tolerance of an independent variable being considered for inclusion representing the proportion of the shared variance of that variable and the criterion variable, math mark, not explained by the independent variables already in the regression equation) were not specified by the author, but rather, default values were automatically set by the computer. The default value of  $n$  equaled 80, permitting all variables to be entered into the regression equation, provided that they met the other criteria. The default value of  $F$  equaled .01. The default value of  $t$  equaled .001. The above default values were extremely permissive. These permissive values were initially used so that the computer could print out data showing the relative contribution of variables.

In addition to the specified multiple regression, the computer was programmed to output residuals,  $\hat{Y}$ ' values (the math scores that would be predicted from the multiple regression equation and variable values), correlation matrices, means, and standard deviations for each variable.

The linear regression model requires that the data be ordered so that the underlying assumption of linearity be met. The data were presented in the form of a scatter diagram (see Figure 1). A visual examination revealed that the assumption was met. Thus, the researcher proceeded with the presentation of results. The next chapter contains a presentation of results of this investigation.

Figure 1

Computer Printout Plot for Math 101, Mixed, Sample II of  
 Standardized Residual (down) and Predicted Math Mark (across)

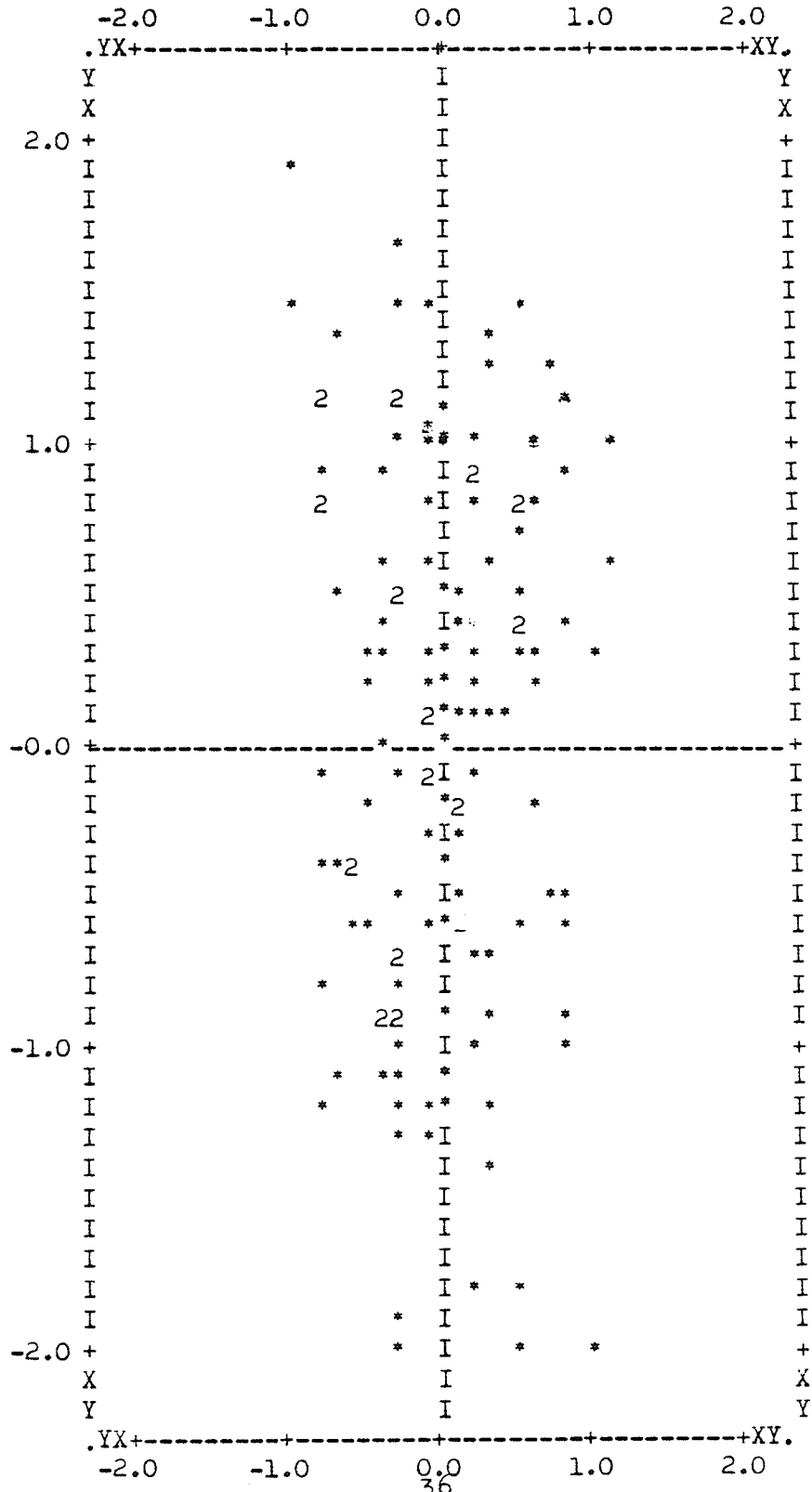



## CHAPTER IV

### RESULTS

The previous chapter described methods to be used in this predictive study. In this chapter the results of that methodology are presented, first for Sample I and then for Sample II. For both samples, results are organized around subgroups representing Math 100, 101, and 102 courses.

#### Sample I

##### Math 100

The multiple correlation coefficient between Math 100 marks achieved by 135 students and their scores on VR + NA, SR, VR, NA, OTIS, and DOM was .638,  $F(7, 127) = 12.422$ ,  $p < .001$ . The following multiple regression equation was derived to predict Math 100 marks:

$$\begin{aligned} \underline{y}' = & 23.536 + .885 (VR + NA) + .162 (SR) + -.371 (VR) + .150 (HN) \\ & + -.188 (NA) + -.072 (OTIS) + .039 (DOM) \end{aligned} \quad (1)$$

All equations in this chapter are numbered 1 through 12. The standard error of the estimate for each equation is listed in Table 2. The correlation matrix for these variables and Math 100 mark is shown in Table 3. Table 4 summarizes the findings by presenting regression coefficients, beta coefficients, corresponding  $F$  values, and other pertinent statistics. Because VR + NA and SR were the only two variables found to be significant ( $p < .05$ ), these were the only variables utilized with Sample II Math 100 data.

Table 2  
Standard Errors of the Estimate  
For Equations Predicting Mathematics Marks

---

1)	11.725
2)	17.212
3)	12.695
4)	11.872
5)	12.232
6)	11.174
7)	17.316
8)	17.500
9)	16.497
10)	11.401
11)	11.575
12)	11.529

---

Note. The numeral preceding each standard error corresponds to the numeral following each equation listed in the text.

Table 3

Correlation Matrix for Test Scores and Math 100 Mark, Sample I

	NA	SR	DOM	OTIS	HN	VR	VR + NA	AR	Math Mark
NA	1.000	.287	.417	.242	.393	.563	.836	.342	.500
SR	.287	1.000	.364	.366	.235	.406	.397	.463	.443
DOM	.417	.364	1.000	.347	.516	.636	.604	.370	.398
OTIS	.242	.366	.347	1.000	.456	.437	.406	.457	.252
HN	.393	.235	.516	.456	1.000	.514	.503	.292	.332
VR	.563	.406	.636	.437	.514	1.000	.905	.458	.486
VR + NA	.836	.397	.604	.406	.503	.905	1.000	.447	.574
AR	.342	.463	.370	.457	.292	.458	.447	1.000	.306
Math Mark	.500	.443	.398	.252	.332	.486	.574	.306	1.000

Table 4  
 Summary of the Multiple Regression Analysis of Test Scores  
 and Math 100 Marks, Sample I

Variable	Multiple <u>R</u>	<u>R</u> <sup>2</sup>	<u>R</u> <sup>2</sup> Change	Simple <u>R</u>	<u>B</u>	Beta	<u>F</u>	<u>df</u>
VR + NA	.574	.330	.330	.574	.885	1.069	6.058*	1, 126
SR	.620	.384	.055	.443	.162	.275	12.407***	1, 126
VR	.629	.396	.011	.486	-.371	-.517	3.092	1, 126
HN	.632	.399	.003	.332	.150	.082	.865	1, 126
NA	.635	.403	.004	.500	.188	-.221	.962	1, 126
OTIS	.636	.405	.002	.252	-.072	-.058	.495	1, 126
DOM	.638	.406	.001	.398	.039	.051	.296	1, 126
(Constant)					23.536			

\*p < .05

\*\*\*p < .001

The multiple correlation coefficient between Math 101 marks achieved by 87 students and their scores on NA, SR, DOM, VR + NA, HN, OTIS, AR, and VR was .570,  $F(8, 78) = 4.684$ ,  $p < .001$ . The following multiple regression equation was derived to predict Math 101 marks.

$$\begin{aligned} \underline{Y}' = & 15.393 + .509 (NA) + .162 (SR) + .200 (DOM) + -.372 (VR + NA) \\ & + .169 (HN) + -.093 (OTIS) + .039 (AR) + .051 (VR) \end{aligned} \quad (2)$$

The correlation matrix for these variables and Math 101 mark is shown in Table 5. Table 6 summarizes the findings by presenting regression coefficients, beta coefficients, corresponding  $F$  values, and other pertinent statistics. Because NA was the only variable found to be significant ( $p < .05$ ), this was the only variable utilized with Sample II Math 101 data.

Math 102

The multiple correlation coefficient between Math 102 marks achieved by 35 students and their scores on NA, HN, AR, DOM, and OTIS was .614,  $F(5, 29) = 3.511$ ,  $p < .05$ . The following multiple regression equation was derived to predict Math 102 marks.

$$\begin{aligned} \underline{Y}' = & 3.635 + .247 (NA) + .563 (HN) + .178 (AR) + -.080 (DOM) \\ & + -.148 (OTIS) \end{aligned} \quad (3)$$

The correlation matrix for these variables and Math 102 mark is shown in Table 7. Table 8 summarizes the findings by presenting regression coefficients, beta coefficients, corresponding  $F$  values, and other pertinent statistics. No variables were found to be significant ( $p < .05$ ). Because the score on variable NA correlated most highly with Math 102 mark, it was the only variable utilized with Sample II Math 102 data.

Table 5

Correlation Matrix for Test Scores and Math 101 Marks, Sample I

	NA	SR	DOM	OTIS	HN	VR	VR + NA	AR	Math Mark
NA	1.000	.244	.407	.357	.371	.166	.693	.416	.495
SR	.244	1.000	.321	.236	-.100	.347	.344	.544	.308
DOM	.407	.321	1.000	.516	.446	.567	.666	.409	.353
OTIS	.357	.236	.516	1.000	.366	.407	.505	.386	.209
HN	.371	-.100	.446	.366	1.000	.256	.445	.234	.226
VR	.166	.347	.567	.407	.256	1.000	.786	.446	.099
VR + NA	.693	.344	.666	.505	.445	.786	1.000	.549	.342
AR	.416	.544	.409	.386	.234	.446	.549	1.000	.310
Math Mark	.495	.308	.353	.209	.226	.099	.342	.310	1.000



Table 6  
 Summary of the Multiple Regression Analysis of Test Scores  
 and Math 101 Marks, Sample I

Variable	Multiple <u>R</u>	<u>R</u> <sup>2</sup>	<u>R</u> <sup>2</sup> Change	Simple <u>R</u>	<u>B</u>	Beta	<u>F</u>	<u>df</u>
NA	.495	.245	.245	.495	.509	.547	4.605*	1, 78
SR	.531	.282	.037	.308	.162	.194	2.508	1, 78
DOM	.545	.297	.015	.353	.200	.235	2.991	1, 78
VR + NA	.564	.318	.021	.342	-.372	-.338	.659	1, 78
HN	.567	.322	.004	.226	.169	.082	.493	1, 78
OTIS	.568	.323	.001	.209	-.093	-.052	.205	1, 78
AR	.569	.324	.001	.310	.039	.043	.115	1, 78
VR	.570	.325	.000	.099	.051	.055	.033	1, 78
(Constant)					15.393			

\*p < .05

Table 7

Correlation Matrix for Test Scores and Math 102 Marks, Sample I

	NA	SR	DOM	OTIS	HN	VR	VR + NA	AR	Math Mark
NA	1.000	.526	.470	.187	.449	.463	.777	.628	.549
SR	.526	1.000	.400	.324	.527	.547	.637	.537	.399
DOM	.470	.400	1.000	.558	.642	.742	.746	.482	.311
OTIS	.187	.324	.558	1.000	.712	.466	.408	.538	.257
HN	.449	.527	.642	.712	1.000	.644	.652	.399	.443
VR	.463	.547	.742	.466	.644	1.000	.907	.443	.344
VR + NA	.777	.637	.746	.408	.652	.907	1.000	.589	.487
AR	.628	.537	.482	.538	.399	.443	.589	1.000	.458
Math Mark	.549	.399	.311	.257	.443	.344	.487	.458	1.000



Table 8  
 Summary of the Multiple Regression Analysis of Test Scores  
 and Math 102 Marks, Sample I

Variable	Multiple <u>R</u>	<u>R</u> <sup>2</sup>	<u>R</u> <sup>2</sup> Change	Simple <u>R</u>	<u>B</u>	Beta	<u>F</u>	<u>df</u>
NA	.549	.302	.302	.549	.247	.305	1.617	1, 29
HN	.592	.350	.048	.443	.563	.384	2.100	1, 29
AR	.602	.362	.012	.458	.178	.245	1.002	1, 29
DOM	.610	.372	.010	.311	-.080	.120	.340	1, 29
OTIS	.614	.377	.005	.257	-.148	.138	.250	1, 29
(Constant)					3.635			

Note. No F values were found to be significant (p < .05).

### Sample II

Sample II consisted of those 344 students for whom the appropriate test scores, identified by results of statistical analyses of Sample I data, were available. Sample II subgroups consisted of 162 Math 100 students, 132 Math 101 students, and 50 Math 102 students.

#### Math 100

The multiple correlation coefficients between Math 100 mark and scores on VR + NA and SR, by multiple regression analyses, were: .616,  $F(2, 159) = 48.670$ ,  $p < .001$ , for mixed (males and females); .585,  $F(2, 76) = 19.749$ ,  $p < .001$ , for females only; and .674,  $F(2, 80) = 33.351$ ,  $p < .001$ , for males only. The following multiple regression equations were derived to predict Math 100 marks:

$$\underline{Y}' = 33.238 + .394 (VR + NA) + .150 (SR) \quad (\text{mixed}) \quad (4)$$

$$\underline{Y}' = 29.943 + .365 (VR + NA) + .195 (SR) \quad (\text{females only}) \quad (5)$$

$$\underline{Y}' = 34.755 + .417 (VR + NA) + .137 (SR) \quad (\text{males only}) \quad (6)$$

The correlation matrices for these variables and Math 100 marks are shown in Table 9. Table 10 summarizes the findings by presenting regression coefficients, beta coefficients, corresponding  $F$  values, and other pertinent statistics.

The significance of the difference between correlation coefficients for males and for females was tested by using Fisher's  $z_r$  transformation (see Table D).  $z$  was found to equal .930, which was not significant at the .05 level.

#### Math 101

The correlation coefficients between Math 101 mark and NA were:

Table 9

Correlation Matrix for SR, VR + NA, and Math 100 Mark, Sample II  
 (Computed for Mixed, Female, and Male Samples)

	SR	VR + NA	Math Mark
SR			
Mixed	1.000	.382	.434
Female	1.000	.262	.418
Male	1.000	.479	.494
VR + NA			
Mixed	.382	1.000	.570
Female	.262	1.000	.504
Male	.479	1.000	.639
Math Mark			
Mixed	.434	.570	1.000
Female	.418	.504	1.000
Male	.494	.639	1.000

Table 10  
 Summary of the Multiple Regression Analysis of  
 VR + NA, SR, and Math 100 Mark, Sample II  
 (Computed for Mixed, Female, and Male Samples)

Variable	Multiple <u>R</u>	<u>R</u> <sup>2</sup>	<u>R</u> <sup>2</sup> Change	Simple <u>R</u>	<u>B</u>	Beta	<u>F</u>	<u>df</u>
VR + NA								
Mixed	.570	.325	.325	.570	.394	.473	49.050***	1, 159
Female	.504	.254	.254	.504	.365	.424	19.316***	1, 76
Male	.639	.409	.409	.639	.417	.523	30.869***	1, 80
SR								
Mixed	.616	.380	.055	.434	.150	.253	14.018***	1, 159
Female	.585	.342	.088	.418	.195	.307	10.124**	1, 76
Male	.674	.455	.046	.494	.137	.244	6.728*	1, 80
(Constant)								
Mixed					33.238			
Female					29.943			
Male					34.755			

\*  
p < .05  
 \*\*  
p < .01  
 \*\*\*  
p < .001

.473,  $F(1, 130) = 37.490$ ,  $p < .001$ , for mixed (males and females);  
 .501,  $F(1, 60) = 20.080$ ,  $p < .001$ , for females only; and  
 .428,  $F(1, 68) = 15.244$ ,  $p < .001$ , for males only. The following  
 regression equations were derived to predict Math 101 marks.

$$\underline{Y}' = 29.133 + .461 (NA) \quad (\text{mixed}) \quad (7)$$

$$\underline{Y}' = 31.106 + .503 (NA) \quad (\text{females only}) \quad (8)$$

$$\underline{Y}' = 28.888 + .385 (NA) \quad (\text{males only}) \quad (9)$$

Table 11 summarizes the findings by presenting regression coefficients, beta coefficients, corresponding  $F$  values, and other pertinent statistics.

The significance of the difference between correlation coefficients for males and for females was tested by using Fisher's  $z_r$  transformation (see Table D).  $z$  was found to equal .526, which was not significant at the .05 level.

#### Math 102

The correlation coefficients between Math 102 mark and NA were:  
 .519,  $F(1, 48) = 17.705$ ,  $p < .001$ , for mixed (males and females);  
 .571,  $F(1, 30) = 14.527$ ,  $p < .001$ , for females only; and  
 .349,  $F(1, 16) = 2.221$ ,  $p < .25$ , for males only. The following  
 regression equations were derived to predict Math 102 marks.

$$\underline{Y}' = 46.113 + .393 (NA) \quad (\text{mixed}) \quad (10)$$

$$\underline{Y}' = 46.055 + .419 (NA) \quad (\text{females only}) \quad (11)$$

$$\underline{Y}' = 47.610 + .287 (NA) \quad (\text{males only}) \quad (12)$$

Table 12 summarizes the findings by presenting regression coefficients, beta coefficients, corresponding  $F$  values, and other pertinent statistics.

The significance of the difference between correlation

Table 11

Summary of the Regression Analysis of NA and Math 101 Mark, Sample II  
 (Computed for Mixed, Female, and Male Samples)

Variable	Simple <u>R</u>	<u>R</u> <sup>2</sup>	<u>B</u>	Beta	<u>F</u>	<u>df</u>
NA						
Mixed	.473	.224	.461	.473	37.490***	1, 130
Female	.501	.251	.503	.501	20.080***	1, 60
Male	.428	.183	.385	.428	15.244***	1, 68
(Constant)						
Mixed			29.133			
Female			31.106			
Male			28.888			

\*\*\*p < .001

Table 12

Summary of the Regression Analysis of NA and Math 102 Mark, Sample II  
 (Computed for Mixed, Female, and Male Samples)

Variable	Simple <u>R</u>	<u>R</u> <sup>2</sup>	<u>B</u>	Beta	<u>F</u>	<u>df</u>
NA						
Mixed	.519	.269	.393	.519	17.705***	1, 48
Female	.571	.326	.419	.571	14.527***	1, 30
Male	.349	.122	.287	.349	2.221	1, 16
(Constant)						
Mixed			46.113			
Female			46.055			
Male			47.610			

\*\*\*p < .001

coefficients for males and for females was tested by using Fisher's  $\underline{z}_r$  transformation (see Table D).  $\underline{z}$  was found to equal .896, which was not significant at the .05 level.



## CHAPTER V

### DISCUSSION

The previous chapter contained a presentation of results. In this chapter, those results are discussed, first for Sample I and then for Sample II. Following this are the implications of the study, both for counsellors at the school involved and for educators in general. Examples are given of specific ways in which the results of this study may be applied to work with students.

#### Sample I

Null hypothesis  $H_{01}$  was rejected at the .001 level for Math 100 (p. 37), Math 101 (p. 41), but not Math 102 (p. 41). There was a positive multiple correlation between math mark and scores on VR, NA, VR + NA, SR, AR, DOM, HN, and OTIS for Math 100 and 101, but not 102. Although the multiple correlation coefficient between Math 102 mark and the variables was significant at the .05 level, it was not sufficiently significant to reject the null hypothesis  $H_{01}$ . In light of the facts that the author set a rigid level of significance (.01), that the multiple correlation coefficient was actually higher for Math 102 (.614) than it was for Math 101 (.570), and that the sample size was smaller for Math 102 (35) than it was for Math 101 (87), the size of sample used for Math 102 may have been a stronger factor in accepting the null hypothesis than was any true lack of significance.

Variables in Table 4 are listed in the order of their contribution to the prediction of Math 100 mark. Table 4 shows that, although 40.6% of the variance in Math 100 marks is explained by consideration of seven variables, 38.4% of the variance is accounted for by consideration of only two variables, VR + NA and SR. While the contribution of all seven variables is statistically significant, it may not be educationally significant. The time and effort involved in testing, scoring, and compiling results of all the tests involved would not be worthwhile for the slight increase (2.2%) in predictability. Similarly, Table 6 shows that, although 32.5% of the variance in Math 101 marks is explained by analysis of eight variables, 24.5% of this variance is explained by consideration of only one variable, NA. Likewise, Table 8 shows that, although 37.7% of the variance in Math 102 marks is explained by analysis of five variables, 30.2% of this variance is explained by consideration of only one variable, NA.

Procedures used with Sample I served their intended purpose, which was to reduce the number of variables to those with individual significant contributions to prediction. Through the Sample I procedure VR + NA and SR were selected as predictor variables for Math 100, and NA was selected for Math 101 and 102.

#### Sample II

Null hypothesis  $H_{02}$  was rejected at the .001 level for Math 100 (p. 46), Math 101 (p. 49), and Math 102 (p. 49), for males, females, and mixed (males and females), with the exception of the Math 102 males-only sample. There was a positive multiple correlation between Math 100 mark and scores on VR + NA and SR for males,

females, and mixed (males and females); between Math 101 mark and scores on NA for males, females, and mixed (males and females); and between Math 102 mark and score on NA for females, and mixed (males and females), but not for males only. The sample size ( $n = 18$ ) of this latter group may have been partially responsible for this finding. Perhaps some of those boys choosing Math 102, a terminal course, are less highly motivated than those choosing Math 100 or 101, often prerequisites for further study. If this were the case, then it would be understandable that the Math 102 marks would be less highly correlated to mathematical aptitude, NA. This motivational factor might prove to be highly significant in predicting any academic marks and may well be worthy of further study.

The fact that the Math 102 mixed correlation coefficient was significant in Sample II but not in Sample I is accounted for by the increase in sample size and the decrease in the number of variables considered, which is in accordance with Kerlinger's "regression law of diminishing returns" (Kerlinger, 1973, p. 625).

Although correlation coefficients were higher for males than for females in Math 100, and higher for females than for males in Math 101 and 102, the differences were not significant (see Table D). Thus, it was inferred that males and females differed only randomly. This finding does not concur with previous research reports, in which significantly higher correlations for females than for males were found. Perhaps findings in this study reflect the changing times and lifestyles and a reduction in academic differences between males and females. Because differences between correlation coefficients for males and females were not statistically signifi-

cant, the regression equations derived for the mixed groups may be used for students of both sexes.

#### Implications of the Study

The study provides direct implications for counsellors at Sisler High School.

Counsellors may directly insert grade nine students' DAT scores into regression equations. Regression equations (with standard errors of the estimate in brackets) derived to predict math marks for Math 100, 101, and 102, respectively, are:

$$\underline{Y}' = 33.238 + .394 (VR + NA) + .150 (SR) \quad [11.872]$$

$$\underline{Y}' = 29.133 + .461 (NA) \quad [17.316]$$

$$\underline{Y}' = 46.113 + .393 (NA) \quad [11.401]$$

Figures 2, 3, and 4 display Sample II (mixed) regression lines for math mark predicted from VR + NA scores for Math 100, and NA scores for Math 101 and 102, respectively. These figures may be used to predict math marks at a glance rather than using the more time-consuming equations.

Table 13 may serve to present to a grade nine student the success or lack of success of previous students with similar NA scores in all three mathematics programs. For example, a student with an NA score between 20 and 29 would see, from Table 13, that no students with similar scores had passed Math 100, 8% had passed Math 101, and 73% had passed Math 102. Naturally, a counsellor cannot state that the student could never pass Math 100. However, it would seem to be the duty of the counsellor to point out to the student that no one with such a low ability score had passed Math 100 in the two years during which this study was conducted. On the other hand, a

Figure 2

Sample II Regression Line for Math 100 Mark Predicted from VR + NA

$$\underline{Y}' = 36.70982 + .4750163 (VR + NA)^a$$

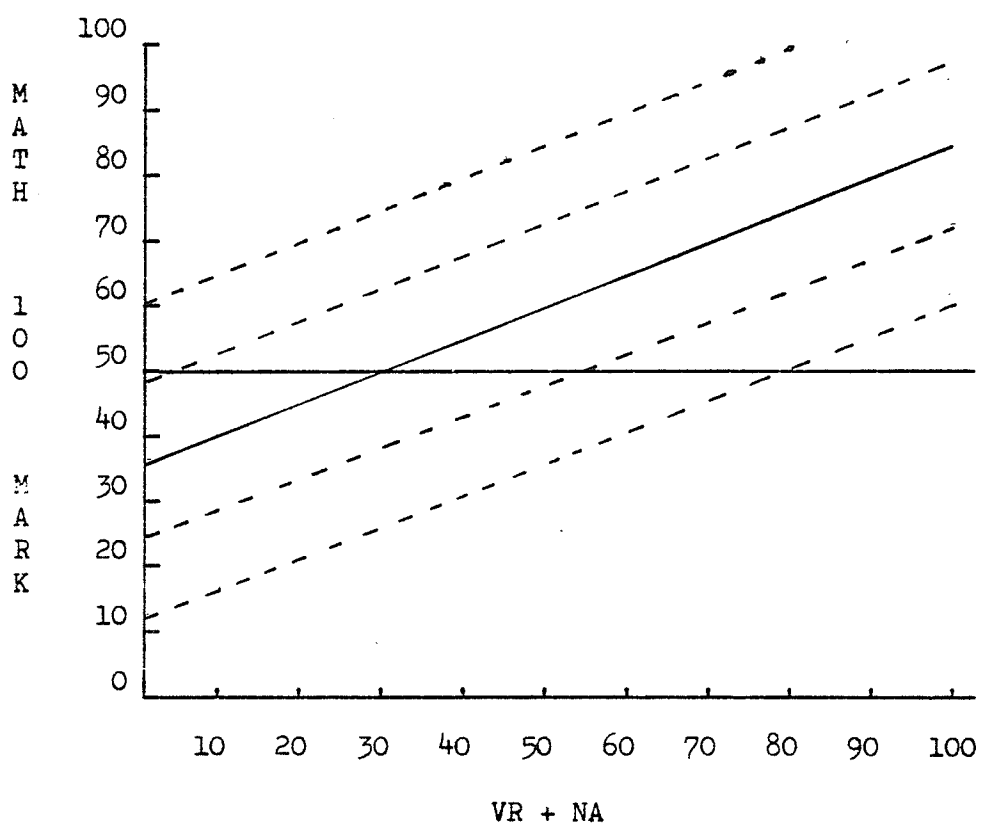

<sup>a</sup>Standard error of the estimate = 11.872

Note. The broken lines on graph contain the range of the predicted score plus and minus one and two standard errors of the estimate.

Figure 3

Sample II Regression Line for Math 101 Mark Predicted from NA

$$\underline{Y}' = 29.13259 + .4606637 (NA)^a$$

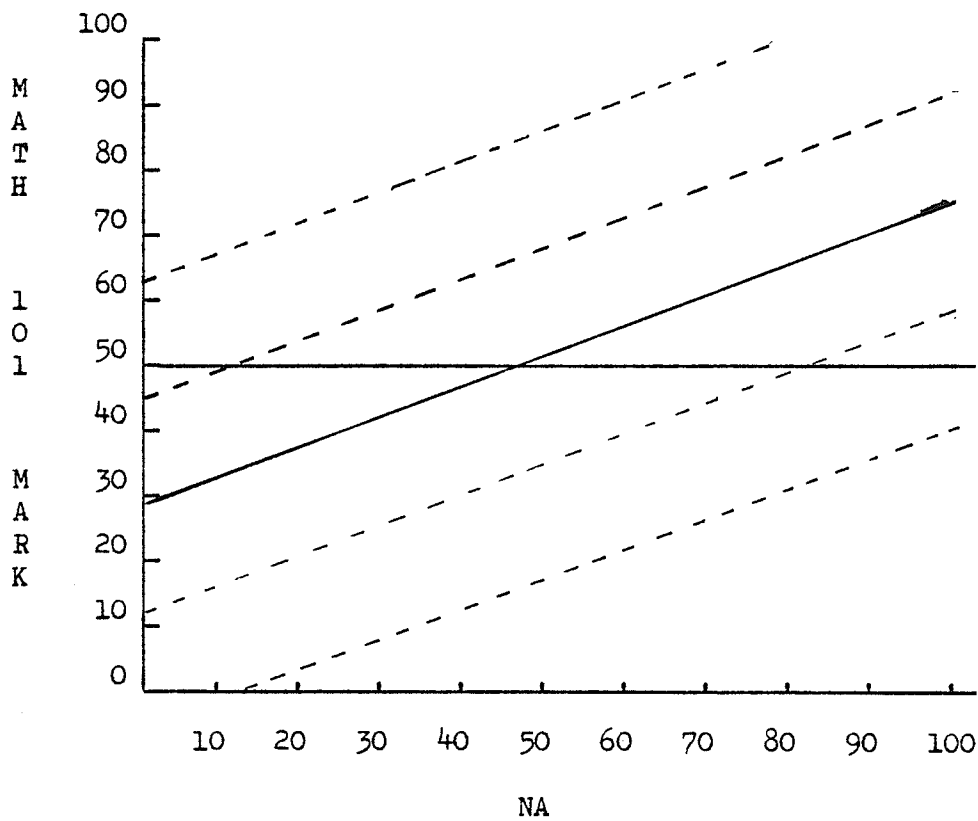

<sup>a</sup>Standard error of the estimate = 17.316

Note. The broken lines on graph contain the range of the predicted score plus and minus one and two standard errors of the estimate.

Figure 4

Sample II Regression Line for Math 102 Mark Predicted from NA

$$\underline{Y}' = 46.11319 + .3932921 (NA)^a$$

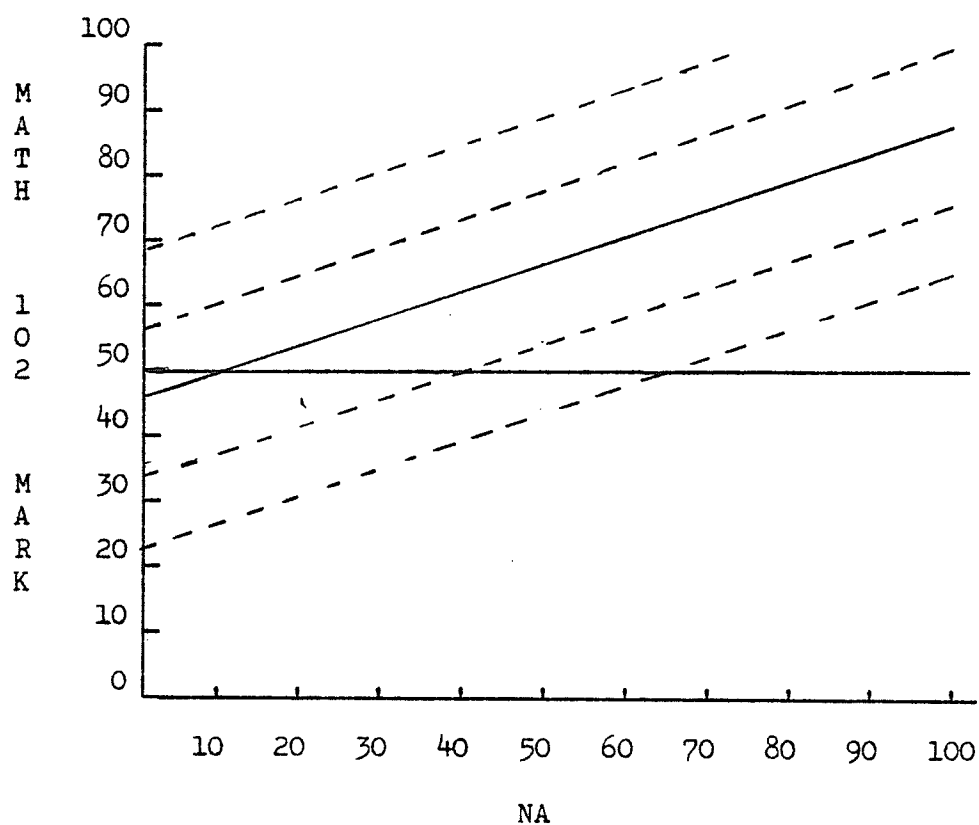

---

<sup>a</sup>Standard error of the estimate = 11.401

Note. The broken lines on graph contain the range of the predicted score plus and minus one and two standard errors of the estimate.

Table 13

Breakdown of Total Number of Students Passing Each Mathematics Course  
According to NA

NA	Math 100	Math 101	Math 102
90 - 100	41/43 (95%)	3/3 (100%)	. . .
80 - 89	31/32 (97%)	4/7 (57%)	1/1 (100%)
70 - 79	31/34 (91%)	7/10 (70%)	1/1 (100%)
60 - 69	20/23 (87%)	13/22 (59%)	. . .
50 - 59	18/24 (75%)	11/21 (52%)	5/6 (83%)
40 - 49	5/12 (42%)	14/28 (50%)	7/7 (100%)
30 - 39	3/7 (43%)	10/33 (30%)	7/8 (87%)
20 - 29	0/2 (0%)	1/13 (8%)	11/15 (73%)
10 - 19	. . .	5/16 (31%)	10/16 (62%)
0 - 9	. . .	12/3 (66%)	0/4 (0%)

Note. Percentage refers to proportion of scores within a given cell. Total number includes those students who withdrew from a mathematics course (see Appendix A for Raw Data Sample III).

Note. Scores above the heavy line have a 50% or greater chance of passing.



student with an NA score between 70 and 79, fearful that he could not handle the Math 101 program, could be reassured that 70% of students in that ability range had passed Math 101. While the counsellor cannot guarantee a passing grade, he can state that the student would have a high probability of gaining a passing grade. A student with an NA score of 45, wondering whether or not to attempt Math 101, might be advised that half the students with similar scores had passed during the previous two years. However, half had failed.

Close examination of factors such as the student's values, goals, motivation, study habits, extra curricular involvement, home environment, and course load might permit the counsellor and student to discover into which half the student would be more likely to fit. How much risk the student might be willing to take is important. Some people will successfully tackle outstanding odds to get what they want. Such a student with an NA score of 45 might prefer to take Math 101, with a 30% chance of passing, rather than Math 102, with an 87% chance of passing. Other people cannot cope with a possibility of failure. Even a 70% chance of passing, given to a student with an NA score of 75, may be seen as a 30% chance of failing, and may be too risky and upsetting for such a student to handle. He may prefer to take Math 102, a course which was failed only by students with lower NA scores.

It is crucial that anyone working with DAT scores recognizes that DAT scores must never be utilized in isolation. Many other factors must be taken into account in trying to predict math marks and, consequently, in trying to choose the most appropriate mathematics course. These factors, however, must be considered in addition to, rather than in lieu of, scores from the DAT.

If a student were considering Math 100, Table 14 could be used to portray the success and lack of success of previous students with similar SR and VR + NA scores. Previous students whose scores fell above the heavy line on this table had greater than a 50% chance of passing; all students with VR + NA scores of 80 and over passed Math 100. More specific information may be derived from this table concerning any given combinations of SR and VR + NA scores.

Although there were no statistically significant differences between correlation coefficients for males and females, it was felt that the differences might have some educational relevance. Separate expectancy tables (see Appendix C, Tables E, F, and G) were therefore devised according to sex for Math 100 and 102, because the differences in these two courses were closest to being significant. Differences between expectancy tables thus derived were so small that they appeared irrelevant.

The implications of this study would seem to extend to educators outside of Sisler High School. A study of the mathematics examinations (Appendix A) might enable a mathematics teacher to compare Sisler's program to his own, and thus to evaluate the usefulness of prediction equations, regression lines, and tables derived from this study to students in his school.

The exact equations used to predict math marks may vary from school to school. Although it may be unrealistic to assume that the magnitude and order of contribution of variables to prediction would be the same for students in other schools, it may be equally inappropriate to assume that DAT scores are useless in prediction.

Further local research, using procedures presented in this study

Table 14

Breakdown of Total Number of Students Passing Math 100  
According to VR + NA and SR

V 80 - 100	2/2 (100%)	6/6 (100%)	12/12 (100%)	16/16 (100%)	31/31 (100%)
R 60 - 79	3/3 (100%)	9/10 (90%)	11/16 (69%)	10/12 (83%)	15/16 (94%)
+ 40 - 59	2/4 (50%)	8/12 (67%)	5/6 (83%)	8/9 (89%)	7/9 (78%)
N 20 - 39	0/1 (0%)	1/6 (17%)	1/3 (33%)	.	2/2 (100%)
A 0 - 19	. . .	0/1 (0%)	. . .	. . .	.
	0 - 19	20 - 39	40 - 59	60 - 79	80 - 100
	SR				

Note. Percentage refers to proportion of scores within a given cell. Total number includes those students who withdrew from a mathematics course (see Appendix A for Raw Data Sample III).

Note. Scores above the heavy line have higher than a 50% chance of passing.

to cross-validate results, is suggested. Study procedures may be improved by keeping track of all students entered in every course as of September, rather than compiling names of students in June. Students enrolled in a course for the second time might be removed from the sample. A check might be done to determine reasons why students had withdrawn, in order to eliminate from the study those who withdrew due to reasons totally unrelated to ability in mathematics. Reasons may have included parents moving, medical problems, or marriage. Consistent pretest orientation across all feeder schools might increase the uniformity of student test-writing motivation and, thus, the usefulness of test scores. It is crucial that anyone using DAT results be aware of the importance of the pretest orientation. The orientation, or lack of it, may be instrumental in determining student effort put into the test and thus in determining the use which may be made of test results.

As Mowat (1966) explained:

Education is essentially a selective process. This is so because on the one hand the fund of human knowledge is so large that no one person can ever master more than a small part of it and therefore an area of specialization for each individual must be determined; on the other hand human beings differ so much in abilities and talents, that steps must be taken to accommodate each individual's education to his abilities and talents. . . . It is evident that we have a long way to go in the search for improved means of selection; it is also evident that the search must go on and be intensified. (p. 18)

The author is in agreement with Mowat and is convinced that such an aid in mathematics course selection has been and is available. The research conducted in this study reveals that, of all test scores available to Winnipeg educators (DAT, Dominion, Henmon-Nelson, and Otis), DAT subtest results -- particularly NA, SR, and VR + NA scores -- contribute most to prediction of success in mathematics, as measured at Sisler High School, and thus aid mathematics course selection.

The DAT is too relevant a tool to be ignored by educators! On the basis of this study, anyone trying to help students choose grade ten mathematics courses wisely would be well advised to consider DAT scores.

## References

- Abelson, R. P. Sex differences in predictability of college grades. Educational and Psychological Measurement, 1952, 12, 638-644.
- Anderson, R. A study of the predictability of high school grades and the Differential Aptitude Tests for success in vocational programs in health careers. A M.S. Thesis Presented to the Faculty of the University of Wisconsin, La Crosse, 1971. (ERIC Document Reproduction Service No. ED 068 697)
- Baldwin, A. Y. Tests can underpredict: A case study. Phi Delta Kappan, 1977, 58 (8), 620-621.
- Bechtoldt, H. Review of the Differential Aptitude Tests. O. K. Buros (Ed.), Mental Measurements Yearbook, 1953, 4, 676-678.
- Bedal, C. L. Editorial. The School Guidance Worker, 1976, 31 (4), 2-3.
- Bell, F. O., & Hoff, A. L. Answer sheets do make a difference. Personnel Psychology, 1964, 17, 65-71.
- Bennett, G. K., Seashore, H. G., & Wesman, A. G. A manual for the Differential Aptitude Tests (4th ed.). New York: The Psychological Corporation, 1966.
- Berdie, R. F. Review of the Differential Aptitude Tests. O. K. Buros (Ed.), Mental Measurements Yearbook, 1953, 4, 679-680.
- Black, D. B. Review of the Quick-Scoring Group Test of Learning Capacity: Dominion Tests. O. K. Buros (Ed.), Mental Measurements Yearbook, 1965, 6, 767-769.
- Boyd, J. D. The relative prognostic value of selected criteria in

- predicting academic success at Northwestern University. Disserta-  
Abstracts, 1955, 15, 1780.
- Burack, B. Have you checked machine scoring error lately? Vocational  
Guidance Quarterly, 1961, 9, 191-193.
- Carpenter, F., Brinkmann, E. H., & Lirones, D. S. Educability of  
students in the visualization of objects in space. Michigan Univer-  
sity, Ann Arbor. Cooperative Research Project No. 1474, 1965.  
(ERIC Document Reproduction Service No. ED 003 271)
- Carroll, J. B. Review of the Differential Aptitude Tests. O. K. Buros  
(Ed.), Mental Measurements Yearbook, 1959, 5, 670-673.
- Carter, H. C. Improving the prediction of school achievement by use  
of the California Study Methods Survey. Educational Administration  
and Supervision, 1959, 45, 255-260.
- Cheong, G. S. C. Relations among age, schooling, Differential Aptitude  
Test, and the ACER Test. Educational and Psychological Measurement,  
1970, 30 (2), 479-482.
- Cronback, L. J. Studies of acquiescence as a factor in the true-false  
test. Journal of Educational Psychology, 1942, 33, 401-415.
- Cronback, L. J. Essentials of psychological testing. New York:  
Harper and Brothers, 1949.
- Crosby, G., Fremont, H., & Mitzel, H. E. Mathematics individual  
learning experiment. City University of New York, Queens  
College, Flushing, New York, Report No. NDEA-VIIA-391, Grant  
OEG-7-42-1050-D69, 1960. (ERIC Document Reproduction Service No.  
ED 003 558)

- Cumming, J. F., Davies, M. M., Nagle, J. P., & Thompson, G. M.  
Project 13--Outreach counseling, Minneapolis public schools.  
Progress Report, Minneapolis Public Schools, Minnesota, 1966.  
(ERIC Document Reproduction Service No. ED 011 676)
- Dalton, S. A decline in the predictive validity of the SAT and high school achievement. Educational and Psychological Measurement, 1976, 36, 445-448.
- Durost, W. N. Present progress and needed improvements in school evaluation programs. Educational and Psychological Measurement, 1954, 14, 247-254.
- Emmett, W. C. Review of Group Test of Learning Capacity: Dominion Tests. O. K. Buros (Ed.), Mental Measurements Yearbook, 1953, 4, 395-396.
- Ferguson, G. A. Review of the Quick-Scoring Group Test of Learning Capacity: Dominion Tests. O. K. Buros (Ed.), Mental Measurements Yearbook, 1965, 6, 769.
- Frederiksen, N. Review of the Differential Aptitude Tests. O. K. Buros (Ed.), Mental Measurements Yearbook, 1959, 5, 673-676.
- Fredhoff, W. H. Relationships among various measures of socioeconomic status, social class identification, intelligence, and school achievement. Dissertation Abstracts, 1955, 15, 2098.
- Froehlich, D. P., & Hoyt, K. B. Guidance testing. Chicago: Science Research Associates, 1959.
- Garrett, H. F. A review and interpretation of investigations of factors related to scholastic success in colleges of arts and sciences and teachers colleges. Journal of Experimental Education,



- 1949, 18, 91-138.
- Gough, H. What determines the academic achievement of high school students? Journal of Educational Research, 1953, 46, 321-333.
- Grooms, R. R., & Endler, N. S. The effect of anxiety on academic achievement. Journal of Educational Psychology, 1960, 51, 299-304.
- Hanna, G. S. Review of the Differential Aptitude Tests. Journal of Educational Measurement, 1974, 11 (2), 145-149.
- Herman, A., & Gallo, J. G. Uses of prediction in secondary schools. Canadian Counsellor, 1973, 7 (4), 232-240.
- Holmes, M. Innocence and the counsellor -- Guidance and the evaluation of students. The School Guidance Worker, 1976, 31 (4), 4-8.
- Humphreys, L. G. Review of the Differential Aptitude Tests. O. K. Buros (Ed.), Mental Measurements Yearbook, 1953, 4, 680-681.
- Jackson, R. A. Prediction of the academic success of college freshmen. Journal of Educational Psychology, 1955, 46, 296-301.
- Jacobs, J. N. Aptitude and achievement measures in predicting high school academic success. Personnel and Guidance Journal, 1959, 37, 334-341.
- Jacobson, T. J. A study of the Differential Aptitude testing program in the Grossmont Union High School District. Grossmont Union High School District, California, San Diego County Department of Education, California Regional Occupational Program, 1975. (ERIC Document Reproduction Service No. ED 117 148)
- Keats, J. A. Review of the Differential Aptitude Tests. O. K. Buros (Ed.), Mental Measurements Yearbook, 1965, 6, 1002-1005.

- Kerlinger, F. N. Foundations of behavioral research (2nd ed.). New York: Holt, Rinehart and Winston, Inc., 1973.
- Kerr, L. J. Interest and aptitude tests -- Are they significant? The School Guidance Worker, 1976, 31 (4), 33-36.
- Kim, H. G., & Kang, S. J. A study of the aptitude structures of freshmen in Seoul National University. Korean Institute for Research in the Behavioral Sciences, Agency for International Development, Department of State, Washington, D.C.: Ministry of Science and Technology, Seoul, South Korea, 1970. (ERIC Document Reproduction Service No. ED 128 353)
- Klugh, H. E., & Bierley, R. The School and College Ability Test and high school grades as predictors of college achievement. Educational and Psychological Measurement, 1959, 19, 625-626.
- Lamke, T. A., & Nelson, M. J. The Henmon-Nelson Tests of mental ability manual (Rev. ed.). Boston: Houghton Mifflin Co., 1957.
- Larson, J. R., & Scontrino, M. P. The consistency of high school grade point average and of the verbal and mathematical portions of the Scholastic Aptitude Test of the College Entrance Examination Board, as predictors of college performance: An eight year study. Educational and Psychological Measurement, 1976, 36, 439-443.
- Lavin, D. E. The prediction of academic performance: A theoretical analysis and review of research. New York: Russell Sage Foundation, 1965.

- Lunneborg, C. E., & Lunneborg, P. W. Predicting success in community college vocational courses. Journal of Counseling Psychology, 1969, 16, 543-548.
- Malone, F. E. A study of students enrolled in post-high school public vocational education programs in Iowa during the 1964-65 school year (Doctoral dissertation, University of Iowa, 1966). Dissertation Abstracts, 1966, 27, 3-A 678.
- Merwin, J. C. Review of the Differential Aptitude Tests. O. K. Buros (Ed.), Mental Measurements Yearbook, 1972, 7, 1049-1052.
- Merwin, J. C., Bradley, A. D., Johnson, R. H., & John, E. R. SVIB machine scoring provided by a test scoring agency. Personnel Guidance Journal, 1965, 43, 665-668.
- Michael, W. B. Prediction. In R. L. Ebel (Ed.) Encyclopedia of educational research (4th ed.). London: The Macmillan Company Collier - Macmillan Ltd., 1969.
- Michael, W. B., & Jones, R. Stability of predictive validities of high school grades and of scores on the Scholastic Aptitude Test of the College Entrance Examination Board for liberal arts students. Educational and Psychological Measurement, 1963, 23, 375-378.
- Miller, G., & Schill, W. J. Is your LPN program keeping P.A.C.E.? 1974. (ERIC Document Reproduction Service No. ED 107 334)
- Mogull, R. G., & Rosengarten, W., Jr. Predicting success in elementary algebra. Alberta Journal of Educational Research, 1974, 20 (1), 34-38.
- Morris, J. Testing: Yes or no, not maybe. The School Guidance

- Worker, 1976, 31 (4), 28-32.
- Mowal, A. S. CAC high school testing project report no. 4, prediction of university success (beyond the first year of attendance).  
Central Advisory Committee on Education in the Atlantic Provinces,  
1966.
- Mussio, J. Assessment: Factors to consider. The School Guidance Worker, 1976, 31 (4), 10-12.
- Nason, L. J. Academic achievement of gifted high school students.  
Los Angeles: University of Southern California Press, 1958.
- Nichols, K. E. A research project using the Safran Student Interest Inventory (SSII): Discriminant analysis of university majors.  
Calgary Separate School Board, Alberta, 1971, Paper presented at  
the Annual Convention of the CGCA, Toronto, 1971. (ERIC Document  
Reproduction Service No. ED 059 284)
- Nie, N. H., Hull, C. H., Jenkins, J. G., Steinbrenner, K. & Bent,  
D. H. Statistical package for the social sciences (2nd ed.).  
U.S.A.: McGraw-Hill, Inc., 1970.
- Perry, D. K. Differential Aptitude Test scores and vocational  
training program choice. Measurement and Evaluation in Guidance,  
1976, 9 (3), 101-109.
- Price, F. W., & Kim, S. H. The association of college performance  
with high school grades and college entrance test scores. Educa-  
tional and Psychological Measurement, 1976, 36, 956-970.
- Quereshi, M. Y. Review of the Differential Aptitude Tests. O. K. Buros  
(Ed.), Mental Measurements Yearbook, 1972, 7, 1049-1052.

- Rapaport, G. M., & Berg, I. A. Response sets in a multiple-choice test. Educational and Psychological Measurement, 1955, 15, 58-62.
- Ryan, J. J., & French, J. R. Long-term grade predictions for intelligence and achievement tests in schools of differing socioeconomic levels. Educational and Psychological Measurement, 1976, 36, 553-559.
- Safran, C. Can counsellors use tests effectively? The School Guidance Worker, 1976, 31 (4), 23-27.
- Scannell, D. P. Prediction of college success from elementary and secondary school performance. Journal of Educational Measurement, 1960, 51, 130-135.
- Schutz, R. E. Review of the Differential Aptitude Tests. O. K. Buros (Ed.). Mental Measurements Yearbook, 1965, 6, 1005-1007.
- Seashore, H. G. The DAT--A seven-year follow-up. Test Service Bulletin of the Psychological Corporation, 1955, 49, 11-15. (ERIC Document Reproduction Service No. ED 079 348)
- Spencer, R. E. Reliability and validity of the digitek optical scanner in test scoring operations. Educational and Psychological Measurement, 1966, 26, 719-723.
- Stricker, L. J. Difficulty and other correlates of criticalness response style at the item level. Educational and Psychological Measurement, 1965, 25, 683-706.
- Taylor, C. L., Brown, F. G., & Michael, W. B. The validity of cognitive, affective, and demographic variables in the prediction of achievement in high school algebra and geometry: Implications for the definition of mathematical aptitude. Educational and Psychological Measurement, 1976, 36, 971-982.

- Tests & instructional aids. Toronto: Guidance Centre, Faculty of Education, University of Toronto, 1976.
- Travers, R. M. Significant research on prediction of academic success. The Measurement of Student Adjustment and Achievement, 1956, 16, 543-548.
- Urdal, L. B., Cech, E. J., Hamreus, D. G., & Workman, D. J. Dropouts: An analysis of personal variables within the school situation. Washington Office of the State Superintendent of Instruction, Olympia, Report No. RR-02-01, 1963. (ERIC Document Reproduction Service No. ED 014 108)
- Wahlstrom, M., & Weinstein, E. L. Standardized testing in Ontario intermediate schools. The School Guidance Worker, 1976, 31 (4), 43-47.
- Walter, D., Denzler, L. S., & Sarason, I. G. Anxiety and the intellectual performance of high school students. Child Development, 35, 917-926.
- Weigel, R., Roehlke, A., & Poe, C. Re-evaluating machine scoring consistency. Vocational Guidance Quarterly, 1965, 13, 209-211.
- Womer, F. B. Test use. In R. L. Ebel (Ed.), Encyclopedia of Educational Research (4th ed.). London: The Macmillan Company Collier-Macmillan Ltd., 1969.

## Reference Notes

Stewart, W. K. The relationship between the Differential Aptitude Tests, grade twelve average, and university success. Unpublished masters thesis, University of Manitoba, 1972.

## Footnotes

Correspondence concerning this thesis should be sent to  
J. L. Tipping, 3-212-65 Swindon Way, Winnipeg, Manitoba, R3P 0T8.

<sup>1</sup>Beta Four is the label given to the class with the lowest academic performance in a given subject of seven classes each arranged as homogeneously as possible.

<sup>2</sup>Alpha One is the label given to the class with the highest academic performance in a given subject of seven classes each arranged as homogeneously as possible.

<sup>3</sup>Math 104, previously known as Math 106, was developed by W. Korytowski and J. Pascoe. Correspondence concerning this course should be sent to Mr. W. Korytowski, Sisler High School, 1360 Redwood Avenue, Winnipeg, Manitoba, R2X 0Z1.



## Appendix A: 1977 and 1978 Mathematics Cumulative Examinations

Used to Determine Math Mark in Math 100 and Math 101

## Mathematics 100

June, 1977

Name \_\_\_\_\_

Time: 2 hrs.

Subject Teacher \_\_\_\_\_

No. of Pages: 7

Values

1. Fill in the blanks:

(a) If  $\triangle ABC \sim \triangle MNO$  then  $\frac{AB}{AC} = \underline{\hspace{2cm}}$ .

20 x 1

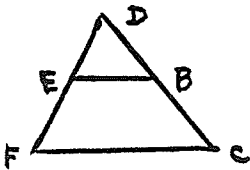
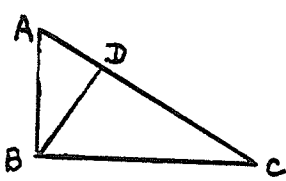
(b)  $\angle T$  and  $\angle A$  are supplementary angles. If  $m\angle T = 2x + 8$  and  $m\angle A = x + 22$ , then  $x$  equals  $\underline{\hspace{2cm}}$ .(c) The measure of the vertex angle of an isosceles triangle is 76. The measure of each base angle is  $\underline{\hspace{2cm}}$ .(d) If  $\angle 1$  complements  $\angle 2$  and  $\angle 2$  complements  $\angle 3$ , then  $\angle 1$   $\underline{\hspace{2cm}}$   $\angle 3$ .(e) If  $\triangle DEF \sim \triangle PMR$ , then  $\triangle FDE$  is similar to  $\underline{\hspace{2cm}}$ .(f) In  $\triangle XYZ$ ,  $XY = 6$  and  $YZ = 10$  then  $XZ > \underline{\hspace{2cm}}$ .(g) The converse of the statement "Each angle of an equilateral triangle has measure 60." is  $\underline{\hspace{2cm}}$ .(h)  If  $\overline{EB} \parallel \overline{FC}$  and  $DE = 4$ ,  $DB = 6$ ,  $DF = 10$ , then  $BC = \underline{\hspace{2cm}}$ .(i)  If  $\overline{AB} \perp \overline{BC}$ ,  $\overline{BD} \perp \overline{AC}$  and  $AB = 10$  with  $BD = 8$ , then  $AD = \underline{\hspace{2cm}}$ .

Note. The original examinations provided sufficient space for students' work to be shown, extra paper for rough work, and graph paper where needed.

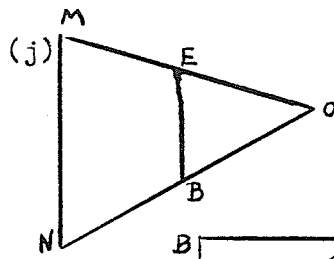

E and B are the midpoints of  $\overline{OM}$  and  $\overline{ON}$  respectively.  $OE = 5$ ,  $OB = 7$  and  $EB = 8$ . The perimeter of  $\triangle OMN$  equals \_\_\_\_\_.

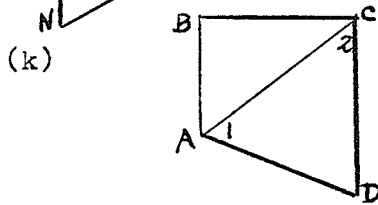

$\overline{AB} \perp \overline{BC}$ ,  
 $m\angle 1 = 61$ ,  $m\angle 2 = 59$ ,  $m\angle D = 60$   
 The longest segment is \_\_\_\_\_.

(l) An obtuse triangle is a triangle with \_\_\_\_\_ obtuse angle(s).

(m) A 48 Centimeter segment is divided into three parts whose lengths have the ratio 2:3:3. The length, in centimeters, of the shortest segment is \_\_\_\_\_.

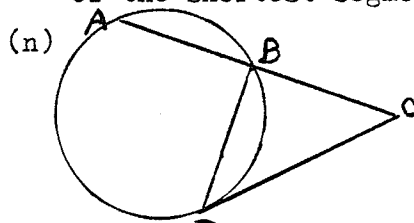

Given:  $BC = BD$ ,  $m\angle D = 35$ .  
 Find:  $m\widehat{AD} =$  \_\_\_\_\_.

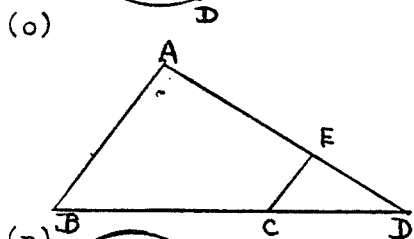

Given:  $\overline{AB} \parallel \overline{EC}$ ,  $AE = 9$ ,  $BC = 6$ ,  
 $CD = 2$ .  
 Find:  $DE =$  \_\_\_\_\_.

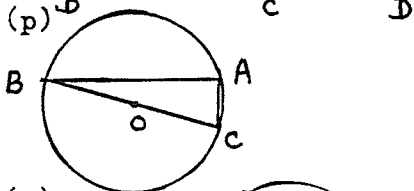

Given:  $\odot O$ ,  $BC = 13$ ,  $AB = 12$   
 Find:  $AC =$  \_\_\_\_\_.

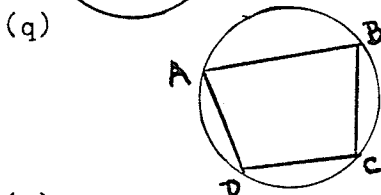

Given:  $m\angle D = 100$   
 Find:  $m\angle B =$  \_\_\_\_\_

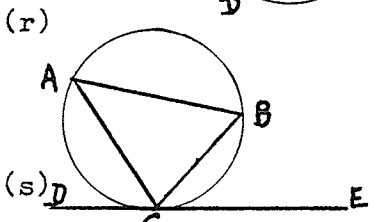

Given:  $\overline{DE}$  tangent to the circle at C.  
 $AB = AC$ ,  $m\angle BCE = 70$   
 Find:  $m\angle ACD =$  \_\_\_\_\_

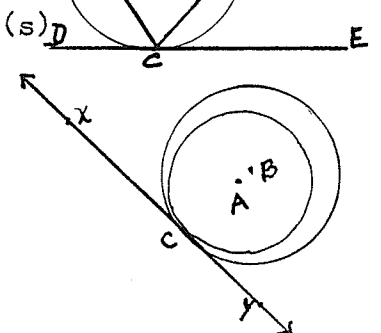

Given:  $\odot A$  and  $\odot B$ , both tangent to  $\overleftrightarrow{XY}$  at C.  
 The radius of  $\odot A = 3$   
 The radius of  $\odot B = 5$   
 Find:  $AB =$  \_\_\_\_\_

(t)

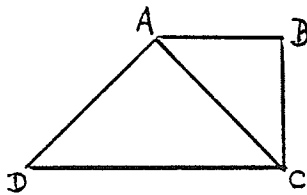

Given:  $\overline{AC}$  bisects  $\angle DCB$ ,  $AC = 4$ ,  
 $AD = 5$ ,  $\angle DAC \cong \angle B$ ,  $DC = 8$   
 Find:  $BC = \underline{\hspace{2cm}}$ .

2. Use a straightedge and compass only to draw the circle passing through the points A, B, and C. Describe the construction.

5

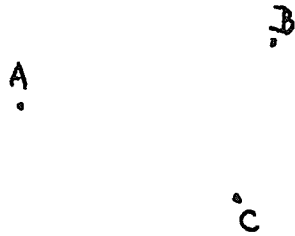

3. Prove the following theorem. (The theorem of Pythagoras.)

"In a right triangle, the square of the hypotenuse is equal to the sum of the squares of the legs."

6

4. Prove each of the following:

(a)

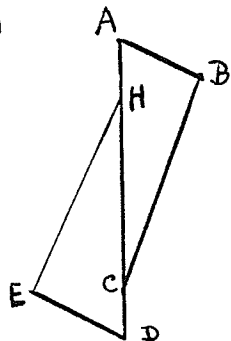

Given:  $\angle A \cong \angle D$ ,  $\overline{AH} \cong \overline{CD}$   
 $\overline{AB} \cong \overline{ED}$   
 Prove:  $\overline{EH} \parallel \overline{BC}$

6

(b)

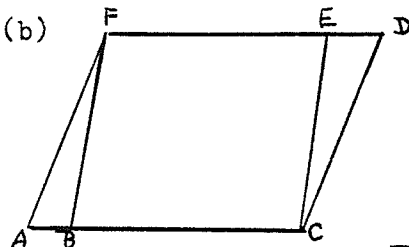

Given:  $\parallel\text{gm } BCEF$ ,  $\overline{AB} \cong \overline{ED}$   
 Prove:  $\overline{AF} \cong \overline{CD}$

6

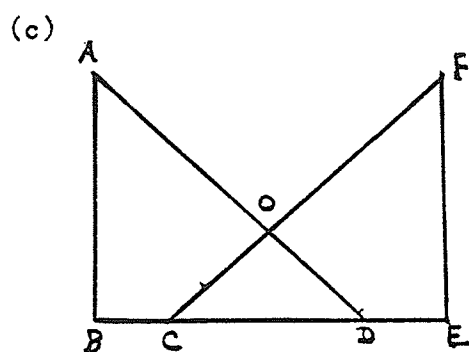

6

Given:  $\overline{AB} \perp \overline{BE}$ ,  $\overline{FE} \perp \overline{BE}$ ,  
 $\overline{BC} \cong \overline{DE}$ ,  $\overline{AD} \cong \overline{CF}$

Prove:  $\triangle COD$  is isosceles.

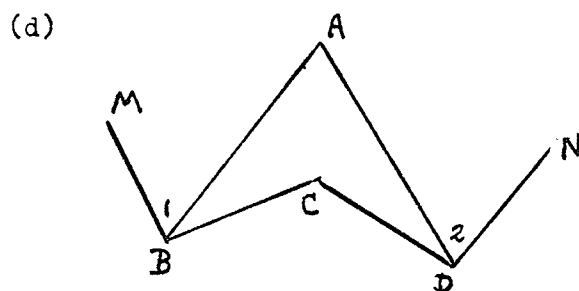

6

Given:  $\overline{AB} \cong \overline{AD}$ ,  $\overline{CB} \cong \overline{CD}$   
 $\angle MBC \cong \angle NDC$

Prove:  $\angle 1 \cong \angle 2$

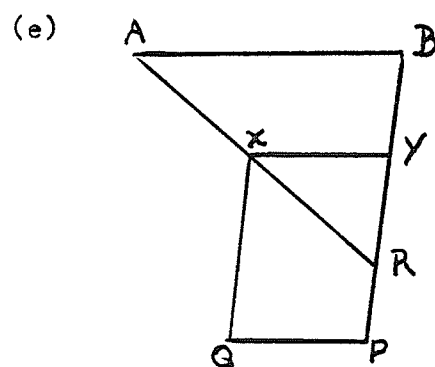

5

Given:  $\parallel gm XYPQ$

X and Y are midpoints of  $\overline{AP}$  and  $\overline{BP}$ , respectively

Prove:  $\overline{AB} \parallel \overline{QP}$

(f)

6

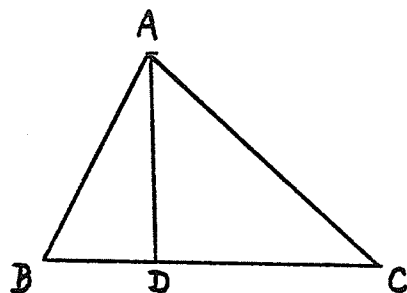

Given:  $\overline{AD}$  is an altitude of  $\triangle ABC$   
 $\overline{AD}$  is not a median of  $\triangle ABC$   
 Prove:  $\overline{AB} \neq \overline{AC}$

(g)

6

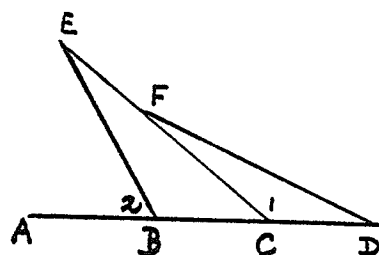

Given:  $\angle 1 > \angle 2$   
 Prove:  $FD > FC$

(h)

5

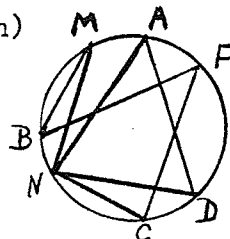

Given:  $\angle A \cong \angle F$   
 Prove:  $\angle M \cong \angle CND$

(i)

6

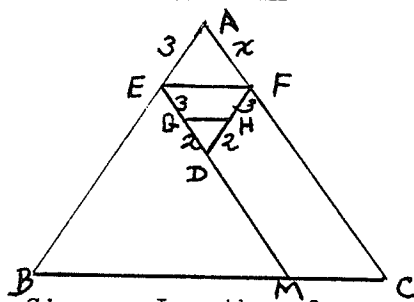

Given: Lengths of segments as indicated in the diagram.  
 Prove:  $\angle HGM \cong \angle GMB$

5

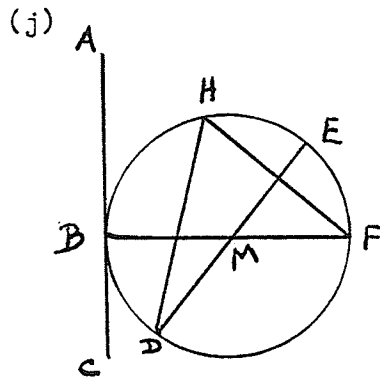

Given:  $\overline{AC}$  is a tangent at B.

$\overline{FB} \perp \overline{AC}$

$\overline{DE}$  is the perpendicular bisector of  $\overline{HF}$

Prove:  $m\angle H = \frac{1}{2} m\angle DMF$

6

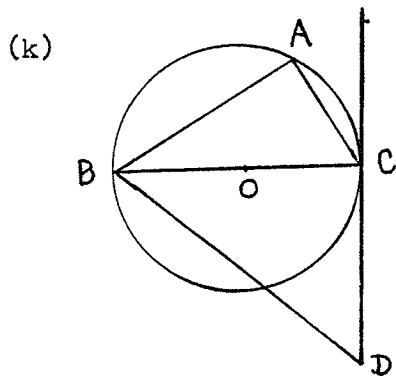

Given:  $\odot O$  with  $\overline{DC}$  tangent at C

$\overline{AC} \parallel \overline{BD}$

Prove:  $BC^2 = (AC)(BD)$

6

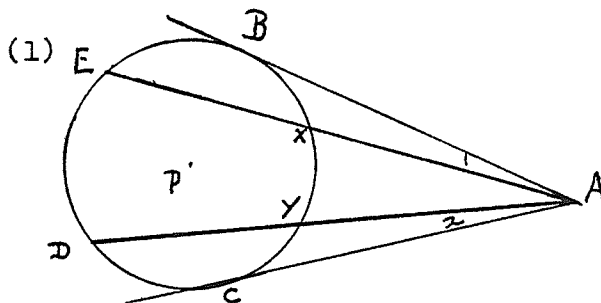

Given:  $\odot P$  with tangents  $\overline{AB}$  and  $\overline{AC}$   
at B and C respectively

$\angle 1 \cong \angle 2$

Prove:  $\overline{EX} \cong \overline{DY}$

Mathematics 100

June, 1978

Name \_\_\_\_\_

Time: 2 hrs.

Subject Teacher \_\_\_\_\_

No. of Pages: 6

Values

1. Fill in the blanks. (Same markings indicate congruent segments or angles.)

(a) Complete the similarities and proportions.

2

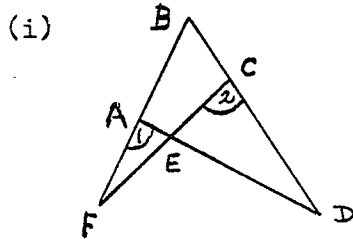

Given:  $\angle 1 \cong \angle 2$

$\triangle AFE \sim \triangle$  \_\_\_\_\_,  $\triangle ABD \sim \triangle$  \_\_\_\_\_

$\frac{AE}{FE} =$  \_\_\_\_\_,  $\frac{AB}{BD} =$  \_\_\_\_\_

(ii)

1

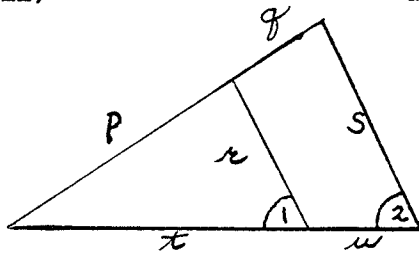

Given:  $\angle 1 \cong \angle 2$

$\frac{p}{q} =$  \_\_\_\_\_  $\frac{r}{s} =$  \_\_\_\_\_

(b) Given circle O, name:

1½

(i) a minor arc intercepted by  $\angle P$ . \_\_\_\_\_

(ii) an inscribed angle that intercepts  $\widehat{QS}$ . \_\_\_\_\_

(iii) a right angle, other than  $\angle RSP$ . \_\_\_\_\_

(iv) a tangent segment. \_\_\_\_\_

(v) a secant segment. \_\_\_\_\_

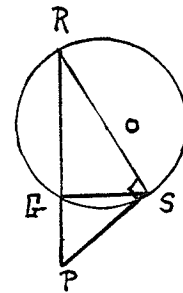

(c) Given the drawn circle and chords, with  $m \angle HGE = 36$

1

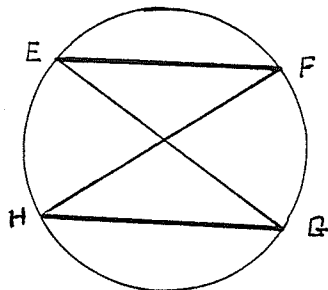

$m \widehat{EH} =$  \_\_\_\_\_

$m \angle F =$  \_\_\_\_\_

1/2

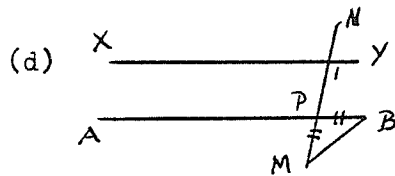

Given:  $XY \parallel AB$ ,  $m\angle ABM = 50$ ,  $PM = PR$

Find:  $m\angle 1 = \underline{\hspace{2cm}}$

1

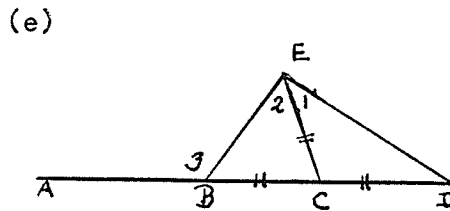

Given:  $BC = CD = EC$ ,  $m\angle 1 = 20$

Find:  $m\angle 2 = \underline{\hspace{2cm}}$ ,  $m\angle 3 = \underline{\hspace{2cm}}$

2

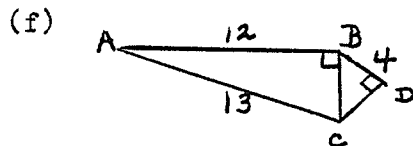

Given:  $\overline{AB} \perp \overline{BC}$ ,  $\overline{BD} \perp \overline{DC}$

Find:  $BC = \underline{\hspace{2cm}}$   $DC = \underline{\hspace{2cm}}$

1

(g) If  $\overline{AC} \perp \overline{DC}$  and  $\overline{AB} \perp \overline{CB}$  then the longest segment below

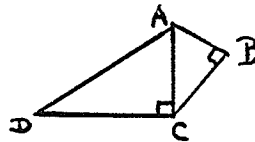

is  $\underline{\hspace{2cm}}$ .

3

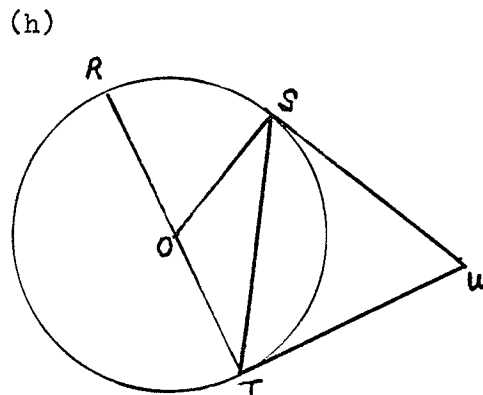

Given: Circle O with  $\overline{RS}$ , and  $\overline{ST}$  as tangents at S and T respectively.

$m\angle RS = 80$ .

Find:  $m\angle RTS = \underline{\hspace{2cm}}$

$m\angle OST = \underline{\hspace{2cm}}$

$m\angle U = \underline{\hspace{2cm}}$

1

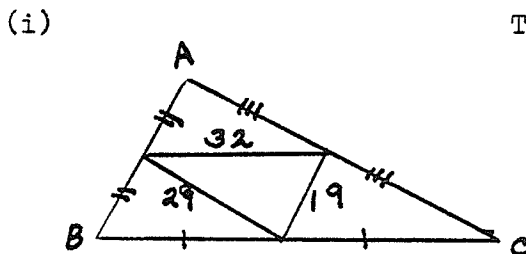

The perimeter of  $\triangle ABC$  is  $\underline{\hspace{2cm}}$

1

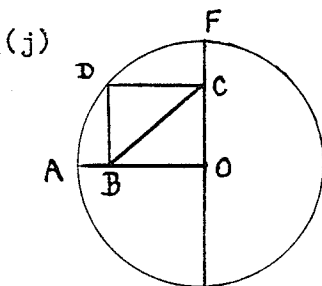

Given: Circle O,  $EF = 6$  cm

$\overline{AO} \perp \overline{FE}$ ,  $\overline{DB} \perp \overline{AO}$ ,

$\overline{DC} \parallel \overline{AO}$

Find:  $BC = \underline{\hspace{2cm}}$



2. Prove the following theorems.

- (a) The two tangent segments from one point to the same circle are congruent.

7

- (b) The Pythagorean Theorem.

8

3. Use straightedge and compass only to draw the circle passing through the vertices of  $\triangle ABC$ . Leave all arcs and describe your construction.

5

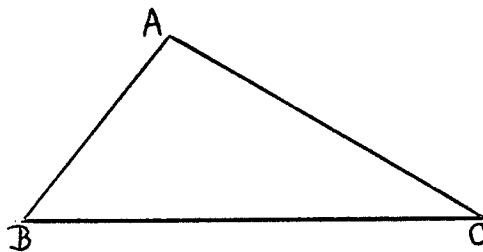

4. Prove each of the following questions.

(a)

5

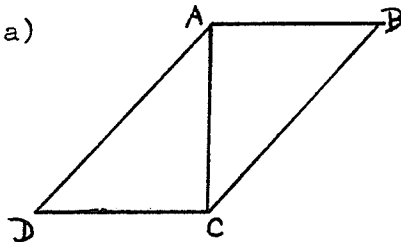

Given:  $\overline{AB} \perp \overline{AC}$   
 $\overline{AC} \perp \overline{DC}$   
 $AD = BC$

Prove:  $\square ABCD$  is a //gm.

5

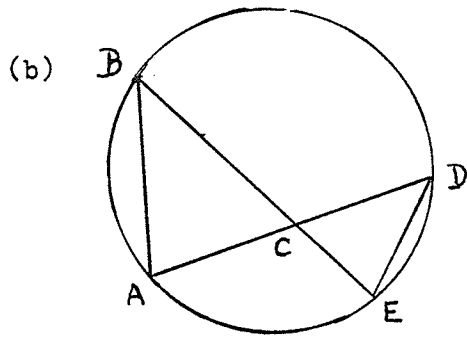

Given: Figure as drawn.

Prove:  $\frac{AB}{AC} = \frac{ED}{EC}$

5

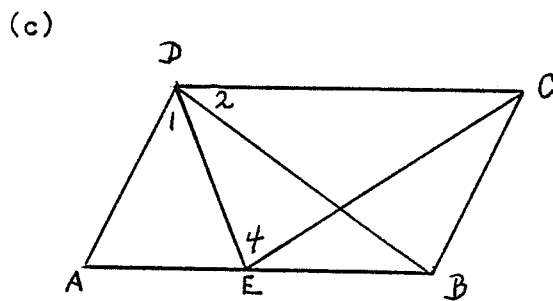

Given:  $\overline{AD} \cong \overline{ED}$

$\angle 1 \cong \angle 2$

$\angle A \cong \angle 4$

Prove:  $\triangle ADB \cong \triangle EDC$

5

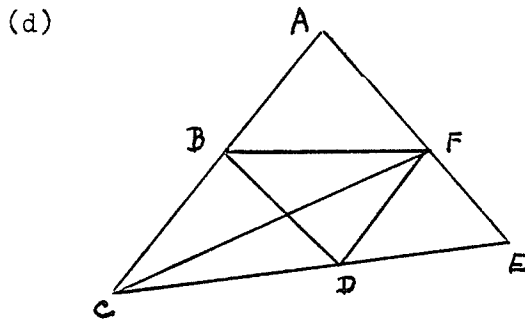

Given: B is the midpoint of  $\overline{AC}$

F is not the midpoint of  $\overline{AE}$

Prove:  $\overline{BD}$  and  $\overline{CF}$  do not bisect each other.

(e) Prove that the altitude to the base of an isosceles triangle is a median of the triangle.

5

(f)

5

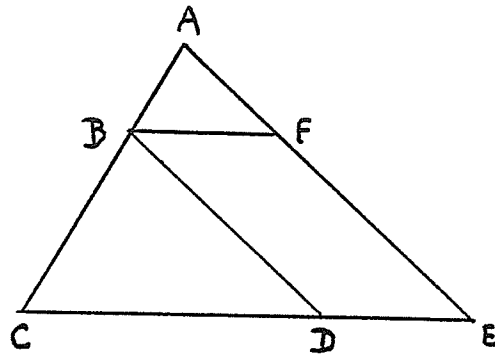
Given:  $\triangle ABF \sim \triangle BCD$ Prove:  $\square BFED$  is a //gm

(g)

5

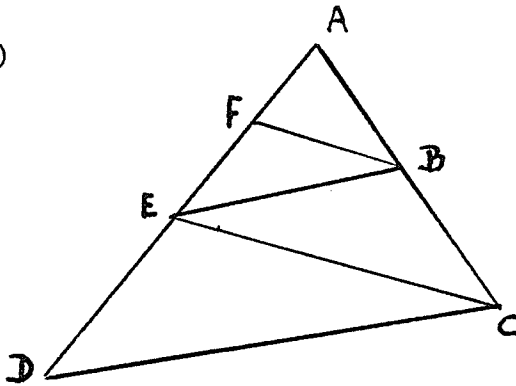
Given:  $\overline{FB} \parallel \overline{EC}$  $\overline{EB} \parallel \overline{DC}$ Prove:  $\frac{AF}{FE} = \frac{AE}{ED}$ 

(h)

5

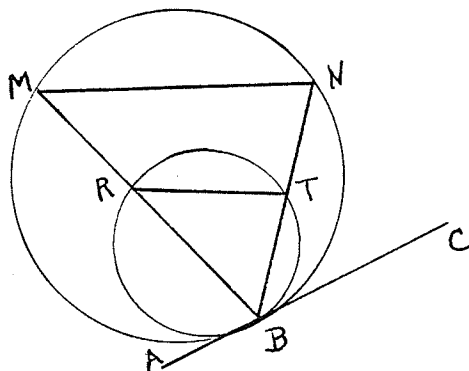
Given:  $AC$  is a tangent to the circle at  $B$ Prove:  $\frac{BR}{BM} = \frac{RT}{MN}$

(i)

5

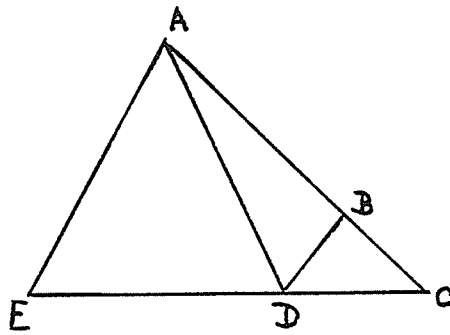

Given:  $\overline{AE} \cong \overline{AC}$ ,  $\overline{BD} \cong \overline{BC}$

$\overline{BD}$  bisects  $\angle ADC$

Prove:  $\angle ADE \cong \angle DBC$

(j)

5

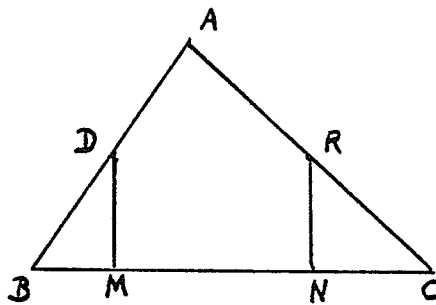

Given: D and R are midpoints of  $\overline{AB}$  and  $\overline{AC}$  respectively.

$\overline{DM} \perp \overline{BC}$ ,  $\overline{RN} \perp \overline{BC}$

Prove:  $\overline{DM} \cong \overline{RN}$

(k)

5

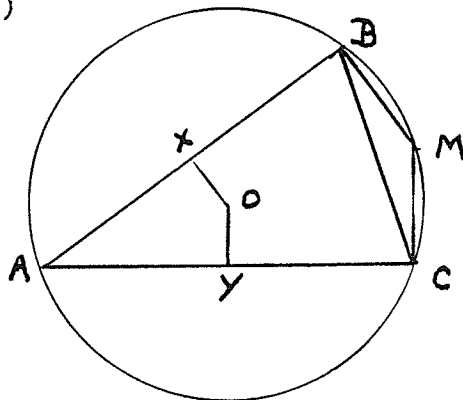

Given: Circle O,  $\overline{OX} \perp \overline{AB}$

$\overline{OY} \perp \overline{AC}$ ,  $OX = OY$

$\angle MBA \cong \angle MCA$

Prove:  $\overline{BM} \cong \overline{CM}$

(1)

5

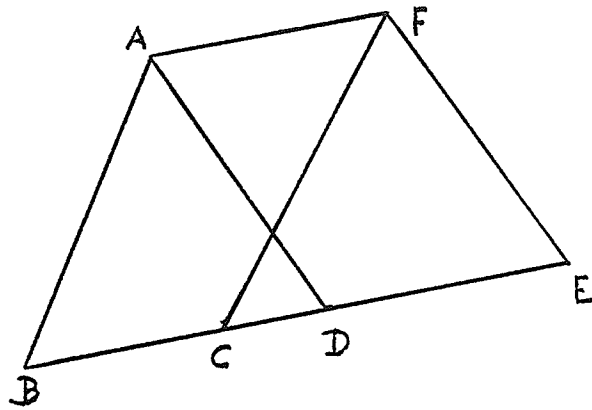

Given:  $\overline{EF} \parallel \overline{AD}$ ,  $\overline{AB} \parallel \overline{FC}$

$BC = DE$

Prove:  $\square AFCB$  is a //gm

(m)

5

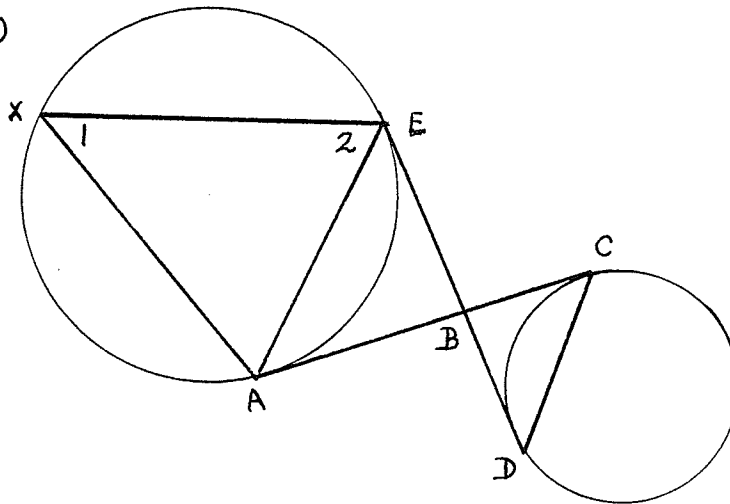

Given:  $\overline{ED}$  and  $\overline{AC}$  are tangent to both circles at E, D and A, C respectively.

$\angle 1 = \angle 2$

Prove:  $\frac{AB}{AX} = \frac{BD}{DC}$

June, 1977

Name \_\_\_\_\_

Time: 2 hrs.

Subject Teacher \_\_\_\_\_

No. of Pages: 7  
and 1 Graph Paper.

Values

Answers

1 I. 1) Express as a decimal  $\frac{3}{8}$  1) \_\_\_\_\_

1 2) Evaluate: (a)  $\frac{2^3 + 2^{-3}}{3^0}$  2) (a) \_\_\_\_\_

1 (b)  $(12^0 \cdot 3^{-1}) \cdot 4^{-2}$  (b) \_\_\_\_\_

1 3) Multiply: (a)  $(3ab^3c)(a^2c^3)$  3) (a) \_\_\_\_\_

2 (b)  $(-3m^3n^4p^5)^3$  (b) \_\_\_\_\_

3 4) Simplify, using positive exponents only.

$$\frac{-16 a^{-3} b^5 c^0}{24 a b^{-2} c^{-2}}$$

4) \_\_\_\_\_

II. Expand and simplify:

2 1)  $9x^2 + 5y - (8x^2 - 3x^2) + 2y$  1) \_\_\_\_\_

2 2)  $(a - 2b + c) + 9b - (4a + 3b + 5c)$  2) \_\_\_\_\_

2 3)  $(a + 3b)^2$  3) \_\_\_\_\_

3 4)  $(x - 2y)^2 - (2x - y)^2$  4) \_\_\_\_\_

III. Factor fully each of the following:

1 1)  $a - 4a^2$

2 2)  $y^2 + 9y + 18$

2      3)  $n^2 - 10n - 24$

2      4)  $16a^2 - b^2$

3      5)  $3a^2 + 15a + 18$

IV. Solve each of the following equations:

1      1)  $b - 6 = -16$

2      2)  $5 + 6a + 3a = 12 - 2a + 10a$

3      3)  $3(2 - 3a) + 4 = 5(a + 2)$

4      4)  $(a - 5)(a - 2) = (a + 1)(a - 4)$

V. (a) From the graph at the right, give the co-ordinates of each point below:

1½      A(      )

B(      )

C(      )

(b) Using the same graph in (a) above, name the point by its letter.

(2, 1) \_\_\_\_\_

1½      (-2, -3) \_\_\_\_\_

(4, -4) \_\_\_\_\_

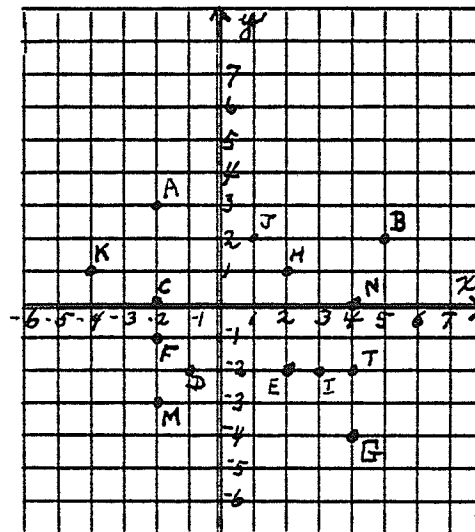

VI. Simplify:

2) 
$$1) \frac{8a^3b^3 - 9a^2b^2 + ab}{ab}$$

5) 
$$2) \frac{x^2 - 6x + 8}{x^2 - 4} \cdot \frac{6x - x^2}{x^2 - 10x + 24} \cdot \frac{x + 2}{x}$$

7) 
$$3) \frac{x^2 - 5x + 6}{x^2 - 9} \cdot \frac{x^2 + 4x + 3}{x^2 - x - 2} \div \frac{x^2 - 5x - 6}{x^2 - 6x}$$

VII. 1) On the graph paper provided, write the equation  
 $2x + y + 4 = 0$  and make a table of three pairs of values.

3) Draw the graph.

2) On the same graph paper as in (1) write the equation  
 $x - y - 1 = 0$  and make a table of three pairs of values.

3) Draw the graph.

1) 3) From the graph, state the intersection point of the two lines.

VIII. Solve the following systems of equations, using algebra:

4) 
$$1) \begin{aligned} 3y - 8z &= -13 \\ -2y &= 7 - 12z \end{aligned}$$

4) 
$$2) \begin{aligned} \frac{3x + y}{3} &= -1 \\ \frac{x + 3}{y} &= -1 \end{aligned}$$



IX. KINDS OF CARS SOLD

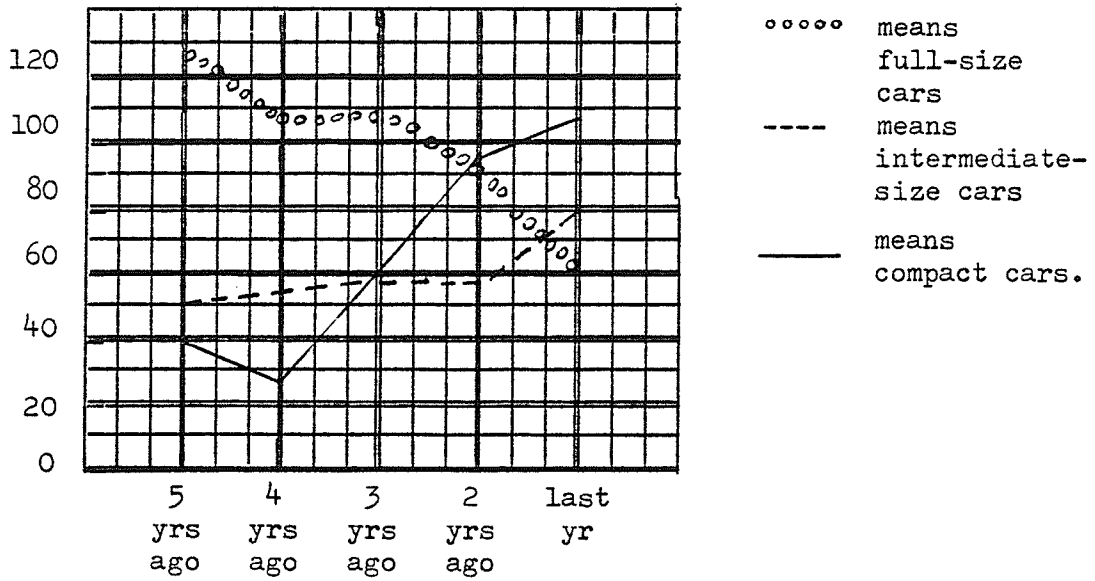

1) Which type of car was the best seller five years ago?

How many cars was that? \_\_\_\_\_

3

2) What was the total number of cars sold last year? \_\_\_\_\_

3) When did the compact cars begin to sell better than the full-size cars? \_\_\_\_\_

4) When did the compact cars begin to sell better than the intermediate-size cars? \_\_\_\_\_

X. Simplify:

1

1)  $\sqrt{54}$

2

2)  $\sqrt{18x^3y^5}$

2

3)  $\sqrt{3} \cdot \sqrt{6}$

1

4)  $\frac{6\sqrt{10}}{\sqrt{2}}$

1

5)  $3\sqrt{3} (\sqrt{8} + 2\sqrt{2})$

3

6)  $3\sqrt{72} + \sqrt{75} - 3\sqrt{3} - 7\sqrt{18}$

3

7)  $3\sqrt{54} - \sqrt{108} - 2\sqrt{120} \div \sqrt{24}$

XI.

(USE  $\pi = 3.14$ )

(1)

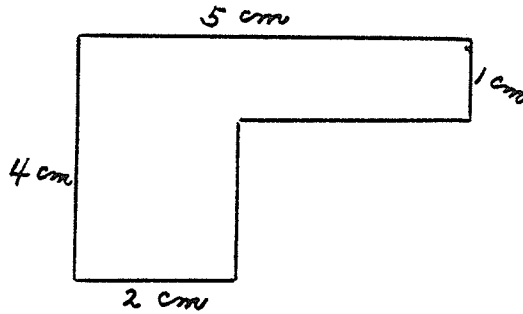

(2)

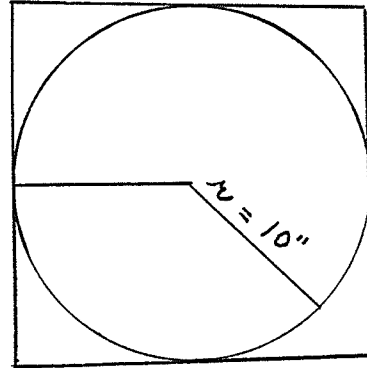

Perimeter

Area of shaded region:

(1+3)

Area

(5)

(3)

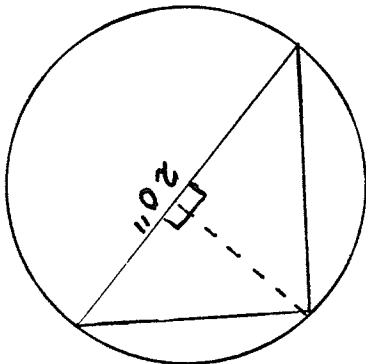

(4)

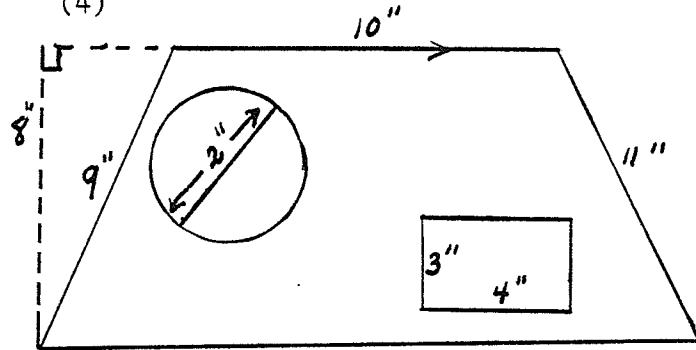

Circumference of circle

Perimeter of trapezoid:

(2+5)

Area of shaded region:

Area of shaded region:

(1+6)

XII. An oil storage tank 48 feet high and 24 feet in diameter, is  $\frac{3}{4}$  full of oil. Calculate the

5

number of gallons of oil in the tank if one cubic foot of oil contains 6.25 gallons.

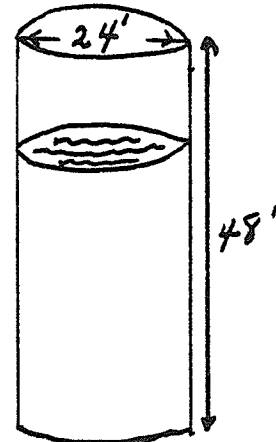

- XIII. Determine the actual cost of painting the ceiling and walls of a room 18' wide x 22' long and 9' high. The room has one door 3' wide x 7' high and two windows, each 4' wide x 3' high.

6

The walls are to be painted yellow and 1 gallon covers 600 sq. ft and costs \$12.00 per gallon.

3

The ceiling is to be painted white and 1 quart covers 150 sq. ft. and costs \$3.50 per quart.

The floor will be carpeted and will not require painting.

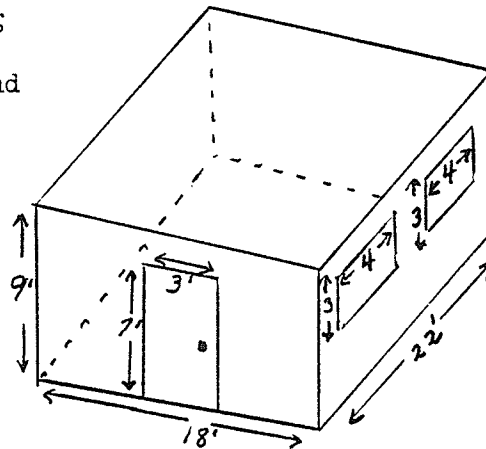

(READ EACH OF THE FOLLOWING PROBLEMS CAREFULLY. SET-UP THE EQUATION(S) AND SOLVE)

- XIV. A box contains three times as many bolts as wrenches. There are 48 bolts and wrenches in all. How many bolts are there?

3

- XV. Karen is twice as old as Lori. Three years from now, the sum of their ages will be 42. How old is Karen?

5

XVI. A jacket and a pair of shoes cost \$30.50 in all. The jacket cost \$21 more than the shoes. How much did the jacket cost?

4

XVII. Connie invested \$2,000 part at 4% and the rest at 9%. Her money earned \$120 in one year. How much money was invested at each interest rate?

5

XVIII. The width of a rectangle is four feet less than the length. If the perimeter of the rectangle is 32 feet, what are its dimensions?

5

XIX. John bought a radio for \$120.00. He paid his bill with two dollar bills, and five dollar bills. If there were 30 bills in all, how many were there of each?

5

---

Total: 150

June, 1978

Name \_\_\_\_\_

Time: 2 hours

Teacher \_\_\_\_\_

Pages: 9

Mathematics 101

Value

1. Evaluate:

(a)  $-30 + (-6)$

(b)  $42 + (-7)$

(c)  $-28 - (+8)$

(d)  $-7 - (-3)$

(e)  $53 - (-6)$

(f)  $4^2 + 5^2$

(g)  $2/5 + 1/5$

(h)  $1/2 - 2/7$

(i)  $3/8 \times 4/9$

(j)  $5/7 \div 3/21$

(k)  $3.27 + 1.654$

(l)  $1.23 - 0.456$

(m)  $2.63 \times .04$

(n)  $7 \div 0.8$

(o) 30% of 25

(p)  $7\frac{1}{2}\%$  of 500

2. Simplify:

(a)  $(3x^2y - 2xy + 6xy^2) - (x^2y + 5xy^2 + 3xy)$

(b)  $(-6a^3b^2)(4a^2b^5)$

1

1

$$1 \quad (c) \quad (2c - 5)(3c + 2)$$

$$1 \quad (d) \quad -2(3d^3e^2)^2$$

$$1 \quad (e) \quad (3f - 1)^2$$

$$2 \quad (f) \quad (3g^2h^5)(4g^4h^4) - (2g^2h^3)^3$$

$$1 \quad (g) \quad \frac{-18j^5k^6l^2}{30j^3k^{10}}$$

$$2 \quad (h) \quad \frac{7m^2n^5}{mn^3} - \frac{12m^{10}n^{15}}{3m^8n^{13}}$$

$$2 \quad (i) \quad \frac{-24p^6q^3 + 12p^4q^2}{-3p^2q^2}$$

$$2 \quad (j) \quad \frac{r^2 - 4r - 5}{r^2 - 2r - 3}$$

$$3 \quad (k) \quad \frac{4 - 2s}{s^2 - 4} \cdot \frac{1 - s}{s^2 - 1}$$

$$4 \quad (l) \quad \frac{t^2 - 10t + 25}{t + 3} \cdot \frac{t^2 - t - 20}{t^2 + 7t + 12}$$

$$2 \quad (m) \quad \frac{3u + 1}{4u} + \frac{u + 3}{4u}$$

$$3 \quad (n) \quad \frac{6}{v^2} - \frac{5w}{3v} + \frac{4w}{6wv^2}$$

4 (o)  $\frac{x+1}{8x} - \frac{3x-1}{12x} + \frac{1}{6x}$

1 (p)  $\sqrt{25y^2}$

1 (q)  $\sqrt{75}$

1 (r)  $\sqrt{15a^2z^2}$

1 (s)  $\sqrt{125b^3c^5}$

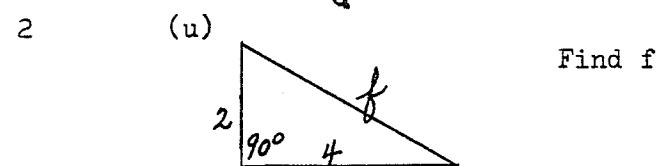
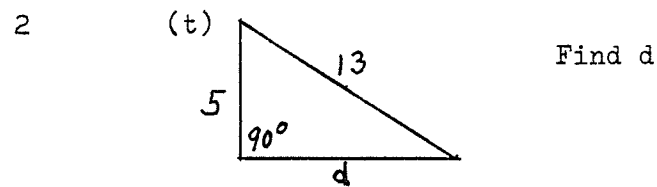

3. Factor completely:

1 (a)  $55e^2f^2 - 22e^2f + 44ef^5$

1 (b)  $g^2 + g - 20$

1 (c)  $16h^2 - 25j^2$

2 (d)  $3k^2 - 30k + 75$

2 (e)  $16l^4 - m^4$

4. Solve

2 (a)  $2(n + 4) = 2(n - 4) + 4n$

3 (b)  $\frac{p + 5}{p - 1} = \frac{p - 3}{p - 5}$

3 (c)  $\frac{q - 1}{2q} + \frac{q + 3}{4q} = \frac{5}{8}$

2 (d)  $0.025r - 0.05(20 - 2r) = 0.2$

1 (e)  $s^2 - 5 = 31$

5. Solve the following system of equations:

3  $4x - y = -1$  and  $2y - 7x = 4$

4 6. Find the perimeter and area of the figure below:

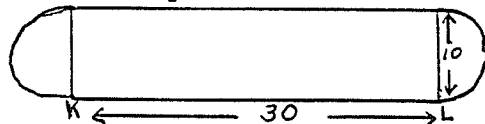

2 7. Find the volume of the figure below:

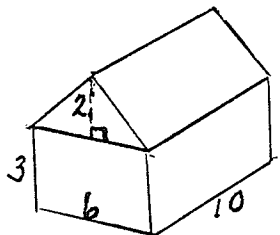



3 8. (a) Using the graph paper provided, find the point of intersection of the lines  $x + 2y = 3$  and  $3y + 4x = 2$

5 (b) This is a distance versus time graph for two greyhounds as they race around a 100 meter track.

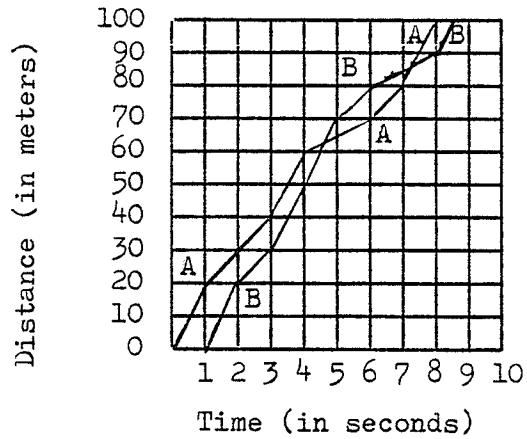

- i) Which dog took the lead at the start of the race? \_\_\_\_\_
- ii) How long did it take the other dog to leave the gate? \_\_\_\_\_
- iii) How many times during the race did dog A slow down? also dog B? (dog A \_\_\_\_\_) (dog B \_\_\_\_\_)
- iv) Who was leading at the 5 second mark? \_\_\_\_\_
- v) When did B overtake A? \_\_\_\_\_ When did he lose the lead again? \_\_\_\_\_
- vi) Who won the race? \_\_\_\_\_ By how much? \_\_\_\_\_

9. Problems: (show your work)

4 (a) Last week-end a few of us went bow-fishing and returned with 78 fish. If the ratio of suckers to carp was 8 to 5, then how many of each did we have?

- 5 (b) On the Saturday of their opening week-end the owners of the Mount Evergreen Ski Resort sold 300 lift tickets and rented 75 sets of equipment for a total of \$2,100. On Sunday they sold 250 tickets and rented 60 sets of equipment to take in \$1,730. What is the price of a lift ticket and a set of equipment?
- 5 (c) John Landlord made \$20,000 last year by renting out his apartment block. He has invested part of this amount at 6% interest in the Knock-It-Down Destruction Company which he has hired to demolish his old block. He has invested the rest at  $7\frac{1}{2}\%$  in the Put-It-Up Construction Company which will build his new block, Make-Me-Rich Towers. If his total interest is \$1,380, how much was invested in each company?
- 5 (d) Joe Moonshine (John Landlord's brother-in-law) made his fortune by selling boot-leg whiskey during the "Roaring Twenties". He added water to liquor which was 40% alcohol to make it 25% alcohol, but then sold it as 40% alcohol. How much water would be added to 20 gallons of 40% liquor to reduce it to 25% ?

## Appendix B: Raw Data Samples I, II, and III

Table A  
Raw Data Sample I

Student Number <sup>a</sup>	NA	SR	DOM	OTIS	HN	VR	VR + NA	AR	Math Mark	Sex <sup>b</sup>
7100001	85	80	90	117	114	85	90	70	84	1
7100002	90	50	80	101	103	45	65	70	37	0
7100003	80	55	75	100	115	85	85	15	65	0
7100004	60	40	80	117	119	70	70	90	71	1
7100005	75	55	45	114	123	80	80	50	84	0
7100006	75	85	40	095	101	85	80	80	73	1
7100007	55	35	55	108	120	65	60	55	87	0
7100008	65	90	95	137	130	70	70	90	82	1
7100009	95	50	90	120	115	85	90	90	83	1
7100010	80	80	90	114	119	85	85	55	87	1
7100011	80	15	60	116	116	45	60	45	75	0
7100012	70	25	70	104	116	60	65	75	55	0
7100013	90	65	80	104	119	80	85	50	93	0
7100014	80	70	70	116	114	65	75	80	63	1
7100015	65	80	30	103	118	45	55	95	62	0
7100016	90	80	80	107	127	90	90	60	83	0
7100017	80	30	35	100	117	40	55	35	48	0
7100018	55	15	65	098	116	40	50	35	60	1
7100019	40	70	65	097	110	50	45	40	67	1
7100020	90	35	85	101	119	65	75	55	73	1
7100021	75	45	85	111	112	85	80	97	85	1
7100022	55	35	65	095	099	70	60	50	59	1
7100023	95	95	90	103	113	65	85	60	85	0
7100024	80	90	65	111	111	70	75	85	80	0
7100025	35	35	65	090	121	35	30	20	70	1
7100026	70	80	80	096	108	50	60	90	82	0
7100027	90	90	90	109	126	85	85	97	80	1
7100028	55	75	45	109	114	50	55	75	69	1
7100029	70	90	90	095	117	65	70	65	86	1
7100030	85	30	80	097	116	70	80	45	80	1
7100031	95	99	95	126	122	95	95	85	60	1
7100032	95	90	95	116	118	95	95	95	87	0

<sup>a</sup>First digit of student number differentiates between 1977 and 1978 grade ten mathematics students. Second, third, and fourth digits identify mathematics course number. Fifth, sixth, and seventh digits signify subject number of a given course and year.

<sup>b</sup>Male = 1 and female = 0.

Table A continued

Student Number	NA	SR	DOM	OTIS	HN	VR	VR + NA	AR	Math Mark	Sex
7100033	95	80	95	090	125	97	95	90	96	1
7100034	65	10	80	108	129	55	60	35	74	1
7100035	70	80	90	135	124	90	85	80	70	1
7100036	90	97	90	111	126	90	90	95	68	1
7100037	97	10	90	100	123	97	99	65	59	1
7100038	35	5	40	084	089	25	30	20	13	1
7100039	60	40	5	105	095	25	40	75	57	1
7100040	97	97	90	120	124	80	90	95	86	0
7100041	85	50	80	100	111	50	65	85	67	1
7100042	85	50	85	109	122	55	80	85	72	0
7100043	60	25	45	116	106	40	50	75	50	0
7100044	65	97	80	122	106	65	65	80	73	0
7100045	75	50	75	091	108	45	60	40	86	1
7100046	97	90	85	116	123	85	95	85	91	1
7100047	75	85	95	130	120	75	75	80	84	0
7100048	50	95	80	129	121	65	60	85	80	1
7100049	65	70	80	103	119	90	80	40	82	1
7100050	70	60	75	083	109	65	65	70	64	0
7100051	85	85	85	105	115	45	65	75	73	0
7100052	97	75	85	112	108	75	90	03	68	1
7100053	70	20	75	103	119	60	65	60	63	0
7100054	75	75	80	107	111	85	85	85	70	0
7100055	85	50	50	083	109	70	80	45	83	1
7100056	90	85	85	090	120	80	85	99	85	0
7100057	90	55	65	111	101	70	85	80	87	1
7100058	80	95	90	101	112	85	85	95	85	1
7100059	55	60	65	096	113	50	50	30	70	1
7100060	97	50	40	095	113	45	75	45	72	1
7100061	90	90	95	141	132	97	99	90	81	1
7100062	95	55	85	119	122	95	95	90	50	0
7100063	45	85	80	084	110	15	35	15	79	0
7100064	65	30	35	101	104	15	50	35	70	1
7100065	90	45	75	100	116	75	80	40	78	0
7100066	75	60	70	094	107	70	70	30	44	0
7100067	75	85	85	117	116	70	70	65	66	0
7100068	80	60	85	104	124	75	80	60	59	0
7100069	95	45	55	091	122	70	80	55	75	0
7100070	80	30	25	077	096	25	55	10	66	1
8100001	60	90	45	119	113	50	55	70	55	0
8100002	55	60	40	089	112	30	40	60	33	0
8100003	40	45	70	098	102	75	65	60	62	0
8100004	55	80	75	112	121	60	55	97	46	0
8100005	55	20	45	097	118	50	50	60	50	0
8100006	70	75	70	114	120	85	85	65	73	0
8100007	80	99	85	096	127	90	90	95	72	1
8100008	85	60	90	108	125	97	97	65	60	0
8100009	75	85	85	119	121	70	70	95	63	0

Table A continued

Student Number	NA	SR	DOM	OTIS	HN	VR	VR + NA	AR	Math Mark	Sex
8100010	50	60	75	105	119	50	50	80	54	1
8100011	55	50	80	097	114	45	50	85	52	0
8100012	55	15	30	100	106	30	40	20	46	1
8100013	97	95	95	124	124	97	99	90	94	0
8100014	85	60	85	109	113	80	85	85	77	0
8100015	75	50	60	100	110	60	70	90	81	1
8100016	20	20	65	095	103	30	20	35	48	1
8100017	55	60	80	104	116	75	70	80	92	0
8100018	85	90	80	116	112	99	95	80	95	1
8100019	95	30	85	112	119	85	90	65	64	0
8100020	70	90	35	114	110	55	60	80	56	1
8100021	70	80	55	117	114	40	55	90	65	0
8100022	97	60	95	120	125	97	97	75	74	0
8100023	50	35	75	104	120	65	55	90	60	0
8100024	30	55	65	116	108	75	55	35	62	1
8100025	95	95	55	098	113	85	90	95	88	0
8100026	90	75	85	117	124	80	85	95	71	0
8100027	90	85	75	133	126	55	70	75	77	0
8100028	80	35	85	117	117	80	85	95	75	1
8100029	65	60	55	103	114	65	65	75	77	1
8100030	40	95	85	101	101	55	45	80	56	0
8100031	99	97	95	124	129	95	97	90	99	0
8100032	40	45	25	105	108	10	25	35	43	1
8100033	80	60	90	126	129	90	85	70	65	1
8100034	55	85	80	103	107	60	55	70	59	0
8100035	70	30	70	094	097	50	60	35	56	1
8100036	55	80	85	100	112	75	70	80	62	0
8100037	65	25	75	095	108	65	65	85	83	1
8100038	80	80	50	109	103	65	70	95	91	0
8100039	70	30	55	128	113	80	80	80	80	1
8100040	75	65	65	109	114	65	70	70	61	1
8100041	55	45	60	090	109	20	35	35	56	0
8100042	45	55	10	100	105	50	50	35	56	1
8100043	97	60	85	094	105	55	80	95	84	1
8100044	90	80	85	116	117	75	85	85	82	0
8100045	70	35	70	111	118	75	75	85	52	0
8100046	55	95	75	108	093	65	60	85	69	0
8100047	97	90	80	109	120	85	95	95	96	1
8100048	85	45	65	101	112	70	80	90	72	0
8100049	60	60	60	122	115	55	60	95	80	0
8100050	80	50	95	116	123	85	85	90	69	1
8100051	70	25	75	103	106	60	65	80	62	1
8100052	75	97	85	114	114	95	90	85	96	1
8100053	85	80	90	107	121	90	90	95	64	0
8100054	60	75	50	124	108	75	70	95	67	0
8100055	85	85	90	119	116	85	85	95	77	0
8100056	45	60	85	107	113	80	70	65	40	0

Table A continued

Student Number	NA	SR	DOM	OTIS	HN	VR	VR + NA	AR	Math Mark	Sex
8100057	60	60	70	087	114	55	55	40	73	1
8100058	70	60	60	105	114	45	55	95	64	1
8100059	95	75	75	105	113	90	95	75	80	1
8100060	60	35	70	098	110	30	40	80	57	0
8100061	97	95	80	117	102	65	85	85	86	1
8100062	65	35	40	087	105	65	65	75	48	1
8100063	85	85	85	101	122	97	95	97	86	0
8100064	90	60	80	108	115	70	80	95	62	0
8100065	75	10	90	112	116	85	85	70	67	1
7101001	65	55	40	097	101	15	20	01	68	1
7101002	15	65	25	105	095	30	15	35	51	0
7101003	20	40	20	082	102	20	20	25	27	1
7101004	95	75	90	114	123	70	85	60	92	0
7101005	45	35	60	103	110	40	40	25	68	0
7101006	95	97	95	108	117	90	95	90	85	1
7101007	40	30	30	081	112	10	20	10	50	1
7101008	90	45	70	116	107	65	75	35	77	1
7101009	40	10	35	096	100	60	50	25	52	0
7101010	65	35	65	085	107	20	40	55	73	0
7101011	80	35	65	112	114	65	65	40	84	0
7101012	15	25	45	097	106	30	15	40	57	0
7101013	35	25	50	104	119	35	35	15	64	0
7101014	45	20	15	100	091	15	25	35	39	0
7101015	35	20	85	117	115	55	50	55	76	0
7101016	65	90	55	105	099	55	55	75	87	0
7101017	40	45	45	082	097	25	30	15	75	0
7101018	45	25	30	097	106	15	25	15	45	1
7101019	45	30	05	083	103	25	35	25	26	1
7101020	50	15	10	083	106	35	40	10	42	1
7101021	80	20	30	105	116	05	45	50	73	1
7101022	70	75	65	109	103	35	50	60	57	1
7101023	20	60	35	091	099	25	20	40	31	1
7101024	45	05	30	100	103	01	25	20	59	1
7101025	65	55	50	097	108	55	60	60	47	1
7101026	45	20	65	090	116	40	40	25	72	1
7101027	75	60	80	126	121	85	85	65	88	0
7101028	35	10	85	096	114	60	50	60	07	0
7101029	10	30	50	095	108	55	30	20	11	1
7101030	85	45	85	111	115	30	70	15	30	1
7101031	60	05	25	096	110	60	60	20	39	0
7101032	50	85	35	107	097	60	55	65	46	1
7101033	60	60	80	104	122	65	65	45	82	0
7101034	65	30	25	087	106	10	35	45	66	0
7101035	60	20	35	094	105	40	50	30	34	0
7101036	30	40	35	103	125	35	30	30	43	0
7101037	80	35	90	117	106	50	60	40	55	0

Table A continued

Student Number	NA	SR	DOM	OTIS	HN	VR	VR + NA	AR	Math Mark	Sex
7101038	80	75	90	109	116	40	60	70	57	0
7101039	40	35	50	096	099	35	35	35	60	1
7101040	60	70	55	103	110	45	50	80	80	0
7101041	75	70	80	112	121	50	60	90	54	0
7101042	45	45	65	101	101	15	35	15	69	0
7101043	35	85	45	098	097	70	55	65	20	1
7101044	35	60	70	111	074	50	45	40	23	1
7101045	65	10	55	103	107	45	55	40	19	1
7101046	45	50	60	103	098	20	30	30	53	1
7101047	65	75	45	092	098	40	50	25	75	0
8101001	55	45	80	105	112	55	55	60	65	0
8101002	45	60	15	097	099	05	20	05	33	1
8101003	80	20	65	126	128	75	80	65	48	1
8101004	35	30	10	082	102	40	35	20	67	1
8101005	25	35	30	096	101	05	10	40	45	1
8101006	40	25	10	101	093	30	35	70	63	0
8101007	15	60	55	087	093	45	25	30	54	1
8101008	70	50	40	104	112	30	50	70	78	0
8101009	40	70	40	090	096	70	60	30	67	1
8101010	55	55	60	089	082	50	50	35	72	1
8101011	30	40	20	095	090	55	40	10	25	0
8101012	65	75	50	119	103	50	55	85	64	0
8101013	45	30	10	098	108	15	25	25	49	1
8101014	45	10	65	094	118	60	60	10	28	0
8101015	40	20	60	085	097	30	30	10	50	1
8101016	55	20	50	101	108	35	45	20	58	0
8101017	15	45	10	089	101	30	20	30	15	1
8101018	20	60	75	096	103	80	60	55	64	0
8101019	45	15	55	085	103	45	45	25	51	1
8101020	15	35	20	094	086	50	30	25	28	1
8101021	80	45	30	080	103	30	55	60	46	1
8101022	15	05	25	085	097	20	15	10	52	1
8101023	25	15	70	117	118	65	50	20	28	1
8101024	50	55	55	082	116	45	45	75	55	0
8101025	25	45	40	117	109	50	35	40	47	1
8101026	70	20	70	094	114	05	35	25	80	0
8101027	70	75	65	095	114	65	70	65	66	0
8101028	40	30	40	098	099	35	35	20	41	1
8101029	35	20	40	094	107	35	35	10	36	1
8101030	30	65	30	108	108	10	15	35	51	0
8101031	55	90	80	111	102	70	60	75	74	0
8101032	40	20	65	122	118	55	50	55	25	0
8101033	30	30	55	080	111	60	45	70	49	1
8101034	40	05	10	097	104	35	35	25	53	0
8101035	60	05	05	091	099	10	35	50	44	1
8101036	35	50	20	082	102	10	20	25	32	1
8101037	50	45	70	105	123	75	70	35	49	0

Table A continued

Student Number	NA	SR	DOM	OTIS	HN	VR	VR + NA	AR	Math Mark	Sex
8101038	10	30	50	095	108	55	30	20	25	1
8101039	30	10	20	094	099	20	20	15	26	1
8101040	35	85	45	098	097	70	55	65	27	1
7102001	70	75	55	090	101	65	70	65	73	0
7102002	30	20	25	105	102	30	25	40	74	0
7102003	55	75	80	107	117	70	65	80	67	0
7102004	10	10	10	094	099	03	03	10	37	0
7102005	20	45	15	088	096	15	15	10	32	1
7102006	30	25	45	088	101	20	20	25	53	0
7102007	35	15	20	088	104	50	40	25	55	0
7102008	30	40	30	094	092	05	10	50	41	1
7102009	15	10	45	107	094	35	20	10	58	1
7102010	25	55	30	094	099	35	25	30	52	1
7102011	55	85	65	122	123	75	70	60	71	1
7102012	55	15	45	101	095	15	30	70	70	1
7102013	15	35	35	078	089	03	05	15	51	0
7102014	45	45	70	104	109	65	55	55	66	1
7102015	05	05	40	080	094	20	10	10	35	0
7102016	15	01	10	070	084	05	05	05	31	1
8102001	45	75	85	101	112	90	75	25	51	0
8102002	10	55	10	107	094	30	15	50	60	0
8102003	25	60	40	129	111	30	25	60	23	0
8102004	80	80	50	091	112	50	60	50	77	0
8102005	35	40	05	089	093	05	15	20	53	1
8102006	20	20	15	081	095	25	20	03	61	0
8102007	20	40	50	115	118	30	20	25	63	0
8102008	25	35	05	073	088	01	01	30	50	1
8102009	20	55	40	103	117	35	25	20	68	1
8102010	10	40	15	095	106	25	10	10	62	0
8102011	25	25	50	119	111	50	35	65	72	0
8102012	55	35	75	119	118	25	40	40	80	0
8102013	40	80	40	095	110	65	55	45	79	0
8102014	35	20	35	087	107	35	30	20	50	0
8102015	15	45	25	083	085	05	10	35	67	1
8102016	10	20	65	105	103	50	25	20	37	0
8102017	10	60	65	105	106	55	30	40	58	1
8102018	20	45	25	092	106	15	15	30	64	0
8102019	40	60	25	095	109	03	15	35	71	0



Table B  
Raw Data Sample II

Student Number <sup>a</sup>	NA	SR	VR + NA	Math Mark	Sex <sup>b</sup>
7100071		05	60	70	1
7100072		45	75	78	1
7100073		80	85	72	1
7100074		50	70	82	0
7100075		90	55	92	1
7100076		99	97	88	0
7100077		65	60	61	1
7100078		20	50	51	1
7100079		60	97	94	1
7100080		50	70	89	1
7100081		15	55	79	0
7100082		80	55	53	1
7100083		40	55	41	1
7100084		75	70	91	1
7100085		25	40	61	1
7100086		75	50	54	0
8100066		25	30	41	0
8100067		65	50	66	0
8100068		99	80	90	1
8100069		35	85	51	0
8100070		65	60	58	0
8100071		55	65	58	0
8100072		50	75	70	1
8100073		60	85	86	1
8100074		50	50	64	1
8100075		90	35	64	0
8100076		35	80	60	0
7101048	35			22	0
7101049	60			59	1

Note. Sample II contains all students in Sample I in addition to the students listed here.

<sup>a</sup>First digit of student number differentiates between 1977 and 1978 grade ten mathematics students. Second, third, and fourth digits identify mathematics course number. Fifth, sixth, and seventh digits signify subject number of a given course and year.

<sup>b</sup>Male = 1 and female = 0.

Table B -- Continued

Student Number	NA	SR	VR + NA	Math Mark	Sex
7101050	10			19	0
7101051	40			35	0
7101052	35			44	0
7101053	55			57	0
7101054	30			61	1
7101055	40			45	0
7101056	55			41	0
7101057	65			67	1
7101058	45			43	0
7101059	55			35	1
7101060	80			87	1
7101061	30			22	1
7101062	35			56	0
7101063	60			30	1
7101064	55			62	1
7101065	35			32	1
7101066	55			61	0
7101067	70			68	0
7101068	55			73	1
7101069	20			31	1
7101070	35			27	1
7101071	35			09	0
7101072	65			24	1
8101041	35			72	1
8101042	35			67	1
8101043	50			49	1
8101044	35			29	0
8101045	40			23	0
8101046	05			59	0
8101047	15			57	1
8101048	55			70	0
8101049	10			31	0
8101050	45			55	1
8101051	55			52	0
8101052	40			45	1
8101053	30			55	0
8101054	55			20	1
8101055	65			74	0
8101056	35			26	1
8101057	35			55	1
8101058	60			68	0
8101059	25			37	1
8101060	20			49	1
7102017	25			50	0
7102018	35			67	0

Table B -- Continued

---

Student Number	NA	SR	VR + NA	Math Mark	Sex
7102019	30			69	0
7102020	15			53	0
7102021	10			56	0
8102020	25			50	1
8102021	55			58	0
8102022	40			55	1
8102023	05			39	0
8102024	20			50	1
8102025	10			65	1
8102026	20			65	0
8102027	45			70	0
8102028	10			55	1
8102029	45			58	0

---

Table C  
Raw Data Sample III

Student Number <sup>a</sup>	NA	SR	VR + NA	Sex <sup>b</sup>
7100087		45	25	0
7100088		45	70	0
7100089		20	40	0
7100090		80	70	1
7100091		40	70	1
7100092		20	35	0
8100077		25	50	1
8100078		20	40	1
8100079		35	10	1
8100080		35	30	1
8100081		80	50	0
8100082		25	30	1
8100083		45	75	0
8100084		50	60	1
8100085		15	45	0
7101073	40			0
7101074	25			0
7101075	25			1
7101076	25			1
7101077	60			0
7101078	75			0
7101079	55			1
7101080	10			0
7101081	60			1
7101082	10			0
7101083	70			1
7101084	30			1
7101085	50			1
7101086	25			1

Note. Sample III contains only students with no math mark.

<sup>a</sup>First digit of student number differentiates between 1977 and 1978 grade ten mathematics students. Second, third, and fourth digits identify mathematics course number. Fifth, sixth, and seventh digits signify subject number of a given course and year.

<sup>b</sup>Male = 1 and female = 0.

Table C -- Continued

Student Number	NA	SR	VR + NA	Sex
7101087	55			1
8101061	15			1
8101062	35			1
8101063	75			1
8101064	30			1
8101065	30			0
8101066	10			0
8101067	10			1
8101068	35			1
8101069	03			1
7102022	05			1
7102023	25			1
7102024	50			0
7102025	15			0
8102030	15			1
8102031	01			1
8102032	25			0
8102033	15			0

## Appendix C: Supplementary Tables

Table D

Calculations Testing Significance of Differences Between Sexes for  
Correlation Coefficients between Math Mark and DAT Subtests

$$\underline{z} = \frac{(z_{r_1} - z_{r_2})}{\sqrt{V(n_1 - 3) + V(n_2 - 3)}}$$

$$\begin{aligned} \text{Math 100} \quad \underline{z} &= (.670 - .819) / \sqrt{V(79 - 3) + V(83 - 3)} \\ &= .930^* \end{aligned}$$

$$\begin{aligned} \text{Math 101} \quad \underline{z} &= (.551 - .457) / \sqrt{V(62 - 3) + V(70 - 3)} \\ &= .526^* \end{aligned}$$

$$\begin{aligned} \text{Math 102} \quad \underline{z} &= (.649 - .364) / \sqrt{V(32 - 3) + V(18 - 3)} \\ &= .896^* \end{aligned}$$

---

\* not significant at the .05 level.

Table E  
Breakdown of Total Number of Males Passing Math 100  
According to VR + NA and SR

V	80 - 100	2/2 (100%)	3/3 (100%)	6/6 (100%)	7/7 (100%)	18/18 (100%)
R	60 - 79	2/2 (100%)	5/6 (83%)	8/10 (80%)	5/5 (100%)	4/5 (80%)
+	40 - 59	1/2 (50%)	4/6 (67%)	4/5 (80%)	6/6 (100%)	2/2 (100%)
N	20 - 39	0/1 (0%)	1/4 (25%)	0/1 (0%)	. . .	. . .
A	0 - 19	. . .	0/1 (0%)	. . .	. . .	. . .
		0 - 19	20 - 39	40 - 59	60 - 79	80 - 100
		SR				

Note. Percentage refers to proportion of scores within a given cell. Total number includes those students who withdrew from a mathematics course (see Appendix A for Raw Data Sample III).

Table F  
Breakdown of Total Number of Females Passing Math 100  
According to VR + NA and SR

V	80 - 100	. . .	3/3 (100%)	6/6 (100%)	9/9 (100%)	13/13 (100%)
R	60 - 79	1/1 (100%)	4/4 (100%)	3/6 (50%)	5/7 (71%)	11/11 (100%)
+	40 - 59	1/2 (50%)	4/6 (67%)	1/1 (100%)	2/3 (67%)	5/7 (71%)
N	20 - 39	. . .	0/2 (0%)	1/2 (50%)	. . .	2/2 (100%)
A	0 - 19	. . .	. . .	. . .	. . .	. . .
		0 - 19	20 - 39	40 - 59	60 - 79	80 - 100
		SR				

Note. Percentage refers to proportion of scores within a given cell. Total number includes those students who withdrew from a mathematics course (see Appendix A for Raw Data Sample III).



Table G  
Breakdown of Males and Females Passing Math 102  
According to NA

NA	Males	Females
90 - 100	. . .	. . .
80 - 89	. . .	1/1 (100%)
70 - 79	. . .	1/1 (100%)
60 - 69	. . .	. . .
50 - 59	2/2 (100%)	3/4 (75%)
40 - 49	2/2 (100%)	5/5 (100%)
30 - 39	1/2 (50%)	6/6 (100%)
20 - 29	5/7 (71%)	6/8 (75%)
10 - 19	5/7 (71%)	5/9 (56%)
0 - 9	0/2 (0%)	0/2 (0%)

Note. Percentage refers to proportion of scores within a given cell. Total number includes those students who withdrew from a mathematics course (see Appendix A for Raw Data Sample III).

Note. Scores above the heavy line have a 50% or greater chance of passing.