

RESISTANCE TRAINING

Redesigning the North American Fitness Club to Challenge Dominant Narratives of Sex, Gender, & Sexuality

Corrie Allan • January 5, 2015

A practicum submitted to the Faculty of
Graduate Studies of the University of
Manitoba in partial fulfillment of the
requirements of the degree of

MASTER of INTERIOR DESIGN
Department of Interior Design,
University of Manitoba, Winnipeg

Copyright © 2015 by Corrie Allan

ACKNOWLEDGEMENTS

There are a lot of people to thank and a single page of recognitions will hardly do justice to their generosity but I will do my best.

Thanks first of all to my advisors Prof. Kelley Beaverford and Dr. Susan Close for pushing me further and reining me back in. I can't thank you enough for your patience, commitment, and expertise. This project would never have become what it is without your support.

To my internal examiner Dr. Lisa Landrum and my external Dr. Roewan Crowe, thank you for your insights and suggestions. Your input helped me understand my own project better by looking at it from different perspectives.

To the Rainbow Resource Centre, University of Winnipeg's LGBT* Centre, and University of Manitoba's Rainbow Pride Mosaic, thanks for your support and assistance in seeking interview participants.

Many thanks to Matraisa and Athena for taking time out to share your insights. They have been invaluable.

To John Pozios, for giving me an inside peek at the Manitoba Club, thank you for your time and knowledge.

To Nicola Mongelli of N-Plus Design, thank you for generously sharing your renderings for my precedent research.

I must also thank the provincial government for providing financial support through a Manitoba Graduate Scholarship.

Finally, three years of thanks are due to my classmates for their collaboration, commiseration, and celebration!

And to my friends & family for riding this roller coaster with me and listening on end to the sorrows and successes along the way.

This project would never have come to fruition without all of you!



ABSTRACT & KEYWORDS

ABSTRACT: North American building design is predicated on the notion that there are only two sexes, genders, and sexualities. With the former presumed to be the biological determinant of the latter, male and female are constructed as anatomical, behavioural, and aesthetic opposites. Queer theory and gender studies literature, however, articulate embodiments, expressions and desires that are neither binary nor fixed. This design seeks to acknowledge these alternative inhabitations by appropriating an exclusive Winnipeg building, the Manitoba Club, for use as a gender diverse fitness club. Exploring concepts of the body, queer space, and deconstruction, this practicum design questions the dominance of binary discourses.

KEYWORDS: Sex, Gender, Sexuality, Fitness, the Body, Queer Space, Deconstruction, the Manitoba Club, Interior Design

TABLE OF CONTENTS

Acknowledgements	i
Abstract & Keywords	ii
Table of Contents	iii
List of Tables	vi
List of Figures	vii
List of Copyrighted Material	xii
Chapter One. Introduction	1
1.0 Introduction	3
1.1 Research Questions	13
1.2 Biases & Limitations	15
1.3 Methodologies	17
1.4 Definition of Terms	21
1.5 Site Selection Criteria	28
1.6 Summary of Forthcoming Chapters	30
1.7 Chapter One Summary	33
Chapter Two. Literature Review	35
2.0 Introduction	37
2.1 Bodies	43
2.1.0 The ‘Fit’ Body: Gender and ‘Fitness’	45
2.1.1 Subversive Bodies	54
2.1.1.0 <i>Variant Bodies</i>	55
2.1.1.1 <i>De-Essentializing Sex</i>	57
2.1.2 Identity	58
2.1.2.0 <i>Simultaneity: Being Both Subject and Object</i>	59
2.1.2.1 <i>Multiplicity</i>	62

2.2	Queer Space	65
2.2.0	Subversive Re-appropriation: Queering Plato’s Chora	66
	2.2.0.0 <i>Liminality</i>	68
	2.2.0.1 <i>Fluidity</i>	69
2.2.1	Imminence	71
2.3	Deconstruction	73
2.3.0	Return of the Repressed	75
2.3.1	Performativity	78
	2.3.1.0 <i>The Ambiguity of Juxtaposition</i>	81
2.4	Chapter Two Summary	84
Chapter Three. Site & Building Analysis		89
3.0	Physical Characteristics	91
3.0.0	Site Overview: Opportunities & Constraints	93
3.0.1	Building Code	93
3.1	Architectonics	102
3.1.0	Architectural Language	103
3.1.1	Geometry & Proportion	114
3.1.2	Materials & Structure	116
3.2	Intangible Characteristics	117
3.2.0	History of the Men’s Club	117
3.2.1	Potential for Subversion	120
3.3	Chapter Three Summary	125
Chapter Four. Precedent Analysis		127
4.0	Introduction	129
4.1	David Barton Gym	130
4.2	The Centre-LGBT Community Centre	135
4.3	Quinte Sports & Wellness Centre	140
4.4	Chapter Four Summary	144
Chapter Five. Design		147
5.0	Introduction	149
5.1	Essential Programming	150
5.1.0	Interview Analysis	150

5.1.1	Programming	153
5.2	Concept Development	156
5.2.0	Spatial Concept	156
5.2.1	Hand Modelling Studies	158
5.3	Execution of Design	161
5.3.0	Introduction	161
5.3.1	Disrupting the Gaze	168
5.3.2	Imminence: Fluidity and Liminality	195
5.3.3	Juxtaposition	211
	5.3.3.0 <i>Space Planning</i>	212
	5.3.3.1 <i>Material Selections</i>	214
	5.3.3.2 <i>Furniture Placement</i>	217
5.4	Chapter Five Summary	221
Conclusions		223
6.0	Overall Summary	225
6.1	Challenges & Lessons Learned	226
6.2	Future Research Directions	228
6.3	Personal Reflections	230
Bibliography		234
Appendices		246
I.	Ethics Review	247
	<i>i. Interview Questions</i>	247
	<i>ii. Statement of Intent & Informed Consent</i>	249
	<i>iii. Invitation Posters</i>	264
II.	CORE Certificate	265
III.	Building Code Analysis	266
IV.	Personal Observation	273
V.	Programming	275

LIST OF TABLES

Table 1. Fitness Club Observations

211-212

Table 2. Programming

278-279

LIST OF FIGURES

Figure 1.	Manitoba Club – Location Map	90
Figure 2.	Manitoba Club – North View	92
Figure 3.	Manitoba Club – East View	92
Figure 4.	Manitoba Club – South View	92
Figure 5.	Manitoba Club – West View	92
Figure 6.	Map of Transportation and Parking	94
Figure 7.	Map of LGBT-friendly Resources and area Fitness Facilities	97
Figure 8.	Map of Landmarks	99
Figure 9.	Building Study: Grid – Original plans not under copyright, used with permission of the Manitoba Archives. Drawing generated by author	106
Figure 10.	Building Study: Structure – Original plans not under copyright, used with permission of the Manitoba Archives. Drawing generated by author	107
Figure 11.	Building Study: Symmetry & Balance – Original plans not under copyright, used with permission of the Manitoba Archives. Drawing generated by author	108
Figure 12.	Building Study: Plan Geometry – Original plans not under copyright, used with permission of the Manitoba Archives. Drawing generated by author.	109

Figure 13.	Building Study: Elevation Geometry – Original plans not under copyright, used with permission of the Manitoba Archives. Drawing generated by author.	109
Figure 14.	Building Study: Proportions – Original plans not under copyright, used with permission of the Manitoba Archives. Drawing generated by author.	110
Figure 15.	Building Study: Plan to Elevation – Original plans not under copyright, used with permission of the Manitoba Archives. Drawing generated by author.	111
Figure 16.	Building Study: Circulation to Use – Original plans not under copyright, used with permission of the Manitoba Archives. Drawing generated by author.	112
Figure 17.	Sketch of Tuscan columns	113
Figure 18.	Original Material Plans	115
Figure 19.	Rendering of The Centre by N-Plus Architecture and Design and RSVP Architecture Studio, used with permission of Nicola Mongelli, N-Plus Architecture and Design, as per email of April 15, 2014.	138
Figure 20.	Rendering of The Centre by N-Plus Architecture and Design and RSVP Architecture Studio, used with permission of Nicola Mongelli, N-Plus Architecture and Design, as per email of April 15, 2014.	138
Figure 21.	Rendering of The Centre by N-Plus Architecture and Design and RSVP Architecture Studio, used with permission of Nicola Mongelli, N-Plus Architecture and Design, as per email of April 15, 2014.	139
Figure 22.	Rendering of The Centre by N-Plus Architecture and Design and RSVP Architecture Studio, used with permission of Nicola Mongelli, N-Plus Architecture and Design, as per email of April 15, 2014.	139
Figure 23.	Image of Quinte Sports and Wellness Centre	142
Figure 24.	Image of Quinte Sports and Wellness Centre	142

Figure 25.	Image of Quinte Sports and Wellness Centre.	142
Figure 26.	Image of Quinte Sports and Wellness Centre	143
Figure 27.	Image of Quinte Sports and Wellness Centre	143
Figure 28.	Concept Drawings	157
Figure 29.	Physical Modelling Studies	158-159
Figure 30.	Site Plan	160
Figure 31.	East & West Exterior Elevations	162
Figure 32.	North & South Exterior Elevations	163
Figure 33.	South Exterior Rendering	164-165
Figure 34.	Retained Elements Plan	167
Figure 35.	Main Floor Plan - Intervention	170-171
Figure 36.	Second Floor Plan - Intervention	172-173
Figure 37.	Third Floor Plan - Intervention	174-175
Figure 38.	Attic Plan – Intervention	176-177
Figure 39.	Locker Room Elevation	1178
Figure 40.	Drapery Details	179
Figure 41.	Drapery Details	180
Figure 42.	Material Suggestions	182

Figure 43.	Locker Room Plan	184
Figure 44.	Locker Room Rendering	185
Figure 45.	Café Elevation	186-187
Figure 46.	Furniture Style Suggestions	187
Figure 47.	Café Rendering	189
Figure 48.	Workout Room Elevation	190-191
Figure 49.	Dressing Table Details	192-193
Figure 50.	Group Fitness Studio, Bodies in motion	194
Figure 51.	Main Floor Ceiling Height & Reflected Ceiling Plan	196
Figure 52.	Second Floor Ceiling Height & Reflected Ceiling Plan	196
Figure 53.	Third Floor Ceiling Height & Reflected Ceiling Plan	197
Figure 54.	Attic Ceiling Height & Reflected Ceiling Plan	197
Figure 55.	Section 2	198
Figure 56.	Section 1	200
Figure 57.	Main Floor Gallery Corridor Rendering	201
Figure 58.	Main Floor Gallery Corridor Elevation	202-203
Figure 59.	Section 3	202
Figure 60.	West Café Corridor Rendering	204

Figure 61.	Group Fitness Configurations	205
Figure 62.	Locker Room/Lounge Furniture Placement	206
Figure 63.	Main Floor Reception Details	207
Figure 64.	Main Floor Reception Details	208
Figure 65.	Third Floor Track Rendering	210
Figure 66.	Third Floor Terrace Plan	212
Figure 67.	West Exterior Rendering	213
Figure 68.	Workout Equipment Distribution Plan	218
Figure 69.	Building Permeability	219
Figure 70.	Exterior Rendering Southeast	220
Figure 71.	Interview Invitation Poster	264
Figure 72.	Course on Research Ethics Certificate of Completion	265
Figure 73.	Adjacent Building Heights	275
Figure 74.	Map of Land Use	276
Figure 75.	Spatial Adjacency Matrix	280
Figure 76.	Zoning	281

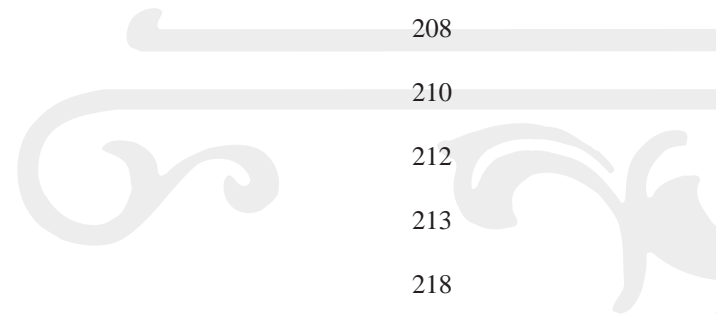

LIST OF COPYRIGHTED MATERIAL

Figure 19.	Rendering of The Centre by N-Plus Architecture and Design and RSVP Architecture Studio, used with permission of Nicola Mongelli, N-Plus Architecture and Design, as per email of April 15, 2014.	138
Figure 20.	Rendering of The Centre by N-Plus Architecture and Design and RSVP Architecture Studio, used with permission of Nicola Mongelli, N-Plus Architecture and Design, as per email of April 15, 2014.	138
Figure 21.	Rendering of The Centre by N-Plus Architecture and Design and RSVP Architecture Studio, used with permission of Nicola Mongelli, N-Plus Architecture and Design, as per email of April 15, 2014.	139
Figure 22.	Rendering of The Centre by N-Plus Architecture and Design and RSVP Architecture Studio, used with permission of Nicola Mongelli, N-Plus Architecture and Design, as per email of April 15, 2014.	139

CHAPTER ONE

INTRODUCTION

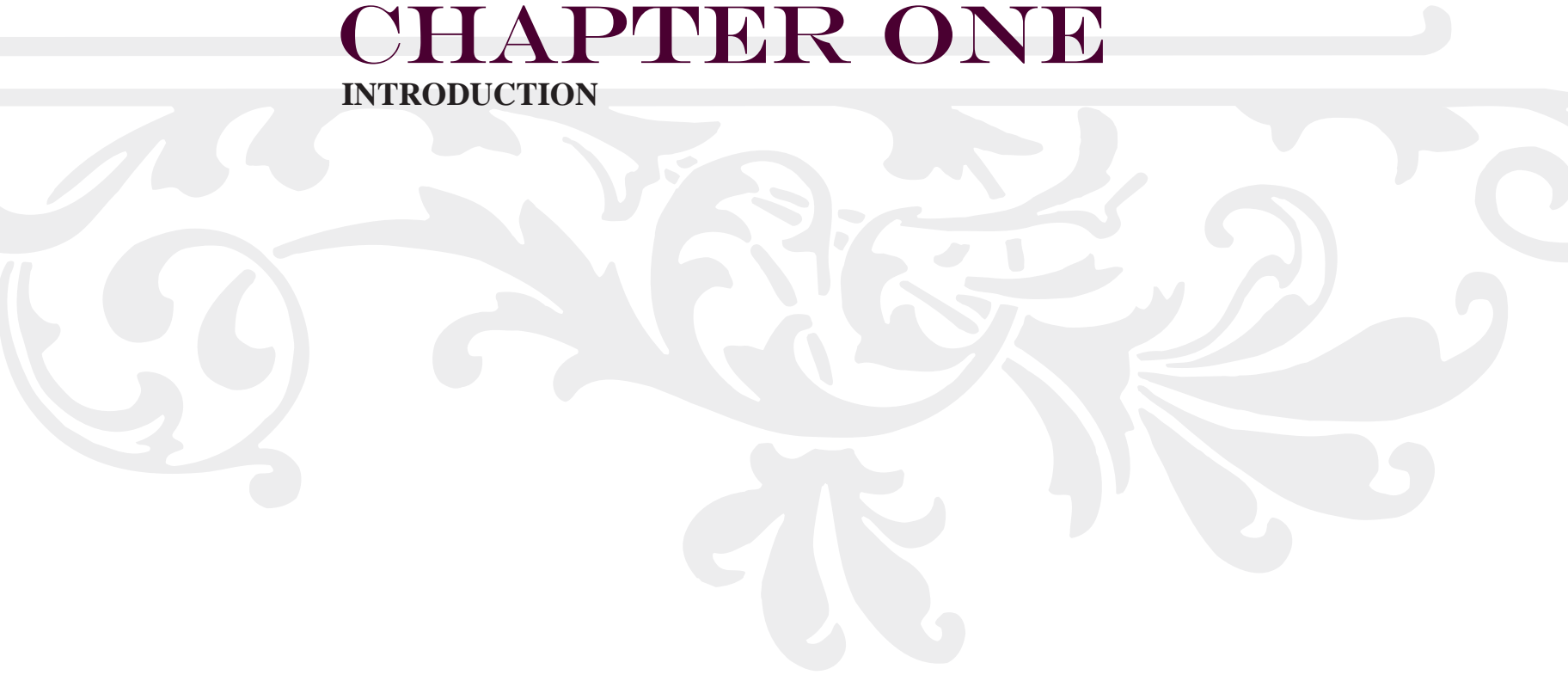

1.0 Introduction

There is an increasing body of evidence confirming that physical, mental, and emotional health are mutually dependent. (Government of Ontario 2013; Statistics Canada 2013) Thus, by providing, not only a venue for exercise, but an increasing number of other health services including athletic and massage therapy, various types of body image and nutrition related counselling, and relaxation facilities such as saunas and steam rooms, fitness clubs have the capacity to improve wellness on a multitude of levels. These benefits are only available, however, to those for whom the club is accessible, or in other words, only in so far as the club design is inclusive of a multiplicity of user

groups.

Sometimes inclusivity means questioning conventional definitions of these user groups. One of the primary ways that occupants are defined in design projects, and by society more generally, is by gender. Despite Ian Johansson's observation that what "makes the gym interesting is the fact that it is a social space in which young people are occupied with maintaining gender stereotypes, while at the same time new gender and body identities are developed" (Johansson 1996), the fitness club remains a space that largely reinforces heteronormative, biological determinist conceptions

of sex and gender as either/or categories that apply only to specific configurations of bodies, expressions and desires (Dworkin and Wachs 2009; Fusco 2006; Ian 1996; Leeds Craig and Liberti 2007). That being the case, the fitness industry based on my research and personal experience, is open only to “new gender and body identities” (Johansson 1996) that fall within binary conceptions of sex and gender. The aim of this project, being undertaken to satisfy one of the degree requirements of the University of Manitoba’s Master of Interior Design program, is to conceive a design concept and intervention for a fitness facility in Winnipeg Manitoba that questions dominant heteronormative¹ and cisnormative narratives.

1. For definition of key terms see Section 1.4, beginning on page 15.

The site selected for this project is the Manitoba Club, a 55000 square foot exclusive, members-only social club located at 194 Broadway Avenue at the corner of Broadway Avenue and Main Street, of which all three levels and attic will be redesigned.

As a discipline interior design is also responsible for improving wellness in that it is the job of practitioners to design environments that contribute to total well-being by aligning the pragmatic requirements of the National Building Code of Canada (NBCC) such as accessibility with more psychological considerations such as aesthetics and human comfort. While one of the most pressing topics in interior design today is, in fact, accessibility, it is often used - as in the NBCC - in a limited capacity to refer only to design for assisted mobility such as wheelchair or white cane usage. Legislating only this one facet of

accessibility, though an important facet, is reductive in that it ignores other permutations of inaccessibility and discrimination such as sex and gender.

While the NBCC mandates that both men and women be accommodated by requiring a certain number of washrooms per sex, its mandates are predicated on the presumption that, not only are male and female the only two sexes needing accommodation, but that they are separate, distinct, and permanent inhabitations. Although many people subscribe to this notion that sex and gender are inherently dichotomous, there is a wealth of queer and gender theory as well as trans studies literature that suggests otherwise. As a result, current legislation ignores expressions and embodiments of sex and gender that do not conform to an “either male or female” binary and

overlooks the multiplicity of bodies, of masculinities and femininities that are both/and, neither/nor, and those which are fluid and changing among multiple identities and expressions. The absence of legislation governing design and construction practices with regard to gender diversity results in many spaces, both public and private, being inaccessible to gender variant communities for whom the either/or design of many public facilities, including most fitness clubs, is prohibitive (Bloyd 2009; Cavanaugh 2010; Nguyen and Cross 2009). While it proved beyond the scope of this project to address the specificity of designing for all of these diverse communities, it can provide a starting point for future research by examining and proposing a challenge to the ways in which fitness club design is invested in binary discourses. That is precisely what this practicum undertakes.

Evident by the sheer repetition with which I have been asked what gender has to do with interior design, this narrative of “either male or female” is so deeply embedded in the North American consciousness that it has become naturalized. The idea that gender is divorced from architecture and design reflects a larger assumption that the dichotomy of ‘male or female’ goes without saying and ignores or denies the possibility of sex and gender beyond this exclusive dualism. If, as interior designers, one of our mandates is to make spaces that are accessible, then it is our job to identify and design for all potential user groups, not just those mandated by building code.

Determining the number and types of facilities based exclusively on the number of male or female occupants makes no consideration for the reality of both/and, neither/nor, and fluidity among many. By designing spaces that challenge this binary

assumption, we can create a dialogue around the need for, and lack of, accessibility for non-normative sexes and genders, increasing visibility for equal rights across a multitude of arenas.

In the long run, challenging this either/or narrative has the potential to be a catalyst for change – changes to building code requirements, changes to institutional conceptions of sex and gender, and most importantly, changes to social attitudes and phobias toward gender variance in all its manifestations. As both Sheila Cavanagh and Caroline Fusco have argued, sites like bathrooms and fitness clubs - particularly locker rooms - that are heavily invested in sex and gender difference are often hostile toward both queer and gender variant individuals because their embodiments, expressions, and desires contradict this narrative.

(Cavanaugh 2010; Fusco 2006) Given the conflation of gender variance with homosexuality and vice versa, there is a persistent assumption that a person who deviates from gender norms must also deviate from sexual norms – heterosexism is dependent on the exclusivity and opposition of male and female, just as the exclusivity and opposition is predicated on heteronormativity (Cavanaugh 2010; Namaste 2006). With violation of one perceived as a violation of the other, “gender is used as a cue to locate lesbians and gay men [and vice versa, whereby]... The gendered construction of space – both public and private – figures centrally in [the] acts of aggression” (Namaste 2006, 588) fueled by trans and homophobia. The result being that these spaces more heavily and violently policed by heterosexist and cissexist individuals who fear the undoing of hetero and cissexual privilege that a multiple gendered reality

represents. Challenging the binarity of the public sphere is not just about acknowledging the need for equal access to spaces and amenities, but about acknowledging basic human rights. By creating spaces that acknowledge multiple genders and resist privileging a binary system, there is the potential to disrupt a vicious cycle of violence.

In a society whose attitudes and institutions are predicated on the notion that there are only two sexes and two genders, the solution to gender accessibility has been to create women-only fitness clubs. While the very concept raises questions about the gender identities and expressions being perpetuated in the conventional fitness club, it fails to address the root of the problem. Segregating clubs based on sex does not interrogate the fundamental issues around gender and the body, and, rather, reinforces both the ‘otherness’ of

women as well as heteronormative conceptions of gender expression and sex as either/or dichotomies. What this project aims to do is to deconstruct, or at very least question, the categories upon which gender discrimination is based and undermine the stereotypes which equate certain characteristics and body types with normal or natural masculinity and femininity. Whether because of one or some combination of size, shape, dress, mannerisms, or sexual anatomy, the dominant attitude associates both women and men who do not embody or express the characteristics ascribed to their sex with aberrance and immorality. (Dworkin 2003; Farkas 2007, 3; Jhally 1999; R. A. Wilchins 2003; Wittig 1992)

Challenging dominant ideologies, however, is not as simple as posting a sign or raising a banner. The fitness club has a long history of masculinist

exclusion. Thought to have originated in ancient Greece, the origins of the gymnasium as a strictly male venue for social interaction including both physical and mental exercise, is a likely source of binarity that permeates the fitness industry today. Providing conditioning for competition in battle and contests of strength, gyms fell into disuse until nineteenth century Germany where men would attend public athletic halls - public only in so far as there was no entrance fee - for physical fitness training. This trend made its way to North America through German-American immigrants who erected athletic halls across the United States during the mid-nineteenth century. It was around the turn of the twentieth century, as weight training gained in popularity, that gyms moved away from gymnastic and coordinated aerobic training and focussed their efforts on weightlifting. The nineteen thirties saw the introduction of the “boxing gym” with the

specific aim of fight conditioning. Though the gym was becoming increasingly separated into specialised facilities dedicated to a single type of training, all facets of athleticism and physical conditioning, and its concomitant benefits, remained the purvey of men. (Kirby 2013)

Present day gym franchises, though still having their origins in ancient Greece, are largely modelled after the bodybuilding clubs of the nineteen sixties and seventies when bodybuilding was trending heavily (Ibid). Though the participation in gym culture, and even bodybuilding itself, has extended beyond just men, it maintains a fairly rigid separation between what kind of body types and, therefore, physical activities are acceptable for women and what are alternately acceptable for men (Dworkin and Wachs 2009; Ian 1996; Johansson 1996; Jhally 1999) and makes no allowance for

bodies or genders that differ from those ideals. Caroline Fusco suggests that gyms are spaces whose very intent is to highlight variance from the norm, “spaces in which individuals could be located, monitored, and surveyed for their adherence to the discourses of... public health” (2006, 8), discourses that prescribe ‘appropriately’ dimorphic and dichotomous sex and gender presentation, and thereby attempt implicitly to regulate such characteristics as body shape, size, muscle mass, and style of dress, to name only a few. The gym, then, provides an opportunity to interrogate definitions of fitness and presumptions about what characteristics and activities constitute a ‘fit’ body.

The prevalence of sedentarity among North American adults makes it increasingly necessary to prioritize accommodation and inclusion so that all

bodies, gender identities and expressions feel welcome in the fitness club and being active. Bringing with it increased risk of heart disease, diabetes, and certain cancers, the deleterious effects of inactivity are well documented (Government of Ontario 2013; Statistics Canada 2013). In a society in which sedentary is on the rise – Statistics Canada estimates that less than fifteen percent of Canadians meet minimum physical activity recommendations while the majority are inactive for an average of ten waking hours per day – the need for inclusive fitness clubs is paramount (Picard 2012; Statistics Canada 2013). Not just an issue of equal rights, this kind of accessibility is also an issue of basic human health increasing the need for individuals of all sexes and gender, embodiments and expressions to feel welcome in fitness facilities.

In the interest of interrogating dominant attitudes and creating a space that is inclusive, regardless of sexual anatomy or gender expression, the fitness club proposed in this project will be one available to all sexes, genders, and sexualities. Creating spaces that are exclusive to specific communities disregards the vast number of individuals who, in spite of having had similar experiences of discrimination and violence, occupy bodies and gender identities that do not unambiguously fit into a single community and are, therefore, excluded despite identifying with one or many. Trans women, for example, are often denied access to women's only spaces by virtue of their not having been born with female genitalia despite having faced many of the same injustices (Dacumos 2006). And although the transgender community was on the front lines of the early campaigns for gay rights including the Stonewall rebellion of 1969, many have since been

excised from gay and lesbian communities because their perceived ambiguity precludes them from mainstream definitions of gay and lesbian (Clare 2009; Rivera 2002). This exclusion inadvertently reinforces hierarchies of otherness which stand in the way of large-scale resistance against cissexist and heteronormative attitudes. (Feinberg 1996; Kusalik 2010, 4; Nestle 2002; Wittig 1992)

The aim of this project is not to perpetuate hierarchies and labels of who belongs and who does not belong; separating and policing categories of who is woman enough, gay enough, trans enough, and so on, to have access to their spaces and resources, is counterproductive insofar as “such a movement, which sets out to free gay people [or many other queer communities], actually ends up erecting yet another set of barriers and constraints to keep them in” (R. Wilchins, Gender Rights Are

Human Rights 2002, 293). By creating a space that is open to all regardless of sex, gender, or sexuality, this project aims to transcend the labels that divide us into ‘who is’ and ‘who is not’ of a particular community and acknowledge that “there are infinite ways to express gender [and] there are infinitely many different ways to be embodied” (Vade and Solovay 2009, 174). It is in this vein that I endeavour to create a space whose challenge to binary sex and gender questions dominant hetero and cisnormative attitudes and initiates a conversation around the need to examine how these attitudes permeate design practice. This design project is aimed at both addressing the common human need for health, and deconstructing the mechanisms by which sex, gender, identification, expression and embodiment are policed in the first place. The more spaces and communities created that question the normalcy and naturalness of cis

and heteronormative attitudes, the less “normal” they will become.

This becomes possible if we “...insist upon a focus on the mechanisms of oppression” (Nangeroni and Mackenzie 2002, 259), subject them to interrogation rather than facilitate their unquestioned repetition. The overarching dominance of heteronormative and cissexist binaries categorize people according to an exclusively dichotomous system – a person is either a masculine male or a feminine female and, by virtue of their sexual preference, is either heterosexual (considered the norm) or homosexual. These being the precepts upon which North American society is based, and the source of trans and homophobia, an investment in their deconstruction would mean a dismantling of much of this discrimination both between different queer

communities and in the public sphere at large.

With this in mind, the aim of this practicum project is to design a fitness facility that challenges the dominant heteronormative and cissexist ideologies that continue to divide and marginalize LGBTQ communities. The following will outline how this hypothetical club, named Inside & Out² presents an alternative, counter-narrative.

2. The name for the club is inspired by a song lyric. In “In or Out,” from her 1992 album *Imperfectly*, Ani DiFranco sings “they’re eyes are all asking, are you in or are you out? I think, oh man, what is this about? I just want more than one membership to more than one club...” Modifying the song title “In or Out” to Inside & Out reflects the myriad of possibilities of sex, gender, and sexuality where inside suggests subjectivities in between, and out suggests those beyond the binary. In addition to its more conceptual relevance, it also reflects the multiple and interrelated aspects of health and wellness - physical, mental, and emotional = inside and out.

1.1 Research Questions

To determine the methods of research most appropriate in achieving these objectives and in order to keep the project within the assigned scope, both the inquiry and the design have been guided by the following questions:

1. What discourses in fitness culture and club design reinforce dominant cisnormative and heteronormative narratives around gender and sexuality?
2. What concepts or issues from gender and queer theory can inform the design of a space that challenges cisnormative and heteronormative gender conventions?
3. What are the current barriers in conventional fitness clubs that prevent inclusion of gender variant communities?
4. What concepts, issues, or narratives from gender and queer theory relate to the design of an inclusive fitness club?

These questions were used to help isolate specific features and atmospheric characteristics that reinforce dominant binary ideologies and develop ways that their reinvention or removal might challenge cisnormative and heteronormative thinking. By challenging these conventional designs, we can question the system that engenders them and initiate a dialogue around designing for more than two sexes, genders, and sexualities.

Multiple methods of investigation were employed in pursuit of these goals including a combination of personal observations, literature review, precedent analysis, and one on one interviews. The purpose and implications of each is described in more detail in section 1.3 Methodology (page 17).

Ultimately, these questions aim to identify trends in gender, usage, and representation in conventional

fitness facilities and to explore their physical and theoretical implications. With the goal of challenging sex and gender binarity, it is necessary to first examine the origins of trends around gender, fitness, and the body in order to subsequently undermine them. Only then can we create an atmosphere that fosters a sense of individuals not being reducible to their genitalia, but rather all being different, equally valid variations of being human.

1.2 Biases & Limitations

As someone whose sex and gender are considered normative, I am approaching this subject without lived experience of my own. While this is a perspective which could be seen as establishing a position of power, my interest in this issue is precipitated from a desire to deconstruct the dominant binarism of sex and gender, and in doing so, create a dialogue around gender inequities and human rights in interior design. The project is, thus, aimed at questioning the validity of and presenting a challenge to the permeation of cis and heteronormativity in the built environment.

Though Riki Wilchins argues that “in a society

where femininity is feared and loathed, all women are genderqueer” (R. Wilchins, *A Continuous Non-Verbal Communication* 2002, 11), there are nonetheless certain encounters with the built environment that I have not experienced given that my gender expression is generally considered to match that which society has assigned me.

As such, I felt it necessary to seek first-hand experience by conducting interviews with volunteers from the trans community in an attempt to gain some of this necessary, but absent perspective. Relying strictly on textual sources from gender studies and queer theory is not only

reductive in that it is a limited view based on my cisgendered interpretation - despite including written accounts of lived experience - but also in that theory has a tendency to overlook the specificity and corporeality of lived experience. A more participatory approach also reduces the risk of designers ascribing needs to users rather than allowing occupants to contribute themselves. This community based design model recognizes “that people who use the environment have an expertise equal to, but different than the expertise of the architect” (Sanoff 2007) and, as a result, is more likely to meet the needs of the community and foster a sense of pride and satisfaction in the space.

That being said, the scope and time frame of the current project proved inadequate to allow for a thorough sampling of interviewees, and despite several expressions of interest, only two volunteers

eventually chose to participate. In conversation with one of these individuals it was suggested that the wording of the interview invitation may not have been as inclusive as intended and may have alienated some potential participants. Even if more participants had been found, however, given the time frame and the scope of the project, the sample size would still have been insufficient to account for the vast diversity of perspectives on the proposed project. As it still informed the final design, however, the interview testimony that was obtained has nonetheless been included in Chapter Five.

1.3 Methodologies

This project employs several different research methodologies in achieving its goal. The document and design are informed in large part by personal observation, literature review, precedent analysis, and the aforementioned interviews, all of which have been used to determine the kinds of features, services, and atmospheric qualities that contribute both to challenging hetero and cisnormative ideologies and creating a more inclusive space.

1.3.0 Personal Observation

Visits to multiple fitness chains throughout the city of Winnipeg, provided an opportunity to identify some of the ways in which the designs of these

facilities either reinforce narrow ideas of sex and gender polarity, or recognize a diversity of bodies and users. Observations made during these visits were specific to physical design features, promotional materials, and spatial planning and did not include any observation of human behaviour in relation to the built environment.

1.3.1 Literature Review

There is a significant catalogue of literature from queer and gender theory, fitness studies, and architectural theory addressing conventional and alternative conceptions of sex and gender. With respect to this project, the sources consulted run the

gamut from gender and its relation to the built environment, the relationship between gender, fitness, and the body, and the interrelationship between gender, identity, and performativity. All three avenues were explored in order to provide a broad spectrum of perspectives on the topic at hand which is ultimately about the multiplicity of sex and gender, bodies and performativity, and the built environment. Information gleaned from the literature review was used to analyse, deconstruct and support the other methods of research used.

1.3.2 Precedent Analysis

The analysis of precedents related to fitness design and design for the LGBT community has been fruitful in identifying trends, both positive and negative, that predominate in North American interiors and were used to inform the final design intervention. It also provided an opportunity to

analyse methods of transliterating textual theories into a coherent design language. The precedents analysed include a fitness club, a recreation centre, and an LGBT community centre. Against the backdrop of the literature reviewed, the analysis of these spaces assisted in determining what and how design trends might reinforce and challenge gender conventions, and inhibit and facilitate a gender diverse environment.

1.3.3 Interview

One on one interviews were chosen, in addition to the benefits described above, because they provided a unique opportunity to build a rapport with the participant and respect their individuality. In a society in which variance from gender norms are not recognized as being viable subjectivities (Connell 2010; Bornstein and Bergman 2010; Dworkin and Wachs 2009) it was critical to the aim

of recognizing multiple permutations, embodiments and expressions of sex, gender, and sexuality that the process did not reduce participants to anonymous objects of study, but that it represented their individuality.

Lacking first-hand experience of navigating public spaces as someone who identifies or is perceived as deviating from norms in a society in which interior design is predominantly informed by cisnormative and heteronormative thinking, the intent was to conduct interviews with volunteers who identified as gender variant in some capacity in order to obtain a first person perspective on the project. These interviews, designed with questions focussing on individuals' preferences with respect to features, atmospheric qualities, and services, were intended to provide insight into the programmatic and aesthetic design of the facility.

(Appendix I.i)

In order to ensure the sensitivity of the interview solicitation and execution and prevent the distress or misuse of contributors, approval from the University of Manitoba's Research Ethics Board was obtained prior to advertising for participants. This involved submitting a detailed proposal documenting the methodology, intended use of data obtained, confidentiality of participants and samples of all communications with participants and potential participants including interview solicitations, questions, and consent forms (Appendix I.ii). These were reviewed by a board prior to beginning the interview process which occurred only after approval was granted.

Once approval was granted, interview invitation posters (Appendix I.iii) were displayed in the

University of Manitoba's Rainbow Pride Mosaic office, the University of Winnipeg's LGBTQ* Centre, and the Rainbow Resource Centre.

Interested people were invited to contact me via email which was provided on the invitation.

1.4 Definition of Terms

Many of the terms and titles associated with the queer community, both claimed by its members and used by society to categorize people perceived as non-normative, are contested and used by different people and groups to connote different bodies, presentations, and desires. For the purposes of clarity, although I do not intend to disparage any other usages or claims to these titles, I will herein define how I intend to use some key terms.

1.4.1 Sex

Sex is generally used to refer to a person's reproductive anatomy or, as Canadian professor, sociologist, and sexologist Aaron Devor puts it,

“sex is between the legs” (Vesely 2012, 3; quoting Devor). The politicization of genitalia, however, suggests that in fact “sex is both a physical attribute and socially constructed” (Dozier 2005). In cissexist terms sex is constructed as a duality where the title woman is presumed to equate to “person with a vagina” and man to “person with a penis.” Contrary to this system, however, in which sex is the binary determinant of gender identity and expression, the aim of this project is to create a space that acknowledges that a person and their gender identity(ies) are not reducible to their genitalia, and furthermore, that sex is not dualistic, but a multiplicity of different anatomical and

genital configurations.

1.4.2 Gender

Whereas “sex is between the legs... gender is between the ears” (Vesely 2012, 3; quoting Devor). While I question whether sex and gender are as discrete as this statement seems to suggest, it does imply that gender is not an inevitable and universal characteristic derived from an individual’s sex. Gender is generally used to refer to an individual’s perception and expression of self through characteristics commonly categorized as masculine and feminine including outward appearance, body language and social behaviours. It is simultaneously assigned, learned, thought, felt, and performed, so while it does not directly refer to sexual anatomy, in heteronormative terms, gender is generally thought to derive therefrom so essentially the title woman still evokes vagina for most people, but along

with the particular set of physical and behavioural characteristics thought to pertain to having a vagina and, therefore, being a woman. Likewise, the moniker man implicitly suggests penis and its own distinct set of physical and behavioural characteristics. This project, however, is informed by the former – that gender, not only does not derive from sexual anatomy, but is multiplicitous in its identification and expression, in ways well beyond those conventionally codified as woman and man and is not determined by genitalia (Bornstein and Bergman 2010; Butler 1990; Feinberg 1996).

1.4.3 Sexuality

“Sexuality... refers to the ways in which individuals organize their erotic and sexual lives” (Doan 2010) including the partner(s) they choose and the activities they engage in with said

partner(s). Conventionally understood as a duality in which people are either heterosexual – desiring members of the ‘opposite’ sex – or homosexual, desiring members of the ‘same’ sex – this binary, not only ignores other sexual identities such as bisexuality and pansexuality, but it presumes that the sexed body is only one of two options, either male or female, making desire either same or opposite. The possibility of sex and gender encompassing more than just male or female, however, posits the potential for a myriad of sexualities as well. It is in this way that I prefer to use the term sexuality, as multiplicitous and potentially fluid in its inhabitations.

1.4.4 Gender Variance

Gender variance is herein used to refer to a myriad of individuals, embodiments and identities that, whether purposefully or otherwise, are perceived

to be outside the norm of essential, binary, sex and gender expression. Transphobic, cissexist, and heterosexist discrimination is not limited to those who identify as transgendered or homosexual, but is often aimed at anyone who is perceived to transgress binary gender dictates whether because of their embodiment, their expression, or desires. This term is intended to encompass all of these individuals, presentations, and activities that diverge from the accepted norm.

1.4.5 Transgender

Though conventional dictionary definitions reduce transgender to refer to a person whose gender identity, aligns, not with their birth sex, but with that of the ‘opposite’ sex, the Latin etymology of the prefix trans has meanings beyond suggesting binary oppositions. It can, in fact, be translated to mean across, outside of, or beyond so, where

heteronormative gender operates as an either/or binary of male or female, transgender is used to refer to individuals who live outside of or beyond the conventional male/female dichotomy. Here trans has a meaning more akin to transgression or transcendence which opens the door for a multitude of different sex and gender combinations, identifications, and expressions. (Diamond and Blazes 2010) In this sense, I invoke transgender as a term distinct from the commonly synonymous ‘transsexual’ in that it includes a vast matrix of individuals. While transsexual is used to refer specifically to those who have had or desire to have gender reassignment surgery, transgender refers, in Catherine Connell’s terms, to “...those who deliberately reject their originally assigned gender assignment... regardless of surgical or medical status” (2010, 33). This definition includes those who identify as transsexual, transvestite, intersex,

two-spirit, and genderqueer, to name only a few.

1.4.6 Cisgender

The term cisgender, relatively unknown outside transgender academia, refers to individuals whose gender identity and expression are congruent with that assigned to them by society by virtue of their apparent sex. Kate Bornstein and S. Bear Bergman’s collaboratively edited *Gender Outlaws: The Next Generation* (2010), and Catherine Connell’s “Doing, Undoing, or Redoing Gender?: Learning from the Workplace Experiences of Transpeople” (2010) both make frequent use of the term in referring to non-transgender populations. Literally speaking, the Latin prefix cis translates as “on this side” where cisgender subsequently refers to individuals on this side, or on the accepted, normative side of the gender binary (Taylor 2010, 1). It does not necessarily mean, however, that they

subscribe to or condone this binary, only that their expression and embodiment happens to coincide with expected gender norms.

1.4.7 Queer

This is a particularly contested term with several different meanings. In my own experience, I have encountered some individuals who are familiar with the term only as a referent to the gay male population despite the fact that it has come to be used as a broader, more encompassing term including the gamut of gay, lesbian, bisexual, transgender, and the many other embodiments, expressions, and desires outside hetero and cisnormative conventions. In academia it is also a term used “to challenge the concept of a stable sexual identification and problematize the binary division homosexual/heterosexual” (Palmer 2012, 4). For the present purpose, I will use it in both its

broad sense to refer, like author and professor Christopher Reed, to “... all manner of sex/gender scofflaws” (1996, 64) as well as a term mounting a resistance to dominant binaries.

1.4.8 Heteronormativity

Heteronormativity refers to a large and multi-faceted set of ideologies that ultimately act to establish and reinforce the normality and essentialism of heterosexuality and its concomitant binary constructions of sexes, genders, and coupling. For the present discussion, suffice it to say that it refers to a hierarchical belief system in which man and woman, male and female, masculine and feminine, and all other verbalizations, expressions and embodiments thereof are the natural, exclusive, and dichotomous derivatives of human genitalia. It is a biological determinist point of view that situates gender as an

either/or whereby penis = man and vagina = woman, equations wherein body parts and gender expressions setup in binary opposition and whereby the two are conceived as mutually exclusive and unambiguous both as subjectivities and embodiments. Deriving from this opposition is the assumption that heterosexuality is the natural and therefore only acceptable configuration for sexual and romantic coupling. That being the case, one of the primary aims of this project is to design a space that, both physically and conceptually, undermines these binaries by acknowledging and reflecting the multitude of gendered bodies and expressions outside the heteronormative system. (Butler, *Bodies that Matter: On the Discursive Limits of Sex* 1993; Wittig 1992)

1.4.9 Cisnormativity

Cisnormativity constitutes “cultural schemas about

the naturalness of a binary gender system” (Schilt and Westbrook 2009, 442) that undergird heteronormative ideology. Like heteronormativity, it implicitly propagates the normalcy and naturalness of cisgenderism, discriminating against perceived gender variance and privileging individuals whose outward gender expression appears to be congruous with the gender norms ascribed to their perceived sex. This presumed normalcy perpetuates the “...belief that transsexuals’ identified genders are inferior to, or less authentic than, those of cissexuals” (Cavanaugh 2010, 54) and that gender presentations that do not adhere to convention are deviant and dishonest representations of ‘true’ sex (Schilt and Westbrook 2009, 443).

1.4.10 Performativity

Performativity, though related to theatricality and

involving performance, is not synonymous therewith. When speaking of performativity I invoke Judith Butler whose definition revolves around the reinforcement and presumed essentialism of social norms including gender through repetition and naming. Implicit, then, in the perpetuation of heteronormative ideology are the mechanisms by which masculinity and femininity and their apparent dichotomy are constructed and passed off as natural and essential. Butler also suggests, however, that it is through this same performative repetition that subversion takes place. (Butler 1990, 1993, 2004) I depart from Butler, however, in proposing that individuals have a certain degree of agency in being able to appropriate and rearticulate or outright refuse hetero and cisnormative narratives. In response to those who argue that Butler's line of argument negates individual agency in the definition of

performativity and thereby negates any presumption thereof in the application of her theory, I invoke Jay Prosser who suggests that "there's something very camp, very definitively queer about readings that refuse to adhere to the letter of Butler's argument, that refused, to use its vernacular, to 'repeat loyally'" (Prosser 2006, 260). And it is through this same refusal, I would argue, that individuals create Butler's 'Gender Trouble.' Important to the notion of performativity, this refusal allows that someone can both abide by and reject gender norms and thereby trouble them, whether consciously or unconsciously. This definition is expanded upon in section 2.3.1.

1.5 Site Selection Criteria

There were a number of important factors considered in selecting the Manitoba Club as this site for this project. Speaking pragmatically, it needed to be fairly centrally located, preferably with multiple means of access such as automobile, public transit, and pedestrian routes. A location close to downtown was considered ideal for commuters wanting to fit in a visit to the gym on their way to or from work, or even during their lunch hour and was identified by one of the interviewees as being preferable (Matraisa 2013).

It also needed to be large enough to house the necessary amenities such as cardiovascular and

muscle conditioning equipment, group fitness space(s), locker rooms and showers, administrative offices and other ancillary services. Specific programming and spatial requirements will be outlined in further detail in the Programming section of Chapter Five.

One of the most important considerations, in the interest of undermining dominant gender and sexuality narratives, was the potential for the history of the building to be subverted. With this in mind, the site needed to be an existing building with a particularly gendered history, ideally one that had been consistent over much, if not all, of the

building's lifetime. Working from a perspective similar that of academics like Judith Butler and Christopher Reed, subversion of dominant social narrative arrives out of juxtaposition of the existing order with unanticipated and unsanctioned reinterpretations of the original, in other words, using the language of the dominant order, encoded with its own preservation, to question its dominance. Thus, it was critical that the building be, not only historic, but one whose history and design reinforced heteronormative and cissexist thinking.

While other sites such as the now defunct Masonic Temple located at 335 Donald Street and the operational Masonic Temple at 420 Corydon Avenue were considered for the project, the Manitoba Club was chosen, not only because it satisfied all of aforementioned conditions, but

firstly, because the history of the men's club as a typology has significant links to fitness and the construction of gender, and secondly, the building, over one hundred years old, has housed this typology since its erection in 1904. This will be discussed further in Chapter Three.

1.6 Summary of Forthcoming Chapters

The following chapters will outline the theoretical and conceptual framework and individual perspectives that have informed the project, the precedents, both inspirational and cautionary, that have been used to guide the design and the transliteration of these concepts, perspectives, and precedents into the proposed design intervention.

Chapter Two will outline the theoretical and conceptual framework that has been used to inform the final design. Derived from an extensive literature review, this framework has been constructed using concepts from both gender theory and queer theory, including written accounts of

queer experience, as well as analyses of the fitness industry and the club environment. The chapter is organized according to three concepts common to both discussions of gender and fitness: the body, queer space, and deconstruction. Texts addressing these concepts from the perspective of gender and queer theory include the work of authors and editors such as Judith Butler, Monique Wittig, Jane Rendell, Mary K. Bloodsworth-Lugo, Catherine Connell, and Carrie-Anne Paechter, while collections and individual works from authors and activists such as Kate Bornstein, Riki Wilchins, Leslie Feinberg, and Martine Rothblatt will provide insight into lived queer experience.

Selected analyses and theories from Sherri Dworkin, Caroline Fusco, Marcia Ian, and Thomas Johansson will be used to investigate fitness as an industry, physical environment, and a social ideology and to explore manifestations of gender conformity and resistance therein.

Finally, queer space will be examined using the work of Christopher Reed, and Mary McLeod, while deconstruction will be investigated through the work of Mark Wigley, Philip Johnson, and John Pile.

Chapter Three is dedicated to an analysis of the chosen site including pragmatic concerns such as zoning, occupancy, and building code analysis, as well as a detailed discussion of its historic, functional, and architectural significance, particularly as it pertains to gender. This chapter

will examine both the potential opportunities and constraints posed by the selected venue.

Chapter Four examines three disparate but equally relevant design precedents. These case studies elucidate some of the theories discussed in Chapter Two and illustrate how these theories can be transliterated from textual language into architectural language. Using a chain of highly stylized American gyms, a New York LGBTQ community centre, and an Ontario recreation complex, the analyses yield design opportunities and methodologies, which, read against the theories brought forward by the literature review, inform the final intervention.

Chapter Five explicates, with the aid of the precedents studied in Chapter Three, the translation of core concepts identified in Chapter Two into the

design of a gender variant fitness facility. It draws, in addition, on information gleaned from a few one on one interviews conducted with transgender identified volunteers to establish the programmatic, aesthetic, and spatial design of the club.

The project concludes with a discussion of obstacles encountered and, where possible, surmounted in the course of the research and design, as well as opportunities for further exploration of this topic and personal reflections.

1.7 Chapter One Summary

Accessibility as a term and as a design practice is at risk of being reductive. While design for assistive mobility is of critical necessity, so too is the accommodation of a greater diversity of bodies, sexes, and genders. Exercise being a vital component in, not only physical, but also mental and emotional wellness, the need for fitness facilities that are inclusive of multiple genders is dire for a population that encounters high incidence of depression and, moreover, thoughts and attempts toward suicide. (Vesely 2012)

Where the overarching source of this inaccessibility derives from the homophobia and transphobia that

result from heteronormative and cissexist ideology, one of the critical aims of achieving long-term accessibility and visibility for gender variance resides in the interrogation and deconstruction of the cissexist and heteronormative thinking that permeates both social and physical environments.

The forthcoming document outlines the process and outcomes of my design for a gender inclusive fitness facility, one that welcomes the gamut of diverse gender identities, expressions, and embodiments within and without the conventional male/female binary and in so doing, challenges the naturalness and essentialism of that binary.

CHAPTER TWO

LITERATURE REVIEW

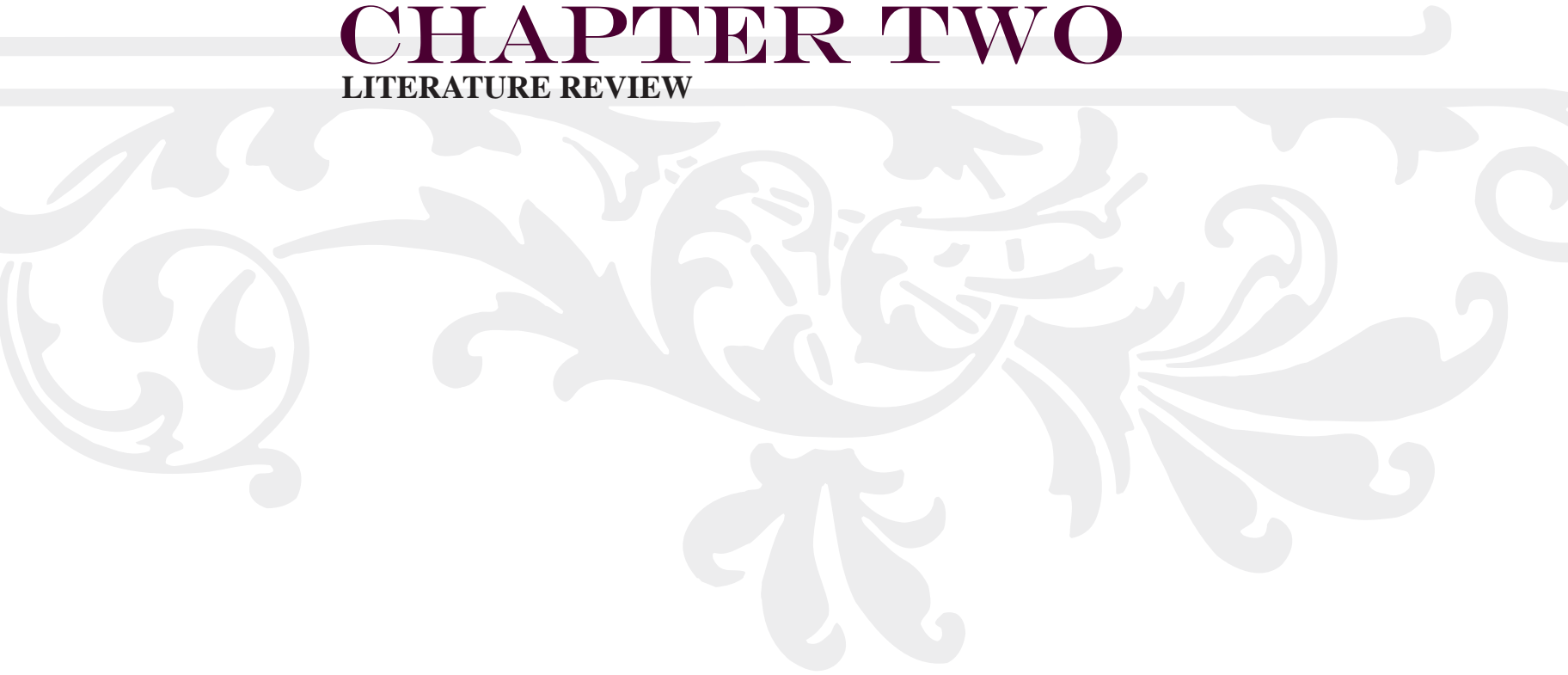

2.0 Introduction

Justice is not only or exclusively a matter of how persons are treated or how societies are constituted. It also concerns consequential decisions about what a person is, and what social norms must be honored and expressed for ‘personhood’ to become allocated, how we do or do not recognize, animate others as persons depending on whether or not we recognize a certain norm manifested in and by the body of that other (Butler, *Undoing Gender* 2004, 58).

In a society that refuses the possibility of sex and gender beyond the conventional binary, many disciplines also do not acknowledge it in either theory or practice. Though there is a large volume of literature affirming the diversity of sex and gender as multiple and simultaneous inhabitations

neither dualistic nor exclusive, this message has yet to infiltrate other discourses including architectural theory, practice, and pedagogy, as well as studies of the fitness industry and its culture. Where these dialogues are almost exclusively focussed on “male versus female” narratives, they fail to acknowledge the exclusion and repression of alternative subjectivities. In the absence of explicit queer narratives in either fitness or architectural discourse, it is therefore necessary to locate and reappropriate, through an examination of these binary discourses, latent implications that can be extrapolated from them, in part from the very fact that they are absent. It is thus necessary to tease

out, through a process of cross-examination and cross-referencing, the overlap between persistently binary discourses like fitness and architecture and alternative sex, gender, and sexuality narratives in gender and queer theory. Locating and sussing out these overlapping discourses forms the contextual and theoretical framework against which narratives of sex and gender multiplicity are translated into the design of a gender diverse fitness club.

The body of gender and queer literature is extensive and continually expanding as the result of contributions from numerous authors and activists who encompass a vast diversity of voices, perspectives, and experiences. These disparate viewpoints, representing a myriad of populations at odds with cisnormative and heteronormative attitudes, are by times also at odds with each other, arguing who and what qualifies as real queer, real

woman, real trans, etc., when in fact their struggles are all fundamentally the same (Bornstein and Bergman 2010; Wilchins 2002; Wittig 1992).

Ultimately, issues of discrimination around both sexuality and gender variance revolve around the persistent belief that sex and gender are binary concepts whose expressions, embodiments, and desires are mutually exclusive, but if this assumption is deconstructed and the actual myriad of genders revealed, the opposition between male and female and hetero and homo is collapsed.

Thus, in the absence of an either/or two-sex-gender system, these prefixes are divested of their former meanings in that, “since everyone has a unique sexual identity, there is actually no reality to being either heterosexual ... or homosexual” (Rothblatt 1995, 84-85). The incongruousness of sex and gender likewise becomes a non-issue because there is no ideal with which to be congruous. With that in

mind, the literature consulted for this practicum project is not limited to any one identity from within the LGBTQ community but includes work by all manner of individuals whether queer, gender variant, transgender, cisgender, transsexual, intersex, lesbian, gay, two-spirit, genderqueer, straight or any other conceptualization and configuration of sex and gender. In the same vein, the literature consulted, though by no means exhaustive, has been selected so as to address a variety of ethnic, social, and political circumstances in order to create a space that reflects as much of the breadth of sex, gender, and sexuality as possible and acknowledges the intersectionality of sex, gender, race, class, and ability. The gender and queer theory reviewed, therefore, includes voices that represent a myriad of bodies and identities that articulate their own unique, intersectional versions of queerness.

As a result, the ideas explored are subdivided along the lines of concept rather than authorship or identification with a particular community. In the interest of creating a space dedicated to the health and wellness of all communities, one whose design deconstructs the binarity and exclusivity of dominant conceptions of gender as a male/female dichotomy, the literature consulted acknowledges and embraces the vast multiplicity of bodies, expressions and identities that is evident in the rich diversity of queer and allied narratives.

A review of this literature, including texts and media not only from gender and queer theory, but also fitness industry analysis and deconstructivism, establishes the conceptual framework through which the design proposal will be conceived. Unpacking and understanding the ways in which hetero and cisnormativity are entrenched in these

discourses and in fitness club design – not to mention architectural practice more generally – is critical to devising a means by which to undermine them. Being that both architectural and fitness discourse, and some gender theory, is organized around relations of masculinity versus femininity as exclusive, dimorphic subjectivities, this review undertakes to, where necessary, reread these binary narratives through a multiply gendered lens and reappropriate them in the interest of staging a queer intervention that deconstructs both a particular typology and related discourses that are typically binary in their construction of gender.

While there is considerable commonality across the disciplines of gender, queer, architectural, and fitness theory, the discussion that follows is organized around three central concepts: the body, queer space, and deconstruction. The first addresses

the body both as a site of the inscription and the re-articulation of gender conventions, contrasting the body in the context of fitness with alternative constructions of corporeality, gender, identity and subjectivity. It is critical to understand both conventional and alternative conceptions of the body given its permeation of architectural discourse and practice. As a space in which cis and heteronormative ideals are largely inscribed but also have the potential to be challenged (Dworkin 2003; Johansson 1996), the gym is particularly poignant in its capacity to provide members of all sexes and genders, embodiments and expressions, the opportunity to reconstruct their identity by means of the body as well as reconstruct their body to match the subjectivity with which they identify (Murphy 2011; quoting Barton’s personal training client Amanda Lepore), and in so doing to rethink the body in relation to the built environment.

Examining the ways in which the construction and deconstruction of the body can mount a resistance to cis and heteronormative dominance, provides a framework for constructing and deconstructing architecture to the same ends.

The second concept investigates theoretical conceptions of queer space or ‘other’ space and its relationship to gender variance. The exploration aims likewise to uncover means by which to challenge the heteronormative ideologies that permeate the built environment by revealing the ways in which space both welcomes and reflects queer identity. Though inscribed with a binary of gender that precludes multiple gendered inhabitation, there is the potential to re-appropriate these spaces in the interest of queering them. So long as “entrance into the public sphere is secured through the enactment of a sanctioned gender

identity, preferably within the context of a heterosexual dyad, couples who violate this prescription, and perhaps especially transgendered people who walk alone, pose a fundamental challenge to public space and how it is defined and secured through gender” (Namaste 2006, 589).

By devising the ways in which a space can reflect queer literature and the bodies and identities it documents and expresses, the application of concepts of queer space to the design of a fitness facility can create an environment that acknowledges and celebrates a diversity of sexes, genders, and desires.

The final section interrogates, through the lens of deconstructive philosophy, the binary of architectural discourse and practice. With parallels to the elements of both queer space and subversive bodies explored in the preceding sections,

architectural deconstructivism is reappropriated as a means by which to expose the latent queerness of the built environment, queerness largely repressed by other architectural movements and philosophies. Through an examination of these concepts, ideas about the body and its relationship to space can be rethought and the conventional either/or exclusivity of the fitness club deconstructed.

2.1 Bodies

The body is both object (for others) and a lived reality (for the subject), it is never simply object or simply subject. It is defined by its relations with objects and in turn defines these objects as such – it is “sense-bestowing” and “form-giving,” providing a structure, organization, and ground within which objects are to be situated and against which the body-subject is positioned. (Grosz 1994, 87)

The body is central to heteronormative and cissexist ideologies which, predicated on gender being an either/or system that derives from anatomical sex, attempts covertly to circumscribe the embodiments and expressions of sex and gender in order to legitimate its own edicts. A rethinking

and reconception of the body, then, is a rethinking of these ideologies. The body, thus, has a particularly powerful capacity to create visibility for multiple, diverse gender inhabitations and equality; where “western evaluative systems have excluded in-between categories as conceivable positions of subjectivity... these positions become feasible through reconceptions of bodies” (Bloodsworth-Lugo 2007, 6), and not just in-between, but subjectivities that transgress and exist beyond the boundaries of conventional sex and gender discourse.

To thwart such reconceptions and secure the

dominance of heteronormative and cissexist ideologies, the body has been repeatedly problematized. Denounced throughout much of Western history and philosophy, it has been constructed as a corrupt and disorderly encumbrance requiring constant surveillance and discipline (Dworkin and Wachs 2009; Cavanaugh 2010). This narrative is so ingrained that

control of the body remains a central organizing principle in post-industrial society. The need to control the unruly body emerges in the post-industrial world as a marker of the self. Linked to personal displays that demonstrate success or failure, the presentation of the body in the twenty-first century signifies a variety of meanings, not the least of which is one's moral worth. (Dworkin and Wachs 2009, 38).

Two of these personal displays, and perhaps the most publicly visible, revolve around gender presentation and physical fitness. Veiled as

morality, this conflation of fitness with a disciplined body, regulated to conform with shapes, sizes and behaviours dictated by hetero and cisnormative ideologies discourages individuals from presenting, or affirming those who choose to present, outside the boundaries of binary gender and its concomitant restrictions on shape and size (Mansfield and McGinn 2004, 65).

By socially, institutionally, and architecturally policing these boundaries and

through the intricate and oblique operations of each disciplinary apparatus, sexuality is privatized without being housed. Institutional practices transform it into some kind of object that appears to be controllable inasmuch as it can be hidden inside or excluded. This is more than simply the defense of a conservative institution in the face of the convoluted topology of desire that threatens to destabilize it. Rather, it is to do with the constructions of sexuality implicit in the constitution of those very

institutional practices, constructions whose strength is produced in the moment of denial (Wigley 1992, 328).

The mandatory transparency of the body, that it be unambiguously identifiable as either a man or a woman, is critical to maintaining this exclusion of sexuality as it is attended by the assumption of that individual's participation in the heterosexual order. In other words, sex and sexuality remain hidden insofar as the assumption of heterosexuality's naturalness precludes the necessity of talking about or questioning it so long as a body is normative in its gender expression – where normative gender expression implicitly includes a size and shape connoting the appearance of fitness. But in that assumption, in Wigley's "moment of denial" (Ibid.), is the very repetition that exposes failures in the binary itself and opens up the possibility of rethinking bodies. (Butler, 1990; Butler 2004;

Wittig 1992)

The fitness club is a site that socioculturally and architecturally both instantiates and substantiates, through its repetition, the dichotomous construction of sex and gender. Architecturally, functionally, and socio-culturally, these are spaces in which masculinity is established as pertaining to a particular body, one sculpted and perfected by means of negating that which is coded as feminine and where femininity, conversely, is constructed as absence (Ian 1996; Sanders 1996, 15; Kessler and McKenna 2006). In so doing, this construction both produces and perpetuates the either/or exclusivity of a male/female dichotomy.

2.1.0 The 'Fit' Body: Gender and 'Fitness'

The fitness club and gym culture have become some of modernity's most stalwart champions of

this notion of gender dimorphism. By constructing and promoting vastly different and mutually exclusive bodily ideals for men and women, the fitness industry perpetuates a binary conception of sex, gender, and expression that hinges on the presumption of heterosexuality and cisgenderism. (Johansson 1996; Leeds Craig and Liberti 2007; Dworkin 2003) Under the guise of naturalness, it propagates "...the silent trope... the conflation of 'health' with the maintenance of narrowly defined gendered bodily ideals" (Dworkin and Wachs 2009, 2).

Where these ideals revolve around masculinity as a negation of femininity, the gym much like the men's club revolves around the exclusion of the female, exercising these edicts at the level of the body. Take, for example, the male bodybuilder, "in body building lingo, he trains and diets in such

a ways as to 'shred' his muscles in order to 'tear down' the existing structure, to substitute the 'rock hard' for the soft, the monumental for the human, and the masculine for the feminine" (Ian 1996, 188), the idea being to remove the soft, fluid, unpredictable space inside the body by replacing it or rather filling it, with solid, impenetrable muscle. This practice constitutes a negation of the female by its negation of interiority which, in heteronormative thinking, is ascribed to women – acknowledging an interior connotes the potential, and assumes the desire, to be penetrated and is thereby categorically denounced in heteronormative conceptions of maleness. Where men are encouraged to trade in the fleshy feminine for solid mass, to take up space, women, conversely, are expected to trim down rather than bulk up, to take up less space while still emphasizing the fleshy curvatures that signal their femininity. (Dworkin and Wachs

2009; Farkas 2007; Johansson 1996; Mansfield and McGinn 2004)

While fat is considered a transgression for both women and men and something to be avoided at all costs – to this I will return later – its elimination or avoidance is constructed differently for women than it is for men. Where “patriarchy is not a system that valorizes the masculine gender over the feminine gender; rather, patriarchal structures value the masculine male, the sexed body residing behind the gender expression... is of vast importance” (Bloodsworth-Lugo 2007, 65), neither must a man connote femininity nor a woman masculinity. As such there is a certain amount of fat or fleshiness if localized in the right places that is acceptable, if not required, for women in order to outwardly manifest their interiority. In order, then, to maintain the opposition of male and female, interiority is not

only ascribed to the feminine and therefore female, but demanded thereof and thus are these fleshy deposits of utmost importance in signifying their difference.

Recounting her experience of being a weightlifter in, not just a male dominated but masculine male dominated space, Marcia Ian describes the perception that “inside the gym world as elsewhere it is the woman who must connote interiority, which is in turn represented visually by tits and ass. Muscle, by contrast, connotes exteriority, the exteriority of the phallus” (Ian 1996, 197). While one could argue that the tits and ass mentioned by Ian, rather than being visual representations of interiority are in fact exterior appendages by virtue of their being fleshy protrusions from the body, they are only outward inasmuch as they are the visible representation of the more taboo, and penetrable,

orifice they are expected to signify. The necessity to connote femininity in this way is reinforced by sanctions introduced and enforced by the International Federation of Bodybuilders against ‘masculine’ levels of muscularity in female bodybuilders, chastising those whose fleshy female parts were obscured by what was considered too much bulk for a woman (Dworkin and Wachs 2009; Mansfield and McGinn 2004). Without question,

these injunctions make it clear that, even in bodybuilding, the one sport and only sub-culture that ostensibly values muscle for muscle’s sake, muscle means man, while women are at best second-class citizens. It is not that women can not become as muscular as males – they can, and do – but they must not (Ian 1996, 196).

What these injunctions represent, along with the attitudes they advocate, is the binarity of male and female where everything that is ‘feminine’ is not

masculine. Not only does it reinforce the presumed dichotomy of these two concepts, but also their exclusivity by denying the possibility of any other sex gender combinations whether it be a muscle-bound woman, a man with an ample bosom, or one of many more besides. It does so by positing their biological essentialism – woman derives from “tits and ass” which are the natural derivatives of interiority (ie. absence of phallus), man derives from the elimination of flesh as the natural evolution of exteriority (ie. presence of phallus).

Rather than defend against the backlash of incensed female body builders the fitness industry has since attempted to curb female muscularity by introducing and promoting a separate venue for women’s competition – more recently body building has been eclipsed by fitness pageants in which women, judged more based on their shape

and gymnastic performance than outright muscularity, are encouraged to develop a lean muscular physique rather than strive for the bulk reserved for men. By separating the types of body and fitness contests for men and women, removing body building from the female fitness equation, there is less potential need for, and backlash from, injunctions imposed against women whose muscularity borders on masculine. Thomas Johansson describes it, much like Dworkin and Wachs, as a “silent process” which serves to police the borders of acceptably gendered bodies; “instead of encouraging women to develop their own bodybuilding culture, they are asked to channel their fascination for muscles into what is called Ms. Fitness contests, a kind of beauty contest where muscles are allowed – but only to a certain extent” (Johansson 1996).

Ultimately, male bodybuilders are constructed and consequently perceived as cultivating some natural, intrinsic characteristic, while female bodybuilders are presented and perceived as acting and developing a body that is against nature and, as such, immoral. (Dworkin and Wachs 2009; Johansson 1996) The ambiguity posed by the body that does not adhere to these heteronormative dictates is construed as a threat to moral order in which the binarity of sex, gender and sexuality is the presumed pinnacle. By not only failing to achieve, but by deliberately rejecting the fit gender ideal prescribed for their sex, the ‘delinquent’ body is not easily categorizable into set categories of gender and sexuality. This failure of the conventional gender classification system stands as a threat to the ontological security of heteronormative dominance which relies on the presumed essentialism of its fundamental

dichotomy of gender difference.

This gendered double standard is not limited to muscle mass. Fatness is likewise treated differently depending on whether an individual is perceived to be male or female. As S. Bear Bergman suggests, based on personal experience, “society... does not see all fat as being equal. A man can be much, much fatter than a woman and still be viewed as comfortably within the standard deviation” (Bergman 2009, 139), which reinforces the dominant idea that whereas women should minimize the amount of space they occupy, men should maximize it and while muscle is preferable, it is nonetheless more acceptable, albeit within limits, for men to have more mass regardless of its composition. Like muscle, fat obscures the outward signifiers of sex that are required to determine socially sanctioned gender expression.

The naturalness and ‘fitness’ of a particular body extends similarly to other areas of body morphology and ability. Deviance from norms concerning size, shape, and ability have also been constructed as aberrant, even irresponsible. Like gender variant bodies, those that are fat and physically impaired are labelled ‘unfit’ – as Eli Clare points out, “the mannerisms that help define gender – the ways in which people walk, swing their hips, gesture with their hands, move their mouths and eyes as they talk, take up space with their bodies – are all based upon how nondisabled people move” (Clare 2009, 112) and in a society in which physical impairment, fatness, gender variance, and indeed any variance from the norm is medicalized and pathologized as a liability, fitness, because it is predicated on normative gender presentation and embodiment, is denied. Ultimately a number of intersecting characteristics and

circumstances have been naturalized as masculine and feminine. This naturalness has permeated every aspect of North American society including our institutions, our buildings, and our language. Even “a certain form of History is used to debase the nonnormative, including the transgendered, the lesbian, the queer, and the fat” (Levy-Navarro 2009, 16).

When this dichotomy is opened up to criticism by virtue of its failure, the naturalness of, not only a binarism of sex and gender, but also of heterosexuality is at risk of being exposed as artificial. The construction of a binarism of gender is, in itself, a mechanism that is both founded on heterosexuality and used to justify its normalcy, a tautology used to justify its own relevance and naturalness. From their ten year study of fitness magazines, Shari Dworkin and Faye Wachs have

concluded that

dichotomous gender difference... is not just part of a gender order but simultaneously, a sexuality order where adherence to gender norms helps to produce a myth of heterosexuality. When men are “masculine,” there are fewer discerning questions about their participation in a heterosexual order, and when women are “feminine,” the same holds for their participation in the “normal” sexuality order (Dworkin and Wachs 2009, 7).

Where fitness is measured relative to ‘appropriate,’ ‘normal’ gender performance, and where “heterosexuality is regarded as the norm, and deviations from this type of sexual orientation are considered as more or less pathological, (Johansson 1996)” non-binary, non-natal sex, gender, and desire, regardless of physical activity level are considered unruly and against nature because they cannot readily be labelled and, thus, cannot be assumed to participate in the hetero and cissexual

order (Dworkin 2003; Varian 2010, 4).

This presumption operates on multiple levels but most insidiously by equating the fit body – constructed as conventionally gendered and heterosexual – with morality. In a society in which health has become the responsibility of the individual, and fitness is reserved for normative bodies and expressions, the individual that conforms to conventional sex, gender, and sexuality narratives is lauded because their participation in the heterosexual order is assumed and therefore the order unquestioned. The individual who fails or declines to achieve the ideal gendered body is stigmatized and labelled perverse, and because “... health and fitness discourses are perceived as operating within the realm of science, or as being unquestionably ‘healthy,’ such discourses are frequently overlooked as a site in which to critically

examine how ideologies of masculinity, femininity, gender, and the body are constructed within such a sphere” (Dworkin and Wachs 2009, 22). Where responsibility for the cultivation of the natural fit, gendered body falls to the individual, gender variances – including variances in size, shape, ability, dress, and mannerisms, to name only a few – are stigmatized as immoral, even deceptive, by virtue of their perceived unnaturalness and deliberate rejection of public discourses of health and morality. (Dworkin and Wachs 2009; Farkas 2007; Schilt and Westbrook 2009)

The ideal fit, gendered body, conflated with normalcy and morality, becomes a performative mechanism in the service of heteronormative and cissexist ideologies whereby, largely conceived as belonging to the realm of the natural, “...the fit body simultaneously validates the individual and

legitimizes the value of such a body” (Dworkin and Wachs 2009, 39) so that transgressing this presumed biology is constructed as a sin against nature. In other words, fitness and thus morality is contingent not only on physical attributes such as strength, stamina, or agility but on an individual’s compliance with binary bodily ideals based on sex.

This division is evident in the occupancy and even design of different functional areas within fitness facilities. Noticing discrepancies between the numbers of women in weight rooms as compared to cardiovascular areas, and likewise differences between the tendency of men to populate cardiovascular rooms as compared to weight, particularly free weight, areas (Dworkin 2003, 132), Sheri Dworkin’s study probing the reasons for such variances reaffirms the commonly perceived importance of gendered ideals pertaining to shape

and size in perceptions of and satisfaction with body image (Leeds Craig and Liberti 2007). The women interviewed in Dworkin’s study were concerned with becoming ‘too’ bulky which they feared, given its construction as masculine, would bring their sexuality into question and label them a lesbian. Thus Dworkin’s participants avoided the weight room for fear of becoming too muscular and thereby masculine in appearance, and instead frequented the cardiovascular room in order to reduce their size. Masculinity, on the other hand, privileges size for men, providing their sex and gender expression are congruent with the norms of the binary.

The fact that most fitness facilities are designed with these as separate functional areas does nothing to detract from this perception. Where Dworkin’s interviewees cited the intimidation of finding

themselves the only woman in the weight room on the occasions that they did venture into that space, the designed separation of cardiovascular fitness and muscle conditioning in most gyms reinforces the separation between the two, both as means of obtaining a particular body shape and image as well as being gender coded activities. Manifested in the physical design of fitness facilities, “these conscious bodily constructions help maintain the appearance of a dimorphic gender order that is often considered the basis for a heterosexual order where “opposites” attract” (Dworkin 2003, 149).

2.1.1 Subversive Bodies

Though she questions to what limits, Dworkin’s study, published in *Athletic Intruders: Ethnographic Research on Women, Culture, and Exercise* reports that “researchers who focus on bodies in sport/fitness have also shown that these

arenas are sites of struggle where the meaning of gender has been negotiated and contested, and where many... have been empowered by the self-definition of their own bodies” (Dworkin 2003, 133); just as it has, or perhaps because it has, been appropriated as a tool in support of heteronormative and cissexist ideologies, the body is a powerful agent in rethinking its own conscription and reimagining its own limits.

In spite of the persuasiveness and pervasiveness of cultural constructions of gender and fitness, there are ways in which the body itself becomes performative in rethinking and reappropriating gender. Liberated from genital dimorphism, de-essentialized gender reveals the multiplicity of embodiments and subjectivities that are, not only possible, but actual lived realities. As a space in which reconfigurations of the body are already

taking place (Johansson 1996), the gym becomes a space capable of such reimaginings.

2.1.1.0 Variant Bodies

Despite the realities being lived by an indefinite number of multiply sexed and multiply gendered individuals, there persists an assumption that gender should correspond to the rigid set of acceptable behaviours, appearances and desires ascribed to a person's genitalia which, like gender, is conceptualized as a two-option, either/or scenario (Bloodsworth-Lugo 2007; Connell 2010) and indeed sex, like "gender, as far as anyone who has never been really, fundamentally conflicted about it is concerned, is a given value" (James 2002, 128). But this is only a given insofar as it is presumed that two sexes, meaning two divergent sets of genitalia, are a given. Not only does this overlook the number of intersex infants whose genitals are

surgically manipulated to fit them into one of two categories, but as Butler has argued the dominance of those categories derives from the ritual of naming infants as either male or female in the first place. Under the pretence of there being a singular disparity between only two types and configurations of genitalia, gender is constructed as a male/female polarity differentiated by gaps between the bodies and behaviours that instantiate them. Whereas they are constructed as biological differences, in fact "...these gaps are culturally set in motion and perpetuated through time, and [only] then get reified as "natural differences" (Dworkin 2003, 140).

Where this naming engenders its own naturalness, genitalia is not intrinsically imbued with maleness or femaleness, but is rather politicized and gendered by being named and, thus only has

connotations in its repeated labelling. Take for example “breasts,” a decidedly female term only inasmuch as it is used exclusively to refer to the chest of a woman. Though discussing the same part of the body, a man is instead referred to as having a chest or pectorals, the latter of which corroborates Ian’s argument about the masculine negation of flesh in favour of muscle. Likewise, penis or vagina instantiates male or female only inasmuch as these associations have been repeatedly articulated and thereby gendered and politicized.

Subversive bodies, however, question this naming by refusing its self-invested authority to confer and fix gender and identity and by revealing the performativity of the body. Where for some, other body parts, including traditionally non-sexual appendages, become sexual anatomy in the course of erotic encounters (Cromwell 2006, 516; Munson,

Do Your Ears 2002; Munson, Liminal 2002) genitals, are themselves performative; rather than physical manifestations of some predetermined, pre-social and pre-political truth about sex and subsequently gender, sexual organs are culturally constructed signifiers of the sex and gender identities they are conventionally presumed to precipitate. Repeated acceptance of their naturalness establishes them as such when, in fact, “‘man’ and ‘woman’ are political concepts of opposition and the copula which dialectically unites them is, at the same time, the one which abolishes them” (Wittig 1992, 29). That being the case, if the sex and gender mandated by heteronormative and cissexist ideology are “a doing and a reading of that doing, a call-and-response that must continually be done and redone, then it’s also unstable, and there are ways I can disrupt it” (R. Wilchins, *A Certain Kind of Freedom: Power and the Truth of Bodies* -

Four Essays on Gender 2002, 24) particularly through articulations, in addition to either/or, of both/and and neither/nor (Cromwell 2006, 513).

2.1.1.1 *De-essentializing Sex*

Where the meanings attached to genitalia are only naturalized in their naming, not only gender, but the sexed body is a performative signifier rather than a pre-social and pre-political given and, thus, “there is nothing inherent in having a penis that leads one to act ‘masculine’ or to be ‘active.’ Nor does having a vagina necessarily imply femininity or passivity ... people are infinitely unique” (Rothblatt 1995, 51). The diversity of gender variant voices documented in texts like *Gender Outlaws: the Next Generation* and *GenderQueer: Voices from Beyond the Sexual Binary*, many of whom write about inhabiting bodies and expressions considered contradictory, provide a defiant affirmation that

masculinity and femininity might just as easily accrue to a person with male genitalia as a person with female genitalia or any combination thereof (Bloodsworth-Lugo 2007, 4; Butler 1990, 9; Connelly 2010, 11; Wittig 1992). The conclusion being that gender identity, embodiment, and expression are not essential characteristics determined by an individual’s anatomy but a complex matrix including, but not limited to instincts, experiences, desires, and cultural and political influences. Labels like male or female, even heterosexual or homosexual are, rather, ways in which the body is circumscribed, pathologized, and glorified or demonized in attempts to curtail variance. (Chase 2002, 211). The possibility of both/and and neither/nor expose the fallacy of, not only biologically determined gender, but the gendered monikers, often slurs, related to gender and sexual preference (Lionheart 2002; Munson,

Liminal 2002) in that, where the rigid binarity of male and female are destabilized, the meanings attached to gendered slurs are rendered impotent. De-essentialized, sex and gender can be acknowledged as the simultaneous and multiplicitous identifications and embodiments that they are.

2.1.2 Identity

The lived experience of a multitude of differently sexed and gendered bodies and identities reveals the ways in which sex and gender are neither binary nor essential, but rather, arrive out of simultaneity and multiplicity where the body's experiences of sex and gender are not singular, but rather a "negotiation of shared space" (Grosz 2000, 220). Though the original reference speaks to architectural space shared by men and women, I propose that, given the classical equation of

buildings with bodies that has permeated architectural practice, discourse, and pedagogy, it also refers to the body as a shared space, one of multiplicity rather than binarity and one in which male and female, and masculinity and femininity – to name only a few – are simultaneously and fluidly inhabited.

As Butler has argued, binary gender is constructed, enforced, and naturalized through language. The act of naming in particular situates human beings, since infancy, in a particular set of accepted behaviours and appearances based on their genitalia. By these means it becomes naturalized to the extent that "gender becomes a self-fulfilling prophecy, imposed from childhood until it is a part of our nature" (Rothblatt 1995, 31). A product of the implement (language) and the person exercising control over it, as opposed to some essential quality

of the individual it is being exercised upon, language and the power to name or confer sex begets the supposed innateness of an individual's gender identity; there is nothing inherently true or real in the masculinization or feminization of sex and gender, nor in its presumed opposition (R. Wilchins, *A Certain Kind of Freedom: Power and the Truth of Bodies - Four Essays on Gender* 2002, 51; Wittig 1992, 29). The binary of heteronormativity and cisnormativity is only perpetuated and normalized by virtue of its repeated power to invest and bestow some perceived semblance of reality (Butler 2004; Butler 1990; Rothblatt 1995, 105). As an intrinsic mechanism of self-preservation, it engenders its own validation by ensuring that no other subjectivities are recognized inasmuch as they, being that the English language is not equipped to address sexed and gendered subjectivities outside the binary - except in

pathological terms where they are not subjectivities but deficiencies and illnesses - cannot be named (R. Wilchins, *A Certain Kind of Freedom: Power and the Truth of Bodies - Four Essays on Gender* 2002, 43; Varian 2010). By deconstructing these terms and exposing them as words that refer only to other words and not to some universal truth of individuals and identities (McLeod 1996, 183), subversive bodies reveal an irreconcilable ambiguity which, pursuant to the juxtaposition of presumed contradictory terms that in their simultaneous inhabitation disrupt the subject/object hierarchy, counter the privilege of the subjectivating gaze. In the acknowledgment of simultaneous subject and objecthood, there is an acknowledgment of subjectivities that beyond either/or.

2.1.2.0 *Simultaneity: Being both/and*

The potentiality of both/and exposed by ambiguous bodies, by virtue of their simultaneous repetition and defiance of convention, represents a sex and gender schema in which one can be both male and female, subject and object. In one well-known current of gender, particularly feminist, discourse, which revolves around visibility and the gaze, seeing comes to be conflated with power and subjectivity. With the body indissociable from architectural discourse, practice and pedagogy, these realms tend toward a similarly ocular-centric perspective.

Conflated with subjectivity, which has been written and philosophized as the purvey of men, the gaze is generally linked to masculinity by virtue of its connotations of reason, truth, and intellect. Disrupting this binarity of subject/object and its

concomitant associations with male/female, becomes a potential source of deconstruction where, owing to the fact that individuals are often simultaneously subjects and objects, the association of masculinity and sight, and sight and subjectivity are rendered meaningless insofar as the words themselves have no intrinsic meanings, only those they have been culturally and politically ascribed. Where the juxtaposition of purportedly oppositional categories reveals the ambiguity of simultaneous inhabitation, Joel Sanders notes this process at work in the gym where

this disturbance of the gaze works in at least two ways: masculine subjects endowed with visual authority can be dispossessed of the gaze through changing configurations of spatial boundaries, while even the most traditional masculine environments are capable of encouraging a transvestite logic of viewing, inviting men to be both subjects and objects of the gaze (Sanders 1996, 21).

In this simultaneity of subject and objecthood is the concession of submission which, equating to interiority and therefore femininity, disrupts heteronormative binarity by exposing the reality that the gaze is ambiguous and individuals are always, inherently both/and rather than either/or.

Being that one cannot have a perspective on their own body – because it is from their body that they have a perspective on the world (Grosz 1994, 92) – this perspective, thought to originate in the mind or the subjective, is inevitably dependent on the objectivity of others' bodies which serve as a point of reference for our own subjective knowledge of both mind and body. Likewise, since our subjective conception of our bodies is equally reliant on the affirmation (or, conversely, rejection) received as the object of other subjects' gazes, we become objects in our search for subjectivity. Thus, where

subjecthood is contingent on objecthood, both our own and that of others, humans are always simultaneously both subjects and objects, the seeing and the seen. Where the subjectivity of the gaze has primarily been afforded to men, “within the confines of the gym, whose mirrored surfaces disperse the gaze in many directions, men willingly submit to a process of scopophilic objectification, readily assuming a receptive position so that they might ultimately attain physical supremacy” (Sanders 1996, 22-23) a process in which the gaze, and its patriarchal and binary affiliations, is disrupted by the simultaneous juxtaposition of subjectivity and objectivity, dominance and submission, exteriority and interiority. Here the gaze and the body that wields it is shown to be inherently ambiguous by its embodiment of both/and.

Where the NBCC provides contingencies for male or female restrooms only, for example, the binarity of building legislation discourages non-binary gazes including those not natively sexed by denying space for them in the built environment. Providing spaces that are both/and instead of either/or creates the potential of multiple gender inhabitation while a deliberate simultaneous conference and refusal of the gaze in the interior environment has the potential to disrupt the act of seeing and power by questioning the assumption of visual hegemony and either/or truths.

As a space or an act in which subjectivity and objectivity materialize, the gaze functions like Plato's chora - an ambiguous, fluid and liminal space and state of being – which will be discussed further in the next chapter, but in a constant state of looking and being looked at, constantly

renegotiating subjectivity and objectivity “the performance of gender in space not only shifts with each performance, but in a very real way each performance also changes the space in which it is performed” (Doan 2010, 638). With the negotiation of gender changing the nature of space, “because each performance is subject to the performer, the observer, and the space in which it is performed and if that space is also in flux, then we have an infinite array of possible genders” (Ibid, 639).

2.1.2.1 Multiplicity

This simultaneity challenges the widespread expectation that, “...every one of 6 billion human beings must fit themselves into one of only two genders” (R. Wilchins, *A Continuous Non-Verbal Communication* 2002, 13). The predominant two-gender system is inadequate to account for a vast multiplicity of sexed and gendered bodies and

identities whose experiences and simultaneity of gendered subjectivities cannot be contained by an either/or, male or female structure. The sheer number and diversity of perspectives from and about different bodies and identities in collections like *Gender Outlaws: The Next Generation* (2010), *GenderQueer: Voices from Beyond the Sexual Binary* (2002), and *Nobody Passes: Rejecting the Rules of Gender and Conformity* (2006) evinces the multiplicity and fluidity of sexes and genders both within and without the conventional male and female. The conclusion being that, “since no two bodies are exactly the same, the binary system is essentially flawed, there are innumerable types of ‘sexes.’ Just as gender is plural, so is biological sex” (Rodriguez 2010, 4).

The naturalness of the conventional binary is contested by both Martine Rothblatt’s *The*

Apartheid of Sex: a Manifesto on the Freedom of Gender (1995) and Riki Wilchins’ “A Certain Kind of Freedom: Power and the Truth of Bodies – Four Essays on Gender” in *GenderQueer: Voices from Beyond the Sexual Binary* (2002, 32) by citing examples from the animal kingdom where there is evidence of “...a seemingly limitless number of variations of sexual types. Many species are either male and female simultaneously or sequentially” (Rothblatt 1995, 26).

Gender theorists and activists are thus arguing for a multiplicity of sexes and genders. Though less a deconstructivist text, sexual difference theorist Luce Irigaray’s *This Sex Which Is Not One* (1977) speaks by virtue of its title alone, albeit unintentionally, to the multiplicity of gender by suggesting that ‘this sex,’ which I would argue refers to all sex, is always already multiple.

Elizabeth Grosz alludes to the same suggesting that in defiance of a heteronormative dictate, “its domination may be undermined through a defiant affirmation of multiplicity, a field of differences of other kinds of bodies and subjectivities” (Grosz 1994, 19; emphasis mine), whereby it is not about sexual or gender difference as though there was just one, but a plurality of differences. Just as compilations like *Gender Outlaws: The Next Generation* and *GenderQueer: Voices from Beyond the Sexual Binary* will attest, “...there are pluralistic gender histories, pluralistic challenges to the male/female, woman/man, lesbian, butch/femme constructions and identities... [a] multiplicity of biological and constructed selves” (Nestle, *Genders on My Mind* 2002, 9). Though articulated in different ways, and captured by different experiences, the myriad of documented experiences evidences a multiplicity of gendered

bodies, expressions, and subjectivities.

Though by Butler’s account deconstructing heteronormative thinking is not to be achieved by establishing the proliferation of gender, but by exposing heteronormative ideologies’ inability to enforce their own mandates - necessitating perpetual repetition, their failure is revealed (Butler 1993) - I would argue that a proliferation and multiplicity of sexes and genders exposes this failure by exposing the artifice of the dichotomous two-sex, two-gender system on which heteronormative ideology is founded, and thus dependent. The multiplicity of sex and gender divests heteronormativity of its authority by calling into question one of its central precepts. Permeated by heteronormative and cissexist binarity, however, conventional architecture and interior design does not recognize this multiplicity.

2.2 Queer Space

“I live in a very liminal place. ‘Liminal’ means an ‘in-between place.’ It means in a doorway, at dawn or at dusk. It’s a lonely place. In the theatre, it’s when the lights go out. And before the performance begins.” (Feinberg 1996, 143; quoting performance artist Jennifer Miller).

A significant number of authors allude, whether directly or indirectly, to an intersectionality of identity that is both liminal and fluid (Clare 2009; Mattilda 2006; Nestle, Howell and Wilchins 2002). These experiences resonate with both the inhabitation of the body as well as the body’s inhabitation of the built environment and thus, with

the means by which hetero and cissexist ideologies might be undermined. Where the body is central to heteronormative ideology and, given the conflation of architecture with the body – as per architectural icons like Vitruvius – the built environment is similarly significant. Just like rethinking the body forces a rethinking of binary gender conventions, so too does a rethinking and reconfiguration of space toward creating queer space. Though queer space, like queer identity, is sensitive to shifting cultural and temporal circumstance meaning that it is not unanimously experienced or understood (McLeod 1996, 21), academic Christopher Reed identifies some characteristics – characteristics paralleled by

the diversely gendered voices of this literature review which, though their manifestation may change, can be used to establish and identify queer space. For Reed queer space is located in the interstices where reclamation of the abject results in a juxtaposition of the accepted with the repressed, a juxtaposition which ultimately produces a sense of imminence or becoming. For embodiments, expressions, and desires to whom subjectivity is generally denied, this notion of imminence implies a sense of agency which in itself juxtaposes the abject with the accepted and yields both a sense of fluidity, while also situating it in a space of liminality or limbo where what is waiting to happen is about to take place – that moment in the wings when the lights in the theatre go out but the play has not yet begun (Feinberg 1996, 143).

2.2.0 Subversive Re-appropriation: Queering Plato's Chora

The idea of the chora is one that encompasses this imminence in both its liminality and its fluidity. When Plato invokes the term 'chora,' he refers, according to Grosz, to a space that "...designates and locates a point of indeterminacy or undecidability" (Grosz 2000, 211), a space in which material objects come into being, shaped and imbued with the characteristics appropriate to some predetermined nature. There is a patriarchal undercurrent in Plato's original conception of the chora that is problematic, but I would argue that it has the potential to be reappropriated, not as an intermediary that produces some final, perfect form, but rather as a queer space, an inhabitable subjectivity or state of being whose liminality and fluidity defy both Plato's original binary-gendered misogyny as well as hetero- and cis-sexist ideology.

The term is attributed to Plato who uses it to identify a liminal space of meaning making where forms take shape, but a space which itself has no unique qualities. Its only defining characteristics are themselves indeterminate – neither being or non-being. While Grosz cites this as a space of women’s oppression, taking it up to argue in favour of sexual difference theory, I would argue that it is highly suggestive of the kind of multiplicity evidenced in the previous section. Plato’s own inability to define chora is evidence of its own limitless liminality and speaks to both the juxtaposition and the ambiguity of transgressively and multiply gendered bodies. Described as both intelligible and unintelligible, neither rational nor material, and devoid of attributes (Grosz 2000), chora embodies the ambiguity of gender variance and is only attributeless inasmuch as it has been named as such. It constitutes, like non-natal and

non-binary subjectivities, a position that we do not recognize as a viable subjectivity, space, or state of being and is, therefore, constructed as an invisible space without definition. It only lacks definition, however, because it does not fit neatly into predefined categories of socially and culturally recognized attributes and generally speaking, society refuses to acknowledge the subjectivity and viability of people and spaces that do not conform to these categories (Link, Vision 2002).

Where Grosz approaches Plato’s chora from the perspective of second wave feminism and sexual difference, her analysis can be read alternatively as a reappropriation that embraces the imminence and liminality of the chora as a queer space rather than an intermediary that produces some ideal form or being. Though Grosz speaks specifically of women and to a particular definition thereof, her statement

can be used to encompass all those disenfranchised based on sex and gender variance and suggest that

the project ahead, or one of them, is to return [them] to those places from which they have been dis- or re-placed or expelled, to occupy those positions – especially those which are not acknowledged as positions, ...partly in order to be able to experiment with and produce the possibility of occupying, dwelling, or living in new spaces, which in their turn help generate new perspectives, new bodies, new ways of inhabiting (Grosz 2000, 221).

These new ways can be found in the liminality and fluidity of both subversive bodies and identities and queer space whose perpetual in-betweenness engenders a sense of imminence, or agency that stands in defiance of the permanence and transparency espoused by dominant gender narratives including Plato's original conception of the chora. The chora, through a queer appropriation, is a space not to be passed through

and exited, but one to be occupied in a permanent state of becoming where liminality and fluidity, and the imminence they produce, constitute a defiant in-between subjectivity.

2.2.0.0 Liminality

Subjectivity is one of these positions from which both women and members of non-normative communities have traditionally been expelled and in a heteronormative society liminal spaces are precisely those spaces which are unacknowledged by virtue of the excommunication of the in-between, a space wherein we find subversion. In a capitalist culture predicated on engendering a society of lack, where ideals of masculinity and femininity are setup precisely to be unattainable in order to sell consumers the right products and brands of masculinity and femininity, everybody and every body is left in a constant state of

becoming, a constant state of indeterminacy or in-betweenness (Dworkin and Wachs 2009). Thus the human race, regardless of gender expression, never actually emerges, fully formed from Plato's chora. Where some queer folks embrace this indeterminacy, embracing and celebrating the inability to be categorized (Munson, Liminal 2002), it represents a return of the repressed³ for those who subscribe to hetero and cis-normative narratives of permanence and singularity. Being abject in patriarchal and even some feminist and gender

3. In Sigmund Freud's definition the uncanny is the return of something repressed. Describing "the uncanny [as] that class of the frightening which leads back to what is known of old and long familiar" (Freud 1955, 220), the repressed is some part of the self that is personally or, often, socio-culturally disavowed. In that sense the return of the repressed or the uncanny "belongs to two sets of ideas, which, without being contradictory, are yet very different: on the one hand it means what is familiar and agreeable, and on the other, what is concealed and kept out of sight... everything is unheimlich [uncanny] that ought to have remained secret and hidden but has come to light" (Freud 1955, 224-225). Thus gender variance is uncanny because it represents a familiar, but repressed, abject, an abject which, as Julia Kristeva argues, is always already part of the self or the accepted (Fusco 2006).

discourse, liminality and the ambiguity it represents is fundamental to queer spaces which "...stress the reclamation (often through nostalgia) of what has been devalued in a way that exposes (often through exaggeration and incongruity) the structure of assumptions undergirding normative values" (Reed 1996, 68). Through an embrace of the architecturally liminal, then, one can begin to unpack the heteronormative values inscribed in a building and stage a reclamation of the chora as a celebration of in-betweenness.

2.2.0.1 Fluidity

In rejecting liminality, dominant architectural and gender norms present a fictitious picture of permanence. In contrast to this presumed fixity both of the human body and the architectural body - where the sexed and gendered body is analogous to built form - the multiplicity and ambiguity of

sexed and gendered bodies opens up a space in which identification, embodiment and performance are shifting desires that may be different at any given moment on any given day. As a liminal space, the chora represents a space in which the body, in a state of becoming, is fluid. Thus, queering gender and interior environments destabilizes the conventional, binary configuration of gender; a fluid model of sex, gender and space undermines the necessary correspondence of gender to genitalia⁴. Not only do queer spaces and “trans-bodies transgress and threaten compartmentalized dichotomous/dualistic

4 This is not meant to suggest that a person does not or cannot derive some sense of identity from their genitalia for certainly anatomy is intimately bound up in sexuality and sexual pleasure. I only mean to impress that the particular influence of one’s sexual organs on their identity and expression is not a universal given and most certainly not divided into two heavily circumscribed categories. I am arguing that having a penis can result in a multitude of different identities and expressions, desires and pleasures just as much as having a vagina or any one of many combinations of body parts can do the same. Furthermore, these identities and expressions are as permanent or ephemeral as the individual perceives and desires them to be.

borders. They reveal that many presumed polarities are never quite polar and that identity itself is always already a matter of bleeding and extension” (Bloodsworth-Lugo 2007, 62). Where fluidity of body and identity characterizes the experience espoused by many of the voices contained in the literature consulted for this project, the transliteration of this experience into the built environment is essential in creating a space that acknowledges some of the common themes in queer literature’s alternative conceptions of gender. Architecturally this sense of fluidity can refer, not just literally to open concept design, but to the manipulability of space, the fluidity of functions and bounding elements, fixtures and fittings, encompassing a blurring, crossing, and defiant straddling boundaries.

2.2.1 Imminence

The culmination of these liminal and fluid conditions creates a sense of imminence.

Describing the chora as “...the nurse of becoming” (Grosz 2000, 212), Grosz points to a liminal zone of fluid materialization, the effect being a sense of something always about to take place. Thus, in place of the rigidity and fixity of cis and heteronormative system, authors like Reed who suggests that queer space and identity is marked by this sense of imminence, and Katie Diamond and Johnny Blazes who assert “I have always been becoming what I am right now” (Diamond and Blazes 2010, 9), speak likewise to the sense of something always about to happen, to the changeability and agency of the individual in their ongoing construction and renovation, inhabitation and mobilization of sex, gender, identity, and space (Lowrey 2010).

Like the negotiation of gender, queer space is characterized by this sense of becoming which for Reed, is made manifest through renovation and the ways in which it “...transforms what the dominant culture has abandoned so that the old and the new are in explicit juxtaposition” (Reed 1996, 68). In a permanent state of transformation, then, the imminence of renovation exposes the very transience of the built environment which it is employed to disguise. Where heteronormativity permeates the built environment, its own instability is inherently exposed in the process and this imminence, whose etymology derives from the Latin *imminere* meaning “...to loom over or threaten, it means ready to take place” (Reed 1996, 64), threatens the foundations of a hetero and cisnormative order. The emphasis becomes, not the transparency of what the body or the individual’s gender identity is, but its becoming something and

marks a defiant refusal to be categorized as either/or.

One of the ways in which renovation is made manifest is through traces which leave behind evidence of inhabitation, evidence that wears away layers of projected permanence to reveal the patina of time and the body. From these traces queer space elicits a sense of imminence through the implication of presence manifested by something absent. Thus, where Reed argues that “queer space is the collective creation of queer people. But that doesn’t mean it disappears when we leave...our traces remain to mark certain spaces for others - to their delight or discomfort - to discover” (Reed 1996, 64), the imminence implied by these traces recalls the essence of queer habitation.

In a desire to project permanence, contemporary architecture, particularly since the advent of modernism, disdains traces and makes significant efforts to deter them particularly in spaces like fitness clubs and locker rooms where bodily excretions like sweat and odour are prevalent. Queer spaces, on the other hand, embrace traces as a reclaimed abject. Traces, by retaining a record of past inhabitation, expose the impermanence and constructedness of the built environment and, thus also, where they pervade architecture and design, the manufacture and deception of cissexist and heteronormative ideologies.

2.3 Deconstruction

As a juxtaposition of old and new, traces act deconstructively to question assumptions about the built environment. Both Reed and Butler, working from the inside out, advocate using the terms of the dominant system in order to challenge it which is precisely what traces do. With the human body indissociably bound up in conceptions of architecture, and where both have performative potential, there are a multitude of opportunities to rethink cissexist and heteronormative ideologies by employing concepts of deconstruction, reappropriating elements of the existing order as a means of interrogating and challenging the terms of its domination.

Discursively speaking, it can be argued that architecture is already inherently queer. In *Stud: Architectures of Masculinity*, Sanders argues that “a building’s architectural integrity derives from the masculinization of its materials, made to bear the weight of all the cultural values masculinity purportedly connotes, above all, austerity, authenticity, and permanence” (1996, 14), all values which, by virtue of their association with masculinity, are considered antithetical to females and femininity. This process of architectural masculinization, however, is fundamentally ambiguous, transgendered if you will, inasmuch as Wigley asserts that “the feminine materiality of

the building is given a masculine order and then masked off by a white skin. The skin effaces the transformation from feminine to masculine and maintains a division, a visible line, between structure and decoration as a gender division. This overt difference veils the fundamental ambivalence of the building's identity" (Wigley 1992, 354).

Based on a reading of several canonical architectural texts, including the works of Vitruvius, Alberti, and Filarete, Diane Agrest points to a trans undercurrent in the position of the architect themselves who is described in these texts as conceiving and giving birth to their buildings.

Originating from eras in which architecture was the exclusive purvey of men, this reference is significant. Though none of the authors intended this to be the case and Agrest herself treats the trans-ness of the texts as antifeminist⁵ rather than an affirmation of sex and gender as multiplicitous,

non-binary realities, the fact remains that the analogy of the architect to that of a mother speaks to a juxtaposition and simultaneous inhabitation of apparent contradictions, questioning forgone conclusions about what bodies and expressions constitute 'man' or 'mother.'

The idea that calling a man 'mother' is contradictory (Vesely 2012) is only valid so long as one accepts hetero and cisnormative definitions that construct father and mother, male and female, and masculinity and femininity as being at odds with one another. What this juxtaposition of seemingly irreconcilable positions reveals is the very nature of architecture's ambiguity, the very irrationality of dividing male and female into oppositional

5. From a sexual difference perspective, Agrest discusses the analogy of the architect to a mother as evidence of men's attempts to repress women by usurping the roles that traditionally make them unique. (Agrest 1999, 364)

categories. Rather than negate each other, these examples of ambiguity draw the same conclusion: “the act of creating interior space is a strategy that is naturally transgressive, ...an act that interprets, conforms to, or even disobeys existing orders” (Brooker and Stone 2010, 25), but like gender and the body, architecture’s⁶ natural ambiguity and potential radicality is suppressed, curtailed by heteronormative definitions and mechanisms that seek to control the unruly and ambiguous. The reappropriation inherent in deconstruction offers a means by which to acknowledge the unruly and ambiguous.

6. As befitting the deconstructivist tone of this project, I do not setup architecture and interior design as separate, oppositional entities, particularly given their frequent conflation with binaries of masculinity and architecture as contrary to femininity and interior design. I use them interchangeably for the same reason that many trans authors and individuals refuse to limit themselves to one pronoun. Architecture and interior design are part and parcel of a multitude of elements that comprise the built environment.

2.3.0 Return of the Repressed

As a philosophy, deconstructivism can be read as a questioning of inherent truths that reveals instead, that all structures, both physical and social, are inherently queer and that ideas of purity and essentialism, means by which to mask this latent queerness, only succeed in exposing them. In that sense, deconstructivism embodies a return of the repressed where, instead of demolishing existing structures, it works within them to expose their ambiguity. Wigley differentiates deconstruction from outright obliteration by explaining that

deconstruction is not demolition, or dissimulation. While it diagnoses certain structural problems within apparently stable structures, these flaws do not lead to the structure’s collapse. On the contrary, deconstruction gains all its force by challenging the very values of harmony, unity, and stability, and proposing instead a different view of structure: the view that the flaws are intrinsic to the structure... A

deconstructivist architect is therefore not one who dismantles buildings, but one who locates the inherent dilemmas within the building... by a combination of gentle coaxing and violent torture: the form is interrogated (Johnson and Wigley 1988, 211).

This view not only acknowledges the impermanence and fluidity of architecture and discourse, but problematizes the notion of there being any pure, essential form. Where modernism sought to reveal the innate purity of structure, deconstruction proposed instead that structure⁷ was inherently impure and sought through “gentle coaxing and violent torture” (Ibid.) to reveal the impurity through a distortion of existing or conventional forms. Rather than taking purity to be

7. In this sense, heteronormative ideology, and its architectural manifestation, is the flawed structure, whose latent queerness is exposed through deconstruction. Queer bodies and expressions expose the repressed and coaxes it out through a reconfiguration of sex, gender, and desire while in the built environment it is achieved through architectural form and convention.

synonymous with cleanliness or wholesomeness, I take it more along the lines of homogeneity⁸ whereby impurity, rather than being imperfect, refers instead to a diverse state of being; in contrast to the idea of one pure or ideal form, impurity recognizes the potential of multiplicity and diversity of interpretation and articulation. Based on the idea that this impurity is the natural outgrowth of essentially queer structures, the reconfiguration and rearticulation it recognizes “is particularly disquieting because it seems to belong to the form, to be part of it... It seems to have always been latent there until released by the architect” (Johnson and Wigley 1988, 17). Rather than revealing some hidden defect, then, deconstruction functions more as a return of the

8. Purity: n. A quantitative assessment of homogeneity or uniformity. The American Heritage Dictionary of the English Language via The Free Dictionary online. (Farlex 2000).

repressed. Stifled and disguised, the latent queerness of the building resurfaces through deconstruction as a returned repressed analogous in many ways to non-binary and non-natal sex and gender in society.

Where we rely on the bodies and subjectivities of others to have a perspective of ourselves (Grosz 1994), gendered subjectivity is a composite both of the performances and embodiments other bodies manifest, as well as the reactions they express toward the embodiments and performance we manifest ourselves. Thus, we recognize in others both the expressions we have embraced as well as those we have rejected. With respect to non-binary and non-natal sex we are faced with repressed subjectivities where, in a cis and heteronormative society that encourages the repression of characteristics of the ‘opposite’ sex, these bodies

and expressions are inevitably uncanny, a return of that repressed ‘opposite.’

A self-described curio cabinet of reclaimed and dissected fragments of human behaviour, E. S. Weisbrot astutely attributes the transphobia they encounter to the fact that others “...felt uncanny in the elements and were uncertain about just what to do with the whole. They knew not what to make of me because I was made of them” (Weisbrot 2010, 2-3). The possibility of sex and gender beyond the binary confronts us with a juxtaposition of the accepted and the abject, that which we have been conditioned to recognize as acceptable, normal behaviour and that which we have been taught to reject as unacceptable or unnatural. These expressions, by deconstructing the sexed body and its rigidly gendered associations, force a recognition of our own multiplicity which, since

being named at birth – it’s a boy! or it’s a girl – we have been conditioned to renounce.

Emerging in architectural discourse in the 1980s and 90s as a term referring to works that (re)assembled fragments into a seemingly chaotic but controlled radicality of form, deconstruction likewise challenges architectural assumptions about structure and purity to expose the underlying implications of commonly touted “truths” – whether of architecture, philosophy, linguistics, or the body. Hence, gender variance can be seen as a deconstruction of heteronormative and cissexist conceptions of the sexed and gendered body that, like the deconstruction in architecture, challenges rigid norms of expression and opens up the recognition of new configurations and ways of seeing (Pile 2009, 440).

Like subversive bodies, then, deconstruction operates through performativity which reveals the compatibility, if not complicity, of mutually exclusive, binary terms. A reconfiguration of conventional parts and forms into a juxtaposition of heretofore contradictory terms presents, in their simultaneity of inhabitation, an ambiguity that disrupts conventional conceptions of subjectivity and objectivity as disparate and gendered states of being.

2.3.1 Performativity

The invocation of performativity is not intended to suggest that all gender is performance or theatrics - these two terms, as defined in 1.4.7 (see page 15), should not be mistaken for synonyms⁹. While not all gender is performance, gender and identity is inherently performative. While it has been argued that “...there is room to question whether any

identification, however stable and long-term, actually constitutes having an identity. Identification is always an act, a repetition, a name we give to a collection of discrete traits, behaviours, urges, empathies” (R. Wilchins, *A Certain Kind of Freedom: Power and the Truth of Bodies - Four Essays on Gender* 2002, 25), that repetition of traits and behaviours that constitutes identification nonetheless reveals the performative expression, the establishing and potentially destabilizing act that simultaneously resembles, disrupts, and reinvents the dominant discourse.

9. By performativity I refer, like Butler, to the repetition of norms and the ability of said repetition to both reinforce, but also stage the reinvention, of conventional gender expectations. Where these conventions are enacted in unexpected ways the meanings and assumptions associated with them, their naturalness, and essentialism are called into question and the prevailing heteronormative model of gender identity is challenged.

Where “architecture behaves as one of the subjectivating norms that constitute gender performativity” (Sanders 1996, 13), the built environment is an ideal site in which to challenge cissexist and heteronormative thinking. Its permeation of language has been oft interrogated, but architecture receives less critical analysis in spite of the fact that it plays a covert and strategic part in perpetuating normative assumptions and, thus reinforcing oppressive discourses (Wigley 1992, 392).

As a discipline that has received less scrutiny, “its institutional limits are defined by its capacity to mask its complicity in the construction of the concepts it employs. Gender is such a concept, underpinned by a spatial logic that is masked in the moment of its application to architecture, as an extra-, or rather, pre-architectural given” (Wigley

1992, 330). The idea being that architecture arrives from the same presumed naturalism of dichotomous sex and gender, but through the performativity of, not just inhabitants, but also architectural convention, that which is given or, as Monique Wittig would say, “goes without saying” (1992) is opened up for questioning (Sanders 1996, 13).

One of the means by which this deconstruction is achieved relies on the juxtaposition of presumed opposites which, being proven simultaneously inhabitable and therefore not dichotomous, renders ambiguous and unstable the original terms. No longer in contention, a multiplicity of different identities, expressions, and subjectivities is revealed and the exclusivity of ‘two genders and only two genders’ is potentially laid to rest. Where gender and “sociality in the gym... depends as much on repetition, ritual, provocation and performativity

as does physical training” (Ian 1996, 192), it is a particularly prime example of the ways in which “architecture, through the establishment and alteration of reiterated types and conventions, creates the space – the stage – where human subjectivity is enacted and performed” (Sanders 1996, 13) and thus, is critical in its capacity to ensure the acceptance of assumptions necessary to the success of cissexist and heteronormative discourse (Wigley 1992, 329). That being said, it is equally potent as a site of deconstruction where the performance and embodiment of unconventional and unsanctioned combinations and configurations of sex and gender become more accessible and visible through a deconstructive application of reiterated types and conventions much like Reed and Butler’s philosophies.

2.3.1.0 The Ambiguity of Juxtaposition

The primacy of difference so constitutes our thought that it prevents turning inward on itself to question itself, no matter how necessary that may be to apprehend the basis of that which precisely constitutes it. To apprehend a difference in dialectical terms is to make apparent the contradictory terms to be resolved. To understand social reality in dialectical terms is to apprehend the oppositions between classes, term to term, and make them meet under the same copula..., which is also a resolution of the apparent contradictions (Wittig 1992, 2).

The meeting to which Wittig refers is not just a dialectical one, but also a physical, embodied one whereby subversive bodies and indeed queer space unites, by placing in juxtaposition with each other, the apparently contradictory terms. She, like Butler, locates the subversion of gender in the interrogation and deconstruction of the basic terms man and woman, male and female, and all their attendant

binarisms. The juxtaposition of them as simultaneously inhabitable identifications, proves deconstructive by undermining the either/or mandate and questioning the essentialism and naturalness of cis and heteronormative ideologies.

By insisting that the body be transparent in both its embodiment as well as its presentation of one or the other (Davis, *Ambivalences of Gender: Boys Will Be Boys, Girls Will Be Boys* 1992, 42; Grosz 1994, 10), these have endeavoured to police conformity with their dictates and thus, by positing woman and man as the only possible options, suggests that both/and and neither/nor subjectivities are inconceivable. The expectation of either/or operates as a mechanism of both reproduction and self-preservation – requiring that sex and gender expression be unambiguously male or female ensures that, for the most part, the only gender

expressions produced will be one or the other, reinforcing the presumed naturalness of the either/or dichotomy (R. Wilchins, *A Certain Kind of Freedom: Power and the Truth of Bodies - Four Essays on Gender* 2002, 43). But where “western binaries are reframed and undermined through a thwarting of “either... or” thought” (Bloodsworth-Lugo 2007, 5), in defiance of this either/or dichotomy, both/and and neither/nor as embodiments, expressions, and desires present a performative ambiguity that makes feasible and conceivable non-binary subjectivities (Bloodsworth-Lugo 2007, 6).

This reconception, initiated by the juxtaposition of simultaneous, ambiguous inhabitation reveals the vast matrix of sexes and genders, bodies and performances that the either/or dichotomy can neither restrain nor contain, a gap between their

designs and lived reality. It is in this gap that one finds the liminal space in which cissexism and heteronormativity are exposed as a system, artificial constructs instituted to reproduce their own mandates. Through simultaneous performance and embodiment, and thereby juxtaposition, of multiple and presumed dichotomous gender identities, the ambiguity inhabited by both/and and neither/nor exposes the fragility and apocryphy of the binary system, deconstructing the naturalness and exclusivity of either/or.

Though evident in the diverse collection of gender literature, the potential of both/and is largely absent in the public realm and the built environment. Architecture and interior design have largely ignored the multitude of individuals and bodies, experiences and lived realities that do not subscribe to a fixed, binary, biological determinist system of

sex, gender and desire. Inscribed with this notion of either/or – in its provision of facilities like restrooms and locker rooms, for example – the built environment is largely prohibitive to, and maintains the invisibility of, alternative subjectivities by denying space to those who express or expose the ambiguity of both/and. In defiance of the transparency of the either/or system, “ambiguity, or rather our experience of it, recognizes the possibility of alternative, contradictory, or obscure interpretations. And it is upon this recognition that any number and variety of ingenious equivocations, calculated duplicities, and artful conceits come to be constructed in everyday life as much, perhaps, as in art itself” (Davis, *Identity Ambivalence*, *Fashion’s Fuel* 1992, 22). The aim, then, of this project is to create such a space, one that through the juxtaposition of supposed oppositions creates ambiguity in its embrace of both the accepted and

the abject. In creating this juxtaposition and deconstructing the binarity of categories on which cis and heteronormative ideologies are dependent, there is an acknowledgement that “...we have a multiplicity of masculinities and femininities inhabited and enacted variously by different people..., by the same people at different times” (Paechter 2002, 69), and by the same person at the same time. The challenge, however, is in creating an ambiguity that neither disrupts the functionality of the space nor renders it unnavigable, but one that acknowledges the simultaneity and diversity of embodiments and expressions, of subjectivity and objectivity, through a reappropriation and reconfiguration of structure and space.

2.4 Chapter Two Summary

So long as the built environment subscribes to cis and heteronormative ideologies, the public realm – where the public realm is largely constituted by and within interior environments – is reinforced in thinking that male and female as an exclusive, dimorphic, and dichotomous system is natural and inevitable, and that design practice and legislation is adequately equipped to provide for the needs of all. A design that challenges such precepts might begin a discussion about the ways in which how we design for and conventionally conceptualize gender is flawed, unjust, and needs to change (R. Wilchins, *A Certain Kind of Freedom: Power and the Truth of Bodies - Four Essays on Gender* 2002, 34; R. A.

Wilchins 2003).

There is a multiplicity of sex and gender identities and embodiments that need accommodating and through an examination of the body, queer space, and deconstruction, this becomes possible through a juxtaposition of oppositional terms which, through an invocation of imminence, disrupt the power of the subjectivating gaze.

By deconstructing the terms that perpetuate hetero and cisnormativity – one being language which offers only he or she subjects and another being architecture which offers only men's or women's

facilities – acknowledging the possibility of both/and and neither/nor through design exposes the inherent ambiguity of bodies and identities, and proves binary, gendered conceptions of subjectivity and objectivity both inadequate and erroneous in a human sense as well as an architectural sense. Contrary to the conventionally held assumption that gender must correspond to sex, subversive bodies and spaces open up the possibility of rethinking and reinventing both gender and the built environment (Connell 2010, 32).

The ambiguity of simultaneously inhabiting embodiments and expressions coded as both male and female, as well as subject and object, poses a defiant affirmation of both/and in place of either/or. The forthcoming design thus employs these notions of juxtaposition, imminence, and the gaze in its effort to create a gender inclusive fitness facility

that challenges conventional cissexist and heteronormative constructs.

More specifically, these ideas will inform the layout of traditionally gender exclusive spaces not just common to the North American fitness facility but also to the built environment more generally. A juxtaposition of simultaneous inhabitations of male and female is translated architecturally as juxtapositions of the phallic and the yonic which, in turn, manifest themselves as interiority and exteriority. With respect to queer space, the design creates imminence, not only in the application of materials and traces, but also in the fluidity of spaces, bounding elements, and functions which will inevitably extend the liminal spaces between different functional areas and elements. Liminal elements original to the building are maintained and complemented by the addition of new ones. The

power of the gaze is disrupted through the application of materials and the creation of spaces that provide user control over their exposure to other occupants. Rather than provide an unobstructed gaze, they are used both to facilitate and frustrate it. Vistas and thresholds between spaces, are likewise employed to both the satisfaction and frustration of the gaze with the intent of advocating for the acknowledgment of simultaneous subject and objecthood.

CHAPTER THREE

SITE & BUILDING ANALYSIS



The Manitoba Club
194 Broadway Avenue
Winnipeg MB, Canada
R3C 0R2



Figure 1. Manitoba Club location map. Generated by author.

3.0 Introduction: Physical Overview



Site:

The Manitoba Club (Figures 1-5)
194 Broadway Avenue
Winnipeg, Manitoba

Architect:

S. Frank Peters

Construction Year:

1904

Size:

55 000 sq. ft.

Zoning:

M - Multiple Use Sector

Street Priority:

P1

Current Occupancy:

A2 - Assembly





Figure 2. Manitoba Club - North View. Photo by author.



Figure 3. Manitoba Club - East View. Photo by author.



Figure 4. Manitoba Club - South View. Photo by author.



Figure 5. Manitoba Club - West View. Photo by author.

The Manitoba Club was selected as the site for this project for a number of reasons, both pragmatic and conceptual. Beginning with its tangible qualities, the location of the building has some definite benefits. Its proximity to downtown makes the Manitoba Club a convenient location for business people on their way to and from work as well as for quick lunch hour workouts. Being on the corner of Broadway Avenue and Main Street, this location is readily accessible via public transit – it is steps from the nearest bus stop and only a few blocks from the completed first phase of the rapid transit corridor (see Figure 6).

Listed by the City of Winnipeg as a Banquet/Meeting Hall the Manitoba Club is categorized by the NBCC as an A2 occupancy classification which includes non-residential clubs, restaurants and licenced beverage establishments,

and community halls. This same classification also includes gymnasias. Zoned as M, or Multiple Use Sector, the site is located on an avenue designated as P1 meaning that, as a high priority street, it takes precedence when it comes to maintenance such as snow removal.

3.0.0 Opportunities and Constraints

These and a number of other practical opportunities and potential constraints posed by the building and the site are outlined on pages 96-101.

3.0.1 Building Code Analysis

For a complete building code analysis please refer to Appendix III where an assessment of Fire and Egress, and Water Closets and Lavatories is addressed.

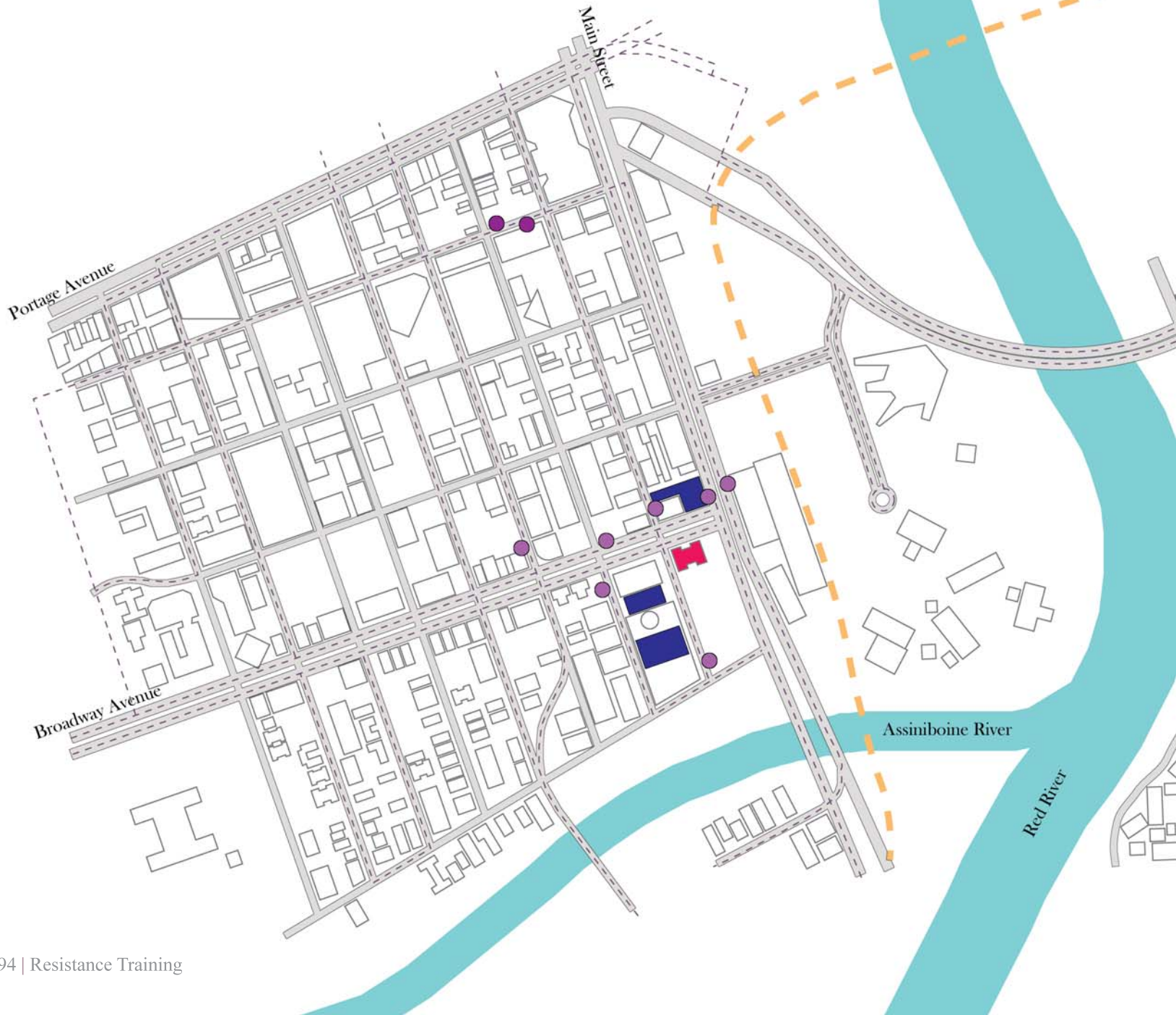

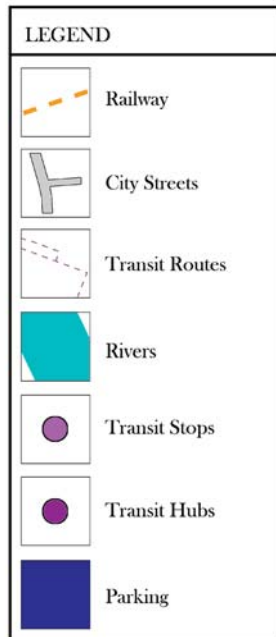

Opposite: Figure 6. Map of transportation and parking

Opportunities

- **Location:** The site is within walking distance of the downtown business sector without being directly on the main thoroughfare and thus not subject to the same traffic volumes.
- **Transit:** Located at the corner of Broadway Avenue and Main Street, the Manitoba Club has access to several Winnipeg Transit routes including the new rapid transit corridor.
- **Resources:** near to LGBTQ friendly businesses and resources (see Figure 7).
- **Priority:** With P1 street priority, priority snow removal means that the building will remain accessible even in winter months.
- **Maintenance:** Ongoing occupancy means that the building has been maintained to a high standard, especially because of its exclusivity and high membership dues
- **Occupancy:** The proposed typology of the building falls into the same occupancy category as the existing categorization which makes the transition easier.

● Klinik on Broadway
545 Broadway Avenue

Opposite: Figure 7. Map of LGBTQ Resources and Fitness Clubs

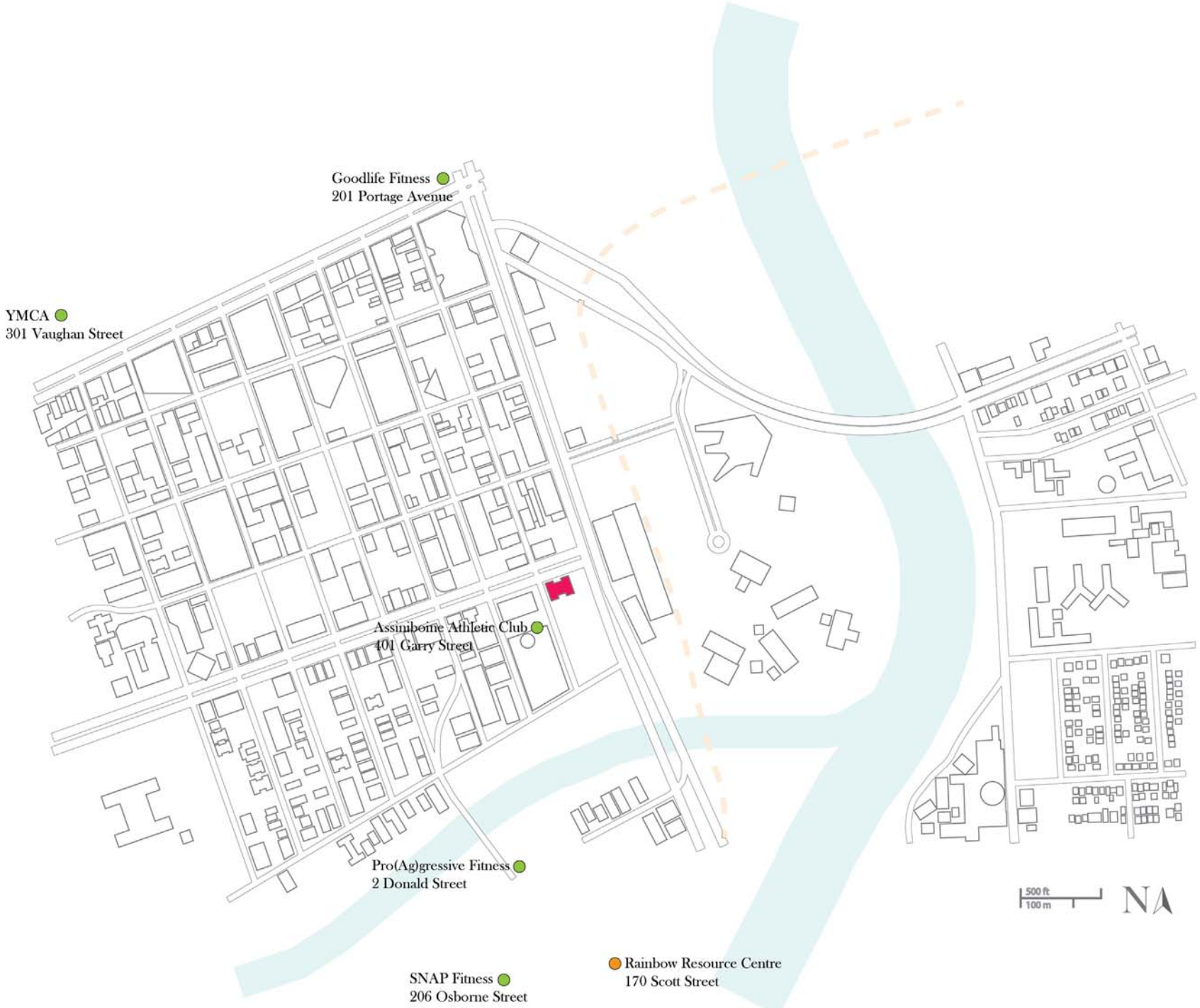

Opportunities continued

- **Visibility:** The building's notoriety and proximity to Manitoba Legislature places the issue of amending gender legislation to include non-binary and no-natal sex and gender on provincial lawmakers' doorstep. It is also nearby to several other institutional, cultural, and historic landmarks including the new Museum of Human Rights (Figure 8).
- **Accessibility:** a wheelchair lift was installed in 1991 on the West side of the building at the Fort Street entrance and the elevator provides access to all floors. Despite making the building accessible for people using wheelchairs, there are some drawbacks to the placement of the wheelchair lift that are discussed below as well as a lack of consideration for other impediments to accessibility which are also discussed.
- **Circulation:** recent renovations to the building relocated the elevator next to the main staircase and nearer to the Fort Street wheelchair lift.
- **Status:** The building is not designated as a heritage site and therefore is not subject to heritage restrictions governing renovation.

LEGEND of LANDMARKS	
	Historic
	Institutional
	Cultural
<ol style="list-style-type: none"> 1. Royal Winnipeg Ballet 2. Manitoba Provincial Legislature 3. Fort Garry Hotel 4. Upper Fort Garry Gate Ruins 5. Union Station 6. Human Rights Museum 7. The Forks 8. Johnson Terminal 9. St. Boniface Hospital 10. St. Boniface Cathedral 11. St. Boniface Museum 12. Universite de Saint-Boniface 	



Figure 8. Map of Landmarks

Constraints

- **Accessibility:** though the building is equipped with a wheelchair lift, it is located at the Fort Street entrance while the main entry is on Broadway. Given that historically the Fort Street entrance was reserved for women, this has a connotation of second class status. There are no visible considerations for people who are blind or deaf. No tactile strips were apparent and fire alarms did not appear to be equipped to address people with hearing impairments.
- **Competition:** The Manitoba Club is positioned in a neighbourhood already populated with several fitness facilities. Right next door is the Assiniboine Athletic Centre while only a few blocks away is one of the city's many Goodlife Fitness centres. To the south is Snap Fitness's Osborne Village location (see Figure 7).
- **Parking:** Not unlike other downtown fitness centres and businesses, 194 Broadway has no dedicated parking lot on site, but there is plenty of parking in the vicinity including public parkades like that at Fort Garry Place. Because it is not a residential area, parking is permitted year round on both the East and West sides of Broadway, with meters in effect weekdays only from 9:00 am to 5:30 pm. Fort, Garry, and Main Street also offer metered parking during the day which becomes free evenings and weekends. The nearby Wawanesa Building at 191 Broadway is also accessible and complimentary weekdays after 4:00 pm as well as all day on weekends and holidays. Right next door the Fort Garry Hotel provides paid and valet parking (Manitoba Club 2013), (see Figure 6).

Constraints continued

- **Structural Integrity:** Cardio and weight apparatuses can weigh anywhere from 250 to 1000 pounds (110 to 454 kilos) per machine which requires significant structural support. The club's Billiards Room hosts 6 pool tables each weighing upwards of 1000 pounds (500 kilograms) plus the weight of occupants meaning that it is structurally capable of supporting a heavy load. However, given the history of the building, extra support has been added to the second floor by increasing the columniation at the first level in order to locate the primary workout areas in historically privileged positions.
- **Construction:** With the lot to the rear (South) of the building undergoing construction, there may be both noise and air pollution. Given that this type of work is normally conducted during the day, it will not have a major impact on the gym's busiest hours which will likely be evenings and weekends. With a number of different functions being housed in the building it will have its own ambient din which will mask most, if not all, of the exterior noise. Given the heat and humidity that accompanies a fitness facility, it is unlikely that windows will be open during the construction since HVAC will be in operation almost constantly, limiting the amount of dust entering the club from the construction site. With the site being converted into a park, it is unlikely that subsequent construction will be as prolonged or as disruptive as it would were the site being developed into a building.

3.1 Architectonics

The architectonics of the building have retained much of the character of its original construction. Despite renovations over the years, the Manitoba Club is relatively unchanged from its original inception; with the exception of an addition made to the southwest corner in 1913, its façade and structure remain unaltered. Thus, despite going through functional and administrative changes, the interior layout has been largely untouched. Based on a review of renovation plans held by the Manitoba Archives as well as on a first hand tour of the main and second floor levels of the building, updates to the interior, though completed using more modern materials, have retained the character

and finishes of the original building. The library and billiards room on the east side of the main floor, for example, have remained in the same place since the building was erected in 1904 and have not been renovated since. Thus, although the politics of the organization have come to be, if only slightly, more inclusive the architecture itself remains, as Rendell has pointed out, invested with the values and connotations of the club's original organization and constituency. Though not explicit in their mandate, the discrimination of men's clubs against women and dandies is evidence of the implicit misogynist, homophobic and transphobic undercurrents that inform the values of such a

typology and, as such, the architecture of the building that represents them.

That being said, as a building whose architectural style is fundamentally classical, it is not without positive attributes. While classical architecture is described as a language that maintains spatial boundaries, hierarchies, and formal constraints, it is also a toolbox. As a database “of forms and procedures that allow a nearly infinite variety of expression... it serves as a framework for atypical and nonconventional expressions” (Semes 2004, 8). In that sense, classical architecture provides a unique opportunity to explore deconstruction and performativity by employing classical tools to reinterpret or reinvent the exclusivity of the Manitoba Club and create a more inclusive environment. Not unlike gender, classical architecture “...can be learned, expanded, and

adapted to changing conditions. It is written in books and embodied in buildings spanning two and a half millennia, and it is still incomplete” (Semes 2004, 15).

3.1.0 Architectural Language

In his *The Classical Orders of Architecture* (2005) British architect and author Robert Chitham credits countryman and architect James Gibbs for influencing early North American architecture through the publication of several treatises that enabled the reproduction of neo-classical architecture in the colonies despite the absence of professional architects. The neo-classical style that Gibbs made popular among Britain’s upper class was thus transmitted to the United States and Canada (Chitham 2005) where buildings like the Manitoba Club were built using the same neo-classical language. With respect to 194

Broadway, this style is particularly evident in the strong symmetry and rectilinearity of the building (Figures 9 – 16). In fact, there is a striking resemblance between Gibbs’ designs and the Manitoba Club exterior including, not only the symmetry and predominant rectilinearity, but also the transom and corner detailing.

The columns (Figure 17) derive from the Tuscan order, which, originating in Renaissance Italy as an adaptation of the Doric column, is notable for its relative lack of detailing as compared to other orders (Chitham 2005, 60). Without the fluting and molding ornamentation common to the other styles, the Tuscan is the most conventionally masculine inasmuch as ornamentation is taken to connote femininity and frivolity. In the absence of detailing, this style is described, by virtue of its contribution to Gibbs’ designs, as “...clean,

straightforward and rational” (Chitham 2005, 107), a description which harkens back both to the Renaissance principles of rationality out of which it was born and to dominant associations of masculinity with reason, and femininity with irrationality. Despite the fact that during this period “the growth of humanism fostered the idea that the obvious could be questioned” (Pile 2009, 124), the focus was rather on discovering cause-and-effect relationships, not unlike that which governs the persistent belief that gender is the direct effect of genitalia. The design of the Manitoba Club, therefore, reflected traditional conceptions of masculinity that were reinforced by the activities that legitimized patriarchy and heteronormativity.

Pervasive in North American culture, hetero and cisnormativity are inextricably linked to other social and personal circumstances such as class. As

Leslie Feinberg suggests transphobia, homophobia, and misogyny developed in concert with class struggles. “Hostility to transgender, sex-change, intersexuality, women, and same-sex love became a pattern wherever class antagonisms deepened... wherever the ruling classes became stronger, the laws grew increasingly more fierce and more relentlessly enforced” (Feinberg 1996, 53) such that narratives of cisnormativity, heteronormativity, and patriarchy became naturalized, resulting in discrimination against many LGBTQ communities in employment and housing opportunities (Grant, Mottet and Tanis 2011). Certain social institutions are specifically designed to highlight and maintain both gender and class difference. Cavanaugh provides public toilets as an example, discussing how “the segregation, first implemented by the Parisian upper classes, was intended to accentuate sexual difference and to project its difference onto

public space. Gender-segregated lavatory design in public was, in its original incarnation, meant to indicate class standing and genteel respectability” (Cavanaugh 2010, 28). As a style that was “perfectly suited to Britain’s eighteenth-century gentry lifestyle” (Chitham 2005, 107), the design of the Manitoba Club is therefore also one that speaks this language of exclusivity in the sense that, deriving from Gibbs’ designs for the British upper class, its architecture reinforces a style that was available only to individuals of high social position which generally precluded individuals who were not members of the white, British, male upper class. Between its design and hefty fees – including an initial entrance fee plus annual membership dues – the Manitoba Club is likewise exclusive, both architecturally and operationally. Thus, it remains largely inaccessible to people who are queer, low income, minorities, and those with impairments.

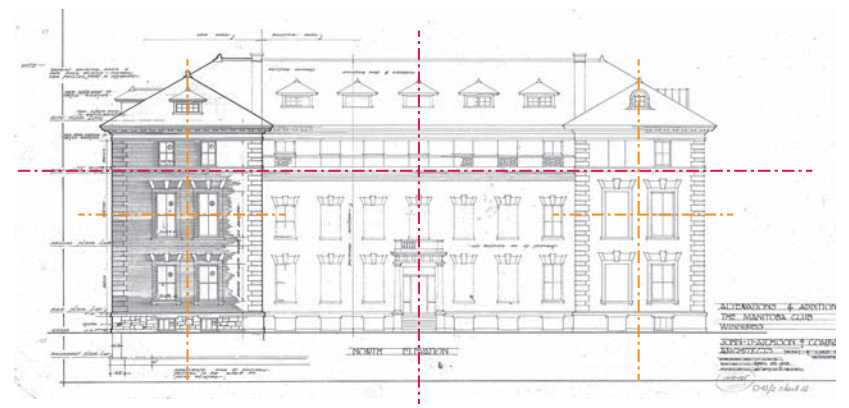
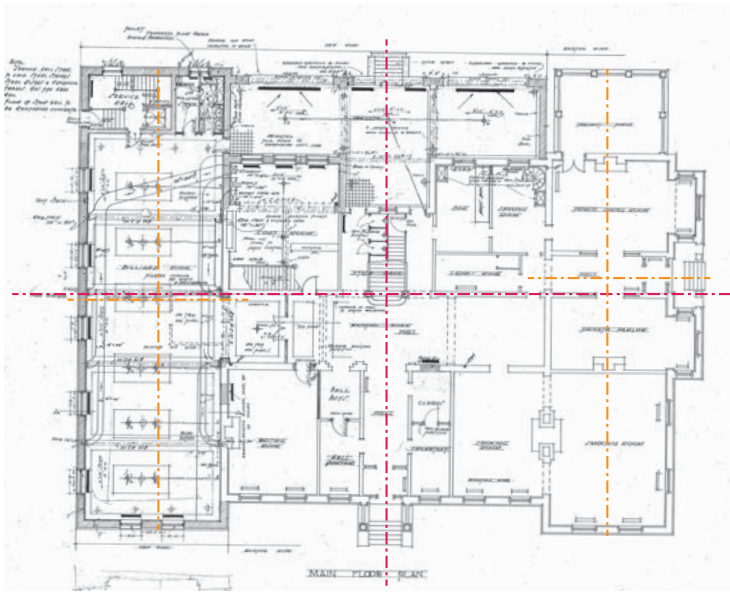

Figure 11. Building Study: Symmetry & Balance - Original drawings by John D. Atchison & Company Architects, 1913. Used with permission of the Manitoba Archives.

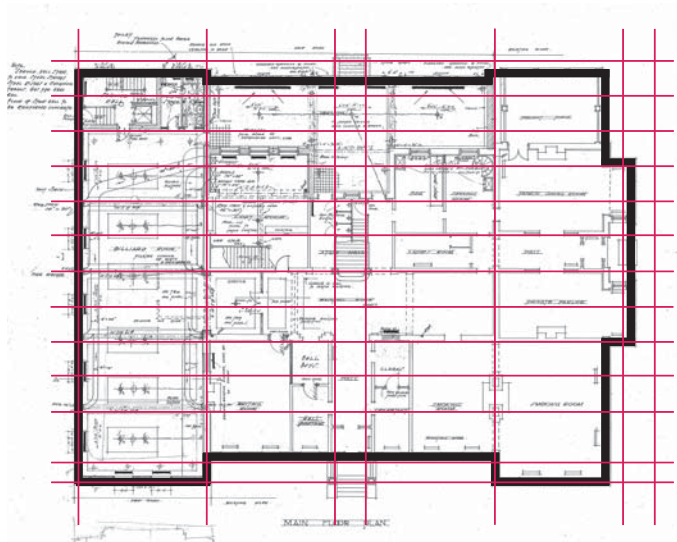

Figure 12. Building Study: Geometry Plan - Original drawings by John D. Atchison & Company Architects, 1913. Used with permission of the Manitoba Archives.

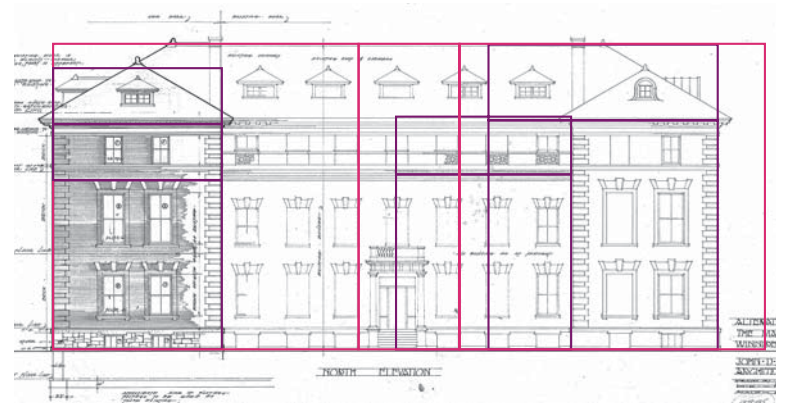

Figure 13. Building Study: Geometry Elevation - Original drawings by John D. Atchison & Company Architects, 1913. Used with permission of the Manitoba Archives.

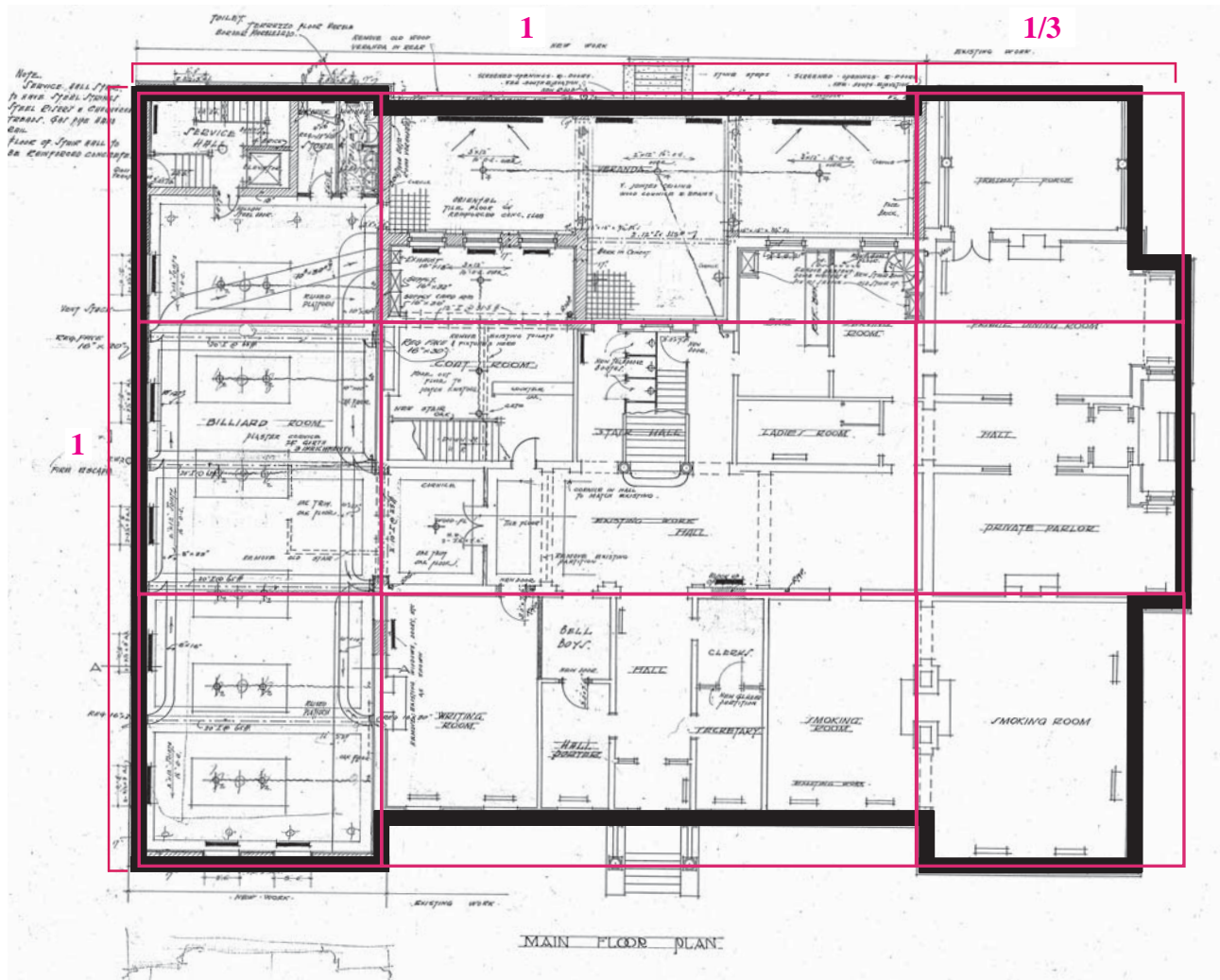

Figure 14. Building Study: Proportions - Original drawings by John D. Atchison & Company Architects, 1913. Used with permission of the Manitoba Archives.

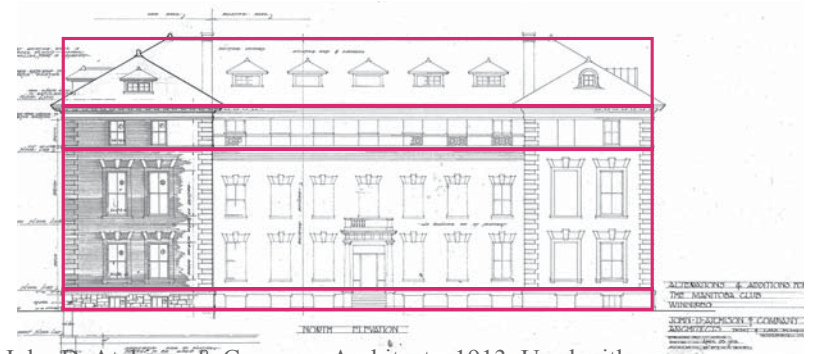
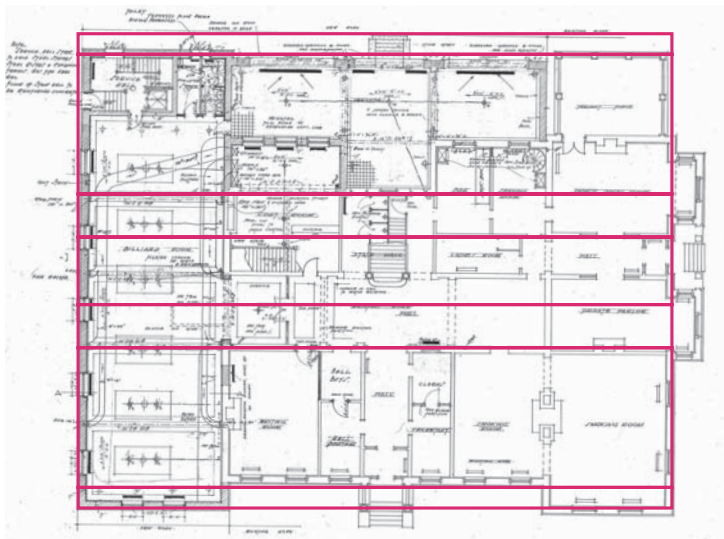
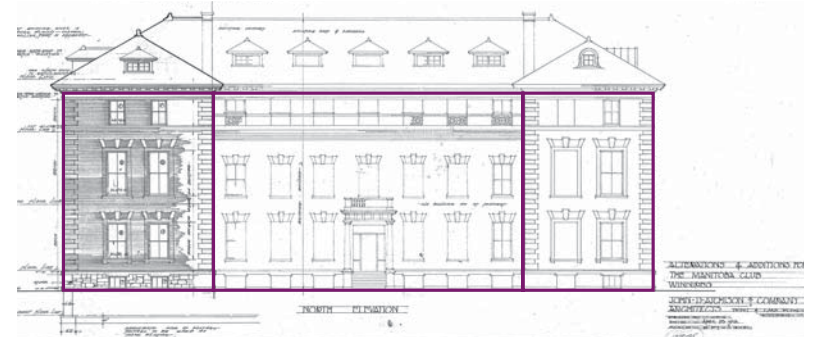
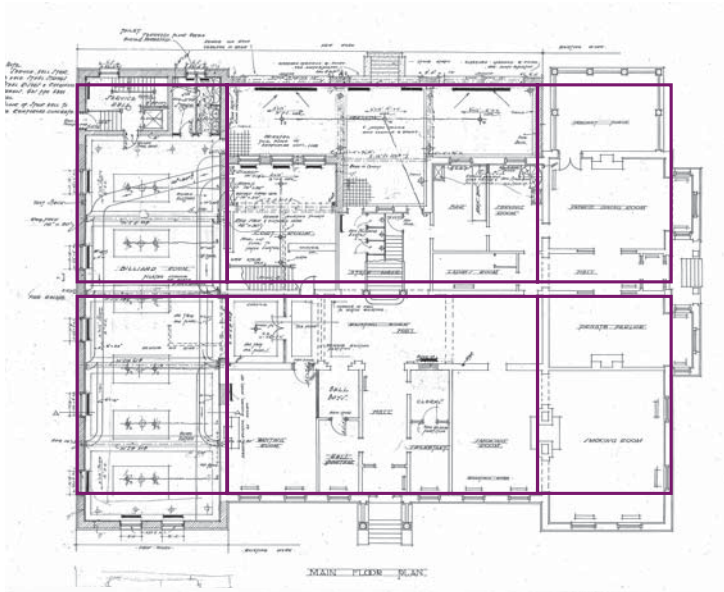

Figure 15. Building Study: Plan to Elevation - Original drawings by John D. Atchison & Company Architects, 1913. Used with permission of the Manitoba Archives.

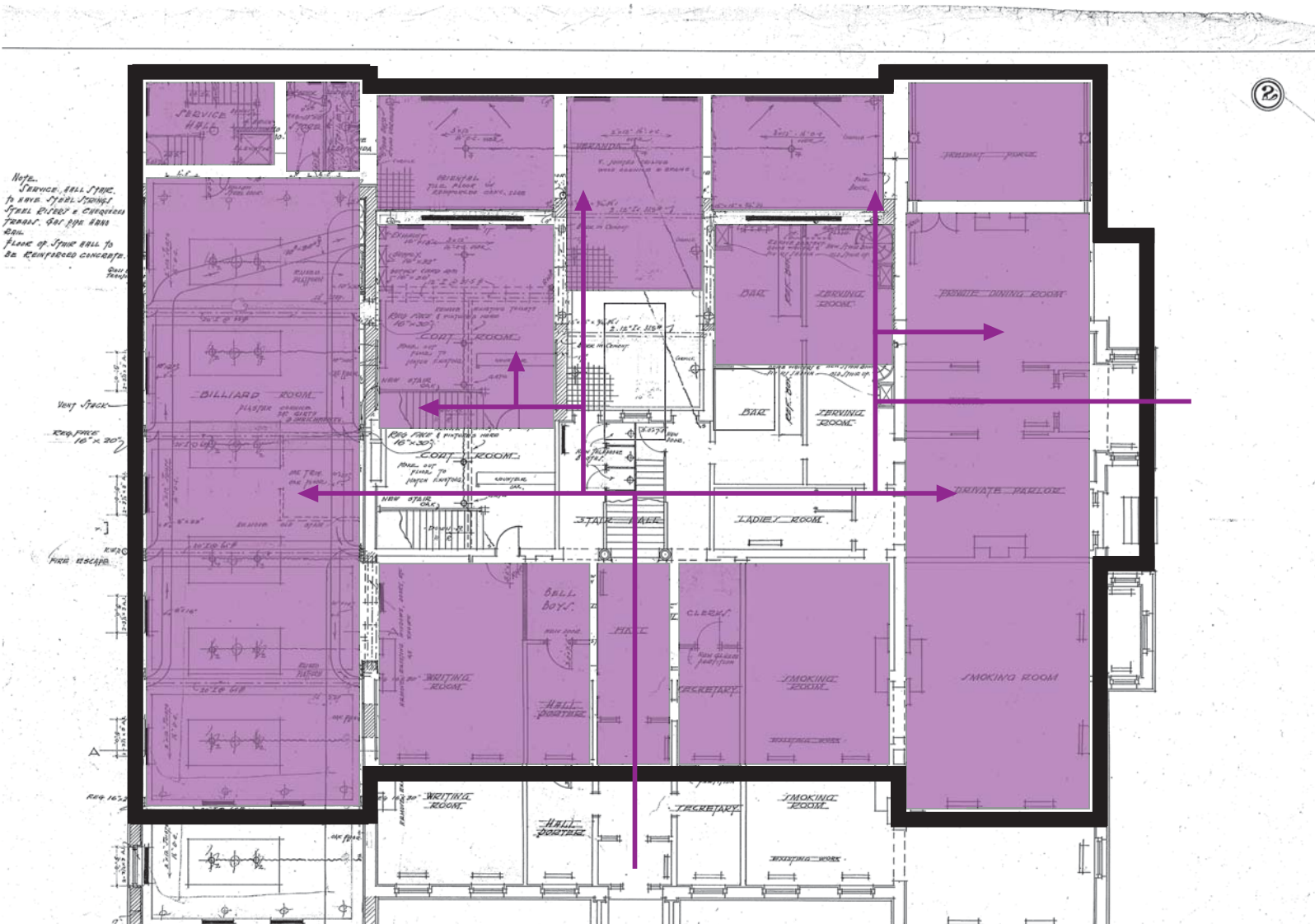
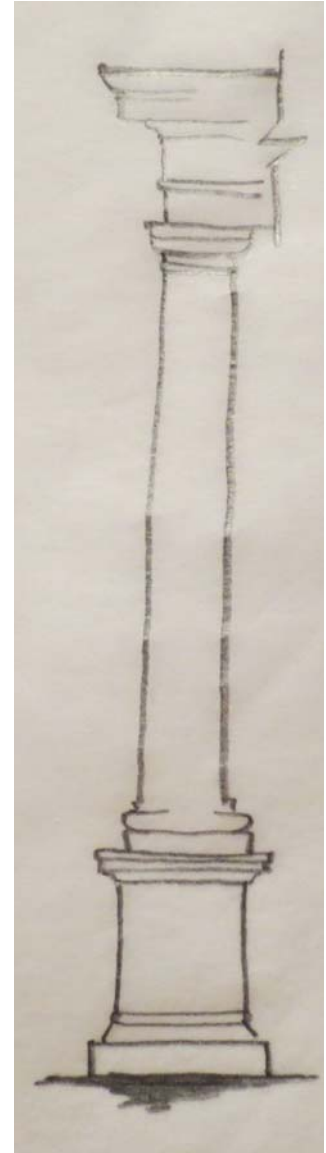

Figure 16. Building Study: Circulation to Use - Original drawings by John D. Atchison & Company Architects, 1913. Used with permission of the Manitoba Archives.

In spite of its language of exclusivity, however, this style embodies a potential for subversion in that it speaks to the femininity of domesticity at the same time as it speaks to its exorcism. Crediting him with establishing “...our [North American] notion of what a proper house should look like” (Chitham 2005, 108), Chitham champions Gibbs as the creator of the architectural epitome of domesticity. Where domesticity is associated with the feminine realm and was categorically denounced both by the members who frequented the men’s club as an escape from the private domesticity of their family homes (Rendell 1999) as well as by some modernist theorists (Reed, Introduction 1996), the referential quality of the Manitoba Club’s architecture to the domestic creates an interesting juxtaposition of the accepted and the abject.

Right: Figure 17. Sketch of Tuscan Column. Generated by author



3.1.1 Geometry & Proportion

The geometry of the Manitoba Club is largely rectilinear as evidenced by the building study drawings (Figures 9-16) where the materiality, spatial planning and openings are all, not only characteristically rectangular, but also conform to the same ratio and numerology. With the width of any of the given rectangles in Figure 13 constituting 1 unit, the lengths of all are equal to 2.25 units which, divided into 1, produces a ratio or 0.4 repeating. This relationship is significant given that the building, both in plan and elevation, and from large scale down to small detail, is divisible by 4 units, a commonality that has potential significance. According to Alastair Fowler, the number four has historic significance in that “in Renaissance arithmology the quadrate was regarded ... as a principle of harmony in nature” (Fowler 1964, 279). As a neoclassical building whose style

originated in the Renaissance, this invocation reinforces the presumed naturalness of the men’s club as a typology and ideology.

While there are elements that are not rectilinear, these are subordinate to the building’s overall language where, in the application of the classical order, the connotations are largely masculine despite any feminine associations related to curvature. Though it might seem overly simplistic, and binaristic to equate masculinity and femininity with rectilinearity and curvature it is not unwarranted given that the club was originally designed exclusively for men and these associations are manifested culturally in places like the fitness club through narratives of “tits and ass” (Ian 1996).



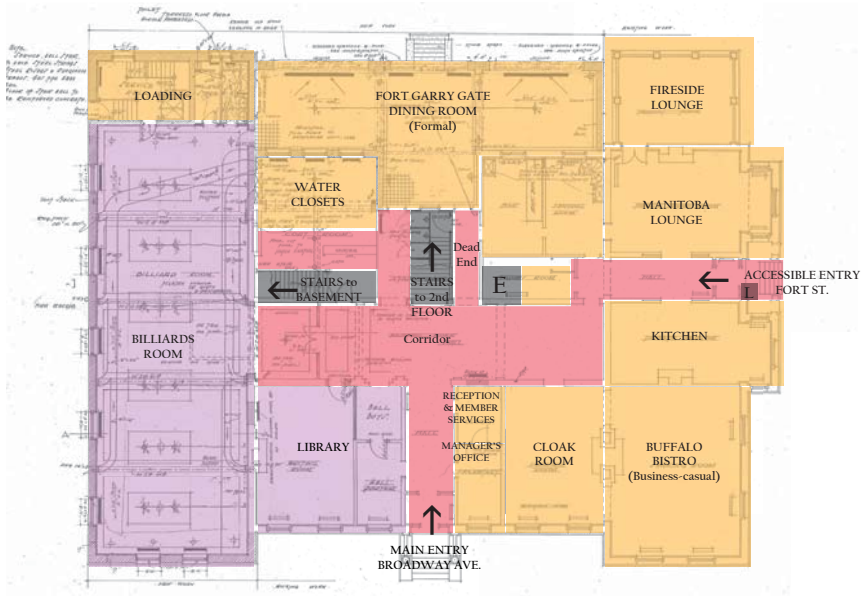

Opposite: Figure 18. Main & Second Floor Plans indicating original materials. Original plans by John D. Atchison & Company Architects, 1913. Used with permission of the Manitoba Archives.

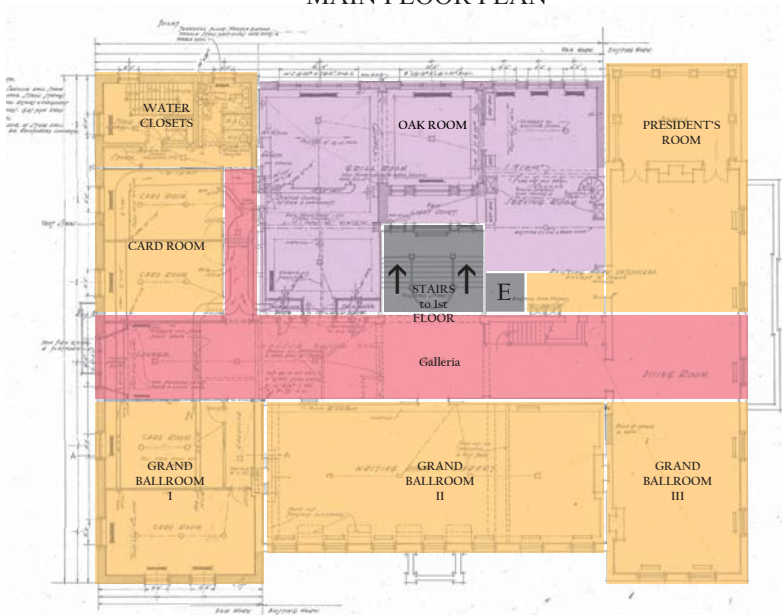

MAIN FLOOR PLAN



SECOND FLOOR PLAN

LEGEND	
	Renovated
	Original
	Horizontal Circulation
	Vertical Circulation

3.1.2 Materials & Structure

Though access to the interior of the building was granted, photo-taking was prohibited. The following outlines the exterior and interior materiality and structure based on my experience of visiting the club as well as archived documents of the building's previous renovations. Of timber frame construction 16 inches on centre, the building is constructed and finished in large part with brick and wood, materials that are traditionally coded as masculine. The exterior brick cladding, arranged in a running bond pattern, reinforces the strict, uninterrupted linearity and rectilinearity of the overall language. As a material itself, brick was, by 1904, an inexpensive material to produce and was desirable for its fire resistance. The interior features a combination of newer gypsum wall board – installed during some of the renovations – and original lathe and plaster. Original wood moldings

are still intact throughout much of the building.

Wood wainscoting and wall moldings predominate with some of the original remaining while other areas have been replaced though in keeping with the original design. The main floor is largely carpeted while new wood floors have been installed in the recently renovated bistro. Some original wood flooring remains in the library, billiards room and second floor north meeting room (Figure 18).

3.2 Intangible Characteristics

Among the less pragmatic considerations for site selection was the history of the site, particularly the gendered history. In order to pose a challenge to heteronormative values, it was necessary that the site selected be an existing, preferably historic, building with a history of heavily gender coded usage. Having examined Jane Rendell's work on the history of the men's club typology, The Manitoba Club was the most promising prospect in this regard.

3.2.0 Gendered History of the Men's Club

Where the architecture of the men's club was

originally designed to reinforce the values of the club and its constituents, both the physical dimensions of the Manitoba Club as well as the functional dimensions of its original occupants construct and perpetuate a dichotomous, two-gender system (Rendell 1999). Because the organization was functionally designed to exclude women, or more generally anyone connoting effeminacy, the building was equipped with physical features designed to segregate the female population. When indeed there was any, the spaces allocated to women - who were not admitted under any pretense of membership but only as visitors chaperoned by male members - were accessible

only via separate rear or side entrances and were designed to reinforce conventional gender stereotypes by facilitating inactivity. Whereas these spaces devoted to women were sitting spaces only requiring the accompaniment of a chaperone, the men enjoyed gaming such as billiards and cards, engaged in displays of sport, expanded their knowledge with a well-stocked library and interpersonal debate and other such active, intellectual, and ultimately non-feminine pursuits.

Like the athletic club, the men's club often functioned, among other things, as "... a place where men met to train and watched each other display physique and sporting skills" (Rendell 1999, 176). As a typology that dates back to the early seventeenth century, it also has a history of patriarchy, not only by virtue of its physical exclusion of women, but also because of the

hierarchies created among its members, between members and staff, and members and non-members. Sport was not only a fixture in these clubs as a public spectacle of masculinity, but also a form of commercial entertainment wherein the accompanying competition and scale both established bonds between members but also established dominance between them and established hierarchies among the membership. (Rendell 1999) "The Manitoba Club [was] founded in close proximity to Masonry in Manitoba and both were havens for the masculine elite [that emphasized] race, respectability, and progress" (Coverton 1993, 3-4).

Aside from their association with sport, the men's club functioned as a place for reaffirmation of patriarchy through displays of masculinity between both members within the same club and between

members of different clubs, as well as between club members and the outside world. As a space of male socialization, one of its most prominent displays of exclusivity and power was its exception to the law by partaking of gambling, an illegal pastime in the early days of the men's club. Where gambling halls were considered base and immoral, they were setup in opposition to, and denied by organizations seeking to establish themselves as legitimate clubs. Viewed as a temptation that stripped men of their reason, the immorality of gambling was associated with femininity in that it signalled submission to vice. The men's club, then excised the female on multiple levels - from their buildings, their activities, and their constructions of masculinity and virtue. The conflation of vice with femininity means that the architecture and interiors of the gambling houses, or hells, were considered indicative of the excess and frivolity of women.

The lavish and ornamented interiors of these gambling houses were seen as deceitful, luring those to be hustled into a false sense of wealth and security. Where lavishness and ornamentation connote inauthenticity and deceit, they were and are also seen as being associated with frivolity, irrationality, and femininity and, indeed, "by the early nineteenth century, gambling's disreputable status was gendered in the feminine" (Rendell 1999, 180). Worse so, were female gamblers, whose double sin – being female and being a gambler – relegated them to the level of prostitutes and effeminate men (or dandies).

While gambling was just as equally a pastime in the "legitimate" men's club, it was justified by the presumed control, rationality, and virtue of their constituency. Where betting in a gambling house was symptomatic of effeminacy and vice, betting

in the men's club was a transgressive act, a defiant thumbing of the nose in the face of the law. The organization of the various activities within the club, for example, reveals this double standard and its binary implications:

the usual location of gambling rooms in clubs on the first floor [above main/ground] along the front elevation was paradoxical. Although this position gave these rooms a protected and special status within the spatial hierarchy, it contradicted the need for an illegal activity to be hidden. One can only suppose that to place such an internalised activity in such an exposed position was intentional and another form of public patriarchal display of exclusivity (Rendell 1999, 179).

While the gambling house was reviled for duping virtuous young men into submitting to feminine vice, surrendering their natural, masculine rationality and control, the men's club was celebrated as a space of male sociality and carefully

managed masculinity. Though this could be argued as an instance of misogyny rather than cis or heterosexism, this conflation of femininity with vice and the construction of masculinity in opposition to and as an exorcism of the feminine is responsible for the binary system that perpetuates all manner of discrimination of sex, gender, and sexuality. The rejection of dandies, which derives from the association of immorality with the feminization of men, speaks volumes to the transphobic and homophobic undercurrent inherent in the binary conceptions of gender evinced by both the men's club and the gambling house, including their gendered associations and unequal conference of privilege.

3.2.1 Potential for Subversion

Based on this gender coded history, the Manitoba Club was conducive to a queering or subversion of

heteronormative ideology. Where academics Christopher Reed and Judith Butler both speak to the importance of working within the dominant order and using its own mechanisms in order to subvert it, the Manitoba Club presented an opportunity to do so by means of design. With its traditionally masculine design and historically gendered functioning (Rendell 1999, 277), the Manitoba Club provided an opportunity to, working within a functionally and architecturally cis and heteronormative order, undermine its dominance and essentialism.

Ultimately this project is aimed at establishing, through the subversion of conventional cisnormative and heteronormative gender assumptions, an inclusive fitness facility that recognizes a multiplicity of sex, gender, and sexuality, subverting the building's architecturally

and functionally patriarchal and heteronormative history through the creation of a space that counters the outmoded norms still being enacted in the realm of the fitness club (Farkas 2007; Dworkin 2007) while also addressing physical, mental and emotional well-being for a multiplicity of sexes, genders, and desires. This particular site offered an opportunity to enact the kind of juxtaposition and performativity proposed by Reed and Butler through the repetition of both cis and heteronormative ideologies and design cues in unanticipated and subversive ways.

Given its long history both as an institution in Winnipeg and as a typology this site is both heavily coded and performative. Formerly a men's only social club – it was not until 1979 that women were permitted to use the front, exclusively men's, Broadway Street entrance and it was 1991 before

they were granted full membership rights (Heritage Winnipeg n.d.) - the Manitoba Club is both functionally and historically imbued with the binary and patriarchy indicative of heteronormative ideology (Rendell 2006, 277) and thereby precludes the possibility of non-normative sex, gender, and sexuality.

Since “it was important that the architecture publically represented the values of the club” (Rendell 1999, 171), which were predicated on an heteronormative exclusion of women and, thus, a two-gender system, the architecture of the men’s club can be said to be encoded with an oppressive and exclusive masculinity. Performative of the ideals and dominance performed and perpetuated by the typology of the men’s club, the Manitoba Club architecture can also be used to undermine it.

Rendell argues likewise that the typology and design is rife with opportunity for subversion of these ideals. Because they function “... simultaneously as both public and private space, clubs complicate the separate spheres ideology of a distinct male, public sphere of the city and female, private sphere of the home” (Rendell 1999, 168) - functioning as a homosocial space where men, escaping from the domesticity of the feminine and familial, retreat to a domesticity of the fraternal. This interpretation reveals the same kind of juxtaposition and simultaneity discussed in the previous chapter where masculinity and femininity embodied by the concepts of public and private (Namaste 2006), domestic and civic are simultaneously inhabited. Thus, the men’s club is predisposed both to ambiguity and to confounding a binary of male and female, and its concomitant, public and private. Approaching this ambiguity

from a gender and queer theory perspective opens up the possibility of disrupting these binaries further by reintroducing the disavowed, the abject. Revolving around traditional notions of family, the intersection of queerness with domesticity is a return of the repressed in a society that disavows non-conventional family structures, particularly those that are unconventional in gender and coupling.

As a space that thus revolved around the repression of the abject – where the abject included and continues to include anything outside male masculinity – this space is well positioned to be reappropriated as a queer space in Reed’s sense of the term. Where his definition involves an imminence created by the juxtaposition of the accepted with the abject (normative with repressed), something always “...ready to take

place” (1996, 64), the conventional character and heteronormative history of the Manitoba Club is primed for just such a queering to take place.

Situated in a predominantly heritage neighbourhood, the area around the Manitoba Club allows for this desired subversion to extend beyond the interior and into the street. Built at a time when Broadway was lined by mansions belonging to Winnipeg’s upper class, the neighbourhood has since become a professional district which, though the buildings might lack the opulence of their turn of the century predecessors, the neighbourhood is largely populated by the upper-middle class (Clerkin 2012). With the chateau style Fort Garry Hotel next door, and Union Station across the street, the Manitoba Club and its surrounding environs, many built between 1904 and 1913, still speak to the same upper class masculinist,

Victorianism. An era that insisted on separate spheres for men and women and ultimately denied a sphere to anyone outside that dichotomy, it was also one that was highly discriminative of race, class, and ability.

3.3 Chapter Three Summary

The selection of the Manitoba Club at 194 Broadway Avenue for this project was based on many diverse considerations. It was critical that, as a space geared toward inclusivity, it be located so as to be accessible to the largest and most diverse population possible. By situating it close to downtown it provides access to a number of different neighbourhoods and by a number of different means. Its proximity to nearby LGBTQ resources places it in a familiar area. In the interest of deconstructing heteronormative attitudes, the history and typology of the building was one of the most important considerations which, as a, formerly men's only, exclusive club, has a history of

gendered exclusion and, thus, discrimination which is reinforced by the building's language, geometry, and materiality. A few constraints, including parking and competition from neighbouring clubs are easily surmountable obstacles that are far outweighed by the opportunities the site offers.

CHAPTER FOUR

PRECEDENT ANALYSIS

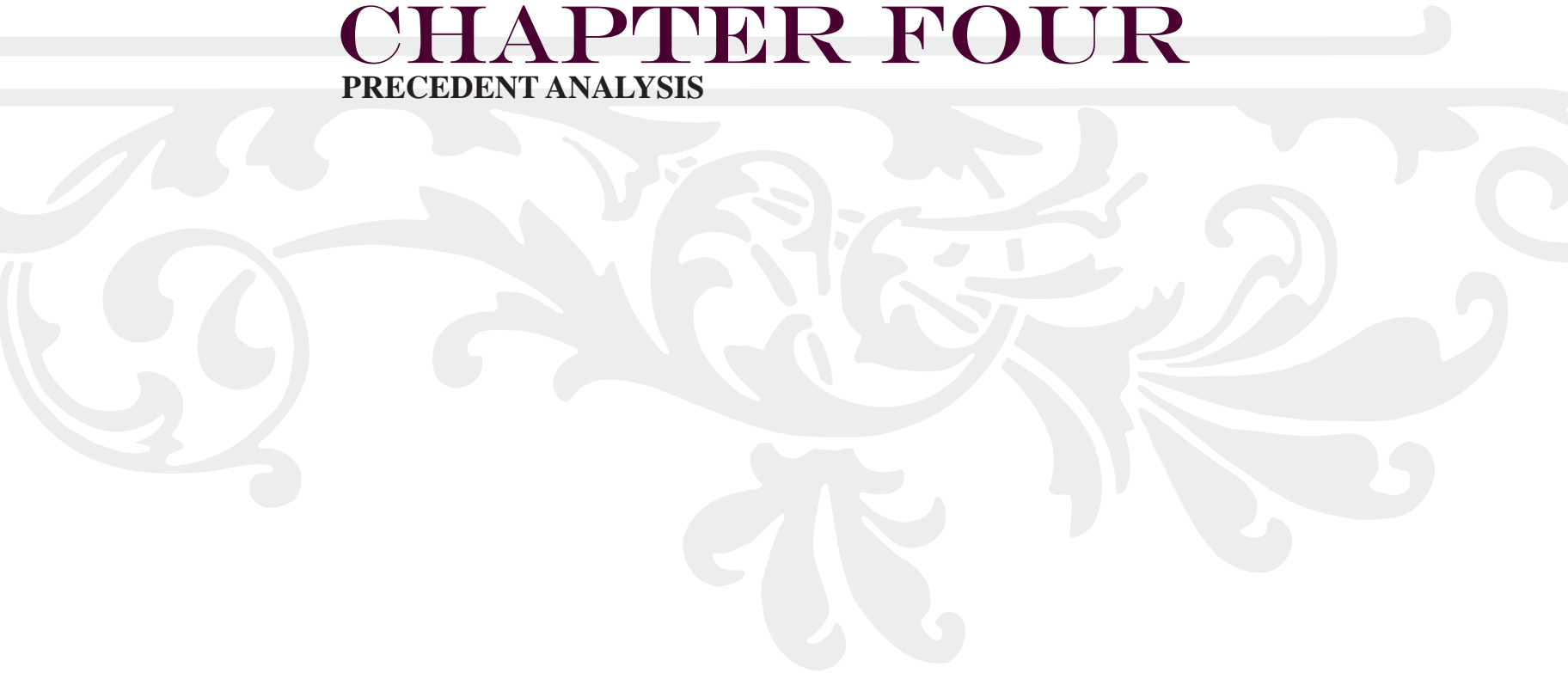

4.0 Introduction

The translation of these ideas relating to the body, philosophy, queer space, and deconstruction - as investigated in Chapter Two - into the final design has been informed by an analysis of three precedents that embody the juxtaposition, imminence, and visual ambiguity desired for the current project. The first, the David Barton Astor Place Gym, is a particularly performative fitness club located in New York City while the second, an LGBT Community Centre also in New York, captures the imminence characteristic of queer space. Finally, Belleville Ontario's Quinte Sport and Wellness Centre addition connects a multitude of functions and users in a uniquely fluid space with elements of deconstructivist

4.1 David Barton Gym

A decorative flourish consisting of a horizontal line with ornate, symmetrical scrollwork and floral patterns extending downwards from both ends.

Location: 4 Astor Place New York,
NY 10001, USA

Designed by: Studio Sofield

Size: 40 000 sq ft.

Date: 1991

With a corporate mandate to “help people get the body of their dreams” (David Barton Gym 2013), the first precedent analyses an American fitness club that captures a deconstructive performativity while also providing some programmatic insight. Though slightly under the size of the current project, David Barton’s Astor Place Gym (<http://www.davidbartongym.com/gallery/#photo>) exemplifies a particularly campy performativity labelled by Barton himself – founder and CEO – as “Victorian punk” (Murphy 2011). Barton’s own highly exaggerated musculature and flamboyant personality – described by newspaper columnist Timothy Murphy as a “self-created, cartoon superhero” (2011) – are directly reflected in the design of this his flagship club which exudes the performativity that characterizes gender and the body, as well as gym and queer culture. In that sense, it provides a cue to the means by which

deconstructive juxtaposition can be achieved.

Exaggerated Victorian furniture and an eclectic style speak to the imminence of queer space. In its specific connection to the modernists’ abjection of Victorian eclecticism (Reed, *Not at Home: The Suppression of Domesticity in Modern Art and Architecture* 1996), Barton’s interior reclaims Victorianism to a degree of hyperbole, juxtaposing the accepted and the abject. The extravagance of the design, with an atmosphere more akin to a nightclub than a fitness facility, is juxtaposed with classical conceptions of the base body - particularly that which defies heteronormative convention - including the concomitant perspiration and odours that attend physical activity. Recalling the lavishness of the denounced gambling house where “the journey to the gambling room - had the effect of dislocating the gambler from the world outside,

creating an atmosphere of suspense and excitement conducive to gambling. On entry to the hell [gambling room], the gambler had to surrender control, give up himself to the unexpected” (Rendell 1999, 179), the Astor Place design is in contrast to the precepts of rationality that attend North American masculinity that, having its origins in the privileged culture of anti-frivolity of the men’s club, pervades environments like the gym. Barton’s gym, then, provides a clue to the ways in which performativity can be employed to deconstruct binarity.

By applying a similarly eclectic design aesthetic, my design juxtaposes the accepted with the abject. The use of eclectic Victorian furniture and lavish materials creates an environment that acknowledges a multiplicity of design styles and thus reflects the multiplicity of sex, gender, and sexuality. Like

Barton’s gym, it employs a variety of levels of lighting and reflective finishes to dramatize the space, the body, and the agency enacted in sculpting the body of one’s dreams. This dramatization also achieves a disruption of the gaze by foregrounding the simultaneity of subject and objecthood that makes the gym an ambiguous, and arguably queer, space in which to see and be seen. Where Sanders attributes this to the fitness club typology in general, Barton’s design draws particular attention to the ambiguity of being both/and.

While theoretically the Astor Place design disrupts subject/object relationships and their gendered associations, its marketing imagery suggests that it is reproducing stereotypes of gendered bodies by reinforcing specific sizes, shapes and desires. Creative programming has the potential to

challenge these stereotypes. A mixture of more traditional and alternative programming allows the accepted and the abject to inhabit the same space simultaneously.

Programmatically, the Astor Place club also lacks some of the more inclusive ancillary services that are becoming more popular in other fitness clubs. Offering group fitness classes and personal training, the chain of David Barton Gyms addresses some of the most basic services available at most fitness facilities, but do not provide services such as massage and athletic therapy or counselling for issues such as nutrition or body image. Though inclusive of and appealing to queer and trans clients, it could be more inclusive if it provided family oriented services such as child minding, and larger opportunities for community building.

Also despite the fact that Barton's gyms attracted a trans clientele, it, like all the fitness clubs I visited in the course of my observational research (Appendix IV), is equipped only with separate women's and men's locker rooms, providing no alternative for individuals for whom these options are not accommodating. With no private change or shower areas, it may not be welcoming for all. While it is possible that the atmosphere in the club is such that individuals are free to use which ever locker room they identify with regardless of anatomy, my project includes desegregated locker facilities that provide increased options both for privacy and sociality in the locker rooms with both private and public change and shower areas that do not demand that an individual align themselves with only one gender. This space incorporates the performativity of the David Barton Astor Place gym, but is differentiated by its inclusion of

services appealing to a larger demographic including parents with young children as well as individuals who identify as both/and, and neither/nor.

4.2 The Centre: LGBT Community Centre

Location: 208 West 13th St. New York,
NY 10011, USA

Designed by: N-Plus Architecture and Design & RSVP Architecture Studio

Size: not given

Date: 2013

The second precedent is informative in its programmatic and spatial functioning which, devised based on user input, fosters both a sense of community and a reflection of queer identity and queer space.

Breaking ground in 2013, New York City's LGBT Community Centre, also known as "The Centre," undertook a 14 month long renovation (Figures 19-22) in an endeavour to create an environment that, in response to years of user feedback, was "...welcoming, functional and vibrant" (Palumbo n.d.). Where the overarching aim of The Centre is to create a space that celebrates the diversity and achievements of the LGBTQ community, the redesign included alterations and additions aimed at providing an inclusive space for socializing and event programming among which were an expanded and more welcoming lobby (Figures 19

and 20), enhanced audiovisual capabilities, and increased multi-purpose space (Figure 22) including a hidden garden café (Figure 21). Based on the feedback of centre members and visitors, these changes supported a desire for increased social space as well as a flexibility of space that could facilitate the exhibition and performance of members' accomplishments.

The importance of visibility and sociality becomes apparent in these desires. The renderings featured in Figures 19-22 achieve this by employing fluidity and liminality that create a queer space. Housing a multitude of activities, there is a fluidity of both spatiality and functionality. Vistas from the lobby into adjacent spaces, as seen in Figures 19 and 20, contribute to this fluidity as does the multi-functionality of some of proposed additions. The furniture pictured in the same figure speaks

likewise to this fluidity while the transitions between these spaces create a liminality in which an individual can be both inside and outside simultaneously. The inclusion of a hidden garden, likewise, engages with this liminality by negotiating interiority and exteriority.

The current project employs some of The Centre's cues to establish this fluidity and liminality. Spaces have the capacity to be temporarily divided – similar to Figures 19 and 20 where structural features divide the reception area but the desk and recessed lighting traverse the two adjacent spaces – such that a variety of types and scales of functions can be supported while each space, even when divided, is connected to those adjacent by some feature, such as lighting or built-in casework, that traverses them all. The manipulability of space that this facilitates creates a space that is constantly

becoming, or imminent, and is more conducive to creating community.

My design also seeks to emulate the way in which this imminence disrupts the gaze by simultaneously offering and frustrating vistas into adjacent spaces. The use of foliage in the hidden garden (Figure 21) succeeds in creating penetrable screens that both allow and obfuscate the gaze and replicate the latent queerness of the gym in the project's ancillary typologies. Though not through the use of vegetation, and not exclusively in the café, my project executes a similar disruption of the gaze through the use of materials and furniture selection and placement.



Figure 19. N-Plus Architecture and Design, and RSVP Architecture Studio. *The Lesbian, Gay, Bisexual & Transgender Community Centre*. [Renderings of Interior by RSVP Architecture Studio and N-Plus Architecture and Design]. Used with permission of Nicola Mongelli, N-Plus Architecture and Design (as per email received April 15, 2014). Image retrieved April 18, 2013 from <http://mycenter.gaycenter.org/page.aspx?pid=315>



Figure 20. N-Plus Architecture and Design, and RSVP Architecture Studio. *The Lesbian, Gay, Bisexual & Transgender Community Centre*. [Renderings of Interior by RSVP Architecture Studio and N-Plus Architecture and Design]. Used with permission of Nicola Mongelli, N-Plus Architecture and Design (as per email received April 15, 2014). Image retrieved April 18, 2013 from <http://mycenter.gaycenter.org/page.aspx?pid=315>



Figure 21. N-Plus Architecture and Design, and RSVP Architecture Studio. *The Lesbian, Gay, Bisexual & Transgender Community Centre*. [Renderings of Interior by RSVP Architecture Studio and N-Plus Architecture and Design]. Used with permission of Nicola Mongelli, N-Plus Architecture and Design (as per email received April 15, 2014). Image retrieved April 18, 2013 from <http://mycenter.gaycenter.org/page.aspx?pid=315>



Figure 22. N-Plus Architecture and Design, and RSVP Architecture Studio. *The Lesbian, Gay, Bisexual & Transgender Community Centre*. [Renderings of Interior by RSVP Architecture Studio and N-Plus Architecture and Design]. Used with permission of Nicola Mongelli, N-Plus Architecture and Design (as per email received April 15, 2014). Image retrieved April 18, 2013 from <http://mycenter.gaycenter.org/page.aspx?pid=315>

4.3 Quinte Sport and Wellness Centre

A decorative flourish consisting of a horizontal line with ornate, symmetrical scrollwork extending downwards and outwards from both ends.

Location: 265 Cannifton Road, Belleville
Ontario, K8N 4V8, Canada

Designed by: PBK/Genivar

Size: 177 000 sq. ft.

Date: 2012

The recently completed addition to Belleville's Yardmen Arena is a programmatically diverse complex. Housing additional ice surfaces, it also features a swimming pool, workout gym, group fitness studio, youth drop-in centre, indoor track, interior courtyard, a café, and offices for local sport organizations. Though different in their spatial and functional needs, the various tenancies of the building remain connected in a number of ways that facilitate opportunities for multiple inhabitation. Ice rinks are linked visually to the main corridor through large sections of glazing that allow spectators to view arena activities from the warmth of the café seating area (Figure 23).

Functions are likewise, linked spatially by openings in the floor plane (Figures 24 and 25) which create a sense of inhabiting multiple spaces simultaneously – a hockey spectator, for example inhabits the ice rink by virtue of their viewing

activity and the seating orientation, the café by virtue of the seat placement adjacent to the food service area, and the upper level by virtue of the atrium open to the second level mezzanine above (Figure 26).

Activities are connected both in the café as well as in the second floor pool viewing area (Figure 27) by these seating arrangements that are fluid in their boundaries. The track likewise, situated as a mezzanine overlooking one of the ice rinks, creates a space whose fluid connection to the activities below provides opportunities multiple, simultaneous inhabitation.

Though somewhat secluded, the offices still share the second floor mezzanine with the other tenancies creating a common corridor connecting all of the building's different functions. The connectivity of

this design has inspired the current project, not only by the way it connects its diverse activities, but also by the way these connections create opportunities for multiple inhabitation.



Figure 23. PBK/Genivar. (2012). Quinte Sport & Wellness Centre. [Images of Interior]. Cell phone photograph by author, December 2013.



Figure 24. PBK/Genivar. (2012). Quinte Sport & Wellness Centre. [Images of Interior]. Cell phone photograph by author, December 2013.

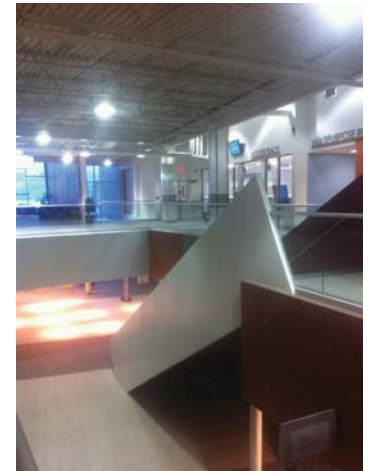

Figure 25. PBK/Genivar.(2012). Quinte Sport & Wellness Centre. [Images of Interior]. Cell phone photograph by author, December 2013.



Figure 26. PBK/Genivar. (2012). Quinte Sport & Wellness Centre. [Image of Interior]. Cell phone photograph by author, December 2013.



Figure 27. PBK/Genivar. (2012). Quinte Sport & Wellness Centre. [Images of Interior]. Cell phone photograph by author, December 2013.

4.4 Chapter Four Summary

Through their manifestation of concepts related to the body, queer space, and deconstruction, The David Barton Astor Place Gym, New York's The Centre, and Belleville's Quinte Sport and Wellness Centre were informative in the design of my gender diverse fitness centre for Winnipeg. Their deployment of performative juxtaposition, imminence and a disrupted gaze produce environments that are conducive to rethinking cis and heteronormative ideology. It is with these concepts as a foundation that the design was developed.

CHAPTER FIVE

DESIGN DEVELOPMENT & EXECUTION

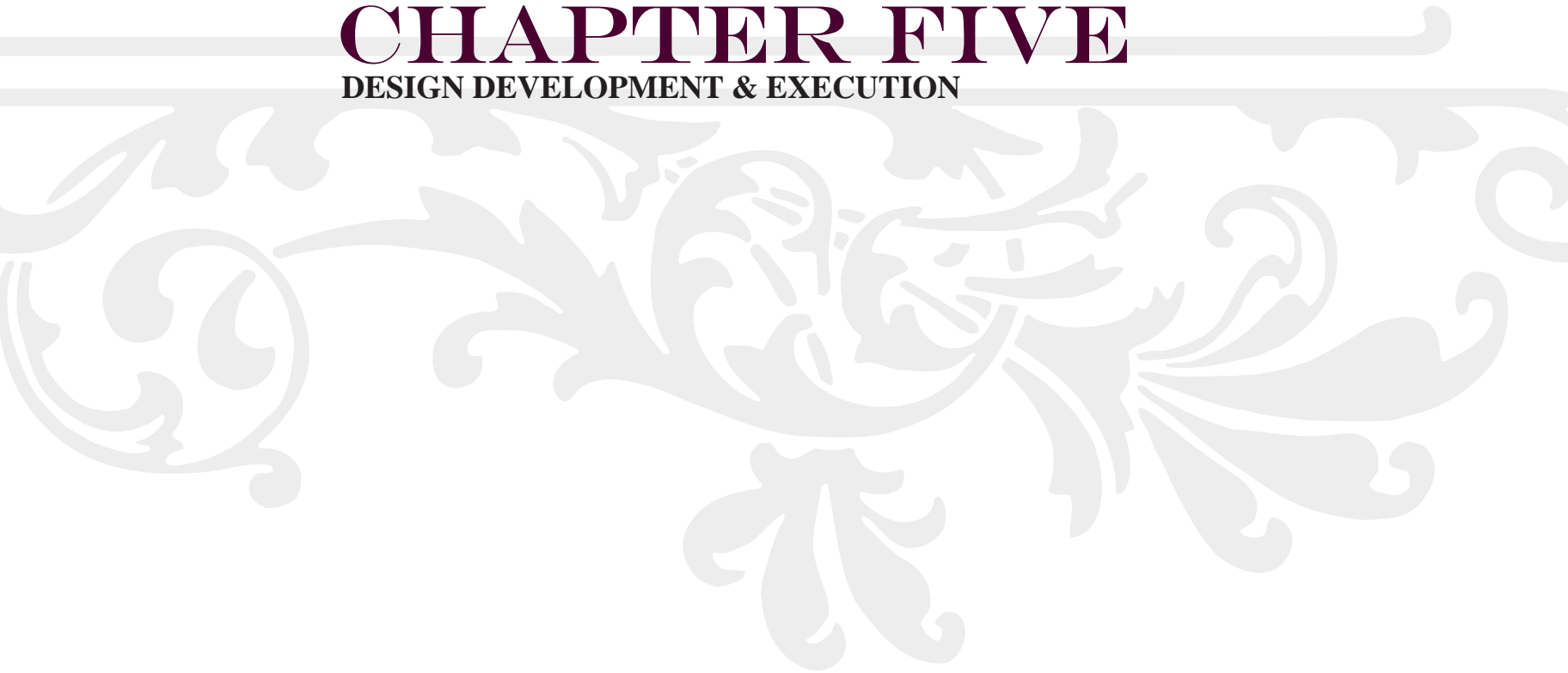

5.0 Introduction

I want to begin by emphasizing that the following design proposal is by no means definitive. Because sex, gender, and desire are prolific in their embodiments, expressions, and desires, there are innumerable ways to present a challenge to the pervasion of social norms in the built environment. The following is merely one interpretation which, because of my lack of success in securing interview participants (to be discussed shortly in more detail), is based almost exclusively on a select set of concepts, alternative conceptions of sex and gender, derived from the literature review. While this review included texts documenting first hand experience, it does not take the place of interview

testimony.

The concepts identified, then, during my review of queer and gender theory, fitness studies, and architectural deconstruction, form the basis of the proposed design. In short, these concepts relate to a disruption of the subjectifying gaze, imminent space, and performative juxtaposition. What follows is, first a presentation of the essential programming information including some of the features, amenities, and services the building provides, and second, an explication of the design concept and its translation from theory into hypothetical built form.

5.1 Programming

5.1.0 Interview Analysis

Interviews were pursued based on the initial intent of creating a space whose challenge to gender and sexuality norms made it more accommodating of transgender communities. The questions (see Appendix I) were aimed toward gaining some perspective into individual's needs and preferences with respect to amenities, services, and atmospheric characteristics. While I endeavoured to conduct one on one interviews by posting invitations in three area LGBTQ centres – University of Winnipeg's LGBTQ* Centre, University of Manitoba's Rainbow Pride Mosaic, and the Rainbow Resource Centre – my attempts were

largely unsuccessful. Though I received several expressions of interest and LGBTQ centre coordinators reported positive reactions from their constituency toward the project, only two individuals chose to take part in the interview process, and despite their input being immensely valuable, it does not represent the actual diversity of transgender perspectives. In the absence of a more diverse sample, this project cannot claim to represent the needs of trans communities and therefore to be trans-friendly in design.

I will nonetheless discuss the participants' insights here. Having been familiarized with the project and

provided with a copy of the statement of intent (Appendix II), participants signed a waiver agreeing to have their comments published in this document and were given the option whether to have their own names used (first name only) or a pseudonym. The interviewees, Matraisa¹⁰ and Athena¹¹, elected to have their own names used.

Their responses impressed the importance of several key issues including privacy and user-ship. Both Athena and Matraisa expressed a desire for personal space over which they had some degree of control with respect to their exposure. For Matraisa, while not requesting complete isolation in workout, locker room, or shower areas, it was important that there be spaces where one could avoid “being

10. Matraisa (interview participant), interview by author, October 7, 2013.

11. Athena (interview participant), interview by author, January 17, 2014.

creeped on” (Matraisa 2013). Dismissing the need for private showers, while not disavowing their importance, Matraisa’s comment suggests that the need for such spaces is not a constant but depends on what and where other users are in the space, as well as the individual’s own state of mind and their perception of others’ looks being affirming or disparaging. A need, then for flexible spaces that could accommodate individuals’ changing needs and wants for personal space and exposure was identified. This was echoed by Athena who, in looking for a fitness club, identified options for privacy, especially in locker room areas, as one of her top criteria.

It was also important to both participants that there be other users, particularly staff, who were members of their communities. Matraisa and Athena expressed a desire to see employees with

whom they could relate. Both participants impressed the importance of making sure all members and staff were, not just LGBTQ or allies, but also inclusive and welcoming of the full range of LGBTQ identities with full knowledge of all aspects of the facility including the available services, amenities, and the range of members. It was important, then, that all spaces, whether for clients or staff or even casual visitors, receive the same treatment and that staff spaces be visible, where possible, to the public in order to foster connection, comfort, and community between employees and members.

The main point of contradiction between the two interviews was in the atmospheric qualities of the space. Athena indicated a preference for darker and less exposed spaces that, instead of being open concept, provided separate areas for different

functions. Matraisa, on the other hand, preferred open spaces with natural daylight and views to the outdoors. Accommodating both desires required flexible spaces whose boundaries could be manipulated to create the desired atmosphere depending on the user(s) and activity being carried out.

The other main point of difference was in the treatment of gender with respect to layout. While Athena warned against the erasure of gender, Matraisa expressed resentment at being forced to align with one or the other every time they visited the gym. Reminding me that, despite wanting to challenge their dominant exclusivity, some people still want to identify as either male or female, Athena's comments echoed those of Tucker Lieberman who expressed the importance of being able to identify with his chosen gender through a

visit to the gym where he was able to use the male locker room without his eligibility being questioned (Lieberman 2006). This was perhaps the most difficult contradiction to reconcile. While it was not my desire to erase gender altogether it is possible, despite my intentions, that the design may be perceived to do so. The goal of designing a challenge to dominant binary assumptions, however, necessarily precluded following traditional two gender locker room models.

5.1.1 Essential Programming

Neither Athena nor Matraisa expressed a desire for any particular services or amenities over and above the more or less traditional fitness club fare. Thus, the programs and services included in the design were chosen with an eye to complicating dominant narratives around sex, gender, and the body including those identified by Dworkin, Ian, and

Sanders that discipline shape and size. It was important that the activities taking place in the building facilitated the production of a diversity of bodies, both at rest and in motion. Whereas Farkas and Fusco identify fitness industry narratives that equate health with disciplined and choreographed bodies engaging in rigid exercise and hygiene activities, the programs and services available in the proposed facility aim to provide opportunities to reimagine ‘fit bodies’ – their sex, gender, shape, size, expression, and movement in space.

In the tradition of facilities like Belleville’s Quinte Sports and Wellness Centre (see section 4.3) or Winnipeg’s Reh-Fit Centre (www.reh-fit.com), this intervention incorporates a variety of amenities aimed at physical and mental health, both individual and community oriented (see Appendix V). Conventional features and services such as

muscle conditioning and cardiovascular exercise equipment, group fitness classes, massage therapy and a track are joined by a café, pro shop, billiard and games lounges, semi-private kitchen and dining space, child-minding, art-making and exhibition, and performance space. This diversity aims to provide an environment in which fitness does not comprise a singular set of criteria disciplining acceptable expressions, embodiments, and activities determined by ascribing to an individual one of two sets of genitalia. The inclusion of a billiard and games lounge wherein members can find space and equipment for reading, playing chess, crossword puzzling, and more, not only maintains a vestige of the building's original occupation, but in addition to meditation space (south terrace – third floor) overlooking the newly constructed park to the South, also acknowledges the importance of mental activity in overall fitness.

Providing a platform for sociality and community building, group fitness classes also provide an opportunity to reinscribe such notions. The proposed classes are designed to acknowledge a variety of different needs, bodies, and fitness goals. In addition to traditional classes like step aerobics, mixed martial arts, and cycling, group programs with less rigid or even no choreography such as improvisational dance, hula hoop, as well as punk and heavy metal aerobics are also featured.

By providing a variety of group fitness classes, both choreographed and unchoreographed, there is an opportunity to reinscribe notions of what constitutes a 'fit' body. Less choreographed classes like Punk Aerobics and Improvisational Dance create bodies whose boundaries are, not only changing by virtue of their movement, but also not fixed by a specified routine and therefore, not

necessarily the same as the other participants. The fluidity of such bodies in unprescribed motion challenges the disciplined boundaries of traditional fitness narratives which privilege the substitution of the soft with the hard, or flesh with muscle through a rigid and choreographed training regime.

Creating spaces for art-marking, exhibition, and performance in the building provide yet another opportunity to critique dominant narratives of sex and gender. Artists like Heather Cassils (<http://heathercassils.com>) and Loren Cameron (<http://www.lorencameron.com>) have demonstrated the capacity for art to challenge sex and gender norms. Cassils in particular challenges these norms and their connection to fitness discourses. By providing a space for artists, including members and non-members both amateur and professional, to display work there is an opportunity to engage and

exhibit a multiplicity of individual perspectives and reconceptions of sex and gender.

5.2 Concept Development

5.2.0 Spatial Concept

With limited interview testimony, the design was largely informed by the literature review. As a result, the discussion of the design is organized around the concepts identified therein: disrupting the gaze, imminence, and juxtaposition. These concepts are not insular, however. Because there is considerable overlap between them, ‘overlap’ became one of the key principles guiding the design. Figure 28 illustrates this concept of overlap which relates, not only to the overlap of the concepts raised during the literature review, but also to the overlap created by acknowledging the possibility of both/and. There is an overlap inherent

in the fluidity and imminence of queer space where fluidity bleeds beyond imposed boundaries and resists being circumscribed. This bleeding and extension between the liminal and the bounded creates the feeling of something about to happen, or imminence. This same overlap juxtaposes conventionally disparate elements with each other by positioning them as simultaneously inhabitable – both/and instead of either/or. In a literal sense, overlap can also disrupt the gaze through a layering of materials and space, but in a more abstract sense, it also resists the fixity of subjectivity necessary to ascribe power to the gaze in the first place. Overlap complicates attempts to fix an individual in a

specific space, identity, or embodiment. These concepts were explored further through hand modelling studies as seen in Figure 29.

Figure 28. Concept Drawings. Generated by author.

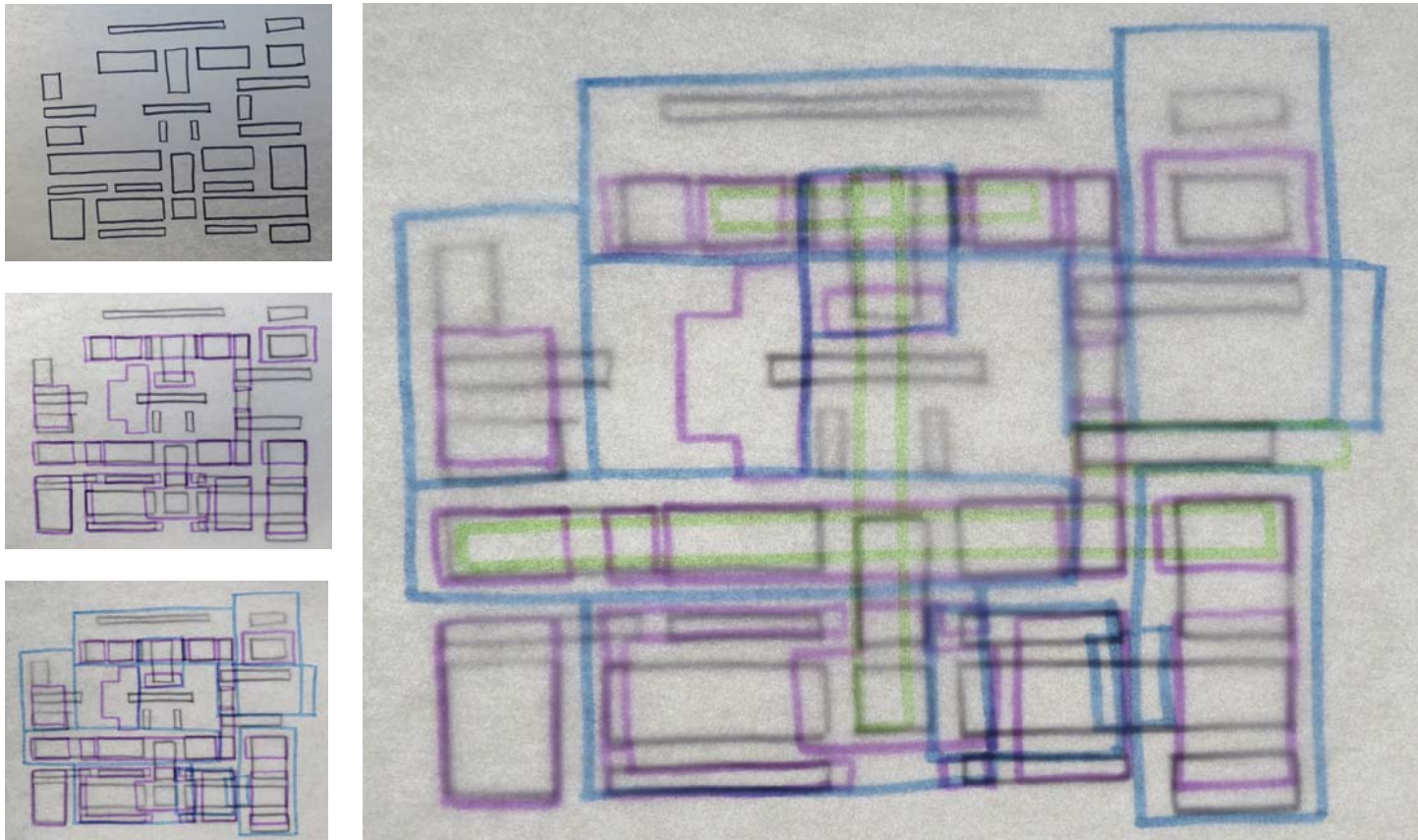

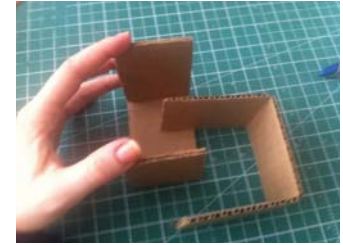
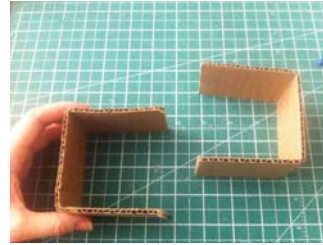
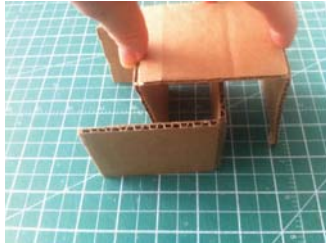

5.2.1 Hand Modelling Studies

Hand modelling studies were conducted to explore ways to create both fluid, overlapping spaces and opportunities or implications for multiple simultaneous inhabitations. Early explorations began with the premise of removing the fourth wall, a concept from theatre studies in which actors, instead of enacting the plot as though it were a realistic, natural set of events and the audience were silent, invisible spectators, engage with the audience by addressing them directly. This style is often political and is used to implicate the public in social activism. By removing one wall or side, the remaining shape maintained the rectilinearity of the existing building while simultaneously refusing its insularity. By exploring it in relation to another equivalent unit, fluid volumes and spatial relationships began to emerge.

These relationships were then applied to scale model explorations of the building. By manipulating this basic unit the building's existing character was used to undermine the values it represented.



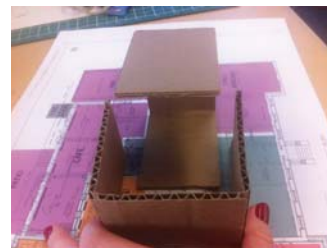

Figure 29. Physical modelling studies. Models and photographs made by author.



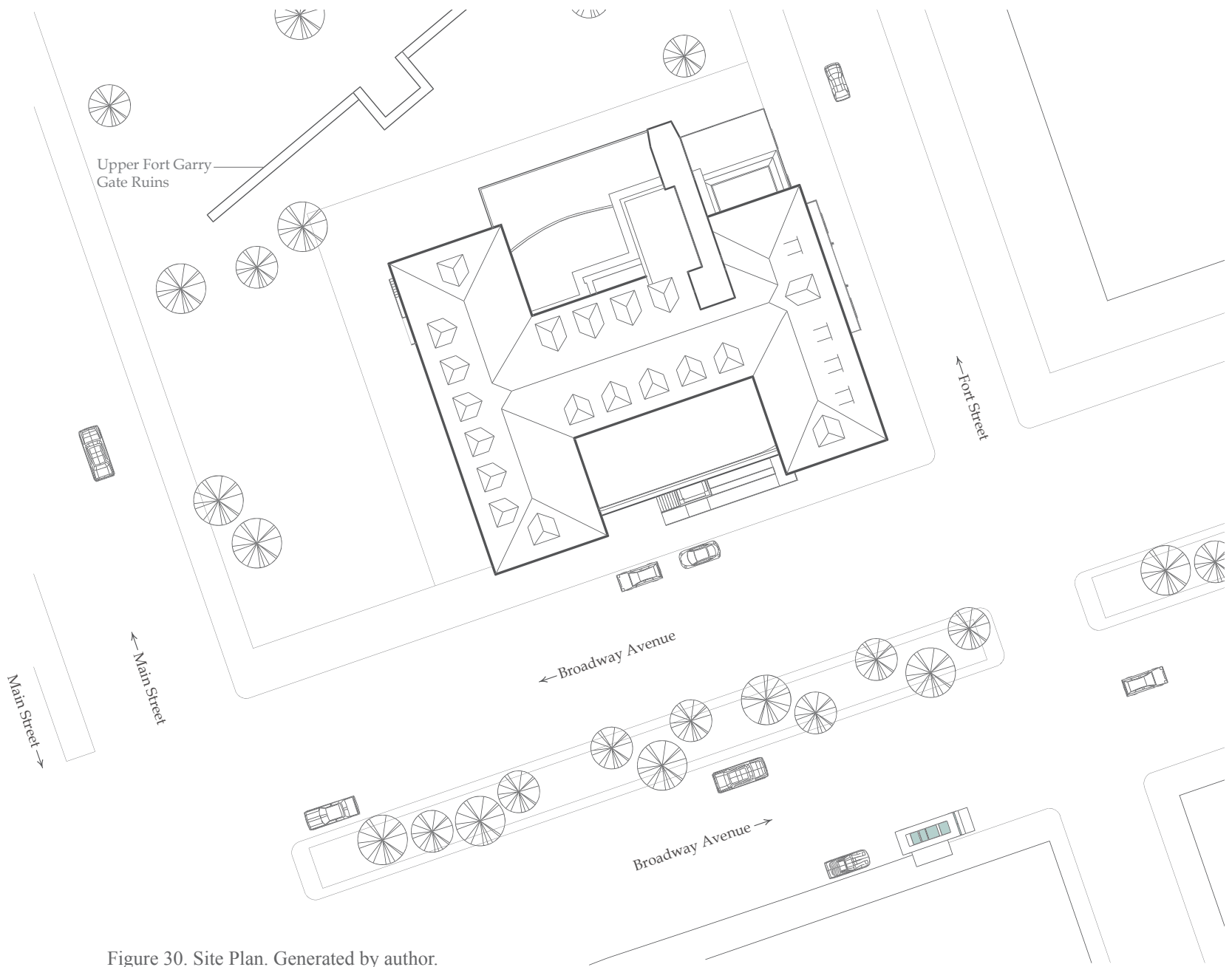

Figure 30. Site Plan. Generated by author.

1 Site Plan



5.3 Design Execution

5.3.0 Introduction

It is based on a simultaneity of subject and objecthood that “transsituated identities disrupt the binary notions of male and female as opposites... Disruption occurs because an individual is capable of articulating an identity founded upon both/and as well as neither/nor and either/or” (Cromwell 2006, 513). This design proposal aims to provide opportunities for such articulations. Contrary to conventional binary fitness club design, it provides spaces in which to inhabit multiple and simultaneous identities, to occupy liminal spaces whose boundaries are fluid, and to juxtapose the accepted with the abject. What follows is an

explication of the design organized around these concepts: beginning with a disruption of the gaze, followed by the fluidity and liminality of space, and concluding with juxtaposition.

The exterior remains largely unaltered with the exception of the North and South entrances (Figure 30). The East and West facades (Figure 31) are untouched while the main Broadway Avenue entrance stair has been rotate ninety degrees clockwise to accommodate the installation of a ramp (Figure 32). Though the appearance remains the same, with the stonework of the stairs, columns and roof left intact, the entry, which previously had

only a small sign at the top of the stair indicating the accessible lift around the corner at the Fort Street entrance, is now fully accessible.

Maintaining the symmetry of the building (Figure 11), a similar treatment was applied to the South side of the building with a stair and ramp extending Eastward from the main floor exit (Figures 32 and 33).

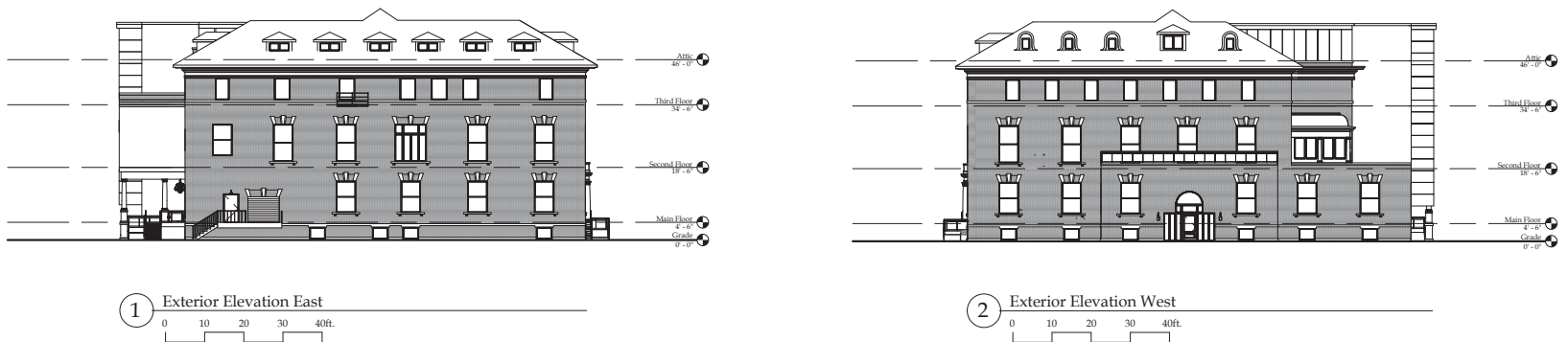

Figure 31. East & West Exterior Elevations. Generated by author.



1 Exterior Elevation North

0 10 20 30 40ft.



2 Exterior Elevation South

0 10 20 30 40ft.

Figure 32. North & South Exterior Elevations. Generated by author.





Figure 33. South Exterior Rendering. Generated by author.

While much is new on the interior, certain elements were deliberately retained because of their relevance to the concept, particularly with respect to their juxtaposition with the overall rigid, bounded character of the building and typology. Figure 34 highlights these features that, in a space privileging exteriority, are simultaneously suggestive of interiority. The orifice-like nature of a double-sided fireplace, or the interiority of a light court shaft that penetrates multiple levels of the building create a simultaneity of interiority and exteriority that is central to the design concept.

Opposite: Figure 34. Retained Elements Plan. Generated by author.

LEGEND

Main Floor

1. East service stair
2. South emergency stair
3. Fort Street entrance & wheelchair lift
4. Double sided fireplace
5. Main entrance corridor
6. Central East-West corridor
7. Main staircase
8. Passenger elevator

Second Floor

1. East service stair
2. South emergency stair
6. Central East-West corridor
7. Main staircase
8. Passenger elevator
9. Decorative porch roof
10. Light court

Third Floor

1. East service stair
2. South emergency stair
6. Central East-West corridor
8. Passenger elevator
10. Light court

Attic

1. East service stair
2. South emergency stair
6. Central East-West corridor
8. Passenger elevator
11. South terrace
12. Curved dormers

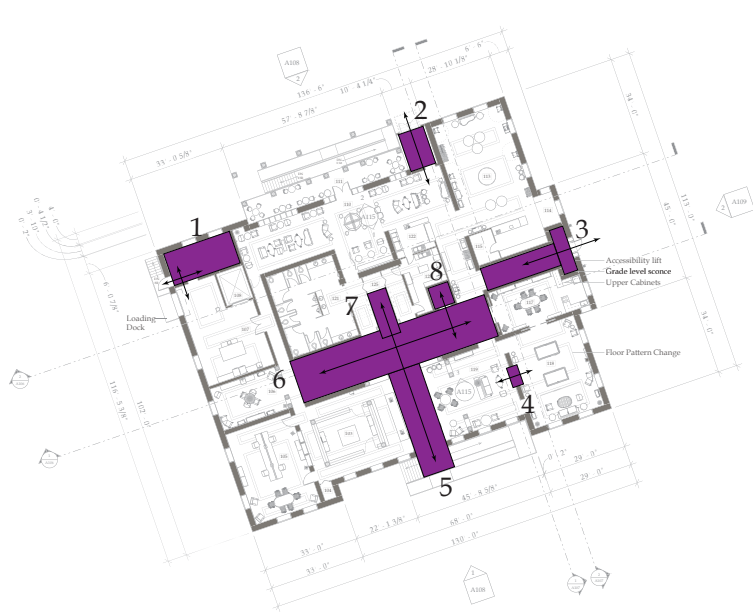

1 Main Floor Plan



1 Second Floor Plan

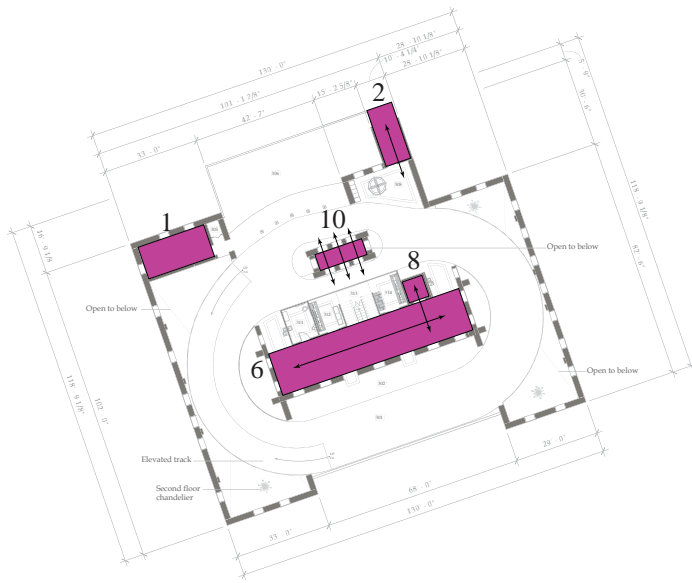

1 Third Floor

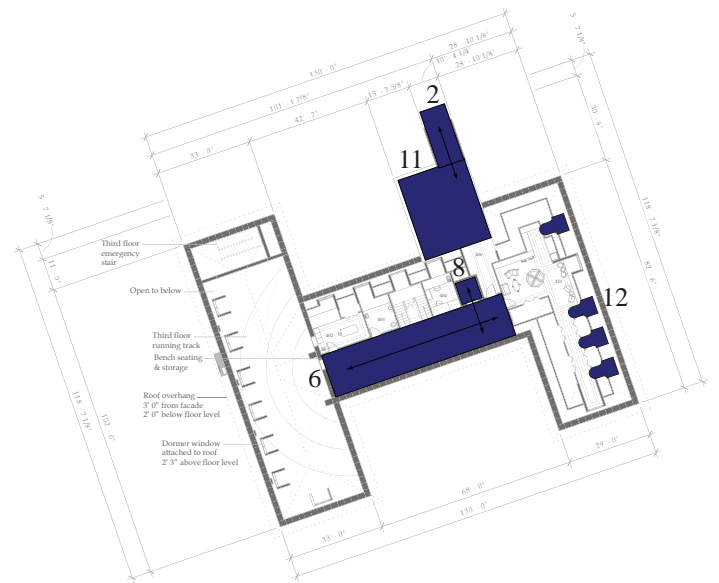

1 Attic



5.3.1 Disrupting the Gaze

While for some institutions and public spaces the response to the need for spaces recognizing both/and and neither/nor has been a third set of facilities apart from the “men’s” and “women’s,” this third space approach, not unlike “The term third gender does not disrupt gender binarism; it simply adds another category (albeit a segregated, ghettoized category) to the existing two” (Towle and Morgan 2006, 677); it does not interrogate gender as a constructed set of precepts about sex, gender, expression and embodiment that demand identification with either/or and abjects both/and and neither/nor. Moreover, it does not acknowledge diversity within the categories “male” and “female.” With this in mind the design, rather than isolating, aims to accommodate a variety of sexes, genders, and embodiments in desegregated, privacy conscious, multi-sex floor plans (Figures 35-38),

particularly with respect to locker rooms and bathrooms. Given Athena and Matraisa’s comments in regards to privacy, it was important that these shared spaces acknowledged such concerns without denying the possibility of an affirmative gaze. The proposal, therefore, features elements designed to provide individuals the option to receive or deflect looks from others as they choose.

According to Cavanagh, the gaze is often employed as a mechanism to police access to sex-segregated spaces by scrutinizing the compatibility of other’s embodiments and presentations with cultural assumptions about their presumed gender (2010). By designing a single locker room for use by all sexes and genders, this proposal disrupts the power of the gaze to evaluate other’s adherence to the norms of a space’s gender designation. While it cannot erase the act of looking, in a multiply

gendered locker room there is no one configuration or combination of sex, gender, embodiment, and expression to which users must comply. In that ilk, the building features desegregated bathrooms which include toilets and urinals – both designed for optimal accessibility – with sanitary disposal in each enclosed stall regardless of whether it contains a toilet or a urinal.

Legend

- 101 Main floor vestibule
- 102 Reception Lounge
- 103 Photocopy & Filing Room
- 104 Storage Closet
- 105 Administration Office
- 106 Children's Artlab & Gallery
- 107 Maintenance & Loading Dock
- 108 Freight Elevator
- 109 Emergency Stair East
- 110 Cafe Seating
- 111 Cafe Patio
- 112 Emergency Stair South
- 113 Pro Shop
- 114 Pro Shop Window Display
- 115 Pro Shop Storage
- 116 West Entrance
- 117 Semi-Private Dining Room
- 118 Billiard Lounge
- 119 Games Lounge
- 120 Gallery Corridor
- 121 Water Closet
- 122 Cafe Service
- 123 Cafe Kitchen
- 124 Passenger Elevator
- 125 Storage Closet

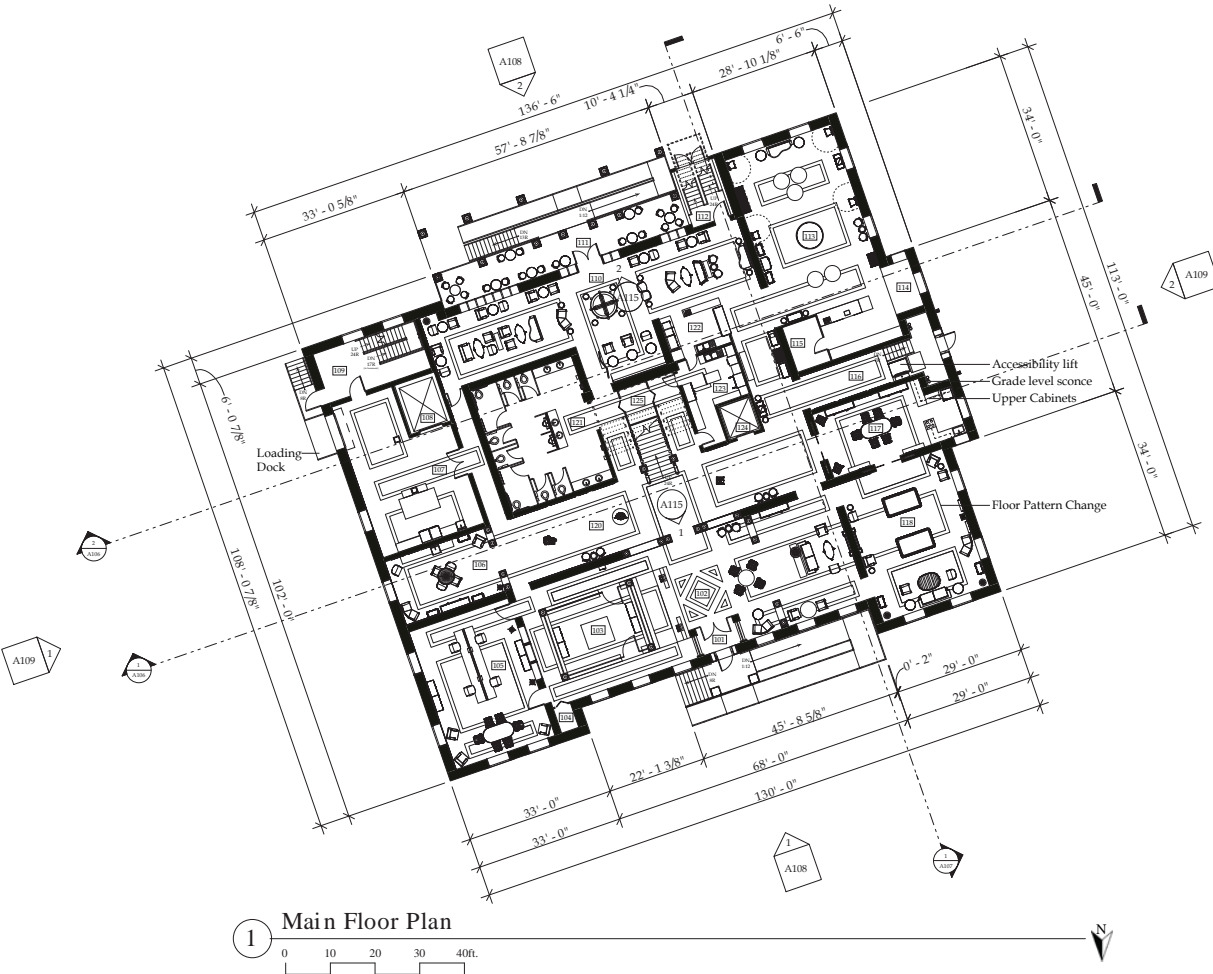

Figure 35. Main Floor Plan (detailed view opposite). Generated by author.

Inside & Out Fitness Club 194 Broadway Avenue, Winnipeg MB

Main Floor Plan

Project number	123456
Date	December 8, 2014
Drawn by	Corrie Allan
Checked by	Kelley Beaverford

A102

Scale	As Noted
-------	----------

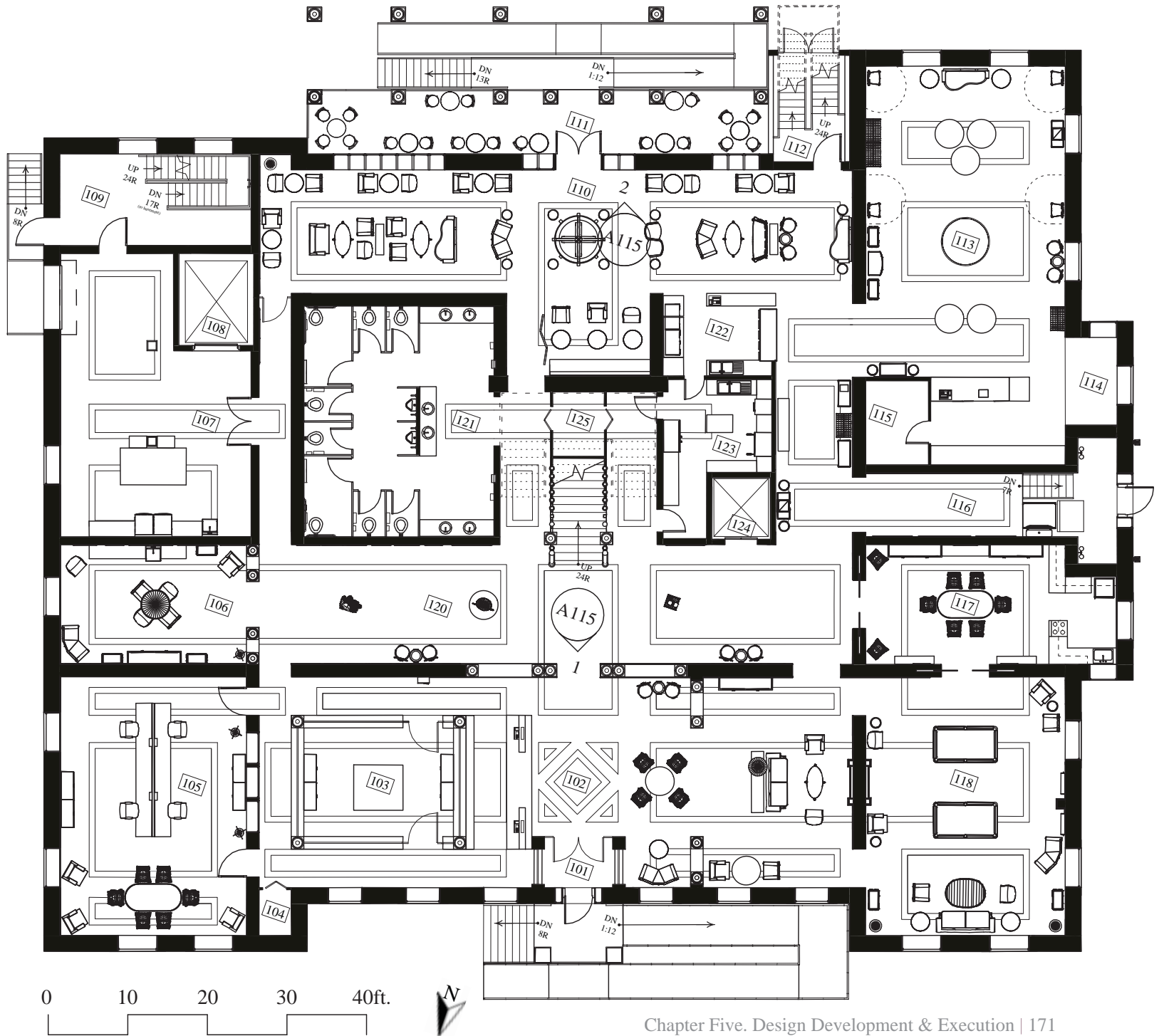

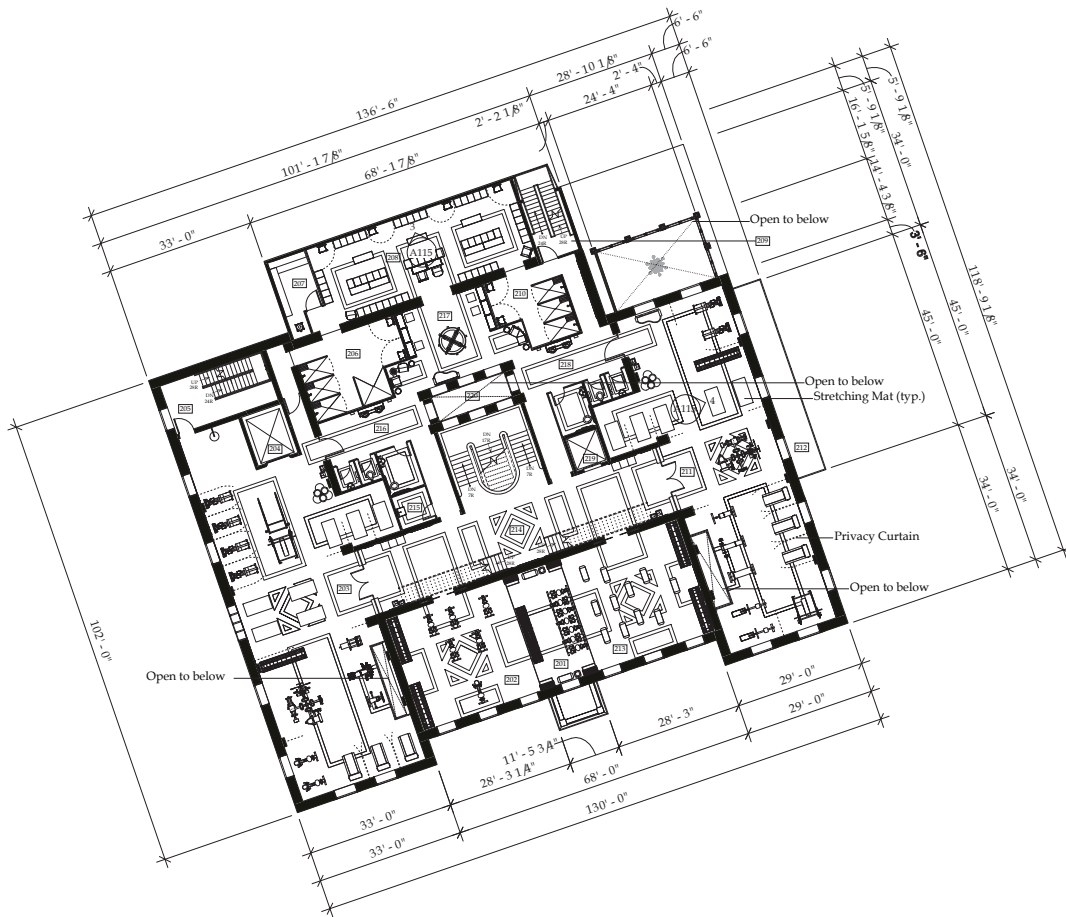

1 Second Floor Plan
 0 10 20 30 40ft.

Figure 36. Second Floor Plan (detailed view opposite). Generated by author.

Legend

- 201 Equipment Storage
- 202 Group Fitness East
- 203 Workout Room East
- 204 Freight Elevator
- 205 Emergency Stair East
- 206 Shower Room East
- 207 Sauna
- 208 Locker Room
- 209 Emergency Stair South
- 210 Shower Room West
- 211 Workout Room West
- 212 Emergency Terrace
- 213 Group Fitness West
- 214 Corridor
- 215 Maintenance
- 216 Water Closet East
- 217 Grooming Lounge
- 218 Water Closet West
- 219 Passenger Elevator
- 220 Light Court

Inside & Out Fitness Club 194 Broadway Avenue, Winnipeg MB

Second Floor Plan

Project number	123456
Date	December 8, 2014
Drawn by	Corrie Allan
Checked by	Kelley Beaverford

A103

Scale	As Noted
-------	----------

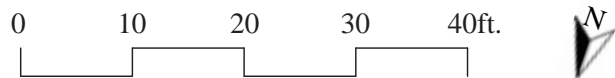
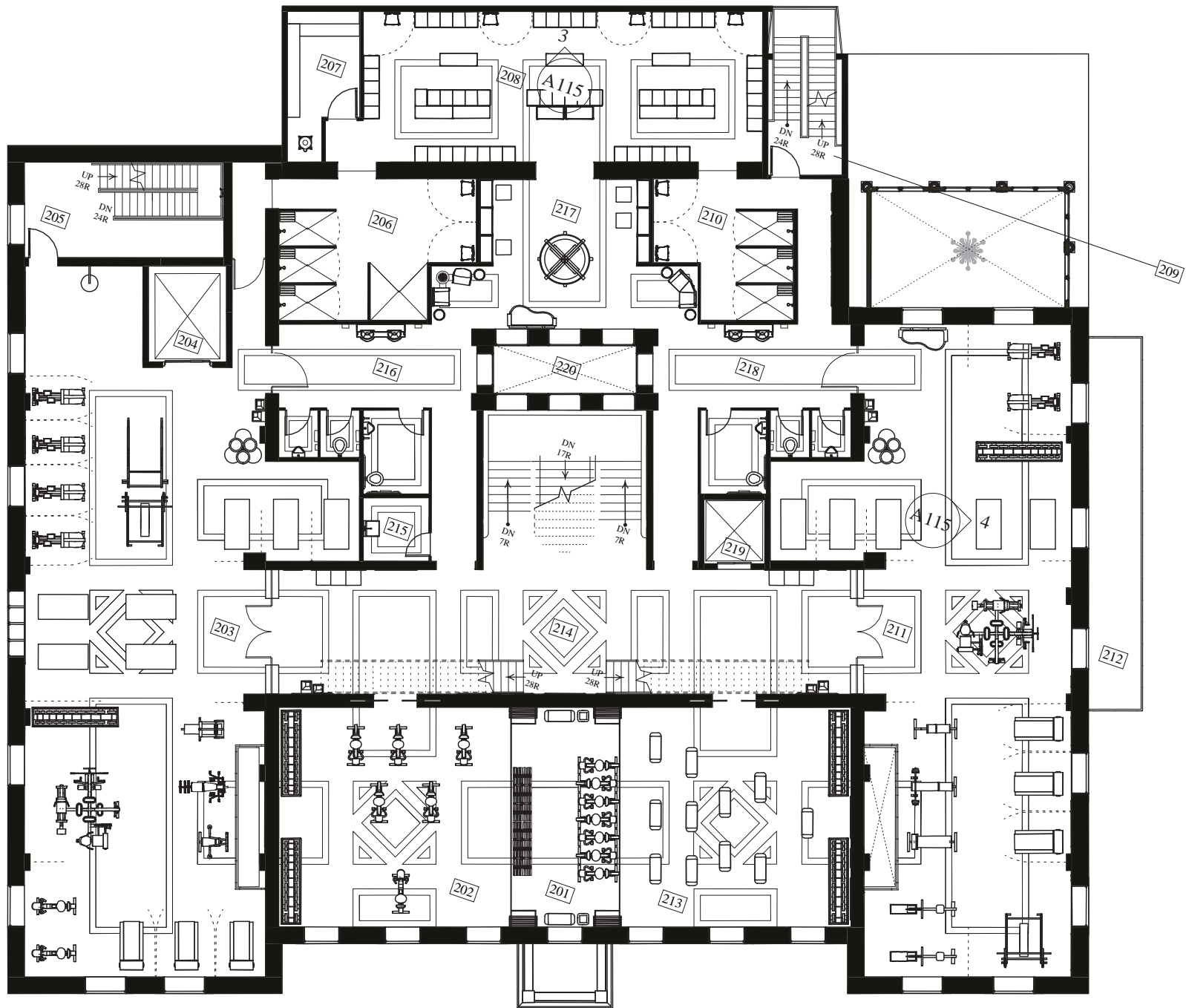

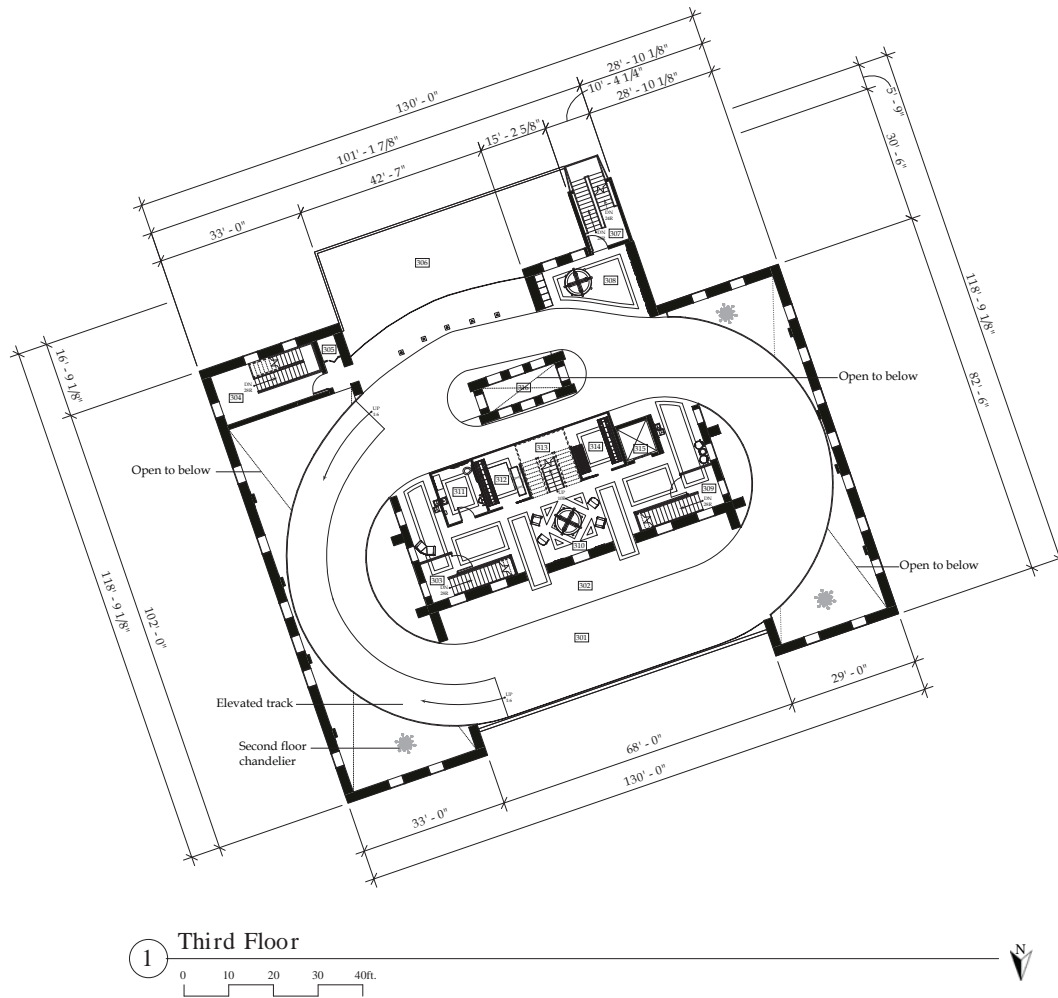

1 Third Floor

Figure 37. Third Floor Plan (detailed view opposite). Generated by author.

Legend

- 301 Track
- 302 North Terrace
- 303 Vestibule East
- 304 Emergency Stair East
- 305 Storage Closet
- 306 South Meditation Terrace
- 307 Emergency Stair South
- 308 Locker Gallery
- 309 Vestibule West
- 310 Lounge
- 311 Water Closet
- 312 Equipment Storage East
- 313 Under-stair Storage
- 314 Equipment Storage West
- 315 Passenger Elevator
- 316 Light Court

Inside & Out Fitness Club
194 Broadway Avenue, Winnipeg MB

Third Floor Plan

Project number	123456
Date	December 8, 2014
Drawn by	Corrie Allan
Checked by	Kelley Beaverford

A104

Scale	As Noted
-------	----------

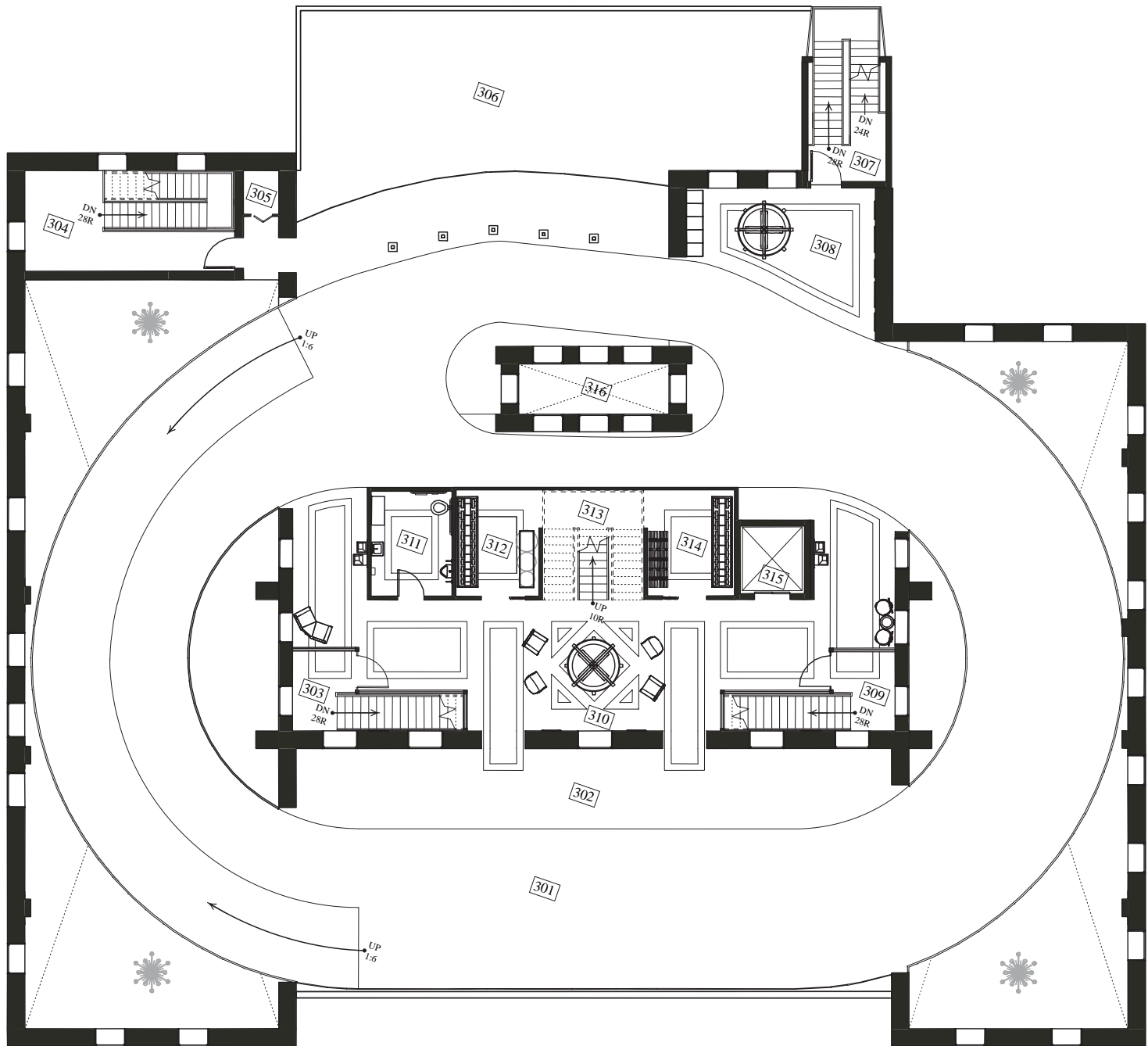

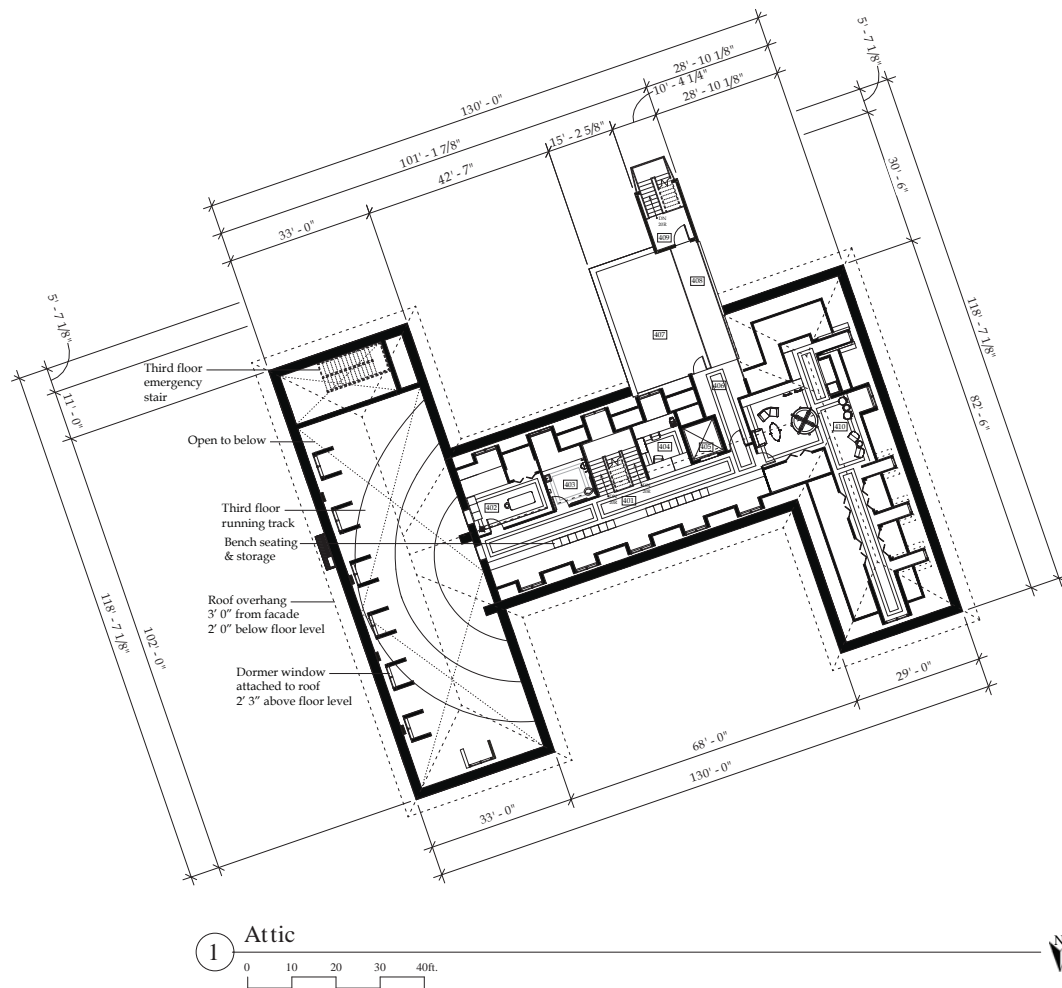

Figure 38. Attic Plan (detailed view opposite). Generated by author.

Legend

- 401 Reception Corridor
- 402 Athletic Therapy
- 403 Water Closet
- 404 Office
- 405 Passenger Elevator
- 406 South Vestibule
- 407 South Terrace
- 408 Exit Corridor
- 409 Emergency Stair South
- 410 Staff Room

Inside & Out Fitness Club

194 Broadway Avenue, Winnipeg MB

Attic Floor Plan

Project number	123456
Date	December 8, 2014
Drawn by	Corrie Allan
Checked by	Kelley Beaverford

A105

Scale	As Noted
-------	----------

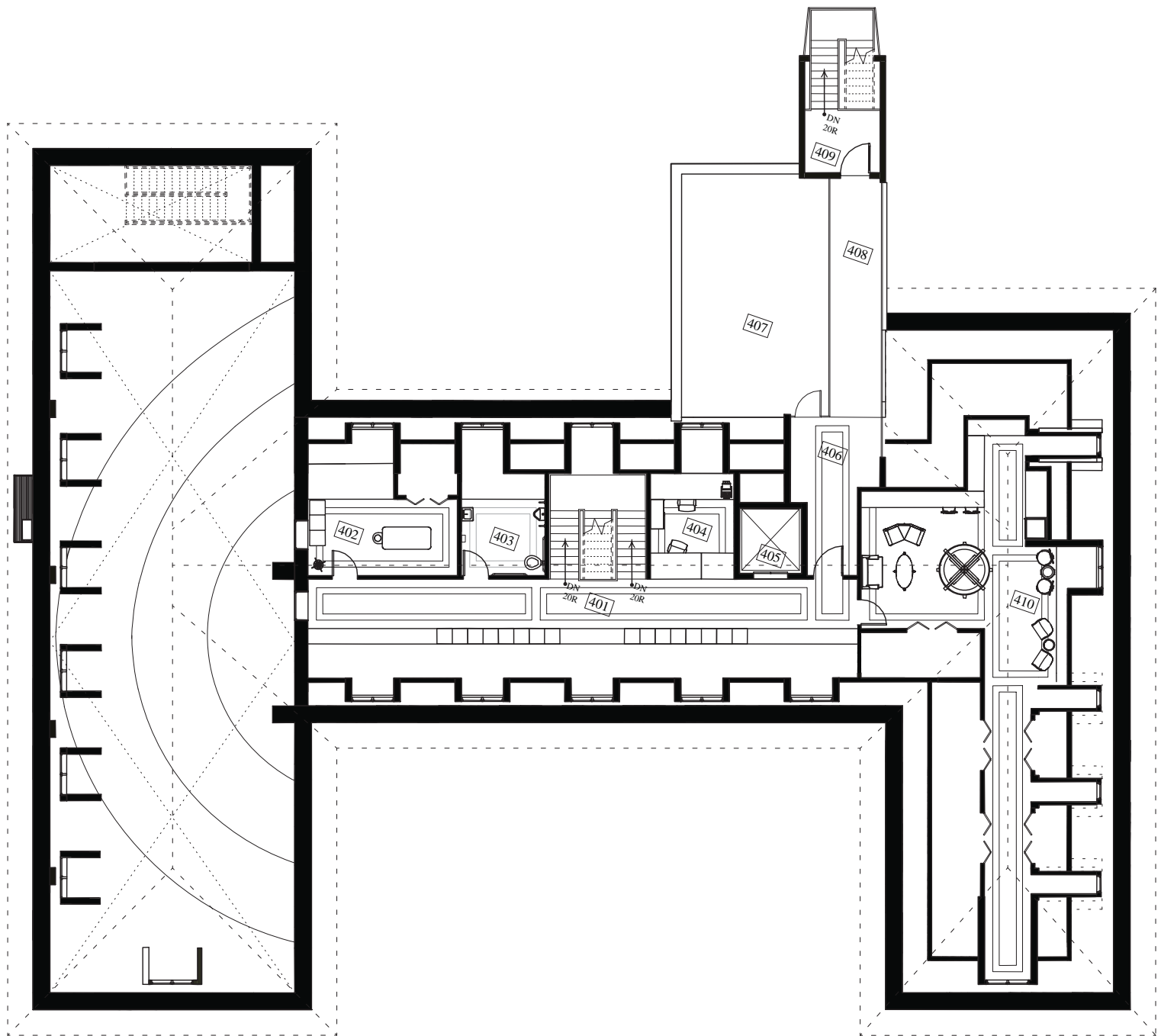

0 10 20 30 40ft.



That being said, users might desire additional privacy whether in the locker room, the gym, or even the social spaces. In order to accommodate this desire as well as to further obfuscate the gaze, changing areas like the locker room and pro shop are equipped with private change areas composed of multi-layered draperies behind which patrons can disrobe (Figures 39 – 41).



Figure 39. Locker Room Elevation. Generated by author.

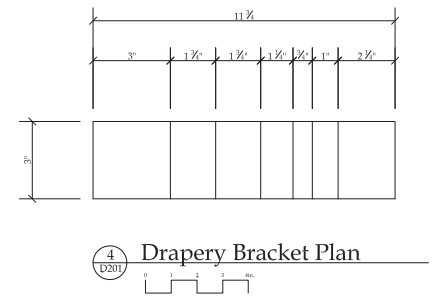
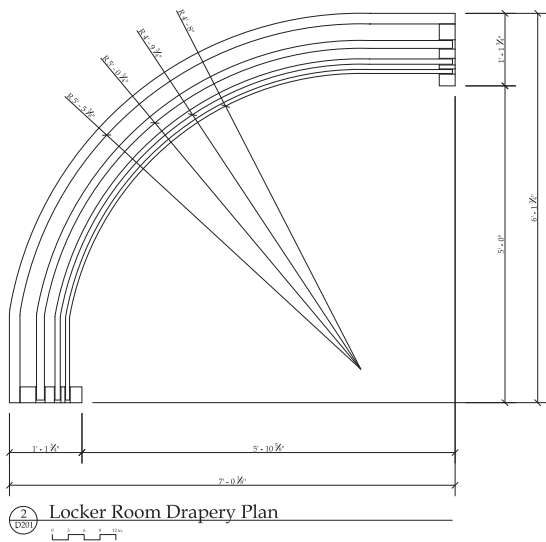
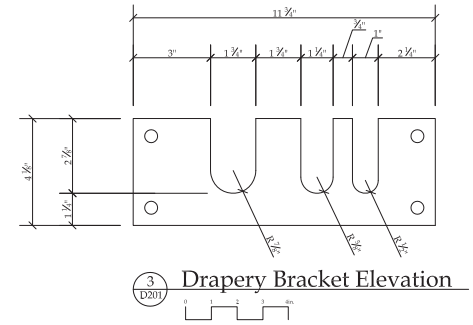
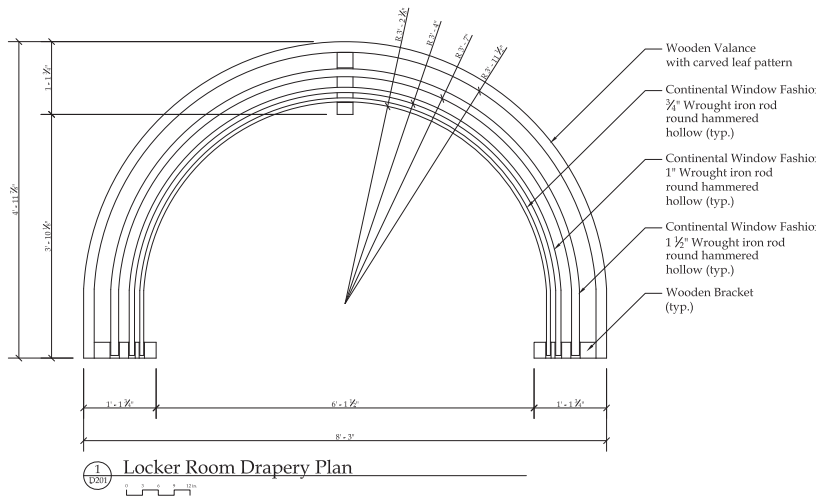
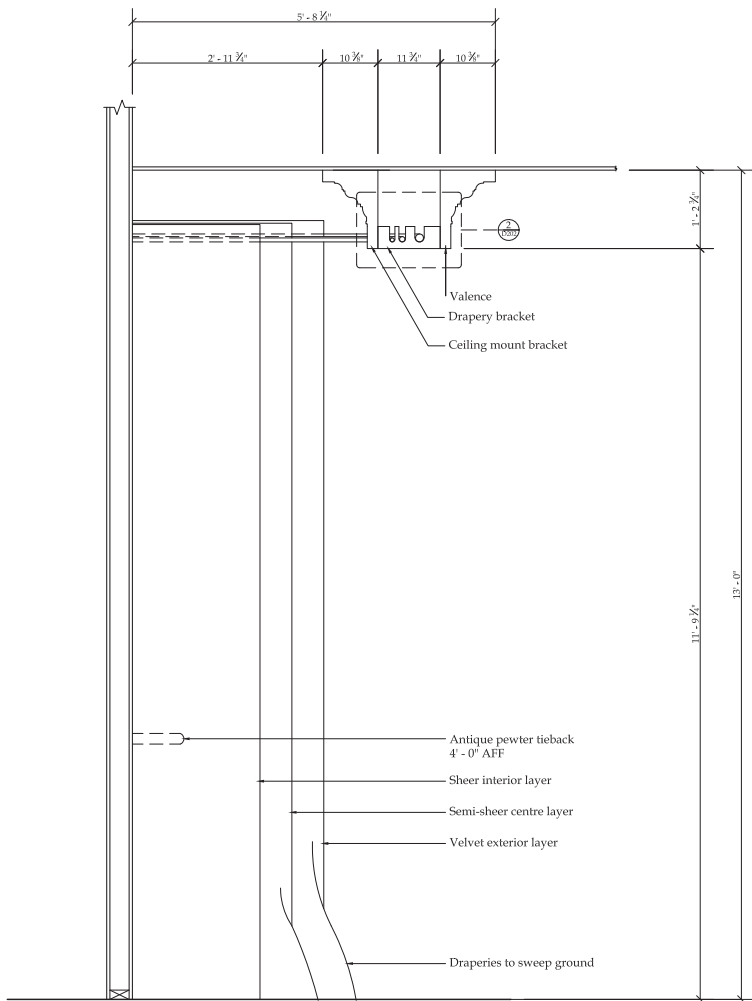
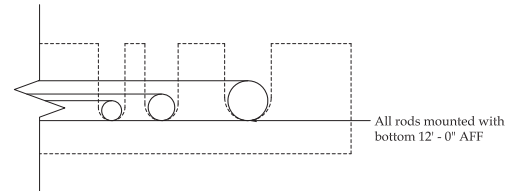

Figure 40. Drapery detail drawings. Generated by author.



1 Locker Room Drapery Section



2 Drapery Rod Section

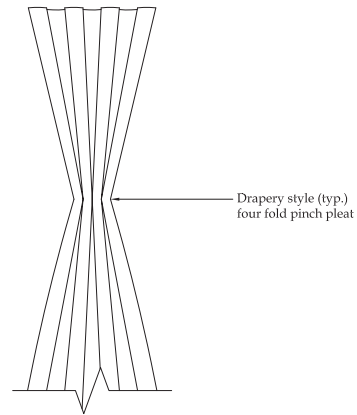

3 Drapery Pleat Style



NTS

Figure 41. Drapery detail drawings. Generated by author.

Multiple layers of fabric, ranging from semi-sheer to opaque (Figure 42), provide individuals the opportunity to choose whether to indulge, partially obscure, or fully rebuke the gaze of others. Located on the second floor (Figure 36), the locker room, for example, is equipped with these private change rooms whose varying opacity allows individuals the ability to control their visibility while changing. The shower rooms adjacent to the locker room are also equipped with these private draped change areas for anyone wishing direct, unobserved access to shower facilities.



Figure 42. Material Suggestions. Photograph by author.

LEGEND

1. Quartz, counter top: Reception desk, Locker Room dressing tables, Cafe service counter
2. Mosaic tile: Shower stall walls, Cafe service counter backsplash
3. Rubber flooring: Workout rooms
4. Perforated Steel: Track guard rail
5. Oak flooring, dark stain: main flooring inset border
6. Hammered glass, Eco-glass Gothic: North terrace and South terrace track enclosure
7. Minwax Burgundy Stain finish sample: Reception desk & Dressing table
8. Black Brushed Aluminum: Fitness equipment
9. Cast steel drawer pull: Reception desk
10. Oak flooring, medium stain: to match existing: main flooring - all floors not otherwise specified
11. Velvet burgundy: general upholstery suggestion
12. Velvet navy: general upholstery suggestion
13. Velvet fuschia: locker room benches, general upholstery
14. Velvet green: workout room opaque layer privacy draperies, general upholstery
15. Fabric, Eames positive pattern: semi-sheer layer all privacy draperies
16. Taffeta, navy with blue embroidery: general upholstery suggestion
17. Fabric, cushioned purple dot: general upholstery suggestion
18. Taffeta, purple & black striped: locker room opaque layer privacy draperies
19. Velvet, purple: general upholstery suggestion
20. Vinyl, orchid: Fitness equipment upholstery
21. Leather, purple snake print: Cafe furniture upholstery
22. Leather, pewter palm print: Cafe furniture upholstery
23. Leather, green: Cafe furniture upholstery
24. Grey lace wall covering: Cafe, Locker room, Gallery corridor
25. Wall covering, purple damask: Workout room, Pro Shop
26. Wall covering: paintable scaffold embossed
27. Paint, lilac
28. Paint, orchid
29. Paint, aubergine: Ceilings
30. Paint, feather paint colour
31. Paint, dove grey
32. Paint, heather grey
33. Ceiling tile, stamped aluminum: all inset raised ceiling areas.

For those who are comfortable changing in full view, there are other levels of exposure. The layout of the lockers provides different areas within the change room, some that are fully exposed to the entrances, some that are partially obscured, and some that are fully concealed (see Figures 43 and 44). The placement of the private change rooms also allows a certain level of concealment between areas within the locker room as, even when open, the draperies provide a visual separation between spaces (Figures 39 and 44).

Right: Figure 43. Locker Room Plan.
Generated by author.
Opposite: Figure 44. Locker Room
Rendering. Generated by author.

LEGEND	
Public	Private
Semi-Private	





The same tactic is employed in the workout and social areas. Similar draperies hang in the weight and cardio rooms, allowing individuals to change the boundaries of their space and accept or refuse both the gazes of others into their personal space as well as their gaze into the spaces of others.

Although it is not fabric that allows individuals control over their level of exposure in the café, the furniture has been selected and distributed in such a way as to achieve a similar effect. The specification of Victorian style furniture provides, not only an eclectic atmosphere, but the diversity of profiles and heights also allows there to be varying levels of enclosure among the seating. Seen in figures 45-47, there is a vast diversity of styles, profiles, and sizes



Figure 45. Cafe Elevation. Generated by author.

Right: Figure 46. Suggested Furniture Styles.
(copyright permission not obtained).



Conversation Sofa

Curious Sofa

Conversation Seat

Balloon Chair

Vis-a-Vis

among Victorian styles such as the balloon chair, the vis-a-vis or face to face chair, the conversation sofa, and the curious sofa. By dispersing these different furniture pieces throughout the space rather than grouping similar pieces together, patrons can, to a certain extent, customize their seating experience by being able to choose a particular area within the café as well as a particular furniture style in which to sit. The café's mere depth of space provides one level of exposure in terms of featuring seating at various distances from central traffic areas which, in addition to the variety of seating profiles, creates opportunities for customizing levels of exposure.

Where fitness club design typically lacks privacy is in workout spaces which are often, not only open concept and devoid of partitioning devices, but

Opposite: Figure 47. Cafe Rendering. Generated by author.





largely adorned with floor to ceiling mirrors as demonstrated by my personal observations (Appendix IV). This type of design, according to Cavanagh, facilitates both the ability of others to cast a disparaging gaze as well as the panopticon effect of self-surveillance (Cavanaugh 2010). While mirrors in fitness clubs do have a practical use – they provide a means by which to evaluate proper technique for activities like weightlifting and stretching which, if not correct, can cause injury – the overabundance of them functions, as Cavanagh suggests, as a mechanism of governance. Disrupting the gaze in this case, is not about removing mirrored surfaces altogether but in obscuring it. The mirrors applied in the workout area are antiques whose patina complicates a fixed view of objects in it. While an individual can still check their form, the trace of time provides a reflection that is more blurred than is typical of

most gyms. Individual's features thus obscured, the fixity of the gaze is hindered in its inability to assign gender or sexual characteristics to images in the mirror. Situated between the windows, daytime users have an alternating view of the outside and the reflected interior (see Figure 48).

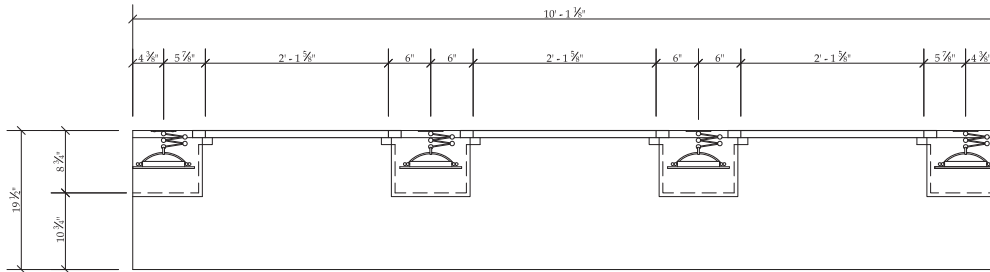

Figure 48. Workout Room Elevation.
Generated by author.

Reflections in washroom mirrors are likewise disrupted. Instead of a solid expanse above the lavatories, numerous framed mirrors are hung in a manner similar to the gallery art. This tactic interrupts the gaze, disallowing the fixity of subject and object and also allowing for more accessible

positioning at lower heights. Locker room mirrors are located inside the private change areas (Figure 39), inside the lockers themselves, and in the grooming lounge where they are integrated into the dressing tables (Figure 49).





1 Dressing Table Plan

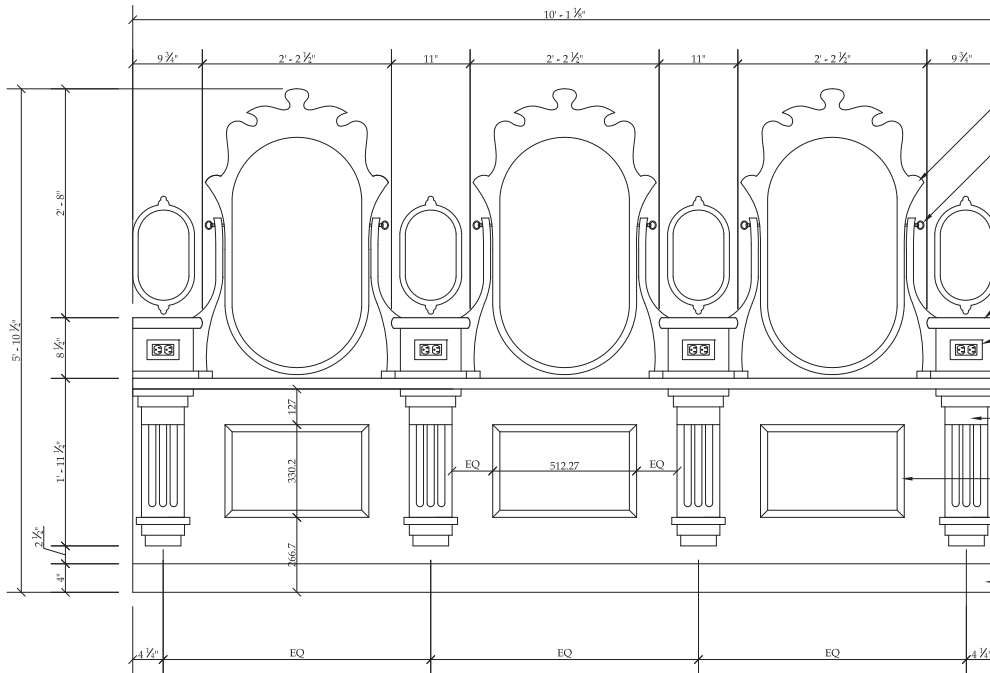
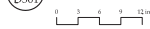

- Antique mirror max. 1" deep (typ.)
- Cheval mirror fitting antique pewter min. 2" long (typ.)
- Extendable mirror wall-mount
- 1 1/2" Quartz countertop full bullnose on exposed edges attached with silicone
- Electrical outlet
- 1 1/2" Quartz countertop full bullnose on exposed edges attached with silicone
- 22" Ash Bracket
- Minwax Water Based Wood Stain clear tint base, Burgundy
- 3/4" 1/2 Round molding (typ.) nailed, see section for location
- 3/4" Ash
- Minwax Water Based Wood Stain clear tint base, Burgundy
- 1mm aluminum kickplate Chemetal Brushed Black Aluminum #917 attached with silicone

2 Dressing Table Elevation

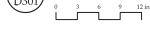

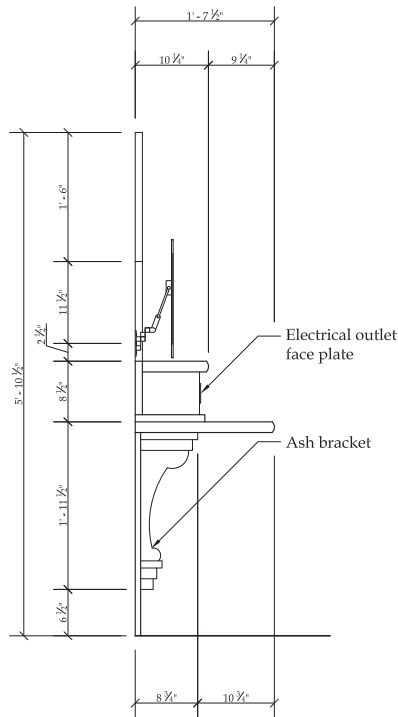

3 Dressing Table Side Elevation
 D301

Opposite & Above: Figure 49. Dressing Table Details.
 Generated by author.

This distribution provides users the option of a completely private view inside the draped change room, a semi-private view that is less visible to others by virtue of the user blocking access to their reflection with their body, and finally a more public view that allows them to be on display if they so choose.

This disruption of the gaze is at work, not only on the interior of the building, but also between the interior and exterior. Rather than repeat the “public patriarchal display of exclusivity” (Rendell 1999, 179)” characteristic of nineteenth century men’s clubs and this building’s own history, this design places the body, in its myriad of sexes and genders in the position of privilege. The second floor street facing façade of the building, historically reserved for gambling rooms as a sort of nose-thumbing to the law and the lower classes who were bound

thereby, becomes the site for group fitness, with individual workout areas on either side (see Figure 36). Placing the group fitness rooms in this privileged position highlights inclusivity rather than exclusivity. Appropriating this space and its history of white, upper class, heterosexual male privilege undermines the precepts on which such privilege is based both by virtue of the diversity of its proposed occupants as well as through the bodies in motion being produced (Figure 50) by its range of choreographed and unchoreographed activities (Appendix V). Instead it privileges a diversity of gazes, acknowledging variant subjectivities.

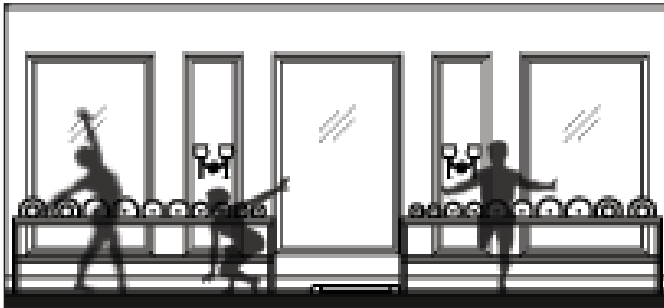

The vantage point from this space also provides occupants a full view of the street, while offering them privacy from it in that, as compared to clubs like Shapes whose ground level glass-walled group exercise space is directly exposed to passers-by, the street has a less direct gaze into this workout space (see Appendix IV).

Likewise, the third floor track is enclosed on the north and south terraces in hammered glass that allows varying levels of privacy based on the individuals proximity to its surface. The nature of the glass selected (see Figure 42) partially obscures the interior of the building with objects within becoming more distorted the greater the distance between them and the surface of the glass.

Figure 50. Group fitness studio, bodies in motion.
Generated by author.

5.3.2 Imminence: Fluidity and Liminality

It is in part due to the fluidity and liminality of the spaces created by this intervention that the gaze is disrupted; imminent space resists the fixity required to subject someone to a disparaging gaze. This was achieved in large part through the application of materials and ceiling heights where changes in floor material and direction work in conjunction with the ceiling height and treatment to create and emphasize areas of overlap whose blurred boundaries create a sense of imminence in their refusal to resolve or line up as would be expected of a more classical tradition (Figures 51-54). With statement lighting fixtures placed at points of intersection and spaces of multi-directionality, these applications allow spaces to open up directly onto one another. By sharing bounding elements both within floors horizontally and between floors vertically, traditional boundaries between

architectural levels, and the hierarchies inherent in the history of the building, become blurred.

Whereas the third and attic levels of the Manitoba Club were originally the servant's quarters, a mezzanine track on the third level is open on the East and West side of the building to the second floor workout areas below and open on the East side to the vaulted attic ceiling above (Figure 55). The spaces remain separated while simultaneously being shared through visual and auditory connections.

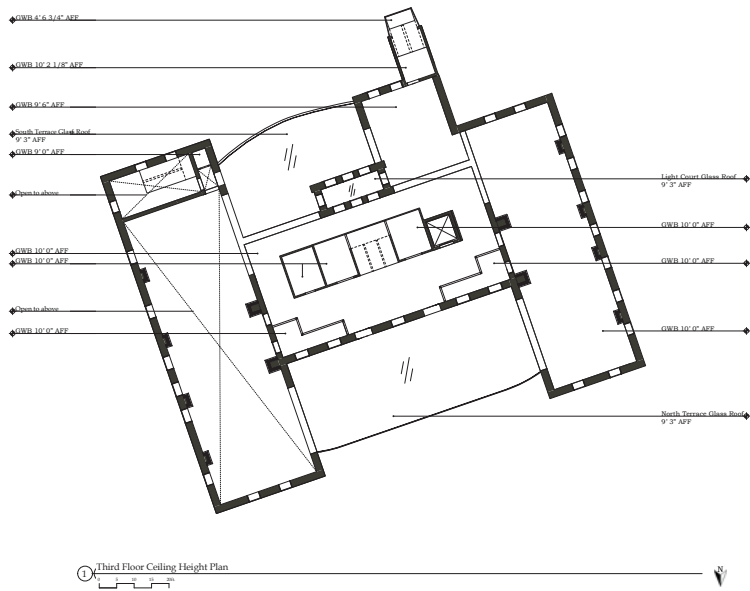

Figure 53. Third Floor Ceiling Height Plan (top) and Reflected Ceiling Plan (bottom). Generated by author.

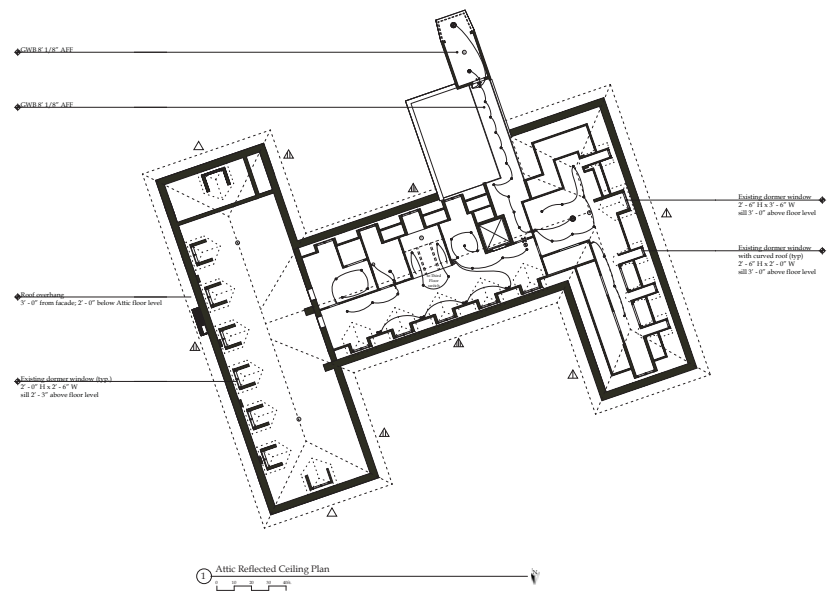

Figure 54. Attic Ceiling Height Plan (top) and Reflected Ceiling Plan (bottom). Generated by author.

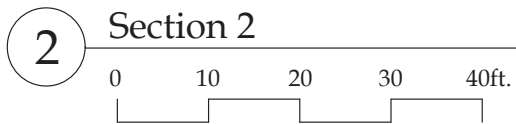
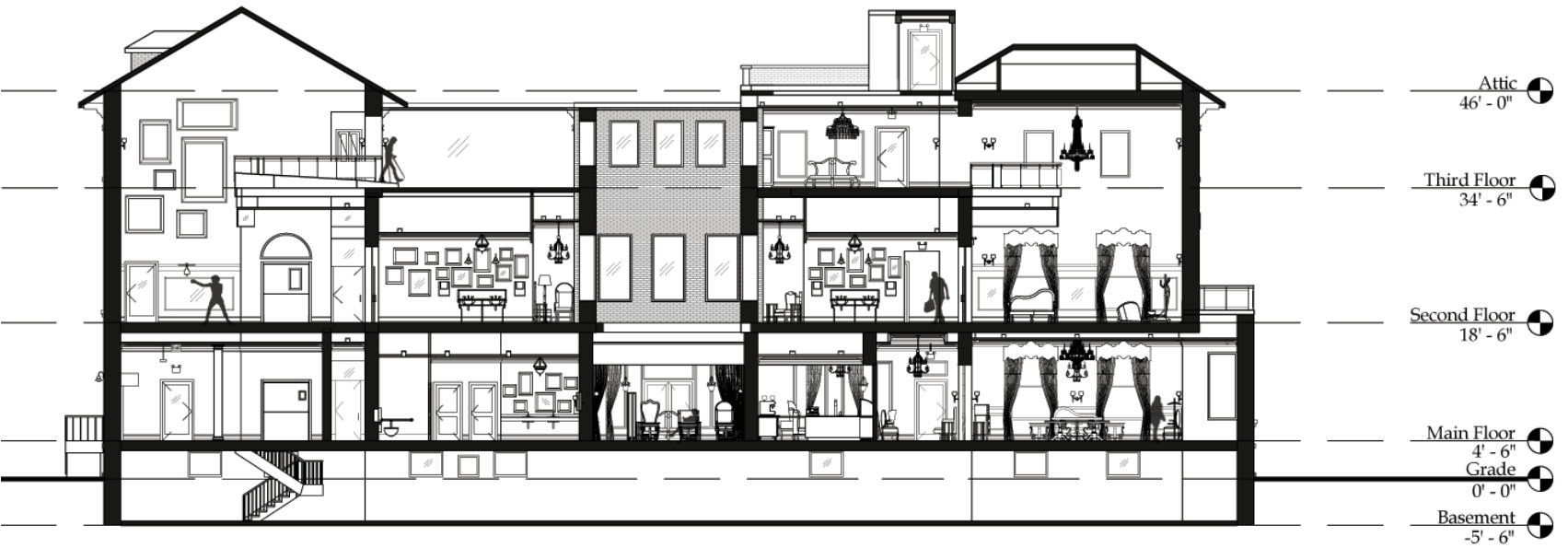
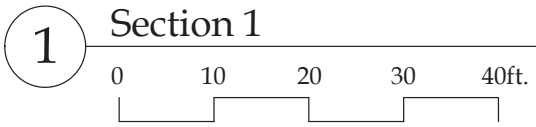
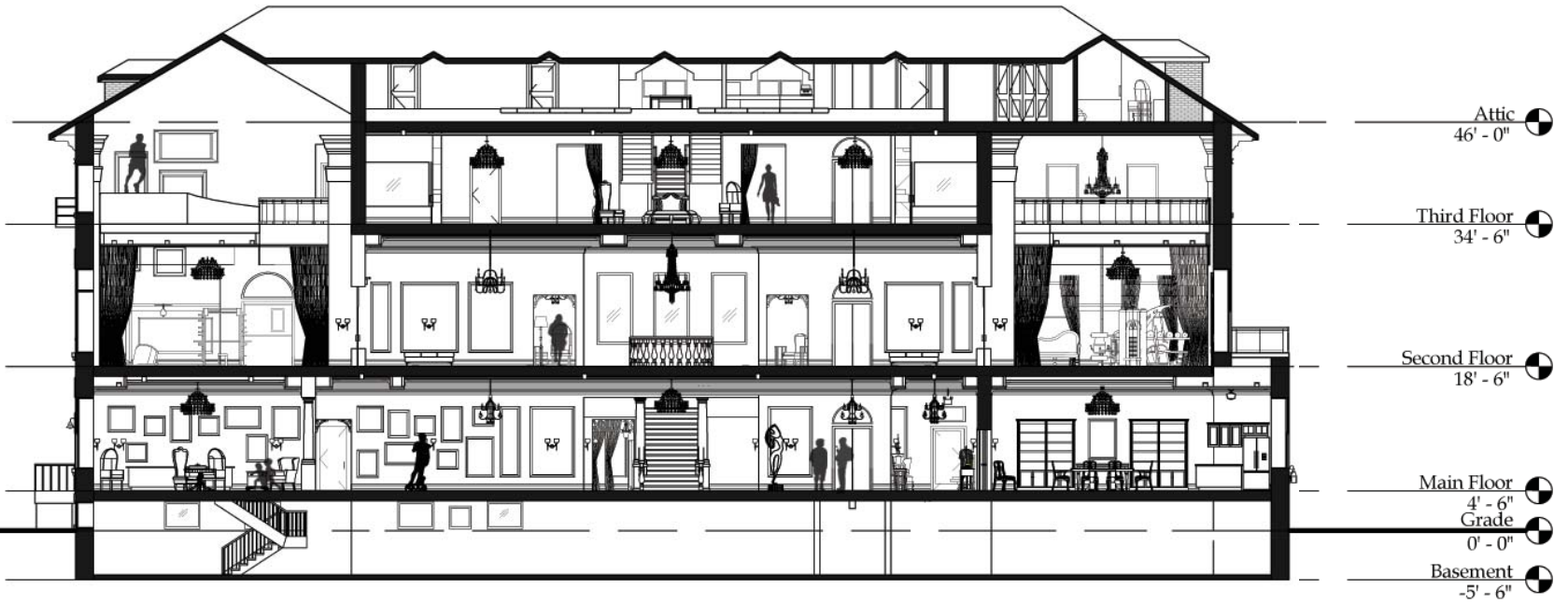

Figure 55. Building Section. Generated by author.

Using these strategies, an individual can be perceived to occupy multiple positions or spaces at once. Working in combination with the floor and ceiling specifications, the selection and placement of furniture in the workout area, but also in the reception lounge and café, emphasize the ability to occupy multiple spaces and perspectives at once, creating positions that are not fixed, but fluid. Where an area of floor pattern terminates in the centre of the café seating area, for example, the space between is spanned by an elevated section of ceiling as well as by a grouping of furniture that occupies the spaces between floor pattern changes (Figure 35). Likewise, instead of being confined to designated rooms, activities spill out, by means of associated furnishings and fixtures into traditionally liminal spaces like corridors. Typically spaces that are passed through as a means to arrive at a specified destination, they become inhabitable in

their own right, as gallery spaces (Figures 56-58), as rest areas (Figure 58), and as merchandise display (Figure 59-60). Instead of stopping at the door, where allowable according to fire code, activities extend into corridors, blurring the boundaries between functional areas and creating a kind of ‘chora’ of the corridors. Rather than a means to an end, the liminal is made into habitable, multi-functional space.



Above: Figure 56. Building Section. Generated by author. | Opposite: Figure 57. Gallery Corridor Rendering. Generated by author.

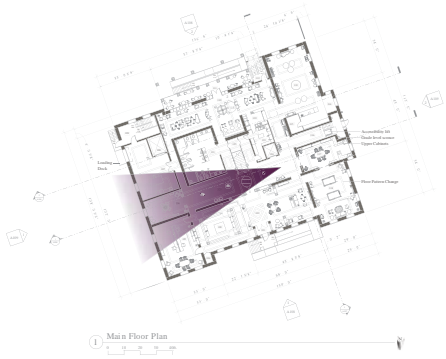



1 Section 3

0 10 20 30 40ft.

This caption includes a circled number '1' and the text 'Section 3'. Below the text is a scale bar with markings at 0, 10, 20, 30, and 40 feet.



Top: Figure 58. Gallery Elevation. Generated by author.
Left: Figure 59. Building Section. Generated by author.



Left: Figure 60. West Cafe Corridor Rendering. Generated by author.
Opposite: Figure 61. Group Fitness Studio Configurations. Generated by author.

Group fitness rooms are separated by a shared storage space that houses collapsible stationary bikes, step risers and platforms, stretching mats, skipping ropes, hula hoops, and other miscellaneous equipment. Constructed with folding partitions, this storage space can be collapsed so that the two areas can be joined to accommodate larger group performances and activities. This feature creates a space whose boundaries are fluid in that there are multiple different ways it can be configured (Figure 61). The folding wall's hammered glass partitions provide an obscured view into the adjacent space which creates a sense of this fluidity even when closed off, while the

storage space becomes an inhabitable chora when both walls are open –although the two spaces become one, the panels folded up against the walls provide a trace of their former boundaries and imply an inhabitable liminal space.

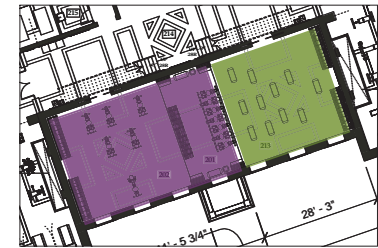
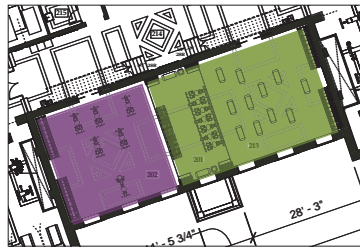
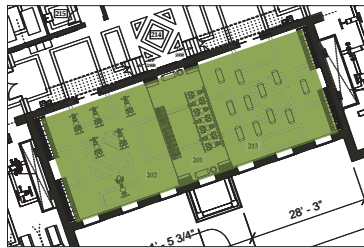
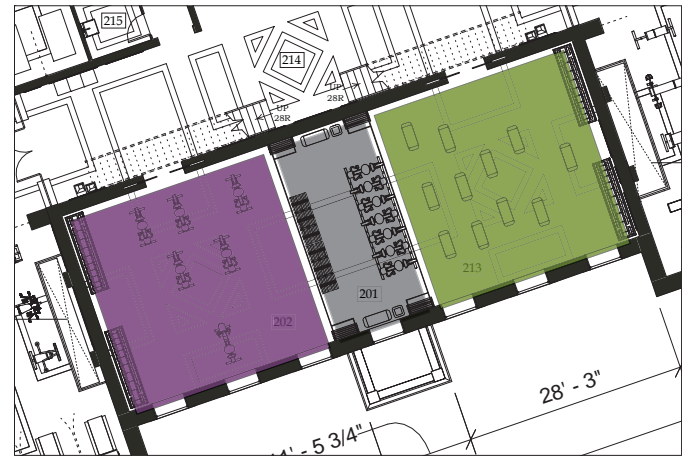

Discourses of public hygiene and individual responsibility result in locker rooms being designed as spaces strictly for complying with social codes of cleanliness where the locker room is a chora-like space (in Plato's sense – see section 2.2.0, page 66) from which individuals emerge as some ideal, sanitized citizen, cleaned of abject bodily excretions – sweat, dead skin, blood, body odour, bodily waste. These are typically not spaces designed to be inhabited for any length of time or purpose beyond cleaning and grooming the body for public presentation. Public locker rooms, including the shower and bathroom facilities that typically accompany them, are most often designed as cursory spaces for pre and post-workout hygiene, necessary but separated and abjected. Surfaces and finishes are designed to resist traces of human habitation and to encourage the minimal most time between locker room arrival and departure.

Designed to maximize efficiency, they discourage lingering and socializing (Fusco 2006). This design, on the other hand, endeavours to claim 'chora' as an inhabitable space. Rather than one that is simply passed through en route to or from working out, this locker room is part of a lounge which, centred around an existing light court, features furnishings akin to those found in the club's other social spaces like the café and main floor lounges (Figure 62).

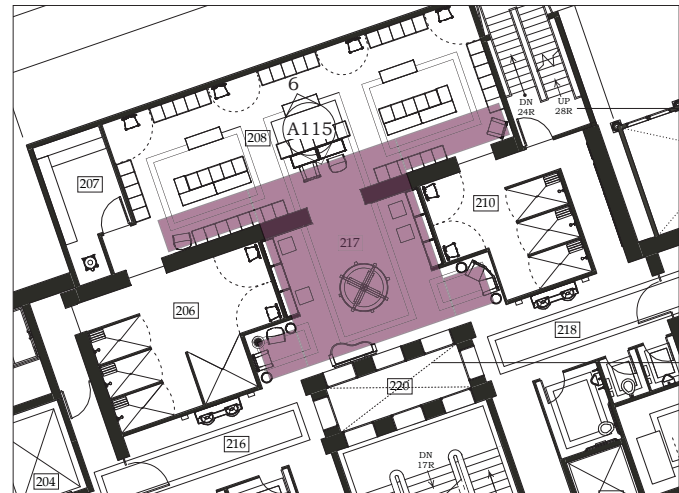

Above: Figure 62. Extension of Lounge Furniture into Locker Room
Opposite: Figure 63. Reception Desk Details. Generated by author.

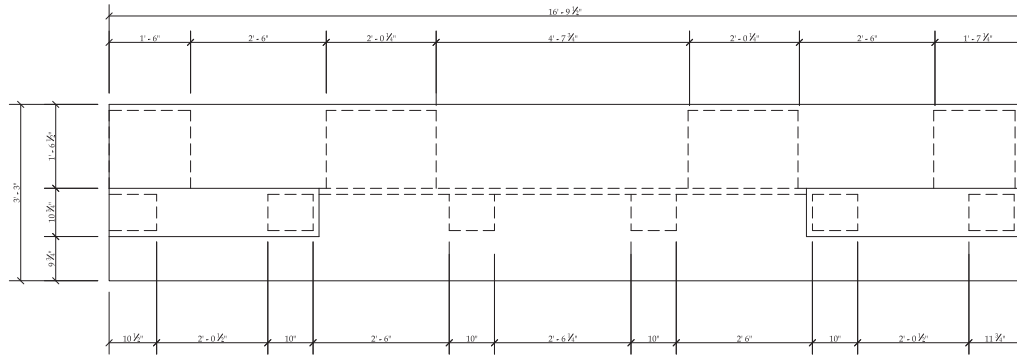

1 Reception Desk Plan
 D101

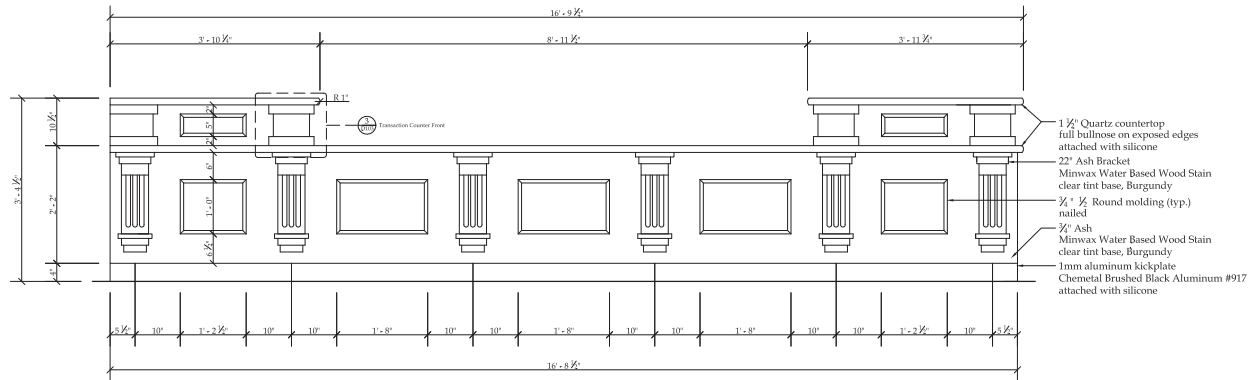

2 Reception Desk Elevation
 D101

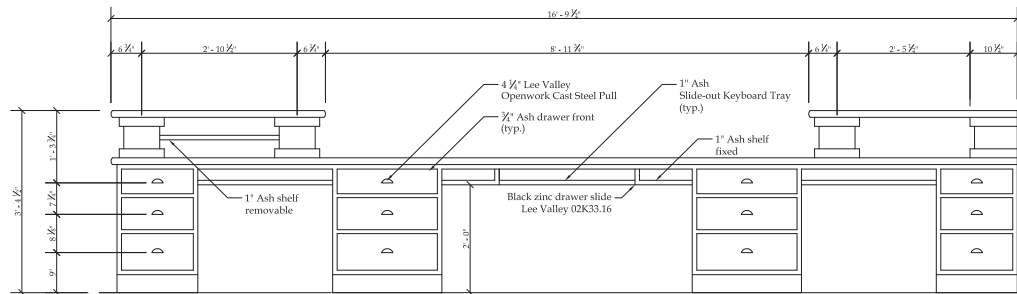

1 Reception Desk Elevation
 D102

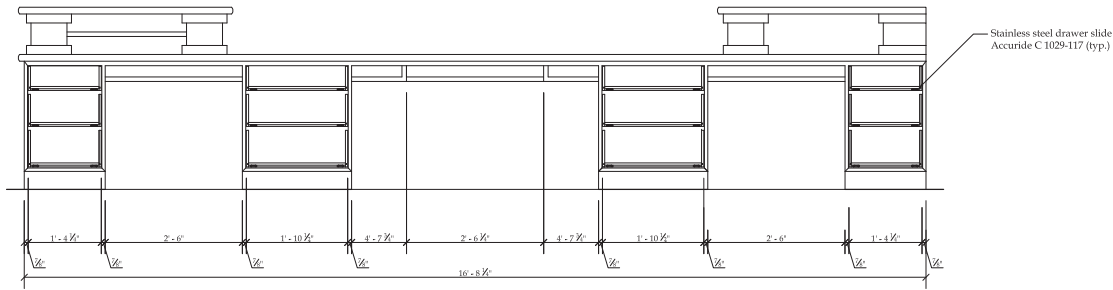

2 Reception Desk Section

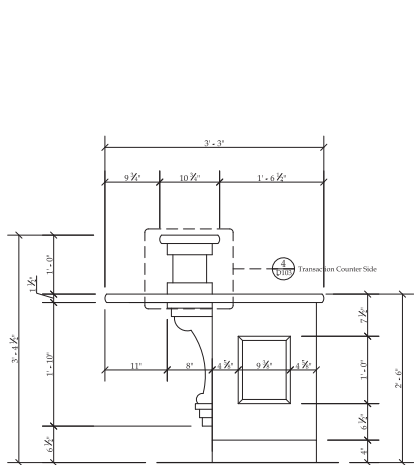
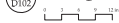

1 Reception Desk Elevation

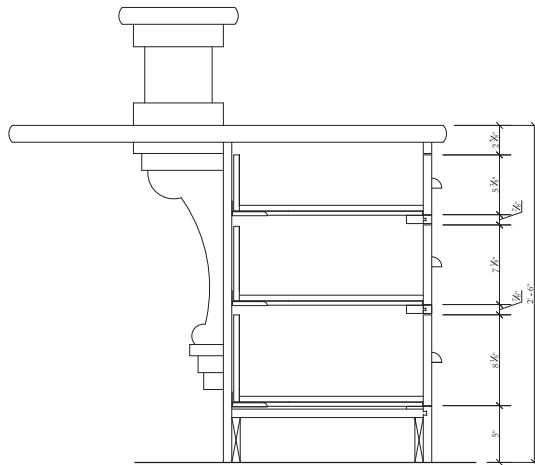

2 Reception Desk Section

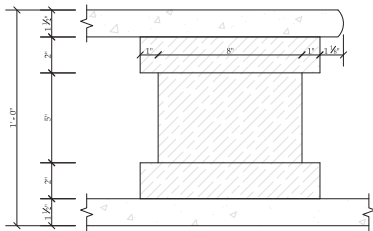

3 Transaction Counter Front Elevation

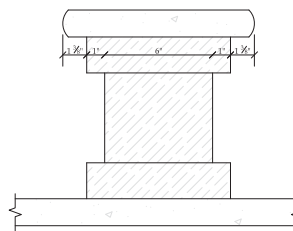

4 Transaction Counter Side Elevation

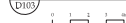

The dressing table, for example, is designed in a similar style and with similar materials and finishes to the main floor reception desk (Figures 63-64).

The connection to these spaces by way of furnishings and finishes such as wallpaper, upholstery, and lighting fixtures creates a similar atmosphere of sociality and lingering inhabitation. With similar visual and tactile stimuli, these spaces create an atmospheric continuity. By also creating visual connections between the locker room and workout spaces - by way of the light court whose windows connect occupants to both the east and west workout as well as to the main stair – the locker room is part of the facility rather than an ancillary space.

Connected to the workout areas by openings in the floor plane (Figures 37 and 56), the third floor track changes in shape and elevation to create a varied

spatiality as a person traverses its course.

Bifurcated on the East side with one section sloping and the other remaining level, users can choose a level change and likewise, where the track forks around the light court, they can also choose an alternate route (Figure 65). Coupled with changes in ceiling height that occur at different points along its course (Figure 53) these options create an imminence of space whereby the changes in volume and elevation they create produce a sense of something always about to take place.

Figure 64. Reception Desk Details. Generated by author.

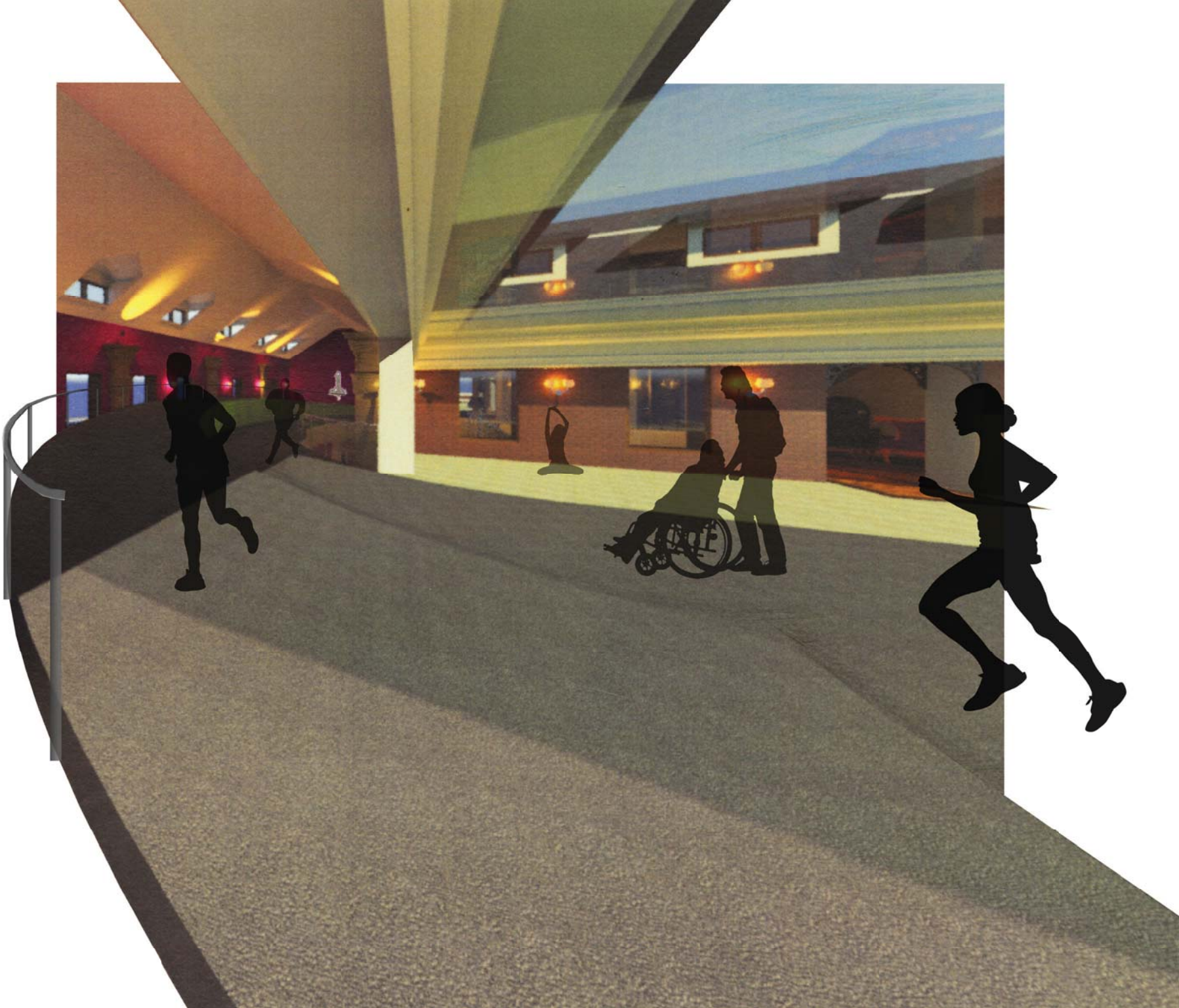

5.3.3 Juxtaposition

The juxtaposition that arises out of deconstruction could be made manifest in a number of different ways. As evidenced by the literature reviewed, interiority and exteriority form one of the foremost dualisms informing gendered fitness narratives. With privilege being given to exteriority, and more literally the replacement of flesh with muscle, interiority becomes the repressed abject whose return creates a deconstructive juxtaposition. By invoking this supposed binarism, this design reanimates the repressed by means of space planning, material selection, and furniture placement.



Opposite: Figure 65. Third Floor Track Rendering.
Generated by author.

5.3.3.0 Space Planning

While the existing layout of the building includes terrace spaces on the third level (Figure 66), as an exclusive member's only club, the building's current activities occur inside the building concealed behind drawn drapes. In this intervention, those spaces are opened up for inhabitation. Located on the third floor, (Figure 37) the track takes users from the original interior of building out onto these terraces which, enclosed with glass walls and ceilings, maintain the feeling of being on the building's exterior while having a seamless connection with the interior (Figure 67). Pivoting glass doors built into the newly constructed terrace walls allow the sounds, smells and sights of the street into the interior which, by blurring the boundaries between inside and outside, juxtapose interiority and exteriority. It also breaches traditional boundaries between building stories. In

its original inception, as mentioned previously, the third floor and attic of the building housed the club's service staff, but by creating the track as a mezzanine open to the workout areas below and the vaulted ceiling above, a juxtaposition of class is created. Opening up the building both between the interior and the street and between floor levels (Figures 53 and 55), creates a return of the repressed by opening up the elitism of the building and making it accessible to all users regardless of gender or class.

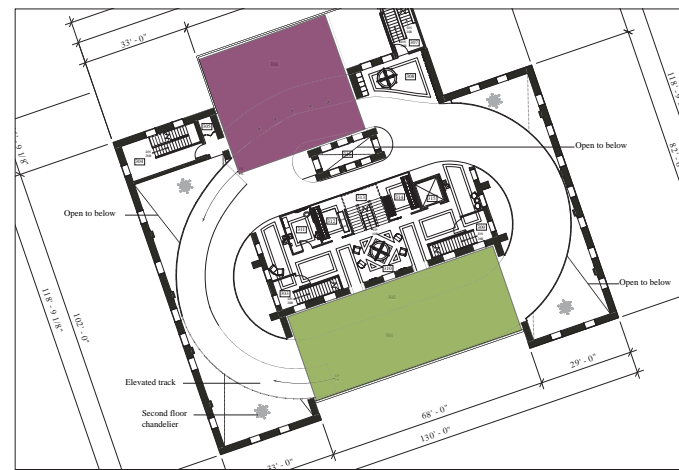



Opposite: Figure 66. Third Floor Terrace Plan | Above: Figure 67. Exterior Rendering. Generated by author.

With the programming of group fitness activities designed to acknowledge a diversity of bodies, it juxtaposes rigid, disciplined narratives of fitness with alternative narratives of fluidity and liminality. Classes like punk & heavy metal aerobics, hula hoop, and improvisational dance make room for less rigidly choreographed activities, in which a multitude of differently sexed and gendered bodies create unregulated, unanticipated movements all at the same time. The placement of the group fitness studio, as mentioned previously, situates this fluid programming in an historically privileged position that, in the men's club was reserved for members to gamble. Here their visibility and location established a hierarchy with the street, flaunting their status to the rest of the populace. Although traditional men's clubs disdained local gambling halls as deceitful, duping otherwise upstanding men into surrendering their reason and losing control,

gambling was considered acceptable among men's clubs patrons because their superior status ensured they were sufficiently disciplined to avoid giving up control of their rationality. By opening this traditionally exclusive and highly disciplined space to be occupied in fluid and undisciplined ways, this positioning juxtaposes the accepted with the abject, the exteriority of upper class, white masculinity, with the interiority of fluid bodies - because of the multiplicity and diversity they represent, the bodies in motion being produced (Figure 50), as well as the fluidity of the boundaries within the space offered by the retractable walls.

5.3.3.1 Material Selection

In a building whose interior is Victorian in its insularity, this opening up and blurring of boundaries achieved by features like the track as well as by the overlap of floor, ceiling, and wall

patterns discussed in the previous section – creates a juxtaposition visible in the application of materials as well as their transition between spaces. In a typology that privileges exteriority, the locker room in particular typically privileges hardness. As evidenced by my own observations (Appendix IV) and those of Fusco, the locker room is a space that, in an effort to discourage leisurely occupation, employs hard surfaces designed to resist traces and be easily disinfected. Materials tend to be white or light coloured so as to emphasize any traces that are left to mark them for removal. This preference for hard, neutral materials furthers the abjection of interiority by refusing softness and tactility. Cavanagh suggests that this predilection for hard white surfaces is also a mechanism by which to centre out anyone who deviates from the space's rigid gender norms (2010, 136). "Historically... modern, urban designs (circa 1930-1970s) were

lauded because they were believed to eradicate the possibilities of contamination and disease in public and private spaces" (Fusco 2006, 15) and in intimate spaces like locker rooms, or fitness clubs more generally, where body movements and secretions make it feel more exposed and perceivedly vulnerable, gender variance is often viewed as a contagion or threat. Emphasizing dimorphic and dichotomous sex, gender, and sexual desire, the discourses of healthism analysed by Fusco abject, not only communicable disease, but also the possibility of non-binary, non-natal sex and gender because of their capacity to destabilize the naturalness and exclusiveness of discourses of hetero and cissexual subjectivity (2006). In spaces reserved for same-sex usage – because heterosexuality is assumed – sexuality and sensuality are typically removed in order to preserve discourses of public health which object

both to same-sex desire and bodies and expressions that undermine the presumed naturalness of heterosexual cissexuality. Whereas typically “the architectural aesthetics of these locker rooms are modern: they contain no excessive features or ornamentation of any kind” (Fusco 2006, 15), this design returns softness and tactility, ornamentation and decoration to the fitness club. In a deliberate juxtaposition with these discourses that demand hard, neutral finishes, the materials selected aim to celebrate a certain sensuality that belongs to all bodies particularly in a space that is geared toward the physical and mental health of said bodies. Materials chosen for this project thus exhibit a tactility that invites touch and shows traces thereof. Velvet and velvet flocked fabrics whose nap reveals its interaction with previous occupants are used for both upholstery and draperies, bringing a softness associated with interiority to a typology - both the

men’s club and the fitness club – that privileges hardness and exteriority (Figure 42).

This is one of the reasons Victorian style furniture was chosen. Its prevalence for luxuriant upholstery and voluptuous cushioning reiterates this softness, but also, as a style that was actually a bricolage of multiple historical and stylistic influences and traditional furniture pieces, it refuses to be bound to the rigidity of any one stylistic movement creating an eclectic juxtaposition, not unlike Weisbrot’s metaphor of the curio cabinet or Eli Clare’s assertion that “...bodies are never singular, but rather haunted, strengthened, underscored by countless other bodies” (Clare 2009, 10). The furniture selection reflects these ideas while Victorian light fixtures lend an additional sense of eclecticism with their placement and switching providing dramatic levels. The lighting scheme

contributes to this luxe atmosphere highlighting the material selection as well as emulating the ‘men’s club’s’ old nemesis, the gambling hall or, as Rendell describes, ‘gambling hell’.



5.3.3.2 Furniture Placement

Fluid boundaries created by floor patterning and furniture and equipment placement allow a deconstructive juxtaposition to be observed. In the second floor East and West workout areas, the intermixing of cardiovascular, muscle conditioning, and stretching equipment resists the typical separation of cardio exercise and weight training that occurs in the majority of club designs. In all of the fitness clubs observed, equipment was grouped according to these activities – cardiovascular equipment was contained to a particular area, weight machines to another separate area, free weights to another zone typically adjacent to the

weight machines, and stretching related equipment in its own separate area. (Appendix IV) While this typical separation contributes to the separation of bodily expectations based on sex, in this proposal, the integrated placement of different types of equipment (Figure 68) encourages a more balanced use of equipment, a less gender-segregated distribution of users, and more abstractly, a juxtaposition of the interiority and exteriority that traditional gym culture represents and reinforces; the gendering of activities as a means by which to achieve certain bodily ideals interiorizes cardiovascular activity and exteriorizes weight training.

Outside the workout area, the extension of activities beyond designated rooms blurs the building’s original insular boundaries and, in so doing, juxtaposes conventional architectural conceptions,



LEGEND	
	Cardiovascular Equipment
	Weight Equipment
	Stretching Mats

particularly as related to a building of this type and era, of interiority and exteriority. With activities not bound by walls, or in some cases separated by floors, there is a juxtaposition of the building's elitist history which confined certain users to specific areas and entry points – such as the former ladies' entrance via fort street and a designated ladies' lounge outside of which women were not allowed – with the bleeding and extension of activities beyond walls and unsegregated by sex.

As it is currently used, activities are concealed within the building behind heavily draped windows. By not only making the building more permeable (Figure 69) but by also positioning outdoor furniture near the North and South entrances (Figures 32 and 70), the public is invited to be part of both the programming and community within.

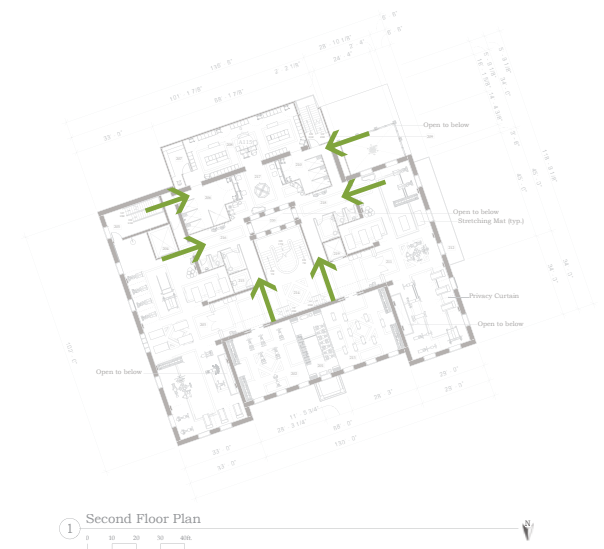

Opposite: Figure 68. Equipment Distribution. Generated by author.
Above: Figure 69. Building Permeability. Generated by author.

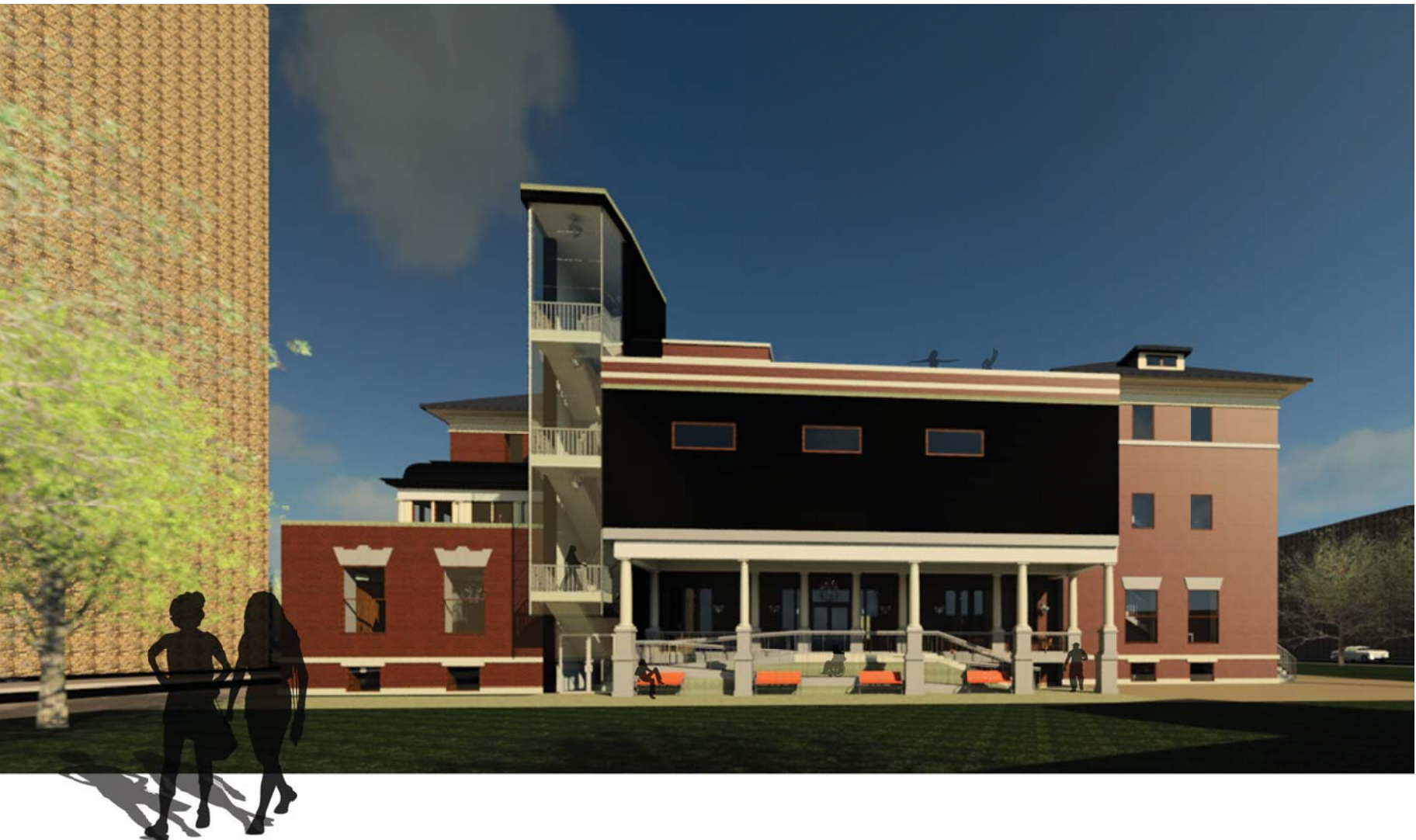

5.4 Chapter Five Summary

Ultimately, all of these factors work together to achieve the desired effect – the imminence of space, for example, contributes to a decentering of the gaze which allows juxtaposition to occur. The comments derived from the interviews were instrumental in translating and applying these concepts from the theory to built form and, in many ways, echoed similar sentiments to each other and to the literature. Both the programming and the design concept were centred around creating privacy to accommodate a multiplicity of perspectives, blurring boundaries, and challenging assumptions about sex and gender as either/or inhabitations and presentations.

A diversity of programming allows for sociality and community, including exercise for the mind as well as the body, and while it maintains the clubhouse atmosphere of the original building, it also provides opportunities for questioning dominant definitions of “fit” bodies – their embodiment (shape, size, anatomy) and expression (dress, mannerisms) – as well as what form(s) fitness activities take.

Opposite: Figure 70. Southeast Exterior Rendering

CONCLUSIONS

REFLECTIONS & FUTURE DIRECTIONS



6.0 Introduction

A decorative flourish consisting of a horizontal line with ornate, symmetrical scrollwork extending downwards from both ends.

North American society, though diverse in many ways, is dominated by a persistent investment in binary sex and gender. The norms this investment precipitates permeate our institutions, our policies, and our interiors. Though challenged by academics and activists in gender and queer studies and issues, hetero- and cissexist attitudes are largely accepted as natural and essential.

6.1 Challenges & Limitations

This practicum project was undertaken with the intent of designing a fitness facility that challenged normative conventions around binaries of sex, gender, and sexuality, and in so doing, create a space that was inclusive of transgender populations. One of the biggest challenges of such a project was its immensity as compared to the more limited scope of the master's practicum project.

Developing a design proposal that challenged conventions was achieved by means of literature review including texts from gender and queer theory, trans studies, fitness studies and industry analyses, and architectural theory, and through a design investigation that explored the translation of

these theories into built form. Creating a space that was verifiably inclusive of trans populations, however, proved a task too large for the scope of the practicum. As community-based design research suggests, “it is vital... to examine the experiences of actual people as they negotiate gender, sexuality, and identity in contexts of cultural and political transformation” (Towle and Morgan 2006, 671), not to mention spatial transformation. While I endeavoured to connect with trans communities via one on one interviews to determine the kinds of services, amenities, and atmospheric qualities that might foster a more inclusive space, my attempts were largely

unsuccessful. On the advice of a department member, a sample size of fifteen was the uppermost limit manageable within the scope of the Master's Practicum, and given the vast diversity of different embodiments and expressions of sex and gender to be accounted for, such a sampling simply would not have been able to adequately represent the transgender population even if it had been exercised to this suggested maximum. In retrospect, and in a larger study, I might have employed a combined process involving both interviews and surveys in an effort to secure more participation.

The complicity of architecture with cissexual and heteronormative ideologies runs deeper than just anatomy and gender presentation; it is manifest in a myriad of ways, not all of which could be addressed in this project. Because sex, gender, and sexuality are indissociable from other

circumstances such as class, race, and ability, further study might also investigate ways in which to overturn assumptions and discourses in fitness culture about gender's intersections with such circumstances.

6.2 Future Directions

Despite its shortcomings, one of the successes of this project is in creating a foundation for further research to occur. Based on feedback from LGBTQ centre liaisons who reported positive reactions to the interview invitations from their constituency, there is an interest in alternative fitness club design. Future studies, then, might take up a similar project through a more expansive interview process, similar to Sheila Cavanagh's work on bathrooms, exploring trans communities' perspectives and experiences of gender and sexuality in fitness clubs and the needs and desires for alternative, dedicatedly trans-friendly designs. While Caroline Fusco's work interviews caretaking and

administrative staff on the subject of 'othered' bodies and discourses of public health in locker rooms, it is first of all limited to the locker room, and secondly limited in the number and breadth of individuals consulted in that it focuses on staff and does not consult members. It does, however, provide an excellent theoretical analysis of both Fusco's interviews and her own observations in an area of research that is relatively untouched. Having received little critical attention, the fitness club, as a purveyor of naturalized discourses of health and fitness, is a site of both reinforcement and potential contestation of binary sex and gender narratives.

That being said, the fitness club or even the oft studied washroom, by no means run the gamut of sex and gender-segregated space. There are a number of other typologies whose heavy investment in binary sex and gender warrant investigating including public swimming pools, educational facilities, and detention centres to name only a few.

6.3 Personal Reflections

One of the biggest lessons learned from tackling a project of this magnitude for the first time relates most definitely to the magnitude. The success of the project is largely dependent on selecting a manageable scope and being specific in setting goals. Some of the limitations described above are the direct result of a game plan that began as a grand scheme that was not only ambitious, but was beyond the ability of the practicum scope. As a student and designer, and in this case project manager, it would have been a much more efficient process had I narrowed the focus from the beginning and either focussed more exclusively on a transgender-friendly space, or on a space aimed

at challenging dominant gender norms. In the end, I think it befitting the goals and scope of the Masters of Interior Design practicum that I ended up gearing the project toward the latter because, as previously mentioned, of the diversity and quantity of interview participants required to do justice to the former. This is a lesson that will serve me well in practice whether I am designing or managing projects. Identifying and prioritizing clear and explicit goals will make the design process, not only more efficient, but more effective in meeting the needs of clients and my design team.

That being said, this experience has also imparted

the need for adaptability. Regardless of how focussed a project's goals, whether academic or architectural, there are always going to be obstacles in achieving those goals. It's critical to recognize when to find an alternate path to achieve the same end, and when to re-evaluate the goals themselves and scale back. It was difficult, but necessary, to let go of some of my initial goals for the project when certain requirements could not be met – limited interview testimony trumped the aim of a community based design project. On the other hand, building code requirements and material availability were surmountable obstacles – I was able to achieve my design goals by adapting the design without sacrificing the intent. Recognizing the difference between the two is key.

This project also presented the first opportunity to grapple with managing the concerns and

expectations of multiple clients in the form of the committee. While the masters curriculum involves a great deal of group work that simulates the experience of working as part of a design team, there is little opportunity to engage in a process similar to managing the needs and requests of multiple and varied clients. It was a valuable process in learning how better to communicate the design process and its products to an audience from varied disciplines. While it is a skill I have yet to master I know that it will help me going into the industry to have communicated and defended my work to such a diverse audience.

Knowing that, this project has also reinforced the importance of client consultation during the programming phase. In future I would begin the interview process before, or at the very least, concurrent with the literature review. While it

would have delayed the completion of this project because of the necessity of acquiring ethics approval prior to beginning the interviews, my reading of the literature might have been different had I been able to reflect on interview testimony in the process. While I am not conscious of having done so, I suspect that I must have projected onto or interpreted the interviews based on my interpretation of the literature, whereas for a more community-based approach, the opposite would have been preferable.

Despite this, the project has met its goal of challenging hetero and cis-normative narratives. What this project has laid is groundwork for future research, both theoretical and community-design based. By cataloguing and examining some of the ways that fitness clubs and indeed the built environment more generally are invested in binary

sex and gender, this practicum offers a baseline for examining other typologies and proposing additional, alternative challenges to building conventions that privilege hetero and cissexism. It successfully worked within a dominant architectural ideology and used its conventions to intervene with an alternative narrative. It also has questioned some of the norms of design practice and education, such as the study of anthropometrics and human behaviour theories, and the segregated gender narratives their use and presentation reinforce.

It is from this that the title, *Resistance Training* derives. In fitness club lingo, resistance training is interchangeable with strength or weight training (State Government of Victoria 2014) and while I do not dispute its potential health benefits, strength training connotes the privileging of exteriority over

interiority and the correlations between this hierarchy and conventional gendered divisions. Like ‘muscle conditioning’ this term is reminiscent of Butler’s notion of performativity and the behavioural conditioning of hetero and cisnormative conventions that through repetition train people to accept certain bodies, behaviours, and desires as normal or natural. Resistance, however, also connotes defiance and in this case the refusal of this project to recognize dominant narratives including the exclusionary history of the building and its typology, and the cis and heteronormative values that pervade North American fitness club design, giving voice instead to alternative conceptions of sex, gender, and sexuality. Instead of privileging the same socio-cultural narrative of the upper class, white, heterosexual, able-bodied male, this project provides opportunities for a number of different

narratives, embodiments, expressions, and experiences to be articulated. The title, then, represents in and of itself, a juxtaposition of the accepted and the abject – resistance training as strength training being the accepted and the refusal of binary narratives as the abject. In the same way that physically “resistance training is based on the principle that muscles of the body will work to overcome a resistance force when they are required to do so. When you do resistance training repeatedly and consistently, your muscles will become stronger” (Ibid.) designs that resist dominant narratives will, over time, build strength toward changing accepted and legislated practices and procedures.

BIBLIOGRAPHY

Agrest, Diane. "Architecture from Without: Body, Logic and Sex." Chap. 39 in *Gender Space Architecture*, edited by Jane Rendell, Barbara Penner and Iain Borden, 358-370. London: Routledge, 1999.

Barnes, Ruth. "Introduction." *Dress and Gender: Making and Meaning in Cultural Contexts*. Edited by Ruth Barnes and Joanne B. Eicher, 8-28. New York: Berg Publishers, 1992.

David Barton Gym. *History*. 2013. <http://www.davidbartongym.com/index.php#!/history> (accessed March 2013).

Bergman, S. Bear. "Part-time Fatso." In *Fat Studies Reader*, edited by Esther Rothblum and Sondra Solovay, 139-142. New York: New York University Press, 2009.

Bloodsworth-Lugo, Mary K. *In-Between Bodies: Sexual Difference, Race, and Sexuality*. Albany: State University of New York Press, 2007.

Bloyd, S. "'Bathroom Bill' Sparks Accessibility Debate." *Club Industry's Fitness Business Pro* 25, no. 8 (2009): 16.

Bornstein, Kate, and S. Bear Bergman, ed. *Gender Outlaws: The Next Generation*. Kobo edition. Berkeley: Seal Press, 2010.

Brooker, Graeme, and Sally Stone. *What is Interior Design?* Mies: RotoVision SA, 2010.

Butler, Judith. *Bodies that Matter: On the Discursive Limits of Sex*. Kobo e-reader edition. New York: Routledge, 1993.

—. *Gender Trouble: Feminism and the Subversion of Identity*. New York: Routledge, 1990.

—. *Undoing Gender*. New York: Routledge, 2004.

Cavanagh, Sheila. *Queering Bathrooms: Gender, Sexuality, and the Hygienic Imagination*. Toronto: University of Toronto Press, 2010.

Chase, Cheryl. "Affronting Reason." In *GenderQueer: Voices from Beyond the Sexual Binary*, edited by Joan Nestle, Clare Howell and Riki Wilchins, 204-219. New York: Alyson Books, 2002.

Chitham, Robert. *The Classical Orders of Architecture*. 2nd. Oxford: Architectural Press, 2005.

Clare, Eli. *Exile and Pride: Disability, Queerness and Liberation*. The Classics Edition. Online audio files. South End Press, 2009.

Clerkin, Paul. *Archiseek: 1905 - Manitoba Club*, Winnipeg, Manitoba. 2012.
<http://archiseek.com/2010/1905-manitoba-club-winnipeg-manitoba/#.UICtMBBpbh4>
(accessed October 5, 2013).

Connell, Catherine. "Doing, Undoing, or Redoing Gender? : Learning from the Workplace Experiences of Transpeople." *Gender & Society* (Sage Publications) 24, no. 31 (2010): 31-55.

Connelly, Sherilyn. "The Big Reveal." In *Gender Outlaws: The Next Generation*, edited by Kate Bornstein and S. Bear Bergman. Kobo edition. Berkeley: Seal Press, 2010.

- Coverton, Gillian. [Thesis] "A System of Morality Veiled in Allegory: the Private Rituals and Public Performances of Free Masons in Winnipeg, 1864-1900." *MSpace*. 1993.
<http://hdl.handle.net/1993/3300> (accessed September 2013).
- Cromwell, Jason. "Queering the Binaries: Transsituated Identities, Bodies, and Sexualities." In *The Transgender Studies Reader*, edited by Susan Stryker and Stephen Whittle, 509-519. New York: Routledge, 2006.
- Dacumos, Nico. "All Mixed Up With No Place to Go: Inhabiting Mixed Consciousness on the Margins." In *Nobody Passes: Rejecting the Rules of Gender and Conformity*, edited by Mattilda A.K.A Matt Bernstein Sycamore, 20-37. Emeryville: Seal Press, 2006.
- Davis, Fred. "Ambivalences of Gender: Boys Will Be Boys, Girls Will Be Boys." Chap. 3 in *Fashion, Culture and Identity*, by Fred Davis, 31-54. Chicago: University of Chicago Press, 1992.
- Davis, Fred. "Identity Ambivalence, Fashion's Fuel." Chap. 2 in *Fashion, Culture and Identity*, by Fred Davis, 19-29. Chicago: University of Chicago Press, 1992.
- Diamond, Katie, and Johnny Blazes. "transcension." In *Gender Outlaws: The Next Generation*, edited by Kate Bornstein and S. Bear Bergman. Kobo edition. Berkeley: Seal Press, 2010.
- Difranco, Ani. "In or Out." *Imperfectly*. Comp. Ani Difranco. 1992. compact disc.
- Doan, Petra L. "The Tyranny of Gendered Space." *Gender, Place and Culture* 17, no. 5 (2010): 635-654. Retrieved June 11, 2014 from <http://dx.doi.org/10.1080/0966369X.2010.503121>
- Dozier, Raine. "Beards, Breasts, and Bodies: Doing Sex in a Gendered World." *Gender and Society* (Sage Publications, Inc.) 19, no. 3 (June 2005): 297-316. Retrieved June 11, 2014 from <http://www.jstor.org/stable/30044595>

Dworkin, Sheri L. "A Woman's Place is in the... Cardiovascular Room?? Gender Relations, the Body, and the Gym." Chap. 6 in *Athletic Intruders: Ethnographic Research on Women, Culture, and Exercise*, edited by Anne Bolin and Jane Granskog, 131-158. Albany: State University of New York Press, 2003.

Dworkin, Sheri, and Faye Wachs. *Body Panic: Gender, Health, and the Selling of Fitness*. New York: New York University Press, 2009.

Farkas, Carol-Ann. "Bodies At Rest, Bodies In Motion: Physical Competence, Women's Fitness, and Feminism." Edited by Ann Kibbey. *Genders* (University of Colorado), no. 45 (2007): 1-36. Retrieved April 15, 2013 from http://www.genders.org/g45/g45_farkas.html

Farlex. *The Free Dictionary*. 2000. <http://www.thefreedictionary.com/purity> (accessed December 3, 2014).

Feinberg, Leslie. *Transgender Warriors: Making History from Joan of Arc to Dennis Rodman*. Boston: Beacon Press, 1996.

Fowler, Alastair. *Spenser and the Numbers of Time*. London: Routledge and Paul, 1964.

Freud, Sigmund. "The 'Uncanny'. Vols. XVII (1917-1919)," in *The Standard Edition of the Complete Psychological Works of Sigmund Freud*, by Sigmund Freud, translated by James Strachey, 218-252. Toronto: The Hogarth Press Limited, 1955.

Fusco, Caroline. "Spatializing the (Im)Proper Subject: The Geographies of Abjection in Sport and Physical Activity Space." *Journal of Sport and Social Issues* 30, no. 5 (2006): 5-28.

Government of Ontario. *Why Exercise is Vital to Health*. October 18, 2013. <http://www.mhp.gov.on.ca/en/active-living/exercise.asp> (accessed March 18, 2014).

- Grant, Jaime M., Lisa A. Mottet, and Justin Tanis. *Injustice at Every Turn: A Report of the National Transgender Discrimination Survey*. Survey, Washington DC: The National Gay and Lesbian Task Force and the National Centre for Transgender Equality, 2011. Retrieved January 25, 2014 from http://endtransdiscrimination.org/PDFs/NTDS_Report.pdf
- Grosz, Elizabeth. *Volatile Bodies: Toward a Corporeal Feminism*. Indianapolis: Indianapolis University Press, 1994.
- Grosz, Elizabeth. "Woman, Chora, Dwelling." Chap. 25 in *Gender Space Architecture: Interdisciplinary Introduction*, edited by Jane Rendell, Barbara Penner and Iain Borden, 210-221. London: Routledge, 2000.
- Heritage Winnipeg. *Vignettes: Greater Winnipeg: Adelaide-Forks: Manitoba Club*. n.d. http://www.virtual.heritagewinnipeg.com/vignettes/vignettes_122W.htm# (accessed April 21, 2013).
- Howell, Clare. "Stories." In *GenderQueer: Voices from Beyond the Sexual Binary*, edited by Joan Nestle, Clare Howell and Riki Wilchins, 18-20. New York: Alyson Books, 2002.
- Ian, Marcia. "Gym." In *Stud: Architectures of Masculinity*, edited by Joel Sanders, 188-223. New York: Princeton Architectural Press, 1996.
- James, Allen. "Not as if You Felt That Way, But..." In *GenderQueer: Voices from Beyond the Sexual Binary*, edited by Joan Nestle, Clare Howell and Riki Wilchins, 127-129. New York: Alyson Books, 2002.
- Johansson, Thomas. "Gendered Spaces: The Gym Culture and the Construction of Gender." *Chinese University of Hong Kong*. 1996. <http://logic.itsc.cuhk.edu.hk/~b114299/young/1996-3/artikkelJohansson3-96.htm> (accessed May 2013).
- Johnson, Philip, and Mark Wigley. *Deconstructivist Architecture*. Boston: Little Brown and Company, 1988.

- Kaldera, Raven. "Do it On the Dotted Line." In *GenderQueer: Voices from Beyond the Sexual Binary*, edited by Joan Nestle, Clare Howell and Riki Wilchins, 156-160. New York: Alyson Books, 2002.
- Jhally, Sut. (Director) and Ericsson, Susan and Talreja, Sanjay. (Producers). (1999). *Tough Guise: Violence, Media & the Crisis in Masculinity* [Motion Picture]. USA: The Media Education Foundation.
- John D. Atchison & Company Architects. *Alterations and Additions for The Manitoba Club*. [Architectural Plans]. Winnipeg, April 25, 1913. Public domain, used with permission of the Manitoba Archives.
- Kessler, Susan J., and Wendy McKenna. "Toward a Theory of Gender." In *The Transgender Studies Reader*, edited by Susan Stryker and Stephen Whittle, 165-182. New York: Routledge, 2006.
- Kirby, Scott. *Gymnasium: A Brief History*. April 2, 2013.
<http://scottkirby2.wordpress.com/2013/04/02/gymnasium-a-brief-history/> (accessed April 2013).
- Kusalik, Telyn. "Identity Schmidentity." In *Gender Outlaws: The Next Generation*, edited by Kate Bornstein and S. Bear Bergman. Kobo edition. Berkeley: Seal Press, 2010.
- Leeds Craig, Maxine, and Rita Liberti. "'Cause That's What Girls Do": The Making of a Feminized Gym." *Gender and Society* 21, no. 5 (October 2007): 676-699. Retrieved April 9, 2013 from <http://www.jstor.org/stable/27641005>
- Levy-Navarro, Elena. "Fattening Queer History." In *Fat Studies Reader*, edited by Esther Rothblum and Sondra Solovay, 15-22. New York: New York University Press, 2009.
- Lie, Allie. "Passing Realities." In *GenderQueer: Voices from Beyond the Sexual Binary*, edited by Joan Nestle, Clare Howell and Riki Wilchins, 166-170. New York: Alyson Books, 2002.
- Lieberman, Tucker. "Hat." In *Nobody Passes: Rejecting the Rules of Gender and Conformity*, edited by Mattilda A.K.A Matt Bernstein Sycamore, 243-253. Emeryville: Seal Press, 2006.

Link, Aaron. "Scars." In *GenderQueer: Voices from Beyond the Sexual Binary*, edited by Joan Nestle, Clare Howell and Riki Wilchins, 94-95. Berkeley: Seal Press, 2002.

Link, Aaron. "Vision." In *GenderQueer: Voices from Beyond the Sexual Binary*, edited by Joan Nestle, Clare Howell and Riki Wilchins, 86-89. New York: Allyson Books, 2002.

Lionheart. "Wanting Men." In *GenderQueer: Voices from Beyond the Sexual Binary*, edited by Joan Nestle, Clare Howell and Riki Wilchins, 228-237. New York: Alyson Books, 2002.

Lowrey, Sassafras. "Today's New Name May Be Tomorrow's Old." In *Gender Outlaws: The Next Generation*, edited by Kate Bornstein and S. Bear Bergman. Kobo edition. Berkeley: Seal Press, 2010.

Maltz, Robin. "Fading to Pink." In *GenderQueer: Voices from Beyond the Sexual Binary*, edited by Joan Nestle, Clare Howell and Riki Wilchins, 161-165. New York: Alyson Books, 2002.

Manitoba Club. *Manitoba Club: Parking and Map*. 2013. <http://www.manitobaclub.mb.ca/parkingmap> (accessed April 20, 2012).

Mansfield, Alan, and Barbara McGinn. "Pumping Iron: The Muscular and the Feminine." Chap. 4 in *Body Matters: Essays on the Sociology of the Body*, edited by Sue Scott and David Morgan, 49-68. London: The Falmer Press, 2004.

Mattilda, ed. *Nobody Passes*. Emeryville: Seal Press, 2006.

McLeod, Mary. "'Other' Spaces and 'Others'." In *The Sex of Architecture*, edited by D Agrest, P Conway and L.K. Weisman. New York: Harry N. Abrams, Inc., 1996.

Montgomery, Stacey. "Twenty Passings." In *GenderQueer: Voices from Beyond the Sexual Binary*, edited by Joan Nestle, Clare Howell and Riki Wilchins, 238-246. New York: Alyson Books, 2002.

- Morgan, David. "You Too Can Have a Body Like Mine: Reflections on the Male Body and Masculinity." Chap. 5 in *Body Matters: Essays on the Sociology of the Body*, edited by Sue Scott and David Morgan, 69-88. London: The Falmer Press, 2004.
- Munson, Peggy. "Do Your Ears." In *GenderQueer: Voices from Beyond the Sexual Binary*, edited by Joan Nestle, Clare Howell and Riki Wilchins, 147-155. New York: Alyson Books, 2002.
- Munson, Peggy. "Liminal." In *GenderQueer: Voices from Beyond the Sexual Binary*, edited by Joan Nestle, Clare Howell and Riki Wilchins, 143-146. New York: Alyson Books, 2002.
- Murphy, Timothy. "The Man Who Made Working Out Cool." *The New York Times*, April 27, 2011.
- N-Plus Architecture and Design, and RSVP Architecture Studio. *The Centre: The Lesbian, Gay, Bisexual & Transgender Community Centre*. [Renderings of Interior] Used with permission of Nicola Mongelli, N-Plus Architecture and Design (as per email received April 15, 2014). Images retrieved April 18, 2013 from <http://mycenter.gaycenter.org/page.aspx?pid=315>
- Namaste, Viviane K. "Genderbashing: Sexuality, Gender, and the Regulation of Public Space." In *The Transgender Studies Reader*, edited by Susan Stryker and Stephen Whittle, 584-600. New York: Taylor and Francis, 2006.
- Nangeroni, Nancy, and Gordene Mackenzie. "Performing Transliberal." In *GenderQueer: Voices from Beyond the Sexual Binary*, edited by Joan Nestle, Clare Howell and Riki Wilchins, 253-259. New York: Alyson Books, 2002.
- Nestle, Joan. "Genders on My Mind." In *GenderQueer: Voices from Beyond the Sexual Binary*, edited by Joan Nestle, Clare Howell and Riki Wilchins, 3-10. New York: Alyson Books, 2002.
- Nestle, Joan, Clare Howell, and Riki Wilchins, ed. *GenderQueer: Voices from Beyond the Sexual Binary*. New York: Alyson Books, 2002.

Nguyen, L, and A Cross. "Ontario Gym Owner Fumes After Transgender Bathroom Battle." *Canwest News*, 2009.

Paechter, Carrie. "Masculinities and Femininities as Communities of Practice." *Women's Studies International Forum* 26, no. 1 (2002): 69-77.

Palmer, Paulina. *The Queer Uncanny: New Perspectives on the Gothic*. Cardiff: University of Wales Press, 2012.

Palumbo, M. The Building for You Center. n.d. <http://mycenter.gaycenter.org/page.aspx?pid+315> (accessed April 18, 2013).

Picard, Andre. "Why the Sedentary Live is Killing Us." *The Globe and Mail*, October 15, 2012, Online ed.

Pile, John. *A History of Interior Design*. 3rd. Hoboken: John Wiley & Sons, Inc., 2009.

Prosser, Jay. "Judith Butler: Queer Feminism, Transgender, and the Transubstantiation of Sex." In *The Transgender Studies Reader*, edited by Susan Stryker and Stephen Whittle, 257-280. New York: Routledge, 2006.

Reed, Christopher. "Imminent Domain: Queer Space in the Built Environment." *Art Journal* (College Art Association) 55, no. 4 (Winter 1996): 64-70.

—. "Introduction." In *Not at Home: The Suppression of Domesticity in Modern Art and Architecture*, edited by Christopher Reed, 7-17. London: Thames and Hudson, Ltd., 1996.

—. *Not at Home: The Suppression of Domesticity in Modern Art and Architecture*. London: Thames and Hudson, 1996.

- Rendell, Jane. "The Clubs of St. James's: Places of Public Patriarchy - Exclusivity, Domesticity and Secrecy." *The Journal of Architecture* (Routledge) 4, no. 2 (1999): 167-189.
- Rivera, Sylvia. "Queens in Exile: the Forgotten Ones." In *GenderQueer: Voices from Beyond the Sexual Binary*, edited by Joan Nestle, Clare Howell and Riki Wilchins, 67-85. New York: Alyson Books, 2002.
- Rodriguez, Esme. "Glitter, Glitter, on the Wall, Who's the Queerest of Them All?" In *Gender Outlaws: The Next Generation*, edited by Kate Bornstein and S. Bear Bergman. Kobo edition. Berkeley: Seal Press, 2010.
- Rothblatt, Martine. *The Apartheid of Sex: a Manifesto on the Freedom of Gender*. New York: Crown Publishers, Inc., 1995.
- Sanders, Joel. "Introduction." In *Stud: Architectures of Masculinity*, edited by Joel Sanders, 11-25. New York: Princeton Architectural Press, 1996.
- Sanoff, Henry. "Community Based Design Learning." In *Design Studio Pedagogy: Horizons for the Future*, edited by Ashraf M. Salama and Nicholas Wilkinson, 21-38. Gateshead: The Urban International Press, 2007.
- Schilt, Kristen, and Laurel Westbrook. "Doing Gender, Doing Heteronormativity: 'Gender Normals,' Transgender People, and the Social Maintenance of Heterosexuality." *Gender and Society* (Sage Publications) 23, no. 4 (2009): 440-464. Retrieved June 11, 2014 from <http://www.jstor.org/stable/20676798>
- Semes, Steven W. *The Architecture of the Classical Interior*. New York: W. W. Norton & Company, 2004.
- State Government of Victoria. *Better Health Channel*. February 2014. www.betterhealth.vic.gov.au/bhcv2/bhcarticles.nsf/pages/Resistance_training_the_health_benefits (accessed November 27, 2014).

Statistics Canada. "Canadian Health Measures Survey: Adult Obesity Prevalence in Canada and the United States." *The Daily*. March 3, 2011. <http://www.statcan.gc.ca/daily-quotidien/110302/dq110302c-eng.htm> (accessed October 2012).

Statistics Canada. *Directly Measured Physical Activity of Canadian Adults, 2007-2011*. May 30, 2013. <http://www.statcan.gc.ca/pub/82-625-x/2013001/article/11807-eng.htm> (accessed March 18, 2014).

Stone, Sandy. "The Empire Strikes Back: A Posttranssexual Manifesto." In *The Transgender Studies Reader*, edited by Susan Stryker and Stephen Whittle, 221-235. New York: Routledge, 2006.

Taylor, Evin. "Cisgender Privilege: On the Privileges of Performing Normative Gender." In *Gender Outlaws: The Next Generation*, edited by Kate Bornstein and S. Bear Bergman. Kobo edition. Berkeley: Seal Press, 2010.

Towle, Evan B, and Lynn M Morgan. "Romanticizing the Transgender Narrative: Rethinking the Use of the "Third Gender" Concept." In *The Transgender Studies Reader*, edited by Susan Stryker and Stephen Whittle, 666-684. New York: Routledge, 2006.

Vade, Dylan, and Sondra Solovay. "No Apology: Shared Struggles in Fat and Transgender Law." In *Fat Studies Reader*, edited by Esther Rothblum and Sondra Solovay, 167-175. New York: New York University Press, 2009.

Varian, Fran. "Daddy Gets the Big Piece of Chicken." In *Gender Outlaws: The Next Generation*, edited by Kate Bornstein and S. Bear Bergman. Kobo edition. Berkeley: Seal Press, 2010.

Vesely, Carolin. "For Winnipeg's Transgender Community, Journey to a New Identity is Life-Affirming." *Winnipeg Free Press*, March 11, 2012: 1-12.

- Weisbrot, E. S. "Seeworthy." In *Gender Outlaws: The Next Generation*, edited by Kate Bornstein and S. Bear Bergman. Kobo edition. Berkeley: Seal Press, 2010.
- Wigley, Mark. *The Architecture of Deconstruction: Derrida's Haunt*. Cambridge: The MIT Press, 1993.
- Wigley, Mark. "Untitled: The Housing of Gender." In *Sexuality & Space*, edited by Beatriz Colomina, 327-389. New York: Princeton Architectural Press, 1992.
- Wilchins, Riki. "A Certain Kind of Freedom: Power and the Truth of Bodies - Four Essays on Gender." In *GenderQueer: Voices from Beyond the Sexual Binary*, edited by Joan Nestle, Clare Howell and Riki Wilchins, 21-63. New York: Alyson Books, 2002.
- Wilchins, Riki. "A Continuous Non-Verbal Communication." In *GenderQueer: Voices from Beyond the Sexual Binary*, edited by Joan Nestle, Clare Howell and Riki Wilchins, 11-17. New York: Alyson Books, 2002.
- Wilchins, Riki Ann. "Time for Gender Rights." *GLQ: A Journal of Lesbian and Gay Studies* 10, no. 2 (2003): 265-267.
- Wilchins, Riki. "Gender Rights Are Human Rights." In *GenderQueer: Voices from Beyond the Sexual Binary*, edited by Joan Nestle, Clare Howell and Riki Wilchins, 289-297. New York: Alyson Books, 2002.
- Wittig, Monique. *The Straight Mind and Other Essays*. Boston: Beacon Press Books, 1992.
- Wright, Susan. "Be A Man." In *GenderQueer: Voices from Beyond the Sexual Binary*, edited by Joan Nestle, Clare Howell and Riki Wilchins, 267-272. New York: Alyson Books, 2002.

APPENDICES

- I. Ethics Review
 - i. Interview Questions
 - ii. Statement of Intent & Informed Consent
 - iii. Invitation Posters
- II. CORE Certificate
- III. Building Code Analysis
- IV. Personal Observation
- V. Programming

Appendix I.i. Ethics Review: Interview Questions

1. Do you currently have a membership at a fitness facility?
 - 1a. If yes, what features, atmospheric qualities, or services made you choose that club?
 - 1b. If no, are there features, atmospheric qualities, or services you would look for if you were going to join one?
2. Whether from the following list, or your own personal preferences, which feature(s) would you identify as being most important in your selection of a fitness club?

(eg. private showers, public showers, private change areas, public change areas, co-ed workout areas, gender-identified workout areas, separate group fitness room, integrated group fitness room, sauna, on-site parking)

 - 2a. How would you describe the physical attributes of these amenities?
3. What atmospheric qualities or characteristics would you identify as being most important in your selection of a fitness club?

(eg. light and open, dark and intimate, visibility, concealment, insular spaces, open vistas, increased emphasis on social interaction, increased emphasis on individual privacy, hygienic, comfortable, relaxing, energizing, slow-paced, fast-paced)

 - 3a. How would you describe these qualities?
4. What services would you identify as being most important in your selection of a fitness club?

(eg. personal training, nutrition counselling, body image counselling, pregnancy counselling, family

counselling, massage therapy, child minding, locker rental service, towel rental service, spousal and family membership rate packages, dedicated shop for inclusive fitness apparel and accessories)

5. Which of these three aspects - features, atmospheric qualities, or services - would be most important in your selection of a fitness facility? Which would be least important?
6. How important is privacy in your preferred workout space? Are there specific areas where it is more important to you?
7. How important is social interaction in your preferred workout space? Are there specific areas where it is more important to you?
8. If you could choose, would there be a particular area in Winnipeg that you would prefer your chosen fitness club to be located?
9. Are there any other suggestions that you have, or considerations I should keep in mind, in designing this as an inclusive fitness club?

Appendix I.ii. Statement of Intent & Informed Consent

Informed Consent

1. Summary of Project: Purpose and Methodology

This inquiry is part of a practicum project that constitutes the final degree requirement for the attainment of the University of Manitoba's Master's of Interior Design degree. The project entails the proposal of a hypothetical interior design informed by existing theory and, where necessary, new information gleaned through original research. My project, tentatively titled *Exercising the Right to be Both/And: Redesigning the North American Fitness Club to Accommodate Gender Multiplicity*, aims to design a fitness club that, on a practical level, is accessible to and inclusive of transgender individuals, and on a conceptual level, subverts heteronormative ideology through its design. While much of the project will be based on literature review of existing theories in both gender studies and deconstructivist and poststructuralist philosophy, it will also be necessary to conduct interviews with transgender identified individuals in order to determine what, if any, specific needs or desires that they might have from a fitness facility in order for it to be a truly inclusive and safe space. The information gathered from these interviews will be used to inform the design of a hypothetical fitness centre in Winnipeg Manitoba.

Prospective participants will be invited to participate in a one time, 30 to 60 minute interview conducted one on

one with the primary researcher. These voluntary interviews will be conducted in a safe public space of the participant's choosing (eg. Rainbow Resource Centre), where the conversation will be recorded with hand-written notes and, at the consent of the participant, a digital audio recorder. If the participant does not consent to be recorded digitally, only hand-written notes will be taken. All documentation of the interviews, both written and audio recorded, will be stored in a locked cabinet in the researcher's home office and in a password protected file on the researcher's personal computer. The researcher will be in possession of the only key to said cabinet and will be the only person privy to the password for said file. One year following the completion of the project and satisfaction of the Master's degree requirements (estimated as October 2014), all documentation will be destroyed.

2. Research Instruments

Attached in Appendix A is a list of the specific interview questions to be asked. With the consent of the participant, hand-written notes will be taken by the researcher while the interview is recorded with an audio recording device. If, however, the participant does not consent to be recorded then only hand-written notes will be taken. Participants will be asked to indicate their preference by selecting a "yes" or "no" checkbox on the consent form.

3. Participants, Recruitment and Compensation

Centre, the Winnipeg Transgender Group, University of Manitoba's Rainbow Pride Mosaic Centre, and

University of Winnipeg's LGBT* Centre requesting voluntary and confidential participation in the interview process. These posters will provide prospective participants with the researcher's contact information and invite them to initiate contact at their own discretion. In this way, they will not be required to provide any personal information of their own or compromise their Interviewees will be sought from among the transgender population including transvestites, transsexuals, and any other person who identifies as being or being perceived to be non-normative in gender and wishes to participate in the inquiry. The sample will include approximately 8-15 participants and will be limited to individuals 18 years of age or older. Participants will be contacted via recruitment posters (see Appendix B) posted at the headquarters and on the websites of local support groups such as the Rainbow Resource anonymity should they wish it to be maintained. The Centre will also be provided with a copy of both the Informed Consent form and the interview questions so that prospective participants can be informed in making their decision.

The interview questions and their delivery will be designed to avoid making reference to or reminding participants of any uncomfortable issues or experiences, but where research suggests that the experience of being transgendered in the built environment is often one of marginalization, it make elicit feelings of stress or discomfort. If, at any time during the interview, the participant feels uncomfortable, they may decline to answer the immediate question, decline to answer any further questions, or discontinue the interview and request that all previous answers be omitted from the inquiry. The interview will conducted with the sole aim of exploring the physical design of a trans-friendly fitness facility including physical features, atmospheric characteristics,

and available services. It will not make reference to or solicit information regarding the interviewee's experiences of being and becoming transgender. If, after completing the interview, a participant decides that they would like their answers omitted from the inquiry, they may contact the researcher by email or phone any time before November 30, 2013 to make this choice known.

Participation in the interviews will be strictly voluntary. No compensation will be provided in exchange for participation. Interviews will be conducted at a safe public space (eg. Rainbow Resource Centre), and at a time of the participant's choosing.

4. Informed Consent and Deception

No confidential records of any kind will be consulted. Prospective participants will be invited to initiate contact with the researcher if they wish to be involved in the interviews. Following this statement of intent is a copy of the consent form participants will be required to sign should they choose to participate. This form outlines the nature and purpose of the study and the interview questions. It will also provide the participant with the option whether or not they wish to be audio recorded and whether or not they prefer to be referred to by name or by a preferred pseudonym. It will provide assurance that their confidentiality will be maintained, and that they will be both provided with access to the final document in the manner of their choosing, and invited to attend the requisite presentations to the advisory committee of the information contained in the document. This consent form must be signed by the participant and returned to the researcher prior to the interview

commencing.

There will be no deception involved or information withheld in the course of this research or the project it is meant to supplement. All details are outlined in the consent form and any additional inquiries by participants will be answered to the fullest and best ability of the researcher.

5. Risks and Benefits

While there are no foreseeable risks to participants, it is possible that, though the questions will be designed to determine what features and characteristics contribute to a transgender friendly environment and to avoid sensitive issues, the process of discussing preferences in regards to the built environment may evoke stress in participants by reminding them of experiences with unfriendly environments. All participants will be made aware and reminded throughout the interview that they can refuse to answer any question they do not wish to and that they can discontinue the interview at any time with the option of having their responses excluded from the study. They will also be encouraged to contact Winnipeg's Rainbow Resource Centre at (204) 474-0212 should they wish to seek counselling in regards to this stress. Attached to the consent form is a list of available resources including contact information for the Rainbow Resource Centre as well as other local support services.

With regards to benefits, this interview and the project to which it pertains are intended to benefit the

transgender community by advocating for inclusivity and accessibility, and by addressing the need for safe spaces that contribute to health and well-being.

6. Anonymity and Confidentiality

Participants will be given the option whether or not they wish to be identified directly or by a chosen alias. They will not be required to give any personal information unless they choose to do so and it will be used solely for communication and/or recognition purposes. No background information, historical or medical, and no personal identifiers such as occupation, place of employment, and address will be requested or used to identify them in the dissemination of the findings. Direct quotations and participant responses will be alternatively credited; in place of their name, a pseudonym will be assigned according to their preference and as such personal identity will be kept completely confidential. If, however, participants wish to be recognized by name – in the document and final presentation – they will be invited to provide their preferred name and it will be included with their consent as indicated by a “yes” or “no” checkbox on the consent form.

All notes and recordings will be kept confidential. Whether participants choose to be acknowledged by name or a preferred pseudonym, all responses will be stored in a password protected folder on the personal computer of the researcher and all consent forms will be filed in a locked cabinet in the researcher’s home office, to which only the researcher will have the password and key. The only parties privy to the information will be the researcher and their supervisors. All notes and recordings will be stored as such until one year after the design

project and final document are complete, submitted to the University of Manitoba, Faculty of Graduate Studies, and practicum requirement satisfied. With an estimated completion date of October 2014, data destruction will occur in October 2015 at which time all notes, recordings, and consent forms will be destroyed.

7. Feedback and Dissemination

Feedback will be provided in the form of the final document and, should they choose to attend, the researcher's final presentation to their advisory committee. If a participant wishes to supply an email address they will also be emailed a link to the final document which is to be published on M-Space (Master's thesis database) as part of the degree requirements. All participants will be invited to attend the final practicum presentation, tentatively scheduled for June 2014. A copy of the final document will also be offered as a donation to the Rainbow Resource Centre library where it will be available for loan to any who wish to read it. It is expected to be donated by August of 2014.

The findings of this interview will be used to inform a hypothetical design proposal for a gender inclusive fitness facility. The final document will contain reference to how the interview findings informed and were translated into the final design. While it will contain direct reference to and quotations of specific statements participants have made, they will not be attributed to them by name unless they have indicated so on their consent form. A presentation of the final design and document will be made in June of 2014 (exact date to be determined) to which all participants will be invited. The final date and time of this presentation will be

communicated to interviewees by the method of their choosing, as well as by signage (Appendix D) posted in the Rainbow Resource Centre and the Universities' LGBT organization offices.

A copy of the final document will be submitted to the researcher's advisory committee (including the above-named supervisors), the University of Manitoba's Department of Interior Design, as well as to the University of Manitoba's Faculty of Graduate Studies for completion of the Master's degree. Published copies will be available on M-Space (Master's thesis database) as well as in the University of Manitoba's Architecture/Fine Arts Library reference collection. A copy will also be given as a donation to the Rainbow Resource Centre library where it will be available for anyone who wishes to view it. If a participant wishes to have more direct access to the document, a link to the document on M-Space can be provided via email or telephone, or if they prefer, a full copy of the document can be provided on a CD by regular postal mail.

Informed Consent

Project Working Title: Exercising the Right to be Trans: Redesigning the North American Fitness Club to Reflect Non-Binary Bodies and Identities

Researcher: Corrie Allan
allanc34@cc.umanitoba.ca



Supervisors: Dr. Susan Close (May 2013 – Dec 2013)
susan.close@ad.umanitoba.ca



Prof. Kelley Beaverford (Jan 2014 – Dec 2015)
kelley.beaverford@ad.umanitoba.ca



This consent form, a copy of which will be left with you for your records and reference, is only part of the process of informed consent. It should give you the basic idea of what the research is about and what your participation will involve. If you would like more detail about something mentioned here, or information not included here, you should feel free to ask. Please take the time to read this carefully and to understand any accompanying information.

1. Purpose of Research, Commitment Required, Recording Devices

This interview is being conducted as part of a design project required for the completion of the Master's Interior Design Program at the University of Manitoba. The purpose of the interview is to determine what features and characteristics contribute to a feeling of inclusion and safety in the built environment, particularly the environment of the fitness club. In doing so, this project is intended to benefit the transgender community by advocating for inclusivity and accessibility, and by addressing the need for safe spaces that contribute to health and well-being.

The interview involves a one time commitment of approximately half an hour to an hour to conduct an interview of approximately 10 questions relating to preferences in building design and facility programming. The interview will be conducted one on one with the above named researcher in a safe public space of your choosing. The conversation will, if you consent, be audio recorded while handwritten notes are taken. If, however, you do not consent to be audio recorded, only handwritten notes will be taken. You may indicate your preference by checking one of the checkboxes below.

Participation in the interview is strictly voluntary. If, at any time during the interview, you feel uncomfortable, you may decline to answer the immediate question, decline to answer any further questions, or discontinue the interview and request that all previous answers be omitted from the inquiry. The interview will be conducted with the sole aim of exploring the physical design of a trans-friendly fitness facility including physical features,

atmospheric characteristics, and available services. It will make no reference to any personal or medical history. If, after completing the interview, you decide that you would like your answers omitted from the inquiry, you may contact the researcher by email or phone any time before April 30, 2014 to make your choice known.

2. Confidentiality & Data Storage

If you choose to participate in this interview you will not be required to give any personal information unless you choose to do so and it will be used solely for communication and/or recognition purposes. You will not be asked to provide any background information, historical or medical, and no personal identifiers will be used to identify you in the dissemination of the findings. In place of your name, a pseudonym will be assigned according to your preference, and as such your personal identity will be kept completely confidential. If, however, you wish to be recognized by name – in the document and final presentation – you are welcome to provide your preferred name and it will be included with your consent. You may indicate your preference by checking the appropriate checkbox below.

All notes and recordings will be kept confidential. Whether you choose to be acknowledged by your preferred name or a preferred pseudonym, all your responses will be stored in a password protected folder on the computer of the researcher and all consent forms will be filed in a locked cabinet to which only the researcher will have the password or key. The only parties privy to the information will be the researcher and project supervisors. All notes and recordings will be stored as such until one year after the design project and final

document are complete, submitted to the University of Manitoba, Faculty of Graduate Studies, and practicum requirement complete. With the proposed completion being October 2014, the destruction of data will occur in October 2015 at which time all notes, recordings, and consent forms will be destroyed.

3. Potential Risks & Benefits

There are no foreseeable risks to your safety or comfort as a result of participating in this interview. You will not be asked to discuss any personal history, only to comment on your preferences with respect to the design and functioning of a hypothetical environment. If at any time during the course of the interview, however, you find the questions or conversation to be uncomfortable or stressful in any way, you may decline to answer the question or to discontinue the interview altogether with no repercussion. If at that time you choose to, you can request that your previous comments be omitted from the documentation. Should you wish to seek counselling, the Rainbow Resource Centre's counselling service can be reached at (204) 474-0212. Drop-in counselling is available at the centre on Mondays between 4:00pm – 7:00pm.

This interview and the project that it is a part of are intended to benefit the transgender community by advocating for inclusivity and accessibility, and by addressing the need for safe spaces that contribute to health and well-being.

4. Feedback & Dissemination

The findings of this interview will be used to inform a hypothetical design proposal for a gender inclusive fitness facility. The final document will contain reference to how the interview findings informed and were translated into the final design. While it will contain direct reference to and quotations of specific statements you have made, they will not be attributed to you by name unless you have consented to be named by checking the appropriate box on this form. A presentation of the final design and document will be made in November 2014 (exact date to be determined) at which your presence is more than welcome. The final date and time of this presentation will be communicated to you by the method of your choosing, as well as by signage posted in the University of Manitoba Rainbow Pride Mosaic Office, the University of Winnipeg LGBT* Centre, and the Rainbow Resource Centre.

A copy of the final document will be submitted to the researcher's advisory committee (including the above-named supervisors) as well as to the University of Manitoba's Faculty of Graduate Studies and to M-Space (Master's thesis database) for completion of the Master's degree. A copy will also be given, if desired, as a donation to the Rainbow Resource Centre library where it will be available for anyone who wishes to view it. If you wish to have more direct access to the document, a link to document on M-Space can be provided to you by your choice of email or telephone, or a pdf can be delivered to you on a CD via regular postal mail.

Your signature on this form indicates that you have understood to your satisfaction the information regarding participation in the research project and agree to participate as a subject. By signing you also confirm that you are 18 years of age or older. In no way does this waive your legal rights nor release the researchers, sponsors, or involved institutions from their legal and professional responsibilities. You are free to withdraw from the interview at any time, and/or refrain from answering any questions you prefer to omit, without prejudice or consequences. Your continued participation should be as informed as your initial consent, so you should feel free to ask for clarification or new information throughout your participation.

The University of Manitoba may look at these research records to see that the research is being done in a safe and proper way.

This research has been approved by the Joint Faculty REB. If you have any concerns or complaints about this project you may contact any of the above-named persons or the Human Ethics Coordinator (HEC), Margaret (Maggie) Bowman, at 474-7122. A copy of this consent form has been given to you to keep for your records and reference.

If you have any questions or concerns, do not hesitate to contact me:

Corrie Allan
allanc34@cc.umanitoba.ca

Please check one of the boxes for each of the following statements:

I consent to have an audio recording device record the content of the interview:

YES NO

I consent to have my name used in the documentation (including the presentation and document):

YES NO

Participant's Name: _____

Preferred Pseudonym (if desired): _____

Participant's Signature: _____ Date: _____

Researcher's Signature: _____ Date: _____

Appendix I.iii. Interview Invitation

INSIGHTS WANTED!

**Interior Design student seeks multiple perspectives in the design
of a queer, gender diverse fitness facility.**

Hi, my name is Corrie! As an Interior Design student at the University of Manitoba, I am interested in your input in the design of a queer fitness club. Your preferences around the spatial, aesthetic, and programmatic design of the space would be immensely valuable and greatly appreciated as I endeavour to design a safe and inclusive space for health and wellness.

If you are 18 years of age or older and interested in participating in a short 30 - 60 minute interview, or if you would like more information, contact Corrie at allanc34@cc.umanitoba.ca.

Thank you!

Corrie Allan
University of Manitoba, Master of Interior Design program

Figure 71. Interview Invitation Poster

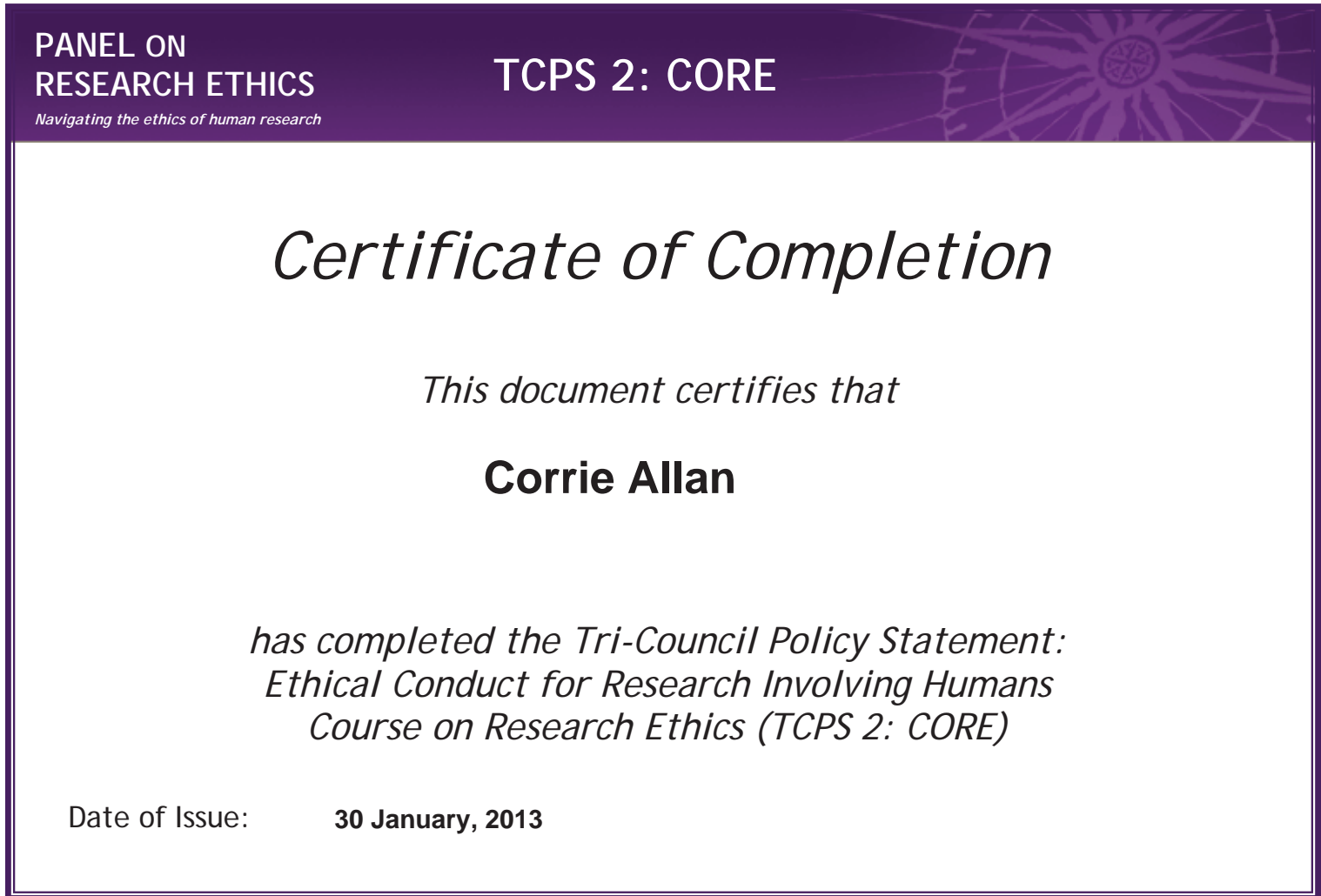

Figure 72. Course on Research Ethics Certificate of Completion

Appendix III. Building Code Review

Life Safety

3.1.2 Major Occupancy Class

A2 – Assembly occupancies other than those listed in other categories.

D – Business & Personal Services

E – Mercantile

3.1.17 Occupant Load

Assembly with non-fixed seats

Reception Lounge 1281.2 ft² @ 8.07 ft² /person = 158 maximum

Group Fitness (both side combined) 1818.3 ft² @ 8.07 ft² /person = 225 maximum

Assembly with fixed seats

Track (fixed lanes) = 24 maximum

Workout West = 22 maximum

Workout East = 26 maximum

Assembly with non-fixed seats & tables

Staff Room 699.5 ft² @ 10.22 ft² /person = 68 maximum

Assembly with standing room

Gallery Corridor 1116.9 ft² @ 4.3 ft² = 259 maximum

Locker room 1033.8 ft² @ 4.3 ft² = 240 maximum

Pool/Billiard Rooms

Billiard Lounge 810.4 ft² @ 100.10 ft² /person = 8 maximum

Dining/Cafeteria

Café 1497.0 ft² @ 12.92 ft² /person = 115 maximum

Personal Services

Massage Therapy 159 ft² @ 49.5 ft² /person = 2 maximum

Mercantile

Pro Shop 1247.9 ft² @ 39.83 ft² /person = 31 maximum

Offices

Main Floor Admin 745.6 ft² @ 100.10 ft² /person = 7 maximum

Photocopy & Filing 902.6 ft² @ 100.10 ft² /person = 9 maximum

Massage Therapy Office 123.9 ft² @ 100.10 ft² /person = 1 maximum

Kitchen

Café 204.1 ft² @ 100.10 ft² /person = 2 maximum

Total Maximum Occupancy = 1297

3.2.8.4 Sprinklers

- 1) a building containing an interconnected floor space shall be sprinklered throughout.

3.2.8.5 Vestibules

- 1) an exit opening into an interconnected floor space shall be protected at each opening into the interconnected floor space by a vestibule.

3.2.8.7 Draft Stops

- 1) A draft stop shall be provided at each floor level within an interconnected floor space, immediately adjacent to and surrounding the opening and shall be not less than 19.75” deep measured from ceiling level down to the underside of the draft stop

3.3.1.11 Door Swing

- 2) swing in direction of travel to exit

3.3.1.18. Guards

- 1) A guard not less than 3’ 6” high shall be provided
 - a) around any roof to which access is provided to purposes other than maintenance
 - c) at each raised floor, mezzanine, balcony, gallery, interior or exterior vehicular ramp, and at other locations where the difference in level is more than 2’ 0”
- 2) there shall be no opening that permits the passage of a sphere whose diameter is more than 4” through a guard serving
 - a) an exterior balcony
 - b) a room, stairway, or space not within a suite of residential occupancy
- 3) no member, attachment or opening located between 0’ 6” and 3’ 0” above the level protected by the guard facilitates climbing

3.4.2.1 Minimum Number of Exits

- 1) Every floor area intended for occupancy shall be served by at least 2 exits

3.4.2.2 Means of Egress from Mezzanines – Table 3.4.2.2.

Distance Limit for Assembly = 49 ft

3.4.2.3. Distance between Exits

- 1) the least distance between 2 exits from a floor area shall be
 - a) one half the maximum diagonal dimension of the floor area but need not be more than 29' 6" for a floor area having a public corridor or
 - b) one half the maximum diagonal dimension of the floor area but not less than 29' 6" for all other floor areas

3.4.2.4 Travel Distance

The distance from any point in the floor area to an exit measured along the path of travel to the exit shall not be more than 164' 0" from any point in an assembly occupancy.

3.4.2.5 Location of Exits

- 1) if more than one exit is required from a floor area, the exits shall be located so that the travel distance to at least one exit shall be not more than
 - b) 131' 0" in a business and personal services occupancy

c) 147' 6" in a floor area that contains an occupancy other than a high-hazard industrial occupancy, provided it is sprinklered throughout

3.4.6.6 Guards

- 2) the height of guards for exit stairs shall be not less than 3' 3" and 3' 6" around landings
- 3) the height of guards for exit ramps and their landings shall be not less than 3' 3" measured vertically to the top of the guard from the ramp surface
- 7) guards shall be designed so that no member, attachment or opening located between 5 ½" and 3' 0" above the level being protected by the guard facilitates climbing

Plumbing

3.7.2.2 Water Closets

Total Occupancy = 1297

Total water closets required = 21*

* Based on maximum female requirement as space acknowledges that individuals may be one or both male and female. This may require a building code variance given that water closets in the building are multi-sex rather than segregated.

Barrier Free

3.8.1.2 Entrances

- 1) at least 50% of the pedestrian entrances of a building shall be barrier-free

3.8.1.3 Barrier Free path of Travel

- 1) The unobstructed width of a barrier free path of travel shall be not less than 3' 3"

3.8.3.3 Doorways and Doors

- 11) A vestibule located in a barrier free path of travel shall be arranged to allow the movement of the wheelchairs between doors and shall provide a distance between 2 doors in series of not less than 3' 9" plus the width of any door that swings into the space in the path of travel from one door to another

3.8.3.4 Ramps

- 1) A ramp located in a barrier free path of travel shall
 - a) have a clear width of not less than 2' 10.25"
 - b) have a slope of not more than 1 in 12
 - c) have a level area not less than 5' by 5' at the top and bottom
 - d) have a level area not less than 3' 11.25" long and at least the same width as the ramp
 - i) at intervals not more than 30' along its length, and
 - ii) where there is an abrupt change in the direction of the ramp, and
 - iii) be equipped with handrails and guards

3.8.3.8. Water closet stalls

- 1) At least one water closet stall or enclosure in a washroom shall be barrier free and shall
 - a) be not less than 5' wide by 5' deep
 - d) be equipped with grab bars

3.8.3.10. Urinals

- 1) if urinals are provided in a barrier-free washroom
 - c) a vertically mounted grab bar not less than 1' 0" long shall be installed on each side, with its centreline 3' 3" above the floor, and located not more than 1' 3" from the centreline of the urinal

3.8.3.13. Showers

- 1) where showers are provided in a building, at least one shower stall in each group of showers shall be barrier-free and shall
 - a) be not less than 5' 0" wide by 3' 0" deep
 - b) have a clear floor space at the entrance to the shower, not less than 3' 0" deep and the same width as the shower
 - e) have a hinged seat that is not spring loaded or a fixed seat
 - f) have a horizontal grab bar

3.8.3.14. Counters

- 1) Every counter more than 6' 6" long, at which the public is served, shall have at least one barrier free section not less than 2' 6" long, not less than 2' 3" and not more than 2' 9" high, and not less than 1' 6" deep

3.8.3.16 Drinking Fountains

- 1) If drinking fountains are provided, at least one shall be barrier-free

Appendix IV. Personal Observations

Table 1. Fitness Club Observations

	Assiniboine Athletic Club 83 Garry St. Winnipeg	Goodlife Fitness various locations in Winnipeg and across Canada	Reh-Fit Centre 1390 Taylor Ave. Winnipeg	Shapes various locations in Winnipeg	Snap Fitness various locations in Winnipeg	University of Manitoba Frank Kennedy Centre 400 University Crescent, Winnipeg	University of Winnipeg Bill Wedlake Fitness Centre 400 Spence St. Winnipeg
SERVICES	<ul style="list-style-type: none"> • personal training • physio & massage therapy 	<ul style="list-style-type: none"> • personal training • massage therapy • group exercise classes • child-minding • tanning • women's only sections in some clubs, full women's only clubs available • towel rental 	<ul style="list-style-type: none"> • personal training • physio & massage therapy • group exercise classes • hot yoga • on-site medical staff • nutritional workshops • emergency call button 	<ul style="list-style-type: none"> • personal training • nutritional counseling • group exercise classes • hot yoga • women's only section 	<ul style="list-style-type: none"> • group training classes • 24 hour access 	<ul style="list-style-type: none"> • personal training • fitness testing • nutritional counseling • group exercise classes • towel rental • locker service 	<ul style="list-style-type: none"> • personal training • fitness testing • group exercise classes • athletic & massage therapy • towel service • locker service
FACILITIES	<ul style="list-style-type: none"> • cardio equipment • weight machines • free weights • swimming pool • hot tub • segregated male and female locker rooms 	<ul style="list-style-type: none"> • cardio equipment • weight machines • free weights • sauna • segregated male and female locker rooms 	<ul style="list-style-type: none"> • cardio equipment • weight machines • free weights • sauna • segregated male and female locker rooms • multi-purpose court (volleyball, badminton) • hot yoga studio • interior & exterior lounge areas • track 	<ul style="list-style-type: none"> • cardio equipment • weight machines • free weights • hot tub • sauna • segregated male and female locker rooms • hot yoga studio • rock climbing wall 	<ul style="list-style-type: none"> • cardio equipment • weight machines • free weights • segregated male and female locker rooms 	<ul style="list-style-type: none"> • cardio equipment • weight machines • free weights • swimming pool • sauna • segregated male and female locker rooms • non-segregated community changeroom available with private change and shower cubicles • track • multi-purpose gymnasium spaces (badminton, basketball, volleyball, tennis, indoor soccer, lacrosse, cricket) • racquetball & squash courts 	<ul style="list-style-type: none"> • cardio equipment • weight machines • free weights • track • segregated male and female locker rooms • saunas • multi-purpose gymnasium spaces (badminton, basketball, volleyball) • racquetball & squash courts

Table 1. Fitness Club Observations continued

	Assiniboine Athletic Club 83 Garry St. Winnipeg	Goodlife Fitness various locations in Winnipeg and across Canada	Reh-Fit Centre 1390 Taylor Ave. Winnipeg	Shapes various locations in Winnipeg	Snap Fitness various locations in Winnipeg	University of Manitoba Frank Kennedy Centre 400 University Crescent, Winnipeg	University of Winnipeg Bill Wedlake Fitness Centre 400 Spence St. Winnipeg
ATMOSPHERIC CHARACTERISTICS	<ul style="list-style-type: none"> • institutional lighting, even illumination • floor to ceiling mirrors on most walls • large windows with view of outdoors • open concept workout area • segregated cardio and weight training equipment 	<ul style="list-style-type: none"> • institutional lighting, even illumination • floor to ceiling mirrors distributed at intervals throughout • large windows with view of outdoors • open concept workout area • segregated cardio and weight training equipment 	<ul style="list-style-type: none"> • institutional lighting, even illumination • limited use of mirrors, distributed throughout • small expanse of windows on West end of workout area • open concept workout area • segregated cardio and weight training equipment 	<ul style="list-style-type: none"> • institutional lighting, even illumination • uninterrupted floor to ceiling mirrors on most walls • vast expanse of mirrors on north and south side of building and between areas, main group fitness studio has windows (north) to parking lot and sidewalk, as well as (west) onto main entry • segregated cardio and weight training equipment 	<ul style="list-style-type: none"> • institutional lighting, even illumination • uninterrupted floor to ceiling mirrors on most walls • vast expanse of mirrors on north and south side of building • segregated cardio and weight training equipment 	<ul style="list-style-type: none"> • institutional lighting, uneven illumination • uninterrupted floor to ceiling mirrors on free weight area walls • no windows • segregated cardio and weight training equipment 	<ul style="list-style-type: none"> • institutional lighting • lots of natural daylight, large expanse of windows on East side • cardio and weight training areas separated by floor levels • open concept weight area on main level, narrow L-shaped cardio & stretching area on second level
PRIVACY	<ul style="list-style-type: none"> • private shower cubicles within locker rooms • no private change areas 	<ul style="list-style-type: none"> • private shower stalls within locker rooms • private change cubicles within change rooms 	<ul style="list-style-type: none"> • private shower stalls within locker rooms • private change cubicles within change rooms 	<ul style="list-style-type: none"> • private showers within locker rooms • labyrinthine layout provides areas of partial concealment for semi-private changing 	<ul style="list-style-type: none"> • private showers within locker rooms 	<ul style="list-style-type: none"> • private showers within segregated and de-segregated locker rooms • private change cubicles in community change room, some with private shower • fixed, semi-sheer draperies in stretching area 	<ul style="list-style-type: none"> • layout of lockers provides areas of partial concealment for semi-private changing

Appendix V. Programming

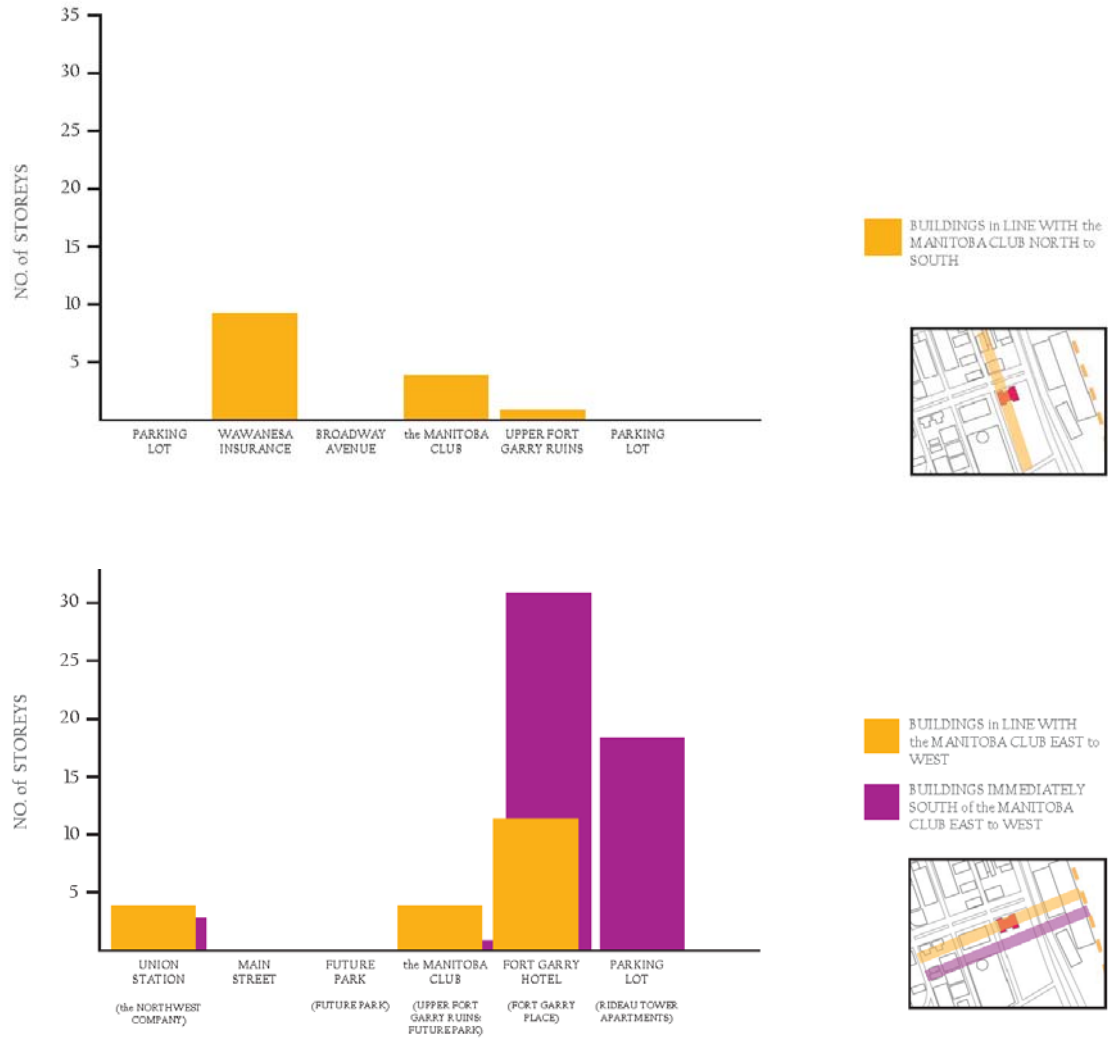

Figure 73. Adjacent Building Heights



Figure 74. Map of Land Use

Primary Users:

Club Members

Staff – gym (Personal Trainers, Group Fitness Instructors, Front Desk Staff, café staff, child-minding staff, pro shop clerks, counsellors, Administrative staff)

Maintenance/Custodial Staff

Gallery visitors

Massage Therapy Clients

Secondary Users:

Special Event Attendees

Tertiary Users:

Guest Presenters/Speakers/Performers/Workshop Facilitators

Mail/Courier Delivery

Equipment Repair Personnel

Table 1. Programming Table

FUNCTIONAL AREAS	MAXIMUM No. of USERS	FUNCTIONAL REQUIREMENTS	AESTHETIC/ATMOSPHERIC REQUIREMENTS	SPATIAL REQUIREMENTS (sq. ft.)	PROPOSED LOCATION
Reception	2-3	<ul style="list-style-type: none"> • desk space • data/telephone capability • laundry attached or adjacent • gated entry to rest of gym • secure file storage • universally accessible 	Organized Welcoming	1 x 200	<ul style="list-style-type: none"> • main floor, • front of building • adjacent to laundry
Locker Rooms	100	<ul style="list-style-type: none"> • lockers • showers • sauna • bathroom • electrical outlets • benches • mirrors • shelves • private change areas that don't first require entering gender specific space • ventilation • universally accessible 	Not binary gendered	1 x 1500	<ul style="list-style-type: none"> • second floor • front of building • washrooms adjacent or attached
Individual Workout	100	<ul style="list-style-type: none"> • cardio equipment • free weights • weight machines • stretching area • ventilation • drinking fountains • durable, resilient flooring • universally accessible 	Unintimidating Gender Neutral	1 x 5000	<ul style="list-style-type: none"> • main floor
Group Workout	75	<ul style="list-style-type: none"> • audio/video equipment • equipment storage • open area • drinking fountains • universally accessible 	Energizing/Invigorating Unintimidating Gender Neutral	1 x 2000	<ul style="list-style-type: none"> • second floor
Child Minding	10	<ul style="list-style-type: none"> • toy storage • child-sized furniture • resilient flooring 	Lively	1 x 500	<ul style="list-style-type: none"> • main floor • adjacent to entrance
Pro Shop	10	<ul style="list-style-type: none"> • display cases and racks • gender neutral changing rooms • mirrors • cash wrap and counter 	Welcoming	1 x 500	<ul style="list-style-type: none"> • main floor

Table 1. Programming Table continued

FUNCTIONAL AREAS	MAXIMUM No. of USERS	FUNCTIONAL REQUIREMENTS	AESTHETIC/ATMOSPHERIC REQUIREMENTS	SPATIAL REQUIREMENTS (sq. ft.)	PROPOSED LOCATION
Cafe	50	<ul style="list-style-type: none"> • seating • cash wrap and counter • dishwasher • refrigeration • food and drink preparation • universally accessible 	Lively Comfortable	1 x 1000	<ul style="list-style-type: none"> • second floor
Therapy and Counselling	3	<ul style="list-style-type: none"> • comfortable seating • acoustic and visual privacy • secure file storage • universally accessible 	Calm Safe	2 x 100	<ul style="list-style-type: none"> • third floor
Administrative Offices	2	<ul style="list-style-type: none"> • telephone and data connectivity • secure file storage • universally accessible 	Minimal Organized	3 x 75	<ul style="list-style-type: none"> • third floor
Multi-purpose Space	100	<ul style="list-style-type: none"> • A/V capabilities • manipulable furniture • universally accessible 	Inviting	1 x 1500	<ul style="list-style-type: none"> • third floor
Custodial	2	<ul style="list-style-type: none"> • ventilation • utility sink • storage • secure 		4 x 25	<ul style="list-style-type: none"> • each floor
Washrooms		<ul style="list-style-type: none"> • universally accessible • gender neutral 	Clean	4 x 200	<ul style="list-style-type: none"> • each floor
Circulation	150	<ul style="list-style-type: none"> • universally accessible 		1 x 2000	
TOTAL AREA				15 525	

ADJACENCY MATRIX

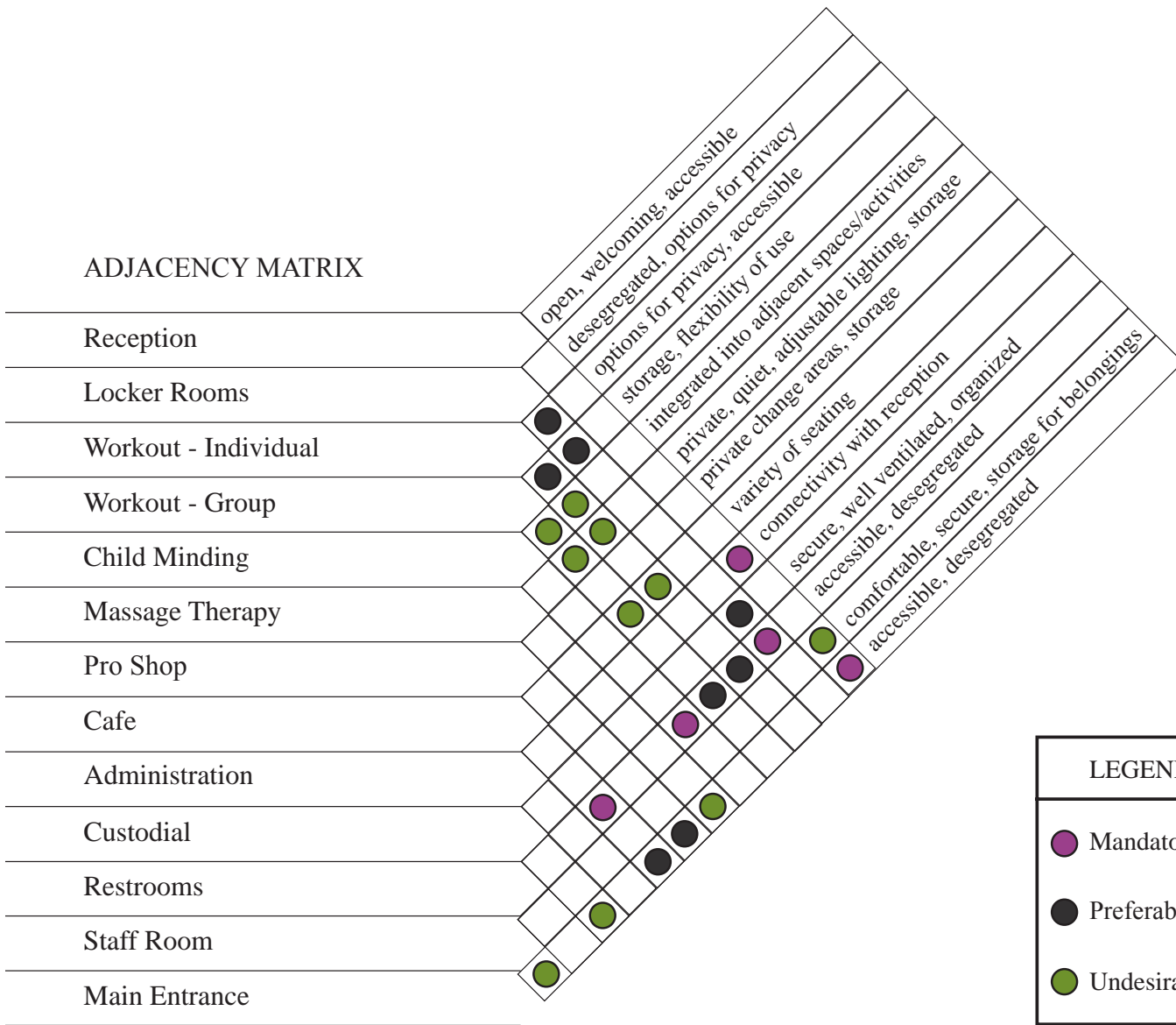

LEGEND	
●	Mandatory Adjacency
●	Preferable but not Mandatory
●	Undesirable Adjacency

Above: Figure 75. Spatial Adjacency Matrix | Opposite: Figure 76. Zoning. Original plans by John D. Atchison & Company Architects, 1913. Used with permission of the Manitoba Archives.

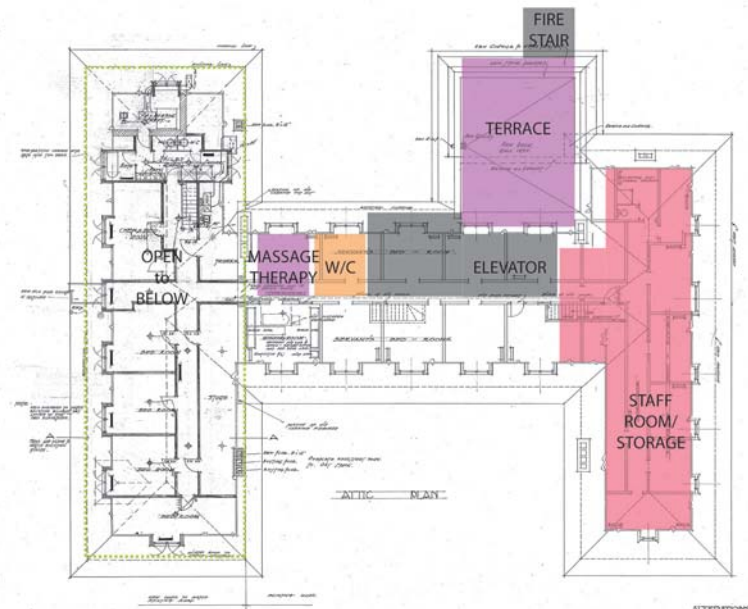
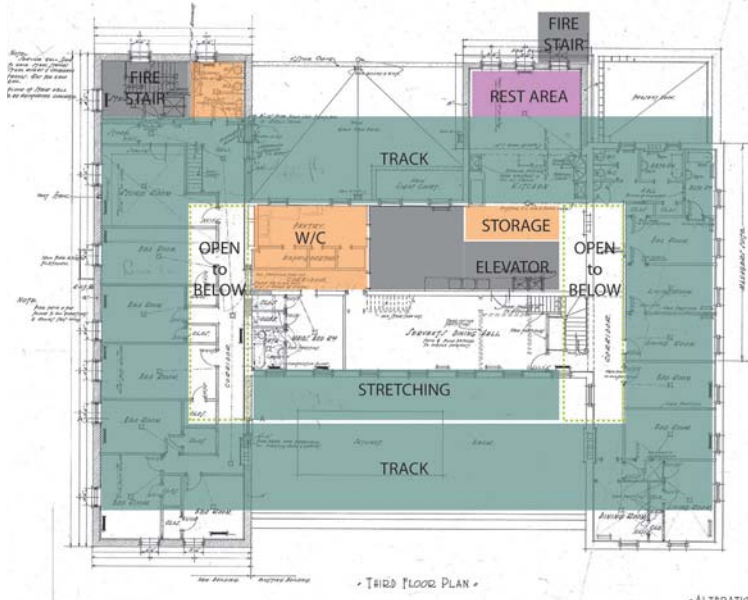
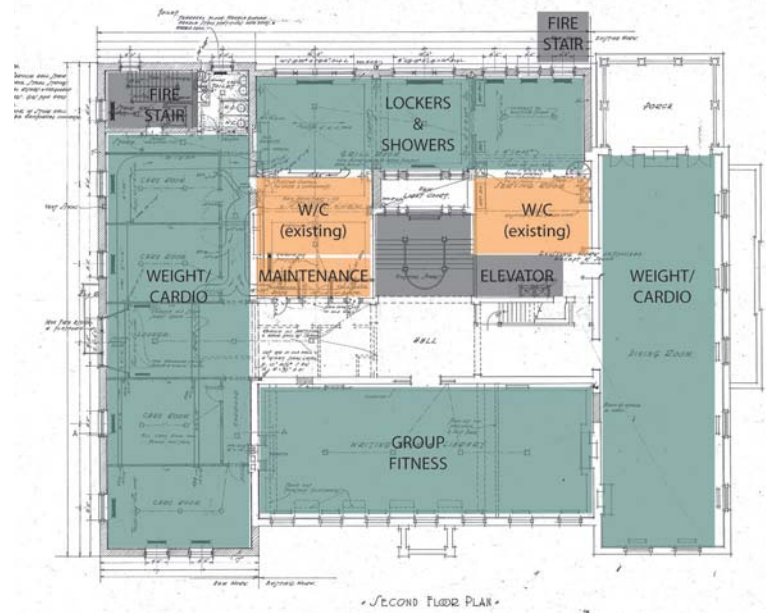

ALTERATIONS © AODITY

ALTERATIONS 3