

**ACCELERATED LABORATORY EVALUATION OF
JOINT SEALANTS UNDER CYCLIC LOADS**

by

Tanya Worms, B.Sc., EIT

A Thesis

Submitted to the Faculty of Graduate Studies in Partial Fulfillment of the Requirements
for the Degree of

Master of Science

Department of Civil Engineering
University of Manitoba
Winnipeg, Manitoba

© 2005 by Tanya Worms

THE UNIVERSITY OF MANITOBA
FACULTY OF GRADUATE STUDIES

COPYRIGHT PERMISSION

**ACCELERATED LABORATORY EVALUATION OF
JOINT SEALANTS UNDER CYCLIC LOADS**

BY

TANYA WORMS

**A Thesis/Practicum submitted to the Faculty of Graduate Studies of The University of
Manitoba in partial fulfillment of the requirement of the degree
MASTER of SCIENCE**

TANYA WORMS © 2004

Permission has been granted to the Library of the University of Manitoba to lend or sell copies of this thesis/practicum, to the National Library of Canada to microfilm this thesis and to lend or sell copies of the film, and to University Microfilms Inc. to publish an abstract of this thesis/practicum.

This reproduction or copy of this thesis has been made available by authority of the copyright owner solely for the purpose of private study and research, and may only be reproduced and copied as permitted by copyright laws or with express written authorization from the copyright owner.

ABSTRACT

There is a need to establish performance-based laboratory procedures for testing of joint and crack sealants. This research proposes a cyclic loading laboratory test procedure to be performed at in-service temperatures, which applies to hot-pour sealants. Two types of hot-pour sealants were evaluated in this research to predict resistance to tensile and compressive extension. The test results at three temperatures +30°C, 0°C and -30°C presented in this research highlight distinct differences in the behavior of low and standard modulus sealant types and confirm the superior performance of the low modulus sealants.

Low modulus sealants are typically able to withstand larger extension. The accelerated testing compared sealants subjected to displacements similar to traffic and temperature loadings in the field. In general, and based on the limited number of sealant products tested, Type I sealants performed poorly when compared to Type IV sealants. Both Type I sealants and two Type IV sealants failed prematurely at the 0°C and -30°C temperatures. The optimized selection of joint sealant products can extend pavement service life and reduce annual maintenance and rehabilitation needs particularly in regions which experience extreme climatic conditions.

Three criteria were used to rank the sealants: percent load drop versus temperature, normal stress analysis and maximum surface stress analysis. Each method allowed the sealants to be grouped into three categories, sealants that performed well, sealants with average performance and sealants with poor performance. From the three criteria, rankings were applied to the sealants as follows: Sealants D and E had good performance, sealants F, G and H performed satisfactory and sealants A, B and C performed poorly. More emphasis was placed on the low temperature results from each criterion which gives better performance rankings to sealants D and E as opposed to sealants F, G and H.

The use of the field data would greatly enhance this research and would allow for models to be built allowing the prediction of the performance of hot-pour joint and crack sealants in the field.

ACKNOWLEDGEMENTS

I would like to thank the many people who made this research possible. My advisor, Dr. Ahmed Shalaby, whose guidance and assistance throughout this research have been invaluable. I would like to also acknowledge the technical support I received from Manitoba Transportation and Government Services in particular Ms. Tara Liske and Ms. Leonnie Kavanagh. In addition I would also like to thank Mr. Scott Sparrow and Mr. Morey McVey, who provided the technical support for the laboratory testing part of this research.

I wish to acknowledge the sponsorship of this research by the Manitoba Department of Transportation and Government Services and the Thomas J. Pounder Memorial Scholarship at the University of Manitoba.

I also gratefully acknowledge the support from my family and friends, for their encouragement and understanding throughout the years. In particular my parents, George and Carol Worms have been my greatest fans and without their love and support I would not have been able to accomplish my undergraduate and graduate degrees.

TABLE OF CONTENTS

List of Tables	vii
List of Figures	viii
1 Introduction	1
1.1 General Overview	1
1.2 Research Objectives	3
1.3 Scope	4
1.4 Organization of Thesis	4
2 Literature Review	6
2.1 Introduction	6
2.2 Types of Sealants	6
2.3 ASTM Test Methods	8
2.3.1 Hot-applied Joint and Crack Sealant Requirements	8
2.3.2 Cold-applied Silicone Joint Sealant Requirements	10
2.3.3 Preformed Polychloroprene Elastomeric Joint Seals for Concrete Pavements	11
2.4 Sealant Failures and Related Pavement Distresses	12
2.4.1 Definitions of Sealant Failures	12
2.4.2 Related Pavement Distresses	13
2.5 Field Trials	14
2.5.1 North Dakota Crack Sealant Study	14
2.5.2 SHRP H-106 Project	14
2.5.3 LTPP Supplemental Joint Seal Experiment	16
2.5.4 Ohio Joint Sealant Experiment	17
2.5.5 Ottawa Crack Sealing Field Evaluation	18
2.5.6 Montreal Crack Sealing Cold Conditions Performance	19
2.5.7 Montana Crack Sealing Experiment	19
2.6 Laboratory Trials	21

2.6.1	Virginia Tech Joint Sealant Testing.....	21
2.6.2	University of New Brunswick Joint Sealant Testing.....	22
2.6.3	Carleton University Joint Sealant Testing	24
2.6.4	Transportation Association of Canada Crack Sealant Testing	24
2.6.5	National Research Council Sealant Testing.....	25
2.7.	Sealant Aging.....	27
2.8.	Joint Opening.....	29
2.9.	Supplemental Sealant Information and Guidelines	31
2.9.1	The Use and Effects of the Hot-Air Lance	31
2.9.2	Literature Review of Wisconsin Sealing Policies.....	32
2.9.3	Sealant Viscosity Study	33
2.9.4	National Guide to Sustainable Municipal Infrastructure	33
3	Experimental Program.....	35
3.1	Introduction.....	35
3.2	Program Outline.....	35
3.3	Test setup and Sample Preparation.....	44
3.3.1	Specimen Preparation	45
3.3.2	Cyclic Test Setup	49
3.3.3	Test Procedure	49
3.4	Testing Procedures.....	51
3.4.1	+30°C Testing	51
3.4.2	0°C Testing	52
3.4.3	-30°C Testing.....	52
4	Laboratory Test Results.....	53
4.1	Fatigue Test.....	53
4.2	Summary of Results.....	53
4.3	Individual Sealant Results	61
4.3.1	Sealant A Results	61
4.3.2	Sealant B Results	63

4.3.3	Sealant C Results	66
4.3.4	Sealant D Results	69
4.3.5	Sealant E Results.....	71
4.3.6	Sealant F Results.....	73
4.3.7	Sealant G Results	75
4.3.8	Sealant H Results	77
4.4	Comments on the Experimental Testing of Sealants	79
5	Sealant Performance and Selection Criteria	82
5.1	Percent Load Drop versus Temperature	82
5.2	Normal Stress Performance Criteria	85
5.2.1	+30°C Normal Stress Strain Results	87
5.2.2	0°C Normal Stress Strain Results	92
5.2.3	-30°C Normal Stress Strain Results.....	97
5.3	Surface Stress Analysis.....	103
5.3.1	Surface Strain Theoretical Model	103
5.3.2	Surface Strain Calculations.....	106
5.3.3	Maximum Stress Analysis	109
5.4	Summary of Results.....	109
6	Conclusions and Recommendations for Future Work.....	111
6.1	Summary.....	111
6.2	Conclusions.....	112
6.3	Recommendations for Future Work	114
	References.....	116

LIST OF TABLES

TABLE 2.1: Physical Requirements for Hot-Poured Joint and Crack Sealants	9
TABLE 2.2: Physical Requirements for Cold-applied Silicone Joint Sealants	10
TABLE 2.3: Physical Requirements for Preformed Elastomeric Joint Seals	11
TABLE 2.4: Sealant acceptance based on ASTM D3405 and field tests (Masson, 1998)12	
TABLE 2.5: Crack Sealant failures, their causes, and possible intrinsic origin	13
TABLE 3.1: Field Trial Data	37
TABLE 3.2: Pavement History of Crack Sealing Sections	37
TABLE 3.3: Material Ingredients and Percentages for Each Sealant.....	41
TABLE 3.4 Material Properties for Type I Sealants as per manufacturer’s datasheets	42
TABLE 3.5 Material Properties for Type IV Sealants as per manufacturer’s datasheets .	42
TABLE 4.1: Stresses and Percent Stress Drop at +30°C.....	55
TABLE 4.2: Stresses and Percent Stress Drop at 0°C.....	56
TABLE 4.3: Stresses and Percent Stress Drop at -30°C.....	57
TABLE 4.4: Average Stress Values for each Sealant.....	58
TABLE 5.1: Maximum and Minimum Normal Strain Values as a Percentage.....	86
TABLE 5.2: Ranking of Sealants based on Normal Stress Strain Results	102
TABLE 5.3: Maximum Surface Strains in both Tension and Compression.....	106
TABLE 5.4: Maximum Tensile Stresses at each test temperature	109
TABLE 5.5: Ranking of Sealants from all temperatures based on all performance criteria	110

LIST OF FIGURES

FIGURE 3.1: 2004 Crack Sealant MTGS Field Trial Site	38
FIGURE 3.2: Routing of Crack to a 3:1 configuration.....	43
FIGURE 3.3: Cleaning of the crack using an air blower.....	43
FIGURE 3.4: Heating of the crack using a hot-air lance.....	43
FIGURE 3.5: Sealant application using a wand and squeegee.....	43
FIGURE 3.6: Final sealed crack	43
FIGURE 3.7: Final Sealed crack across the entire road surface.....	43
FIGURE 3.8: Testing Procedure.....	45
FIGURE 3.9 Concrete block, sealant specimen and bearing plates.	46
FIGURE 3.10: Formwork for concrete blocks	47
FIGURE 3.11: Concrete blocks after pouring	47
FIGURE 3.12: Concrete block prior to sawing, 100mm(w) x 75 mm (h) x 50 mm (d)....	47
FIGURE 3.13: Sawn concrete block, 50mm(w) x 75 mm(h) x 50 mm(d).....	47
FIGURE 3.14: Spacers and clamp in place ready for sealant.....	47
FIGURE 3.15: Finished product, sealant trimmed and ready for testing	47
FIGURE 3.16 Specimen mounted in loading frame.....	48
FIGURE 3.17: Load form generator and data acquisition system.....	49
FIGURE 3.18: Typical load and stroke versus number of cycles conducted at +30°C and 1Hz frequency.....	51
FIGURE 4.1: Average Initial Stress Values at +30°C.....	59
FIGURE 4.2: Average Initial Stress Values at 0°C.....	60
FIGURE 4.3: Average Initial Stress Values at -30°C.....	60
FIGURE 4.4 Sealant A Stress vs. Number of Cycles (+30°C).....	62
FIGURE 4.5 Sealant A Stress vs. Number of Cycles (0°C)	62
FIGURE 4.6: Sealant A Stress vs. Number of Cycles (-30°C).....	63
FIGURE 4.7: Adhesion failure for Sealant A.....	63
FIGURE 4.8 Sealant B Stress vs. Number of Cycles (+30°C).....	65
FIGURE 4.9: Sealant B Stress vs. Number of Cycles (0°C)	65

FIGURE 4.10 Sealant B Stress vs. Number of Cycles (-30°C).....	66
FIGURE 4.11 Sealant C Stress vs. Number of Cycles (+30°C).....	67
FIGURE 4.12 Sealant C Stress vs. Number of Cycles (0°C)	68
FIGURE 4.13 Sealant C Stress vs. Number of Cycles (-30°C).....	68
FIGURE 4.14 Sealant D Stress vs. Number of Cycles (+30°C).....	69
FIGURE 4.15: Sealant D Stress vs. Number of Cycles (0°C).....	70
FIGURE 4.16: Sealant D Stress vs. Number of Cycles (-30°C).....	70
FIGURE 4.17 Sealant E Stress vs. Number of Cycles (+30°C)	71
FIGURE 4.18 Sealant E Stress vs. Number of Cycles (0°C)	72
FIGURE 4.19 Sealant E Stress vs. Number of Cycles (-30°C)	72
FIGURE 4.20 Sealant F Stress vs. Number of Cycles (+30°C)	73
FIGURE 4.21: Sealant F Stress vs. Number of Cycles (0°C).....	74
FIGURE 4.22: Sealant F Stress vs. Number of Cycles (-30°C)	74
FIGURE 4.23 Sealant G Stress vs. Number of Cycles (+30°C).....	75
FIGURE 4.24: Sealant G Stress vs. Number of Cycles (0°C).....	76
FIGURE 4.25 Sealant G Stress vs. Number of Cycles (-30°C).....	76
FIGURE 4.26 Sealant H Stress vs. Number of Cycles (+30°C).....	77
FIGURE 4.27 Sealant H Stress vs. Number of Cycles (0°C)	78
FIGURE 4.28 Sealant E Stress vs. Number of Cycles (-30°C)	78
FIGURE 4.29: Torsion failure of concrete blocks while tightening into the testing machine.....	80
FIGURE 4.30A: Concrete Shattering	80
FIGURE 4.30B: Close up of failure within the sealant	80
FIGURE 5.1: Sealants that performed well – Average Percent Load Drop vs. Temperature	84
FIGURE 5.2: Sealants that performed satisfactory - Average Percent Load Drop vs. Temperature	84
FIGURE 5.3: Sealants that performed poorly - Average Percent Load Drop vs. Temperature	85

FIGURE 5.4: Maximum Normal Strain Configuration	86
FIGURE 5.5: Sealant A Hysteresis Loops (+30°C)	88
FIGURE 5.6: Sealant B Hysteresis Loops (+30°C).....	88
FIGURE 5.7: Sealant C Hysteresis Loops (+30°C).....	89
FIGURE 5.8: Sealant D Hysteresis Loops (+30°C)	89
FIGURE 5.9: Sealant E Hysteresis Loops (+30°C).....	90
FIGURE 5.10: Sealant F Hysteresis Loops for (+30°C)	90
FIGURE 5.11: Sealant G Hysteresis Loops for (+30°C).....	91
FIGURE 5.12: Sealant H Hysteresis Loops for (+30°C).....	91
FIGURE 5.13: Sealant A Hysteresis Loops (0°C).....	93
FIGURE 5.14: Sealant B Hysteresis Loops (0°C).....	93
FIGURE 5.15: Sealant C Hysteresis Loops (0°C).....	94
FIGURE 5.16: Sealant D Hysteresis Loops (0°C).....	94
FIGURE 5.17: Sealant E Hysteresis Loops (0°C)	95
FIGURE 5.18 Sealant F Hysteresis Loops for (0°C).....	95
FIGURE 5.19: Sealant G Hysteresis Loops for (0°C).....	96
FIGURE 5.20: Sealant H Hysteresis Loops for (0°C).....	96
FIGURE 5.21: Sealant A Hysteresis Loops (-30°C)	98
FIGURE 5.22: Sealant B Hysteresis Loops for (-30°C).....	99
FIGURE 5.23: Sealant C Hysteresis Loops for (-30°C).....	99
FIGURE 5.24: Sealant D Hysteresis Loops for (-30°C).....	100
FIGURE 5.25: Sealant E Hysteresis Loops for (-30°C).....	100
FIGURE 5.26: Sealant F Hysteresis Loops (-30°C)	101
FIGURE 5.27: Sealant G Hysteresis Loops (-30°C)	101
FIGURE 5.28: Sealant H Hysteresis Loops (-30°C)	102
FIGURE 5.29: Maximum Tensile Sealant Configuration	104
FIGURE 5.30: Typical +30°C Analysis of Surface Strain	107
FIGURE 5.31: Maximum Compressive Sealant Configuration	108
FIGURE 5.32: Sealant A Analysis of Surface Strain at -30°C.....	108

1 Introduction

1.1 General Overview

The sealing of joints and cracks in pavement structures has been in practice since the early 1900s. Over the years, joint sealing materials have evolved from sand, tar paper, coal-tar pitch, asphaltic compounds, or wooden blocks to highly sophisticated materials such as silicones, polyurethanes, preformed, and hot-pour sealants in use today, (Lynch 1996). Early sealant materials were not subjected to standardized testing procedures and many failed as a result. Since then, several test procedures have been investigated and a few have been accepted into approved standards, such as ASTMs, for many of the materials on today's market. Variability within the sealants and the empirical nature of the tests have been ineffective in predicting sealant behaviour in the field.

Current test standards are empirically based tests and have little or no correlation to field performance. Advancements in performance based specifications are needed with the development of more stringent testing procedures. Failed sealants have been the cause of many pavement distresses and the current empirical test procedures do not explain why one material performs well and one material does not when both laboratory tests are within the specified limits. ASTM laboratory test procedures also require long and sophisticated tests that many highway or transportation agencies are unable to perform, relying on past performance or previous field trials. This leaves many newer and better performing products off the approved products list and accepts sealants with satisfactory field performance. Sealant performance can be categorized by good, satisfactory or poor performance. Good performing sealants refer to sealants with less than 10 percent failure over the life of the field trial and satisfactory performing sealants are those which exhibit between 10 and 30 percent failure. Poor performing sealants are sealants with greater than 30 percent failure over the life of the field trial.

Field based sealant trials have been the foundation for much of the knowledge base in transportation departments and although this knowledge can be more accurate, field trials

are expensive and can take up to 5 years to complete. Some field trials have ranked sealants against one another with a maximum percent failure rate over the trial period, while others have looked at the joint configuration, the routing of cracks, use of a hot-air lance and other installation procedures. Field trials can complicate matters somewhat, as preparation of the joint and extended heating of the sealant can cause changes to the sealant properties, which can lead to early failure.

In Manitoba field trials have been the basis for sealant selection. The last crack sealant field trial conducted in Manitoba was initiated in 1995 and completed in 1997. The study compared 13 hot-pour crack sealants placed in the fall of 1995 along Provincial Trunk Highway (PTH) #1. The process evaluated and approved hot-pour crack sealants based on two year satisfactory field performance and lab testing for specification and procurement by the Manitoba Department of Highways and Transportation, currently Manitoba Transportation and Government Services, (MTGS), (Manitoba, 1996 and 1997). The recommendations from these field trials were that:

- Five hot-pour crack sealants with satisfactory field performance were approved.
- A wider rout configuration of 4:1 should be adopted by the Department and
- Only new sealants which conformed to the low modulus specification (D6690 Type IV sealants) should be considered for acceptance by the Department

Hot-pour sealants are polymer modified bituminous blends formulated to provide certain bond, elastic modulus and resilience. The formulation of a sealant blend remains proprietary information and the suppliers only provide Material Safety Data Sheets (MSDS) without mechanical testing. Without knowledge of the formulation of the materials, two materials may have the same components but not the same composition and one material may be cheaper or better performing. The ability to test new sealants using accelerated laboratory testing and to correlate the results with field performance allows transportation departments to accept new products as they come onto the market. Performance based testing allows for the differentiation of multiple sealants at in-service temperatures.

1.2 Research Objectives

The purpose of this research is to investigate and rank the performance of various candidate sealant materials for applicability of use in Manitoba through a rational non-biased approach. The project involves laboratory testing of sealant materials to verify fundamental properties and performance simulation under cyclic loading.

The general objectives of this research project are to:

- (a) Establish a performance-based laboratory test criteria and test methods at the University of Manitoba.
- (b) Quantify and rank selected sealant materials using laboratory methods and field evaluation methods of bond and cohesion
- (c) Provide local transportation agencies with a laboratory test procedure that gives sealant field performance results.

Detailed Project Tasks:

- Literature review of present state of the art and state of the practice dealing with material types, construction issues, and practical considerations.
- Laboratory testing: the performance of various sealant types and sealant families can be best made in a controlled laboratory experiment, which will eliminate many of the random variability likely to occur in the field. The combination of load, thermal ramping, and using restrained specimens will provide insight into the relative performance of the sealant and its adhesion to the joint face. The evaluation tests include: Cyclic loading in tension, and compression.
- Field monitoring (collaboration with MTGS): test sections will be selected to demonstrate the performance of joint sealants under actual environmental and stress conditions. The monitoring includes
 - a. Joint opening displacement: manual readings. This monitoring will help develop joint width criteria and relate sealant type to joint opening.
 - b. Joint and sealant condition monitoring: inspect and document sealant or joint damage and identify causes and remedial procedures.
 - c. Distinguish sealant failures in cohesion and adhesion and approximate time (season) of failure.
- Sealant selection criteria and application guidelines: assist the sponsoring agency in developing or updating the criteria for sealant selection and application. This task will require collaborative work with the manufacturers and local suppliers to upgrade current practices.

1.3 Scope

Manufacturers were invited to participate in a joint field and laboratory crack sealant study. The scope of this study is limited to 8 of the hot-pour materials provided by the manufacturers. This study contains the results of the laboratory evaluation performed on these sealants. The field samples were placed in the summer of 2004 and the first year evaluation of these field trials will not be completed until the spring of 2005. The laboratory results will be correlated with the performance of the sealants in the field trial. Due to the long term nature of the field trial it was not possible to include the field results within this research. It is anticipated that this will be completed by September 2006.

This research looks to develop a laboratory evaluation procedure to be used to predict the performance of new joint and crack sealants for use in Manitoba's cold climate. Based on the cyclic test procedure at three in-service temperatures, new materials can be tested and compared to past performance. The benefits of this research are the ability to test new products on the market and ensure their suitability for maintaining an effective seal in cold climates. Field trials require a minimum of two years performance to select the suitability of the material for this climate, laboratory evaluation can be completed in a maximum of two months, allowing local transportation agencies quicker access to new, cost-effective and better performing materials.

1.4 Organization of Thesis

This thesis has been organized as follows:

Chapter 2: Literature Review

This chapter reviews the purpose of joint and crack sealants, the development of sealants over the years, current material specifications, sealant failures and related pavement distresses, previous field trials from other jurisdictions, previous laboratory evaluations, the ageing of sealants, and other supplemental sealant information.

Chapter 3: Experimental Program

This chapter outlines the experimental program, including the field trial set up, the laboratory test setup and the sample preparation.

Chapter 4: Laboratory Test Results

This chapter presents the results from the fatigue test conducted in this study. There were 8 hot pour sealants tested in this study at three in service temperatures. Two specimens from each sealant were tested at each temperature +30°C, 0°C and -30°C. This chapter also presents the experienced gained using this test setup.

Chapter 5: Sealant Performance and Selection Criteria

This section discusses three sealant performance criteria that rank the sealants. The three criteria are percent load drop versus temperature, normal stress analysis and maximum surface stress analysis.

Chapter 6: Conclusions and Recommendations for Future Work

This chapter will outline a summary of the thesis, the conclusions of the laboratory test procedure and the ranking of the sealants based on laboratory performance. This section will also present recommendations for future work and improvements to the laboratory test procedure.

References and Appendices are included at the end of the thesis.

2. Literature Review

2.1. Introduction

Joint and crack sealants come in many forms, can be made into many different shapes and cover a variety of uses. Many types of sealants have been used to protect roads from damage in joints and cracks, each with a specific range of application. According to some researchers, “The purpose of sealants is to seal and fill cracks and joints in bridges, concrete and asphalt pavements“, (Panek, 1991). “They prevent the infiltration of water, brine, and stones into cracks and joints, thereby extending the service-life of the structure, (Peterson, 1982). The intended purpose of the sealant depends on the application, in roads for instance; sealants fill joints and cracks, keeping water and incompressibles from damaging the pavement structure. The joint or crack opening allows for the movement of the pavement structure, dissipating stresses that develop due to the fluctuation of temperature from day to night, and month to month as well as traffic loadings. There are three broad types of sealants, hot-pour sealants, cold-pour sealants and preformed sealants. The cold-pour can be further broken down into three categories that are one-component, two-component and silicone.

2.2. Types of Sealants

Sealants have been constantly evolving since their initial use in the early 1900s. The three major types of sealants are hot-poured, cold-poured and preformed. Hot-pour sealants are generally single component polymer modified asphalts, often mixed with other modifiers to extend their low-temperature performance. These sealants can be categorized into the four types listed below: (ASTM D6690)

- *Type I*—A joint and crack sealant capable of maintaining an effective seal in moderate climates. The material tested for low temperature performance at -18°C using 50 percent extension (formerly Specification D 1190).
- *Type II*—A joint and crack sealant capable of maintaining an effective seal in most climates. Material is tested for low temperature performance at -29°C using 50 percent extension (formerly Specification D 3405).
- *Type III*—A joint and crack sealant capable of maintaining an effective seal in most climates. Material is tested for low temperature performance at -29°C using

50 percent extension. Special tests are included (formerly Federal Spec SS-1401C).

- *Type IV*—A joint and crack sealant capable of maintaining an effective seal in climates experiencing very cold temperatures. Material is tested for low temperature performance at -29°C using 200 percent extension.

Hot-pour sealants can be trafficked shortly after placement. During the heating process the polymers and modifiers are blended together and once cooled provide a traffic-ready surface. They are typically used on high volume roads or on crack sealing jobs eliminating the need for traffic interruption.

Cold-pour sealants are grouped into three categories; silicones, one component and two component sealants. One component sealants are generally composed of asphalt emulsions, with selected petroleum resins or one-part polyurethanes. These sealants cure by exposure to air and ultraviolet light and so can take up to 3 weeks to cure completely and need to be covered with sand in the field if they are to be opened to traffic immediately after placement. Two component sealants are rarely used because they require precise mixing of two substances in the field. Silicones are more popular on joint sealing projects since they take longer to cure but some field trials suggest they last longer. Silicones can also react with different types of aggregate and are very stiff making them a poor candidate for use in crack sealing jobs and with asphalt pavements. Silicones come in two types, non-sag and self-leveling, the non-sag sealants require tooling to ensure the proper width to depth ratio is obtained and self-leveling sealants must have sufficient flow characteristics to form a smooth and level surface in horizontal joints without tooling or forming, (ASTM D5893). The most widely used sealants are the hot-pour polymer modified bitumen-based materials.

Preformed materials differ from the two previous types of sealants, these sealants are not formed in the field, but are produced in specific shapes by a manufacturer and inserted into the joint by a contractor, (Lynch 1998). The most common type of preformed sealants are compression seals which “seal” the joint by remaining in compression. These sealants require a vertical joint wall to obtain maximum sealing and are not

recommended for resealing projects, due to the difficulty in recreating a vertical joint or crack wall.

Sealants have evolved from the basic filler materials into very complex materials that must be placed in clean, dry joints or heated to specific temperatures to ensure no overheating of specific components. Past materials filled the pavement joint to keep the incompressibles out but did not adhere well to the joint walls and allowed water infiltration, (Lynch, 1998). Current day hot-pour materials recommended for cold climates are low modulus sealants, which are expected to withstand larger movements and greater temperature changes. Some of the materials are jet-fuel and jet-blast resistant for use on airport pavements. Sealants have typically been chosen based on empirical test results where there is a lack of correlation between field and test conditions, as test results do not necessarily reflect field performance (Masson, 2000). Performance based testing is crucial to allow new products to be used in the field.

2.3. ASTM Test Methods

The earliest material specification for hot-pour sealants came about in the early 1940s although this specification did not provide for a uniform melting process and this resulted in non-uniform melting and in some cases overheating, which has been known to cause material problems in the field, (Seibel, 1992). Many highway departments follow empirical based tests that evolved into ASTM Standards. Hot-applied joint sealants fall under ASTM D6690, D3406, and D3569, silicone sealants fall under D5893, cold-pour emulsions fall under D977 and D2397 and preformed sealants fall under D2628.

2.3.1. Hot-applied Joint and Crack Sealant Requirements

Table 2.1 lists the ASTM physical requirements for hot-poured joint and crack sealants. Hot pour sealants are covered under three separate ASTM standards, D3406 covers joint sealants, elastomeric-type for Portland Cement Concrete pavements, D3569 covers joint sealants, elastomeric, jet-fuel-resistant-types for Portland Cement Concrete pavements and D6690 covers joint and crack sealants, for concrete and asphalt pavements. Each of these tests attempts to ensure conformance of each sealant to factors that in the past represented good performance of sealants in the field.

TABLE 2.1: Physical Requirements for Hot-Poured Joint and Crack Sealants

Property	Sealants	Requirement	ASTM Standard
Conditioning/Cure Times	Type I-IV ^A D3406, D3569	24 h ± 4 h 72 h ± 2 h	D5329
Cone Penetration			D5329
a) Non-immersed @ 25°C, 5 s	Type I-III D3406, D3569	90 units (max) 140 units (max)	
b) Fuel-immersed @ 25°C, 5 s	Type IV D3569	90-150 units Shall not exceed non-immersed	
Flow			D5329
a) 60°C for 5 h	Type I	5 mm (max)	
b) 60°C for 5 h	Type II-IV	3 mm (max)	
c) 60°C for 72 h	D3406, D3569	No flow	
Bond			D5329
a) Non-immersed, 25.4 mm specimen 50 % extension at -18°C	Type I	2 of 3 specimens pass ^B 5 cycles	
b) Non-immersed, 12.7 mm specimen 50% extension at -18°C	D3406, D3569	3 specimens pass ^B 3 cycles	
c) Non-immersed, 12,7 mm specimen 50% extension at -29°C	Type II and III	3 specimens pass ^B 3 cycles	
d) Non-immersed, 12.7 mm specimen 200% extension at -29°C	Type IV	3 specimens pass ^B 3 cycles	
e) Water-immersed, 12.7 mm specimen 50% extension at -18°C	D3406, D3569	3 specimens pass ^B 3 cycles	
f) Water-immersed, 12.7 mm specimen 50% extension, -29°C	Type III	3 specimens pass ^B 3 cycles	
g) Fuel-immersed, 12.7 mm specimen 50% extension at -18°C	D3569I	3 specimens pass ^B 3 cycles	
Resilience			D5329
a) 25°C	Type II-IV, D3406, D3569	60 % min.	
b) Oven Aged 70°C for 24 ±2 h	D 3406, D3569,	60% min.	
c) Oven Aged 70°C for 168 h	Type III	60% min.	
Artificial Weathering – 160 h	D 3406, D3569	No physical change	D5329
Tensile Adhesion – average three specimens	D3406, D3569	Min. 500 % elongation	D5329
Flexibility - 70°C for 72 h, bent at 90°	D3406, D2569	No surface crazing or cracking	D5239
Solubility – specimen immersed in jet fuel for 24 h	D3569	No change in weight greater than 2%	D5329
Asphalt Compatibility – tested at 60°C	Type I-IV	Pass ^C	D5329

^ATypes I to IV refer to definitions from ASTM D6690

^BThe development at any time during the test procedure of a crack, separation, or other opening that at any point is over 6 mm deep, in the sealant or between the sealant and concrete block shall constitute failure of the test specimen. The depth of the crack, separation or other opening shall be measured perpendicular to the side of the sealant showing the defect.

^CThere shall be no failure in adhesion, formation of an oily exudate at the interface between the sealant and asphaltic concrete or other deleterious effects on the asphaltic concrete or sealant when tested at 60°C.

2.3.2. Cold-applied Silicone Joint Sealant Requirements

Table 2.2 covers the physical requirements of cold-applied silicone joint sealants, from the standard D5893, many of these tests can take days, weeks or months to perform and are very costly. This specification is one of the only material standards for silicone sealants but does not necessarily indicate field performance.

TABLE 2.2: Physical Requirements for Cold-applied Silicone Joint Sealants

Property	Requirement	ASTM Standard
Cure Evaluation – 12.7 by 12.7 mm cross section	21 days	D5893
Rheological Properties		
a) Non-sag Sealant	Slump < 7.6 mm	D2202
b) Self-Leveling Sealant	Smooth level surface	C639
Extrusion Rate	> 50ml/min.	C1183
Tack-free time	5 hours ± 10min	C679
Effects of Heat Aging	Weight loss < 10% and not show any cracking or chalking	C792
Bond		
a) Non-Immersed, 12.7 mm specimens at -29°C for 5 cycles at 100% extension	No crack, separation or other opening	D5329
b) Water-Immersed, 12.7 mm width specimens at -29°C for 5 cycles at 100% extension	No crack, separation or other opening	
c) Oven-Aged, 12.7 mm specimens, heated at 70°C for seven days, follow non-immersed bond	No crack, separation or other opening	
Hardness		
a) Tested at -29°C, Type A-2 durometer	Not exceed 25	C661
b) Tested at 23°C, Type 00 durometer	Not less than 30	
Flow, tested at 93.3°C for 72 h	No flow	D5329
Rubber Properties in Tension		
a) Ultimate Elongation at 23°C, using 500 mm/min	Not less than 600%	D412, Die C
b) Tensile Stress at 150% Elongation, at 23°C, using 500 mm/min.	Shall not exceed 310 kPa	
Effects of Accelerated Weathering, 5000 h of exposure	No flow or tackiness or presence of an oil-like film or reversion to a mastic-like substance	C793
Resilience, Oven aged at 70°C for seven days	Not less than 75%	D5239

2.3.3. Preformed Polychoroprene Elastomeric Joint Seals for Concrete Pavements

Table 2.3 covers the physical requirements for preformed elastomeric joint seals, these sealants fall under a different style of sealants. The sealants bond to the joint interface by being under compression and are not expected to remain in place if the joint opens wider than the original size of the sealant. The key to good use is determining the correct size of sealant for each joint to ensure the joint opening will never be wider than the sealant. Preformed joint seals have had great success but continue to be one of the most costly joint sealing materials on the market.

TABLE 2.3: Physical Requirements for Preformed Elastomeric Joint Seals

Property	Requirement	ASTM Standard
Tensile Strength, MPa	13.8 min.	D412
Elongation at break, %	250 min.	D412
Hardness, Type A Durometer, points	55 ± 5	D2240 (modified) ^A
Oven aging, 70 h at 100°C		
- Tensile Strength, loss, max, %	20 max.	
- Elongation, loss, max, %	20 max.	
- Hardness, Type A durometer, points change	0 to +10	
Oil Swell, ASTM Oil 3, 70 h at 100°C		D471
- Weight change, max, %	45 max.	
Ozone Resistance		D1149
- 20% strain, 300 pphm in air, 70 h at 40°C	No cracks	(modified) ^B
Low-temperature stiffening, 7 days at -10°C		D2240
- Hardness, Type A durometer, points change	0 to +15	
Low-temperature recovery, ^C 72 h at -10°C, 50% deflection, %	88 min.	9.2 ^D
Low-temperature recovery, ^C 22 h at -29°C, 50% deflection, %	83 min.	9.2 ^D
High-temperature recovery, ^C 70 h at 100°C, 50% deflection, %	85 min.	9.2 ^D
Compression-deflection, at 80% of nominal width, min, N/m	613	9.3 ^D

^A The term "modified" in the table relates to the specimen preparation. The use of joint seal as the specimen source requires that more plies than specified in either the modified test procedures be used. Such specimen modification shall be agreed upon by the purchaser and seller prior to testing. The hardness test shall be made with the durometer as recommended in Test Method D2240.

^B Test in accordance with Procedure A of Test Method D518.

^C Cracking, splitting, or sticking of a specimen during a recovery test shall mean that the specimen has failed the test.

^D The reference sections are those of specification D2628.

Based on field trials some conclusions have been that sealant specifications need to be revised to better reflect field performance, (Cuelho, 2003). The current ASTM specification selects sealants based on penetration, resilience, flow and bond to concrete/asphalt interface, “Because of the lack of correlation between field and standard test conditions, standard test results do not reflect field performance, (Masson, 2000). Table 2.4 displays results from field performance in cold climates and ASTM acceptance.

TABLE 2.4: Sealant acceptance based on ASTM D3405 and field tests (Masson, 1998)

Sealant	4-year performance	ASTM acceptance
H	Good	No
B	Good	Yes
E	Good	No
F	Average	No
M	Average	Yes
L	Average	Yes
D	Average	Yes
J	Average	No
K	Poor	Yes
A	Poor	No
C	Very poor	No
G	Very poor	No

2.4. Sealant Failures and Related Pavement Distresses

2.4.1 Definitions of Sealant Failures

Sealants play an important role in the pavement structure and when they fail many problems can occur. Sealant failures can be defined into two general categories: adhesion and cohesion. Adhesive failures occur when the sealant is no longer bonded to the joint or crack face. Cohesive failures are when the sealant ruptures or cracks. Some of the causes of sealant failures are the inability of the sealant to handle the movement of the pavement slabs as well the stiffness of the sealant which can greatly affect the performance of the sealant at temperature extremes.

Some field specific definitions of sealant failure come from the following field trials. A field study carried out in Montana to assess the most economical and effective material and method for sealing cracks in flexible pavements, failure was defined by the following four types: adhesion, cohesion, pullout and secondary cracking, (Cuelho, 2003). A field

study in North Dakota evaluated the effective sealant capabilities of various types of crack sealing products in use with asphalt pavements. Failure was defined if the combined failures totalled 20 percent or more of the joint length, (Marquart, 2001). A laboratory study carried out by Al-Qadi et al, defined the major joint-sealant failure types as adhesive, cohesive, intrusion and extrusion, and intrusion of incompressible material into the joint. The failure of the sealant itself is not catastrophic, however, this failure can lead to the reduction of service life of the surrounding pavement section, (Al-Qadi, 1999). Masson, (2000), investigates sealant failures, causes, and the possible origins, as displayed in Table 2.5.

TABLE 2.5: Crack Sealant failures, their causes, and possible intrinsic origin*

Failure types	Causes	Origin
Adhesive	Poor wetting	High sealant viscosity High insoluble content Segregation of sealant components
	High modulus	Excessive polymer, rubber or filler in sealant Ageing, short-term and long-term
	Incompatibility	Weak aggregate-sealant interaction
Cohesive	High modulus	Excessive polymer, rubber or filler in sealant
	Low shear strength	Short-term ageing
Sealant loss	-partial	Embrittlement High glass transition temperature Excessive asphalt content in sealant Ageing
	-complete	Pull-out Excessive flow Poor freeze-thaw resistance Shear sensitive

*Excludes failures related to construction, e.g., geometry

2.4.2 Related Pavement Distresses

Preventative maintenance such as joint and crack sealing can reduce moisture infiltration into the pavement system. When moisture enters the pavement there can be a loss of load bearing capacity and premature pavement failure, which leads to much costlier fixes. Many views differ on the cost-effectiveness of sealing pavement joints, especially if the sealant does not perform well over the long-term, joint deterioration will occur and savings will not be realized, (Olson, 2003).

Allowing water into the pavement structure promotes stripping damage to bound materials and can decrease the strength and stiffness of underlying, unbound materials. (Cuelho, 2003). This report described crack sealing as a procedure that while not directly improving the structure integrity of the pavement, looks to improve the future pavement structural integrity by keeping water out of the pavement structure.

2.5. Field Trials

Field trials have long been the evaluation procedure for many transportation agencies. These studies have consistently proven field performance of joint and crack sealants, with one major drawback, the length of time to obtain the results. The following section is a review of previous field trials from other jurisdictions and the subsequent results. Each field trial is discussed, including the purpose of the study, the joint width to depth ratios, the routing, the types of sealants and the performance.

2.5.1 North Dakota Crack Sealant Study

A field study in North Dakota evaluated the effective sealant capabilities of various types of crack sealing products in use with asphalt pavements. Four hot pour sealants were evaluated, using a routed joint configuration. Two types of routed joints were used a $\frac{3}{4}$ " by $\frac{3}{4}$ " and a $1\frac{1}{4}$ " by $\frac{3}{8}$ ", with one of each type used for all four sealants. Some conclusions of the project were that the rout needs to have vertical walls with a flat bottom and so the cutting wheels on the router must be kept in good condition. As well it is important to ensure that the crack is followed, missing just to the side of the crack will ensure failure, (Marquart, 2001). The study also stated that the wider rout configurations had better performance since all the cracks underwent the same expansion.

2.5.2 SHRP H-106 Project

A maintenance experiment carried out by Strategic Highway Research Program (SHRP) Project H-106 in March 1991 began installation of 22 test sites for investigation of various pavement maintenance materials and procedures. This experiment looked at pothole repair, crack sealing and filling, joint resealing, and partial-depth spall repair. The crack sealing experiment installed four transverse crack seal test sites and one longitudinal crack fill test site. A total of 15 different materials were placed at the

various test sites including 10 crack sealants and 5 crack fillers (Evans, 1995). Seven different crack preparations were used at the various sites as well as eight different configurations of material placement. In general, good short-term performance can be achieved by both standard and low-modulus rubberized asphalt sealants. Silicone sealants showed similar if not better performance than hot-applied materials. Reservoir configurations provided better short-term performance than the simple band-aid configuration, where the crack was filled but not routed.

The joint reseal experiment from Project H-106 proposed to evaluate joint resealing as a common maintenance practice, since premature seal failure is frequently experienced, leading to additional repair and expenditure, (Evans, 1999). A total of 1,600 joints were resealed at 5 test sites using 12 sealant materials and 4 methods of installation. The 12 materials used were low-modulus rubberized asphalt sealants, silicone sealants, as well one one-part polysulfide sealant. The 4 configurations used were saw and recessed, saw and overband, plow and overband and saw and flush-fill. The sealants placed were approximately 13 mm in width, using a 2:1 width to depth configuration. To evaluate the field performance, 10 evaluations were completed at 1, 5, 9, 12, 18, 30, 42, 56, 68 and 82 months after installation. The distresses collected were:

- Partial-depth adhesion loss
- Full-depth adhesion loss
- Partial-depth spalling
- Full-depth spalling
- Overband wear
- Stone intrusion
- Partial-depth cohesion loss
- Full-depth cohesion loss

Findings over the 7-year evaluation period, showed significant seal failures, only 21 percent of the treatments developed 10 percent or less failure along the length of their joints. Colder regions experienced higher silicone sealant spalling than joints containing asphalt sealants. Correlation of laboratory test results and field performance data provided the observations:

- The ASTM D 3583 test at 23°C correlated well with adhesion failure in both the silicone and hot-applied sealants

- Overall sealant failure and estimated service life both related well with the ASTM D 113 maximum elongation and the ASTM D 3583 tensile adhesion test for hot-applied sealants.

This report compared different types of sealants in different configurations in different climates and gave many recommendations to designer/operators of joint resealing projects and to planner/researchers as well. Silicone sealants were recommended for many types of configurations as long as it was maintained below the surface and not subjected to traffic wear. Hot-applied sealants were recommended for projects to be overlaid or replaced in less than 6 years and should be overbanded to ensure better performance.

2.5.3 LTPP Supplemental Joint Seal Experiment

A supplemental joint seal experiment was carried out by the Long-Term Pavement Performance (LTPP) program to evaluate 21 sealants at 6 test site locations. The majority of the sealants placed were silicone, however, several hot-poured sealants and preformed compression seals were also installed, (Smith, 1999). The sealant materials were installed using seven joint preparation methods, although not every test site installed the same material-configuration combinations as several of the treatments were unique to only one site. Each site followed the same sealant installation process of:

- Primary/initial joint sawing
- Secondary/reservoir joint sawing
- Joint cleaning
- Backer material placement
- Sealant application

Several types of performance data was collected, primarily consisting of seal failure data and seal distress data. Sealant failure was defined as a deterioration of the seal material or surrounding pavement that permits moisture or debris to pass below the seal. Seal distress was defined as those seal system deficiencies that result in a reduction in seal performance without inhibiting the seal's ability to resist the infiltration of moisture and debris below the seal. The final findings and recommendations are as follows:

- The overall average failure of treatments at five of the six sites at these 5 to 7 year old sites ranged from 19 to 58 percent of the joint length. At the sixth site, overall joint seal failure was approximately 9 percent (2 year old site).

- 26 of the 56 joint seal treatments have shown greater than 80 percent effectiveness, 7 have shown 65 to 79.9 percent effectiveness, 1 has shown 50 to 64.4 percent effectiveness, and 22 have “failed”, with less than 50 percent effectiveness.
- Poor construction practices, such as overheating and extended heating of hot-applied sealants, placement of silicone seals too thin or too high in the joint, and hand installation of compression seals, have affected the performance of several joint seal treatments.
- Due to a lack of laboratory testing and an overall lack of statistical performance differences among sealant materials, no significant relationships were identified between field performance indicators and laboratory-determined material properties.
- Hot-applied sealants in 9 mm wide joints will provide moderate performance (4 to 8 years) if they are properly heated and installed in thoroughly cleaned joints. Hot-pour sealants’ service life is substantially shorter than silicone seals and compression seals although their installation costs are considerably less, which make them the most cost-effective option.

2.5.4 Ohio Joint Sealant Experiment

A joint sealant experiment was constructed and evaluated in Athens, Ohio, which involved the installation of joint sealants in the transverse joints of a newly constructed Portland Cement Concrete (PCC) pavement, (Hawkins, 2001). Fifteen different combinations of materials and joint configurations were used, which also included unsealed sections. Ten sealant types were installed, 2 hot-applied sealants; 4 silicone sealants and 4 preformed compression seals. The joints were sawed, cleaned of all residue and backer rod was then installed prior to the installation of the silicone and hot-applied sealants.

Visual inspections of the sealants were conducted twice during the first year with the conclusion that the silicone and hot-pour sealants are in fair to poor condition. The narrow 3 mm joints showed the highest failure. It was concluded with the exception of one of the preformed compression seals that they exhibited significantly better performance to date than the liquid sealants. The unsealed sections were also performing well, exhibiting no visibly signs of distress at the joints or in the slabs. This study also evaluated pavement structural performance, which unlike the sealant performance, in which the westbound lanes are superior to the eastbound, pavement structural performance in the eastbound lanes is higher than in the westbound lanes, (Ioannides,

2004). The westbound lanes have superior sealants but are experiencing more extensive transverse cracking suggests that no correlation exists between sealant effectiveness and transverse cracking. The correlation of other structural deformities such as corner breaks and spalls with sealant effectiveness found that there is no correlation with corner breaks and a faint correlation with spalling. Surface profilometer surveys were also carried out and further suggest that there is no correlation existing between sealant effectiveness and pavement surface deterioration.

The conclusions of the Ohio joint sealant experiment are that:

- “serious consideration needs to be given to the joint cleaning and sealant placing operations”
- Sandblasting is important to provide a rougher surface for the sealant to bond to.
- There is little if any correlation between sealant performance and the development of structural distresses or of surface roughness in the pavement.

2.5.5 Ottawa Crack Sealing Field Evaluation

A field evaluation of crack sealing in the Ottawa-Carleton region used three different crack sealing materials, to determine whether “low-modulus” materials offer superior performance in the local climate, (Corbett, 2000). Past experience has shown that using materials listed on the Ontario Ministry of Transportation’s sources list does not imply that the material will be effective for the climate, due to the excessive failures occurring in the Ottawa-Carleton region. These problems have led to the requirement for a better material specification, more suited to the local climate.

The three sealants were placed in one of two configurations, a 40 by 10 mm configuration with no overband and a 12 by 19 mm with overband. The cracks were routed and the sealants were placed. The results showed that all materials performed better in longitudinal versus transverse cracks, with one of the materials performing statistically better than the other two. Failure was defined if either the bond or material exceeded the selected failure threshold. If 10 percent failure was the selected threshold then sealants A and B had more than 55 percent failure with Sealant C showing only 12 percent failure.

Recommendations were that the modified ASTM specifications cannot be reliably used to obtain a high-performance crack sealing material. The report suggested warranty-type contracts could be used as an alternative to method-specification type contracts.

2.5.6 Montreal Crack Sealing Cold Conditions Performance

The selection of sealants for use in cold climates has been a difficult task as minimum 1 year field trials have been the normal selection tool, (Masson, 1999). A study carried out in the Montreal region looked at the performance of twelve bituminous hot-pour crack sealants over four years in temperatures ranging from -40 C to +40 C. The sealants were placed in transverse and longitudinal routs of 12 by 12 mm, 19 by 19 mm and 40 by 40 mm. The cracks were sealed after they were routed, cleaned and heat treated.

Numerical modeling of the sealants was performed to compare expected to observed performances. The models did not take into account some factors of the field conditions, which are most likely responsible for the discrepancies amongst the results. Sealant aging and unaccounted shear stresses at the surface can also explain some of the discrepancies. The sealants were also ranked in decreasing order of field performance and the performance compared to ASTM test results. Little correlation was found between the two sets of results which brings into question the usefulness of the specification in selecting good sealants. The study concluded that sealant performance was found to vary tremendously from one product to the next. It was found that sealants with either good or poor field performance failed to meet the requirements of the ASTM D3405 specification. The authors also recommended that a performance-based specification was required to select sealants adapted to the condition.

2.5.7 Montana Crack Sealing Experiment

A study in Montana looked to determine an estimation of the useful life for crack sealing to be incorporated into Montana's pavement management system, (Johnson, 2000). Sealing techniques used both nonrouted and routed methods. The method of evaluation included the last twelve full-width transverse cracks in each test section to allow for a larger sample size which will help with the comparisons between test sections. Modes of

failure included material failure and those caused by a combination of factors. Failure was determined as follows:

- 0-10 percent failure, excellent
- 11-20 percent failure, good;
- 21-35 percent failure, fair;
- 36-50 percent failure, poor; and
- 51-100 percent failure, very poor

Interim conclusions were that no substantial differences have been observed between materials with cone penetration values greater than 90. All these sealants appear to remain flexible at cold temperatures. Routing improves performance for transverse cracks, but did not appear to be necessary for longitudinal cracks. It was also found that during the summer heat and the closing of the cracks, healing of the seal occurred, but, was found to be too little too late, as this occurred after the wettest portion of the year. Any benefits related to the healing are reduced because the water had already infiltrated the pavement.

Many transportation agencies over the years have struggled with the question of whether or not to seal a pavement joint, (Burke, 2002). This paper examines the case for and against the use of unsealed jointed concrete pavements, with a primary focus on the performance of Wisconsin test-pavements. Wisconsin researchers issued a challenge to other researchers to prove that total pavement performance was not significantly effected by joint sealing or lack thereof. A summary of Western European concrete practices was conducted and found that not a single country has adopted unsealed pavements as a standard pavement type for road construction. This study has made it clear that the use of unsealed pavement joints has been largely ineffective in providing long-term cost-effective pavement performance. Care must be taken in choosing high quality sealant material, the type and size of sealant for the chosen pavement joint and panel characteristics, as well as effective installation and inspection procedures, and periodic sealant repair and replacement practices.

2.6. Laboratory Trials

Field trials are often long and time consuming, not necessarily feasible all the time for the approval of new material, which is why it is desirable to develop a laboratory performance based protocol. The need for sealants in rigid pavement joints has become debatable, partly because of the unpredictable field performance of joint sealants. The inability to predict sealant performance stems from the fact that there is no laboratory evaluation method that accurately simulates field traffic and environmental loading conditions. There are ongoing efforts to develop performance-based laboratory test procedures.

2.6.1 Virginia Tech Joint Sealant Testing

Al-Qadi et al. evaluated rigid pavement joint sealant under cyclic shear and constant horizontal deflections, (Al-Qadi, 1999). The test setup consisted of two concrete cubes and a sealant sandwiched between them. Two types of aggregate were used as well as two sealant types; a silicone and a one-part polyurethane. Sealant performance is influenced by many parameters, including workmanship quality, sealant shape factor, joint spacing, sealant physical and chemical properties, joint characteristics, joint cleaning, loading, deflection, temperature and oil contamination.

The evaluated sealant types were tested under temperatures ranging between -34°C and 26°C . The results indicated that changing temperature did not affect the sealant's response significantly, therefore the testing was performed at 23°C . Five joint widths from 12.7 to 25.4 mm and the horizontal deflections were varied between 6.2 and 58 percent of the joint width, and a shear deflection of 3.2 mm was used in this study. To simulate a truck moving at 88 km/h, a pulse was applied for 0.05 seconds and was followed by a relaxation for 0.25 seconds. Sealants were considered failed when 20 percent of the specimen showed adhesive and/or cohesive failure. The number of cycles to failure was reported, and the variation within the results of identical specimens did not exceed 15 percent.

The results showed that most of the failures were adhesive and that sealant performance is affected by joint width: the smaller the joint, the better the performance, especially for polyurethane. For slab contraction, the greater the joint width the better the performance. The joint needs to have a width range that meets construction specifications and temperature change effects.

The effects of freezing and thawing on sealant performance were only visible in the engineering stress. A reduction in the engineering stress occurred when freezing and thawing cycles were applied. No significant changes in the number of cycles to failure were noted. Conclusions were that sealants were greatly affected by joint width, joint extension, and the aggregate type used in the concrete. However, temperature changes and freezing and thawing cycles were insignificant. Joint width should be kept at a reasonable size to optimize its fatigue life and stress resistance capability, (Al-Qadi, 1999).

2.6.2 University of New Brunswick Joint Sealant Testing

Rogers et. al proposed a laboratory test apparatus which would simulate joint movements and be used to evaluate the performance of various commercial sealants used for sealing undoweled joints. This research looked at fatigue testing of polyurethane joint sealants in cyclic shear, (Rogers, 1998 and 1999). The work involved testing sealants at multiple temperatures to simulate traffic loads in undoweled or faulted concrete pavement joints. Previous research has been done to assess the sealant resistance to repeated lateral expansion and contraction in order to simulate concrete behaviour caused by temperature variation. However a common cause of sealant failure is the result of cyclic shear in the joint due to heavy truck loading. This work evaluated three main parameters – temperature, joint size and pavement deflection – on the strength and durability of the sealant. The sealants were subjected to compressive or tensile stress as results when the adjacent concrete slabs expand or contract due to temperature effects in the field.

A constant shear deflection of ± 3 mm was applied for 250,000 cycles at a frequency of 8 Hz, with the actuator force being recorded. The first set of tests investigated the

temperature dependence of the sealant using -40°C , $+40^{\circ}\text{C}$ and room temperature. The sealant was more resistant to deflection at lower temperatures than at higher temperatures, indicating a change in the viscoelastic behaviour. The second set of tests looked at the sealant response to alternate cycles of freezing and thawing. The test cycled between $+40^{\circ}\text{C}$ down to -40°C for three hours and increased to $+40^{\circ}\text{C}$ for three hours. This was repeated once and the shear resistance was recorded. The resistance at -40°C went up 131 kPa between the two cycles while the $+40^{\circ}\text{C}$ values remained relatively unchanged. Sealants exhibit viscoelastic properties and at warm temperatures the material exhibits elastic behavior. At very cold temperatures the sealant is very stiff and as the temperatures increases, a point is reached at which the modulus of elasticity of the material begins to decrease at a rapid rate. The flexibility increases and the temperature at which the modulus begins to decrease is referred to as the glass transition temperature of the material. In the transition range between the glass transition temperature and the elastic region the behaviour of the material is termed viscoelastic. The summary was the development of method to simulate sealant shear fatigue due to periodic traffic loads.

The following test procedure allows for the most suitable sealant for the expected service conditions to be selected. (Rogers 1999).

Step 1: Adhesion-in-peel Tests

- In accordance with ASTM C794,
- This test was used to provide visual observations of the adhesion between the sealant and the concrete.

Step 2: Dynamic Mechanical Analysis (DMA)

- Evaluated the viscoelastic properties of sealants.
- This test helped to determine if a sealant will become rigid and brittle and experience failure in the field.

Step 3: Shear Fatigue Tests

- Studied the effects of temperature, moisture, and thermal expansion/contraction on the ability of a sealant/concrete joint to resist deflection.
- The testing found that the shear resistance of the sealant is directly proportional to the force applied to the sealant.

Step 4: Dynamic Mechanical Analysis

- This test was performed after the fatigue test to measure the glass transition temperature (T_g) of the fatigued joint sealant. Sealants that maintained a T_g comparable to the prefatigue value would not have suffered significant molecular degradation and can be considered suitable for sealing.

This research proposed that the average joint shear resistance should be used to compare the flexibility of sealants.

2.6.3 Carleton University Joint Sealant Testing

Abd El Halim et al. tested a silicone, rubber based cold-poured and a thermoplastic hot-poured sealant in tension and compression using displacement-controlled loading at five service temperatures, (Abd Al Halim, 1997). The temperature varied from -40°C to $+40^{\circ}\text{C}$, while the strain rate varied from 2.5 mm per minute to 25 mm per minute. The objective of the study was to investigate the change in tensile and compressive behaviour of three types of sealants at various temperatures and strain rates.

Observations included that the cold-poured and silicone tests samples fully recovered after removal of the applied compressive or tensile loads. The hot-poured samples showed a high degree of plastic, non-recoverable deformation. The tests were terminated when the nominal strain reached approximately 80 percent. In compression one cold-poured sample split at $+40^{\circ}\text{C}$, whereas in tension, two cold-poured samples ruptured at $+40^{\circ}\text{C}$ and two hot-poured samples ruptured at -40°C . The sealant behaviour was unaffected by the strain rate applied in the tests.

Some findings were that the tensile modulus (stiffness) of the silicone is almost constant regardless of the test temperature. In compression the compressive modulus of the silicone is significantly dependent on the test temperature. The test results showed that for temperatures lower than 0°C , hot-poured sealants will have the highest tensile stiffness. The silicone sealants had the lowest tensile stiffness under all test conditions. The cold-poured sealant consistently displayed modest tensile stiffness regardless of its temperature, (Abd Al Halim, 1997).

2.6.4 Transportation Association of Canada Crack Sealant Testing

A project carried out by Transportation Association of Canada looked to identify an effective laboratory test method and equipment design for prediction of field performance of crack sealants. (Zanzotto, 1997). The objectives of the study were:

- To identify factors critical for the field performance of crack sealants;
- To select and develop a test method that reflects these critical factors
- To design testing instruments capable of performing the selected performance test;
- To verify the laboratory test methods by comparing test results to known field performance of crack sealants.

Factors which influence performance of crack sealants in the field:

- Those which are a function of crack sealant properties (fluidity, softness, hardness or bond strength toward the crack wall)
- Those which are not a function of crack sealant properties (installation methods, type of winter maintenance).

A test protocol was developed with 16 commercially manufactured crack sealants. First a Low Temperature Stress Relaxation Test was performed which measured the resistance of crack sealant to extension. This test was to assess the ability of the crack sealant to change shape and also dissipate the imposed stresses as quickly and as much as possible. Second, the Tensile Adhesion Test measured the resistance of the crack sealant to debond from a solid surface.

During the second phase of the project 14 crack sealants with known field performance were evaluated by the previous tests and the results were that the sealants that failed in the field of which there were 4 all failed both tests, as in they debonded or cracked during the testing. It was concluded that if the crack sealant failed either test then the possibility of failure in the field increased and if the sealant failed both tests then it was not recommended for use in the field.

2.6.5 National Research Council Sealant Testing

A study of aging both short term and long term of crack sealants was carried out in Montreal, (Masson et al. 1998). This study was assessing the application temperatures and the significance of these temperatures to application practices. The sealants were heated to the application temperatures noted by the manufacturer and throughout an average work day were poured into molds and allowed to cure. During the 1-6 hour

heating period the viscosities of twelve sealants were measured and the sealant properties did not remain unchanged during the heating period and in fact:

- Elastomers present in crack sealants often degrade.
- Crack sealants lose volatile oils upon heating.
- Either longer dwell times at recommended application temperatures or higher temperatures, or both conditions combined, will promote faster degradation of mechanical properties.

Dynamic Mechanical Analysis (DMA) for two sealants was also performed looking at the glass transition (T_g) point of both of the sealants and the abilities of the sealant to dissipate cyclic stresses. Stress relaxation of the sealants is a very important characteristic. Dynamic Shear Rheometer (DSR) testing was also performed in the range of 5-85°C to assess sealant modulus and stress relaxation, and indirectly assess sealant degradation due to installation, (Oba, 1996).

The testing of the tensile adhesion of the bond was also looked at. The test investigated the measurement of the bond strength of sealants to concrete by bringing sealant-concrete assemblies to tensile failure. This testing indicated that sealants extended more at higher temperatures and that more energy was spent in stretching the sealant. The researchers used electrical resistivity as a measure of adhesion, (Masson, 1999). This test is based on the hypothesis that strong adhesion slows mass transfer along the interface more than weak adhesion. The resistivity was related to wetting and was directly proportional to pouring viscosity and inversely proportional to substrate roughness.

Future considerations such as the development of a performance-based specification would potentially rectify the mismatch of field and standard test conditions. As well the relationship between fundamental sealant characteristics and field performance must be established. Currently there are no standardized techniques for use with crack sealants, and no control parameters have been established, (Masson, 2000). These studies have shown that performance-based laboratory test methods can potentially simulate long term performance of sealants under field conditions.

2.7. Sealant Aging

Joint and crack sealants in the field are continually aging, from the time spent in the melter, short term aging, to the service conditions, long term aging. To simulate field conditions in the laboratory the aging of sealants must be considered. A literature review of previous test methods was conducted and two types of aging have been considered and will be discussed. Ultraviolet weathering; a water and light combination or heat aging using a forced-draft oven, or a pressure aging vessel.

Hot applied bituminous sealants fall under the ASTM specification D6690 which classifies sealants into four types. The typical type of hot applied sealant used in Manitoba is Type IV. Type IV sealants are considered low modulus sealants, less stiff in cold weather conditions, and are not required to undergo Oven Aged Resilience testing. In ASTM D6690 this is the only requirement for the laboratory aging of hot-applied bituminous sealants.

Short term aging which occurs in the melter is difficult to simulate in the laboratory, hot spots within the melter due to inadequate mixing can cause the sealant to be over heated in one area and under heated in another, (Masson et al., 2004). Hot applied sealants are made up of many different types of materials, such as, bitumen, polymer modifiers and recycled-rubber. Each sealant requires specific heating requirements depending on their components and therefore the sealants are to be heated to the correct application temperature specified by the manufacturer, if overheating occurs then degradation can occur. Sealant degradation during the crack sealant of pavements, a topic studied by the National Research Council of Canada (Masson et al., 1998), attempted to reconstruct short term aging and how it affects sealant behaviour in the laboratory. The study applied twelve hot-applied bituminous sealants in the field and selected three sealants to be tested in the laboratory. The viscosity of the sealants was measured during the six hour heating process, which is approximately the amount of time a sealant would stay in the melter in the field. As well the mass loss of materials was continuously monitored. The samples were poured out at regular intervals and tested in tension to assess the modulus of elasticity and the elongation at break of the sealants. The study concluded that sealant

properties do not remain unchanged and when melted at higher than recommended temperatures or for longer periods of time, faster degradation occurs.

Studies on long term aging have included the use of twin carbon-arc or QUV weatherometers and forced-draft ovens. Ultraviolet light and water vapour have been found to artificially age the specimen but only after long periods of exposure, minimum time 500 hours, (Van Dam et al. 1999). This type of testing requires many hours spent in the laboratory, which is not always possible, and may only result in a hardening of the surface layer. Sealant aging by UV alone is very time prohibitive, but when combined with freezing and thawing cycles can decrease the amount of time spent aging, (Masson and Lauzier, 1993). Some laboratory test setups have included thin sheets of silicone sealant placed in a forced-draft oven for 7 days at temperatures of 93°C. The specimens were not damaged in the process although appeared to undergo aging as shown in the subsequent DSR testing, (Lynch and Janssen, 1999).

Using heat aging for hot-applied bituminous sealants has not been tested in a laboratory procedure. Researchers at the University of Manitoba performed some experimental analysis with hot applied bituminous sealants set in between two concrete blocks, but long term exposure to 70°C temperatures caused the sealant to soften considerably and lose structure. This configuration for heat aging of sealants was discarded due to the loss of the sealant material. Aging hot-applied sealants in thin sheets seems to address this type of problem. Re-melting the sealant after aging will introduce more variability into the material and does not seem to represent field conditions, therefore it has been discarded as a potential test procedure. The sealant after cooling can be cut or punched from the sheet and tested in the DSR. DSR testing seems to provide promising results about the viscoelastic nature of sealants. "DSR testing has the ability to characterize material properties over a wide range of conditions", (Lynch and Janssen, 1999). The dynamic modulus of sealants can be derived from the stress components and can be used to classify sealants with higher elastic modulus or lower viscous materials. The heat aging of the sealants to represent in-service field conditions and comparison with before

test results can provide information about the effects of service conditions on the physical nature of the sealants.

2.8. Joint Opening

A variety of laboratory investigations have been performed to evaluate many types of joint sealants. Most tests have looked at tensile strength, compression, bond, penetration, flow, stress relaxation, shear fatigue and solubility. This test occurred in the laboratory and evaluated three sealant types at two different joint widths: 19 mm and 6.5 mm to simulate pavement expansion and contraction joints associated with 15-20 m reinforced concrete slabs and joints in plain unreinforced concrete pavements respectively, (Al-Qadi, 1995). The specimens were tested under cyclic loading using 4.4 mm in-line deflection for the 19 mm joint and the 6.5 mm joint was tested using in-line deflection of 1.5 mm. Failure was considered at 20 percent, although if no failure occurred then testing was terminated at 500,000 cycles. The influence of freezing and thawing on joint sealant performance was evaluated by exposing specimens to 50 cycles of rapid freezing and thawing conditioning, prior to testing, in accordance with ASTM standard C-666.

The results showed that the effects of freezing and thawing caused the number of cycles needed to cause failure to decrease as well as normal/shear stress at failure. The stress levels of conditioned specimens, as expected, were larger at the 19-mm joint width for all sealants under both compression and tension. Three sealants were tested a polyurethane, a low modulus silicone as well as a self-leveling silicone. Conclusions were that small joint widths offered higher sealant failure resistance than in the 19 mm joint width, as well that the 50 cycles of freezing and thawing reduced the number of cycles to failure.

The development of a model to predict joint opening is based on many factors which include the ambient and pavement temperatures. A study carried out by Morian (1999), looked at the ambient and pavement temperature trends of the LTPP sites to reasonably predict the joint movement. Some of the observations included that the intermediate hot climate showed a tighter range than those in the other climates. In cold climates such as Manitoba or Minnesota the movement range was from -5 to 3 mm or a total of 8 mm

movement. The paper compared the measured and calculated joint movements and revealed that in general the AASHTO method of estimating joint movement underestimates actual joint movement. The conclusion the researchers came up with is that joint were not be effectively sealed because approximately 1/3 of all the joint openings were much larger than the average of the majority of joints. As well the average measured openings are greater than those for which joint sealants historically have been designed. (Morian, 1999).

“The primary purposes of joint sealants in joint concrete pavements are to minimize moisture infiltration through the joints, to reduce moisture-related distress (such as pumping), and to prevent the intrusion of incompressible material into joints to minimize pressure-related distress (such as spalling)”, (Woo Lee, 2003). There is much controversy over whether or not this statement is true. Many researchers have looked into the performance of joint sealants such as LTPP and although there was little evidence that the unsealed sections had more joint faulting than the sealed sections, there was more faulting and higher rates of IRI. The indication was that “how well a section was sealed is a large factor in the performance of the sealant”

Joint openings caused by temperature changes and drying shrinkage of Portland Cement Concrete (PCC) are estimated based on ΔL , (AASHTO, 1993). Discussion looked at the values for C, the adjustment factor due to subbase/slab friction restraint. Minkarah et al. (1982) and Poblete et al. (1988), recommended a value of C equal to 1.0 for treated and untreated subbases. A number of researchers have shown discrepancies between in situ joint openings and the AASHTO prediction, (Minkarah et al. 1982; Poblete et al. 1988; Bodocsi et al. 1993; Morian et al. 1999). The Lee-Stoeffels model was developed for the prediction of the probability of the magnitude of joint opening by accounting for joint freezing and transverse cracking, used the LTPP sites. This model is not applicable to estimate joint opening for new joint concrete pavements.

Analysis of joint movement data from the LTPP Seasonal Monitoring Program (SMP) sites showed that 45 percent of the joints experienced larger openings than AASHTO

predictions, and 30 percent of the joints were frozen. The use of the temperature as the maximum annual temperature is conservative and is considered as the design temperature range. Conclusions are that discrepancy was observed between maximum joint opening estimated by the AASHTO method and the observed opening. Sealant damage is influenced by erratic large opening that cannot be predicted by the AASHTO method. The results of the resealing design indicated that some sites do not need resealing, whereas the other sites need to change future sealant type to permit larger sealant elongation. (Woo Lee, 2003).

2.9. Supplemental Sealant Information and Guidelines

2.9.1 The Use and Effects of the Hot-Air Lance

A study was commissioned to look at the use of the hot-air lance (HAL) and when its use is most effective, (Masson, 1999). A laboratory and field study were commissioned to assess effectiveness in the laboratory 24 test conditions were evaluated, including speeds and lance heights. Once the sealants were placed a small-scale tensile test was prepared. The test was conducted at -37°C at a rate of 10mm/min to assess the adhesion strength. Full-scale tensile tests were also conducted using 3 year old Asphalt Concrete (AC). The testing machine subjected the sealants to shear, tensile and compressive movements, this apparatus was also located in a cold room which permitted the cyclic movement as well as the temperatures as low as -40°C .

Results from the field showed that the HAL heated the rout up to 220°C but after 1 minute the temperature had returned to approximately 30°C . The estimated time between the HAL and the sealing is 1-5 minutes so the HAL therefore cannot promote sealant adhesion.

Results from the laboratory showed that in the small-scale tests the HAL did not increase the adhesion of the sealant, but if the briquette was overheated the surface was damaged to a depth of about 1 mm and the adhesion strength of the sealant is reduced by 50 percent or more. During the full-scale tests, without any heat treatment of the AC, there was a significant difference between the capacity of sealants to follow crack openings in

low temperatures without debonding. The results indicated that the HAL exerted little influence on sealant adhesion, but it also accelerated debonding when the sealant could accommodate little movement.

It was concluded that the HAL did not oxidize bitumen, but it may age and embrittle its surface and when the rout is overheated, the bitumen, fines and small aggregate are blown off the surface. The overall conclusion was that the HAL must be used with much caution although it may be beneficial when sealing damp cracks, (Masson, 1999).

2.9.2 Literature Review of Wisconsin Sealing Policies

A study from Indiana looked at the act of sealing and resealing of joints and cracks as part of a pavement maintenance and restoration process, (Hand, 2000). Some Departments of Transportation (DOTs) such as Wisconsin have instituted a “no-seal” policy on new pavements and claims to have saved \$6,000,000 annually with no loss in pavement performance and with increased customer safety and convenience. A study was commissioned with these two questions leading the way:

- Does joint/crack sealing in any way improve the service life or serviceability of pavements (performance)?
- If sealing does improve performance, is it cost effective and in what situations?

In review of the literature on the effectiveness of joint and crack sealing, conflicting evidence came to light. Wisconsin concluded that it was not cost-effective for PCC pavements in their state, but the LTPP SPS-4 test sections showed that unsealed joints showed more joint deterioration than sealed sections. In regards to crack sealing of flexible pavements, most of the literature supported the idea that crack sealing will retard the deterioration of cracks and therefore extend pavement service life. However, the cost-effectiveness of crack sealing in terms of pavement performance is not substantiated by evidence, as well it was shown on LTPP SPS test sites crack sealing was only effective in specific climates.

The report concluded that although Wisconsin has adopted a no-seal policy, it was apparent that different climatic, subgrade, and drainage conditions may all have effects

on the performance of pavements with and without sealed joints and cracks. Further research was required to assess the cost-effectiveness of sealing and where a no-seal policy could be implemented.

2.9.3 Sealant Viscosity Study

Masson, (2000), assessed the failures at the crack sealant/asphalt interface and looked at microscopic filling of the voids in the interface by the sealant. It was determined that the sealant viscosity strongly affects the interlocking capacity. The theories about how the bond between the two develops and how they interact are described in detail and a comparison of different types of sealants and their ability to bond. Only two mechanisms can explain the adhesion of the sealant to the AC. Initially rapid adsorption, or wetting, of the AC surface by the sealant can occur, followed by the slow penetration of sealant into AC microvoids to provide interlocking. Adsorption is governed by the chemical interactions between sealant and AC and consequently it is sensitive to aggregate composition. Interlocking is controlled by sealant viscosity and thus by pouring temperature and sealant cooling rate.

2.9.4 National Guide to Sustainable Municipal Infrastructure

The National Guide to Sustainable Municipal Infrastructure has prepared Guidelines for Sealing and Filling Cracks in Asphalt Concrete Pavement, (Infraguide 2003). This is a best practice with guidelines for crack treatment in asphalt concrete based on Canadian experience. "If performed in an effective and timely manner, crack treatment can extend the life of AC pavements by two to five years." Crack treatments can only be effective and sealant durability extended after careful pavement and sealant selection, and sealant installation. Field trials do not predict long-term performance because performance is not linear in time, whereas sealant specifications only allow for the selection of materials with limited durability. The following definitions for crack sealing and crack filling are given in this guideline:

- Crack Sealing – an active crack is typically greater than 3 mm in width in the summer and 15-100 percent larger in the winter. Active cracks are routed to a predefined geometry, cleaned, and then sealed.
- Crack Filling – a crack that shows little, if any, movement over time. Typically less than 3 mm wide, less than one year old.

The guideline gives the following recommendations:

- Crack treatment is only cost effective when it delays pavement deterioration and extends pavement service life.
- Not treating cracks leads to increased maintenance costs, because deteriorated cracks are difficult to repair, and can lead to increased user costs.
- The extension in pavement service life is related to sealant durability. Sealants that show less than 10 percent debonding after three winters and less than 50 percent debonding after eight years, service life is said to be extended by at least two years (FHWA 1998; Hand et al., 2000).

3 Experimental Program

3.1 Introduction

Joint and crack sealing are two important maintenance practices carried out in Manitoba. Joints have traditionally been sealed to allow movement of the pavement slabs, as well as to prevent incompressible material and water from further damaging the pavement structure. The climate in Manitoba is one of the most extreme in North America, with winter temperatures lasting below -30°C for several weeks and conversely summer temperatures rise above $+30^{\circ}\text{C}$. Joint sealant failures are prevalent and are associated with pumping action during the thaw weakening period. Rigid pavement blowups are not uncommon due to joint locking or ingress of incompressible materials in pavement joints.

Standard specifications from the local transportation agencies state that typical concrete joints are sawn to a width of 10 mm. Given an average slab length of 5 m, the movement of the joint can be close to 4 mm between the winter and summer extremes. The seal plays an important part in keeping the water out of the underlying structure. In the spring time as the temperature warms up but the ground still remains frozen some of the greatest movement of the pavement slabs occurs and a sealant that can maintain a good bond to the pavement structure is very important. Many sealants that make it through the winter will fail in spring under the combined pressure from below and the large joint/crack widths.

3.2 Program Outline

Together with Manitoba Transportation and Government Services (MTGS), it was proposed to prepare a laboratory and field study to see if a laboratory test procedure could predict field performance for Manitoba climates. MTGS annual sealant program, seals 230,600 lineal/meters, placing about 150,000 kgs of sealant. The unit price is equal to $\$0.90/\text{kg}$ costing on average $\$150,000$ for the sealant and $\$450,000$ to deliver the program. MTGS seals mostly asphalt pavements with hot-pour sealants and for new concrete pavements has place pre-formed compression seals in very low quantities.

The laboratory tests were carried out in conjunction with a field trial conducted on the TransCanada Highway near Winnipeg shown in Figure 3.1. The field trial site was chosen based on the length of the site, the condition of the pavement and the homogeneous nature of the cracks. From previous field studies it was decided to place a 500 m test section for each sealant to ensure each section had a representative sample of cracks to evaluate. This study is looking primarily at the transverse cracks in each section although the longitudinal cracks were sealed as well. The site is on the TransCanada highway approximately 50 km east of Winnipeg and the highway is four lane divided. The sealants were placed in both the passing and travelling lanes in the east bound direction starting from the junction of PR#302 and travelling approximately 14 km east. The nine hot pour sealants were placed one after another with the middle 100 m providing the section that will be evaluated, only the first eight hot pour sealants are included in the laboratory testing program. The three cold pour sealants were placed at the end of the test section to avoid tracking and contamination with the other products. Cold pour products have a tendency to track and require a sand coating after placement prior to trafficking. The field trial placement data is listed in Table 3.1.

The pavement in this section was last repaved in 2000 and is in good condition. A history of the pavement in both the hot-pour and cold-pour sections is provided in Table 3.2. The width of the roadway that was sealed is on average 9.2 m wide including both the inside and outside shoulders. The roadway was initially built in 1955 and some sections were reconstructed in 1989.

TABLE 3.1: Field Trial Data

Sealant Name	Application Type	Length of Test Section (m)	Sealed Trans. Cracks (ln.m.)	Sealed Long. Cracks (ln.m.)	No. Trans. Cracks Eval.	Date Sealed	Air Temp (°C)	Pavement Temp. (°C)
F	Hot Applied	435	279	92	31	04-06-28	15	19
G	Hot Applied	456	313	150	32	04-06-28	16	19
E	Hot Applied	398	242	128	28	04-06-29	29	42
B	Hot Applied	331	221	128	30	04-07-05	14	22
D	Hot Applied	500	271	187	30	04-07-05	16	29
A	Hot Applied	373	275	167	38	04-07-05	16	29
C	Hot Applied	490	347	453	38	04-07-06	11	24
H	Hot Applied	345	227	280	30	04-07-06	23	39
HP9	Hot Applied	444	263	338	30	04-07-06	23	39
CP1	Cold Applied	618	269	403	30	04-07-07	13	16
CP2	Cold Applied	658	260	196	30	04-07-08	22	39
CP3	Cold Applied	641	274	199	30	04-07-07	26	41

TABLE 3.2: Pavement History of Crack Sealing Sections

	Hot-Pour Section	Cold-Pour Section
Type of Roadway	Expressway	Expressway
Length of Road Section	11.35 km	2.1 km
Width of Road	7.4 m	7.4 m
Outside Shoulder Width	2.5 m	2.5 m
Outside Paved Shoulder Width	0.8 m	0.8 m
Inside Shoulder Width	1.0 m	1.0 m
Inside Paved Shoulder Width	1.0 m	1.0 m
Surface Type	Bituminous	Bituminous
Year Paved	2000	2000
Surface Depth	100 mm	100 mm
Base 1 Type	Bituminous(BPM)	Bituminous(BPM)
Year Placed	1968	1989
Depth of Base 1	46 mm	46 mm
Base 2 Type	Bituminous(BPM)	Granular
Year Placed	1955	1955
Depth of Base 2	76 mm	76 mm
Base 3 Type	Granular	Granular
Depth of Base 3	330 mm	330 mm

Note BPM = Bituminous Pavement Mixture

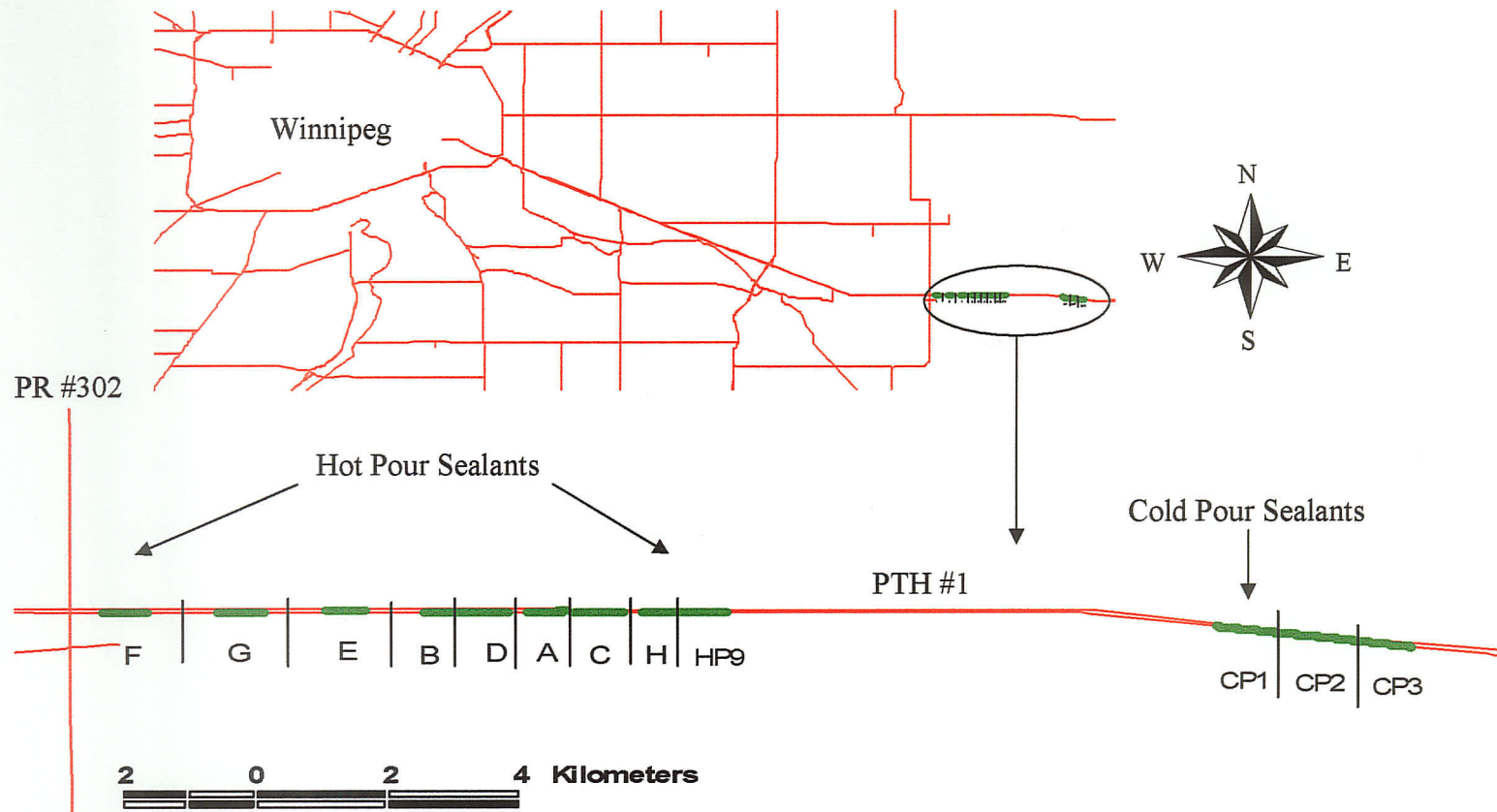

Legend

- Individual Sealant's Test Section
- MTGS Highway Network

Sealants

- A-F - Sealants included in the laboratory evaluation
- HP9 - Hot-pour sealant not included in the laboratory evaluation
- CP1-CP3 - Cold-pour sealants not included in the laboratory evaluation

FIGURE 3.1: 2004 Crack Sealant MTGS Field Trial Site

Prior to placement of the sealants, the roadway was evaluated based on MTGS Evaluation Methods for the Surfaced Roadway Network. The rating for cracking is summarized below including the rating assigned to this roadway.

Cracking – Cracking scores for each roadway segment represents the most predominant type of cracking present in that segment. The cracking score represents the average type of crack, as well as the amount of that type of crack occurring.

There are three types of crack severity reported:

- Slight (S) average width = less than 5 mm
- Moderate (M) average width = 5 mm to 10 mm
- Extreme (X) average width = greater than 10 mm

Each severity in turn is coupled with 1 of 4 possible extent identifiers to signify the quantity of the predominant cracking exhibited. The extent of cracking is categorized as:

- Rating of 0 = less than 1% by area
- Rating of 1 = greater than 1% and less than or equal to 6%
- Rating of 2 = greater than 6% and less than or equal to 15%
- Rating of 3 = greater than 15%

For Bituminous Expressways

Cracking Good 0, S0, S1, S2, M0, M1, X1

 Poor S3, M2, M3, X1, X2, X3

The average cracks on this site consist of small to medium cracks in the transverse direction. The majority of the cracks on this site were between 5 and 10 mm wide. The cracks were routed to the MTGS standard 3:1 width to depth ratio. A complete copy of the MTGS Evaluation Methods for the Surfaced Roadway Network can be found in APPENDIX A.

The research program included the evaluation of 12 commercially available products, nine hot-pour sealants and three cold-pour materials that were submitted by eight manufacturers. Table 3.3 lists the ingredients for each of the eight evaluated sealants and their compositions according to the manufacturer data sheets. The hot-pour sealants fall under Type I and Type IV according to ASTM D6690. Under ASTM specifications, Type I sealants, are tested at -18°C using 50 percent extension for 5 cycles, while Type IV, low-modulus sealants, are tested at -29°C using 200 percent extension for 3 cycles.

Table 3.4 lists the material properties of Type I sealants and Table 3.5 lists the material properties for Type IV sealants as per the datasheets received from each manufacturer. The two Type I sealants are labelled as Sealant A and Sealant B while the six Type IV sealants are labelled Sealants C to F. These sealants can be categorized into the four types listed below: (ASTM D6690)

- *Type I*—A joint and crack sealant capable of maintaining an effective seal in moderate climates. The material tested for low temperature performance at -18°C using 50 percent extension (formerly Specification D 1190).
- *Type II*—A joint and crack sealant capable of maintaining an effective seal in most climates. Material is tested for low temperature performance at -29°C using 50 percent extension (formerly Specification D 3405).
- *Type III*—A joint and crack sealant capable of maintaining an effective seal in most climates. Material is tested for low temperature performance at -29°C using 50 percent extension. Special tests are included (formerly Federal Spec SS-1401C).
- *Type IV*—A joint and crack sealant capable of maintaining an effective seal in climates experiencing very cold temperatures. Material is tested for low temperature performance at -29°C using 200 percent extension.

TABLE 3.3: Material Ingredients and Percentages for Each Sealant

Sealant	Material Ingredients	Percentage (A, B)	Specific gravity	Unit Weight
A	Residues (petroleum), vacuum	33-97%	1.0	
	Bitumens	60-100%		
	Mineral Oil	1-7%		
	Residual Oils	0-5%		
B	Process Oil	10-20%	1.2-1.3	
	Asphalt	40-50%		
	Synthetic Rubber	6-8%		
	Polymers - Reclaimed Tire Rubber	8-10%		
	Calcium Carbonate	25-40%		
C	Residues (petroleum), vacuum	33-97%	1.0	
	Bitumens	60-100%		
	Mineral Oil	1-7%		
	Residual Oils	0-5%		
D	Asphalt Cement		0.95-1.2	
	Reclaimed vulcanized rubber			
	Petroleum hydrocarbon mixture with butadiene-styrene co-polymer			
	Severely hydrotreated heavy naphthenic distillate			
	Heavy naphthenic distillate solvent extract			
E	Process Oil	10-20%	1.2-1.3	
	Asphalt	40-50%		
	Synthetic Rubber	6-8%		
	Polymers - Reclaimed Tire Rubber	8-10%		
	Calcium Carbonate	25-40%		
F	No Material Information Given			9 lbs. gallon (1.10kg/L)
G	No Material Information Given			9 lbs. gallon (1.10kg/L)
H	Asphalt	40-95%	1.0-1.7	9.6 lbs.
	Vacuum Distillate	0-20%		(1.15 kg/L)
	Petroleum Distillate	0-20%		@ 6F (15.5C)
	Hydrotreated Heavy Napthenic Distillate	0-20%		
	Styrene-Butadiene Block Copolymer	0-15%		
	Ethylene-Butadiene Block Copolymer	0-15%		
	Vulcanized Rubber Compound	0-25%		
	Mineral Filler	0-50%		
	Polyester Fibers	0-10%		

A=Percentage by weight for Sealants B, E and H

B=Percentage by volume for Sealants A and C

TABLE 3.4 Material Properties for Type I Sealants as per manufacturer's datasheets

Sealant	Penetration (1/10 mm)	Flow (mm)	Bond (at -18°C)	Resilience (%)	Asphalt compatibility	Max. heating temp. (°C)	Application temp. (°C)
A	80	nil	Pass	N/A ¹	N/A	N/A	185-200
B	100	3 Max.	Pass	30%	Pass	204	188-199
Specification limits	90 Max.	5 Max.	Pass 5 cycles @ 50% ext.	N/A	Pass	N/A	N/A

¹ N/A = not available

TABLE 3.5 Material Properties for Type IV Sealants as per manufacturer's datasheets

Sealant	Penetration (1/10 mm)	Flow (mm)	Bond (at -29°C)	Resilience (%)	Asphalt compatibility	Max. heating temp. (°C)	Application temp. (°C)
C	103	nil	Pass	80%	Pass	N/A ¹	185-200
D	100-150	10	Pass	30-60%	Pass	204	193-204
E	130	3	N/A	30%	Pass	204	188-198
F	120	1	Pass	70%	Pass	200	170
G	120	3	Pass	54%	Pass	200	170
H	100-150	10	Pass	30-60%	Pass	210	193
Specification limits	90-150	3 Max.	Pass 3 cycles @ 200% ext.	60% Min.	Pass	N/A	N/A

¹ N/A = not available

Figures 3.2 to 3.7 display the placement of the sealants in the field and the steps followed. Figure 3.2 shows routing of the crack which for this research is 3:1 width to depth configuration. Figure 3.3 displays cleaning of the crack using an air blower and Figure 3.4 displays heating of the crack using a hot-air lance. These three activities take place prior to the sealing of the crack. Figure 3.5 displays the placement of the sealant using a wand and squeegee. Figures 3.6 and 3.7 show the final product, sealed with a slight overband.



FIGURE 3.2: Routing of Crack to a 3:1 configuration



FIGURE 3.3: Cleaning of the crack using an air blower



FIGURE 3.4: Heating of the crack using a hot-air lance



FIGURE 3.5: Sealant application using a wand and squeegee



FIGURE 3.6: Final sealed crack



FIGURE 3.7: Final Sealed crack across the entire road surface

From the research objectives the development of a test procedure for hot-poured sealants was laid out. Previous research conducted by Rogers (1998) and Al-Qadi (1999), have shown that fatigue testing of sealants is a better indication of sealants field performance. The goals of this research are to work with MTGS and develop a test methodology that can be carried out at a local laboratory.

A sealant that conforms to the ASTM test methods will not necessarily perform well in the field (Lynch 1998), therefore a cyclic loading test for local conditions was developed at The University of Manitoba. The test applies repeated compressive and tensile loading cycles to compare sealant performance. While it is desirable to conduct accelerated thermal cycling rather than mechanical (load) cycling, it is deemed too slow and not practical to adopt in general laboratory use.

3.3 Test setup and Sample Preparation

The test procedure was designed to provide an accelerated laboratory testing method for hot-pour sealants. This procedure could be used by local transportation agencies wishing to test new materials on the market. This set up does not directly replicate a specified number of years in the field but provides a fatigue test to compare sealants against one another. Eight hot-pour sealants were provided for the laboratory testing procedure and followed the testing plan outlined in Figure 3.8.

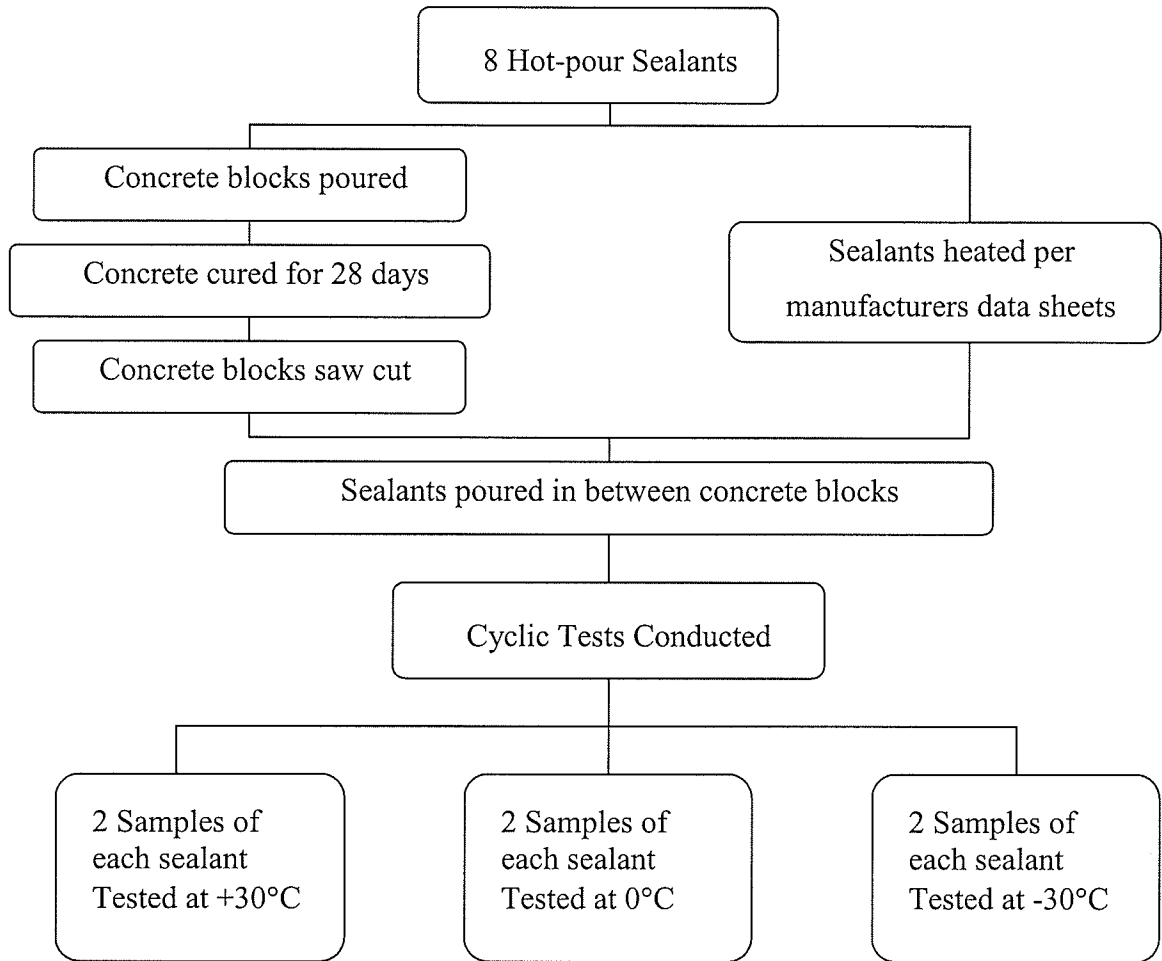

FIGURE 3.8: Testing Procedure

3.3.1 Specimen Preparation

The sample preparation consists of the placement of a 10 mm strip of sealant between two concrete blocks and applying a predetermined cyclic displacement at three temperatures; +30°C, 0°C and -30°C. A schematic of the concrete block, sealant specimen and bearing plates set up is shown in Figure 3.9. The blocks were cast with four anchor bolts per end to connect to the loading frame, as shown in Figures 3.10, 3.11 and 3.12. The aggregate used in the concrete was a mix of granite and river gravel, with a nominal aggregate size of 10 mm to allow the mix to flow around the bolts. The blocks, were allowed to cure after casting, until a minimum 28-day strength of 30 MPa was achieved. The blocks were saw-cut to simulate the surface of a typical concrete pavement joint. The sawn concrete blocks dimensions are 50 mm x 75 mm x 50 mm as shown in Figure 3.13. The concrete blocks were washed and allowed to dry to minimize the debris

left on the surface by the saw cut. The sealant was applied directly to the clean, dry surface.

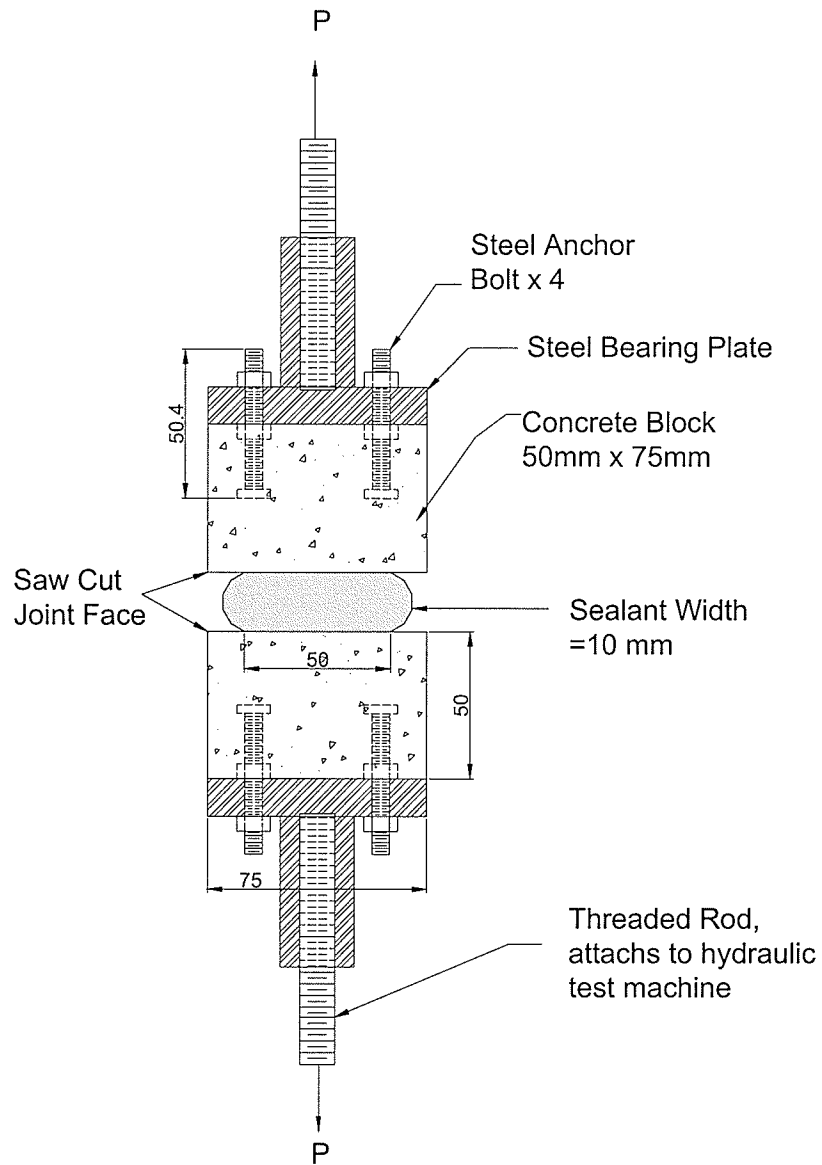

FIGURE 3.9 Concrete block, sealant specimen and bearing plates.

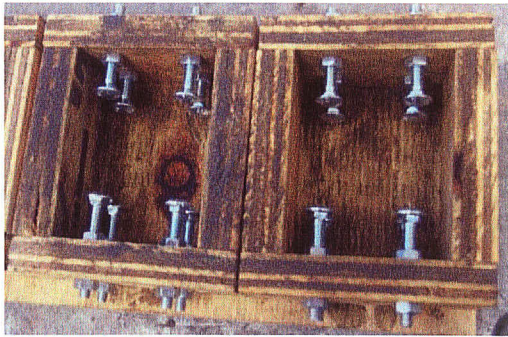

FIGURE 3.10: Formwork for concrete blocks with anchor bolts



FIGURE 3.11: Concrete blocks after pouring

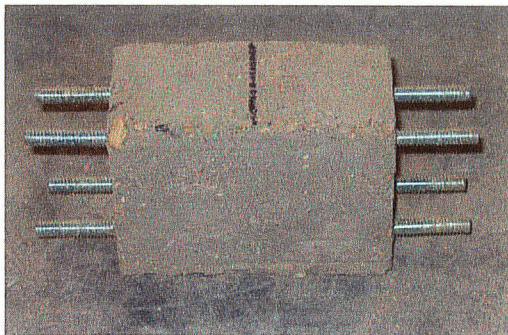

FIGURE 3.12: Concrete block prior to sawing, 100mm(w) x 75 mm (h) x 50 mm (d)

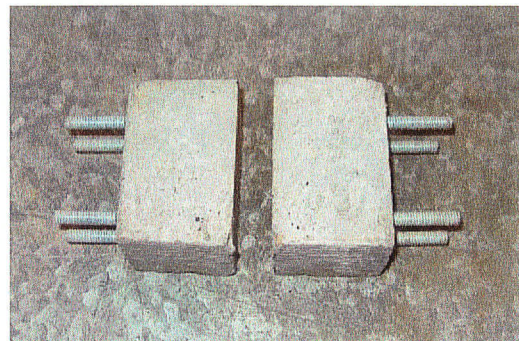

FIGURE 3.13: Sawn concrete block, 50mm(w) x 75 mm(h) x 50 mm(d)

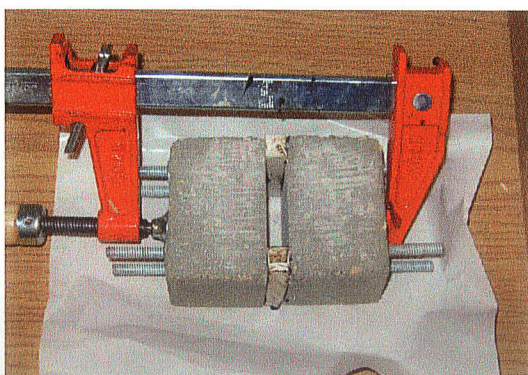

FIGURE 3.14: Spacers and clamp in place ready for sealant

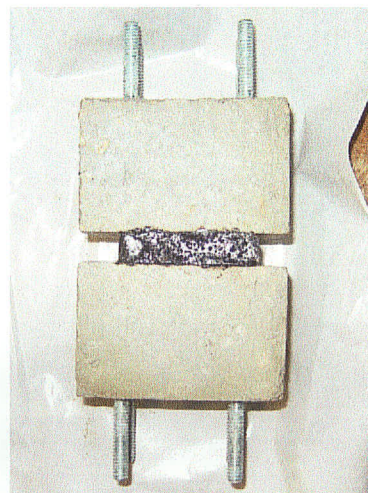

FIGURE 3.15: Finished product, sealant trimmed and ready for testing

Sealants are composed of bituminous and polymer modified materials. Some segregation may occur during the manufacturing process due to the use of the various fillers with differing specific gravities. When sealants are sampled in the laboratory the sealant must be cut from the block supplied by the manufacturers from the top to the bottom to ensure that all the material components in the sealant were in every pour. Each sealant was then heated in a double jacketed oil melter until the pouring temperature specified by the manufacturer was reached, in the range of 170°C to 204°C. After the specified temperature was reached the sealants were poured in between the two concrete blocks with spacers on either side keeping the sealant from flowing out the sides and maintaining the 10 mm width, Figure 3.14. Each sealant had their own consistency during the pour, some sealants were extremely soft and leaked out the bottom of the reservoir. The excess sealant was trimmed, being careful not to pull the sealant from the blocks. The finished sealant sample size is 50mm x 50mm x 10mm, shown in Figure 3.15. The specimen were allowed to cool for several days before being mounted in a hydraulic loading frame equipped with an environmental chamber, Figure 3.16. Sealant widths varied from 9.5 to 11 mm in width, this was shown to not be a problem amongst each sealant as the recorded stress values were consistently within 15 percent of each other.

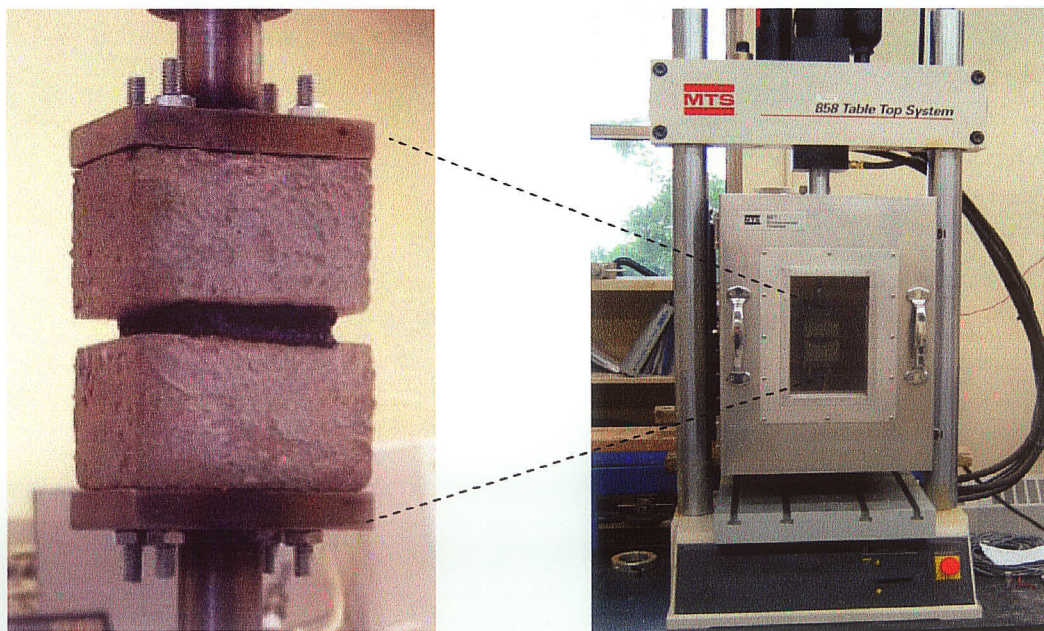

FIGURE 3.16 Specimen mounted in loading frame.

3.3.2 Cyclic Test Setup

The fatigue test setup involved the use of a MTS 858 Table Top loading frame shown in Figure 3.16. Using the bolts precast into the concrete blocks, the test specimen was bolted to the steel bearing plates which then threaded into the loading frame. An environmental chamber was used to condition the sample as well to maintain the temperature during the test. The loads and displacements were recorded during the entire test using LabVIEW® software and a data acquisition system. The MTS setup with environmental chamber is shown in Figure 3.16 and the data acquisition system is shown in Figure 3.17.

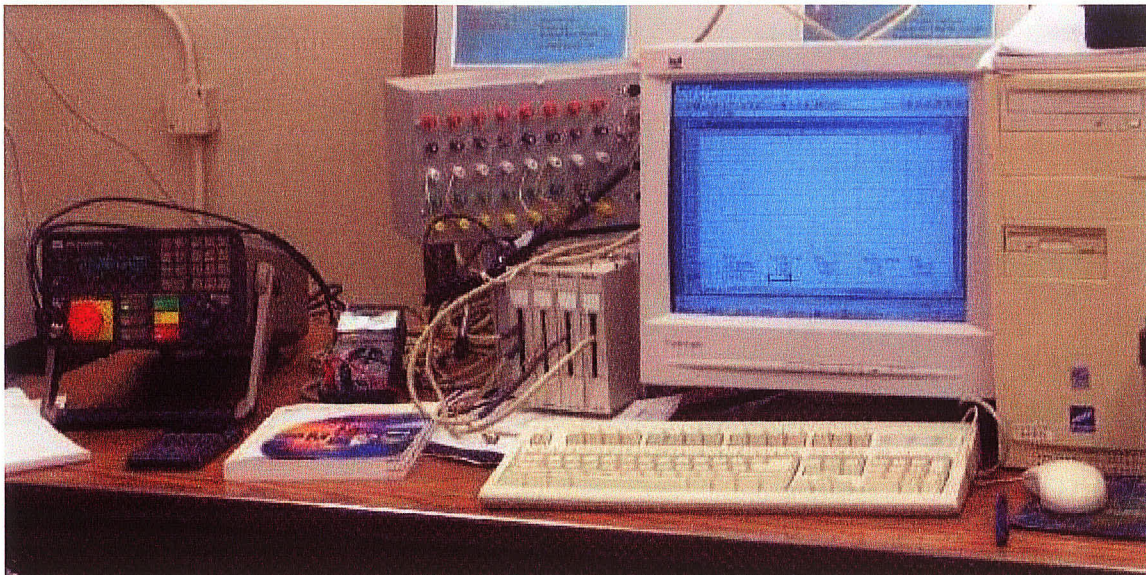

FIGURE 3.17: Load form generator and data acquisition system

3.3.3 Test Procedure

The fatigue test was performed on each of the eight hot-pour sealants, in order to simulate Manitoba's climate extremes the test was proposed to be run at three temperatures +30°C, 0°C, and -30°C. At each temperature the sample was conditioned for up to one hour to ensure isothermal conditions across the sample. A thermocouple was placed into a dummy sample at each temperature to record the temperature as the test was run to ensure that the temperature was being maintained at $\pm 1^\circ\text{C}$. The laboratory program schedule for each sealant can be found in APPENDIX B.

Joint movement of the pavement structure is predicted based on the AASHTO Guide for the Design of Pavement Structures, (1993). Joint movements in pavements are influenced by factors such as slab length, volume change characteristics of the concrete, slab temperature range, and friction between the slab and subbase (or subgrade). For design purposes, the mean transverse joint opening over a time interval can be computed approximately by Equation 3.1, (AASHTO, 1993 and Huang, 1993).

$$\Delta L = CL(\alpha_c \times DT_D + Z) \quad (3.1)$$

Where

- ΔL = the joint opening caused by temperature changes and drying shrinkage of the PCC, in.,
- α_c = the thermal coefficient of contraction of Portland cement concrete, °F,
- Z = the drying shrinkage coefficient of the PCC slab, which can be neglected for a resealing project, in./in.,
- L = joint spacing, in.,
- DT_D = the temperature range, °F, and
- C = the adjustment factor due to subbase/slab friction restraint. Use 0.65 for stabilized subbase, 0.8 for granular base.

AASHTO joint movement prediction equation is based on temperature extremes identified from the associated LTPP seasonal data (Morian, 1999). In Manitoba these extremes are -40°C to +30°C, a range of 70°C. The factors for Southern Manitoba:

- L = 5.5 m
- α_c = 9 to 10.8 x 10⁻⁶/°C
- Z = 0.5 to 2.5 x 10⁻⁴
- DT_D = 70°C
- ΔL = 3.00 mm – 4.43 mm

Based on the above factors for Southern Manitoba it was decided to subject the blocks to extension and compression. Each test was run using displacement control in a sinusoidal wave form, with the blocks subjected to plus and minus 2 mm displacement, shown in Figure 3.18. The sealant was loaded uniformly to minimize the torsion of the sample and the load and displacement values were recorded by the data acquisition system.

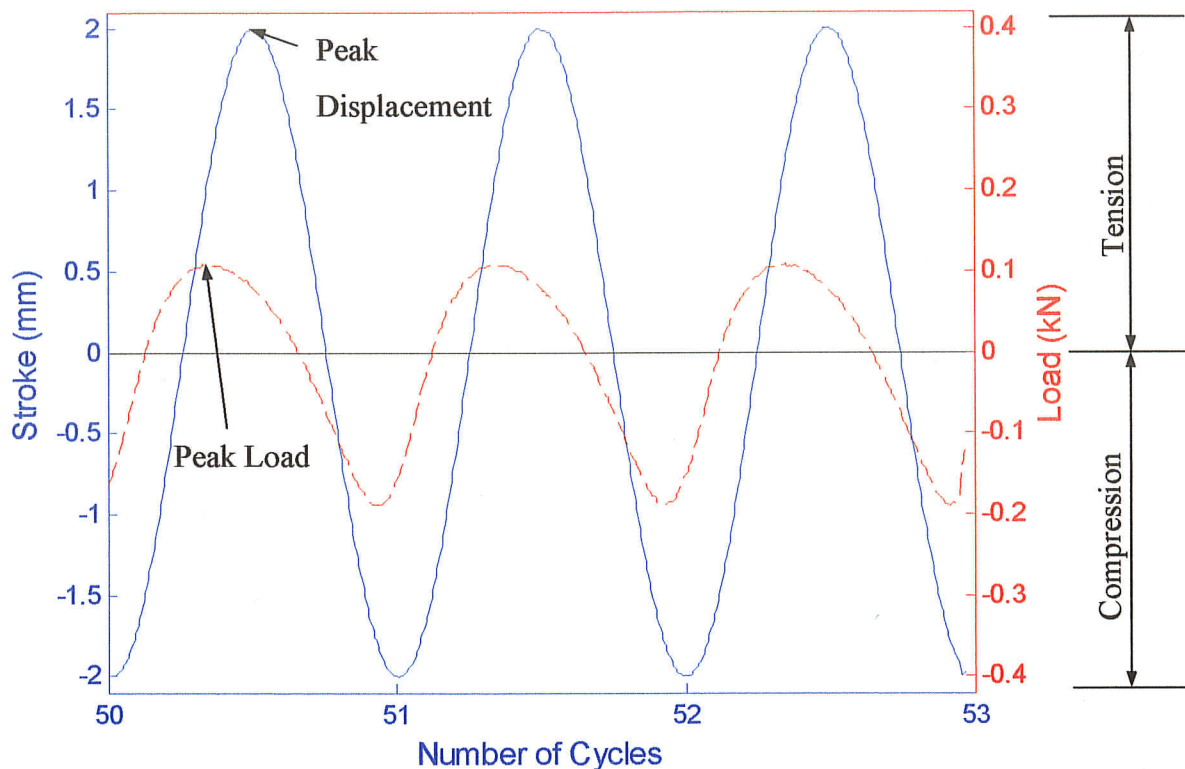

FIGURE 3.18: Typical load and stroke versus number of cycles conducted at +30°C and 1Hz frequency.

3.4 Testing Procedures

3.4.1 +30°C Testing

The environmental chamber was equipped with a heater to ensure that the test sample remained at the desired test temperature during the entire test. This chamber maintained the test temperature at +30°C ± 1°C. The samples were loaded using plus and minus 2 mm extension controlled loading at 1 Hz frequency for 25000 cycles which was completed in one work day. Two samples of each sealant were tested to confirm the test results. In cases where a significant variation was found (> 15%), a third sample was tested and the two closest results were retained.

3.4.2 0°C Testing

This test required the use of liquid nitrogen to lower the temperature to 0°C. Each sealant was conditioned for up to one hour prior to the start of the test. The samples were loaded using plus and minus 2 mm extension controlled loading at 1 Hz frequency for 5000 cycles. The number of cycles was modified to run 5000 cycles as it was realized that more than 50 percent load drop had already occurred for all the samples.

3.4.3 -30°C Testing

This test required the use of liquid nitrogen to lower the temperature to -30°C. Each sealant was conditioned for up to one hour prior to the start of the test. The samples were loaded using plus and minus 2 mm extension controlled loading at 0.003 Hz frequency for maximum 25 cycles. The extension remained the same but after a number of catastrophic failures of both the concrete and the sealant, the frequency and duration of the test were lowered to 0.003 Hz and a maximum of 25 cycles.

4 Laboratory Test Results

This chapter presents the results from the fatigue test conducted in this study. There were 8 hot pour sealants tested in this study at three in service temperatures. Two specimens from each sealant were tested at each temperature +30°C, 0°C and -30°C, making a total of 48 specimens tested.

4.1 Fatigue Test

This test subjected the concrete blocks to plus and minus 2 mm tensile and compressive displacement while recording the load. The results have been analyzed to give the normal stress in KPa versus the number of cycles. The normal stress was calculated by dividing the load by the theoretical cross-sectional area of the sealant, which for each sample was 50 mm by 50 mm. The data acquisition machine was set to record 200 points a second to capture the maximum and minimum results. A summary of the results from each temperature are presented initially followed by the sealants' individual outcomes. The results are listed in order of the sealants which are then further separated by each test temperature.

4.2 Summary of Results

The consistency of the data shows that this test is repeatable. At the +30°C temperature only three of the sixteen tests had initial stress value differences greater than 15 percent and in fact the majority of the results were less than 10 percent different. At 0°C and -30°C the number of tests with an initial stress value differences greater than 15 percent increased to 6 and 5 of the 16 tests respectively. These inconsistencies can be attributed to variation of the sealant material within the sealant blocks as well the aging of the sealants during the heating process.

A summary of the initial and final stress results for the sealants at +30°C are listed Table 4.1. Table 4.2 displays the summary of the initial and final stress results from 0°C, sealants A, B, and C showed greater than 80 percent load drop in both tension and compression. Sealants A and B were shown to be much stiffer sealants recording tensile

stresses higher than 450 KPa. This was also shown in the results that Sealants A and B experienced adhesion failure at 0°C. At the -30°C test temperature, see table 4.3, five of the eight hot pour sealants failed in adhesion prior to the end of the 25 cycles and proved to be a good indication that at the modified loading rate the results differentiated between the sealants. Sealant H showed adhesion failure in only one sample, with the remaining four of the five failed sealants showing complete adhesion failure during both tests. For this research adhesion failure is defined as debonding of the sealant from the concrete block face.

Table 4.4 shows the average results for each sealant in tension and compression. Sealants A and B had average initial stress values of 67.79 KPa and 61.6 KPa at +30°C, these values are considerably different from the values shown by the low modulus sealants C-H. Sealants C-H at +30°C showed initial average results of 55 KPa down to 37.63 KPa all results lower than the Type I sealants. All 8 hot pour sealants evaluated showed significantly higher values in compression than tension. In compression the maximum value of -134 KPa was shown by Sealant A and the values ranged to -56.14 KPa shown by Sealant H. Compared to the values of 67.79 KPa felt by Sealant A in tension this is approximately a 50 percent increase. The lower values realized by the Type IV sealants kept this value lower than 50 percent due to their increased ability to dissipate stresses realized from the repeated extension and compression of the test.

At 0°C the average initial values jump to a high of 568.1 KPa for Sealant A an increase of 500 KPa by lowering the temperature 30°C. Similar to the +30°C data the Type I sealants showed much higher values than the Type IV (low modulus) sealants. The range in the low modulus sealants was 423.02 KPa to 189.76 KPa versus the 475.32 KPa to 568.1 KPa range of the Type I sealants. In compression the Type I sealants initial values started at greater than 1500 KPa and were reduced at the end of the test by greater than 80 percent. Both the Type I sealants experienced adhesion failure during both of the trials conducted at the 0°C temperature. No adhesion failure was realized in any of the Type IV sealants at this temperature. The initial compressive stresses were all in the range of -350 KPa to a high of -956.47 KPa.

TABLE 4.1: Stresses and Percent Stress Drop at +30°C

Sealant		Initial Stress (KPa)	Final Stress (KPa)	Percent Stress Drop
A	Stress T1	69.92	15.17	78.31
	Stress T2	65.66	15.50	76.39
	%Difference	6.09	2.19	
	Stress C1	-141.63	-25.48	82.01
	Stress C2	-127.05	-27.15	78.63
	%Difference	10.29	6.54	
B	Stress T1	57.97	10.56	81.78
	Stress T2	65.23	12.55	80.77
	%Difference	12.53	18.80	
	Stress C1	-99.30	-15.23	84.67
	Stress C2	-126.37	-15.53	87.71
	%Difference	27.26	2.00	
C	Stress T1	56.75	13.72	75.82
	Stress T2	51.52	14.06	72.70
	%Difference	9.22	2.48	
	Stress C1	-101.08	-20.82	79.40
	Stress C2	-88.31	-22.04	75.04
	%Difference	12.64	5.84	
D	Stress T1	52.45	25.76	50.88
	Stress T2	54.92	22.38	59.24
	%Difference	4.70	13.11	
	Stress C1	-95.06	-50.66	46.71
	Stress C2	-95.61	-45.18	52.74
	%Difference	0.58	10.80	
E	Stress T1	43.94	22.38	49.06
	Stress T2	42.93	19.00	55.73
	%Difference	2.31	15.10	
	Stress C1	-79.26	-45.18	42.99
	Stress C2	-75.95	-40.57	46.59
	%Difference	4.17	10.22	
F	Stress T1	43.24	30.23	30.10
	Stress T2	46.74	27.50	41.17
	%Difference	8.08	9.03	
	Stress C1	-75.73	-54.58	27.93
	Stress C2	-82.06	-53.22	35.14
	%Difference	8.36	2.49	
G	Stress T1	44.59	31.15	30.15
	Stress T2	45.36	30.40	32.97
	%Difference	1.72	2.39	
	Stress C1	-81.45	-58.76	27.86
	Stress C2	-78.90	-55.14	30.11
	%Difference	3.13	6.16	
H	Stress T1	31.72	20.40	35.69
	Stress T2	43.54	19.55	55.10
	%Difference	37.24	4.17	
	Stress C1	-45.59	-29.42	35.48
	Stress C2	-66.68	-33.29	50.07
	%Difference	46.24	13.16	

TABLE 4.2: Stresses and Percent Stress Drop at 0°C

Sealant		Initial Stress(KPa)	Final Stress(KPa)	Percent Load Drop
A	Stress T1	641.85	94.06	85.35a
	Stress T2	494.34	65.11	86.83a
	%Difference	22.98	30.78	
	Stress C1	-1882.90	-334.25	82.25
	Stress C2	-1880.40	-325.67	82.68
	%Difference	0.13	2.57	
B	Stress T1	458.59	79.86	82.59a
	Stress T2	492.04	47.56	90.34a
	%Difference	7.29	40.46	
	Stress C1	-1783.20	-194.34	89.10
	Stress C2	-1192.80	-148.52	87.55
	%Difference	33.11	23.58	
C	Stress T1	410.19	47.18	88.50
	Stress T2	435.83	63.82	85.36
	%Difference	6.25	35.25	
	Stress C1	-814.63	-86.48	89.38
	Stress C2	-1098.30	-96.25	91.24
	%Difference	34.82	11.29	
D	Stress T1	243.72	117.38	51.84
	Stress T2	276.89	101.11	63.49
	%Difference	13.61	13.86	
	Stress C1	-576.74	-237.54	58.81
	Stress C2	-628.87	-199.34	68.30
	%Difference	9.04	16.08	
E	Stress T1	176.28	81.21	53.93
	Stress T2	203.24	83.46	58.94
	%Difference	15.29	2.77	
	Stress C1	-347.71	-149.96	56.87
	Stress C2	-472.88	-182.81	61.34
	%Difference	36.00	21.91	
F	Stress T1	254.75	61.77	75.75
	Stress T2	262.64	92.81	64.66
	%Difference	3.10	50.26	
	Stress C1	-536.72	-160.97	70.01
	Stress C2	-622.98	-186.88	70.00
	%Difference	16.07	16.10	
G	Stress T1	164.19	79.50	51.58
	Stress T2	185.55	79.20	57.32
	%Difference	13.01	0.38	
	Stress C1	-331.11	-151.52	54.24
	Stress C2	-372.76	-169.21	54.61
	%Difference	12.58	11.68	
H	Stress T1	290.78	98.68	66.07
	Stress T2	236.53	94.32	60.13
	%Difference	18.66	4.42	
	Stress C1	-651.75	-193.83	70.26
	Stress C2	-460.34	-167.83	63.54
	%Difference	29.37	13.41	

^a Adhesion failure noted in these tests

TABLE 4.3: Stresses and Percent Stress Drop at -30°C

Sealant		Initial Stress(KPa)	Final Stress(KPa)	Percent Drop
A	Stress T1	1624.10	182.42	88.77a
	Stress T2	1713.60	230.75	86.53a
	%Difference	5.51	26.49	
	Stress C1	-5173.10	-3146.90	39.17
	Stress C2	-5102.50	-3610.80	29.24
	%Difference	1.36	14.74	
B	Stress T1	1126.40	156.52	86.10a
	Stress T2	1135.90	134.34	88.17a
	%Difference	0.84	14.17	
	Stress C1	-2328.20	-1265.50	45.65
	Stress C2	-2144.60	-1049.90	51.04
	%Difference	7.89	17.04	
C	Stress T1	1556.70	208.86	86.58a
	Stress T2	1446.60	140.16	90.31a
	%Difference	7.07	32.89	
	Stress C1	-4269.30	-2333.90	45.33
	Stress C2	-2896.00	-1782.00	38.47
	%Difference	32.17	23.65	
D	Stress T1	652.13	282.11	56.74
	Stress T2	567.31	286.55	49.49
	%Difference	13.01	1.57	
	Stress C1	-1185.60	-684.39	42.28
	Stress C2	-1099.10	-668.04	39.22
	%Difference	7.30	2.39	
E	Stress T1	470.40	249.61	46.94
	Stress T2	434.48	240.08	44.74
	%Difference	7.64	3.82	
	Stress C1	-821.86	-470.60	42.74
	Stress C2	-791.57	-454.35	42.60
	%Difference	3.69	3.45	
F	Stress T1	1614.70	428.43	73.47a
	Stress T2	1521.20	199.64	86.88a
	%Difference	5.79	53.40	
	Stress C1	-3160.70	-1755.10	44.47
	Stress C2	-3066.20	-1744.80	43.10
	%Difference	2.99	0.59	
G	Stress T1	948.78	400.53	57.78
	Stress T2	1194.20	427.89	64.17
	%Difference	25.87	6.83	
	Stress C1	-2116.10	-1401.10	33.79
	Stress C2	-2544.40	-1460.50	42.60
	%Difference	20.24	4.24	
H	Stress T1	1025.00	333.58	67.45
	Stress T2	1262.80	400.33	68.30a
	%Difference	23.20	20.01	
	Stress C1	-1962.60	-923.59	52.94
	Stress C2	-2605.50	-1440.30	44.72
	%Difference	32.76	55.95	

^a Adhesion failure noted in these tests

At -30°C the initial stress values jumped again to a high of 1668.85 KPa shown by Sealant A. Sealant B at this temperature was lower than Sealant C a difference of almost 400 KPa less. Sealants A to C all realized adhesion failure prior to the end of the test. This is not surprising due to the greater than 80 percent decrease in load from the start of the test to the end of the 25 cycles. The low modulus sealants also separated themselves at this temperature with some of the sealants maintaining a low initial stress value of less than 500 KPa while Sealants C, F, G and H displayed initial tensile results greater than 1000 KPa. In addition to Sealant C failing in adhesion Sealant F had both trials fail in adhesion and Sealant H had one trial fail partially in adhesion.

TABLE 4.4: Average Stress Values for each Sealant

Sealant		+30 Degrees		0 Degrees		-30 Degrees	
		Initial	Final	Initial	Final	Initial	Final
A	Average Tension	67.79	15.33	568.10	79.59	1668.85	206.59
	Average Compression	-134.34	-26.32	-1881.65	-329.96	-5137.80	-3378.85
B	Average Tension	61.60	11.55	475.32	63.71	1131.15	145.43
	Average Compression	-112.84	-15.38	-1488.00	-171.43	-2236.40	-1157.70
C	Average Tension	54.14	13.89	423.01	55.50	1501.65	174.51
	Average Compression	-94.69	-21.43	-956.47	-91.37	-3582.65	-2057.95
D	Average Tension	53.68	24.07	260.31	109.25	609.72	284.33
	Average Compression	-95.34	-47.92	-602.81	-218.44	-1142.35	-676.22
E	Average Tension	43.44	20.69	189.76	82.34	452.44	244.85
	Average Compression	-77.60	-42.87	-410.30	-166.39	-806.72	-462.48
F	Average Tension	44.99	28.86	258.70	77.29	1567.95	314.04
	Average Compression	-78.89	-53.90	-579.85	-173.93	-3113.45	-1749.95
G	Average Tension	44.97	30.78	174.87	79.35	1071.49	414.21
	Average Compression	-80.17	-56.95	-351.94	-160.37	-2330.25	-1430.80
H	Average Tension	37.63	19.98	263.66	96.50	1143.90	366.96
	Average Compression	-56.14	-31.36	-556.05	-180.83	-2284.05	-1181.95

Figures 4.1 to 4.3 display the average initial stress values for each sealant at the three in-service temperatures. It is clear from the figures that the Type I sealants, sealants A and B consistently have larger initial stress values than the Type IV sealants. At +30°C the Type I sealants display higher initial results than the Type IV sealants. At 0°C sealants A, B and C display higher initial stress results and at -30°C only sealants D and E maintain low initial stress values.

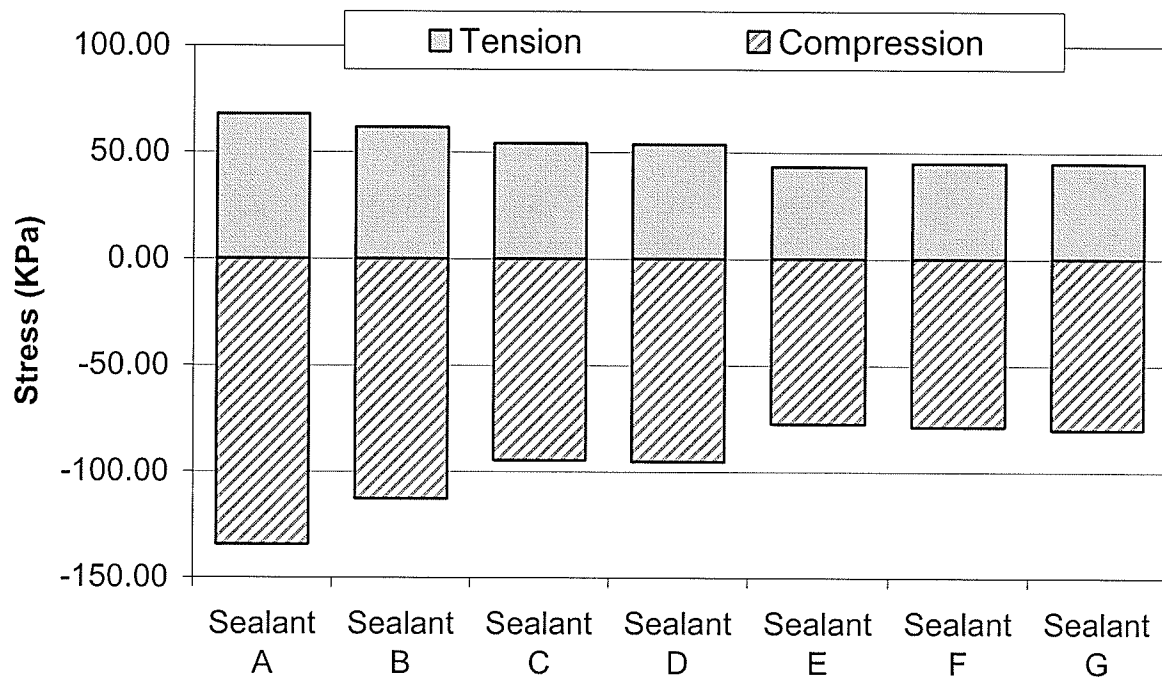

FIGURE 4.1: Average Initial Stress Values at +30°C

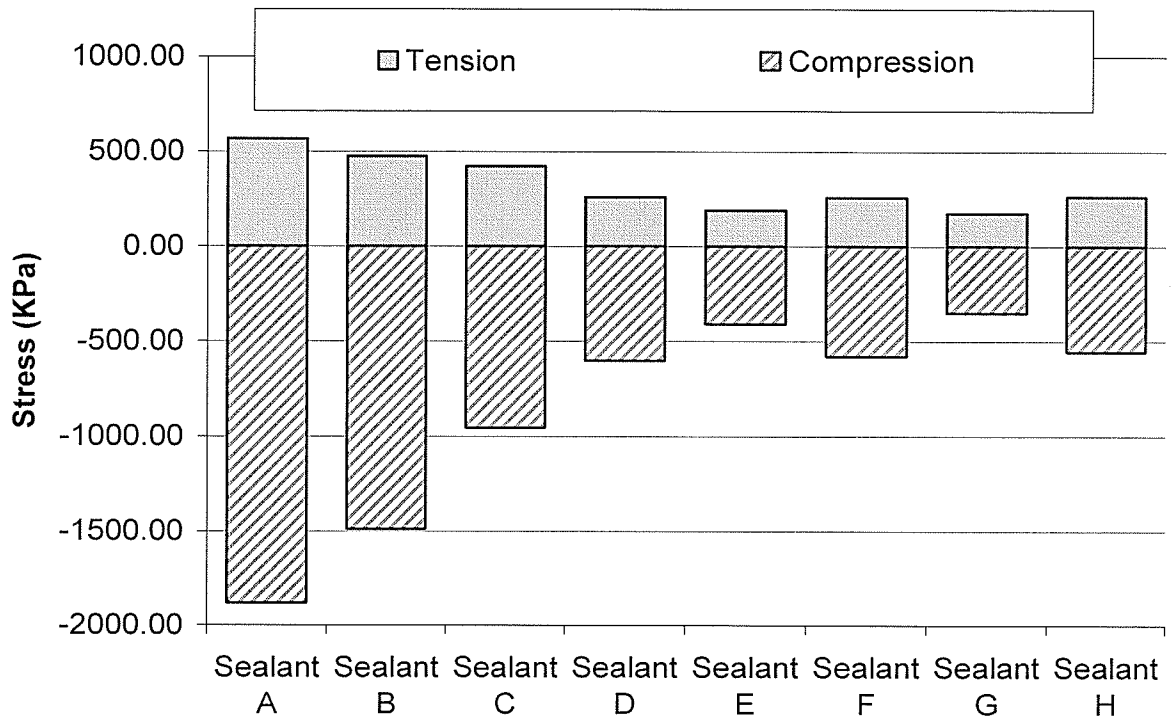

FIGURE 4.2: Average Initial Stress Values at 0°C

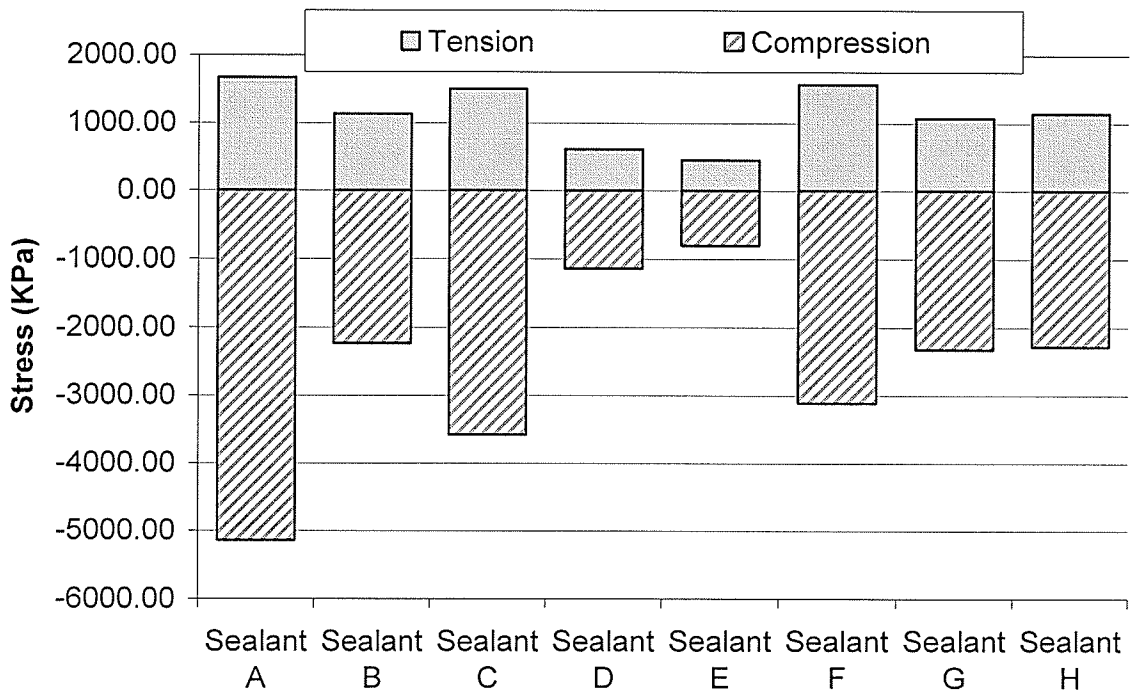

FIGURE 4.3: Average Initial Stress Values at -30°C

4.3 Individual Sealant Results

4.3.1 Sealant A Results

The results for Sealant A, a Type I sealant are shown in Figures 4.4 to 4.6. Figure 4.4 shows the results of the +30°C testing. This figure shows the consistency of these two tests, in tension the initial stress values vary by 6 percent and in compression the results were 10.29 percent different. Figure 4.4 shows Test 1, the solid line, displaying a consistently declining rate ending with approximately the same value as Test 2, the dotted line. Test 2 shows a sudden drop in load at about 450 cycles, this was attributed to the sealants inability to resist the cyclic loading.

Figure 4.5 displays the 0°C results for Sealant A. The initial tensile stress values are greater than 500 KPa for both tests and the initial compressive stresses are greater than 1800 KPa. The two initial stress results for Sealant A at 0°C were not within 15 percent, although within 10 cycles the values were much closer and at 100 cycles the results were almost identical. Both tests show a percent drop in load of greater than 85 percent and at approximately one hundred cycles experience adhesion failure.

Figure 4.6 displays the results from the -30°C testing for Sealant A. The initial stress values were greater than 1500 KPa in tension and greater than 5100 KPa in compression. The sealants experienced adhesion failure during the first cycle as they were extended towards the plus 2 mm mark. Test 1 was stopped after 6 cycles experiencing an 86 percent drop in load in tension and Test 2 was allowed to continue for 16 cycles, finally ending with an 88 percent load drop. This sealant did not perform well at any of the test temperatures. The sealant experienced adhesion failure at two of the test temperatures as well a sudden drop in load was experience at the +30°C temperature. The adhesion failure for Sealant A is shown in Figure 4.7. The sealant completely debonded from the concrete joint face and the sealant retained its initial shape.

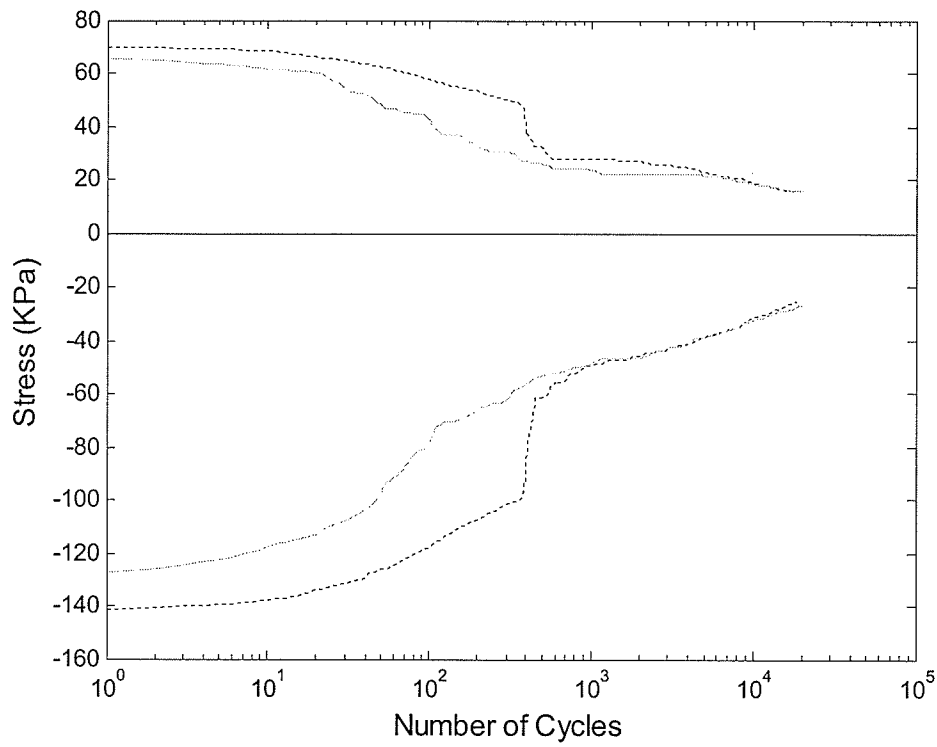

FIGURE 4.4 Sealant A Stress vs. Number of Cycles (+30°C)

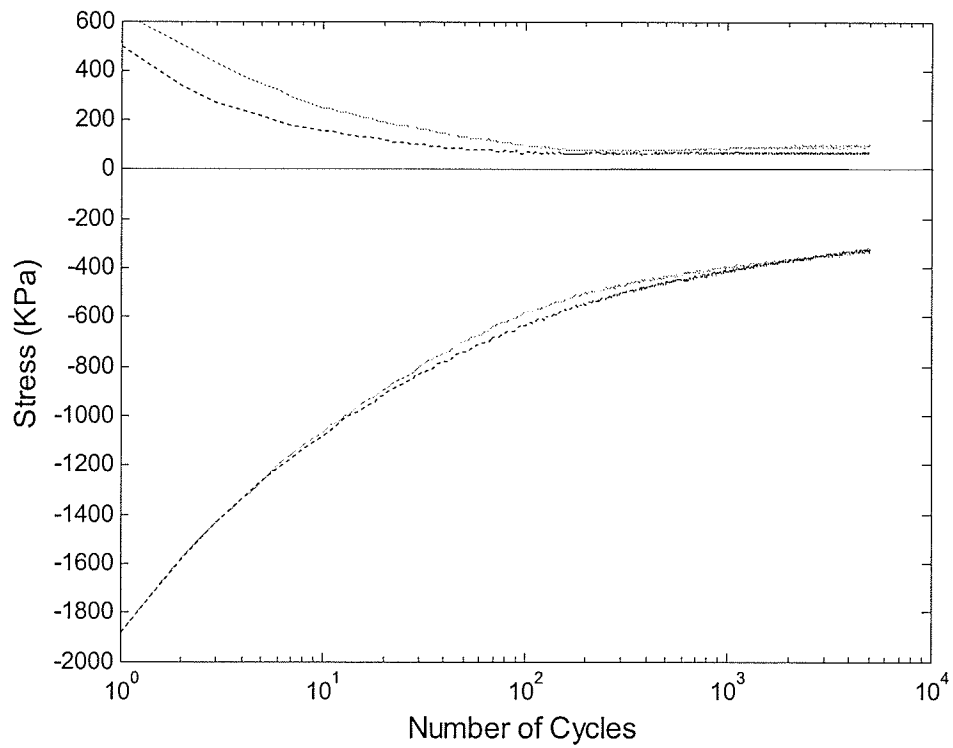

FIGURE 4.5 Sealant A Stress vs. Number of Cycles (0°C)

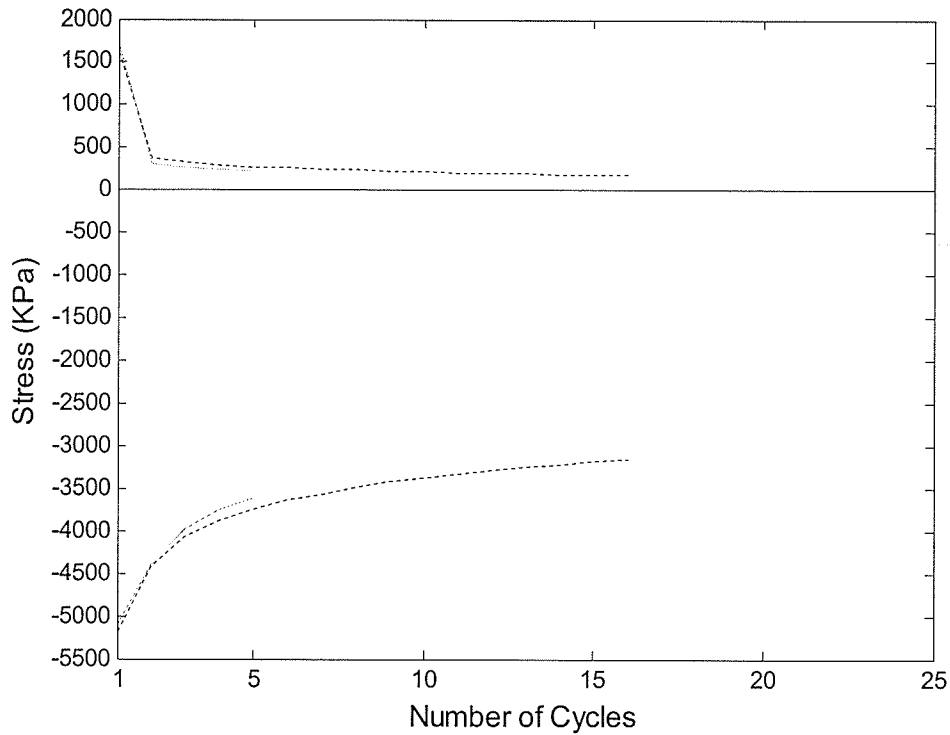

FIGURE 4.6: Sealant A Stress vs. Number of Cycles (-30°C)

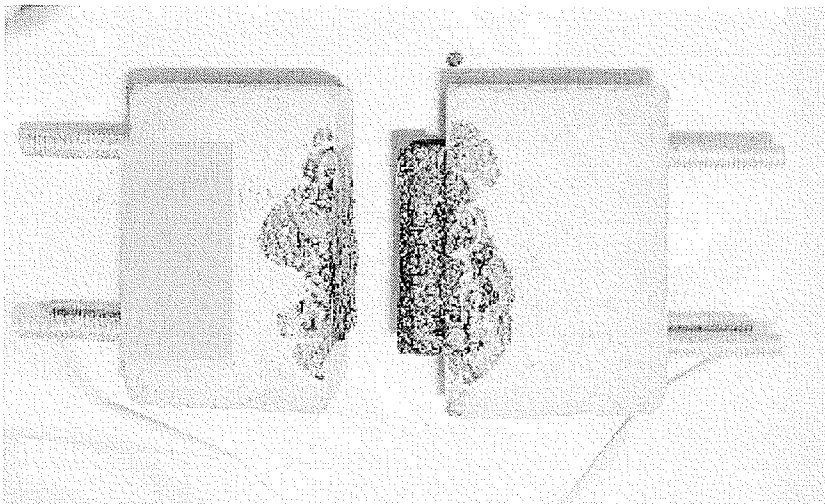

FIGURE 4.7: Adhesion failure for Sealant A

4.3.2 Sealant B Results

Figures 4.8 to 4.10 show the results of Sealant B, also a Type I sealant. Figure 4.8 displays the results from the +30°C test temperature. The initial stress values in tension were similar ranging from 58 KPa to 65 KPa. In compression there was a slightly higher difference and this is attributed to the material properties of the sealant. Type I sealants

are generally composed of synthetic rubbers, and stabilizing fillers and compatible asphalt, these components in a Type I sealant can make the product very stiff and as well the consistency of the product in each sample may not be exactly the same. The trends shown by Sealant B are consistent at this temperature and after 1000 cycles the rate of stress dissipation increases.

Figure 4.9 displays the results from the 0°C tests for Sealant B. These results are similar to Figure 4.8, the initial stress values in tension are similar with a significant difference in the compressive values. The trends are similar between Test 1 and Test 2 and at the end of the test both tests suffered adhesion failure and this is reflected in the greater than 80 percent drop in stress from the initial values to the final values.

In Figure 4.10 the results from the -30°C tests are displayed. In tension the initial stress values are within 1 percent of each test result. Adhesion failure occurred within the first few cycles although both tests were continued for another 10 cycles to allow comparison of the results. The results in compression show less than 10 percent difference between the two tests. This sealant failed in adhesion at both the cold temperatures as well during the +30°C test an 80 percent load drop was experienced. This sealant is not recommended for cold temperature use, the results indicate that the sealant is very stiff at even 0°C and is not expected to perform well under significant joint movements.

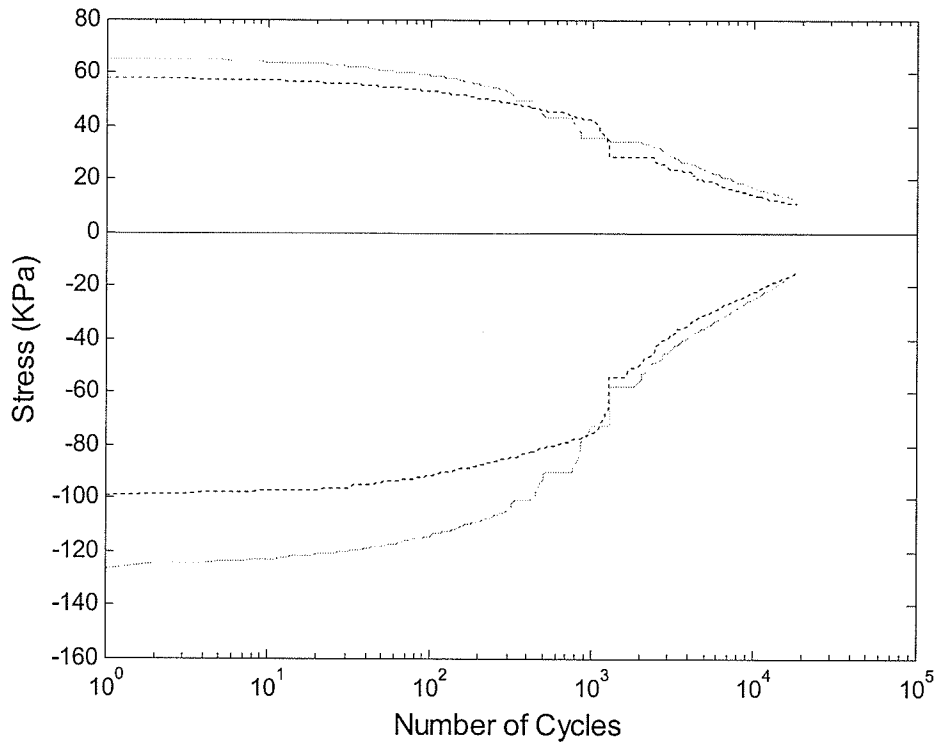

FIGURE 4.8 Sealant B Stress vs. Number of Cycles (+30°C)

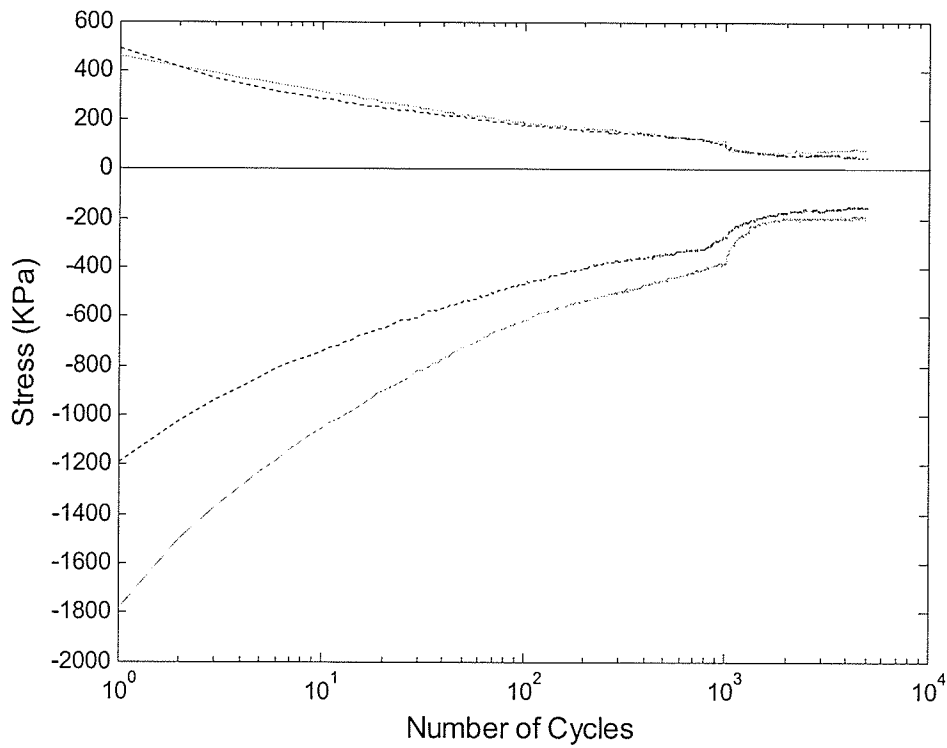

FIGURE 4.9: Sealant B Stress vs. Number of Cycles (0°C)

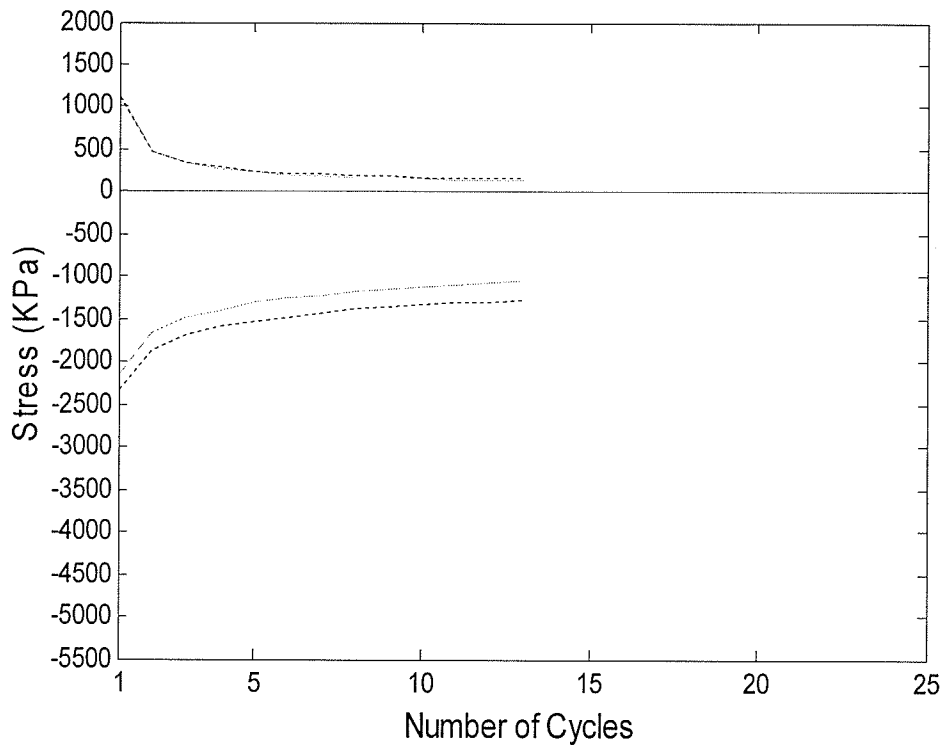

FIGURE 4.10 Sealant B Stress vs. Number of Cycles (-30°C)

4.3.3 Sealant C Results

Figures 4.11 to 4.13 display the results for Sealant C the first of the Type IV sealants. These sealants according to ASTM D6690 are joint and crack sealants capable of maintaining an effective seal in climates experiencing very cold temperatures. Figure 4.11 highlights the results from the +30°C tests. The results for both tests were consistent, showing a sudden drop in resistance between 800 and 1100 cycles.

Figures 4.12 and 4.13 highlight the results from the 0°C and -30°C tests for Sealant C respectively. In tension both sets of results were within 10 percent but in compression the initial compressive values differed by 32 to 35 percent. The fillers in the sealant can be the reason for this discrepancy, because although they provide little tensile strength they impact the compressive resistance. Rubber fillers can impact the compressive strength during the testing phase as they are stiffer than the surrounding materials, if more rubber fillers are in one test block then a significant increase in compressive stress can be realized. The fillers can adversely affect the tension as they decrease the surface

area adhesion of the sealant to the concrete block. No adhesion failure was noted during the 0°C testing but the sealant underwent a greater than 85 percent drop in resistance to load. At the -30°C test temperature adhesion failure was noted within the first few cycles. In tension, the percent drop in resistance to load was greater than 85 percent. This sealant did not perform very well at cold temperatures. This sealant does not follow the general trends of the other Type IV sealants with lower initial stress values and fewer adhesion failures. The very high initial stress values were similar to the Type I sealant results and the adhesive failure at -30°C makes this sealant a poor candidate for Manitoba climates.

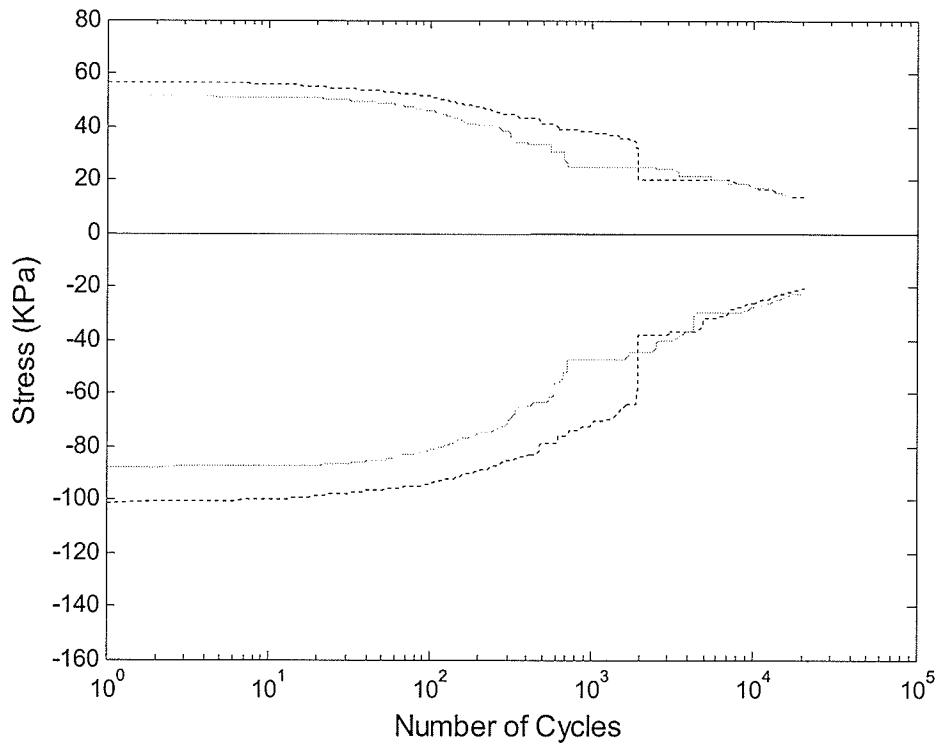

FIGURE 4.11 Sealant C Stress vs. Number of Cycles (+30°C)

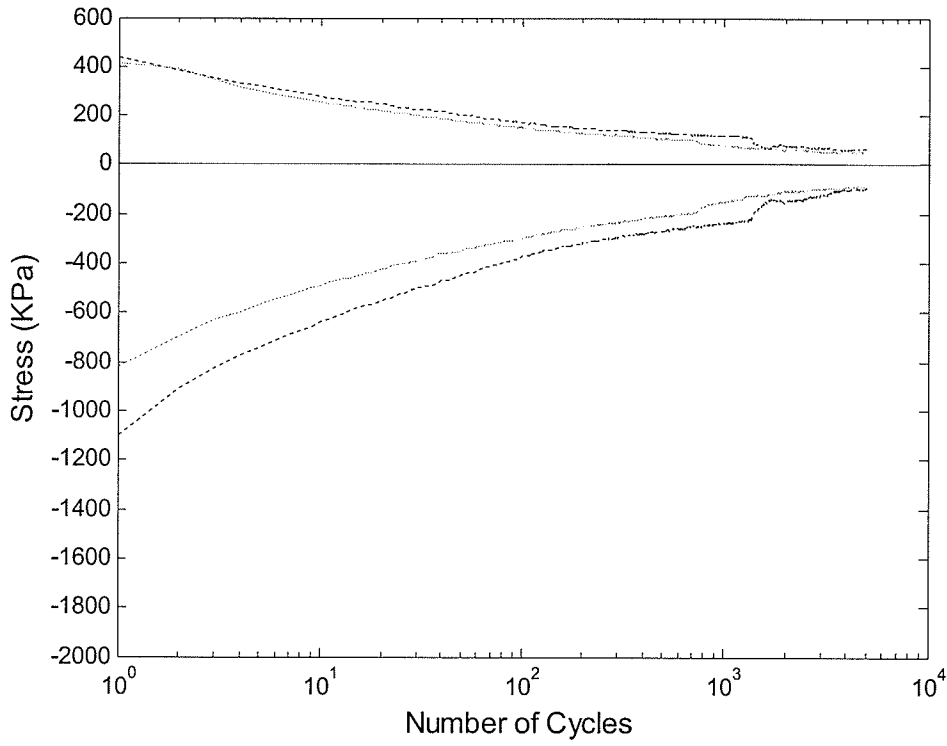

FIGURE 4.12 Sealant C Stress vs. Number of Cycles (0°C)

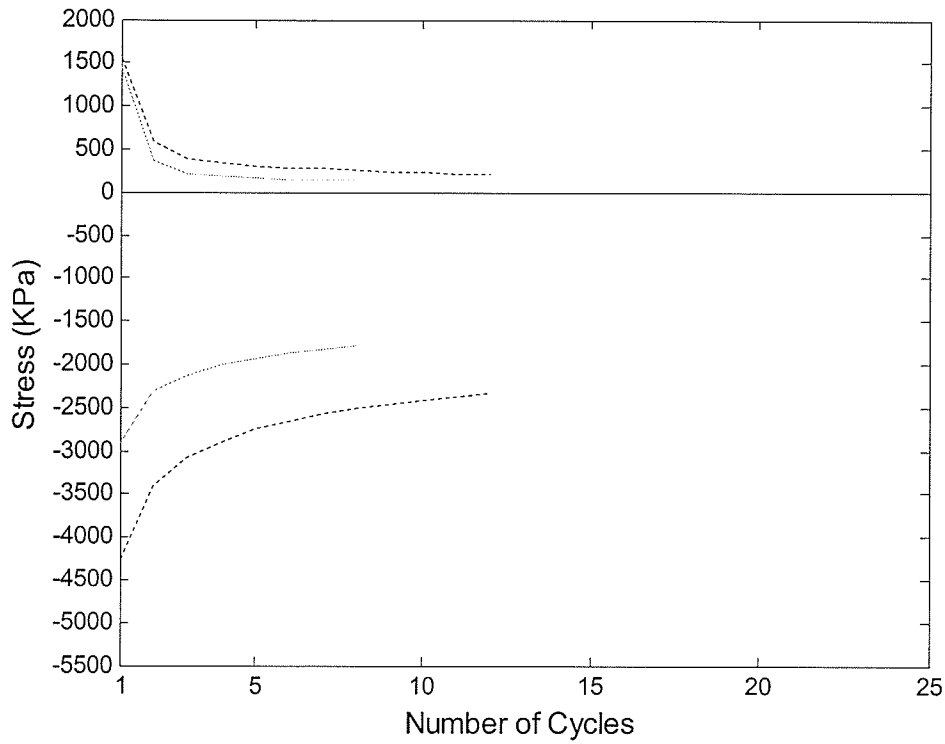

FIGURE 4.13 Sealant C Stress vs. Number of Cycles (-30°C)

4.3.4 Sealant D Results

Figures 4.14 to 4.16 highlight the results from Sealant D testing. This sealant displayed consistent results through all three test temperatures. No adhesion failure was noted at any temperature and at the -30°C test recorded the second lowest stress values in both tension and compression. The sealant remained soft and flexible throughout the entire testing procedure. At the $+30^{\circ}\text{C}$ test the percent drop in stress was close to 50 percent. At 0°C the percent drop remained relatively constant between 50 and 60 percent. This sealant really performed well at -30°C recording a low 50 percent reduction in stress. Low initial stress values were also realized and the sealant remained pliable when it was removed from the testing machine. This sealant would be recommended for Manitoba climates as it was not too soft in at $+30^{\circ}\text{C}$ or 0°C and at -30°C performed very well.

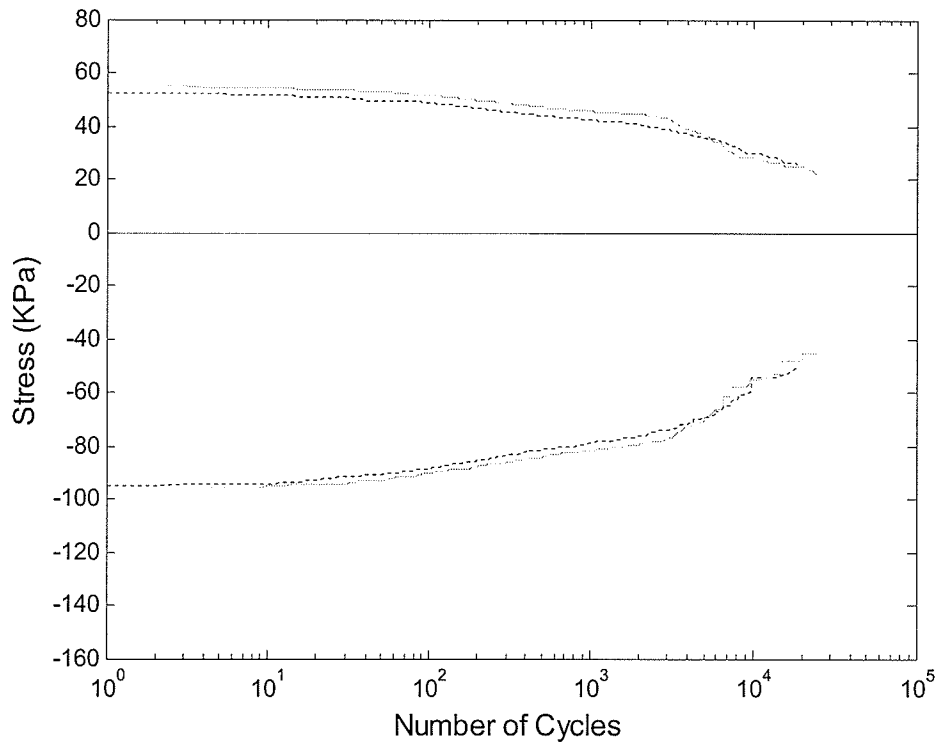

FIGURE 4.14 Sealant D Stress vs. Number of Cycles ($+30^{\circ}\text{C}$)

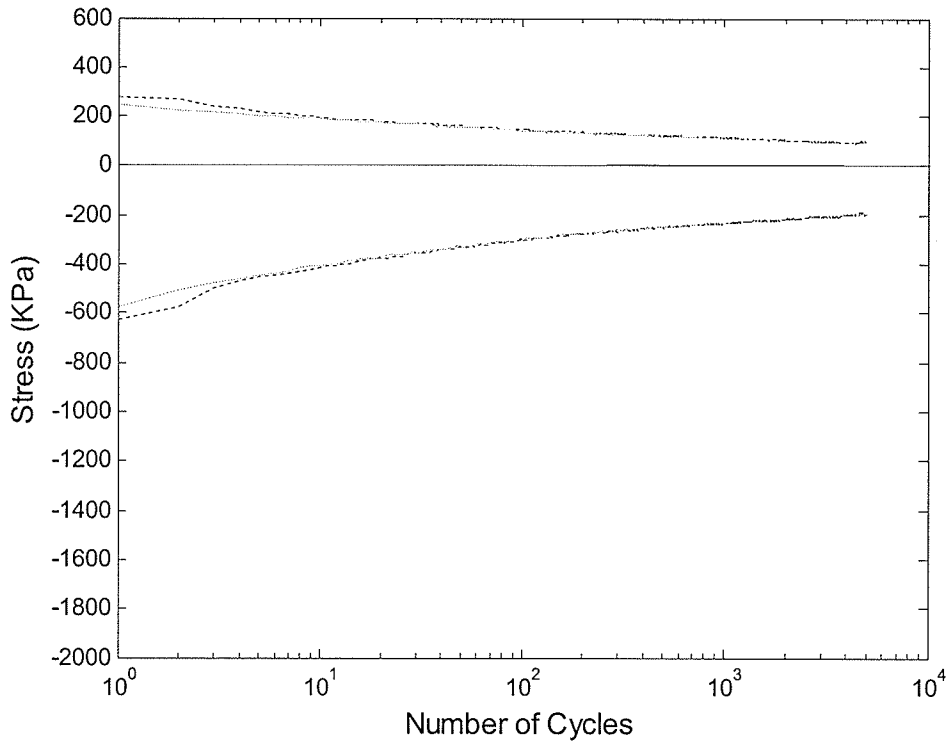

FIGURE 4.15: Sealant D Stress vs. Number of Cycles (0°C)

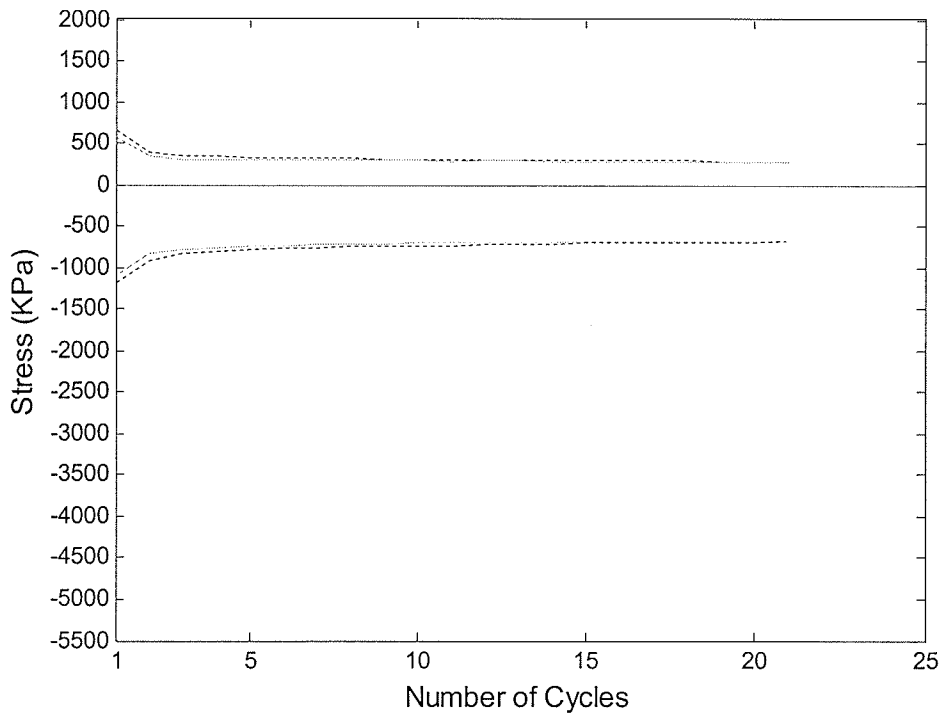

FIGURE 4.16: Sealant D Stress vs. Number of Cycles (-30°C)

4.3.5 Sealant E Results

The results for Sealant E are highlighted in Figures 4.17 to 4.19. At +30°C the sealant exhibited low initial stress values for both tension and compression. At 0°C the initial compression values were 36 percent apart although the sealant in tension and the stress dissipation trend were very similar. This sealant did not exhibit failure at any of the temperatures. This sealant was one of the softest sealants tested, the initial stress values were consistently one of the lowest at all three temperatures. This sealant performs well at cold temperatures, the only problem may be with the warm weather, as the sealant remains soft and may be pulled or tracked out of the joint.

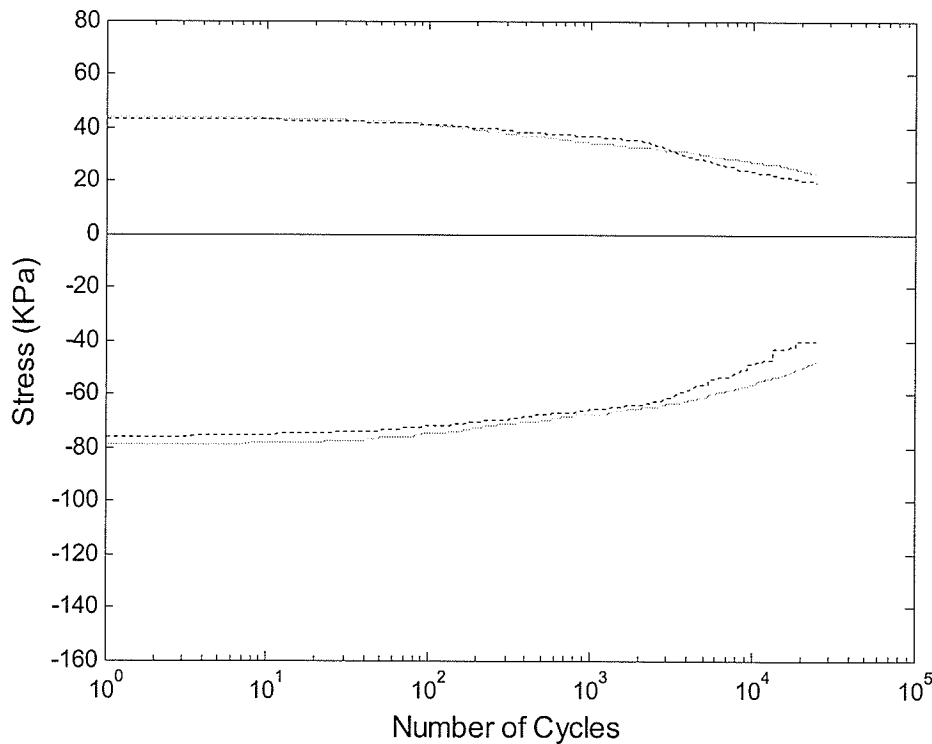

FIGURE 4.17 Sealant E Stress vs. Number of Cycles (+30°C)

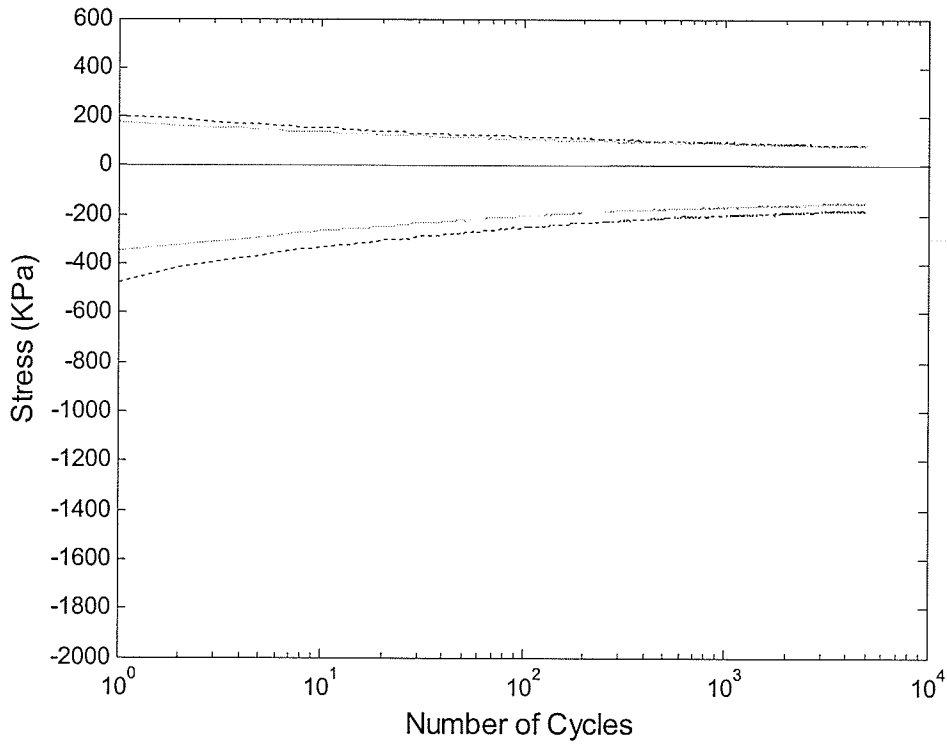

FIGURE 4.18 Sealant E Stress vs. Number of Cycles (0°C)

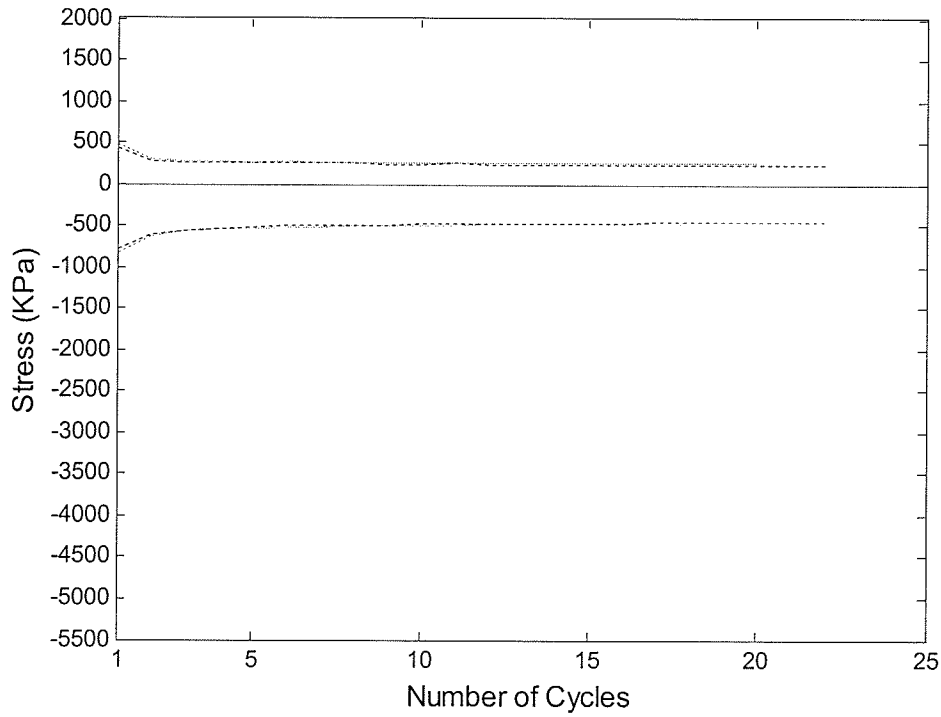

FIGURE 4.19 Sealant E Stress vs. Number of Cycles (-30°C)

4.3.6 Sealant F Results

The test results of this sealant are highlighted in Figures 4.20 to 4.22. At all three test temperatures the results were consistent and followed a similar trend. At +30°C and 0°C no adhesion failures were noted although the initial stress values were mid range, not overly soft but not very stiff. At -30°C this sealant painted a different picture recording very stiff values in both tension and compression. This sealant exhibited larger initial stress values in both tension and compression than one of the Type I sealants. This proved to be significant as both Test 1 and Test 2 exhibited adhesion failure within the first few cycles at -30°C. This sealant performed well at both the +30°C and 0°C but seemed to have reached its limit at -30°C, exhibiting very stiff behaviour and eventual adhesive failure. This sealant would not be recommended for the Manitoba climate. The sealant performed well at the warm and cool temperature but did not last through the cold temperature.

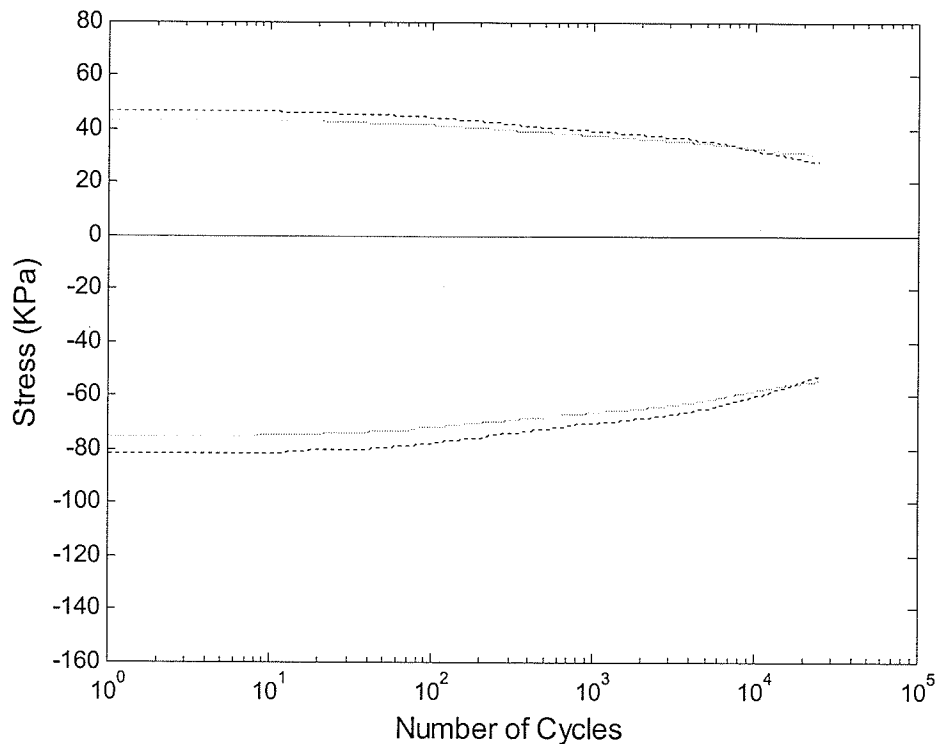

FIGURE 4.20 Sealant F Stress vs. Number of Cycles (+30°C)

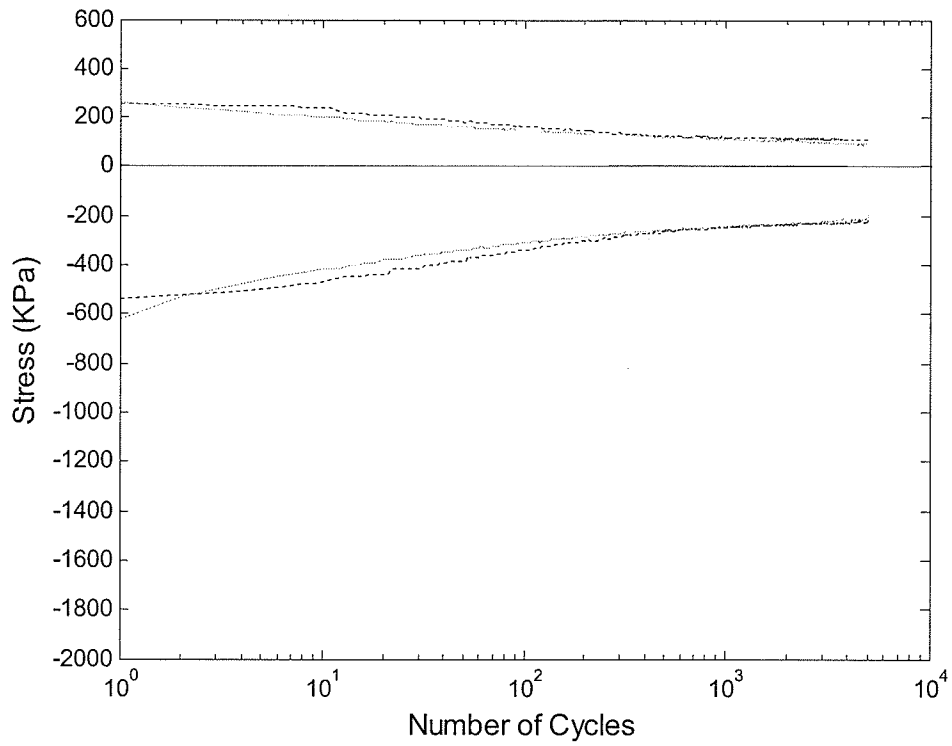

FIGURE 4.21: Sealant F Stress vs. Number of Cycles (0°C)

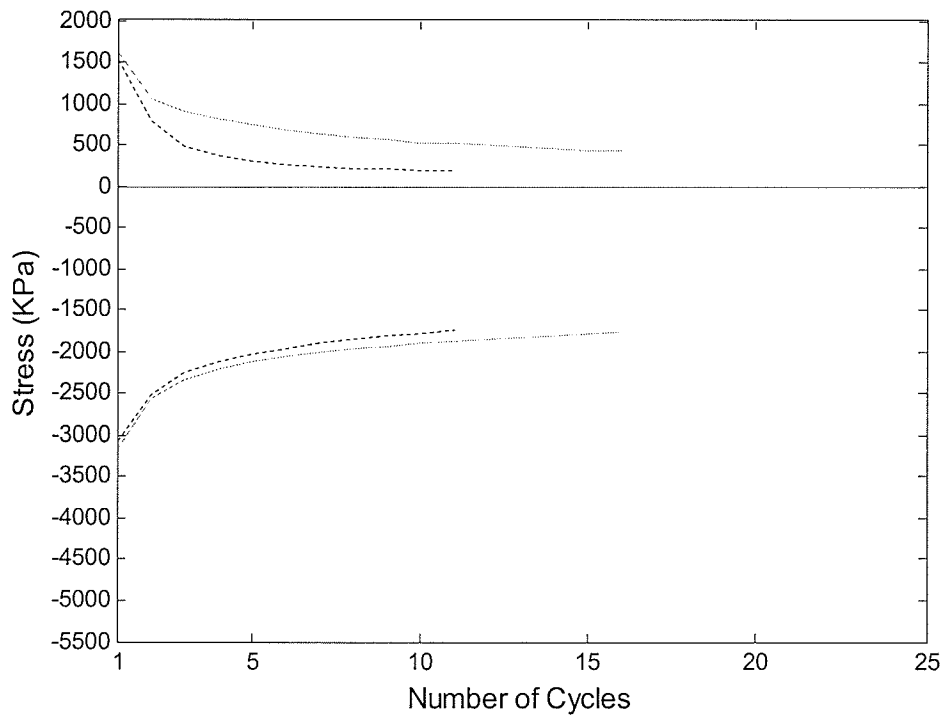

FIGURE 4.22: Sealant F Stress vs. Number of Cycles (-30°C)

4.3.7 Sealant G Results

The test results for Sealant G are displayed in Figures 4.23 to 4.25. At each temperature the sealant followed a similar stress dissipation trend line. At -30°C the initial results were greater than 15 percent different although within the first 5 cycles the results became very close. This sealant exhibited soft behaviour at all three test temperatures, this could be a potential concern during warm weather the sealant may become tacky and be pulled from the joint. At -30°C this sealant performed well and would be a good candidate for the cold weather experienced in Manitoba.

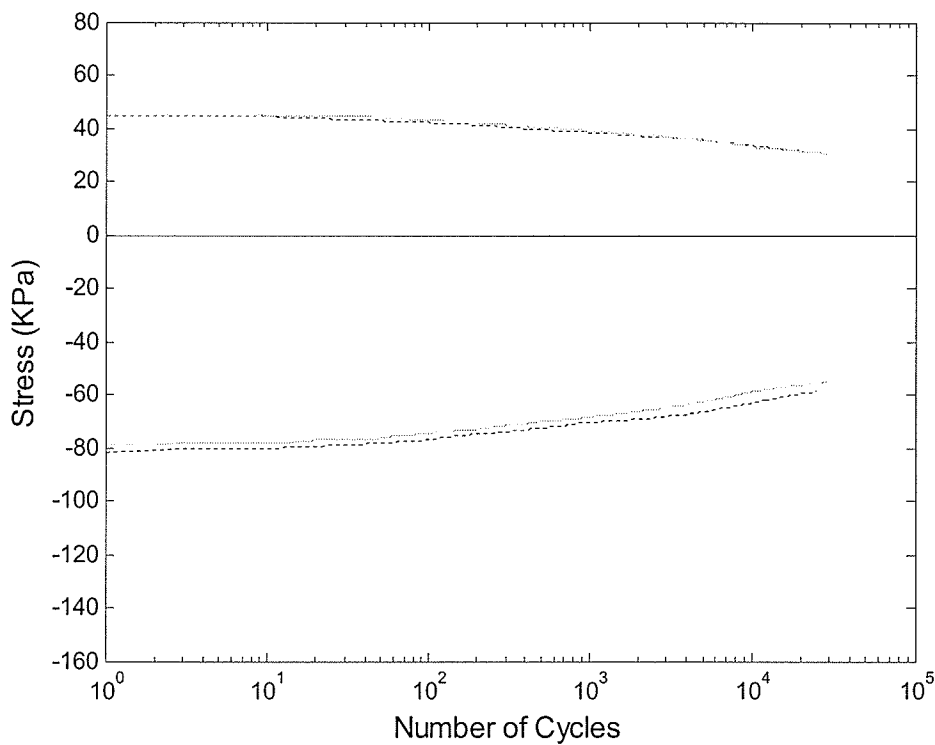

FIGURE 4.23 Sealant G Stress vs. Number of Cycles (+30°C)

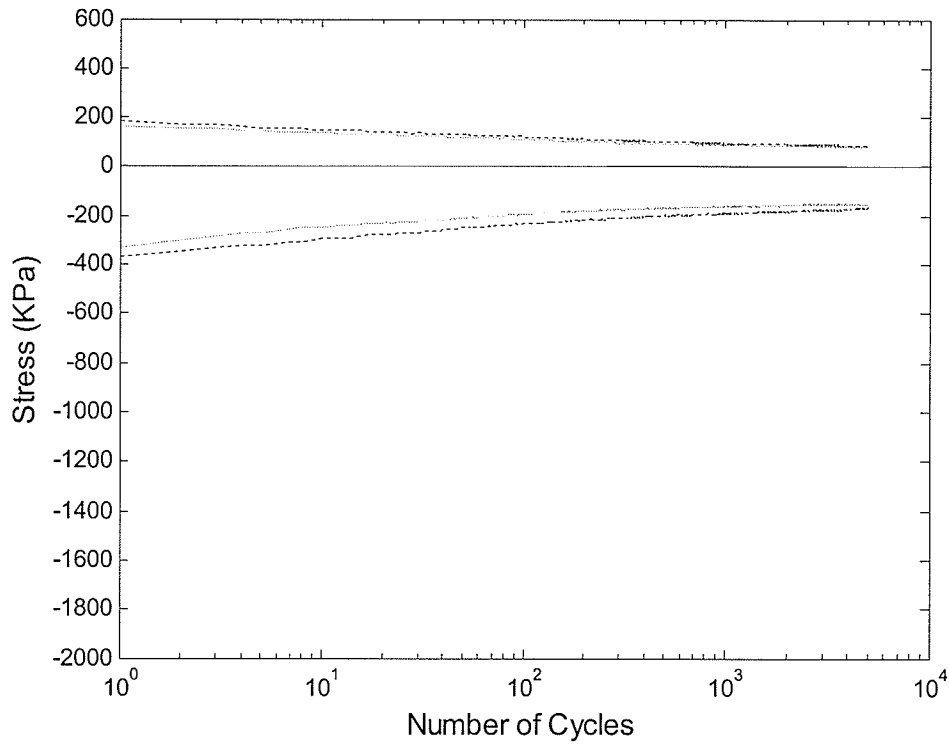

FIGURE 4.24: Sealant G Stress vs. Number of Cycles (0°C)

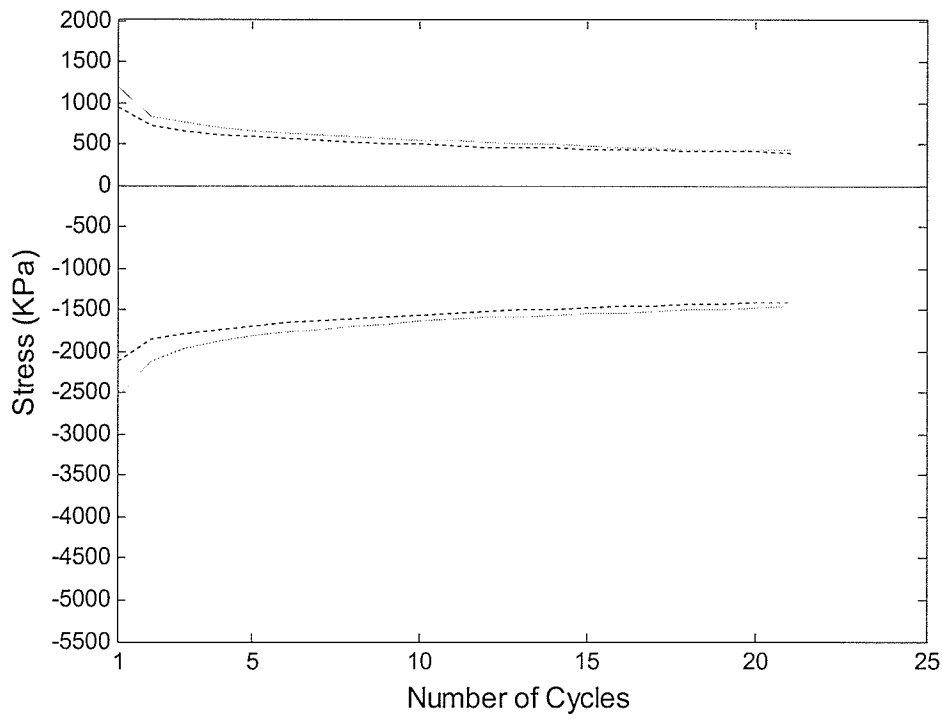

FIGURE 4.25 Sealant G Stress vs. Number of Cycles (-30°C)

4.3.8 Sealant H Results

The results for Sealant H are displayed in Figures 4.26 to 4.28. This sealant at all three temperatures exhibited greater than 15 percent difference between the two tests. Each temperature was tested a maximum three times and the closest results were maintained. This sealant did not seem to have consistent results between the two tests, this is the only sealant which exhibited significantly different behaviour at all three temperatures. The trend lines were all similar although the numbers differed by approximately 20KPa at +30°C, 200 KPa at 0°C and almost 700 KPa at -30°C in compression. In tension the results were a little closer at +30°C the difference was closer to 12 KPa, 55 KPa at 0°C and 200 KPa at -30°C. At -30°C during test 1 sealant failure was noted but test 2 did not show failure. This sealant displayed slightly different results but due to the fact that the trend line matches this was not considered a major problem. This sealant despite one failure at -30°C performed well at all other temperatures, although was very soft at +30°C. This sealant recorded consistently some of the softer stress values and may be susceptible to debris puncturing the seal or being pulled out.

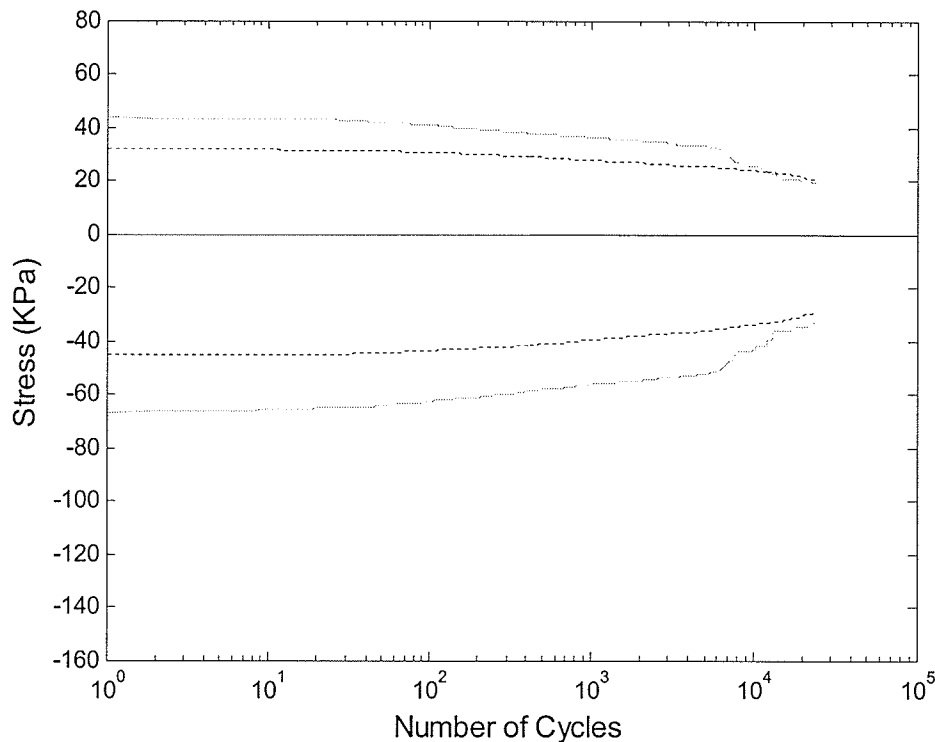

FIGURE 4.26 Sealant H Stress vs. Number of Cycles (+30°C)

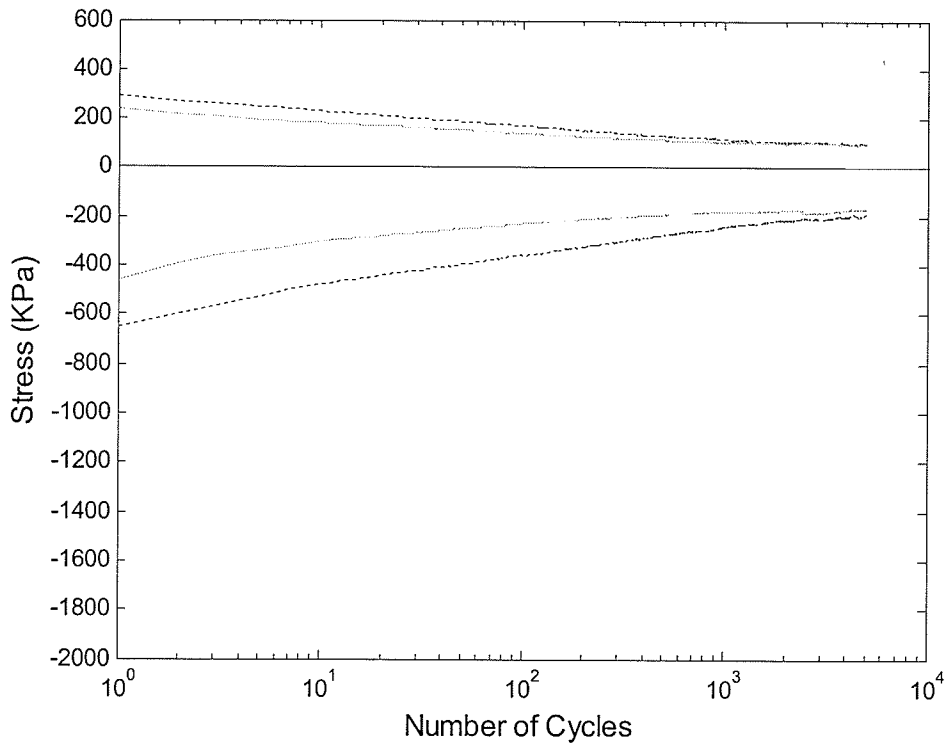

FIGURE 4.27 Sealant H Stress vs. Number of Cycles (0°C)

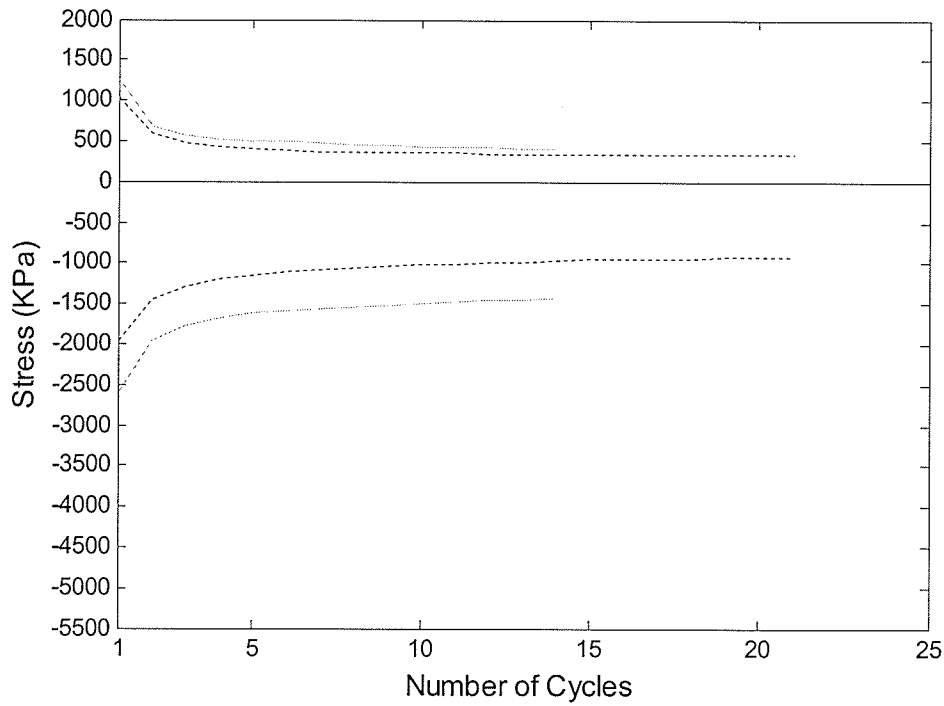

FIGURE 4.28 Sealant E Stress vs. Number of Cycles (-30°C)

4.4 Comments on the Experimental Testing of Sealants

This test setup was designed to perform a fatigue analysis on joint sealants. During the testing at the different temperatures, difficulties were encountered that required the test to be modified. The test setup was designed after the bond test from ASTM D6690. The concrete blocks were poured around the four anchor bolts and this caused a shear plane to develop along the top of the bolt heads. As the bolts were tightened into the testing apparatus, some of the concrete blocks sheared a corner off, shown in Figure 4.29. This problem was encountered in about 15 percent of the blocks. These blocks were not used in the subsequent testing and care was taken to gently tighten the bolts and not induce torsion into the bolt.

At the -30°C test temperature the 1Hz frequency was not possible to maintain. During the initial testing the concrete blocks and in some cases the sealant completely shattered as they were too stiff to withstand the rapid movement. The frequency was lowered to 0.1Hz with the same result and finally at 0.003 Hz we were able to test from the beginning to the end without shattering the blocks. An example of concrete shattering is shown in Figure 4.30A and an example of the sealant shearing is shown in Figure 4.30B. The lowering of the frequency allowed for the completion of the tests at -30°C this did not adversely affect the results since each sealant was compared against one another at each test temperature. The sealants were not compared across the different temperatures due to the different loading rate and the number of cycles performed at each test temperature.

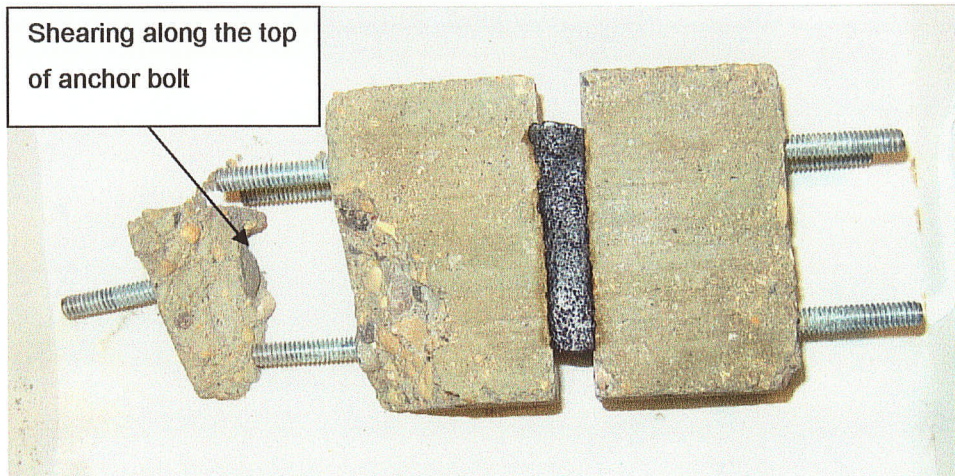

FIGURE 4.29: Torsion failure of concrete blocks while tightening into the testing machine



FIGURE 4.30A: Concrete Shattering



FIGURE 4.310B: Close up of failure within the sealant

A third difficulty occurred with the use of the Liquid Nitrogen to cool the blocks. The tanks depleted very quickly and had to be replaced once a week while the 0°C tests were being conducted. The test had been shortened to 5000 cycles due to the depletion of the liquid nitrogen and the fact that the sealants were much stiffer at cooler temperatures and experienced similar percent drops in loads as the $+30^{\circ}\text{C}$ test results. When the -30°C tests were conducted the tank had to be replaced every 3 days, due to the difficulties with the concrete blocks and rapid depletion of the liquid nitrogen the test frequency was slowed to 0.003 Hz and only 25 cycles were conducted. The plus and minus 2 mm stroke was maintained throughout the testing and each temperature testing was consistent amongst all the sealants. At -30°C four sealants underwent adhesion failure, where the

sealant became completely detached from the concrete block. Some of the sealants only experienced partial adhesion failure, this was still counted as a failure for the sealant. Even if only a crack opens up, water can penetrate to the underlying layers and cause structural deficiencies.

5 Sealant Performance and Selection Criteria

This chapter will discuss three sealant performance criteria that will rank the sealants. The three criteria are percent load drop versus temperature, normal stress analysis and maximum surface stress analysis. These three criteria are applied to the 8 hot-pour sealants tested and a ranking for each sealant is produced. These three criteria serve as benchmarks for future testing.

5.1 Percent Load Drop versus Temperature

The first criteria used to assess the performance of the hot-pour sealants was the percent load drop versus temperature. The percent load drop was directly calculated from the initial and final loads that were measured see equations 5.1 and 5.2.

$$\%LoadDropTension = \frac{FinalTensileLoad - InitialTensileLoad}{InitialTensileLoad} \quad (5.1)$$

$$\%LoadDropCompression = \frac{FinalCompressiveLoad - InitialCompressiveLoad}{InitialCompressiveLoad} \quad (5.2)$$

This criteria took into account the sealants ability to dissipate the stress from the cyclic loading as well the sealants initial stiffness to the temperature differences. This method allowed the sealants to be grouped into good, satisfactory and poor performing sealants.

Based on the percent load drop criteria there were two sealants with good performance. Sealants D and E consistently maintained the percent load drop less than 50 percent at all test temperatures. Figure 5.1 displays the results from Sealants D and E. The graph from left to right shows the results from -30°C to +30°C which appear to be close to a straight line. The sealants, D and E, were unaffected by the temperature, not too stiff at -30°C and not too soft at +30°C. Sealants D and E did not show any adhesion failure at any of the test temperatures and only one test in compression went above 60 percent load drop from the beginning of the test to the end. These two sealants consistently recorded percent load drop in the range of 40 to 60 percent in both tension and compression. These results were not characteristic of the remaining sealants, which recorded higher percent load drops in both tension than compression.

The second category is satisfactory performance and three sealants, F, G and H, were grouped into this category. The results are shown in Figure 5.2 and two distinct trend lines were developed from the results. Trend line 1 is for the tension results, the sealants recorded 60 to 80 percent load drop at -30°C and this decreased to 30 to 50 percent at $+30^{\circ}\text{C}$, these results showed the sealant increasingly had difficulty in resisting the thermal loading. In compression the trend looks opposite, the sealant recorded low percent load drop in the range of 40 to 50 percent at -30°C and increased to 50 to 70 percent at 0°C and then decreased to 30 to 50 percent at $+30^{\circ}\text{C}$. All three sealants displayed increased stiffness to temperature given by the low percent load drop at the -30°C test temperature. These sealants were considered in the satisfactory performance category as one of the samples from both Sealants F and H underwent adhesion failure at -30°C and displayed higher percent load drop in tension at -30°C than at $+30^{\circ}\text{C}$.

The third category covered the sealants that would not be recommended for use in cold climates due to their poor performance. The percent load drop results versus temperature for Sealants A, B and C are displayed in Figure 5.3. These sealants extend the results from Sealants F, G and H which performed satisfactory, displaying higher percent load drops in tension at -30°C and lower percent load drops in compression due to the increased stiffness of the materials. At -30°C the percent load drop in tension ranged from 85 to 90 percent and all three sealants experienced adhesion failure. At 0°C the percent load drop in tension reduced by one to two percent with Sealants A and B experiencing adhesion failure. At $+30^{\circ}\text{C}$ in tension the percent load drop ranged from 75 to 81 percent and none of the sealants experienced adhesion failure. In compression at -30°C the results show 30 to 50 percent load drop, increasing dramatically to 80 to 90 percent at 0°C and decreasing slightly to 75 to 86 percent at $+30^{\circ}\text{C}$. These sealants experienced significant load drop at all three test temperatures and showed very stiff behaviour at -30°C in compression. Based on this criteria these three materials would not be recommended for use in cold climates.

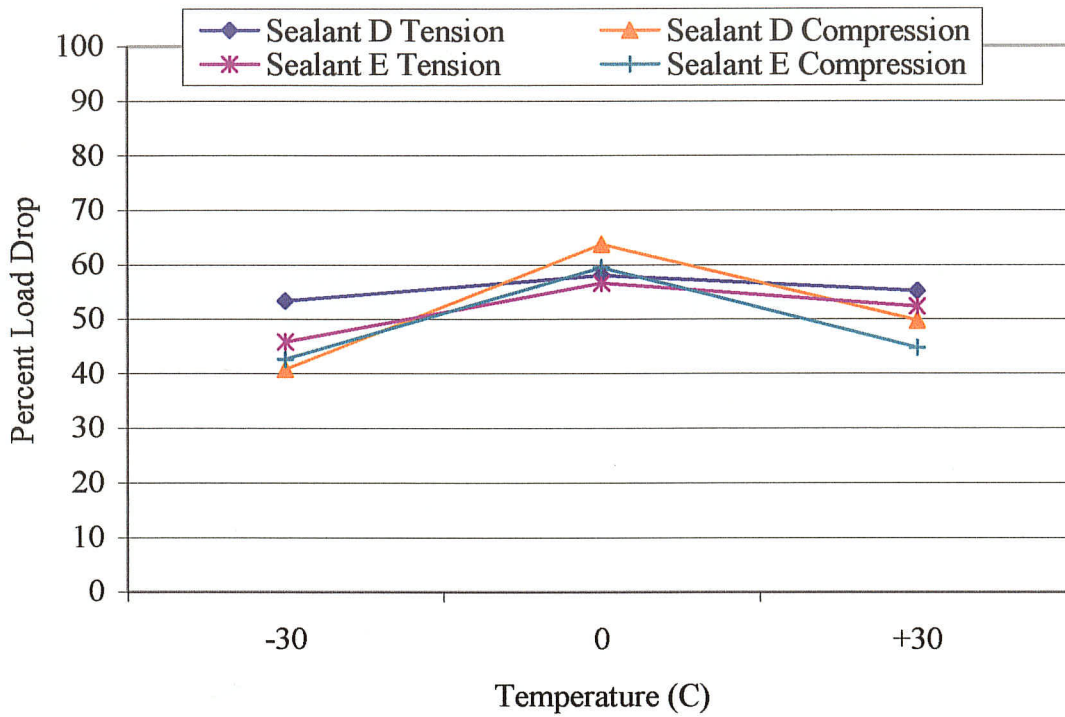

FIGURE 5.1: Sealants that performed well – Average Percent Load Drop vs. Temperature

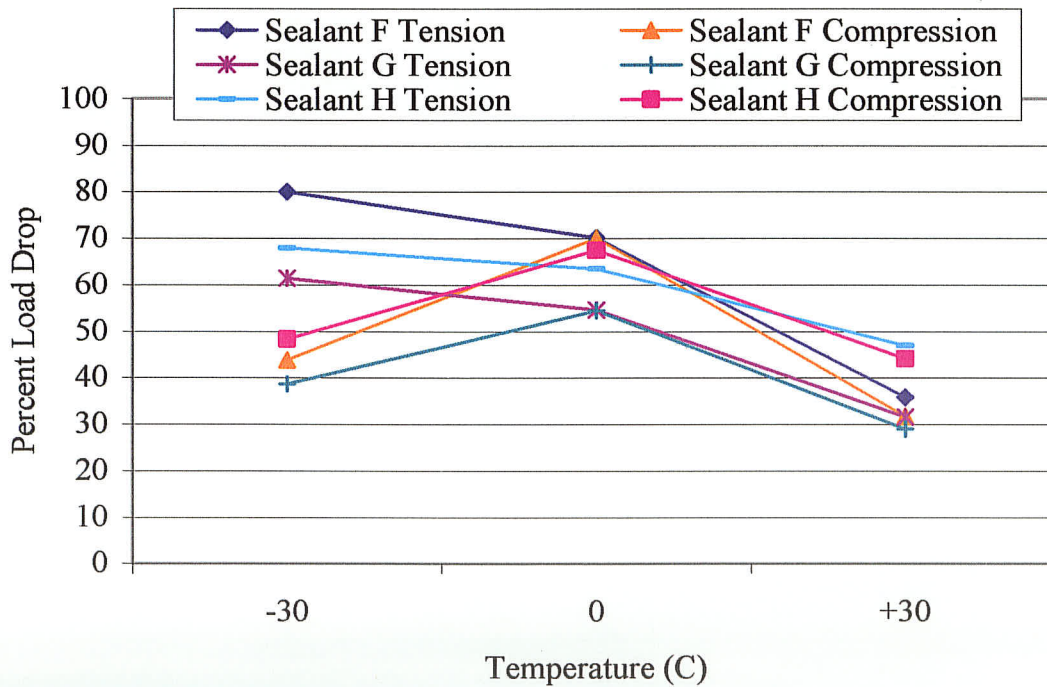

FIGURE 5.2: Sealants that performed satisfactory - Average Percent Load Drop vs. Temperature

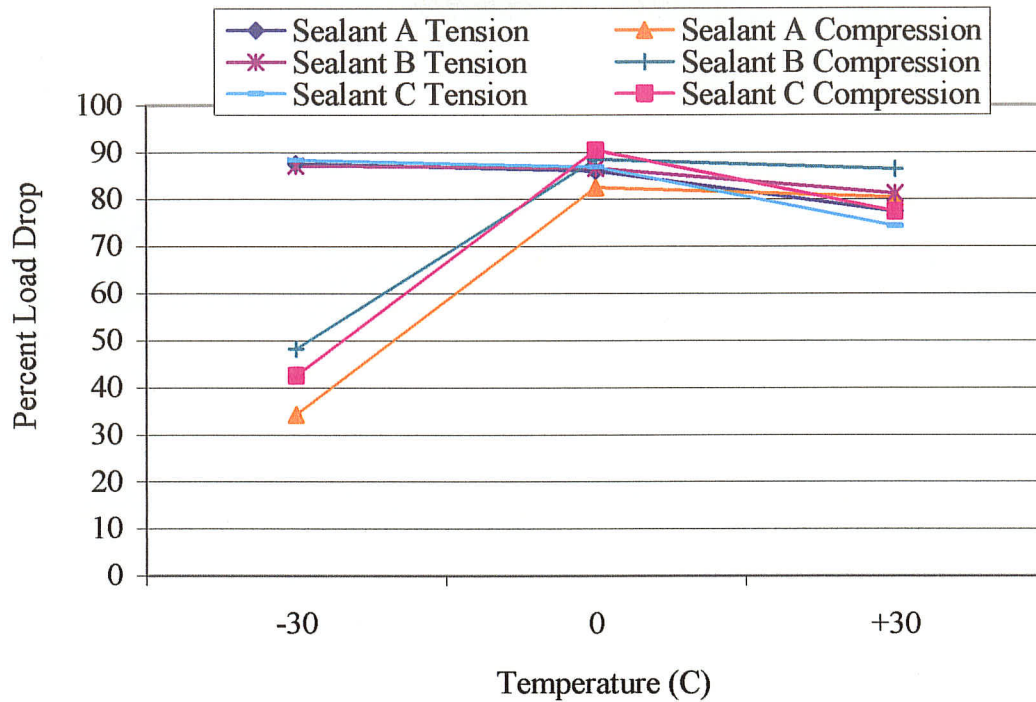

FIGURE 5.3: Sealants that performed poorly - Average Percent Load Drop vs. Temperature

5.2 Normal Stress Performance Criteria

The development of normal stress as a performance criterion was used in this research due to the fact that the cyclic loading was displacement controlled and the use of strain by itself cannot be an indication of performance of these sealants. The stiffness of the materials and stress are better indicators of performance and the figures below show the stress and strain results at each test temperature for each sealant.

The normal strain was calculated for each sealant using the extension or compression (ΔL) directly measured by the data acquisition apparatus and dividing by the original width (L) of the sealant measured prior to testing, as shown by Figure 5.4. The normal strain for each sealant was calculated because the joint opening of each test block was between $10 \text{ mm} \pm 1.5 \text{ mm}$. The strain was plotted against stress and hysteresis loops were developed for each test temperature. The results are organized by test temperature and each plot shows three hysteresis loops at different cycles in the test to display the

decrease in resistance to the cyclic loading from the beginning of the tests to the end. The results are from one of the test trials for each sealant at each temperature. At +30°C cycles highlighted are 10, 50 and 5000 due to the shorter nature of the test and at -30°C the cycles shown are 1, 5 and 15 with exceptions from trials which did not complete 15 cycles. These results are shown in Figures 5.5 to 5.28.

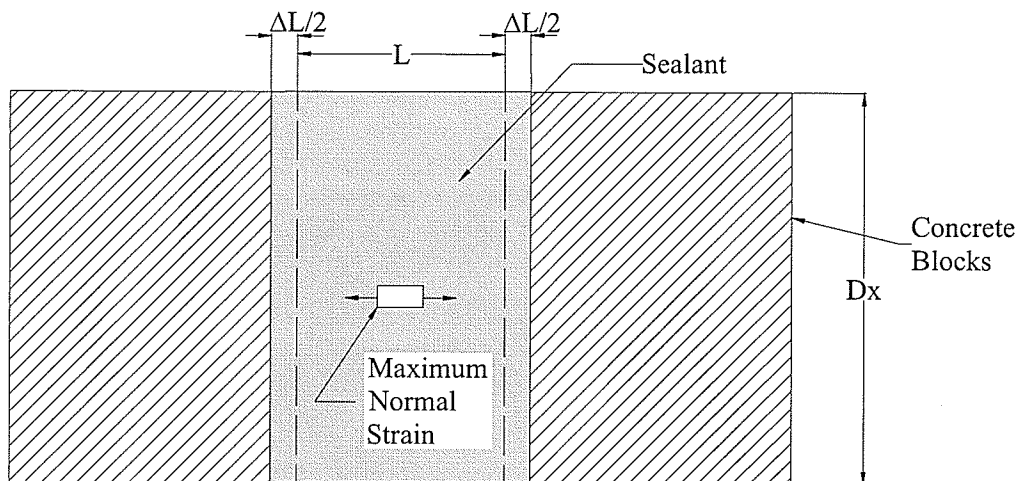

FIGURE 5.4: Maximum Normal Strain Configuration

Each sealant experienced similar strain values as shown in Table 5.1 in both tension and compression. The minor difference between the strains comes from the fluctuations in the initial widths of the sealants as measured prior to each test. The results given in Figures 5.5 to 5.28 allow the segregation of the performance of the sealants by use of the stress values.

TABLE 5.1: Maximum and Minimum Normal Strain Values as a Percentage

	+30 Degrees Strains (%)		0 Degrees Strains (%)		-30 Degrees Strains (%)	
	Max.	Min	Max.	Min.	Max.	Min.
Sealant A	19.998	-20.124	18.928	-18.878	18.444	-17.973
Sealant B	19.825	-19.92	18.916	-18.892	18.591	-18.425
Sealant C	20.401	-20.539	19.668	-19.649	18.249	-17.999
Sealant D	19.939	-20.316	19.608	-19.687	18.248	-18.171
Sealant E	20.83	-20.978	20.837	-20.912	20.075	-20.025
Sealant F	20.433	-20.506	20.211	-20.289	20.033	-19.855
Sealant G	20.031	-20.093	19.083	-19.074	19.091	-18.926
Sealant H	20.231	-20.706	19.025	-19.123	21.15	-20.939
Average	20.211	-23.397	19.534	-19.565	19.235	-19.039

5.2.1 +30°C Normal Stress Strain Results

These results evaluate each sealant's ability to dissipate the stresses from the initial values to the end of each test. Generally these results show sealants that had high initial stress values at each temperature, these sealants experienced damage and large drops in stress were the results. At the +30°C test temperature no definitive adhesion or cohesion failure occurred. These sealants can be grouped into sealants with initial stress values greater than 100 KPa, Sealants A to D, and sealants with initial stress values close to 80 KPa, Sealants E to G, and sealants with less than 70 KPa, Sealant H.

The results are further broken down with Sealants A and B showing high initial stress values at 50 cycles but as shown in Figure 5.5 Sealant A after 1000 cycles has experienced a significant dissipation in stress to less than half its initial value. Sealant B experiences this result between the 1000 and 20000 cycles, Figure 5.6. Sealant C in Figure 5.7 displays an equal dissipation from cycle 50 to 20000, no abrupt failure occurring. Sealant D in Figure 5.8 displays similar results to Sealant C. Sealants E to G displayed in Figures 5.9 to 5.11 showed very consistent results amongst each other. Each sealant's minimum and maximum stress values at 50 cycles started out in compression close to the 80 KPa range and in tension close to the 40 KPa range. The final values at cycle 20000 had lowered minimally to 50 KPa in compression and 20 KPa in tension. Sealant H shown in Figure 5.12 displayed a slightly flatter slope when travelling from tension to compression and the maximum and minimum stress values were 60 KPa in compression and 40 KPa in tension. At cycle 20000 the results show 30 KPa in compression and 15 KPa in tension, this sealant was extremely soft to work with and the stress values calculated confirm this result.

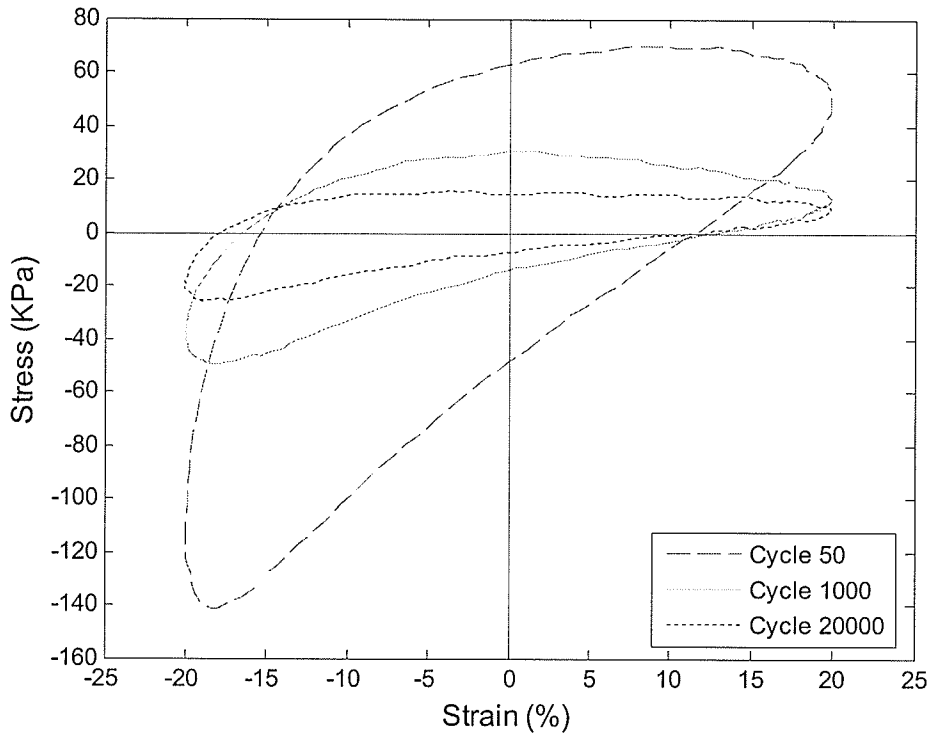

FIGURE 5.5: Sealant A Hysteresis Loops (+30°C)

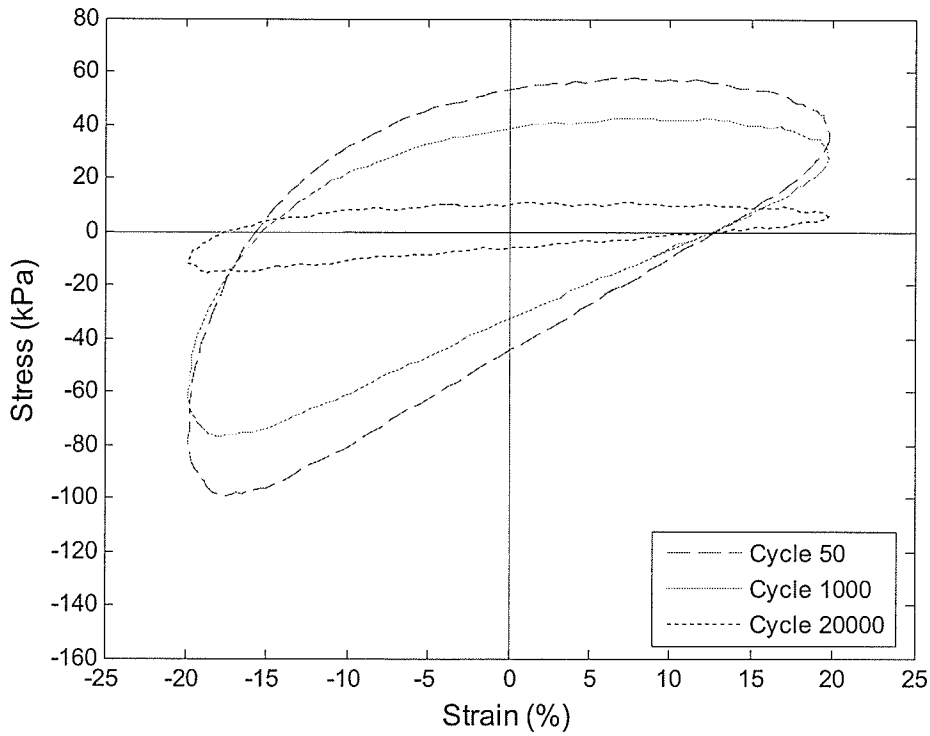

FIGURE 5.6: Sealant B Hysteresis Loops (+30°C)

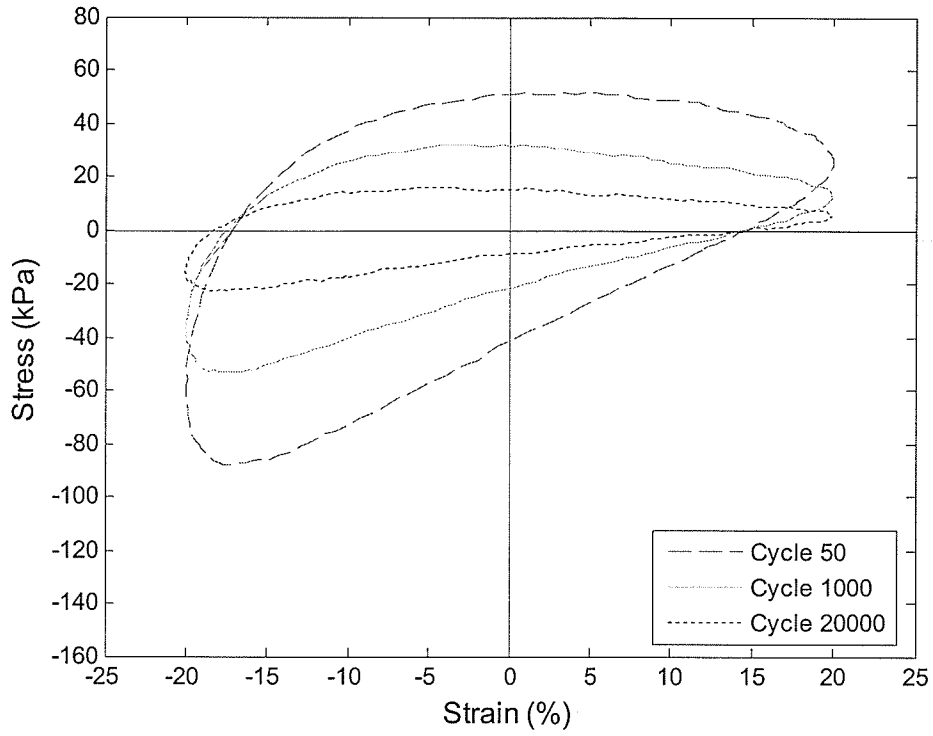

FIGURE 5.7: Sealant C Hysteresis Loops (+30°C)

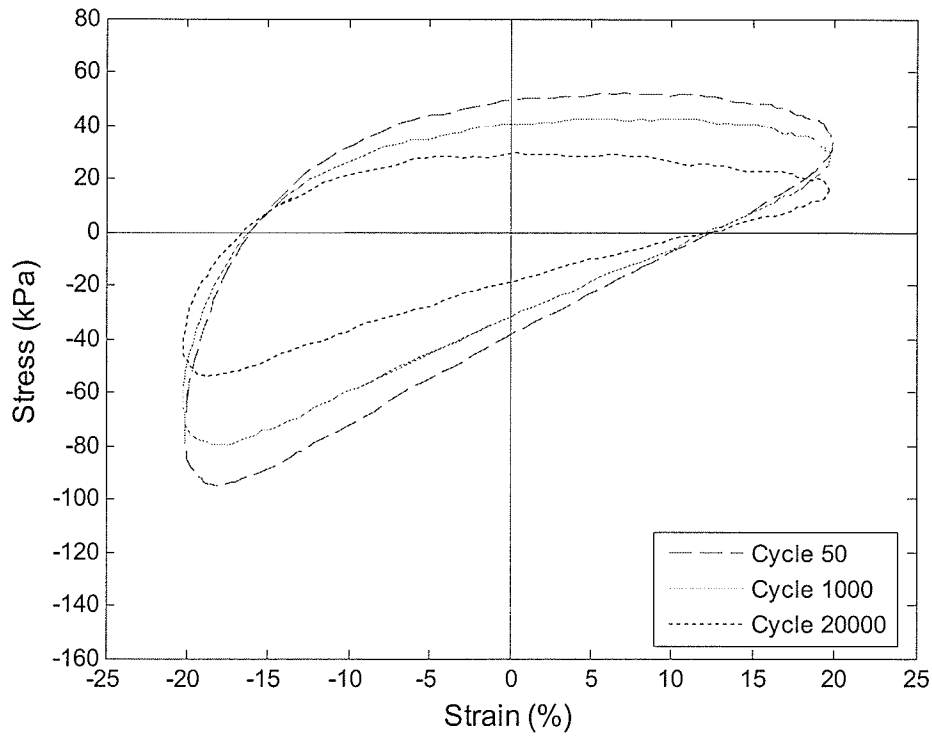

FIGURE 5.8: Sealant D Hysteresis Loops (+30°C)

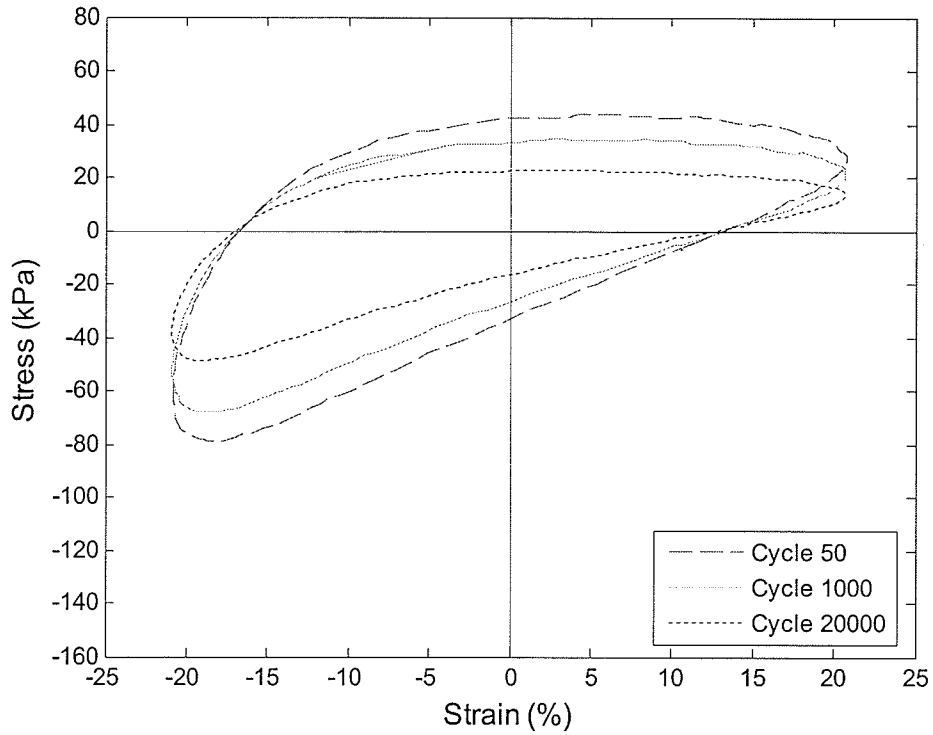

FIGURE 5.9: Sealant E Hysteresis Loops (+30°C)

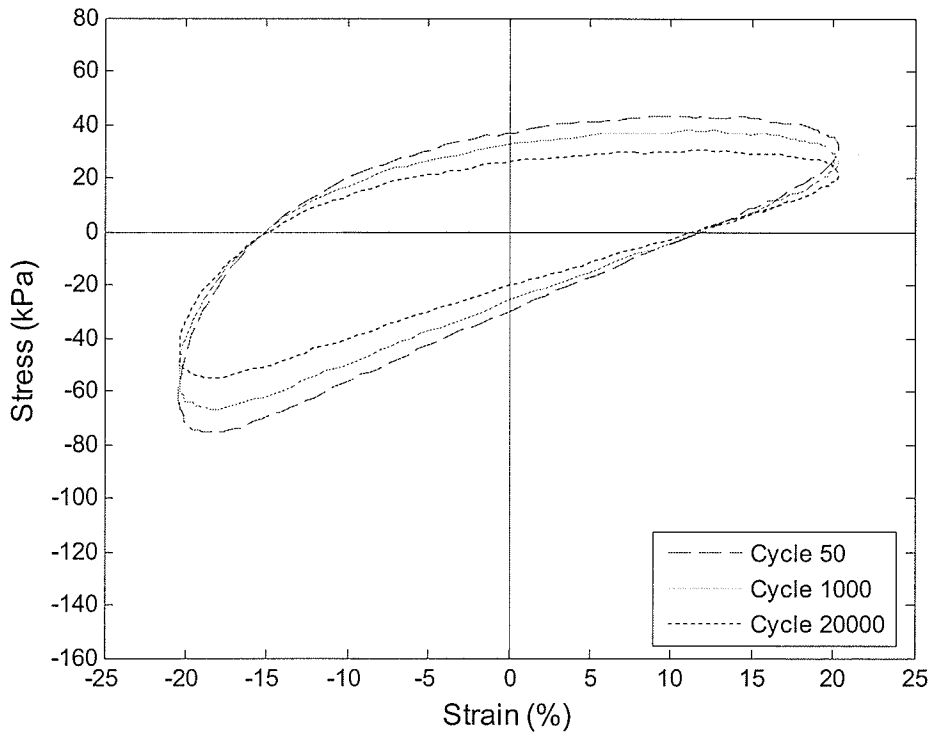

FIGURE 5.10: Sealant F Hysteresis Loops for (+30°C)

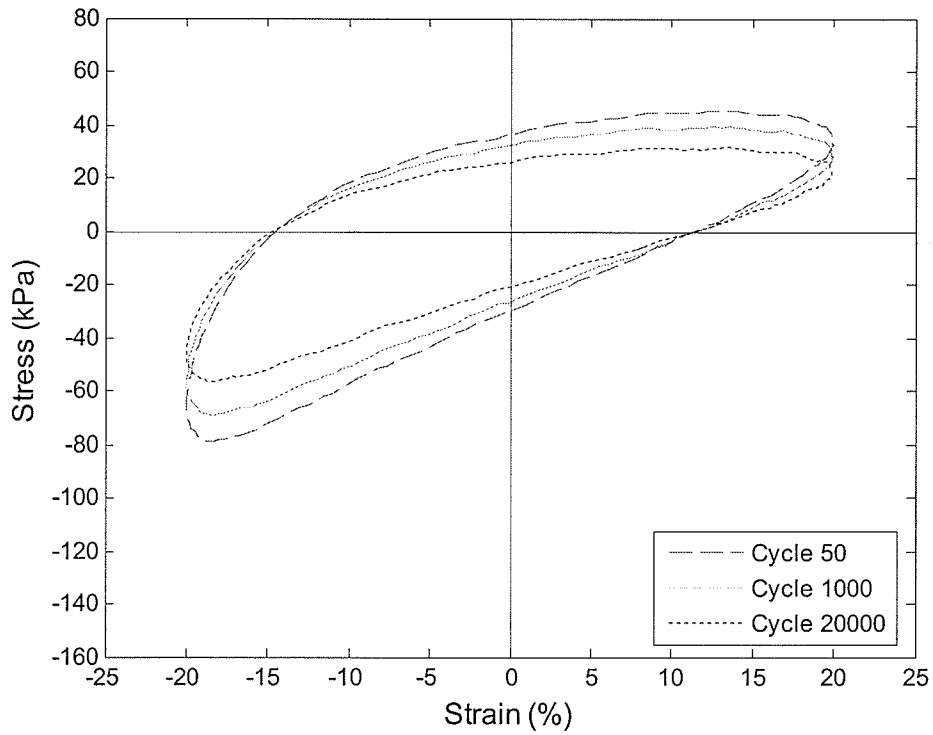

FIGURE 5.11: Sealant G Hysteresis Loops for (+30°C)

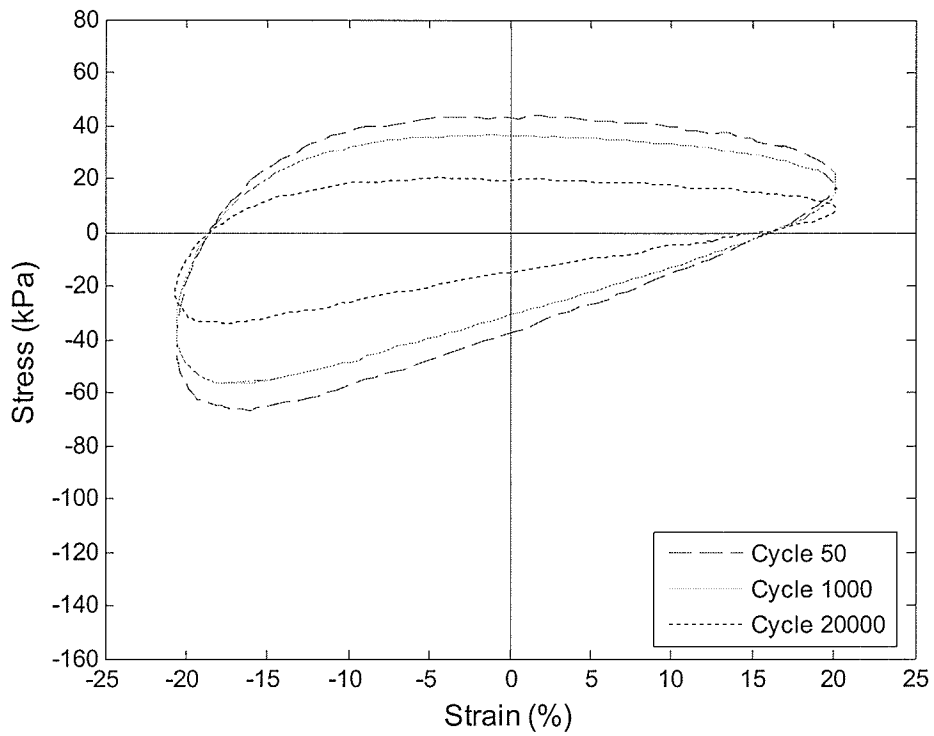

FIGURE 5.12: Sealant H Hysteresis Loops for (+30°C)

5.2.2 0°C Normal Stress Strain Results

The stress and strain results for the eight sealants tested at 0°C are shown in Figures 5.13 to 5.20. Trends were developed between sealants that displayed similar results. These results also indicate a stiffening of the material from +30°C to 0°C. All sealants displayed much higher initial stresses and the hysteresis loops took on different shapes due to the stiffness of the sealant materials. Sealants A and B results at 0°C are different from the straight line travelling from tension to compression in the +30°C results. Figures 5.13 and 5.14 display a bend just after the displacement moves from the neutral axis into compression. By cycle 50 both sealants show signs of adhesion failure as the stress realized in both the tension and compression sides have dropped to less than 50 percent of the stress values realized at cycle 10. By cycle 5000 the stresses have dropped to greater than 80 percent load lost. Sealants A and B would not be recommended for use in cool climates, the sealants realized very high initial stresses and after 50 cycles experienced adhesion failure.

The results from Sealant C shown in Figure 5.15, display a fairly high initial stress value of 1100 KPa in compression and 450 KPa in tension. This sealant experienced greater than 80 percent load drop in both tension and compression although no adhesion failure was noticed. Sealants D through H displayed similar results amongst each other. These sealants experienced no adhesion failure and the hysteresis loops display straight line movement from tension to compression. The lower initial stress values realized are consistent with materials that at the cooler temperatures are able to handle the plus and minus 2 mm movement for a minimum of 5000 cycles. These five sealants are good candidates for cool climate use.

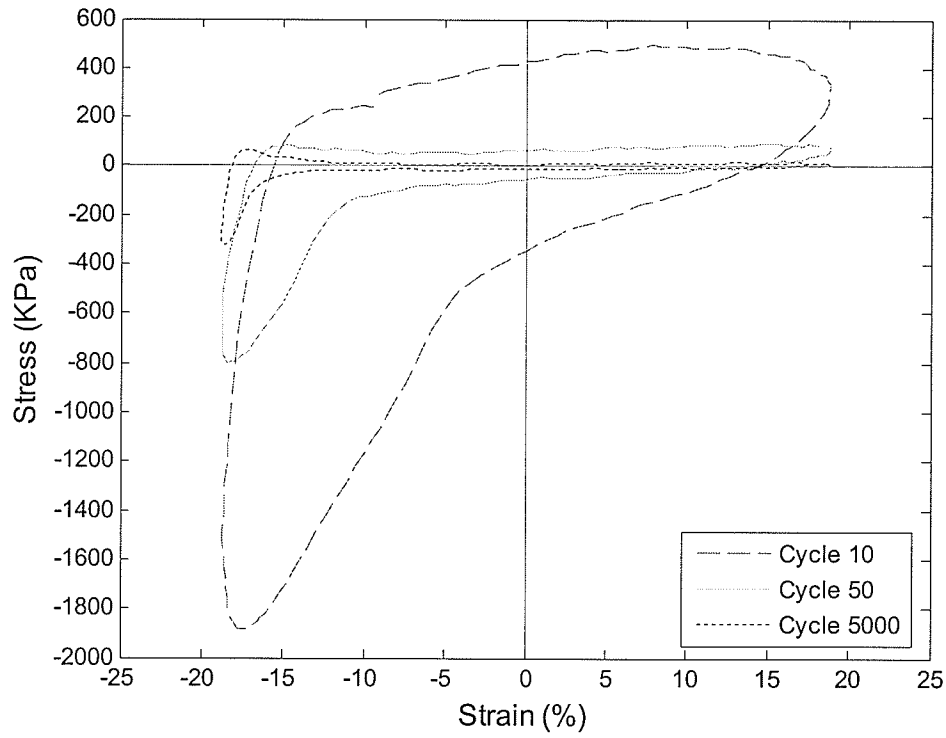

FIGURE 5.13: Sealant A Hysteresis Loops (0°C)

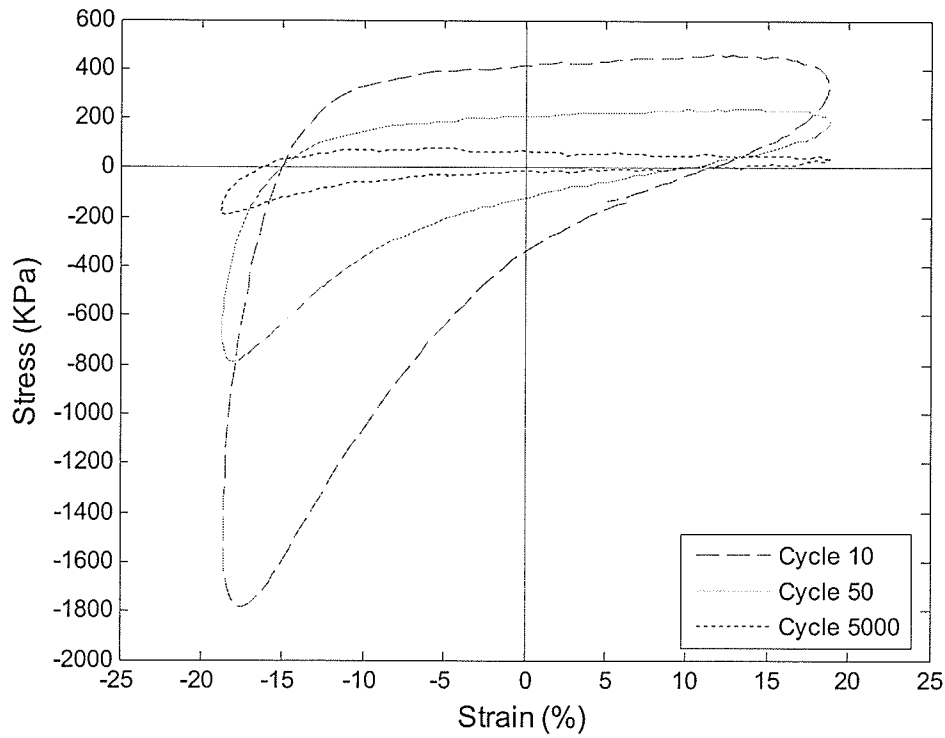

FIGURE 5.14: Sealant B Hysteresis Loops (0°C)

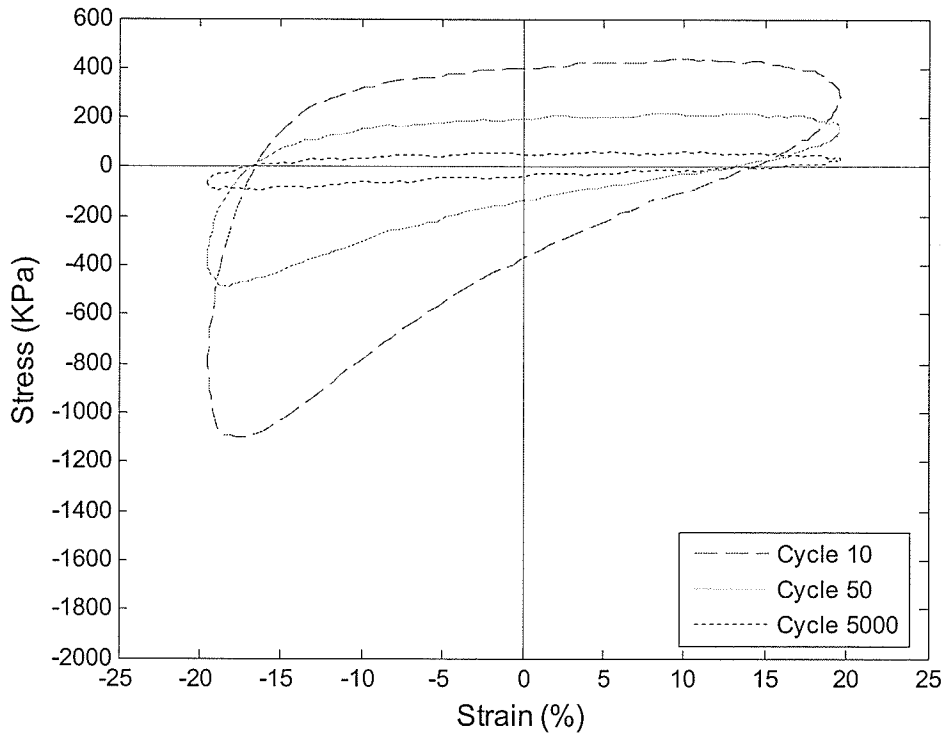

FIGURE 5.15: Sealant C Hysteresis Loops (0°C)

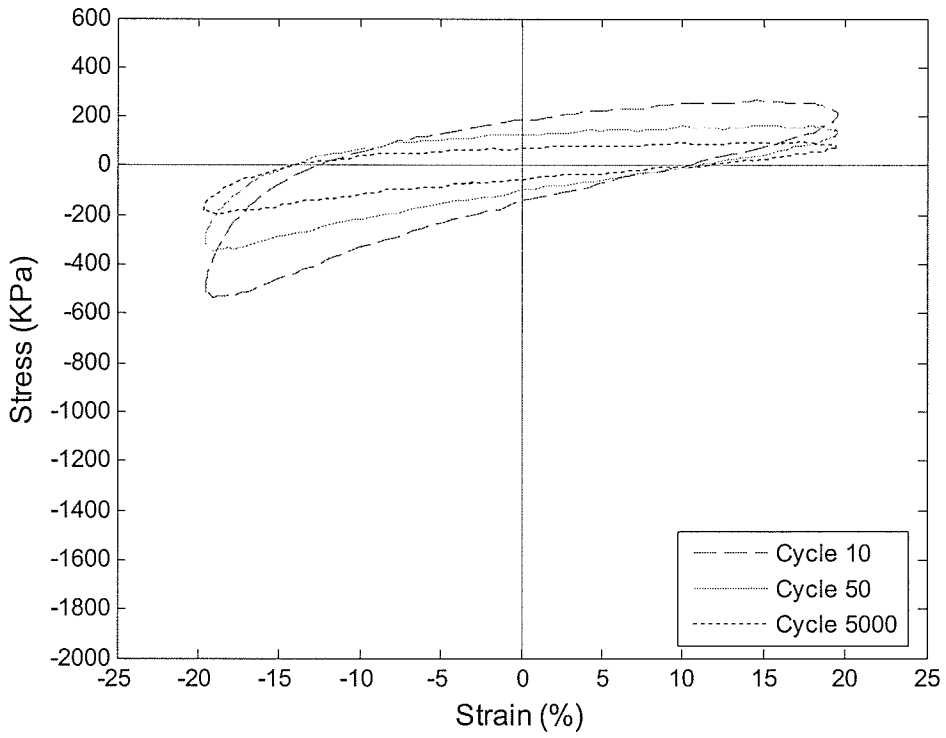

FIGURE 5.16: Sealant D Hysteresis Loops (0°C)

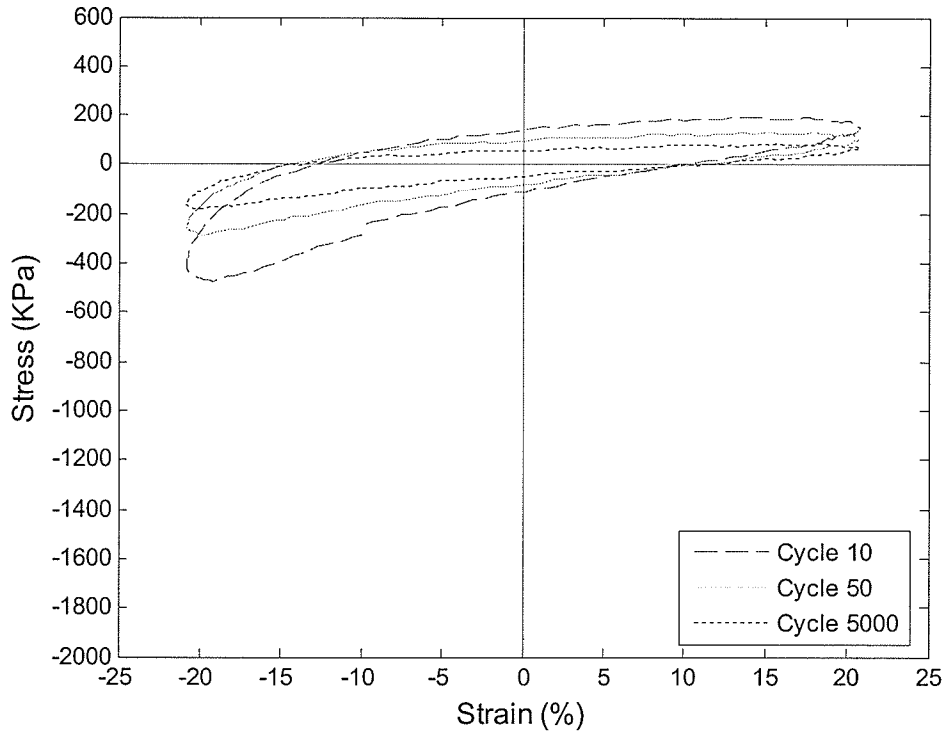

FIGURE 5.17: Sealant E Hysteresis Loops (0°C)

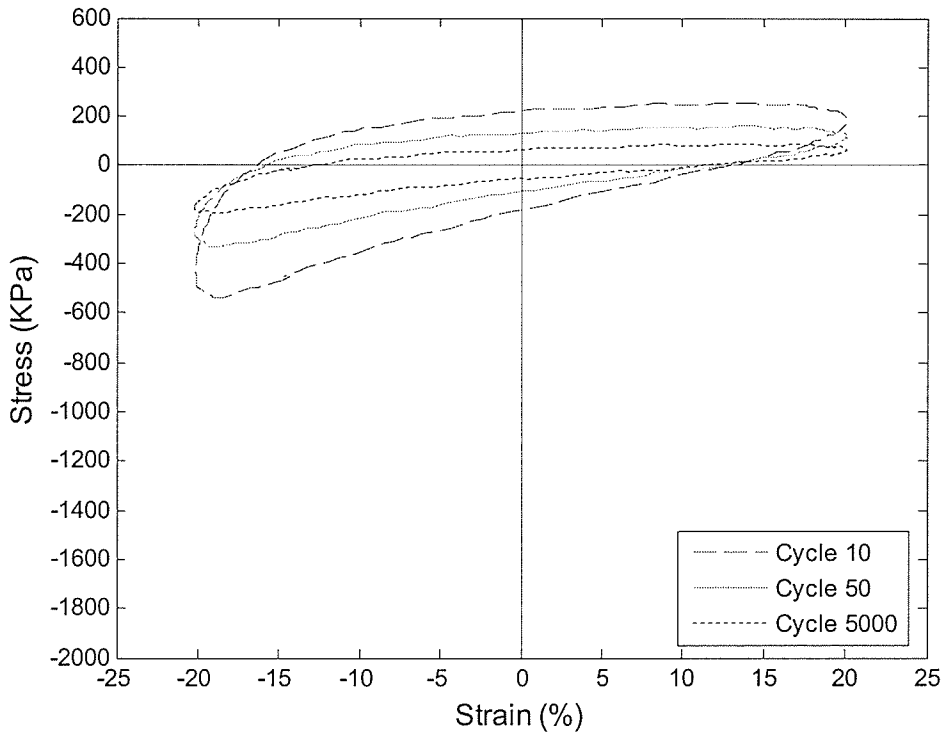

FIGURE 5.18 Sealant F Hysteresis Loops for (0°C)

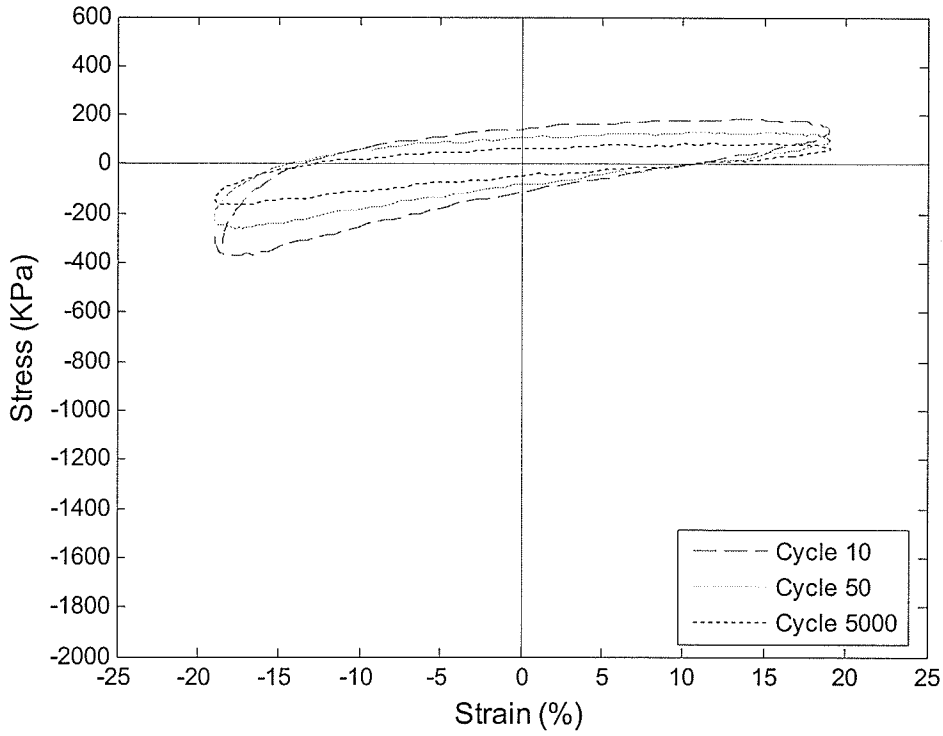

FIGURE 5.19: Sealant G Hysteresis Loops for (0°C)

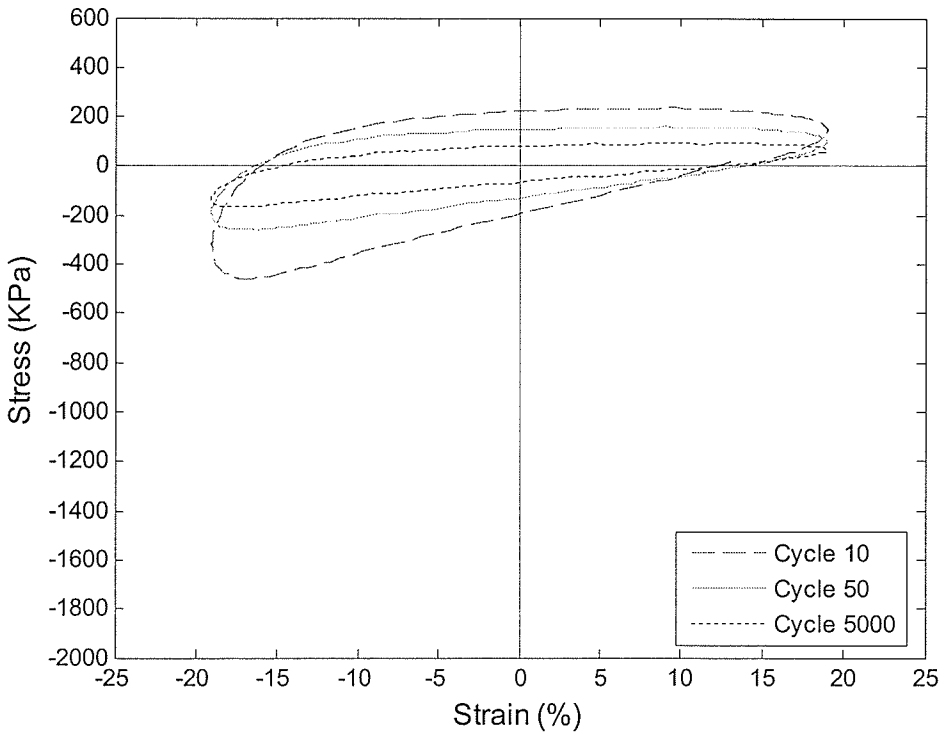

FIGURE 5.20: Sealant H Hysteresis Loops for (0°C)

5.2.3 -30°C Normal Stress Strain Results

Figures 5.21 to 5.28 display the stress strain results from the -30°C tests. At this temperature adhesion failures were noted during both test trials for Sealants A, B and C. These results are highlighted in Figures 5.21 to 5.23. Sealants A and C display distinct failures during the first cycle as the sealant was extended toward the plus 2, an abrupt drop occurred at less than 5 percent strain, the stress dropping to a straight line just slightly into compression due to the weight of the block. These sealants failed in adhesion prior to the maximum tensile strain recorded. Sealants A and C continued to record high values in compression as no material was lost in the failure and the sealants at -30°C were extremely stiff. Sealant B did not record an abrupt failure but the stress values recorded by cycle 5 shows very little resistance to tension. Once the test block was removed from the apparatus adhesion failure was noted.

Sealants D and E recorded much lower stress values than Sealants A, B and C. Sealants D and E did not record any failures during either of the two test trials. Each sealant successfully completed 15 cycles showing only a 40 to 55 percent load drop from the beginning of the test to the end. Similarly as to the above load drop criteria these two sealants recorded much lower stress values over the entire test than the remaining sealants. These two sealants are good candidates for use in Manitoba as they are able to dissipate the induced displacements displaying low stress values and not experiencing any failures.

Sealants F and H both experienced higher initial stress values similar to Sealants A, B and C. Sealants F and H both had one test trial fail in adhesion under the induced displacement. Although no abrupt failure was noted like Sealants A and C, both Sealants F and H realize high initial stress values in both tension and compression, 1000 to 1500 KPa in tension and 2500 to 3000 KPa in compression. These sealants performed satisfactory and would be conditionally considered for use in cold climates. Sealant G did not record any adhesion failure and its initial stress values were lower than both Sealants F and H but higher than Sealants D and E. This sealant experienced 40 percent

load drop in compression and 60 percent load drop in tension. This sealant did not perform as well as Sealants D and E and its results put it closer to Sealants F and H.

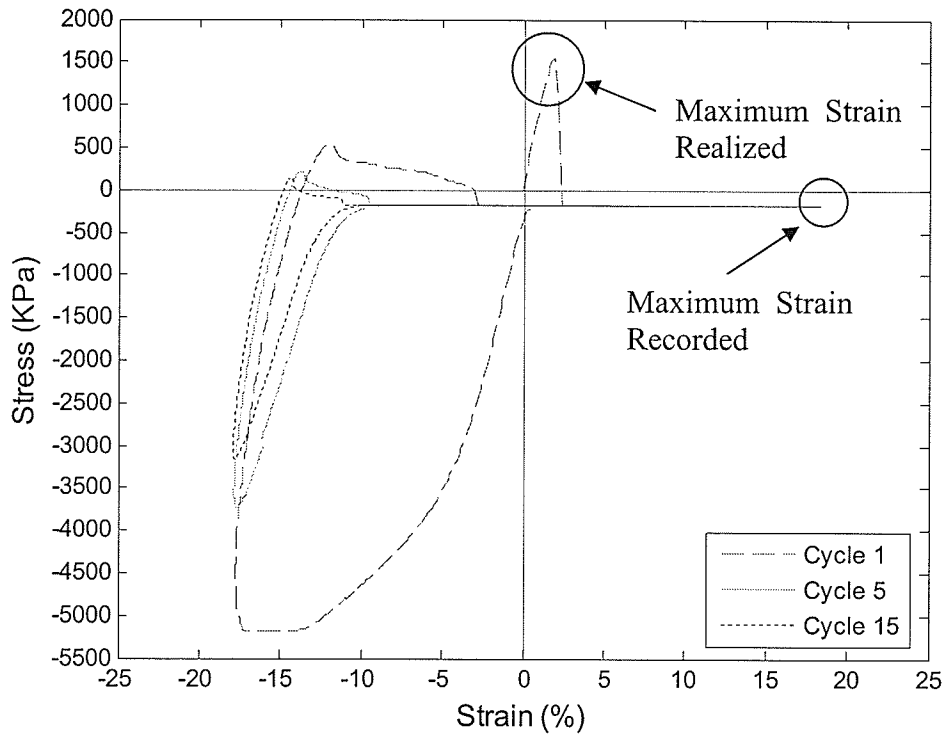

FIGURE 5.21: Sealant A Hysteresis Loops (-30°C)

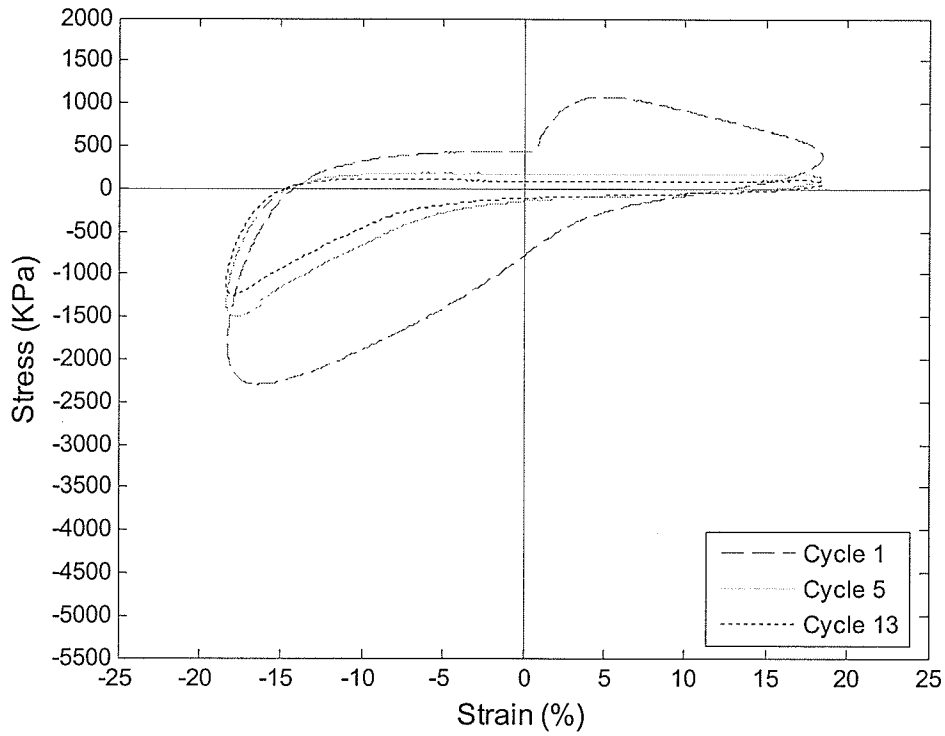

FIGURE 5.22: Sealant B Hysteresis Loops for (-30°C)

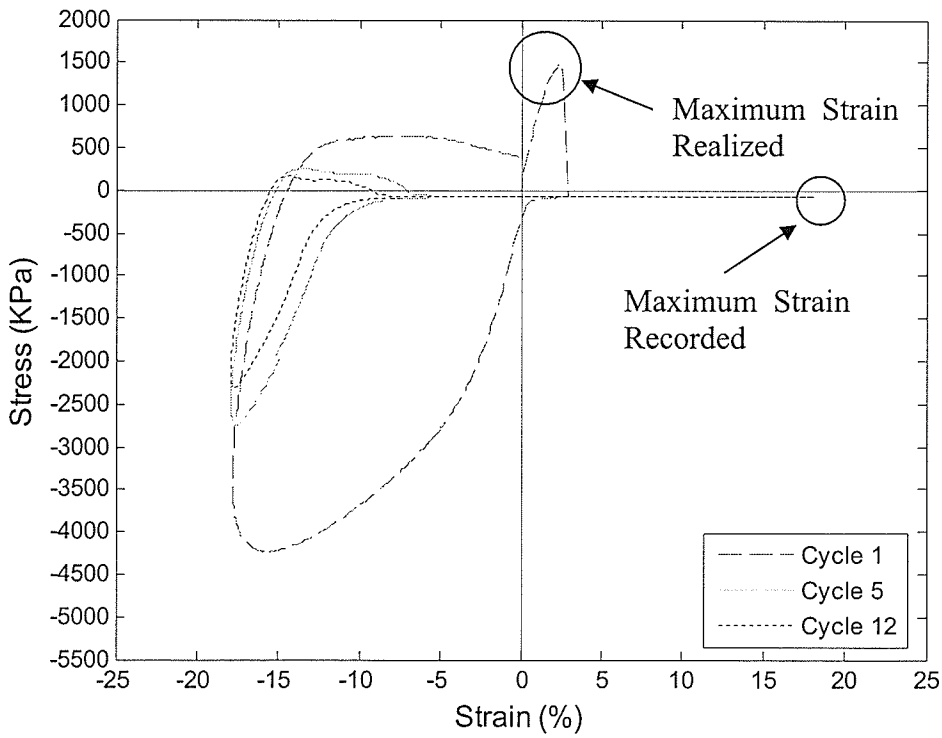

FIGURE 5.23: Sealant C Hysteresis Loops for (-30°C)

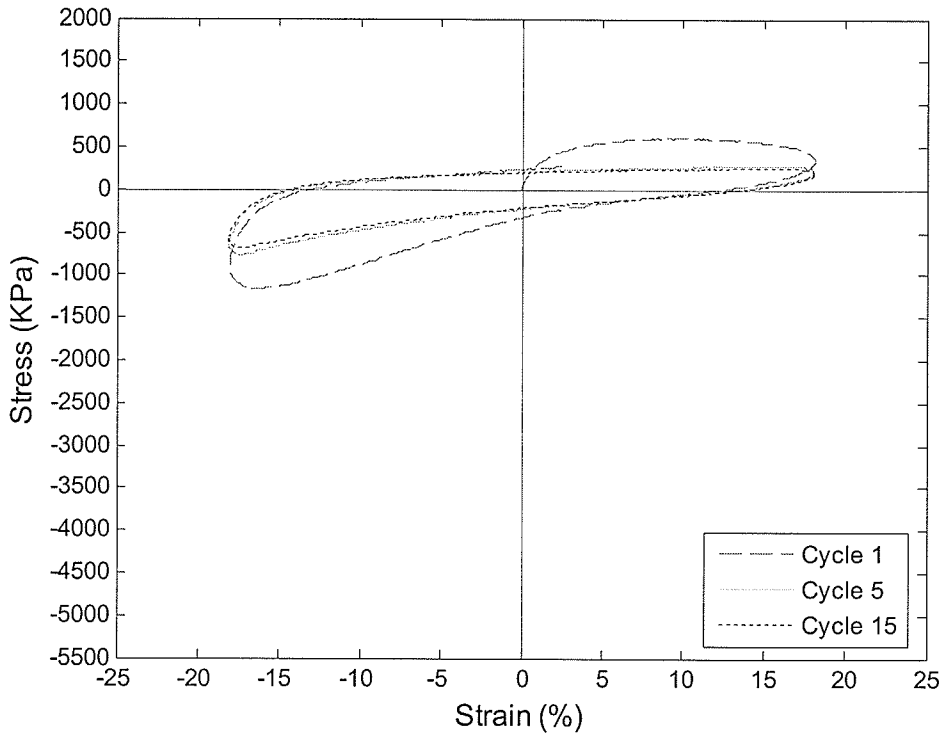

FIGURE 5.24: Sealant D Hysteresis Loops for (-30°C)

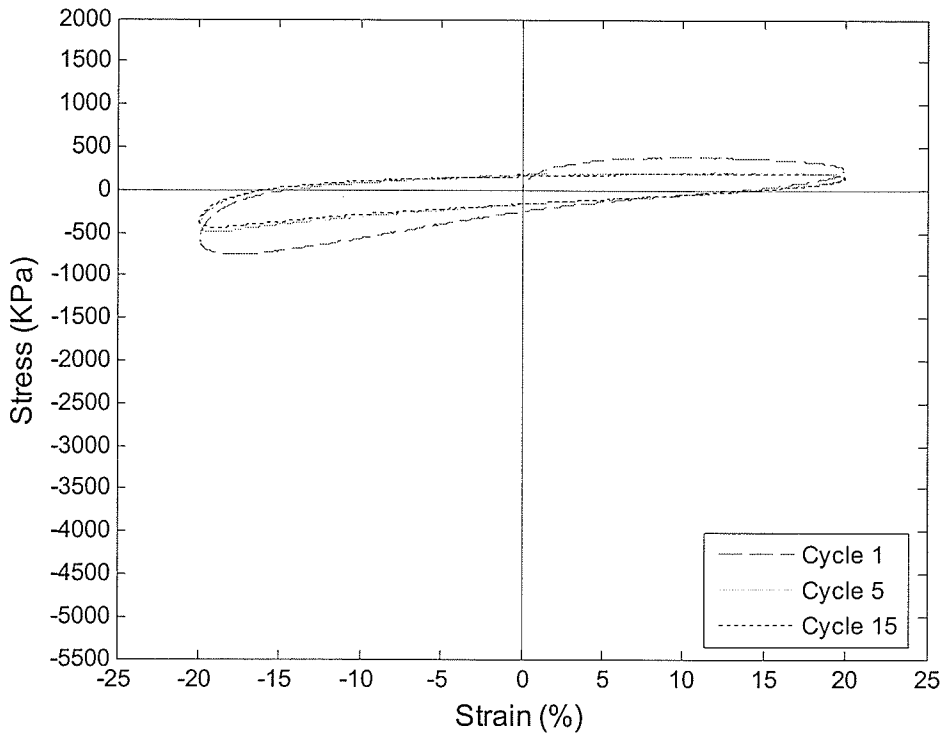

FIGURE 5.25: Sealant E Hysteresis Loops for (-30°C)

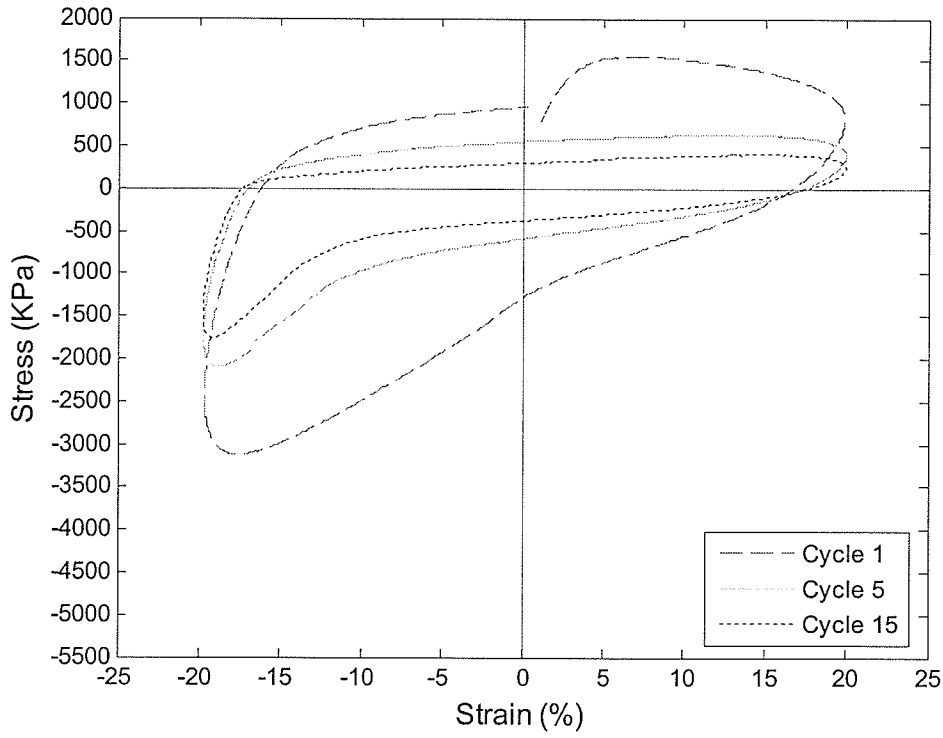

FIGURE 5.26: Sealant F Hysteresis Loops (-30°C)

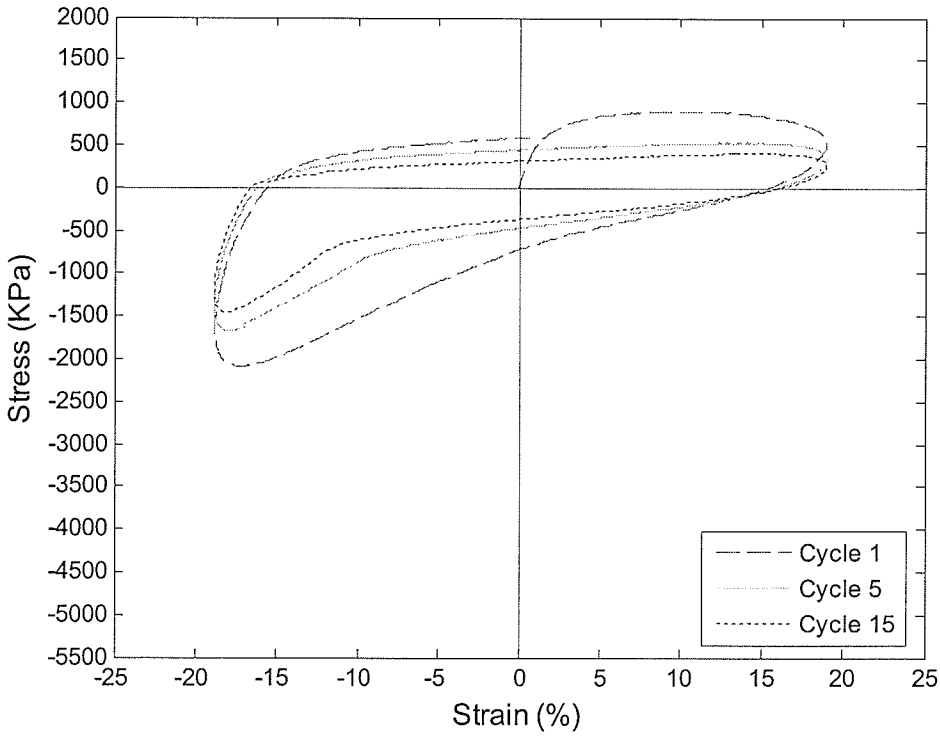

FIGURE 5.27: Sealant G Hysteresis Loops (-30°C)

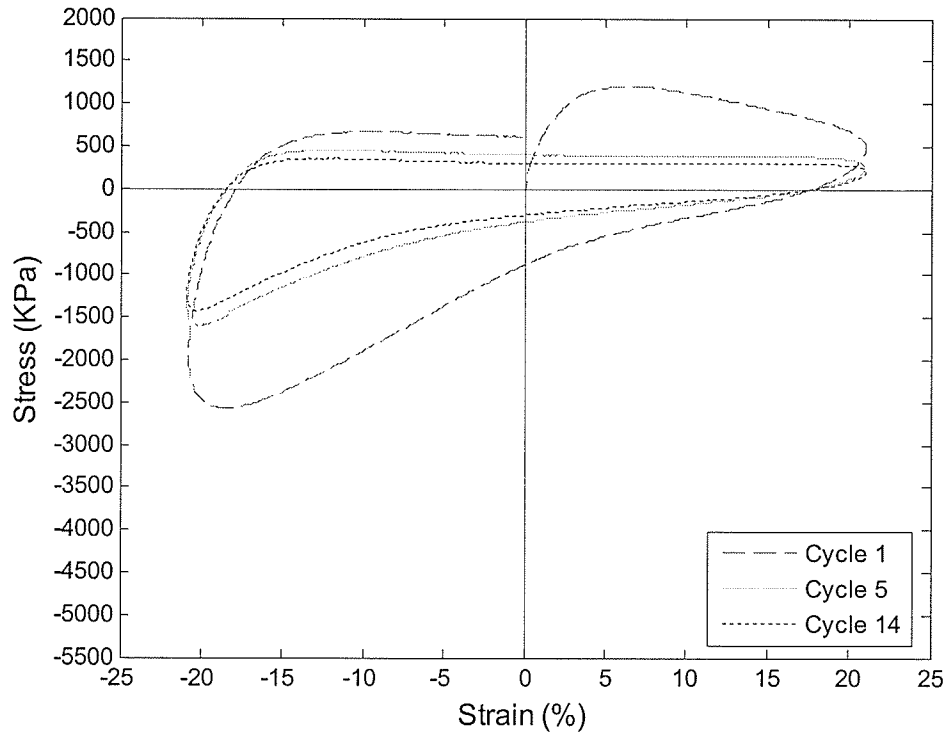

FIGURE 5.28: Sealant H Hysteresis Loops (-30°C)

Ranking of sealants based on the above analysis again allows for a three category grouping. The sealants are grouped into good, satisfactory and poor performance categories and this is displayed in Table 5.2.

TABLE 5.2: Ranking of Sealants based on Normal Stress Strain Results

	+30 Degrees	0 Degrees	-30Degrees
Sealant A	3	3	3
Sealant B	3	3	3
Sealant C	2	2	3
Sealant D	2	1	1
Sealant E	2	1	1
Sealant F	1	1	2
Sealant G	1	1	2
Sealant H	1	1	2

1=Good Performance
 2=Satisfactory Performance
 3=Poor Performance

5.3 Surface Stress Analysis

This is the third criteria for determining the performance of the sealants. Similarly to the normal stress analysis from section 5.2 the definition of stress is obtained by dividing the load by the cross-sectional area of the sealant. The difference between the surface stress analysis and the normal stress analysis is that the cross-sectional area in this case is smaller due to the fact that the shape of the sealant is extending in a curved parabolic shape. A schematic of each test block can be seen in Figure 5.29 and 5.31. From the previous section the normal strain was calculated by dividing the extension and compression by the original length, this ignores the fact that the sealant is extending and compressing in a curved parabolic shape. A better and more accurate result is proposed with the use of a mathematical model developed by Tons in 1959. This model has been analyzed by Lynch (1996) and this section will discuss this model and its benefit to this research. The classifying of the sealants by the resulting surface stress will use the modified cross-sectional area of the sealant taking into greater effect the stiffness of the material.

5.3.1 Surface Strain Theoretical Model

This model is based on maximum strain calculations that detail the suspected relationship between joint movement and sealant configuration. The model assumes the fact that the sealant deforms in a parabolic shape and thus the use of the arc length of the parabola is used to calculate the increase and decrease in the mid-section of the sealant, (Lynch 1996). The assumptions originally made by Tons (1959) were;

- The cross-sectional area of the in-place sealant was rectangular
- The sealant was a liquid-type, homogeneous material that changed shape when extended and compressed by did not change volume.
- The top and bottom free surfaces deformed parabolically and equally as the sealant was extended and compressed
- There was no three sided adhesion, the sealant did not adhere to the bottom of the joint reservoir.
- The strain in the sealant along the parabolic surfaces was uniformly distributed during extension.
- The minimum and maximum joint widths were the maximum strains the sealant would experience regardless of the width of the joint when it was sealed.

Calculations of strain based on the above assumptions

1. Cross-sectional area of the joint

$$J_s = (W_x - W_{\min}) * D_x \quad (5.3)$$

Where

- J_s = the cross-sectional area
- W_x = the width at any extension
- W_{\min} = minimum joint width
- D_x = depth of sealant material in the joint reservoir

2. Area of the parabolic surface

$$A_p = 0.5 * (W_x - W_{\min}) * D_x \quad (5.4)$$

Where

- A_p = area of one of the parabolas (ACB)
- H = the distance from the original sealant to the peak of the parabola

3. Area of a parabola $A_p = 2/3 * H * W_x \quad (5.5)$

4. Calculation of H, solve for H from 5.5 and substitute A_p from 5.4 and H becomes:

$$H = 1.5 * \left(\frac{A_p}{W_x} \right) = \frac{0.75 * D_x * (W_x - W_{\min})}{W_x} \quad (5.6)$$

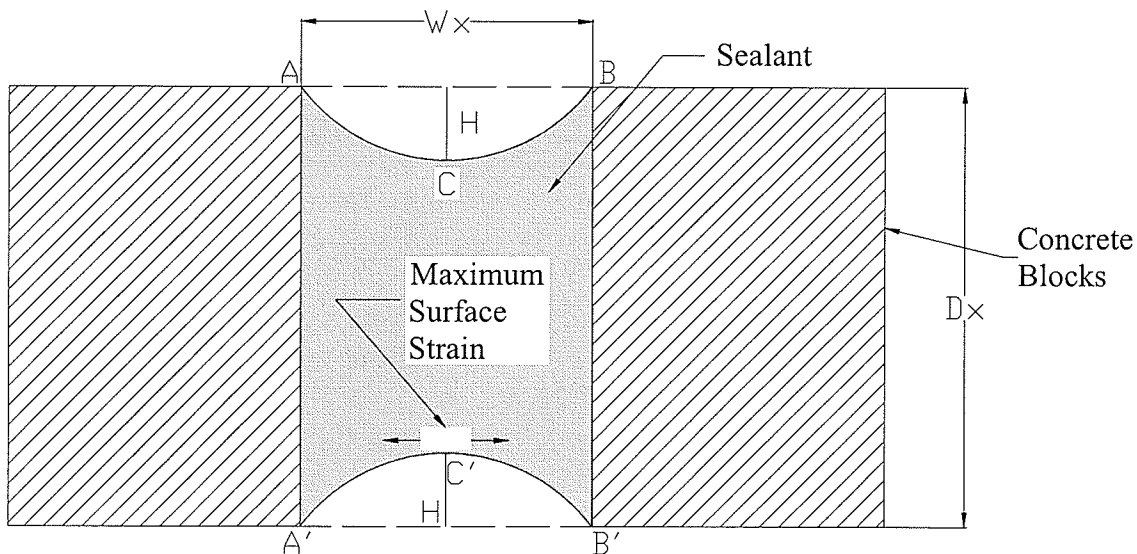

FIGURE 5.29: Maximum Tensile Sealant Configuration

Where

ACB	=	length of parabola
ACBA	=	area of parabola
Dx	=	depth of joint sealant
Wx	=	extended joint width
H	=	maximum recessed depth of sealant surface

5. Defining the arc length of a parabola from the generic parabolic formula

$$Y = aX^2 \quad (5.7)$$

Where $a = \frac{4H}{Wx^2}$ (5.8)

$$X = \frac{Wx}{2} \quad (5.9)$$

Substituting into the definite integral of the function shown in 5.10:

$$L = \int_a^b \sqrt{1 + \left(\frac{dy}{dx}\right)^2} dx \quad (5.10)$$

Where $\frac{dy}{dx} = 2aX$ (5.11)

This makes the definite integral in this case to be:

$$L = \int_0^x \sqrt{1 + 4a^2 X^2} dx \quad (5.12)$$

If 5.8 and 5.9 are substituted into 5.12 the result is 5.13:

$$L = \int_0^{\frac{Wx}{2}} \sqrt{1 + \frac{64H^2}{Wx^4} \frac{Wx^2}{4}} dWx \quad (5.13)$$

Solving 5.13 and multiplying by 2 to get the total arc length:

$$L = \frac{1}{2} \sqrt{Wx^2 + 16H^2} + \frac{Wx^2}{8H} \ln\left(\frac{4H + \sqrt{Wx^2 + 16H^2}}{Wx}\right) \quad (5.14)$$

From the total arc length the calculation of the maximum strain of the sealant at the surface becomes:

$$S_{\max} = \left(\frac{L - W_{\min}}{W_{\min}}\right) * 100 \quad (5.15)$$

Where

Smax	=	the maximum strain in the surface of the sealant
L	=	parabolic arc length (ACB from Figure 5.29)

5.3.2 Surface Strain Calculations

Based on the above calculation for maximum strain at the surface of the sealant, each test was analyzed to produce the maximum tensile and compressive strains. These values are indicated for each sealant in Table 5.3. These values in tension are typically 18 to 20 percent higher than the normal strain values calculated in section 5.2. Conversely in compression the values are virtually nonexistent registering less than 4 percent strain in compression. This is due to the fact this model is looking at the surface strain and as the sealant is compressed the surface of sealant is undergoing tensile strain. A typical look at how the strain is calculated is shown in Figures 5.30 to 5.32.

TABLE 5.3: Maximum Surface Strains in both Tension and Compression

	+30 Degrees Strains (%)		0 Degrees Strains (%)		-30 Degrees Strains (%)	
	Max.	Min.	Max.	Min.	Max.	Min.
Sealant A	38.785	-2.3631	34.532	-2.6203	2.8954	-2.7521
Sealant B	38.028	-2.4054	38.036	-2.4054	33.47	-2.7079
Sealant C	40.443	-2.2793	35.884	-2.5336	2.2133	-3.0213
Sealant D	39.046	-2.3631	37.229	-2.4479	32.246	-2.7964
Sealant E	42.503	-2.1965	42.213	-2.1965	29.552	-3.0213
Sealant F	40.746	-2.2793	38.765	-2.3631	39.038	-2.3631
Sealant G	39.157	-2.3631	35.187	-2.5769	35.373	-2.5769
Sealant H	40.643	-2.2793	35.131	-2.5769	43.588	-2.1555
Average	39.919	-2.3161	37.122	-2.4651	27.297	-2.6743

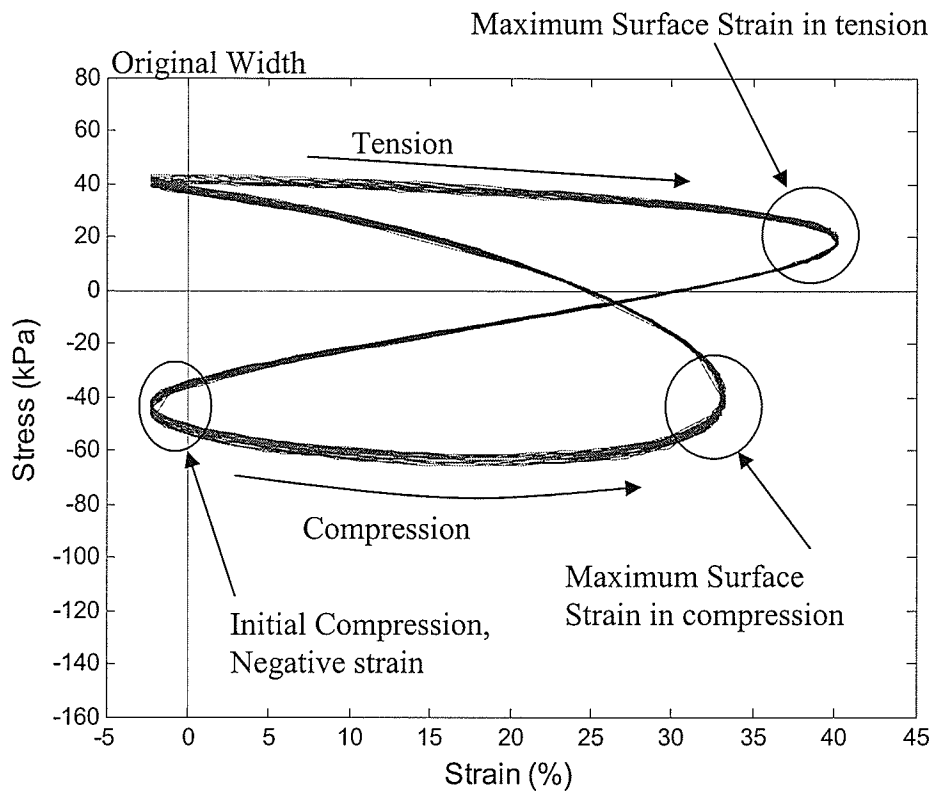

FIGURE 5.30: Typical +30°C Analysis of Surface Strain

Shown in Figure 5.30 the sealant travels from the neutral position, its original width, towards the maximum tensile strain which corresponds with the maximum tensile displacement. The sealant then starts to relax the strain as it travels back to its original width. As the sealant starts to compress the strain becomes negative but due to the fact that this is looking at the surface strain the surface of the sealant begins to go into tension again. The surface fibres are being strained in tension shown in Figure 5.31. This strain is not as critical as the maximum tensile displacement which corresponds to the test results of the sealants that failed, which failed in tension. Figure 5.32, displays the results from Sealant A, which although the test continued to run did not realize the maximum strain. The sealant realized 2.9 percent strain before adhesion failure occurred.

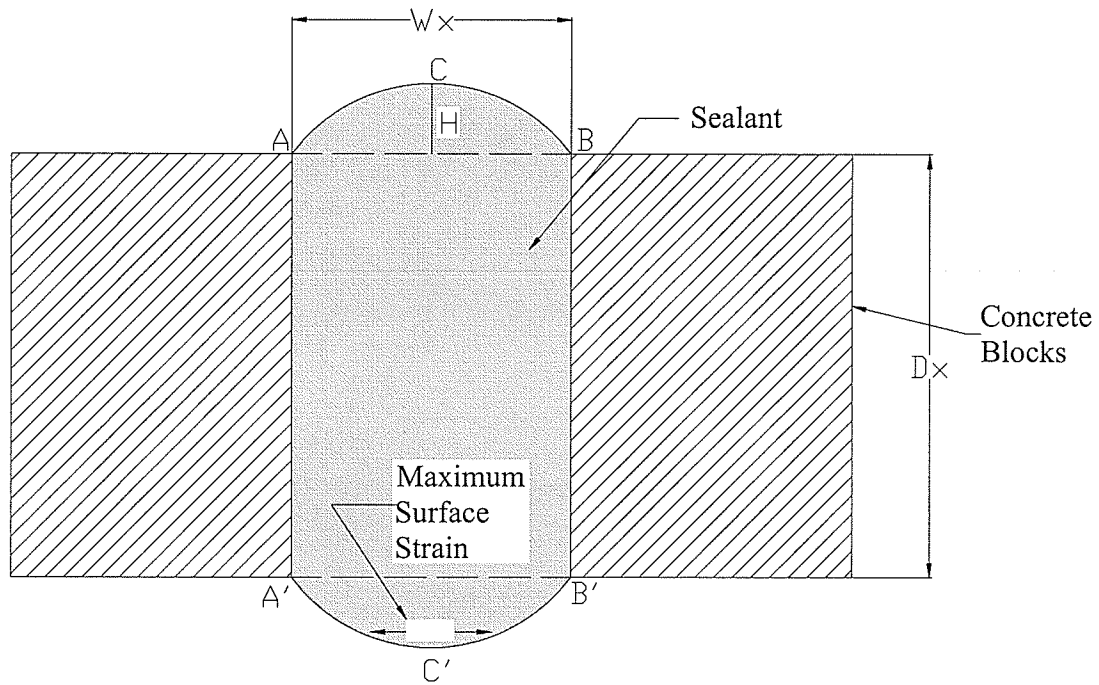

FIGURE 5.31: Maximum Compressive Sealant Configuration

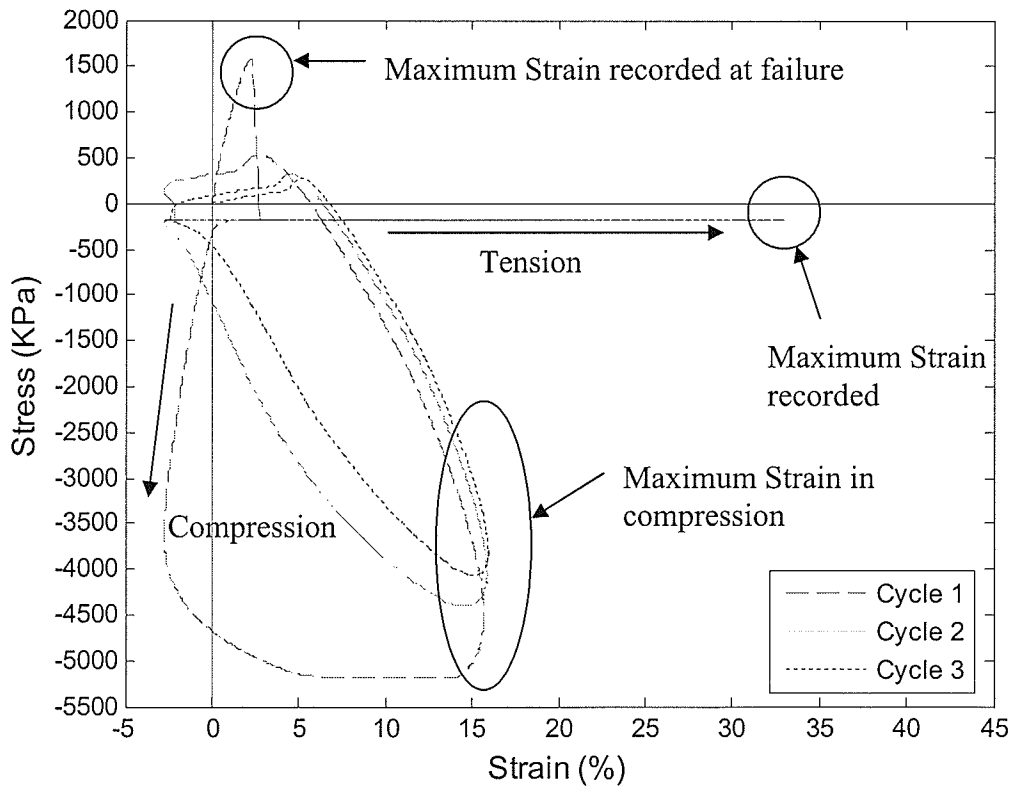

FIGURE 5.32: Sealant A Analysis of Surface Strain at -30°C

5.3.3 Maximum Stress Analysis

From the data analyzed above, a maximum surface stress can be calculated for each sealant. This stress analysis takes into account the narrowing of the cross-sectional area, allowing the calculation of the critical stress. Table 5.4 displays these results and compares the analysis with the maximum calculated values from the normal stress strain analysis. The narrowed cross section was calculated using the original size of the sealant, 50 mm by 50 mm and subtracting from one side only 2*H. This resulted in higher maximum tensile stresses for each of the sealants. The percent difference in stresses was an average of 12 percent higher at +30°C, an average of 7.6 percent higher at 0°C and an average of 5.2 percent higher at -30°C.

TABLE 5.4: Maximum Tensile Stresses at each test temperature

	+30 Degrees		0 Degrees		-30 Degrees	
	Stresses (KPa)		Stresses (KPa)		Stresses (KPa)	
	Max. (narrow)	Max (normal)	Max. (narrow)	Max (normal)	Max. (narrow)	Max (normal)
Sealant A	77.808	69.916	521.73	487.53	1664.8	1624.1
Sealant B	74.07	64.881	528.87	487.08	1177.4	1126.4
Sealant C	65.824	57.46	287.28	276.89	1599.5	1556.7
Sealant D	59.864	52.449	309.27	276.89	701.44	652.13
Sealant E	50.628	44.082	225.28	203.24	495.89	470.4
Sealant F	49.857	43.519	285.09	262.64	1714.5	1614.7
Sealant G	51.915	45.418	203.98	185.55	1022.9	948.78
Sealant H	49.816	43.537	250	236.53	1362	1262.8

5.4 Summary of Results

These analyses have shown that it is possible to categorize the sealants based on percent load drop and stress using two different types of strain analysis. From the first criteria we can see that Sealant D and E perform the best, Sealants A, B and C perform the worst and Sealants F, G and H are in between. The second criteria looks at the normal stress strain results and Sealants D and E maintain lower stress values than all of the other sealants and do not record any adhesion failures. Using the maximum surface strain we can see that the stress and strain values are much higher than the normal stress strain values and it is clear that Sealants A, B and C do not perform well, recording significantly higher stress values than any other sealants. The results are summarized in Table 5.5. Higher

emphasis was placed on the -30°C results for the stress criteria combined with the rankings from the percent load drop. In Manitoba's climate the -30°C temperature is when the most damage occurs within the sealant. Sealants D and E had the best performance at -30°C despite ranked as satisfactory at +30°C. Sealants F, G, and H experienced satisfactory rankings from the % load drop and the -30°C stress criteria, the two performance criteria with the most emphasis placed on them. The +30°C and the 0°C stress criteria were considered secondary as the sealant can heal itself at warm temperatures and fewer problems occur when the joints are closer together.

TABLE 5.5: Ranking of Sealants from all temperatures based on all performance criteria

	% Load Drop	Normal Stress			Surface Stress		
		+30°C	0°C	-30°C	+30°C	0°C	-30°C
Sealant A	3	3	3	3	3	3	3
Sealant B	3	3	3	3	3	3	3
Sealant C	3	2	2	3	2	2	3
Sealant D	1	2	1	1	2	1	1
Sealant E	1	2	1	1	2	1	1
Sealant F	2	1	1	2	1	1	2
Sealant G	2	1	1	2	1	1	2
Sealant H	2	1	1	2	1	1	2

1=Good Performance
 2=Satisfactory Performance
 3=Poor Performance

6 Conclusions and Recommendations for Future Work

6.1 Summary

Performance based laboratory test methods are necessary to characterize sealant behaviour in the field. Field trials are necessary to correlate the results but once a test method has been established and proven, then transportation agencies will be able to test and compare performance of new sealants on the market. Sealant failures are common and to justify the time and cost and to ensure that benefits are realized, agencies need to be aware of the sealants' performance under local conditions.

This thesis developed a test procedure that subjected hot-pour sealants to cyclic loading under three in-service temperatures. This procedure could be used by local transportation agencies wishing to test new materials on the market. This set up does not directly replicate a specified number of years in the field but provides a fatigue test to compare sealants against one another. Eight commercially available hot-pour sealants were tested at -30°C , 0°C and $+30^{\circ}\text{C}$. Each test was run using displacement control in a sinusoidal wave form, with the blocks subjected to plus and minus 2 mm displacement. An environmental chamber was used to maintain the test temperature during each test and at $+30^{\circ}\text{C}$ the test was conducted for 25000 cycles at a frequency of 1 Hz. At 0°C the number of cycles was reduced to 5000 cycles, while maintaining the 1 Hz frequency and at -30°C the frequency was lowered to 0.003 Hz and the maximum number of cycles to 25.

Two types of sealants were tested, Type I sealants and Type IV sealants, according to ASTM D6690. Type I sealants are considered joint and crack sealants capable of maintaining an effective seal in moderate climates. The material tested for low temperature performance at -18°C using 50 percent extension (formerly Specification D 1190). Type IV sealants are considered joint and crack sealants capable of maintaining an effective seal in climates experiencing very cold temperatures. Material is tested for low temperature performance at -29°C using 200 percent extension.

Each test was analyzed to calculate normal stress and normal strain, the parabolic surface strain was also calculated and the corresponding narrowed cross-section was used to calculate the maximum stress experienced by the sealant. The percent load lost over the span of the test was also calculated to allow a comparison of the sealants against one another.

6.2 Conclusions

Comparison of sealants under accelerated laboratory tests can potentially provide information about how each sealant will perform in the field. The test procedure evaluated sealants at three in-service temperatures under cyclic loading conditions, which has shown a distinction between commercially-available types of hot-pour sealants.

From the literature review it is clear that there is a need for correlation of laboratory test trials and field trials. Many laboratory and field trials have been carried out but few conclusions can be taken from the results. The results of this test procedure can be compared to the future data from the field trials and models evaluating field performance can be calculated.

There are currently no standardized laboratory procedures that can simulate field performance. Field trials are long and laborious; costing time and money, the use of a performance based test can allow transportation agencies to assess new materials on the market and their corresponding field performance for local climates.

The results of the laboratory tests indicated that Type I sealants exhibited higher initial load values and also experienced adhesion failure at both the 0°C and -30°C test temperatures. The Type IV sealants generally exhibited lower resistance to load and three of the eight sealants did not show signs of failure at any of the three test temperatures.

Low modulus sealants are typically able to withstand larger extension. The accelerated testing compared sealants subjected to displacements similar to traffic and temperature

loadings in the field. In general, and based on the limited number of sealant products tested, Type I sealants performed poorly when compared to Type IV sealants. Both Type I sealants failed prematurely at the 0°C and -30°C temperatures as well three Type IV sealants failed prematurely at the -30°C test temperature.

During the testing it was found that the concrete blocks were unable to handle the 1 Hz loading at the -30°C test setup. The frequency had to be lowered to allow the test blocks to complete one cycle. The concrete blocks were poured around the four anchor bolts and this caused a shear plane to develop along the top of the bolt heads. As the bolts were tightened into the testing apparatus, some of the concrete blocks sheared a corner off. These blocks were not used in the tests.

The testing at 0°C and -30°C required the use of pressure fed liquid nitrogen tanks and it became clear that the tanks depleted very quickly and had to be replaced once a week while the 0°C tests were being conducted. When the -30°C tests were conducted the tank had to be replaced every 3 days, due to the difficulties with the concrete blocks and rapid depletion of the liquid nitrogen the test frequency was slowed to 0.003 Hz and only 25 cycles were conducted.

Three criteria were used to rank the sealants: percent load drop versus temperature, normal stress analysis and maximum stress analysis. The first criterion used was the percent load drop versus temperature to assess the performance of the sealants. This criterion took into account the sealants ability to dissipate the stress from the cyclic loading as well the sealants' increasing stiffness to the low temperatures. This method allowed the sealants to be grouped into three categories, sealants that performed well, sealants with average performance and sealants with poor performance. From the three criteria, rankings were applied to the sealants as follows: Sealants D and E had good performance, sealants F, G and H performed satisfactory and sealants A, B and C performed poorly. More emphasis was placed on the low temperature results from each criteria which gives better performance rankings to sealants D and E as opposed to sealants F, G and H.

The use of normal stress as a performance criterion was used in this research due to the fact that the cyclic loading was displacement controlled and the use of strain by itself cannot be an indication of performance of these sealants. Sealants A and B performed poorly at all three test temperatures. Sealant C performed satisfactorily at +30°C and 0°C and performed poorly at -30°C. Sealants D and E had satisfactory rankings at +30°C and good rankings at both the 0°C and -30°C test temperature. Sealants F, G and H received good rankings at +30°C and 0°C and satisfactory rankings at -30°C.

The third criteria for determining the performance of the sealants is the maximum surface stress analysis. The sealants maintained the same ranking from the second criteria as the ranking was dependent on the maximum stress values which were calculated by dividing by the cross-sectional area which is narrower due to the extended parabolic shape. The results of using the maximum stress values makes the values larger but does not change each sealants' position from the previous ranking.

6.3 Recommendations for Future Work

This research developed a laboratory test evaluation for hot-poured joint and crack sealants. This is the beginning of a large collaboration of data with field trials and other test procedures such as Dynamic Mechanical Analysis (DMA) to determine the sealants glass transition temperature (T_g), Dynamic Shear Rheometer (DSR) to look at the viscosities of the sealants and tensile loadings to failure.

Further testing on each sealant will be required to determine the ASTM material properties to see if any correlation can be made with the laboratory and field data. This would allow for a more complete set of results

Further improvements need to be made to the design of the concrete block set up. The blocks need to be stronger or larger to handle the shear stresses that develop along the plane of the bolt head. Complete redesign of the concrete block setup could be done to

completely eliminate the need for bolts to be embedded in the blocks. The ability to test the sealants in shear would also be an asset to this procedure. This could be achieved using a modified test setup.

The loading rate for -30°C had to be lowered significantly due to the extreme stiffness of some of the materials, it would be ideal if it was consistent with the 0°C and the +30°C loading rate of 1 Hz. The stiffness of the sealants caused very high stresses in the concrete blocks so the reinforcement of the blocks is one way to deal with this problem.

The laboratory results will be compared to the performance of sealants in the field trial. It was not possible to include field results in this thesis due to the long term nature of the field trial. It is anticipated that this work will be completed by September 2006.

References

1. AASHTO. Guide for the Design of Pavement Structures. Washington, D.C. 1993. pp. II-50.
2. Abd El Halim, A.O., A.G. Razaqpur, A. Shalaby, M. Farha, and G. Argue. Compressive and Tensile Properties of Joint Sealants under Different Temperatures. Proceedings of ASCE/CSCE International Conference on Engineering Materials, Vol. II, Ottawa, Aug. 1997, pp.651-662.
3. Al-Qadi, I.L., S. Aboqudais, and R.E. Khuri. "A Method to Evaluate Rigid Pavement Joint Sealant Under Cyclic Shear and Constant Horizontal Deflections." Transportation Research Record No. 1680, TRB, National Research Council, Washington, D.C., 1999, pp. 30-35.
4. Al-Qadi, I.L., and S.A. Abo-Qudais. "Joint Width and Freeze/Thaw Effects on Joint Sealant Performance", Journal of Transportation Engineering, Vol. 121, No.3 May/June 1995, pp. 262-266.
5. American Society for Testing and Materials. Annual Book of ASTM Standards. Vol. 04.02, American Society for Testing and Materials, Philadelphia, 2003.
6. American Society for Testing and Materials. Annual Book of ASTM Standards. Vol. 04.03, American Society for Testing and Materials, Philadelphia, 2003.
7. American Society for Testing and Materials. Annual Book of ASTM Standards. Vol. 04.07, American Society for Testing and Materials, Philadelphia, 2003.
8. American Society for Testing and Materials. Annual Book of ASTM Standards. Vol. 09.01, American Society for Testing and Materials, Philadelphia, 2003.
9. Bodocsi , A., I. Minkarah, and S.A. Rajagopal. "Analysis of Horizontal Movements of Joint and Cracks in Portland Cement Concrete Pavements." Transportation Research Record 1392. TRB, National Research Council, Washington, D.C., 1993.
10. Burke, M.P. and J.W. Bugler. "Long-Term Performance of Unsealed Joint Concrete Pavements". Transportation Research Board 81st Annual Meeting. Washington, D.C., 2002.

11. Corbett, M.A. and K. Lauter. Field Evaluation of Crack Sealing in a Cold Climate. Canadian Technical Asphalt Association Conference Proceedings, Winnipeg, MB, 2000. pp.193-202
12. Cuelho, E.V., S.K. Ganeshan, D.R. Johnson, R.B. Freeman, and P.L. Schillings. Relative Performance of Crack Sealing Materials and Techniques for Asphalt Pavements. MAIREPAV Conference Proceedings. Guimaraes Portugal, 2003, pp.327-337.
13. Evans, L.D., M.A. Pozsqay, K.L. Smith, and A.R. Romine. LTPP Pavement Maintenance Materials: SHRP Joint Reseal Experiment, Final Report. FHWA-RD-99-142, McLean Virginia, Federal Highway Administration,. September 1999.
14. Evans, L.D., C.A. Good Mojab, A.T. Patel, A.R. Romine, K.L. Smith, and T.P. Wilson. Evaluation of Materials, Procedures, and Equipment for Pavement Maintenance. Proceedings Maintenance Management Conference. TRB, AASHTO, FHWA, Washington, D.C. National Academy Press 1995, pp. 107-121.
15. FHWA (Federal Highway Administration), 1998. Techniques for Pavement Rehabilitation—Reference Manual. 6th Edition, FHWA/HI-98-033, Federal Highway Administration, Washington, D.C.
16. Hand, A.J., K.A. Galal, D.R. Ward, and G. Fang. “Cost-Effectiveness of Joint and Crack Sealing: Synthesis of Practice”, Journal of Transportation Engineering, November/December 2000, pp. 521-529.
17. Hawkins, B.K., A.M. Ioannides, and I.A. Minkarah. “To Seal or Not to Seal?” Transportation Research Record 1749. TRB, National Research Council, Washington, D.C., 2001, pp. 38-45.
18. Huang, Y., Pavement Analysis and Design. Prentice Hall, New Jersey, 1993.
19. Ioannides, A.M., A.R. Long, and I.A. Minkarah. “Joint Sealant and Structural Performance at the Ohio Route 50 Test Pavement.” Transportation Research Board 83rd Annual Meeting. Washington, D.C., 2004.
20. Johnson, D.R., R.B. Freeman and J.R. Stevenson. “Cost-Effectiveness of Crack Sealing Materials and Techniques for Asphalt Pavements”, Transportation Research Record No. 1697. TRB, National Research Council, Washington, D.C., 2000. pp. 31-40.
21. Lynch, L.N. and D.J. Janssen. “Pavement Joint Sealant Specifications—Past, Present, and Future.” Journal of Elastomers and Plastics. Vol. 30, April 1998, pp.161-181.

22. Lynch, L. N. and D.J. Janessen. "Material Characterization of Silicone Sealants." Transportation Research Record No. 1680. TRB, National Research Council, Washington, D.C., 1999. pp. 44-46.
23. Lynch, L.N. Rheological Analysis of Silicone Pavement Joint Sealants. Technical Report GL-96-4, US Army Corps of Engineers, Waterways Experiment Station. February 1996.
24. Manitoba Department of Highways and Transportation. 1995/96 Crack Sealant Evaluation. April 1996.
25. Manitoba Department of Highways and Transportation. 1996/97 Crack Sealant Evaluation Second Year Evaluation Report. June 1997.
26. Marquart, M. Evaluation of Crafcoc Sealant on Asphalt Pavements. Federal Highway Administration ND96-04 H-5-085(004)041; Third Annual Report. North Dakota Department of Transportation. September 2001
27. Masson, J-F. Bituminous Sealants for Pavement Joints and Cracks: Building the Basis for a Performance-Based Specification. Proceedings of the Third RILEM International Symposium. 2000, pp. 315-328.
28. Masson, J-F., P. Collins, and P-P. Légaré. "Performance of Pavement Crack Sealants in Cold Urban Conditions". Canadian Journal of Civil Engineering. Vol. 26, 1999. pp.395-401.
29. Masson, J-F., P. Collins, and M. Lowery. "Temperature Variation in Hot-Poured Sealants During the Sealing of Pavement Cracks." Transportation Research Board 83rd Annual Meeting. Washington, D.C., 2004.
30. Masson, J-F. and M.A. Lacasse. "Effect of Hot-Air Lance on Crack Sealant Adhesion." Journal of Transportation Engineering. July/August 1999, pp.357-363.
31. Masson, J-F., and M.A. Lacasse. A Review of Adhesion Mechanisms at the Crack Sealant/Asphalt Concrete Interface." Proceedings of the Third RILEM International Symposium. 2000, pp.259-274.
32. Masson, J-F., C. Lauzier, P. Collins and M.A. Lacasse. "Sealant Degradation during Crack Sealing of Pavements". Journal of Materials in Civil Engineering. ASCE Vol. 10 No.4, November 1998. pp 250-255.
33. Masson, J-F. and C. Lauzier. Crack Sealant Evaluation: Aging and Performance, (in French). Report A-2016.4. Institute for Research in Construction, National Research Council of Canada, Ottawa, Canada, 1993.

34. Minkarah, I., J.P. Cook, J.F. McDonough and S. Jaghoory. "Effect of Different Variables on Horizontal Movement on Concrete Pavement." American Concrete Institute Journal SP-70, 1982.
35. Morian, D.A, N. Suthahar and S. Stoeffels. "Evaluation of Rigid Pavement Joint Seal Movement". Transportation Research Record No. 1684. TRB, National Research Council, Washington, D.C., 1999. pp.25-34.
36. National Guide to Sustainable Municipal Infrastructure. InfraGuide Innovations and Best Practices: Roads and Sidewalks Guidelines for Sealing and Filling Cracks in Asphalt Concrete Pavement. NRC-CNRC, Federation of Canadian Municipalities. March 2003.
37. Oba, K., Rheological Measurements of Bituminous Materials Using Dynamic Shear Rheometry: Study on Joint Sealant. Report FE-156-800. EMPA, Swiss Federal Laboratories for Materials and Testing and Research, Dubendorf, Switzerland, 1996.
38. Olsen, R. and R. Roberson. Edge-Joint Sealing as a Preventive Maintenance Practice. 2003-26 Final Report Minnesota Department of Transportation, St. Paul, MN. August 2003.
39. Panek, J.R. and J.P. Cook. Construction and Sealant Adhesives, Third Edition. John Wiley, New York, 1991.
40. Peterson, D.E. Resealing Joints and Cracks in Rigid and Flexible Pavements, NCHRP Synthesis of Highway Practice 90. Transportation Research Board, Washington, D.C., 1982.
41. Poblete M., R. Salsilli, R. Valenzuela, A. Bull and P. Sparatz. "Field Evaluation of Thermal Deformations in Undoweled PCC Pavement Slabs." Transportation Research Record No. 1207. TRB, National Research Council, Washington, D.C., 1988.
42. Rogers, A.D., P. Lee-Sullivan and T. Bremner. "A Method of Fatigue Testing of Concrete Highway Joint Sealants in Shear". Journal of Testing and Evaluation. Vol. 26, No. 3. May 1998. pp. 234-239.
43. Rogers, A.D., P. Lee-Sullivan and T. Bremner. "Selecting Concrete Pavement Joint Sealants. I: Proposed Test Protocol." Journal of Materials in Civil Engineering. November 1999, pp. 302-308.
44. Rogers, A.D., P. Lee-Sullivan and T. Bremner. "Selecting Concrete Pavement Joint Sealants. II: Case Study." Journal of Materials in Civil Engineering. November 1999, pp. 309-316.

45. Seibel, C., Jr. Testing Is Priority One, But Successful Joint Sealant Field Performance Depends Upon Many Other Procedures and Practices as Well. Proceedings of the Pavement Systems Division Workshop—Crack and Joint Sealing for Rigid and Flexible Pavements. USAE Waterways Experiment Station, Vicksburg, MS, May 1992.
46. Smith, K.L., M.A. Pozsgay, L.D. Evans and A.R. Romine. LTPP Pavement Maintenance Materials: SPS-4 Supplemental Joint Seal Experiment, Final Report. FHWA-RD-99-151, Federal Highway Administration, McLean, Virginia. October 1999.
47. Van Dam, T.J., S. Reay, M. Appleyard and M.J. Eacker. “Development of a Laboratory Screening Test for Asphalt Pavement Crack Sealants”. Transportation Research Record No. 1680. TRB, National Research Council, Washington, D.C. pp.36-43.
48. Woo Lee, S. and S.M. Stoffels. “Effects of Excessive Pavement Joint Opening and Freezing on Sealants.” Journal of Transportation Engineering, ASCE, July/August 2003, pp.444-450.
49. Zanzotto, L. Laboratory Testing of Crack Sealing Materials for Flexible Pavements. Transportation Association of Canada Research Report, 1997.

APPENDIX A

MTGS Evaluation Methods for the Surfaced Roadway Network

Evaluating Manitoba's Surfaced roadway network

For the purpose of pavement management, Manitoba's surfaced roadway network has been further subdivided into the following categories.

Bituminous Expressways	Bituminous expressways
Bituminous Arterials	Bituminous Primary and Secondary Arterials
Bituminous collectors	Bituminous Collectors
Ast Roadways	All asphalt surface treated roadways
Concrete Roadways	All concrete + bituminous over concrete roadways

Bituminous Expressways

8 Condition States

Cracking	Good	0,S0,S1,S2,M0,M1,X0
	Poor	S3,M2,M3,X1,X2,X3
IRI	Good	≤ 1.6
	Poor	> 1.6
Subgrade Defects	Good	$\leq 0.5\%$
	Poor	$> 0.5\%$

Bituminous Arterials

12 Condition States

Cracking	Good	0,S0,S1,S2,M0,X0
	Fair	S3,M1,M2,S2
	Poor	M3,X2,X3
IRI	Good	≤ 2.4
	Poor	> 2.4
Subgrade Defects	Good	$\leq 0.5\%$
	Poor	$> 0.5\%$

Asphalt Surface Treatment Roadways (AST)

16 Condition States

Cracking	Good	0,S0,S1,S2,M0,M1,M2,X0,X1
	Poor	S3,M3,X2,X3
IRI	Good	≤ 3.0
	Poor	> 3.0
Subgrade Defects	Good	$\leq 2\%$
	Poor	$> 2\%$
Surface Defects	Good	$\leq 10\%$
	Poor	$> 10\%$

Bituminous Collectors

24 Condition States

Cracking	Good	0,S0,S1,S2,M0,X0
	Fair	S3,M1,M2,X0
	Poor	M3,X2,X3
IRI	Good	≤ 3
	Poor	> 3
Subgrade Defects	Good	$\leq 1\%$
	Poor	$> 1\%$
Surface Defects	Good	$\leq 5\%$
	Poor	$> 5\%$

Appendix "B"

Regular Maintenance

Those 1000 series surface activities, which are essential to achieving the service life of bituminous[†] pavements but are not intended to influence surface condition rating scores.

- 100 Spray patching
- 101 Strip sealing
- 103 Crack filling
- 104 Asphaltite Repairs
- 109 Pitch and run
- 110 Hand Patch
- 111 Wheel Rut repair
- ### Spot machine patching (<= 5%)
- 131 Spot failure repair

Effective Treatment vs Distress Bituminous Surfaces	Cracking	Surface	Rutting	Subgrade	IRI
Reconstruction	Y	Y	Y	Y	Y
Thin Overlay	Y	Y	Y	N	Y
Sealcoating	Y	Y	N	N	?
Full Microsurfacing	Y	Y	Y	N	Y
Wheel path Micorsurfacing	Y	?	Y	N	Y
Deep Patching	N	N	N	Y	N
Bit. patching by machine	Y	Y	?	?	Y
Rout & seal	Y	N	N	N	N
Routine maintenance	N	N	N	N	N

Y = Yes N = No ? = Need time series data

[†] Bituminous, seal over bituminous, road mix

Appendix "C"

Rutting

The collection of network rutting is contracted out. Rutting is processed in accordance with **ASTM E 1703/E 1703M – Standard Test Method for Measuring Rut-Depth of pavement surface using a straightedge.**

Rutting is measured on northbound and eastbound lanes on all but 600 series surfaced roadways. The rut score for each segment is based on the average reported depth of 100m sections within each segment.

Determined Rut Values

Field	Comments
LRUT_MEAN	Use all of the values in the field that fall within the bounds of the segment. Calculate the average and place in the SCR database.
RRUT_MEAN	Use all of the values in the field that fall within the bounds of the segment. Calculate the average and place in the SCR database.
LRUT_SD	Use all of the values in the field that fall within the bounds of the segment. Calculate the average and place in the SCR database.
RRUT_SD	Use all of the values in the field that fall within the bounds of the segment. Calculate the average and place in the SCR database.
Left mode	Use the values in the field LRUT_MEAN and determine the predominant reading from all of the readings. Place the predominant reading value in the SCR database in a field called LRUT_MODE. In case of a tie use the higher value.
Right mode	Use the values in the field RRUT_MEAN and determine the predominant reading from all of the readings. Place the predominant reading value in the SCR database RRUT_MODE. In case of a tie use the higher value.

Determine Rutting Scores

Determine the start and end of the condition segment in the SCR database and establish the readings from the automated database. Use the MAX of each LRUT_MEAN and RRUT_MEAN data pair to represent each 100-meter portion of the segment.

Based on the values in the chart below categorize all of the readings into the number of readings in each severity.

Severity	Range
Slight	0 mm to <10 mm
Moderate	10 mm to <= 20 mm
Extreme	> 20 mm

(Number of rut measurements in category / total number of rut measurements)*100

SLIGHT_RUT	% OF SLIGHT RUTS (2 DECIMAL PLACES)
------------	-------------------------------------

MODERATE_RUT	% OF MODERTE RUTS (2 DECIMAL PLACES)
EXTREME_RUT	% OF EXTREME RUTS (2 DECIMAL PLACES)
RUT_SCORE	$MODERATE_RUT + (2 * EXTREME_RUT)$

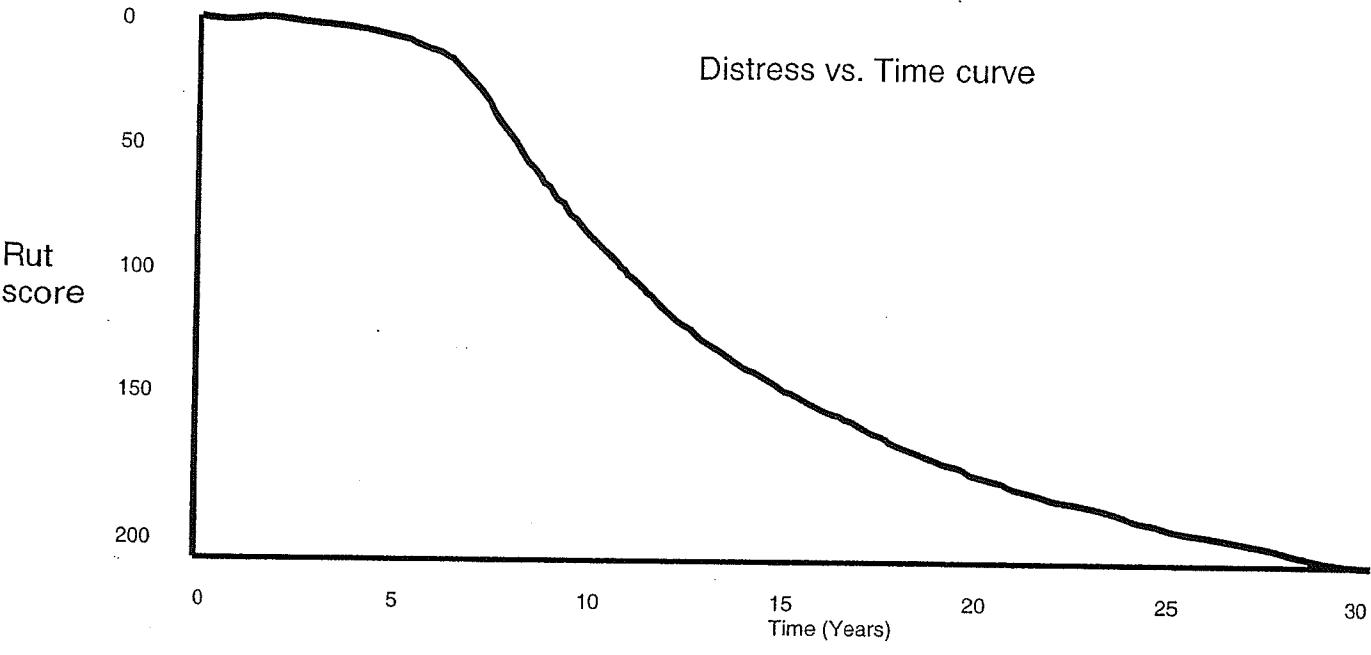

International Roughness Index (IRI)

IRI scores are arrived at by applying logic similar used to derive the segment rutting score.

The highest 100-m average score recorded from each wheel path is used to calculate the IRI score for the segment. This represents a “worst case” average. This method is proposed because from a user perspective, the deviation from ride comfort can not readily be interpreted between wheel paths.

The IRI score represents the mean of the “worst case” 100-m averages recorded for a roadway segment.

This scoring method differs to that proposed in the 2001 TAC report, “Standardization of IRI Data Collection and Reporting in Canada”. That report proposed scoring the IRI based on the mean of the left and right wheel paths.

Data collected during the last 2 seasons indicates that the outside wheel path exhibits a consistently higher IRI than the inside wheel path.

Surface Condition

The surface condition score for the roadway segment represents the percentage of area within a segment displaying distress associated with pavement wear. Raters carry out a visual inspection of the roadway surface and using measuring wheels and odometers record individual areas of distress. The approximated sum of bleeding, edge loss, raveling and block cracking associated with severe oxidation are captured. The total sum is then divided into the overall area of the segment to produce a % of distress.

Subgrade Condition

The subgrade condition score for the roadway segment represents the percentage of area within a segment displaying distress associated with inadequate subgrade support. Raters carry out a visual inspection of the roadway surface and using measuring wheels and odometers record individual areas of distress. The approximated sum of shoving, pot holing, and wheel path block cracking associated with excessive deflection are captured. The total sum is then divided into the overall area of the segment to produce a % of distress.

Cracking

Cracking scores for each roadway segment represents the most predominant type of cracking present in that segment.

The cracking score represents the average type of crack, as well as the amount of that type of crack occurring.

There are three (3) crack types of crack severity reported:

Slight (S) < 5mm in average width

Moderate (M) 5mm-10mm average width

Extreme (X) >10mm average width.

Each severity in turn is coupled with 1 of 4 possible extent identifiers to signify the quantity of the predominant cracking exhibited

The Extent of cracking is categorized as:

0	<= 1% by area
1	>1% & <= 6%
2	> 6% & <= 15%
3	>15%

Example: A roadway with a score of M2 means that the roadway exhibits predominantly moderate cracks, and they occur in 6-15% of the surfaced area.

APPENDIX B

Laboratory Schedule for Each Sealant

Sealants	Block #	Date Poured	Date Tested	Test Temp (C)	# of Cycles	Block Separation (mm)	Notes
Sealant A	1	June 7/04	June 8/04	30	18650	10.0	Adhesion failure noted Top block cracked, stroke 0.5mm out in comp. Adhesion failure noted Adhesion failure noted Adhesion failure noted
	2	June 7/04	June 9/04	30	20050	9.6	
	3	June 7/04	June 14/04	30	3513	9.9	
	4	June 7/04	Aug. 18/04	0	5000	10.5	
	5	June 7/04	Aug. 19/04	0	5050	10.6	
	6	June 7/04					
	7	Aug. 19/04	Aug. 30/04	-30	6	10.6	
	8	Aug. 19/04					
	9	Aug. 19/04	Aug. 27/04	-30	16	10.9	
	10	Aug. 19/04					
Sealant B	1	June 24/04					Block cracked during install, okay Adhesion failure noted 3300 cycles Adhesion failure noted Test ended due to adhesion failure Adhesion failure noted
	2	June 24/04	June 28/04	30	18564	10.1	
	3	June 24/04	June 30/04	30	18479	9.9	
	4	June 24/04					
	5	June 24/04	Aug. 16/04	0	5600	9.9	
	6	June 24/04					
	7	Aug. 17/04	Aug. 19/04	0	5050	10.1	
	8	Aug. 17/04	Aug. 24/04	-30	14	10.8	
	9	Aug. 17/04					
	10	Aug. 17/04					
	11	Aug. 25/04	Aug. 31/04	-30	12	13.0	
	12	Aug. 25/04					
Sealant C	1	June 25/04	July 5/04	30	20600	9.4	Small crack on bottom brick, results okay Concrete shattered after one cycle Failure occurred during the first cycle Adhesion failure noted
	2	June 25/04	July 9/04	30	20650	9.8	
	3	June 25/04	Aug. 18/04	0	5000	10.4	
	4	June 25/04					
	5	June 25/04	Aug. 30/04	-30	1	10.1	
	6	June 25/04	Aug. 17/04	0	5000	10.3	
	7	Aug. 19/04	Sept. 9/04	-30	8	11.5	
	8	Aug. 19/04	Aug. 30/04	-30	12	11.0	

Sealants	Block #	Date Poured	Date Tested	Test Temp (C)	# of Cycles	Block Separation (mm)	Notes	
Sealant D	1	June 8/04	June 11/04	30	25302	9.0	No apparent difference in longer test Ran out of LN2 - did not use these results	
	2	June 8/04	June 10/04	30	25271	9.6		
	3	June 8/04	Jun. 14,15/04	30	71600	9.7		
	4	June 8/04	Aug. 12/04	0	17000	10.4		
	5	June 8/04						
	6	June 8/04						
	7	Aug. 13/04	Aug. 25/04	-30	21	11.0		no adhesion failure noted
	8	Aug. 13/04						
	9	Aug. 13/04						
	10	Aug. 13/04	Aug. 17/04	0	5050	10.1		
	11	Aug. 13/04	Aug. 18/04	0	5000	10.2		
	12	Aug. 13/04	Aug. 24/04	-30	21	10		no adhesion failure noted
Sealant E	1	June 16/04					No failure noted No failure noted	
	2	June 16/04	June 21/04	30	25026	9.6		
	3	June 16/04	Aug. 19/04	0	5050	10.1		
	4	June 16/04						
	5	June 16/04	June 23/04	30	25341	9.5		
	6	June 16/04	Aug. 19/04	0	5000	9.6		
	7	Aug. 18/04	Sept. 8/04	-30	21	11.5		
	8	Aug. 18/04	Sept. 8/04	-30	24	10.0		
	9	Aug. 18/04						
	10	Aug. 18/04						
Sealant F	1	June 30/04	Aug. 11/04	0	25400	9.6	(results discarded), bolts not tight	
	2	June 30/04	Aug. 10/04	0	25000	9.9		
	3	June 30/04	July 8/04	30	25325	10.1		
	4	June 30/04	Aug. 9/04	0	21360	10.2		Span +/-1 mm (results discarded)
	5	June 30/04	July 6/04	30	25823	9.8		Bottom block slightly cracked (no worries)
	6	June 30/04						
	7	Aug. 11/04	Aug. 24/04	-30	11	10.8		Test ended due to adhesion failure
	8	Aug. 11/04						
	9	Aug. 11/04	Aug. 16/04	0	5000	10.0		Keep these results
	10	Aug. 11/04						
	11	Aug. 25/04	Aug. 31/04	-30	17	10.0		Adhesion failure noted
	12	Aug. 25/04						
	13	Aug. 25/04						

Sealants	Block #	Date Poured	Date Tested	Test Temp (C)	# of Cycles	Block Separation (mm)	Notes
Sealant G	1	July 5/04					
	2	July 5/04	July 7/04	30	25250	9.9	Keep these results
	3	July 5/04					
	4	July 5/04	July 12/04	30	26088	10.5	Results slightly out of range, do not use
	5	July 5/04	July 13/04	30	29200	10.0	Keep these results
	6	July 5/04	Aug. 16/04	0	5000	9.6	Blocks in fridge
	7	Aug. 16/04					
	8	Aug. 16/04	Aug. 17/04	0	5000	10.1	
	9	Aug. 16/04	Aug. 25/04	-30	21	10.5	No adhesion failure noted
	10	Aug. 16/04	Aug. 25/04	-30	21	10.2	No adhesion failure noted
Sealant H	1	Aug. 31/04	Sept. 2/ 04	30	24514	9.8	
	2	Aug. 31/04					
	3	Aug. 31/04	Sept. 10/04	-30	14	9.5	No failure noted
	4	Aug. 31/04	Sept. 1/04	30	23814	11.0	
	5	Aug. 31/04	Sept. 9/04	-30	21	10.0	Adhesion failure noted
	6	Aug. 31/04	Sept. 9/04	-30	21	11.0	No failure noted
	7	Aug. 31/04	Sept. 10/04	0	5050	9.0	No failure noted
	8	Aug. 31/04	Sept. 10/04	0	5050	10.5	No failure noted