

THE UNIVERSITY OF MANITOBA

AN INVESTIGATION OF THE THREE-DIMENSIONAL
FORCE AND MOMENT DESIGN PARAMETERS OF
SELECTED ORTHODONTIC ALIGNMENT LOOPS

BY

DONALD KENNETH MEADOR

A THESIS

SUBMITTED TO THE FACULTY OF GRADUATE STUDIES
IN PARTIAL FULFILMENT OF THE REQUIREMENTS FOR THE DEGREE
OF MASTER OF SCIENCE

DEPARTMENT OF PREVENTIVE DENTAL SCIENCE

WINNIPEG, MANITOBA

MAY, 1982

AN INVESTIGATION OF THE THREE-DIMENSIONAL
FORCE AND MOMENT DESIGN PARAMETERS OF
SELECTED ORTHODONTIC ALIGNMENT LOOPS

BY

DONALD KENNETH MEADOR

A thesis submitted to the Faculty of Graduate Studies of
the University of Manitoba in partial fulfillment of the requirements
of the degree of

MASTER OF SCIENCE

© 1982

Permission has been granted to the LIBRARY OF THE UNIVER-
SITY OF MANITOBA to lend or sell copies of this thesis, to
the NATIONAL LIBRARY OF CANADA to microfilm this
thesis and to lend or sell copies of the film, and UNIVERSITY
MICROFILMS to publish an abstract of this thesis.

The author reserves other publication rights, and neither the
thesis nor extensive extracts from it may be printed or other-
wise reproduced without the author's written permission.

Abstract

Alignment loops are commonly used in clinical orthodontics, and yet little is known about the actual forces and moments generated by such loops. In particular, the relationship between these forces and loop geometry are very imperfectly understood. It is in this context that this project was undertaken to elucidate the three-dimensional force system developed through configurational changes in selected alignment loops. Optimum geometry may then be related to the delivery of an ideal force system for given clinical requirements of tooth movement.

The use of a measuring system developed at the University of Manitoba allowed for the simultaneous measurement of the three-dimensional forces and moments generated at the center of resistance of the defined model tooth. This data was then reduced to a workable form through the computation of slope values relating forces and moments to the primary force.

Analysis of the data obtained through vertical and bucco-lingual activations of the selected alignment loops, results in the following conclusions.

- (1) Horizontal additions of wire are most effective in altering the stiffness value of a loop to occluso-gingival activations.
- (2) Vertical additions of wire are most effective in altering the stiffness value of a loop to bucco-lingual activations.

- (3) Helical additions to a loop are of little value in force control and may result in an increase in spurious moment magnitudes.
- (4) All loop configurations investigated generated spurious forces upon activation. The magnitude and direction of these forces is dependent upon the design of the loop itself.
- (5) The rotational stiffness of the loop configuration is an important factor in determining the direction and magnitude of developed moments.
- (6) The L-loop configuration offers the versatility of differential moment magnitude at its supports.

DEDICATION

THIS THESIS IS DEDICATED TO MY CHILDREN
KRIS AND KARINE. I PRAY WE ARE ABLE TO
RECAPTURE TIME TOGETHER LOST OVER THE
PAST 28 MONTHS.

ACKNOWLEDGEMENTS

Many people were involved in the successful completion of this manuscript. I would like to express my sincere gratitude to them all, not only for their help in the preparation, but most importantly for their friendship.

A special kind of thanks is due my wife and best friend Margie, for her continual encouragement and understanding as I was out chasing a dream.

TABLE OF CONTENTS

CHAPTER		PAGE
I	REVIEW OF LITERATURE	1
	Introduction	1
	Historical - Clinical	2
	Analytical	14
	Experimental	18
	Conclusion	23
II	STATEMENT OF THE PROBLEM	25
III	MATERIALS AND METHOD	26
	Introduction	26
	Measuring System	26
	Programs	28
	Activation System	31
	Loops Tested	33
	Mounting	42
	Experimental Procedures	45
	Data Analysis	48
IV	RESULTS	50
	Introduction	50
	Symmetrical Loop Configurations	51
	a) Occluso-gingival Activations	51
	i) Variation of the H parameter in a vertical loop	52
	ii) Variation of the D parameter in a vertical loop	55

CHAPTER	PAGE
iii) Helical additions to a vertical loop	59
iv) Variation of the L parameter in a T-loop ..	63
v) Variation of the d parameter in a T-loop ..	66
b) Bucco-lingual Activations	69
i) Variation of the H parameter in a vertical loop	69
ii) Variation of the D parameter in a vertical loop	70
iii) Helical additions to a vertical loop	76
iv) Variation of the L parameter in a T-loop ..	79
v) Variation of the d parameter in a T-loop ..	82
Asymmetrical Loop Configuration (L-loop)	85
a) Occluso-gingival Activations	85
i) Centered L-loop	85
ii) L-loop one millimeter from the active tooth bracket	88
iii) Reversed L-loop one millimeter from the active tooth bracket	90
b) Bucco-lingual Activations	91
i) Centered L-loop	93
ii) L-loop one millimeter from the active tooth bracket	95
iii) Reversed L-loop one millimeter from the active tooth bracket	97
V DISCUSSION	100
Introduction	100
Vertical Activation	103
a) Stiffness value	104
b) Spurious forces	106

CHAPTER	PAGE
c) Rotational effects around the x-axis	111
d) Rotational effects around the y-axis	112
e) Rotational effects around the z-axis	114
f) Summary	117
Horizontal Activation	119
a) Stiffness value	119
b) Spurious forces	120
c) Rotational effects around the x-axis	122
d) Rotational effects around the y-axis	123
e) Rotational effects around the z-axis	124
f) Summary	124
VI CONCLUSION	127
REFERENCES	129
ADDITIONAL BIBLIOGRAPHY	134

LIST OF FIGURES

FIGURE		PAGE
1	General view of instrumentation	27
2	Flow diagram of data aquisition program	29
3	Flow diagram of data analysis program	30
4	General view of measuring instrument	32
5	Vertical loop with variation of parameter "H"	35
6	Vertical loop with variation of parameter "D"	36
7	Vertical loop with 1½ turn helix at the apex	37
8	Vertical loop with 1½ turn helices	38
9	T-Loop with variation of parameter "L"	39
10	T-Loop with variation of parameter "d"	40
11	L-Loop	41
12	Axis system used in the measuring instrument	44
13	Plot of moments generated with a buccal activation of a 10 mm vertical loop	102
14	Vertical misalignment of a vertical loop in an occlusal direction	108
15	Vertical misalignment of a vertical loop in a gingival direction	108
16	L-Loop occlusally activated	110
17	Reversed L-loop occlusally activated	110
18	Illustration of moments about the z-axis	116
19	Graphic illustration of the effect of parameter variation on force generation along the y-axis	118
20	Graphic illustration of the effect of parameter variation on force generation along the z-axis	125

LIST OF TABLES

TABLE		PAGE
I	Experimental blocks	49
II	Force and moment relationships for centered vertical loop occlusally activated; variation of parameter "H"	53
III	Force and moment relationships for centered vertical loop gingivally activated; variation of parameter "H"	54
IV	Force and moment relationships for centered vertical loop gingivally activated; variation of parameter "D"	57
V	Force and moment relationships for centered vertical loop gingivally activated; variation of parameter "D"	58
VI	Force and moment relationships for centered vertical loop occlusally activated; helical additions	61
VII	Force and moment relationships for centered vertical loop gingivally activated; helical additions	62
VIII	Force and moment relationships for centered T-loop occlusally activated; variation of parameter "L"	64
IX	Force and moment relationships for centered T-loop gingivally activated; variation of parameter "L"	65
X	Force and moment relationships for centered T-loop occlusally activated; variation of parameter "d"	67
XI	Force and moment relationships for centered T-loop gingivally activated; variation of parameter "d"	68
XII	Force and moment relationships for centered vertical loop buccally activated; variation of parameter "H"	71
XIII	Force and moment relationships for centered vertical loop lingually activated; variation of parameter "H"	72
XIV	Force and moment relationships for centered vertical loop buccally activated; variation of parameter "D"	74
XV	Force and moment relationships for centered vertical loop lingually activated; variation of parameter "D"	75
XVI	Force and moment relationships for centered vertical loop buccally activated; helical additions	77

TABLE		PAGE
XVII	Force and moment relationships for centered vertical loop lingually activated; helical additions	78
XVIII	Force and moment relationships for centered T-loop buccally activated; variation of parameter "L"	80
XIX	Force and moment relationships for centered T-loop lingually activated; variation of parameter "L"	81
XX	Force and moment relationships for centered T-loop buccally activated; variation of parameter "d"	83
XXI	Force and moment relationships for centered T-loop lingually activated; variation of parameter "d"	84
XXII	Force and moment relationships for centered L-loop vertically activated; "toe" of loop directed mesially	87
XXIII	Force and moment relationships for L-loop (1.0 mm from active tooth) vertically activated; "toe" of loop directed mesially	89
XXIV	Force and moment relationships for L-loop (1.0 mm from active tooth) vertically activated; "toe" of loop directed distally	92
XXV	Force and moment relationships for centered L-loop horizont- ally activated; "toe" of loop directed mesially	94
XXVI	Force and moment relationships for L-loop (1.0 mm from active tooth) horizontally activated; "toe" of loop directed mesially	96
XXVII	Force and moment relationships for L-loop (1.0 mm from active tooth) horizontally activated; "toe" of loop directed distally	99

Review of Literature

Introduction:

An orthodontic correction involves tooth movement, a process initiated by application of a force and continued through to completion with the dissipation of this force over the desired distance parameter. Force magnitudes with respect to desired types of tooth movement are controversial (Ackerman et al., 1969; Hixon et al., 1969; Hixon et al., 1970). Recent research has indicated that lighter forces may be more efficient than heavier ones, but no precise generalization relating force magnitude to type of tooth movement has been established (Gianelly and Goldman, 1971). However, uncontroversial is the fact that in order to generate movement of a desired type, a force system of appropriate magnitude and direction must be applied to a tooth. Yet so little is qualitatively or quantitatively known of the mechanically active appliance systems in use today. Tooth movement is in fact a three dimensional mechanical process, and as such, the appliances used in orthodontics should be analyzed in three dimensions.

Orthodontic alignment loops are one aspect of the wide range of mechanical systems that have been discussed in the literature with respect to their ability to generate certain desired tooth movements. Originally developed as a means of reducing the inter-bracket stiffness of the chosen elastic member component, recent literature has focused upon the design parameters of such loops for the generation of desired forces and moments. As such their development and analysis

can be examined from three perspectives:

- (1) historical-clinical,
- (2) analytical,
- (3) experimental.

Historical-Clinical:

The use of inter-tooth elastic member loops to move teeth dates back to Matteson (1888), who presented to the profession a sectional loop configuration which he believed developed a persistent and controllable action in minor operations for the correction of dental irregularities. The appliance was a compound coil and lever spring made of piano-wire, the diameter of this wire being determined by the degree of expansive power desired to be exerted. The diameters of the coils and the lengths of the levers were determined by the positions and relations of the teeth to be moved, while the distance of the coils from each other depended upon the circumstances of the case. Matteson felt that ideally the coils should be made small and the levers short, in order that the device might lie close to the teeth upon which it is intended to act. He also felt that this type of methodology, for pushing apart two teeth, would spuriously yield a resultant lateral displacement of neighboring teeth in the arch.

The placement of loops in a continuous arch was advanced by J. Lowe Young (1916), as a means of removing molars from lingual cross-bite, rotating one or both molars in either direction, or moving inci-

sors bodily forward. The appliance was a modification of Angle's pin and tube mechanism, and consisted of a female and a male component. The female portion entailed a vertical tube, either square or elliptical in design, soldered to the buccal surface of the molar band, the long axis of the tube and the tooth being coincident. The male portion of the appliance was an extension of spring metal which accurately inserted into the female component and was located just distal to the vertical loop. Lowe Young proposed this method of attachment for all deciduous and mixed dentition cases where it was found necessary to lengthen the dental arch on either side. Adjustments were performed by opening or closing the vertical loop such that when the appliance was sprung into place and locked, gentle pressure was exerted in two directions, owing to the tendency of the wire to return to its original shape. Hence, root movement of the anchor teeth could be attained in any direction.

The methodology of Lowe Young was looked upon with disfavour by E.H. Angle (1916), who at that time was proposing the use of a screw mechanism attachment to the molar teeth to generate root movement and anchorage. Angle was concerned that "instead of the force being delivered evenly to the anchor tooth and in one direction only, as is easily possible with the screw, the direction of force is constantly changed, thus mischievously disturbing the function of the cells of the periodontal membrane and alveolar process" (1928). Angle felt that frequent removal and replacement of the loop mechanism would yield only further distortion of the desired clinical results. He

also cautioned against the use of vertical loops in the region of the canine teeth, fearing excessive resorption of the incisor roots would result.

With Angle's (1912) introduction of the ribbon arch, the screw force was again available for lengthening the archwire from molar to molar and for opening up spaces in the buccal aspects of the dental arches, and hence the idea of the vertical loop was lost in history. However, Angle's (1928) development of the edgewise arch appliance led to the re-introduction of the vertical loop by Strang (1933) as an efficient means of localized separation of dental units. The methodology involved cutting the edgewise continuous arch at the desired point and soldering a vertical looped wire component between the two cut-ends. As such Strang felt he had evolved "an auxiliary vertical loop in harmony with the fundamental principles of dynamics and physiology, and that would most efficiently effect divergent movements of the units of the dental arch from any given point". He felt that Lowe Young's use of a vertical loop, with attachment of the arch to a vertical tube on the molar, was the "most dangerous modification" of appliances for tooth movement ever suggested because:

"(1) the method of fixation was conducive to the marked jiggling of anchor teeth and incisors and was rendered even more vibratory by the addition of considerably more wire in the form of a vertical loop.

(2) the technique suggested for obtaining force through the use of this auxiliary was by loop bending. The enlargement of the

loop was attended by deflections of the lines of force that were excessive when multiplied by the distance between the loop and the posterior point of attachment.

- (3) the location of these loops was often at points in the archwire where the lines of force diverged almost at right angles, making force control practically impossible.
- (4) attachment methodology through vertical tubes and pins augmented, to a marked degree, the diversified effects of loop bending.
- (5) the delicate, unsupported 0.030 inch round wire used permitted unknown deflections of the lines of force."

Strang felt that his modification of the edgewise arch would overcome all the maladies of Lowe Young's mechanism in that it would limit the action of the force system to an anterior and posterior direction through correct principles of anchorage attainment. The horizontal form of the bracket slot, accurately engaging the rectangular archwire at points closely related to the loop was seen as providing this control. However, Strang cautioned against universal use of this appliance and as such tabulated a list of rules of caution. Vertical loops

- (1) are contraindicated in the canine region of the archwire where the lines of force emanating from their action are divergent.
- (2) should never be used except in conformity with the principles of the ideal archwire form.
- (3) should never be used without correct principles of anchorage.

(4) should never be modified in form, for the purpose of establishing force action, except by ligature traction, and when this activity has expended itself the resting archwire should be of an ideal typical conformation.

(5) should not be used unless it is possible to retemper the archwire after soldering.

(6) should be made as small as possible for their size has great influence upon force control.

Tweed (1941) adopted the use of Strang's vertical spring loop in the treatment of mixed dentition cases, that had suffered premature loss of teeth and space. To prevent the forward displacement of the anterior segment as the force in the loop developed, he advocated the use of second order bends mesial to the loop, and the use of Class III mechanics and headgear. Tweed also used the vertical loop mechanism for closing spaces between teeth, making sure that the anterior segment between the loops was stepped gingivally so as to overcome the inherent distal tipping.

Begg's (1956) introduction of a thin round archwire technique, to carry out universal tooth movements with light forces, involved the bending of the archwire into shapes that would allow it to perform all required orthodontic tooth movements. Modification of the archwire shape with the addition of loops was advocated for a number of reasons (Sims, 1972):

- 1) improved resiliency of the appliance between adjacent teeth.
- 2) reduction in the number of customary clinical adjustments.

3) diminished force values applied to provide improved control over the individual movements and

4) rapid tooth movement.

Vertical loops were used to align and unravel crowded, rotated anterior teeth, but were never placed distal to the canines. Ideal positioning was suggested to involve placement midway between the neighbouring teeth, while length and width parameters of six to eight mm. in height and 1 mm. in width were advocated (Begg and Kesling, 1977). Begg felt that all tooth movements could be performed simultaneously with these loops, but cautioned against inaccurate forming and activation due to the rapidity with which the teeth could be moved into undesired positions. This caution was extended by Sims (1972) who felt that failure to maintain anchorage, impingement of the ends of the loop on the gingival tissue, dramatic changes in the shape of the dental arch, and inadequate bite opening are detrimental responses due to uncontrolled loop units. Sims also expressed the need for a clear understanding of the reciprocal interactions derived from loops such that they too may be more readily controlled.

In a paper discussing the methodology of contouring loops to obtain force control in all three planes of space, Stoner (1960) stated that placement of loops in an archwire allows control to be established over direction, degree, duration and distribution of forces in the appliance such that efficient tooth movement may be anticipated. Any loop will automatically increase the range of activity, this activity being dependent upon two types of force built up in the

loop itself:

(1) the spring of legs which act as independent levers and may be activated in any direction.

(2) activity developed in the curvature at the apex of the loop.

Usually the action of any loop will depend upon a combination of the two.

Stoner (1960) proposed five rules as being applicable to all loops:

1) any loop will reduce forces and increase range,

2) any loop may be contoured "open" or "closed",

3) loops are most efficiently activated through compression of the legs,

4) the force of any loop may be reduced by coiling the wire at the apex one or more times. This coil (helix) does not alter in any way the directional activity, shape, or function of any loop,

5) the force reduction generated is in direct proportion to the increase in the amount of wire between the brackets.

In discussion of specific loop configurations, Stoner (1960, 1975) felt that the vertical loop yielded a force reduction in only the labiolingual direction of activation. For occlusogingival movements, he proposed the use of a horizontal loop, a loop formed in such a manner that its active legs are parallel to the archwire itself. The omega loop was also seen as an alternative to the vertical loop in that it distributes stresses more evenly through the curvature of the

loop instead of concentrating these stresses at the apex. Stoner felt its use would entail generation of a bodily root thrust to the last tooth in the arch.

Stoner (1960) proposed that the most efficient range of activity of the horizontal loop was generated when the legs of the loop are compressed. and that double the force reduction could be obtained by further contouring the horizontal arm into the form of a T-loop. The T-loop was then seen as eliminating the undesirable tipping that occurred with the other loops, and being able to elevate or depress the dental unit in a true vertical plane. A combination of vertical and horizontal components combined into a single loop was also seen as providing the benefit of both vertical and horizontal legs and hence the advantage of optimum force control in all three planes (Stoner, 1975).

Stoner (1960) cautioned with regard to certain inadequacies in the operational function of loops, for although they increase force control of the appliance, complication of treatment may result from their overuse. To this end he proposed the use of more conventional designs, and the standardization of loop parameters to standardize predicted force potential.

Burstone et al. (1961) emphasized that although the mechanical properties of a wire partly determine its action, the primary factor in the delivery of a continuous force is the design of the spring itself. Adequate design of orthodontic loops should involve consideration of:

- (1) relationship between force and deflection,
- (2) load at which permanent deformation occurs,
- (3) range of activation within the elastic limit.

Design of the loop is also influenced by inherent limitations within the oral cavity and as such may be unsuitable for clinical purposes if it is:

- (1) irritating to the soft tissues,
- (2) unhygienic,
- (3) uncomfortable,
- (4) overly complicated to fabricate and use.

As regards the effect of loop design on the release of a relatively constant force to initiate a desirable tissue response, Burstone et al. (1961) stated:

- 1) modification of the linear configuration of a wire offers the greatest potential in altering the rate and allowable working load of a spring,
- 2) modification of a cantilever along its length by the placement of coils or loops reduces spring rate without affecting allowable load,
- 3) the load-deflection rate in a cantilever modified with a helix is determined by the diameter of the helix, the number of turns in the helix, and the length of the cantilever,
- 4) elimination of sharp bends in the design of a loop enhances its elastic properties,
- 5) with respect to the linear configuration of a spring. optimal

design is influenced by the distribution of the wire rather than simply by the total amount of the wire utilized,

- 6) loading of a spring or loop in the same direction as it was originally wound increases the elastic range.

The clinical application of spring design is seen as a two-step procedure, involving first the establishment of a realistic maximum working load, and secondly the selection of the type of alloy, wire cross-section, and linear configuration of the wire such that this working load may be most efficiently obtained.

Jarabak and Fizzell (1972) found the loop appliance to be the most versatile of any of the basic systems of force applications and as such could be used to induce tooth movement in a variety of ways in either first-order or second-order mechanics. Loops are seen as working most efficiently in a direction of activation perpendicular to their legs, with the force from these cantilever arms giving direction to the whole force system. The cross-sectional geometry of the wire, modulus of elasticity, diameter, number of turns of the helix, and the length of the arms then determine the force magnitude of the highly elastic system. They felt that a large helix incorporated into the loop in an appropriate position will decrease the force magnitude, as will the incorporation of longer cantilever arms.

Jarabak and Fizzell (1972) classified loops as:

- (1) vertical
- (2) horizontal
- (3) transverse.

Vertical loops are seen as performing most efficiently for tooth movement in an anteroposterior direction; horizontal loops move dental units in a vertical direction; transverse loops are most efficient for mediolateral changes.

In a comparison of the loops, Jarabak and Fizzell found the helical component of the loop generated increased flexibility, but that the increase was insignificant with respect to whether 1 1/2 or 2 1/2 turns of wire were added at the reflex point. The loops tested were:

- (1) a simple loop,
- (2) a helical loop with 1 1/2 helical turns of wire at the apex,
- (3) a helical loop with 2 1/2 helical turns of wire at the apex.

Analysis involved load-deflection measurements. The effective stiffness of a loop was then suggested as being determined mainly in the region of the right-angle bends.

Restrained lateral extensions in a simple vertical loop were seen as increasing the stiffness of the appliance two-hundred percent, and as such, a short length of wire between a bracket and a right-angle bend becomes a principle factor in determining the stiffness of the loop. Jarabak and Fizzell thus suggested that flexibility of the appliance will be increased by appropriate placement of helices in the area of a right-angle bend.

Jarabak and Fizzell (1972) discussed the fact that reciprocal forces from looped arches are not well documented, and are clinically significant when provision for neutralizing them is omitted. These forces are seen as being not unmanageable and may be minimized by

bracket angulation or by the placement of compensating bends in the appliance.

Thurrow (1982) states that orthodontic wires are formed into loops to provide:

- (1) altered elastic properties to the archwire.
- (2) hooks or stops for various mechanical procedures.

Loops are seen as functioning by elastic bending of the wire, with loop form providing reduced stiffness, increased working range, and control over which direction the first two provisions operate. Mathematically, he claims the stiffness of a loop is inversely proportional to the square of the length of the arms, the range is directly proportional to the length of the arm, and the strength is inversely proportional to arm length. As regards the incorporation of helices into loop design, Thurrow states:

- "1) the length of wire incorporated into a helix has an inverse effect on stiffness and a direct effect on the working range. but it has no effect on strength.
- 2) the effect of increasing the diameter of a helix is the same as increasing the number of coils.
- 3) using extra turns of wire in the helix is merely another means of increasing wire length.
- 4) placement of helices where the arms of a loop join the horizontal arch will reduce any tipping action of the loop."

Loops are also seen as only providing flexibility in directions that lie at right angles to the arms of the loop, and any loop that is

activated in the direction of winding will function more efficiently than a loop that is unwound in activation.

Ricketts et al. (1979) proposed that loops be introduced into the mechanical orthodontic system when some additional elastic force, other than the wire deflection, would be desirable. Various loop designs are then suggested in order to lower load-deflection rates, to produce a range of movement, and also to eliminate the unknown and uncontrollable frictional forces present in any type of sliding mechanism.

Analytical:

In 1932 Steiner advocated an analytical approach to the mechanical discussion of the principles of orthodontic appliances in general, such that an understanding of force control could be developed. He felt that only then could an ideal appliance be designed in which not only would power be stored, but also distributed to the appropriate dental unit, evenly and continuously, with a measured and constant intensity. This feeling was reiterated by Burstone et al. (1961), who felt that the development of orthodontic appliances should be determined by an analytical approach involving physical and engineering principles, rather than a trial and error procedure. However, it was not until 1970 that an analysis of this type did in fact appear in the orthodontic literature.

In 1970, Waters examined the mechanics of finger and retraction springs incorporated into removable orthodontic appliances. The

analysis procedure involved:

- (1) the breakdown of the appliance into component parts which are amenable to analysis.
- (2) the consideration of the shearing forces and bending moments necessary to maintain the equilibrium of each part.
- (3) the determination of the deformation of each component under the forces and couples required for equilibrium.
- (4) the summation of the deformations of the component parts in terms of an arbitrary and externally applied force or load.

The load-deflection relationships thus derived were then checked experimentally on enlarged models of the appliances. Waters was thus able to propose, that subject to the normal assumptions of simple beam theory, the load-deflection characteristics of both the finger and buccal-canine retraction springs are expressible in terms of the physical parameters E (modulus of elasticity) and I (second moment of area), and the dimensions of the constituent parts of the springs.

Through the adoption of simple beam theory, and the assumption that each component of the loop is straight and the span symmetrical and centrally loaded, Waters (1975, b) determined that the characteristics of the span were affected by the design of the loop itself. The major contribution to flexibility was found in the loop, this flexibility being increased by the lengthening of the sides or the base. The stiffness of the looped arch was predicted to depend on the plane of deflection, with the ratio of stiffness between horizontal and vertical deflection again being most dependent on the design char-

acteristics. For vertical loops, vertical deflections are seen as being more sensitive to changes in width of the base of the loop, and horizontal deflections are more sensitive than vertical ones to changes in the height of the loop.

Again using an extension of simple beam theory, Waters (1976. b), in a study of the mechanics of plain and looped arches, found that for vertical loops activated vertically the stiffness increased by approximately 40% for every one mm. decrease in the arm length of a 6 mm. loop, and decreased approximately 25% for every mm. increase in the width of a 3 mm. base. However, no matter what the parameters of the loop, the archwire with vertical loops was always found to be more flexible than a straight arch of the same material.

Koenig and Burstone (1974) used generalized beam theory, and a computer program capable of predicting the force systems and the deformed shape of any arbitrary curved or twisted beam in three planes of space, to analyze a lingual arch, a vertical loop, and a Burstone rectangular loop. The 0.016 inch round 8 mm. vertical loop, when activated as a retraction spring, was shown to possess an activation distance of only 1.362 mm. before it yielded at a bending moment of 1860 gm.mm. This activation yielded a 506 gm. force and 1040 gm.mm. moment on the cuspid. The rectangular loop activated to its yield point provided an intrusive force of 230 gm. and a moment of magnitude 250 gm.mm. on the cuspid. The authors thus concluded the low moment to force ratio of the rectangular loop would allow the use of this design to produce a single force in bracket geometries which produce

moments in straight-wire applications.

Yang and Baldwin (1974) reported on a computer assisted finite element procedure for the analysis and design of orthodontic springs.

Two loops used for space closure were analyzed:

(1) a 0.017 x 0.022 inch vertical loop with a vertical component of 10 mm. and an interbracket distance of 8 mm. The two ends are assumed to be restricted from vertical movement and rotation.

(2) a retraction loop used at Indiana University.

For the finite element analysis the vertical loop was idealized by twenty-eight elements, while the Indiana retraction loop was idealized by one-hundred and two. Both springs were then analyzed using different loading and boundary conditions. The results showed the Indiana retraction loop to be more efficient in providing controlled tipping followed by root correction. The results were then compared to experimental laboratory findings, and shown to be compatible.

DeFranco et al. (1976) reported on an incremental procedure for three-dimensional large displacement analysis of orthodontic appliances. Analysis of a vertical loop and a rectangular loop, using this non-linear analysis, demonstrated higher end forces, lower end moments, and less possible activation than when a linear small deflection analysis was used. The authors felt that significant geometry changes, which may occur as a result of large clinical activations, would be reflected in this analysis, thereby resulting in a more accurate prediction of the delivered force systems. As such the analysis

was proposed for prediction of force-displacement characteristics of orthodontic appliances that have complex spatial configurations subjected to three-dimensional activations.

Grief et al. presented an abstract in 1978 which introduced a new three-dimensional finite element mechanics computer program. The basis of the program was that any structure may be analyzed as a number of discrete elements tied together at connecting nodal points. Six degrees of freedom were incorporated to describe each node, three deflections and three rotations. Several retraction springs and T-loops were stated to have been tested, the results indicating non-linear load-displacement characteristics for large displacements. However, no results of this work have ever been published in the literature.

Experimental:

Storey and Smith (1952), in a classical "in vivo" experiment, measured the amount of tooth movement that occurred at both the active and reactive ends of a fixed mandibular cuspid retraction appliance. The numerical value of tooth movement was obtained with reference to a fixed point in the maxilla, while force generation from the spring used was assessed by calibration of a load-deflection plot. Light springs were stated as applying 175-300 gms. of force, while heavy springs were in the 400-600 gms. range. Results obtained from five patients were seen as indicating an optimum range of force values to produce a maximum rate of tooth movement.

Halderson et al. (1953) reported on experimental measurements of the forces generated with the mesio-distal activation of a vertical loop. The measuring device consisted of a transducer (to convert the force measurement to electrical energy), an amplifier, and an ink-writing oscillograph to provide a written record of the measurements. An "in vivo", one millimeter activation of a vertical loop, fabricated of 0.0215 x 0.0275 inch steel edgewise archwire, resulted in a force measurement of 800 gm. This led the authors to conclude that the load generated through this mechanism was unduly excessive, and should be modified by using smaller-sized edgewise wires, or by using wires of a softer alloy, for all vertical loop procedures.

Burstone et al. (1961), in a theoretical discussion and experimental analysis of the principles involved in the design of low-gradient springs, described an instrument capable of simultaneous uniplanar load and deflection measurements. Analysis of the data obtained from various spring configurations allowed the authors to conclude that the confirmation of theoretical considerations by experimental data indicates the possibility of predicting the force characteristics of an appliance through nonempirical methods.

Newman (1963), using an Instron measuring device to plot tensile strength test diagrams, determined that an eight mm. 0.016 inch stainless steel wire vertical loop had a 2.3 ounce reduction in force for every mm. of unloading. Similarly, an eight mm. vertical loop of 0.021 x 0.025 inch stainless steel wire had a 15.2 ounce reduction for every millimeter of movement. Accordingly, it was stated that the

lower the load-deflection rate of a spring, the more constant the force during deactivation.

Mahler and Goodwin (1967) investigated the mechanical properties of seven different types of manufactured 0.018 inch round orthodontic wires which were bent into four loop configurations, both heat-treated and non heat-treated. The samples were stressed in an Instron tensile testing instrument, and evaluation was based upon the elastic deformation to force ratio and the elastic force limit. Results indicated wire configuration design to have the greatest influence on the significant working characteristics of the wire-loop combinations.

Chaconas et al. (1974) used a simulated two-dimensional mouth model to study four different designs of sectional retraction springs. Force and activation measurements were obtained with a Statham Universal load cell and were recorded with a Hewlett-Packard x-y recorder. Results demonstrated increased activation forces with increased wire size, and variation in activation forces per unit of deflection depending upon the loop configuration.

Burstone and Koenig (1976), in an article dealing with spring design as it influences moment to force ratios, used a combination of experimental and mathematical modeling techniques to obtain their data. Experimental measurements involved the use of a system for measuring uniplanar forces and moments as described by Solonche et al. (1977). The appliances to be tested were mounted in two chucks, each chuck being attached to an angular displacement transducer, the angular displacement sensed by the transducer being proportional to the

torque applied by the appliance. Force and moments obtained were then converted to linear and angular displacements and transduced to electrical signals, which were displayed on an x-y plotter.

The variables of vertical height, horizontal length, and loop diameter, in mesial-distal activation of vertical and T-loops, were analyzed. The results obtained indicated that the moment to force ratio is significantly increased by:

- (1) increased loop height occlusogingivally,
- (2) decreased horizontal length occlusally,
- (3) greater gingival-horizontal length (as in a T-loop).

Helices were also determined as decreasing the load-deflection rate while having little effect on the moment to force ratio.

Brown (1977 a, 1977 b) used a typodont set-up and a Correx measuring gauge to determine the flexibility of the box-loop, cross-loop, and the vertical loop systems in the vertical plane. Load-deflection diagrams were then plotted. The results indicated the box-loop to be more flexible under extrusive rather than intrusive loading, while the vertical loop was found to be extremely inflexible during both intrusive and extrusive deflections.

Vanderby et al. (1977) used angular displacement transducers and a linear variable differential transformer to measure fixed end moments and vertical force, respectively, for vertical activations of three types of loops. Experimental force systems were obtained from T-loops, L-loops and rectangular loops, each loop being centered with its ends rigidly fixed at an interbracket distance of seven mm.

Results obtained demonstrated a significant change in qualitative moment and force relations, due to geometric nonlinearity, and a differing mechanical behaviour of L-loops and rectangular loops when comparing positive and negative vertical activations.

Lack (1980), using a computer assisted transducer measuring system, was able to measure simultaneously the instantaneous three-dimensional forces and moments generated at the centre of resistance of the test tooth resulting from horizontal activations of various cuspid retraction mechanisms. The loops tested included:

- 1) open vertical loop,
- 2) closed vertical loop,
- 3) open vertical loop with a 1 1/2 turn helix,
- 4) closed vertical loop with 1 1/2 turn helix,
- 5) L-loop and
- 6) Burstone loop.

All loops, with the exception of the Burstone loop, were activated 2 mm. horizontally from a centered bracket position, and again from a bracket position 1.5 mm. distal to the measuring tooth. The Burstone loop was activated 5 mm. and placed 2 mm. distal to the measuring tooth. All loops were then tested with a horizontal activation involving a simultaneous vertical misalignment, and with anti-tipping and anti-rotation bends placed in the horizontal arms. The experimental results indicated that none of the loops tested were able to fulfill a requirement of pure translatory force generation to the test tooth, and that all the loops tested produced numerous side effects

during activation. Little mechanical difference was in fact found between the various loops, save for the load-deflection rate generated by the various configurations.

Waters (1981) used a test rig and load-deflection measurements to demonstrate stiffness changes as regards initial alignment of irregular teeth with various loop geometries. He proposed that for radial deflections the vertical limbs and the loop base should be as long as possible. An increase in loop height from 6 to 8 mm. was seen as reducing the span stiffness by about 50%, while an increase in the base from 2 to 3 mm. yields a reduction of 15%. For vertical activations, a reduction in stiffness is generated by fabricating the loop base as wide as possible. Loop height makes only a minor contribution to the activations in this dimension.

Conclusion:

The historical development of orthodontic mechanical systems and philosophies has carried with it a paralleling desire for a definitive understanding of the clinical functioning modality of such appliances. Many appliance systems and geometries for the attainment of "ideal" functional results have been proposed, most of which have not been based on sound mechanical principles nor have they been thoroughly tested clinically or in the laboratory. Clinical observation by itself has in fact fostered many inaccurate conclusions, due principally to the lack of conformity from one clinical situation to the next. As such a loop design which was found to generate desired

results in one situation of tooth malalignment, was found to create many spurious effects in what clinically would be deemed the same circumstances.

Analytical methodologies and consequent proposals have been plagued by the magnitude of computation required, especially in three-dimensional analysis, and the difficulty of applying such analysis to any system with a complex geometry.

The advent of a means for measuring simultaneous three-dimensional force and moment generation upon activation of chosen appliance systems makes experimental measurement the most accurate means of analysis of the various mechanical systems. Appliance systems may now be tested through a whole range of activations in any plane, and data generated which will not only portray the primary forces and moments generated, but also any spurious side effects, which may in fact be clinically significant. Hence, both a qualitative and a quantitative understanding may be advanced so that the clinical design and manipulation of orthodontic appliances may be based on more scientific mechanical principles.

Statement of the Problem

Multibanded orthodontics involves utilization of very small interbracket spaces for the placement of appliances used to produce an appropriate force system. These small interbracket spaces limit the degree of control that one has over the magnitude of force generated by the elastic member of the appliance. Much of the previous literature has approached interbracket loops as a methodology for decreasing the magnitude of this force, and it is on this basis that many researchers have discussed the value of incorporating more wire into an interbracket space.

Tooth movement involves much more than just the application of light forces. As such, an ideal appliance should have not only a low load-deflection rate, but also should move the tooth only in the desired direction. Thus it should not generate any spurious forces or moments as it deactivates.

Recent research has focused upon the importance of loop design in generating desired force systems. However, three-dimensional qualitative and quantitative design parameters for alignment loops have not been experimentally defined. It is in this context that this study will seek to elucidate the three-dimensional configurational parameters by which alignment loops may be judged, and empirically define any relationships between design and force production that may exist. The basis of this judgement will be that of their ability to deliver an ideal force system for given clinical requirements of tooth movement.

Materials and Method

Introduction:

Experimental data generated in this investigation was obtained through the use of instrumentation originally developed by Paquien (1978), and later modified by McLachlan (1979). It is similar to that used by Lack (1980), the components of which consist of a data acquisition system and a minicomputer, both in turn interfaced with a measuring system (Figure 1). The data acquisition system records the outputs of the measuring system transducers, and relays this information to the computer for calculation of the forces and moments generated. The minicomputer is a Hewlett-Packard 9830A complete with x-y plotter and printer auxiliaries. It was used in the collection, calculation, storage, and visual representation of the data.

Measuring System:

The original measuring system was developed as a methodology for the direct measurement of the three-dimensional force and moment system delivered by orthodontic appliances. The device itself consists of six electrical force transducers placed in an appropriate geometrical configuration. This configuration allows the computation of the six components (three forces, three moments) from the six force measurements. The combination of these transducers and the digital computer provided an automatic means of data collection and computation.

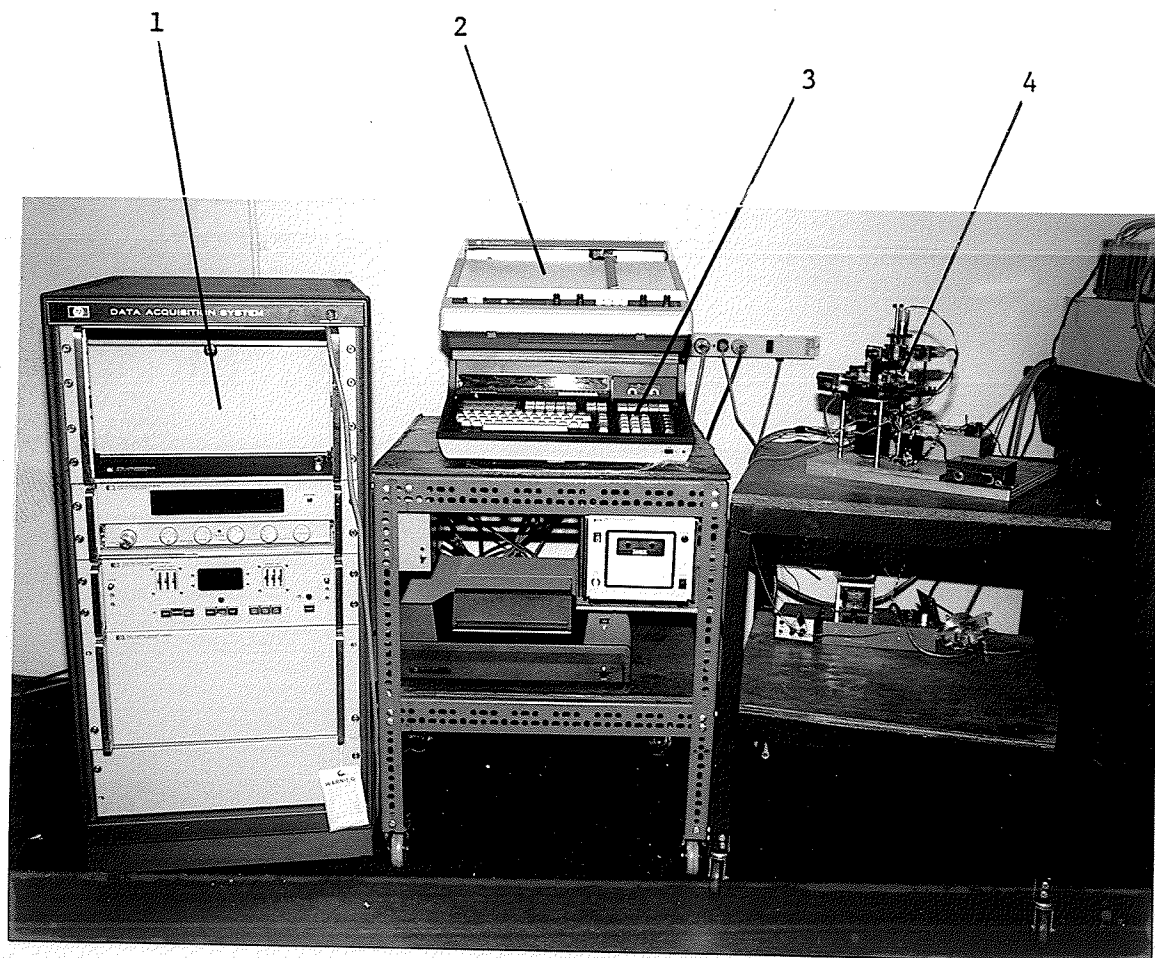

1. Data aquisition system
2. Plotter
3. Minicomputer -
4. Measuring system

FIGURE 1: General view of instrumentation

Lack (1980) has demonstrated the accuracy of the measuring instrumentation in generating three-dimensional force and moment data to a maximum force level of 130 gm. and moment magnitudes of 2300 gm.mm. Calibration, and consequent confirmation of the accuracy of the measuring system to plus or minus 3% of full scale, was performed by McLachlan (1979) and Lack (1980).

Modification of the original design by McLachlan (1981) resulted in the addition of an activation parameter in the buccal or lingual direction (z - axis). Hence the measuring system now has the capability of measuring three-dimensional force and moments generated through primary activation directions in all three planes of space.

Programs:

The programs used in this investigation were written in the BASIC computer language. The data acquisition program (Figure 2) provided a means by which the operator had to follow all steps necessary for the correct sequencing of the data collection. Operator control of such quantities as the direction, magnitude, and number of steps of activation of the appliance is provided at the keyboard. A plot of one facet of the data generated (eg, total force) is displayed upon the x-y plotter such that visual observation of the validity of the results is possible. The program also allows for storage of the data on magnetic tape at the end of each experimental run, and for the returning to the zero activation point such that each activation series will start from the same origin.

FIGURE 2:
Flow diagram
of data
aquisition
program

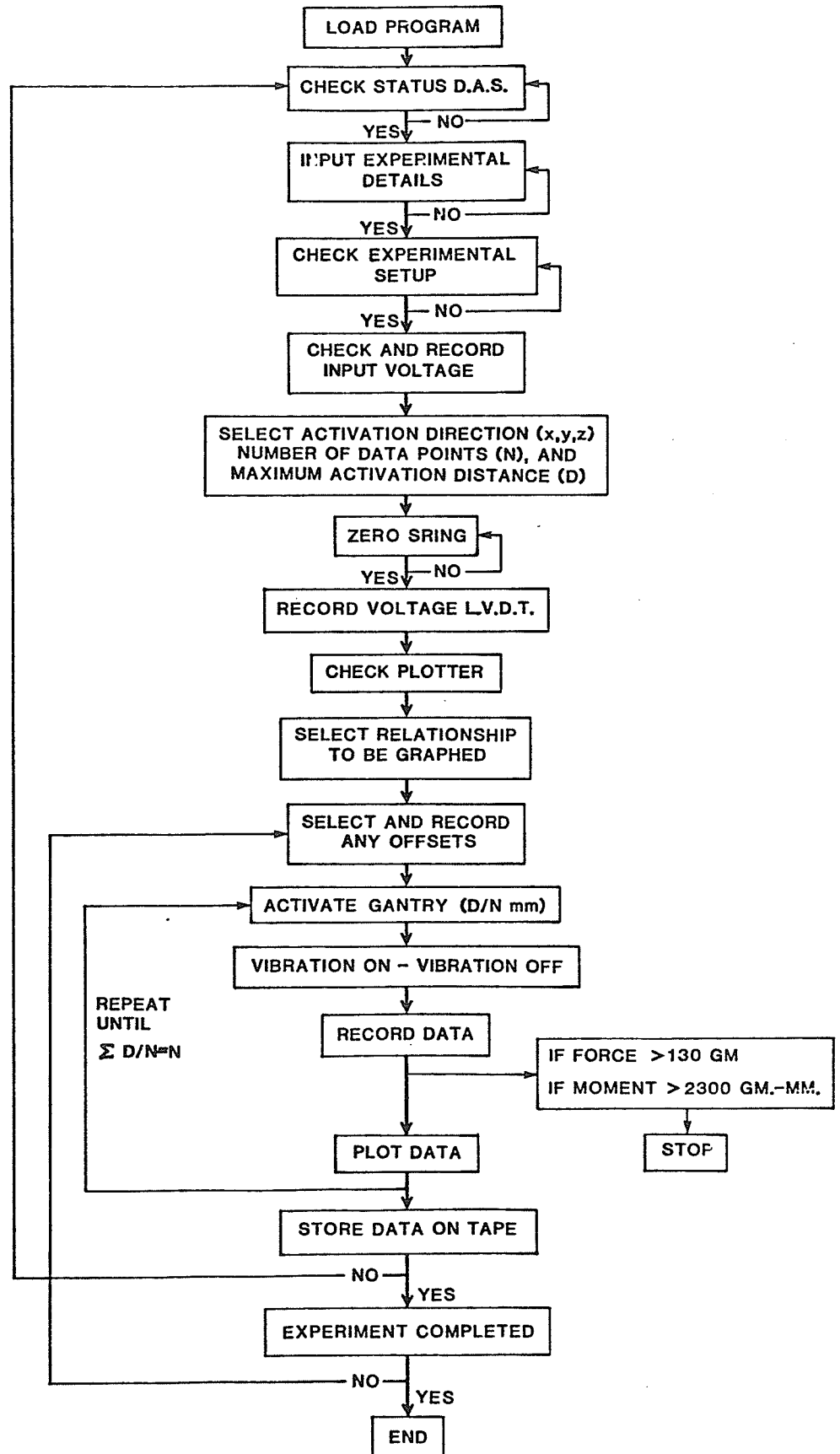

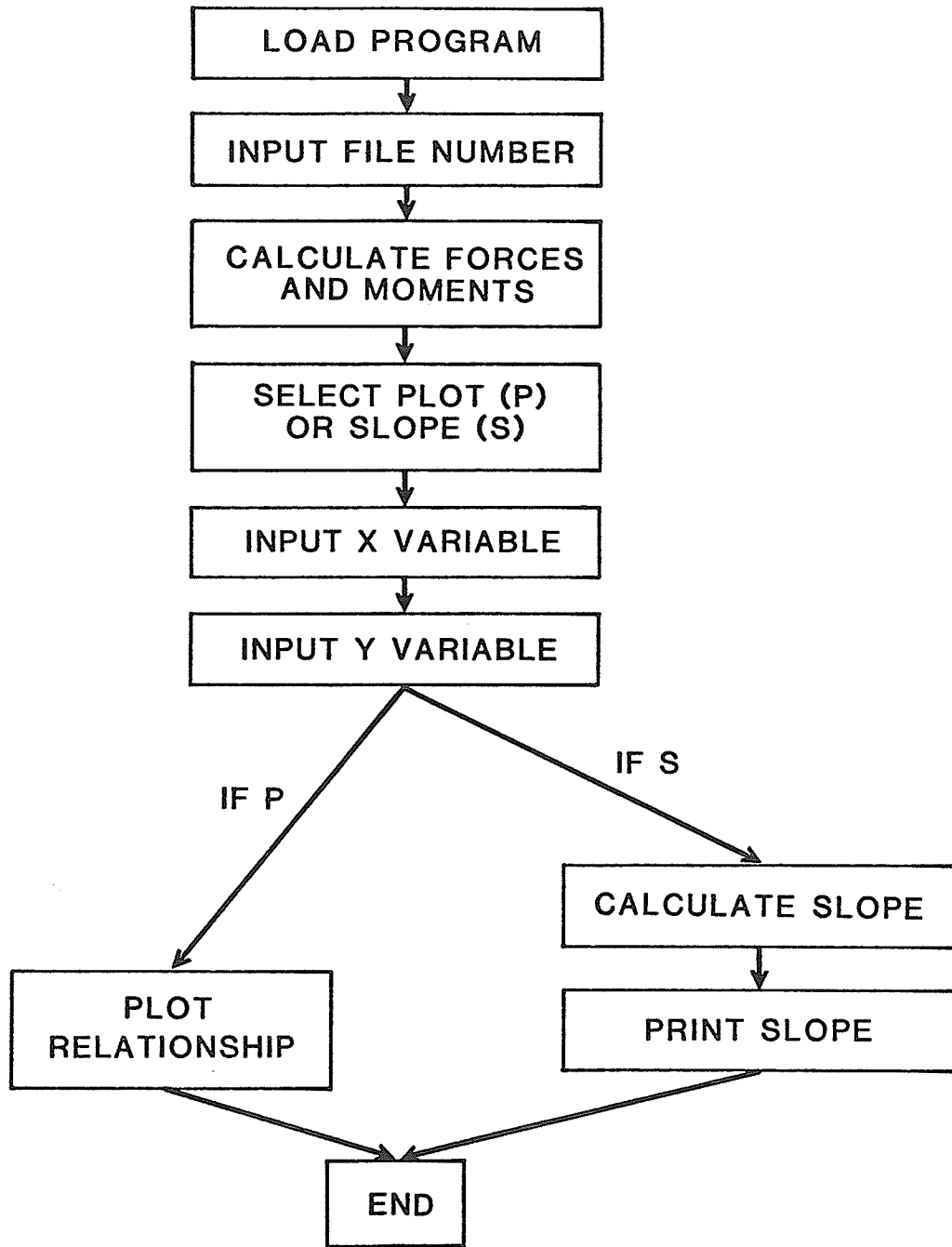

FIGURE 3: Flow diagram of data analysis program

The data analysis program (Figure 3) was used to calculate and visually represent desired relationships obtained from the raw data stored on the magnetic tapes. The program allows for either a plot or a calculated slope reading to be generated. The horizontal axis in this program can be made to be proportional to either activation distance or force magnitude, while the vertical axis may be designated as either a force or a moment magnitude.

Activation System:

The measuring system has the capability of both positive and/or negative activation of the tested appliance in all three planes of space. Activation directions and distances are controlled through the data acquisition program, and are monitored by the appropriate linear voltage displacement transducer. Manual adjustment of the transducers, to the appropriate distance parameter, is accomplished through a screw mechanism (Figure 4).

The three-dimensional activation system allows an activation range of:

- 1) plus or minus 26 mm. in the x-dimension,
- 2) plus or minus 16 mm. in the y-dimension,
- 3) plus or minus 16 mm. in the z-dimension.

Within these ranges any maximum activation can be combined with any number of activation points.

In the present investigation, because of the small interbracket distance and consequent stiffness of the appliances tested, an activa-

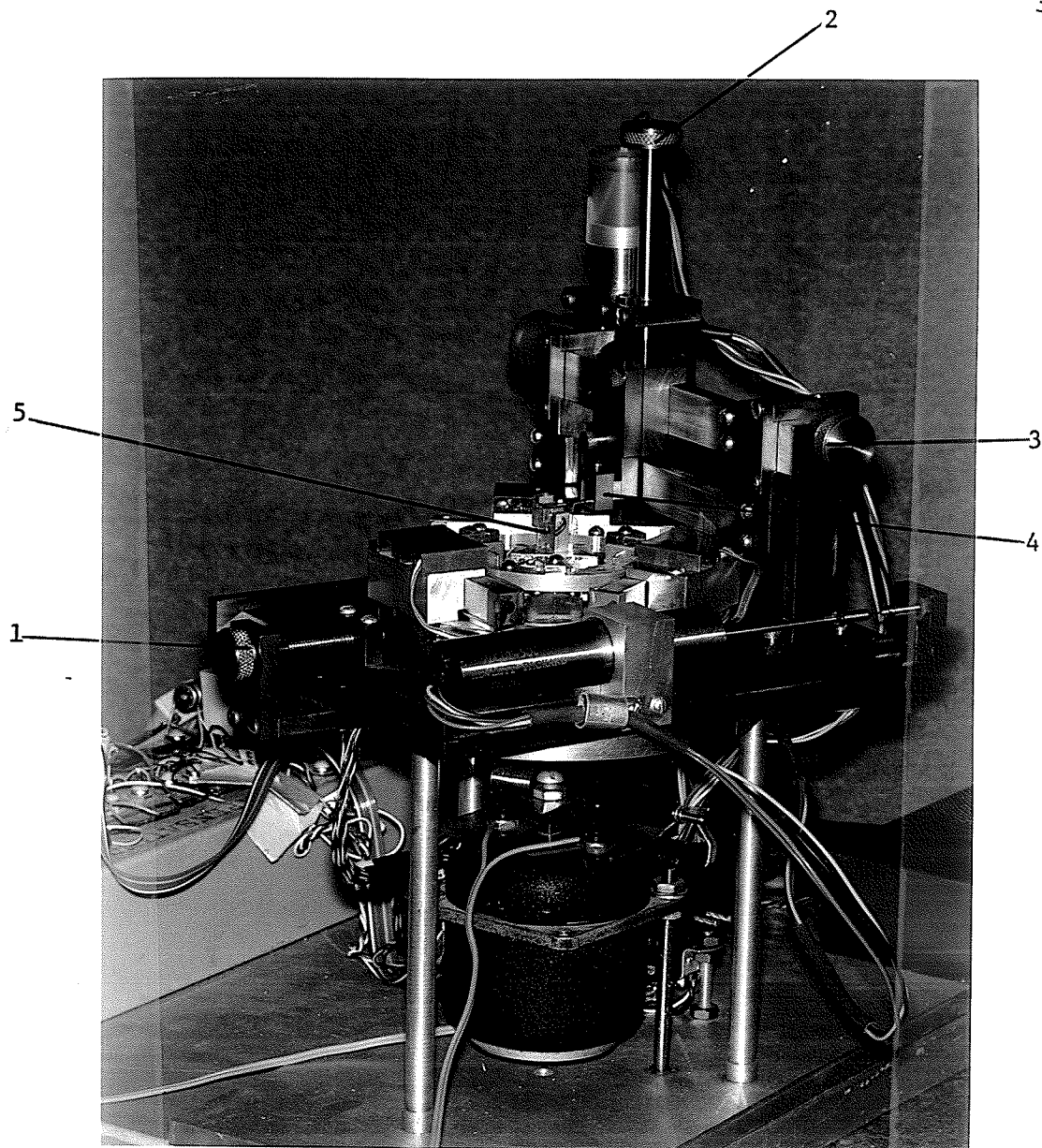

1. x-axis activation screw
2. y-axis activation screw
3. z-axis activation screw
4. Clamping mechanism
5. Simulated tooth

FIGURE 4: General view of measuring instrument

tion distance of one millimeter over ten activation points was chosen. Activation directions were both positive and negative and used either the y-axis or the z-axis as primary axes.

Loops Tested:

The loops selected for this investigation were considered most representative of alignment loops in general. Primary data was generated from symmetrical appliance systems in which a pure vertical or horizontal component could be varied. The investigation was then expanded to detail the effect of configurational changes and inter-bracket positioning on force and moment production by the appliance. Both symmetrical and asymmetrical loops were tested.

The loops tested were:

- 1) vertical loop with variation of parameter "H" as 6 mm., 8 mm., 10 mm., and 12 mm. (Figure 5).
- 2) vertical loop with variation of parameter "D" as 2 mm., 3 mm., 4 mm., and 5 mm. (Figure 6).
- 3) vertical loop "H" = 8 mm., "D" = 2 mm., with a 1 1/2 turn helix at the apex of the loop (Figure 7).
- 4) vertical loop "H" = 8 mm., "D" = 2 mm. with 1 1/2 turn helices at the points where the horizontal arms join the vertical arms (Figure 8).
- 5) T-loop "H" = 8 mm., "D" = 2 mm. with variation of parameter "L" as 6 mm., 8 mm., 10 mm., and 12 mm. (Figure 9).
- 6) T-loop "D" = 2 mm. with variation of parameter "d" as 2 mm.,

3 mm., and 4 mm. (Figure 10).

- 7) L-loop "H" = 8 mm., "D" = 2 mm., "L" = 6 mm. and "d" = 2 mm. (Figure 11).

Each loop was fabricated by the author using a 139 bird-beak plier and a Tweed loop-forming plier. Yellow Elgiloy of 0.016 diameter was the material used in all cases. Construction was standardized through the use of a template drawn on millimeter graph paper, and each loop was made to lie flat on the template. Care was taken not to over bend any loop during fabrication: any such error in fabrication resulted in the loop being discarded.

Only one loop of each representative length parameter was fabricated and used throughout the experiment. Previous research by Vanderby et al. (1977) has demonstrated variability in force and moment production due to errors in fabrication and placement of appliances of the same design. However, the statistical results in this investigation were derived from only four samples of each loop tested. In addition, no explanation is given of the physical parameters of the loops which might explain the reported variability in force and moment generation.

Our preliminary experience in fabricating and testing loops suggested, that with carefully controlled geometry, variation of force and moment generation was not greater than that to be expected from the measuring process. Furthermore, the experiments that form the basis of the present study were aimed at elucidation of the behaviour of physical elements, for which there exists a set of underlying phys-

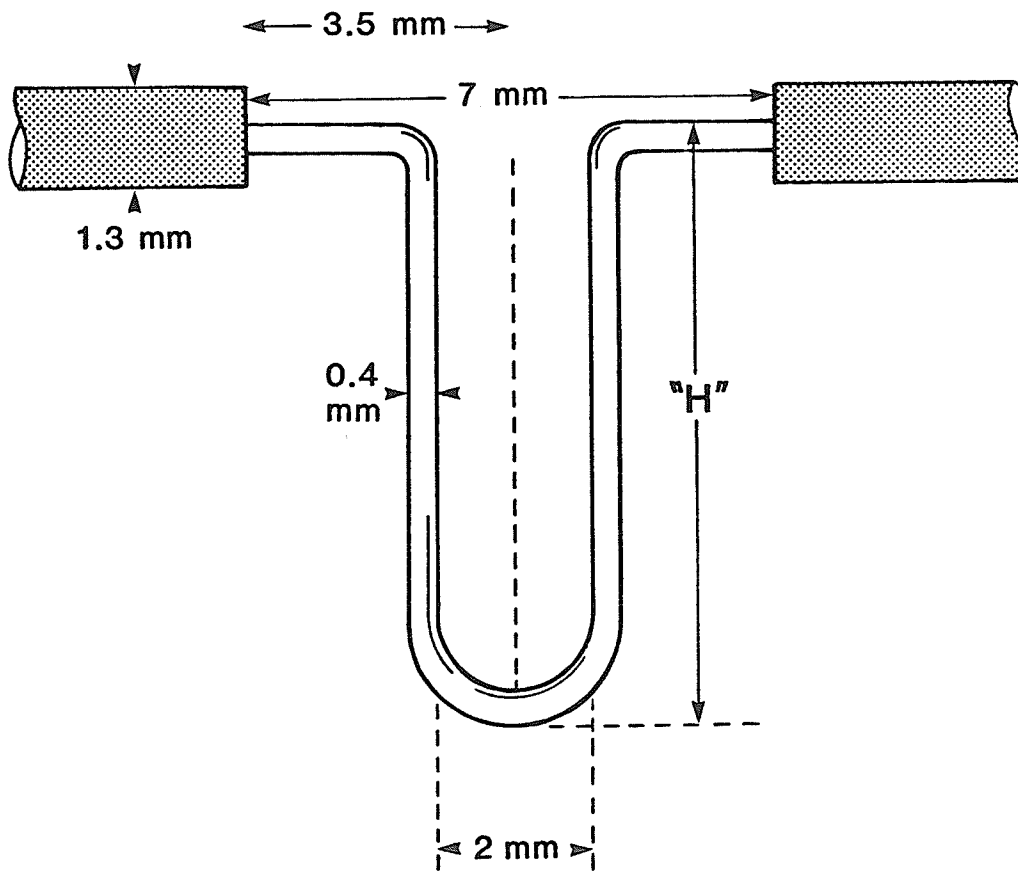

$$"H" = (6, 8, 10, 12) \text{ mm}$$

FIGURE 5: Vertical loop with variation of parameter "H"

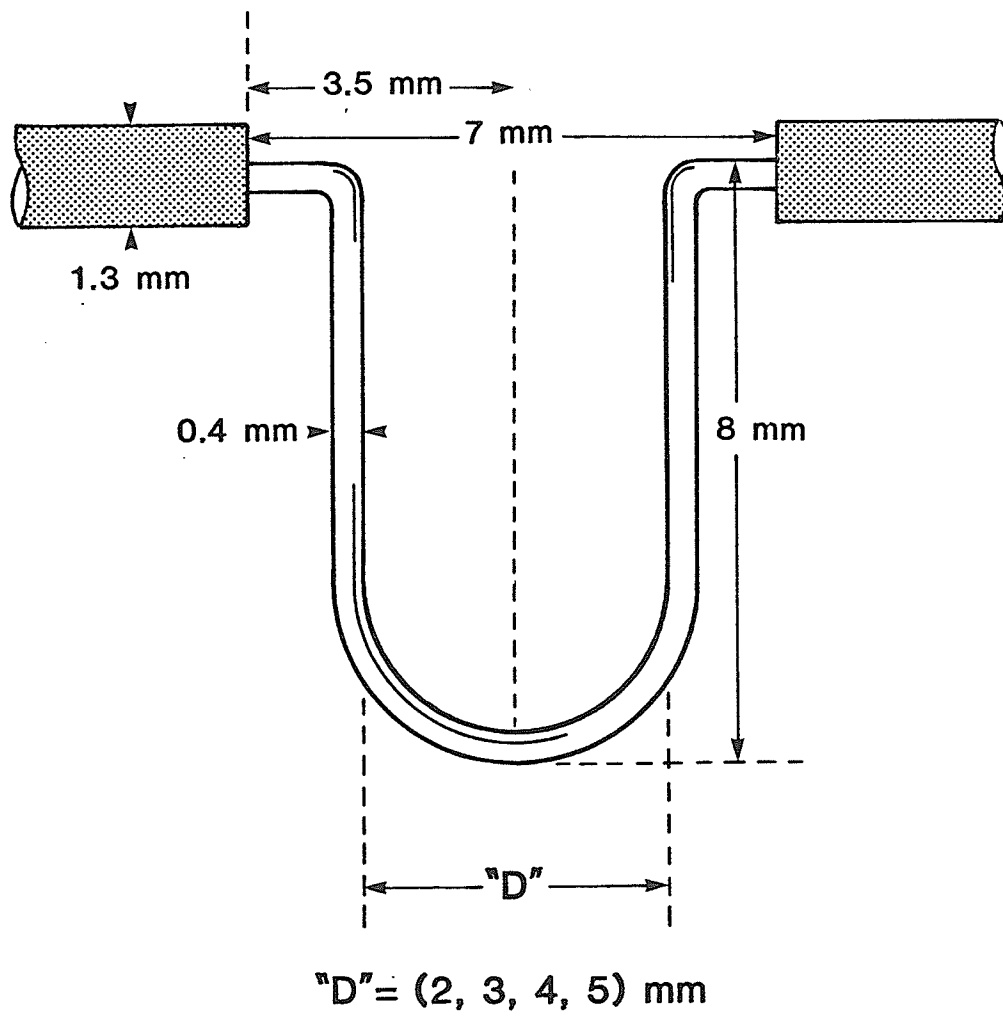

FIGURE 6: Vertical loop with variation of parameter "D"

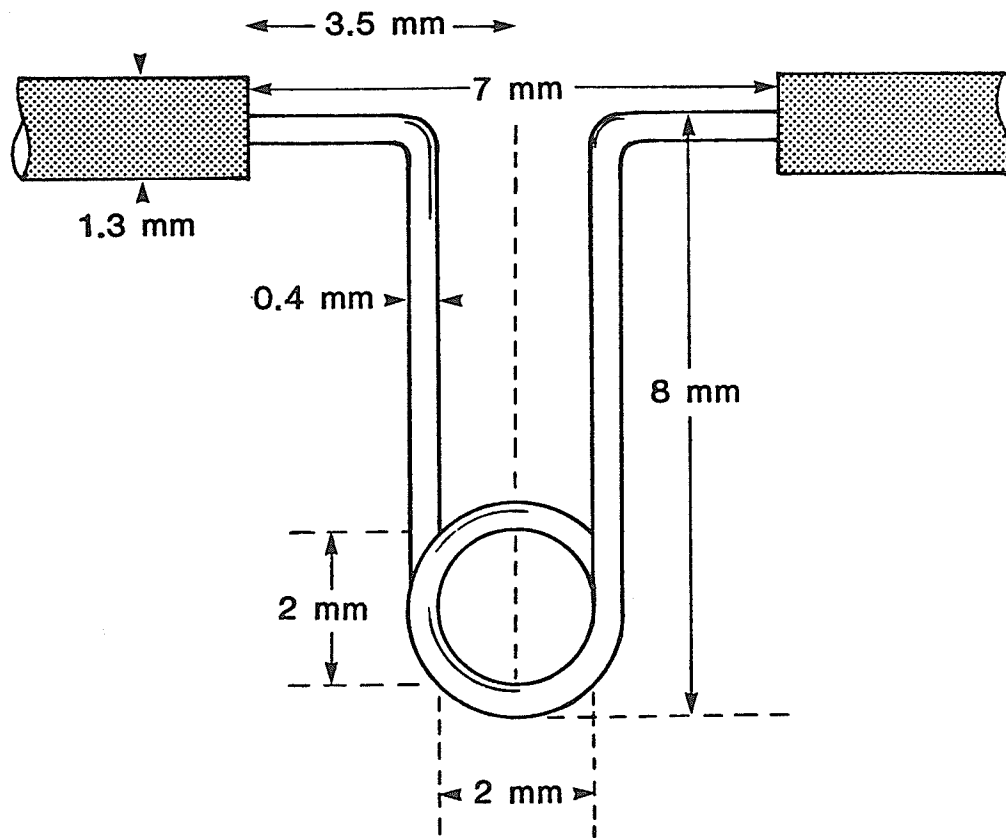

FIGURE 7: Vertical loop with $1\frac{1}{2}$ turn helix at the apex.

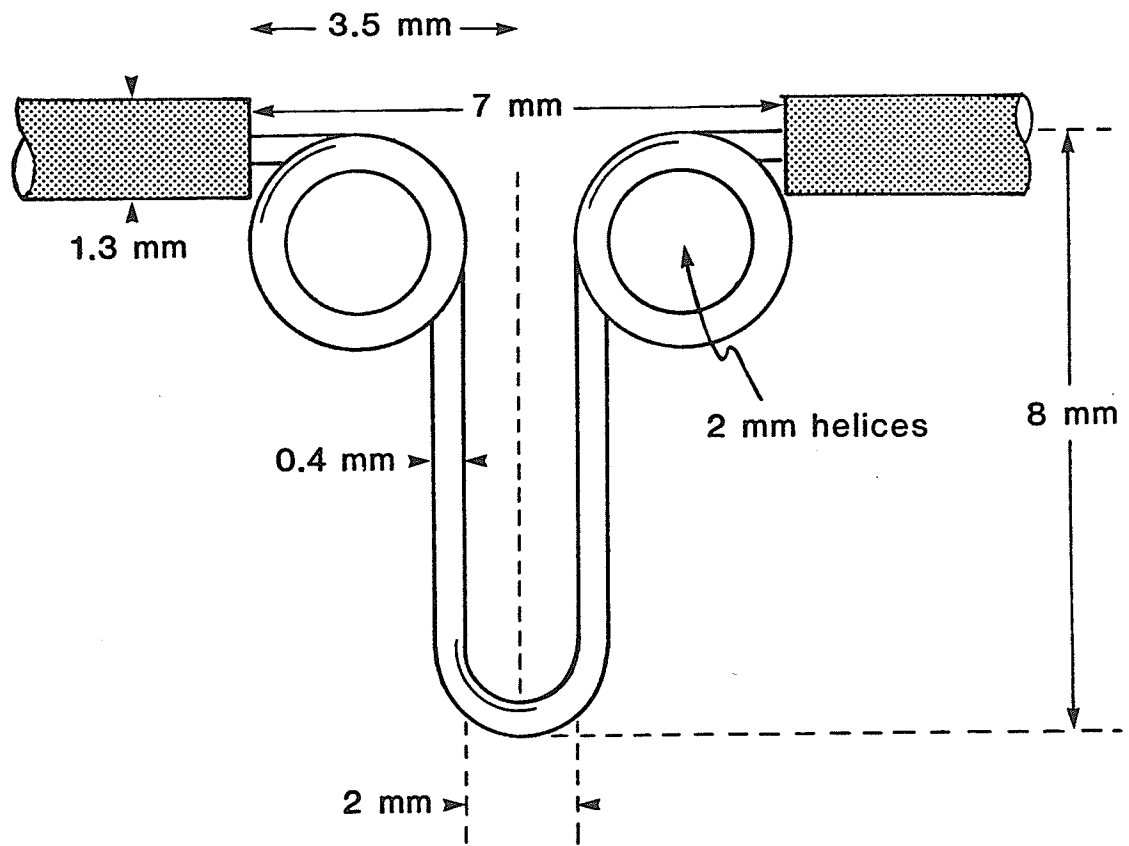

FIGURE 8: Vertical loop with $1\frac{1}{2}$ turn helices.

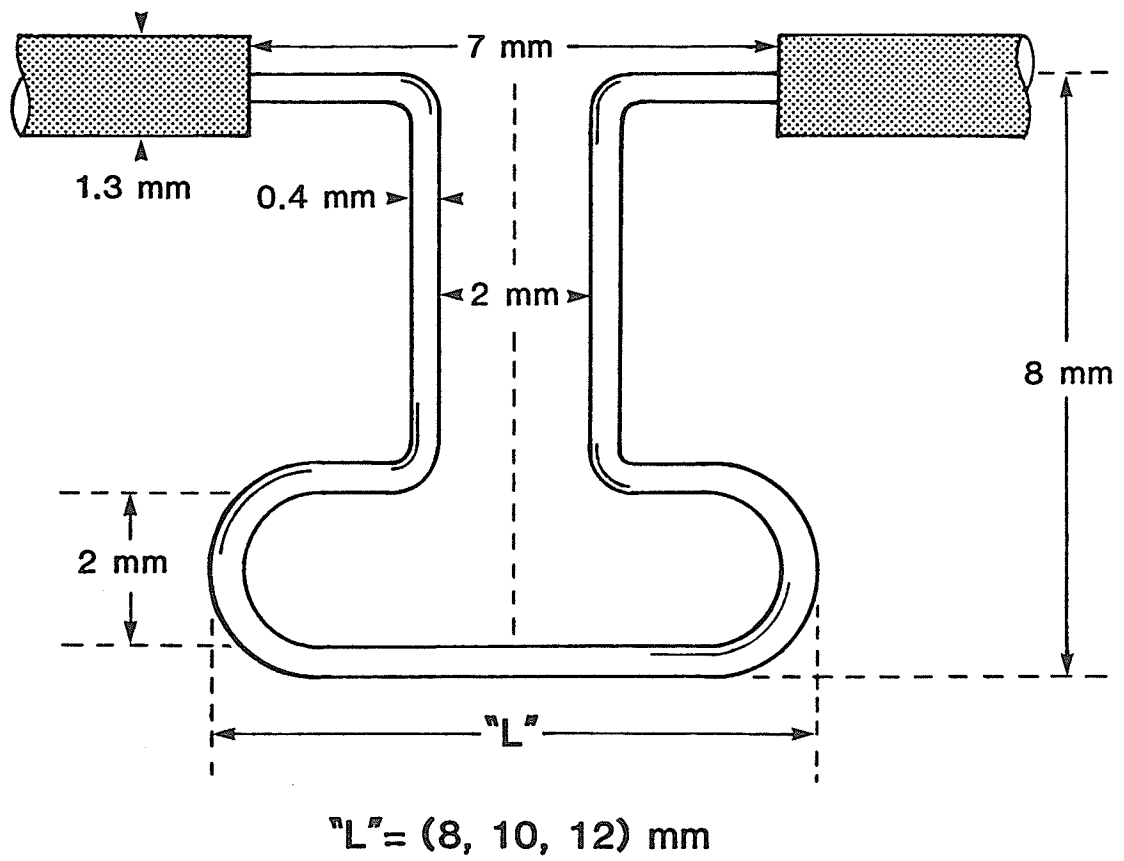
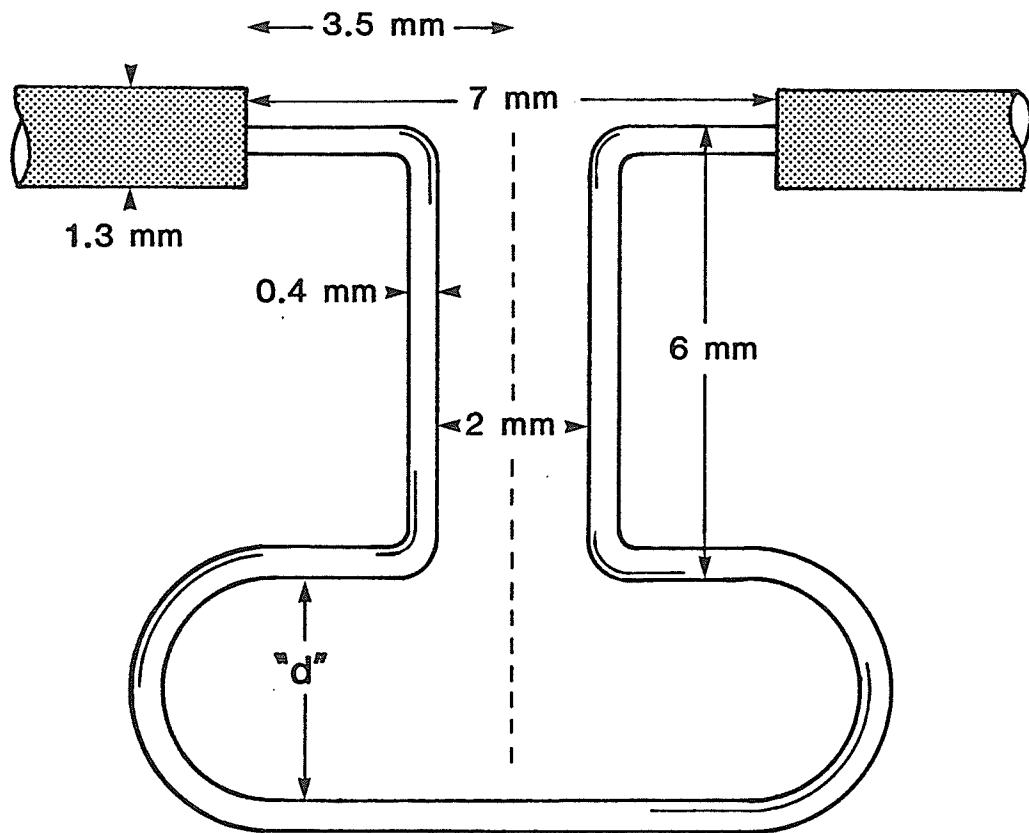

FIGURE 9: T-Loop with variation of parameter "L"



$$d = (2, 3, 4) \text{ mm}$$

FIGURE 10: T-Loop with variation of parameter "d"

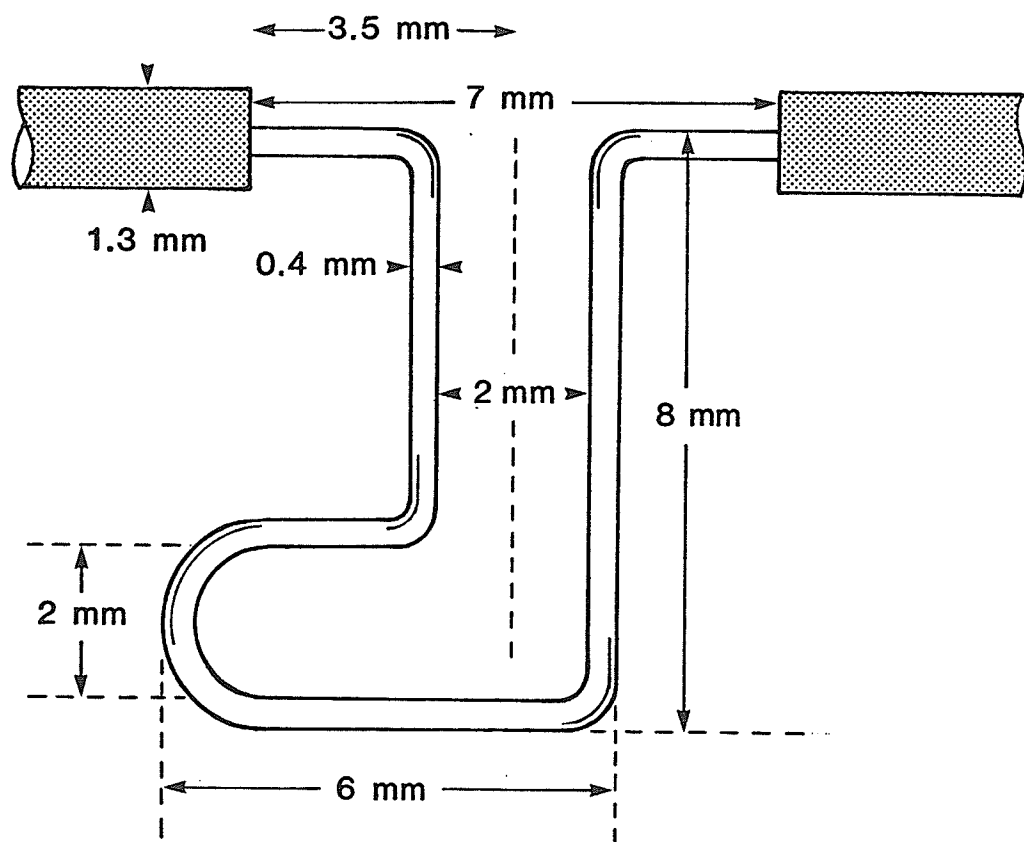

FIGURE 11: L-Loop

ical principles. Thus, deviations owing to inaccurate construction will be seen in variability in the relationship between the various loop behaviours and their expected behaviours.

Mounting:

Interbracket distance of the measuring system was controlled by the placement location of the stainless steel tubing on the horizontal occlusal legs of the appliances. This distance for all appliances tested was standardized at 7 mm. The tubing had an outside diameter of 0.7 mm., and was rigidly attached to the loop appliance through the use of red compound. This methodology was developed by Lack (1980) and involves injection of the compound (temperature approximately 50-60 degrees Celcius) into the tubing, once the appliance arm has been appropriately positioned. Tubing was attached in this manner at both ends of the appliance. Interbracket distances or placement dimensions could then be very easily adjusted by gently heating and moving the tubing to the appropriate position. Care was taken to ensure that the compound was flush with the ends of the tubing which faced the appliance, such that interbracket distance could be accurately determined as the measurement between the mounting tubes. This methodology of mounting ensured the rigidity of the appliance at its most lateral extensions.

After placement of the mounting tubing the appliances were returned to the original template and checked for any distortion that may have occurred in any of the three planes of space.

The distal end of the appliance system was then placed in the clamping mechanism located on the vertical activation post. The clamping mechanism was tightened down such that the appliance was made to lie parallel to the x-y axis system of the measuring instrument (Figure 4). The three activation screws were then adjusted until the mesial tubing was passively positioned in the slot of the model tooth. The clamping mechanism for attachment of the appliance to the model tooth involved the use of a flexible piece of brass, and ensured that no undue forces were applied to the force measuring transducers during this procedure. Once mounting was completed the appliance was visually checked to ensure that it still retained its parallel relationship to the axis system.

The simulated tooth attached to the measuring system was designed with the appliance attachment 12 mm. vertically and 4.2 mm. buccal from the designated centre of resistance. All recorded force and moment readings were then taken by the measuring system from this centre of resistance point.

The axis system used in the measuring system was designated such that:

- 1) the x-axis runs mesio-distal to the model tooth with distal displacements given a positive value,
- 2) the y-axis runs occluso-gingival to the model tooth with occlusal displacement given a positive value,
- 3) the z-axis runs bucco-lingual to the model tooth with lingual displacement given a positive value (Figure 12).

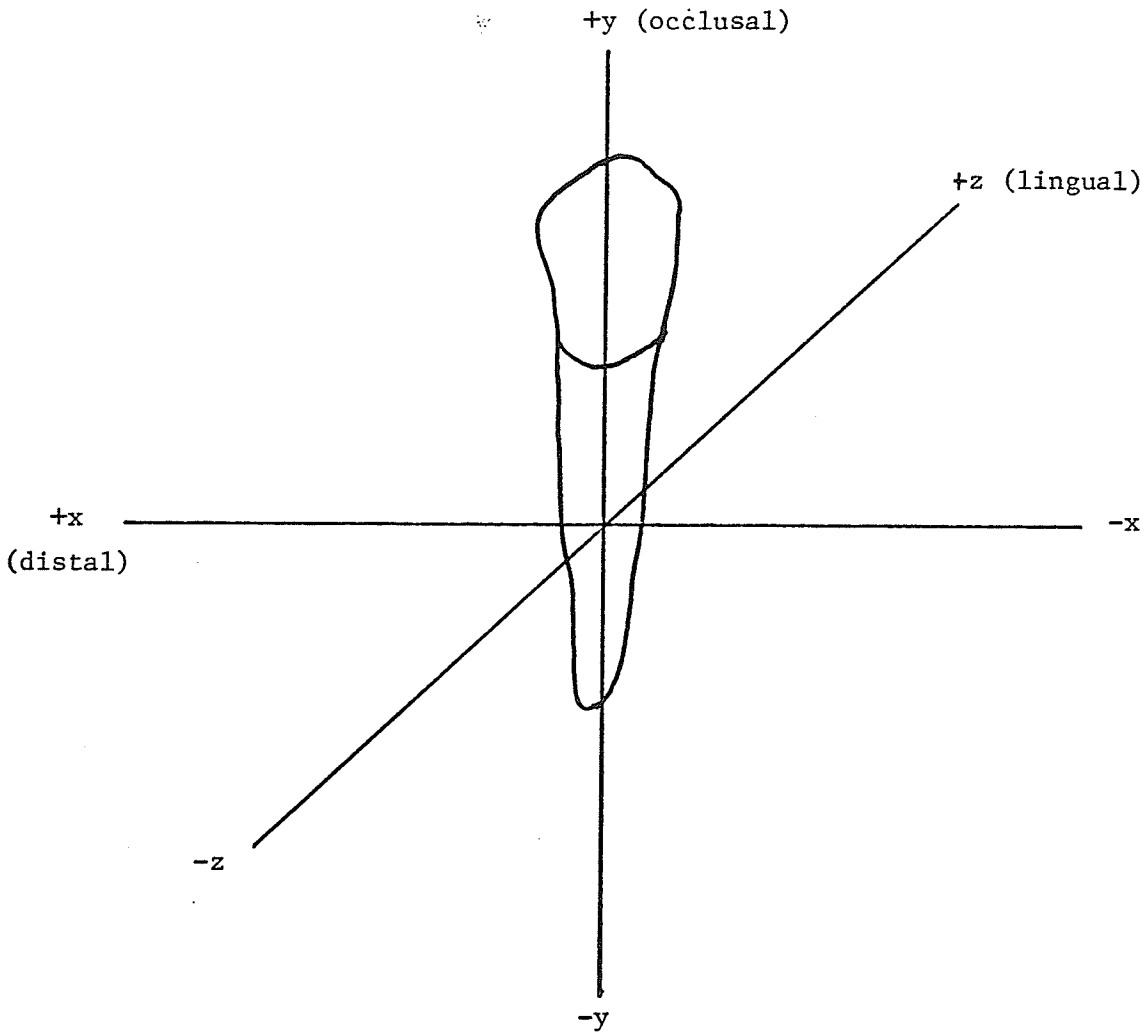

FIGURE 12: Axis system used in the measuring instrument.

Using these coordinates a force tending to move the model tooth lingually along the z-axis would have a positive value.

Experimental Procedures:

Data collection involved the division of the experimental procedure into six experimental blocks (Table I). Each experimental block was distinct in that it involved either a pure translatory activation in the occluso-gingival (y) or bucco-lingual (z) direction, or centered and non-centered interbracket placement of the selected loop. All loop activations were translatory, in which one arm of the loop was displaced up to one millimeter in the appropriate direction, with ten activation points being recorded over this range. Both positive and negative displacement directions on the axis system were recorded to allow for delineation of forces and moments developed at both the brackets being engaged by the appliance.

The first experimental block involved the testing of selected symmetrical loop configurations. All loops in this block were centered in the 7 mm. interbracket space, and activated in both a positive and negative direction along the defined occluso-gingival (y) axis.

Each loop was loaded into the measuring device as previously described. The data acquisition program was then run, with offsets along the x-axis and z-axis being set to zero. Activations along the positive y-axis were recorded first, and involved ten readings over a one millimeter displacement parameter. A plot of the total force pro-

duced versus activation was simultaneously recorded to ensure the validity of the results and prevent any force overload of the measuring system. The recorded data was then stored on magnetic tape, once the activation run was complete.

The tested appliance was then returned to its initial passive state, through the use of the L.V.D.T. readouts, and this point was plotted and compared to the initial unactivated point to determine if any distortion of the appliance had in fact occurred. The appliance was then disconnected from the measuring tooth and slowly raised vertically through movement of the vertical activation post. If no spurious movement of the appliance was observed during this procedure, the appliance was lowered into the slot on the model tooth until it lay passively. It was then firmly clamped in this position and the experiment rerun in exactly the same manner, except for the fact that activation was now carried out along the defined negative y-axis.

Experimental block number two involved the testing of the same loop configurations as used in block number one. All loops were centered in the 7 mm. interbracket space, and were activated in both a buccal (-z) and lingual (+z) direction. All experimental procedures were the same as those described for block number one.

The third experimental block involved the testing of an asymmetrical loop, i.e. a L-loop. The loop was again centered, as in the two previous blocks, and one millimeter activations along the positive and negative y-axis were recorded. The loop was then removed from the measuring system, rotated 180 degrees on the x-z plane, and remounted.

Activation data along the positive and negative y-axis was again recorded, and in combination with the previous data obtained in this block, allowed for the delineation of forces and moments generated at both bracket attachments.

Block number four involved the same experimental procedures as block three except for the change in the activation axis from occluso-gingival (+y) to bucco-lingual (+z). The tested appliance was again a centered L-loop.

In block number five the asymmetrical L-loop was not centered in the interbracket space but was moved to a position 1.0 mm. from the measuring tooth. The interbracket space was maintained at 7 mm. Activation occurred along the occluso-gingival (+y) axis, the maximum activation again being one millimeter. Two configurational placements of the L-loop were tested, the first involving the "toe" of the loop being directed towards the measuring tooth, while in the second configuration the "toe" was directed away from the measuring tooth. Both configurations were again tested after a 180 degree manipulation, as has been previously described.

The sixth block involved data generation from an L-loop asymmetrically placed in the interbracket space as described in the previous block. Activation was along the bucco-lingual (+z) axis. Testing involved configurations and manipulations as described for block number five.

Data Analysis:

Initial analysis of the data, stored on the magnetic tape from the various experimental blocks, occurred in the computer programs. Here the electrical outputs of the various transducers were changed to forces and moments acting at the center of resistance of the simulated tooth.

The data analysis program then allowed for the plotting of the data, or the determination of the slope of the linear relationships. Numerical values of force magnitudes were then derived through extrapolation of the slope values to a one millimeter activation distance.

Six relationships were chosen as being representative of the mode of action of the various loop configurations. These relationships described the stiffness of the appliance in the primary activation direction (F_1/A), the magnitude of any spurious forces as a ratio of the primary force (F_2/F_1), and the moment to force ratios in all three planes of space as related to the primary force direction (M/F_1). It was felt that these ratios adequately described the appliance in all three planes of space.

TABLE I
EXPERIMENTAL BLOCKS

BLOCK	TYPE OF LOOP	PARAMETER VARIED	LOOP PLACEMENT	ACTIVATION DIRECTION
1	a) Vertical	H	Centered	$\pm y$
		D	Centered	$\pm y$
		Helices	Centered	$\pm y$
	b) T-Loop	L	Centered	$\pm y$
		d	Centered	$\pm y$
2	a) Vertical	H	Centered	$\pm z$
		D	Centered	$\pm z$
		Helices	Centered	$\pm z$
	b) T-Loop	L	Centered	$\pm z$
		d	Centered	$\pm z$
3	L-Loop	"toe" directed mesially	Centered	$\pm y$
4	L-Loop	"toe" directed mesially	Centered	$\pm z$
5	L-Loop	a) "toe" directed mesially	1.0 mm distal to model tooth	$\pm y$
		b) "toe" directed distally		
6	L-Loop	a) "toe" directed mesially	1.0 mm distal to model tooth	$\pm z$
		b) "toe" directed distally		

Results

Introduction:

Data generated in this experiment will be tabulated as a slope value obtained from the linear relationships plotted. Since all the appliances tested were initially passively positioned in the measuring device, with no offsets or compensating bends, the initial point on all plots is at the intersection of the two axes. Thus only pure slope values will be presented.

All appliances were activated through a one millimeter primary activation range in both the occluso-gingival ($\pm y$), and bucco-lingual ($\pm z$) plane. Both positive and negative activations were recorded in order to demonstrate any changes that might occur in force and moment magnitudes or directions, associated with an activation that either closed or opened the vertical arms of the loops. The appliance ends were designated as either active (A) or reactive (R), the former being that which was attached to the model tooth. In order to better visually simulate the clinical situation, activations will be described as occurring at the active end of the loop. In the measuring system data is generated in an opposite manner, i.e. through the activation of the reactive end.

In looking at the results it must be remembered that slope values only are given. Thus positive or negative values of slope will not determine the signs of the absolute values in the quotient. For this determination the sign of one of the absolute values must be known.

To illustrate this point reference may be made to Table XXII. Here, the slopes of M_x/F_y for the active and reactive tooth are of similar magnitude as expected. However, it is expected that M_x be of opposite sign, and that this is so is confirmed by noting that F_y is negative for the active tooth and positive for the reactive tooth.

Comparisons between tested appliance systems are drawn from six tabulated values. The relationship F_y/A_y (F_z/A_z) is the only absolute value, and is a measure of the stiffness of the appliance when activated in the primary activation direction. The other five relationships are related to force generation in the primary direction, and describe the magnitude of force (F) and moment (M) production generated by one gram of primary force. All measurements were obtained in the metric system, with the units of the six relationships being expressed as:

F	gm.
F/activation	gm./mm.
F/F	gm./gm.
M/F	gm.mm./gm.

The sign convention used to describe moment directions is that of a right-handed system.

Symmetrical Loop Configurations:

a) Occluso-gingival Activations.

Loops tested in this block of the experiment were symmetrically

placed in the seven millimeter interbracket space. Data was then generated through activation of the loop over a range of one millimeter in both the occlusal and gingival directions.

i) Variation of the H parameter in a vertical loop.

The results of experiments involving variation of the vertical component (H) of a vertical loop are presented in Table II. All other dimensional components of the loop were maintained unchanged throughout the experiment.

Activation of the designated active (A) end of all the loops in an occlusal direction resulted in the generation of a force, at the center of resistance of the model tooth, in the opposite direction. The loop with the shortest vertical component was found to produce, at full activation, a vertical force of the greatest magnitude (-213.59 gm.). As the vertical component of the loop was increased in length, there was a decrease in magnitude of this force. A loop with a H value of 12 mm., at full activation, yielded a force of -162.63 gm., a decrease of 23.9% from that generated by the 6 mm. vertical loop.

Slope values for force generated in the x direction are all positively directed. At full activation the loop with the smallest H dimension yielded the largest force in the x direction (-23.4 gm.), while the loop with the largest H dimension generated the smallest force (-6.50 gm.).

Slope values for force generated in the z direction are negatively directed and are smaller in magnitude than those for the x

TABLE II

Force and Moment Relationships for Centered Vertical Loop Occlusally Activated,
Variation of Parameter "H".

H	6 mm	8 mm	10 mm	12 mm
F _y /A _y	+213.59	+179.23	+165.41	+162.63
F _x /F _y	+ 0.11	+ 0.12	+ 0.14	+ 0.04
F _z /F _y	- 0.05	- 0.06	- 0.02	- 0.01
M _x /F _y	+ 2.44	+ 2.43	+ 2.35	+ 2.59
M _y /F _y	- 0.14	- 0.09	- 0.13	- 0.17
M _z /F _y	+ 7.29	+ 6.75	+ 6.89	+ 6.95

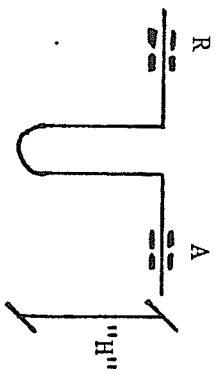

A = Active

R = Reactive

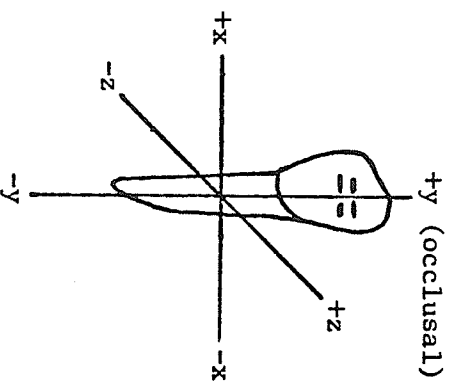
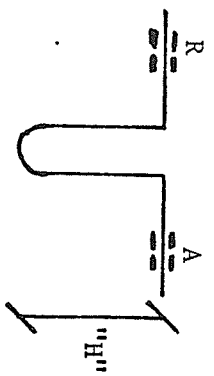

TABLE III

Force and Moment Relationships for Centered Vertical Loop Gingivally Activated, Variation of Parameter "H".

H	6 mm	8 mm	10 mm	12 mm
F _y /A _y	+223.01	+182.11	+167.91	+164.68
F _x /F _y	+ 0.10	+ 0.13	+ 0.02	+ 0.07
F _z /F _y	+ 0.04	+ 0.02	+ 0.03	+ 0.01
M _x /F _y	+ 2.43	+ 2.55	+ 2.79	+ 2.54
M _y /F _y	+ 0.11	+ 0.13	+ 0.15	+ 0.13
M _z /F _y	+ 6.11	+ 6.82	+ 6.93	+ 6.84



A = Active
R = Reactive

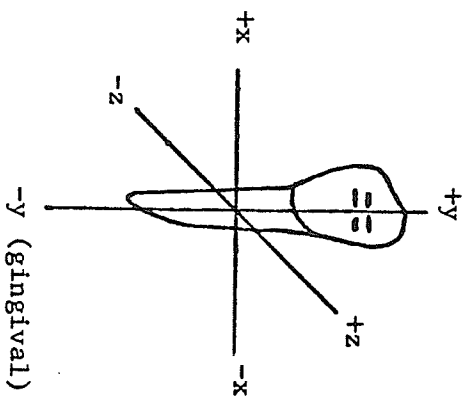

direction. For a one millimeter activation, forces along the z-axis vary in magnitude from 10.7 gm. for a 6 mm. loop to 1.63 gm. for a 12 mm. loop.

Rotational effects, at the center of resistance of the active tooth, are very consistent throughout the variation in height of the vertical loop. The slope value of the rotational effect around the x-axis varied from 2.35 gm. mm./gm. to 2.59 gm.mm./gm., and had a direction that would tip the crown of the tooth buccally.

The slopes of the rotational effects around the y-axis (M_y) are all negatively directed and similar in magnitude.

The slopes of the rotational effects around the z-axis (M_z) are all of similar magnitude and have a direction that would tip the crown of the active tooth distally.

Activation of the active end of those same loop configurations, one millimeter in the gingival direction, generated forces and moments of the same relative magnitudes as for an occlusal activation (Table III). Direction of action was opposite in all cases, except for force generation along the z-axis.

ii) Variation of the D parameter in a vertical loop.

Data generated as a result of variation of the width of the half-helix (D) at the apex of a vertical loop, and a one millimeter occlusal activation, is presented in Table IV.

For all loops tested in this part of the experiment, an occlusal activation of the active arm produced a force in the negative y direc-

tion. The magnitude of this force varied from -179.23 gm., for every millimeter of activation of the loop with $D = 2$ mm., to -114.63 gm. per millimeter of activation of the loop where $D = 5$ mm. The percentage decrease in force production along the y-axis, for an increase in the D dimension from two to five millimeters, was thus 36.1.

Forces developed along the x-axis, during activation of these appliances, are much smaller than the y forces. The magnitude of the slope value is greatest when $D = 2$ (0.12 gm./gm.), and demonstrates a continual decrease as D is increased.

The slope values in the z direction are also very small. The magnitudes of these slopes are inconsistent, but are consistent in direction. Their absolute values are so small that force production may in fact be considered to be zero along this axis.

Rotational effects about the x-axis, for occlusal activation of the loops tested in this section, are all similar in direction and in magnitude. The direction of the moment about this axis (M_x) is such that the crown of the tooth would be tipped buccally.

The magnitudes of the slopes of the rotational effects around the y-axis, for a y activation of the loops, are all very small. At no point in the plots did the absolute value of M_y exceed 19.0 gm.mm. Magnitudes of moments about the y-axis may thus be considered to be very close to zero.

Rotational effects about the z-axis, at the center of resistance of the active tooth, are consistent in their direction throughout the various loop designs. The magnitude of the slopes show a constant

TABLE IV

Force and Moment Relationships for Centered Vertical Loop Occlusally Activated, Variation of Parameter "D".

D	2 mm	3 mm	4 mm	5 mm
F _y /A _y	+179.23	+152.19	+130.50	+114.63
F _x /F _y	+ 0.12	+ 0.07	+ 0.04	+ 0.03
F _z /F _y	- 0.06	- 0.01	0.00	- 0.06
M _x /F _y	+ 2.43	+ 2.48	+ 2.12	+ 2.41
M _y /F _y	- 0.09	- 0.12	- 0.13	- 0.01
M _z /F _y	+ 6.75	+ 6.94	+ 7.90	+ 8.28

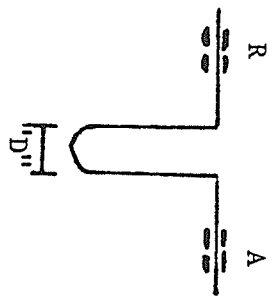

A = Active

R = Reactive

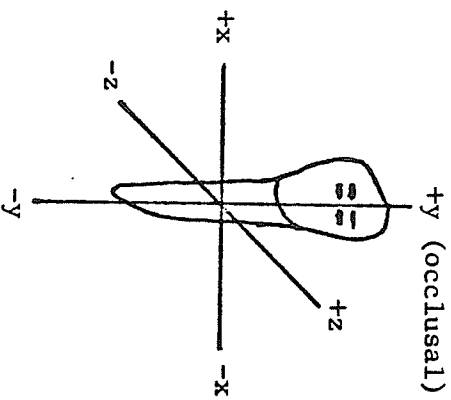
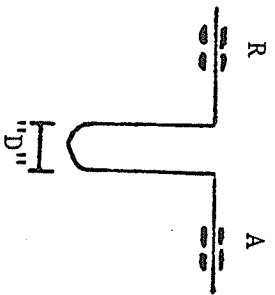

TABLE V

Force and Moment Relationships for Centered Vertical Loop Gingivally Activated, Variation of Parameter "D".

D	2 mm	3 mm	4 mm	5 mm
F _y /A _y	+182.11	+159.18	+128.99	+110.56
F _x /F _y	+ 0.13	- 0.07	- 0.04	- 0.02
F _z /F _y	+ 0.02	+ 0.01	+ 0.01	+ 0.01
M _x /F _y	+ 2.22	+ 2.34	+ 2.65	+ 2.22
M _y /F _y	+ 0.13	- 0.01	+ 0.15	+ 0.16
M _z /F _y	+ 6.82	+ 6.95	+ 7.57	+ 8.03



A = Active
R = Reactive

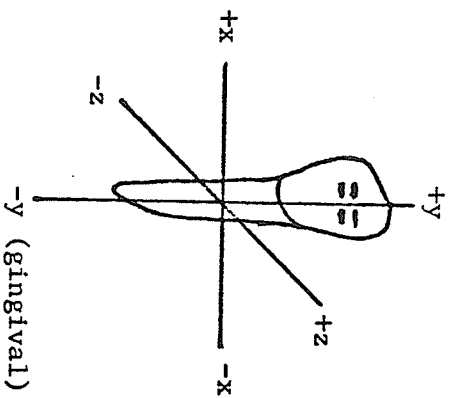

increase as one progresses from the loop with $D = 2$ mm., to the loop where $D = 5$ mm.

Data generated throughout activation of these same loops in the gingival direction (-y), over a one millimeter range, demonstrates the same trends as above (Table V). The stiffness of the loops again decrease as the dimension D is increased, while the moment to force ratios about the z-axis (M_z/F_y) increase.

iii) Helical additions to a vertical loop.

The results of incorporation of a $1\frac{1}{2}$ turn helix, at chosen points in a 8 mm. vertical loop, are presented in Table VI. Two modifications of the standard vertical loop were tested. The first involved placement of a $1\frac{1}{2}$ turn helix at the apex of the loop, while the second involved placement of $1\frac{1}{2}$ turn helices at the reflex points where the vertical arms of the loop join the horizontal arms.

Activation of the loops one millimeter occlusally resulted in the generation of a force in the negative y direction. The absolute magnitude of this force varied with respect to the design of the loop. At maximum activation, force production by the 8 mm. vertical loop was the largest (-179.23 gm.), while the addition of two helices to the loop decreased this value (-131.89 gm.).

The slope values for forces generated in the x direction are all small and positively directed. Absolute magnitudes of forces generated along this axis vary from 21.5 gm. for the 8 mm. vertical loop,

to 11.9 gm. for the 8 mm. vertical loop with two helices. The direction of this force is such that it acts in a mesial direction at the center of resistance of the active tooth.

The slope values for force generated along the z-axis are again small but negatively directed. The forces vary in absolute magnitude from 10.8 gm., for the straight vertical loop, to 4.0 gm. for the loop with two helices.

Rotational effects about the x-axis are consistent in direction but vary as regards the magnitude of the slope. The magnitude of the moment to force ratio (M_x/F_y) is least for the 8 mm. vertical loop, and increases with the progressive increase in the number of helical additions.

Moments about the y-axis, for an occlusal activation of all the loops, are all very small. Coupled with a vertical intercept of zero, they may be considered to be negligible.

The value of the slopes of the moments around the z-axis, for a y directed force, are all positive but vary in magnitude. There is a progression in value from 6.75 gm.mm./gm. for the 8 mm. vertical loop, to 8.66 gm.mm./gm. for the 8 mm. vertical loop with two helices.

Activation of the active end of the same appliances, over a one millimeter dimension in the gingival direction, resulted in the generation of data consistent with that above (Table VII). Relative magnitudes were all similar, while directions of action reversed for the force in the y-direction, the force in the x-direction, the moment about the x-axis, and the moment about the z-axis.

TABLE VI

Force and Moment Relationships for Centered Vertical Loop Occlusally Activated, Helical Additions

	J	H	qp
Fy/Ay	+179.23	+168.40	+131.89
Fx/Fy	+ 0.12	+ 0.11	+ 0.09
Fz/Fy	- 0.06	- 0.05	- 0.03
Mx/Fz	+ 2.43	+ 2.67	+ 3.36
My/Fz	- 0.09	- 0.05	0.00
Mz/Fz	+ 6.75	+ 7.14	+ 8.66

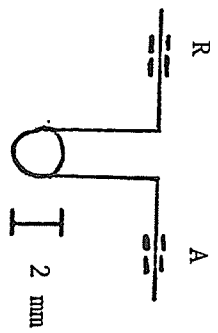

A = Active
R = Reactive

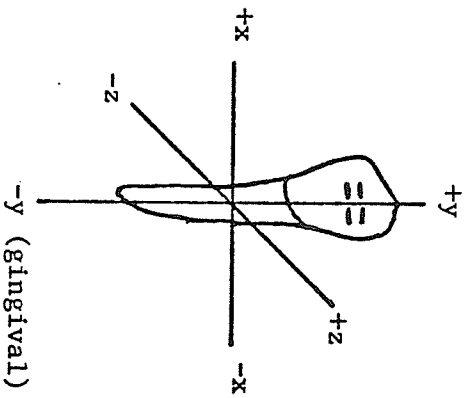
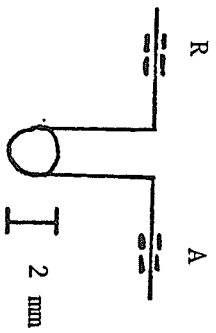

TABLE VII

Force and Moment Relationships for Centered Vertical Loop Gingivally Activated,
Helical Additions

	\overline{U}	\overline{P}	\overline{Q}
F_y/A_y	+182.11	+164.27	+135.64
F_x/F_y	+ 0.13	+ 0.07	- 0.02
F_z/F_y	+ 0.02	+ 0.02	+ 0.02
M_x/F_z	+ 2.55	+ 2.54	+ 3.14
M_y/F_z	+ 0.13	+ 0.12	+ 0.03
M_z/F_z	+ 6.82	+ 7.41	+ 8.70



A = Active

R = Reactive

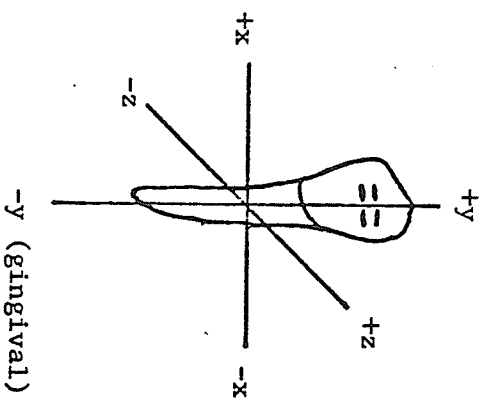

iv) Variation of the L parameter in a T-loop.

Data generated as a result of a one millimeter vertical activation, while varying the gingival-horizontal length of a T-loop (L), is presented in Table VIII. All loops were again symmetrically placed in the 7 mm. interbracket space during testing.

Vertical activation of the active end of the loops resulted in the generation of a force in the opposite (-y) direction. The slope values for the plots of the force generation (F_y), versus activation distance, are all positively directed. However, they vary in magnitude from 110.50 gm./mm. for a T-loop where $L = 8$ mm., to 50.34 gm./mm. for a T-loop with an L-dimension of 12 mm.

Slope values for force generation in the x direction are all small, and have a mesial direction of action along the x-axis.

Slope values for force generation along the z-axis are also very small and may be considered to be zero.

Rotational effects about the x-axis are very consistent, as regards the value of their slope and direction of action.

Slope values for rotational effects about the y-axis are all very small and negatively directed. Since all these plots have zero as their origin, and such a small slope value, rotational effects about this axis may in fact be considered to be zero.

Slope values for rotational effects about the z-axis are consistent in direction, but demonstrate a variation in magnitude. The T-loop with $L = 8$ mm. has the largest value (10.83 gm. mm./gm.), while

TABLE VIII

Force and Moment Relationships for Centered T-Loop Occlusally Activated,
Variation of Parameter "L".

L	8 mm	10 mm	12 mm
F _y /A _y	+110.50	+64.81	+50.34
F _x /F _y	+ 0.06	+ 0.07	+ 0.03
F _z /F _y	- 0.01	- 0.03	0.00
M _x /F _y	+ 2.83	+ 2.54	+ 2.46
M _y /F _y	- 0.07	- 0.01	- 0.01
M _z /F _y	+ 10.83	+ 8.66	+ 7.82

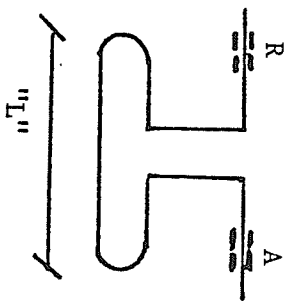

A = Active

R = Reactive

+y (occlusal)

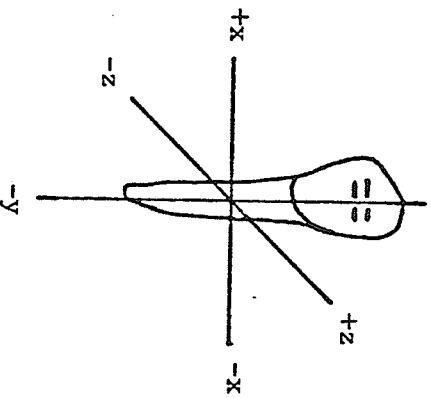
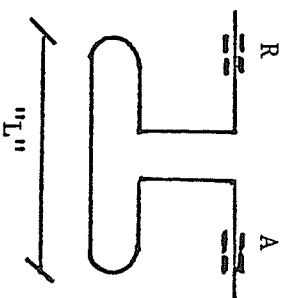

TABLE IX

Force and Moment Relationships for Centered T-Loop Gingivally Activated,
Variation of Parameter "L".

L	8 mm	10 mm	12 mm
F _y /A _y	+112.05	+64.87	+47.41
F _x /F _y	+ 0.01	+ 0.02	+ 0.05
F _z /F _y	0.00	0.00	- 0.02
M _x /F _y	+ 2.68	+ 2.54	+ 2.20
M _y /F _y	+ 0.09	+ 0.05	+ 0.03
M _z /F _y	+ 10.21	+ 8.87	+ 7.69



A = Active

R = Reactive

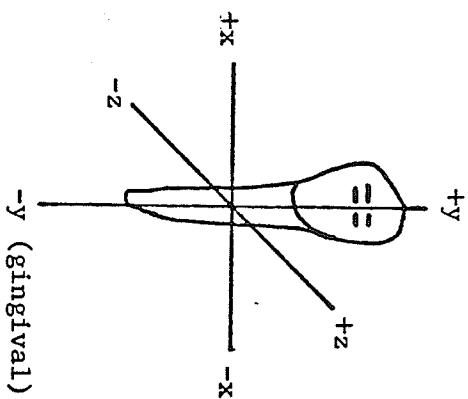

the T-loop where $L = 12$ mm. has the smallest value (7.82 gm.mm./gm.). The direction of the moment about this axis is such that, through deactivation of the active end of the loop, the crown of the tooth will be moved distal while the root is moved mesial.

Data consistent with that above was generated through a one millimeter activation of the same loops, in a gingival direction (Table IX). Directional changes were the same as those described in previous sections.

v) Variation of the d parameter in a T-loop.

Data generated through variation of the d parameter in a T-loop and activation through a one millimeter dimension, is presented in Table X.

Activation of the active end of the loops in an occlusal direction (+y) results, in all cases, in the production of a force in the opposite direction. At one millimeter activations the force magnitudes vary from -110.50 gm. for a T-loop where $d = 2$ mm., to -77.08 gm. for a T-loop where $d = 4$ mm.

Force generation along the x-axis is small, when compared to the primary force production (F_y), and is directed in a mesial direction at the center of resistance of the active tooth.

Force production in the z direction is very small, and in all cases very close to being zero.

Slope values for rotational effects around the x-axis are all consistent in direction and magnitude.

TABLE X

Force and Moment Relationships for Centered T-Loop Occlusally Activated,
Variation of Parameter "d".

d	2 mm	3 mm	4 mm
F_y/A_y	+110.50	+88.55	+77.08
F_x/E_y	+ 0.06	+ 0.12	+ 0.08
F_z/F_y	- 0.01	+ 0.04	+ 0.01
M_x/F_y	+ 2.83	+ 2.90	+ 2.94
M_y/F_y	- 0.07	+ 0.05	+ 0.03
M_z/F_y	+ 10.83	+ 8.94	+ 8.98

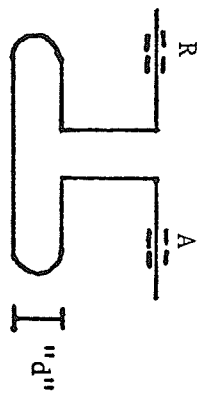

A = Active

R = Reactive

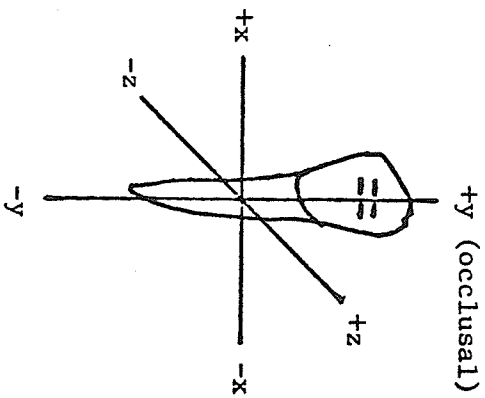
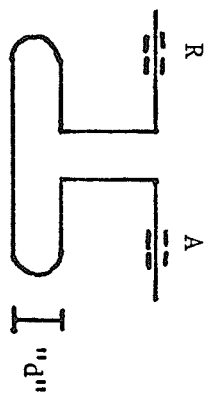

TABLE XI

Force and Moment Relationships for Centered T-Loop Gingivally Activated,
Variation of Parameter "d".

d	2 mm	3 mm	4 mm
Fy/Zy	+112.05	+84.74	+73.17
Fx/Fy	+ 0.01	+ 0.01	+ 0.09
Fz/Fy	0.00	- 0.04	- 0.01
Mx/Fy	+ 2.68	+ 2.83	+ 2.82
My/Fy	+ 0.09	+ 0.09	+ 0.05
Mz/Fy	+ 10.21	+ 8.34	+ 8.32



A = Active
R = Reactive

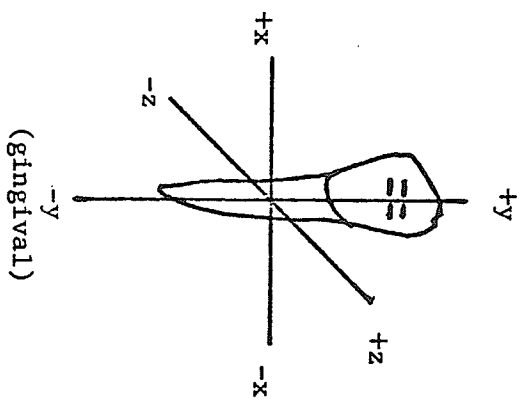

Slope values for rotational effects around the y-axis are all very small and are very close to equalling zero.

Rotational effects around the z-axis are consistent in direction, but vary in magnitude. The direction of this moment, for a +y activation of the loops, is such that the crown of the active tooth is moved distal, while the root is moved mesial.

Activation of the same loops over a one millimeter gingival dimension, yields data of similar magnitude to that above (Table XI). Directional changes, as compared with an occlusal activation, are consistent with those described in previous sections.

b) Bucco-lingual Activations.

Loops tested in this block of the experiment were symmetrically placed in the 7 mm. interbracket space, and activated over a range of one millimeter, in both buccal and lingual directions.

i) Variation of the H parameter in a vertical loop.

Data generated as a result of variation of the vertical component (H) of a vertical loop is presented in Table XII.

Activation of the active end of the loops, in a buccal direction, resulted in all cases in the generation of a force in the opposite direction. The loop with the shortest vertical component produced a force (F_z) of the greatest magnitude (58.59 gm./mm.), while the loop with the longest vertical component developed a force with the least

magnitude (20.98 gm./mm.).

Slope values for forces generated in the x direction are small, when compared to the primary force (F_z). They vary in absolute magnitude from 4.10 gm., at one millimeter activation of a 6 mm. vertical loop, to 2.10 gm. for the same activation of a 12 mm. vertical loop.

Force generation along the y-axis is larger than that along the x-axis. The magnitude of this force is approximately twice that of the F_x , and is gingivally directed.

Rotational effects around the x-axis are very consistent throughout the variation in height of the vertical loop. Direction of this moment is such that the crown of the tooth will be moved lingually, and the root buccally.

Slopes of the rotational effects around the y-axis are all negatively directed. As such, during deactivation of the appliance, the distal aspect of the crown of the tooth will be rotated distally around this axis.

Magnitudes of the moments about the z-axis are all very small. They are all negatively directed and will tend to tip the crown of the tooth distally.

Activation of these same appliances one millimeter in the lingual direction (Table XIII) yields results consistent in magnitude with those above.

ii) Variation of the D parameter in a vertical loop.

Data generated as a result of variation of the width of the

TABLE XII

Force and Moment Relationships for Centered Vertical Loop Buccally Activated, Variation of Parameter "H".

H	6 mm	8 mm	10 mm	12 mm
F_z/A_z	+58.59	+38.57	+26.75	+20.98
F_x/F_z	+ 0.07	+ 0.07	+ 0.06	+ 0.10
F_y/F_z	- 0.18	- 0.19	- 0.16	- 0.16
M_x/F_z	+11.89	+12.05	+12.20	+11.56
M_y/F_z	- 4.09	- 4.82	- 5.05	- 4.16
M_z/F_z	- 1.04	- 1.11	+ 1.06	- 1.02

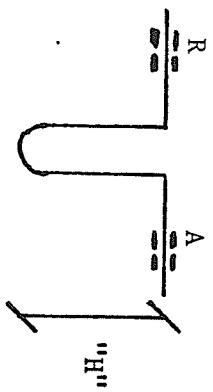

A = Active

R = Reactive

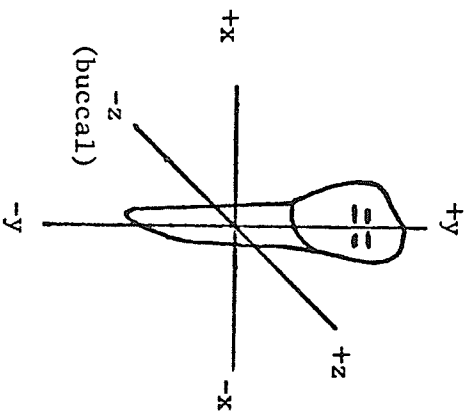
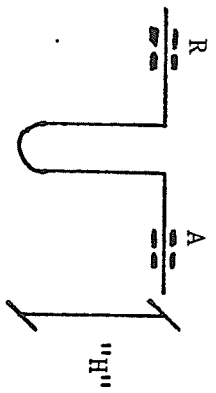

TABLE XIII

Force and Moment Relationships for Centered Vertical Loop Lingually
Activated, Variation of Parameter "h".

D	6 mm	8 mm	10 mm	12 mm
Fz/Az	+65.70	+42.55	+28.61	+23.84
Fx/Fz	+ 0.11	+ 0.10	+ 0.13	+ 0.14
Fy/Fz	- 0.16	- 0.15	- 0.23	- 0.08
Mx/Fz	+12.06	+12.25	+11.94	+11.09
My/Fz	- 4.24	- 4.33	- 4.62	- 4.14
Mz/Fz	- 1.15	- 1.28	- 0.89	- 1.80



A = Active
R = Reactive

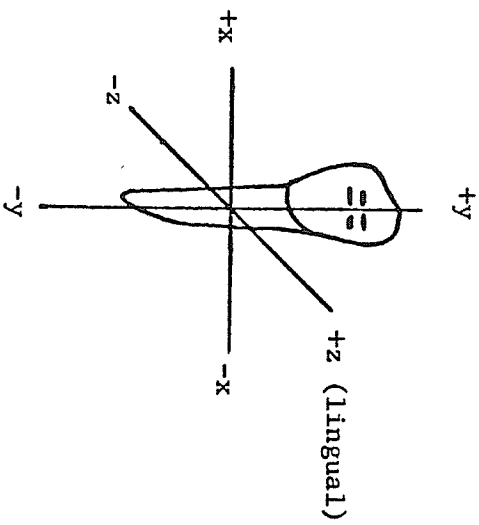

half-helix (D), at the apex of a vertical loop, is presented in Table XIV.

All loops tested in this part of the experiment, when activated in the buccal direction, produced a force in the opposite direction. The magnitude of this force varied from 38.57 gm., for every millimeter of activation of the loop with $D = 2$ mm., to 33.56 gm. per millimeter of activation of the loop when D was increased to 5 mm. The percentage decrease in force production along the z-axis, for an increase in the D-dimension of three millimeters, was thus only 8.70.

Forces developed along the x-axis, during deactivation of these loops, are much smaller than the z-forces, and are in all cases distally direct.

The slope values for forces developed in the y direction are also very small and negatively directed. As such they exert a gingivally directed force to the active tooth.

Rotational effects about the x-axis, for buccal activation of the appliances tested in this section, are all equivalent in direction, but vary in magnitude. The slopes of these moment to force ratios are all positive. The absolute magnitude of this ratio is greatest when $D = 2$ mm., and decreases in value as parameter D is increased.

The magnitude of the slopes of the rotational effects about the y-axis, for a buccal activation of the appliances, are consistent in both direction and magnitude. The direction of these moments is such that the distal aspect of the tooth would be rotated distally around the y-axis.

TABLE XIV.

Force and Moment Relationships for Centered Vertical Loop Buccally Activated, Variation of Parameter "d".

D	2 mm	3 mm	4 mm	5 mm
F_z/A_z	+38.57	+37.63	+34.18	+33.56
F_x/F_z	+ 0.07	+ 0.12	+ 0.19	+ 0.21
F_y/F_z	- 0.19	- 0.06	- 0.07	- 0.01
M_x/F_z	+12.05	+10.25	+ 9.97	+ 8.84
M_y/F_z	- 4.82	- 4.65	- 4.48	- 5.01
M_z/F_z	- 0.61	- 0.69	- 0.88	- 1.49

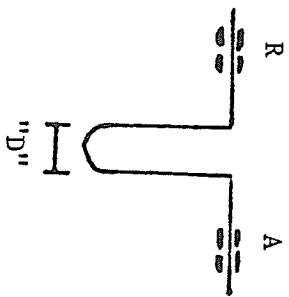

A = Active

R = Reactive

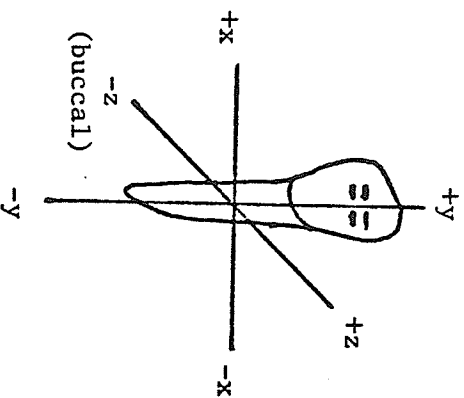
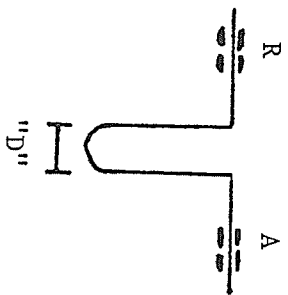

TABLE XV

Force and Moment Relationships for Centered Vertical Loop Lingually Activated, Variation of Parameter "D".

D	2 mm	3 mm	4 mm	5 mm
Fz/Az	+42.55	+39.16	+33.34	+31.33
Fx/Fz	+ 0.10	+ 0.14	+ 0.13	+ 0.06
Fy/Fz	- 0.15	- 0.11	- 0.10	- 0.01
Mx/Fz	+12.25	+10.52	+ 9.67	+ 8.88
My/Fz	- 4.33	- 5.22	- 4.90	- 4.58
Mz/Fz	- 1.28	- 1.79	- 0.90	- 1.02



A = Active
 R = Reactive

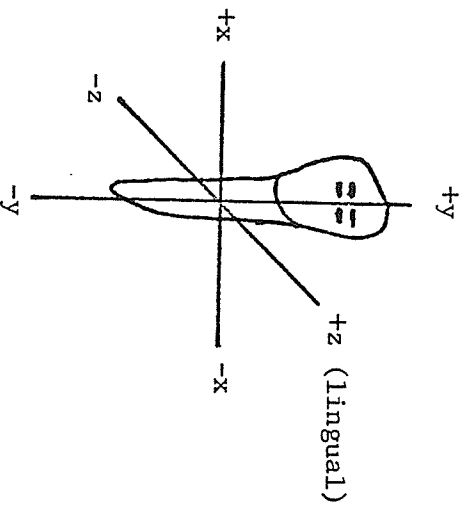

Rotational effects about the z-axis are all very small and negatively directed.

Data generated through activation of these same appliances in the lingual direction (Table XV), over a one millimeter range, demonstrates the same trends as that presented above. Again both the stiffness of the appliance, and the moment to force ratio about the x-axis, decrease as D is increased.

iii) Helical additions to a vertical loop.

The results of incorporating a 1 1/2 turn helix, at chosen points in a 8 mm. vertical loop, are presented in Table XVI. Two modifications of the standard vertical loop were tested.

Activation of the loops one millimeter buccally resulted in the generation of a force in the lingual direction, at the center of resistance of the model tooth. The magnitude of this force is very similar for all the loop configurations tested.

The slope values for forces generated in the x direction are consistent in magnitude and direction for the three configurations.

The slope values for force generated along the z-axis are all negatively directed for a buccal activation of the appliances.

Rotational effects around the x-axis are consistent in direction but vary as regards the magnitude of the slope. The magnitude of the moment to force ratio (M_x/F_z) is least for the 8 mm. vertical loop with a 1 1/2 turn helix at its apex. This ratio is similar for the other two loops.

TABLE XVI

Force and Moment Relationships for Centered Vertical Loop Buccally Activated, Helical Additions

	J	h	qp
Fz/Az	+38.57	+39.43	+40.61
Fx/Fz	+ 0.07	+ 0.13	+ 0.12
Fy/Fz	- 0.19	- 0.24	- 0.03
Mx/Fz	+12.05	+10.11	+11.80
My/Fz	- 4.82	- 4.28	- 5.14
Mz/Fz	- 0.61	- 1.66	+ 0.49

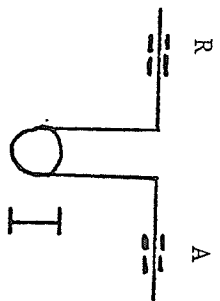

A = Active

R = Reactive

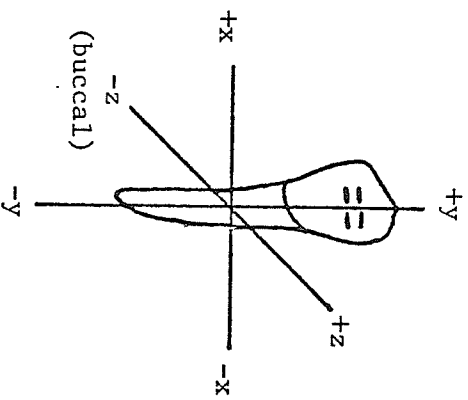
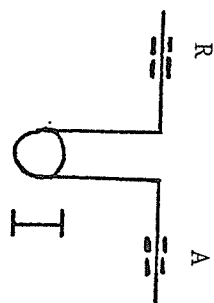

TABLE XVII

Force and Moment Relationships for Centered Vertical Loop Lingually Activated, Helical Additions

	U	V	W
F_z/A_z	+42.55	+40.82	+39.77
F_x/F_z	+ 0.10	+ 0.14	+ 0.09
F_y/F_z	- 0.15	+ 0.07	+ 0.15
M_x/F_z	+12.25	+ 8.23	+11.67
M_y/F_z	- 4.33	- 4.22	- 5.06
M_z/F_z	- 1.28	- 1.18	+ 1.36



A = Active

R = Reactive

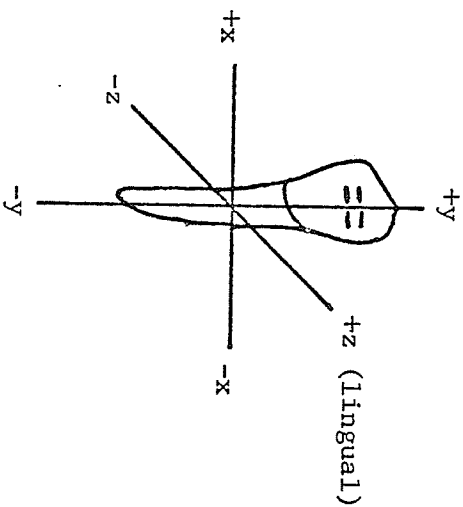

Moments about the y-axis, for a buccal activation of all the loops, are all similar in magnitude, and are all negatively directed.

The value of the slopes of the moments about the z-axis, for a z directed force, vary in direction. When compared to the other two loops tested in this part of the experiment, the addition of two 1 1/2 turn helices reverses the direction of this moment.

Activation of the active end of the same loops, over a one millimeter distance in the lingual direction, resulted, with one exception, in data consistent with that above (Table XVII). The moment developed about the x-axis, for a vertical loop with a 1 1/2 turn helix at its apex, activated lingually, was less than that generated with a buccal activation.

iv) Variation of the L parameter in a T-loop.

Data generated as a result of a buccal activation of one millimeter, while varying the gingival horizontal length of a T-loop (L), is presented in Table XVIII.

Buccal activation of the active end of these loops resulted in the generation of a force in the opposite (+z) direction. The slopes of the plots of force generation, versus activation distance, are all negatively directed. The magnitudes of these slopes are very similar for all the loops tested in this part of the experiment.

Slope values for force generation in the x direction are all small, and have a direction of action distal along the x-axis.

Slope values for force generation along the y-axis are again all

TABLE XVIII

Force and Moment Relationships for Centered T-Loop Buccally
Activated, Variation of Parameter "L".

L	8 mm	10 mm	12 mm
F_z/A_z	+21.73	+20.33	+19.50
F_x/F_z	+0.08	+0.10	+0.11
F_y/F_z	-0.05	-0.06	-0.05
M_x/F_z	+9.70	+9.24	+8.95
M_y/F_z	-5.11	-4.85	-5.00
M_z/F_z	-0.86	-1.44	+0.42

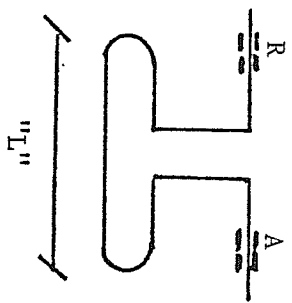

A = Active

R = Reactive

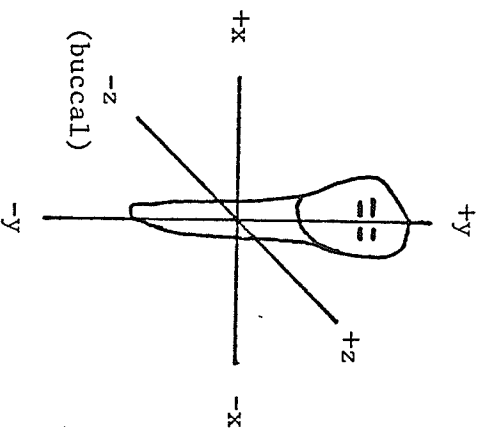
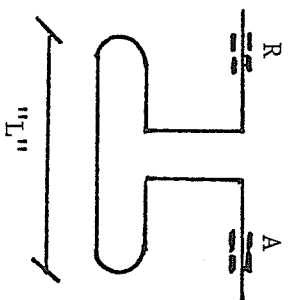

TABLE XIX

Force and Moment Relationships for Centered T-Loop Lingually Activated,
Variation of Parameter "L".

L	8 mm	10 mm	12 mm
Fz/Az	+22.09	+19.35	+17.25
Fz/Fz	+ 0.05	+ 0.01	+ 0.03
Fy/Fz	- 0.13	- 0.10	- 0.14
Mx/Fz	+ 9.13	+ 8.59	+ 8.47
My/Fz	- 4.45	- 4.35	- 4.24
Mz/Fz	+ 0.24	- 0.74	+ 0.58



A = Active

R = Reactive

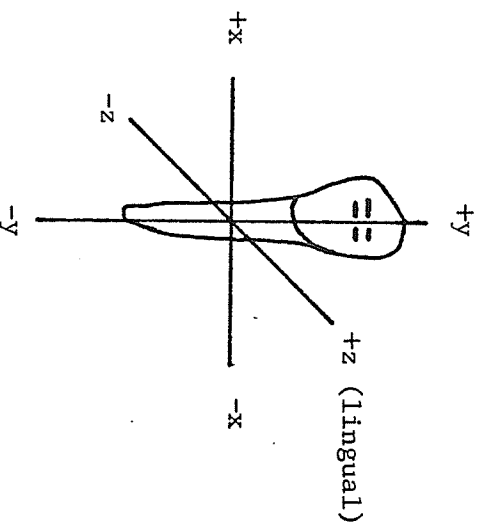

small and are negatively directed.

Rotational effects about the x-axis are consistent in direction, but demonstrate a slight decrease in magnitude as the gingival-horizontal length of the loop is increased.

Slope values for rotational effects about the y-axis are consistent in both magnitude and direction. The direction of these moments is such that the distal aspect of the active (model) tooth will be rotated distally, about the y-axis, as the appliance deactivates.

Slope values for rotational effects about the z-axis are all very small and approximate zero.

Data, consistent in magnitude with that above, was generated through a one millimeter activation of the same loops in the lingual direction (Table XIX).

v) Variation of the d parameter in a T-loop.

Data generated through variation of the d parameter in a T-loop, and activation through a one millimeter buccal dimension, is presented in Table XX.

A one millimeter activation of the active end of the loops, in a buccal direction (-z), results, in all cases, in the production of a force in the opposite direction. Force magnitudes vary from 21.73 gm., for a T-loop where $d = 2$ mm., to 14.29 gm. for a T-loop where $d = 4$ mm.

Force generation along the x-axis is small, and is directed in a distal direction at the center of resistance of the active tooth.

TABLE XX

Force and Moment Relationships for centered T-Loop Buccally Activated, Variation of Parameter "d".

d	2 mm	3 mm	4 mm
Fz/Az	+21.73	+17.00	+14.29
Fx/Fz	+0.08	+0.09	+0.16
Fy/Fz	-0.05	-0.08	-0.04
Mx/Fz	+9.70	+10.24	+11.12
My/Fz	-5.11	-4.68	-4.98
Mz/Fz	-0.86	-0.40	-1.10

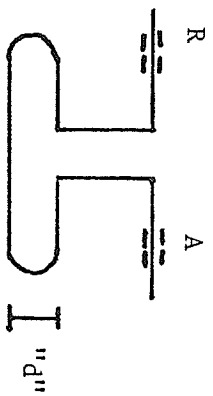

A = Active
R = Reactive

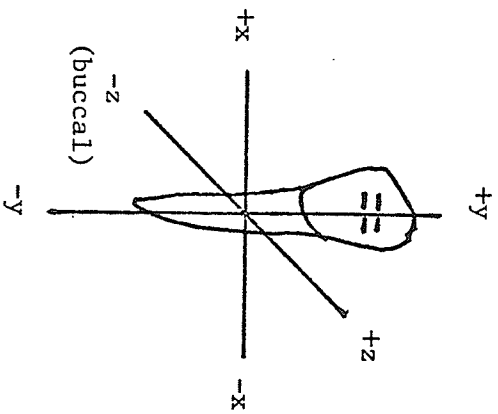
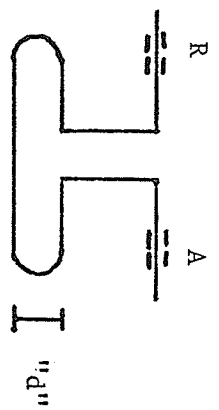

TABLE XXI

Force and Moment Relationships for Centered T-Loop Lingually Activated,
Variation of Parameter "d".

d	2 mm	3 mm	4 mm
F_z/A_z	+22.09	+19.13	+17.54
F_x/F_z	+ 0.05	+ 0.07	+ 0.05
F_y/F_z	- 0.13	- 0.07	- 0.11
M_z/F_z	+ 9.13	+10.60	+10.93
M_y/F_z	- 4.45	- 4.35	- 5.24
M_x/F_z	+ 0.24	- 1.08	- 1.17



A = Active
R = Reactive

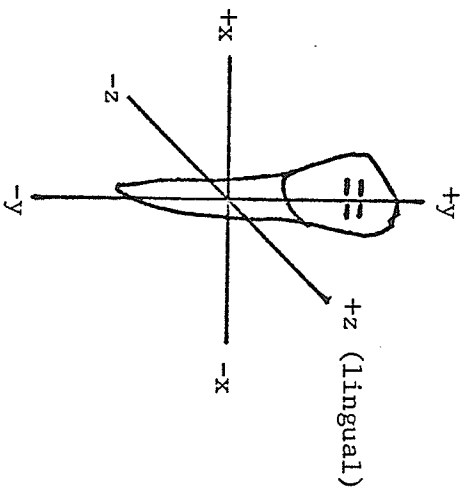

Force production in the z direction is again small, and gingivally directed.

Slope values for rotational effects around the x-axis are consistent in direction, but demonstrate a slight increase in magnitude as d is increased from 2 mm. to 4 mm.

Slope values for rotational effects around the y-axis are similar in both direction and magnitude. Their direction is such that, during deactivation, the distal aspect of the active tooth will be rotated distal about this axis.

Rotational effects about the z-axis are all very small, and do in fact approximate zero.

Activation of the same loops, over a one millimeter lingual dimension, results in data of similar magnitude (Table XXI). Directional changes, as compared with a buccal activation, are consistent with those presented in previous sections.

Asymmetrical Loop Configuration (L-loop):

a) Occluso-gingival Activations.

i) Centered L-loop.

The L-loop tested in this block of the experiment was symmetrically placed in the 7 mm. interbracket space, with the "toe" of the loop directed toward the designated active (A) end of the appliance. Data was then generated from one millimeter occlusal and one millimeter gingival activations of the appliance (Table XXII). The loop was

then rotated 180 degrees around the y-axis, and the activations repeated. This allowed for the delineation of force and moment at both the active (A) and reactive (R) ends of the loop.

At the designated active end of the loop, an occlusal activation of one millimeter results in the generation of a force in the opposite direction. The magnitude of this force at full activation is -128.57 gm.

Activation of the loop in this dimension also results in the generation of a force along the x-axis. The magnitude of this force is 20% of that of the primary force (F_y), and is mesially directed.

The magnitude of any force developed along the z-axis is negligible.

At the center of resistance of the active tooth, the moment about the x-axis is directed such that the crown of the tooth will be tipped buccally. The moment to force ratio (M_x/F_y) about this axis has a value of 2.65 gm.mm./gm.

The slope value of the rotational effect around the y-axis is negatively directed and small in magnitude.

The moment to force ratio about the z-axis (M_z/F_y) has a magnitude of 5.84 gm.mm./gm. The moment (M_z) has a negative value, and hence a direction that will tip the crown of the active tooth in the distal direction.

Activation of this loop generates forces and moments, at the center of resistance of the reactive tooth, similar in magnitude to those at the active tooth. The only exception involves the slope of the

TABLE XXII

Force and Moment Relationship for Centered L-Loop Vertically Activated, "Toe" of Loop Directed Mesially

	OCCLUSAL ACTIVATION		GINGIVAL ACTIVATION	
	R	A	R	A
Fy/Ay	+128.22	+128.57	+134.30	+133.97
Fx/Fy	- 0.18	+ 0.20	- 0.09	+ 0.17
Fz/Fy	0.00	0.00	+ 0.02	+ 0.01
Mx/Fy	+ 2.67	+ 2.65	+ 2.58	+ 2.69
My/Fy	+ 0.37	- 0.36	+ 0.45	- 0.07
Mz/Fy	- 10.20	+ 5.84	- 10.27	+ 5.90

A = Active
R = Reactive

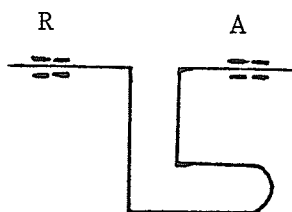

rotational effect about the z-axis. At the reactive tooth, the magnitude of this slope is $-10.20 \text{ gm.mm./gm.}$

Activation, in the gingival direction, of the active end of this L-loop yields data similar to that for an occlusal activation (Table XXII). Magnitudes are similar, the only difference from the data for an occlusal activation being in the direction of the action of the various forces and moments.

ii) L-loop one millimeter from the active tooth bracket.

In this part of the experiment the L-loop described above was moved to a position one millimeter distal to the model (active) tooth. The "toe" of the loop was again directed toward the active tooth, and the interbracket space was maintained at 7 mm. Experimental methodology was as described in the previous section.

A one millimeter occlusal activation, of the active end of the loop, resulted in a force generated along the y-axis (Table XXIII). This force had a magnitude of -149.59 gm. at full activation, and a gingival direction.

Force generated along the x-axis is mesially directed and has a magnitude equal to 34% of the force developed along the y-axis.

The magnitude of any force developed along the z-axis is negligible.

Activation of this loop results in the generation of a moment around the x-axis. The direction of this moment is such as to tip the crown of the tooth buccally. The moment to force ratio about this

Force and Moment Relationships for L-Loop (1.0 mm from Active Tooth) Vertically Activated, "Toe" of Loop Directed Mesially

	OCCLUSAL ACTIVATION		GINGIVAL ACTIVATED	
	R	A	R	A
Fy/Ay	+149.50	+149.59	+150.00	+136.58
Fx/Fy	- 0.31	+ 0.34	- 0.21	+ 0.28
Fx/Fy	- 0.01	0.00	0.00	+ 0.01
Mx/Fy	+ 2.37	+ 2.85	+ 2.19	± 2.79
My/Fy	+ 0.63	- 0.74	+ 0.57	- 0.44
Mz/Fy	- 11.29	+ 4.43	- 10.54	+ 4.49

A = Active
R = Reactive

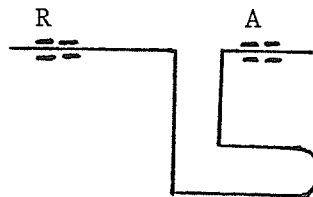

axis has a value of 2.85 gm.mm./gm.

The slope value of the rotational effect around the y-axis is negatively directed. The direction of this moment is such that the active tooth will be rotated mesial during activation of the appliance.

The slope value of the rotational effect around the z-axis is positively directed and has a magnitude of 4.43 gm.mm./gm.

Magnitudes of forces and moments generated at the center of resistance of the reactive tooth, during activation of the appliance, are, with two exceptions, very similar to those at the active tooth.

The slope of the rotational effect around the x-axis has a value of 2.37 gm.mm./gm. at the reactive tooth. This compares with a value of 2.85 gm.mm./gm. at the active tooth.

The M_z/F_y relationship changes to a value of -11.29 gm.mm./gm. at the reactive tooth, as compared with a value of 4.43 gm.mm./gm. at the active tooth.

Activation of this loop one millimeter in the gingival direction again generates results similar in magnitude with those presented above (Table XXIII).

iii) Reversed L-loop one millimeter from the active tooth bracket.

In this part of the experiment the L-loop was again placed one millimeter distal to the active tooth brackets but the "toe" of the loop was directed towards the designated reactive tooth. Experimental methodology was as described in the previous sections.

Activation of this loop one millimeter occlusally resulted in a negative force generation along the y-axis (Table XXIV). The slope value for this relationship had a value of 126.55 gm./mm.

The slope value in the x direction is very small and negatively directed.

The slope value in the z direction is very close to being zero.

The slope value for the rotational effect around the x-axis is positively directed and has a value of 1.58 gm.mm./gm.

The slope value for the rotational effect around the y-axis is small in magnitude. Coupled with a vertical intercept of zero, moments about this axis may be considered to be very small.

Activation of the appliance results in the generation of a significant moment around the z-axis. The slope value for the rotational effect around this axis is positively directed and has a value of 8.84 gm.mm./gm.

Forces and moments produced at the reactive tooth are presented in Table XXIV. As compared with the active tooth, of significance is the increase in the M_x/F_y relationship, and the decrease in the M_z/F_y relationship.

A one millimeter gingival activation of the active end of this L-loop generated data presented in Table XXIV. Moment and force directions are opposite to those presented for an occlusal activation, but the magnitudes are very similar.

b) Bucco-lingual Activations.

TABLE XXIV

Force and Moment Relationships for L-Loop (1.0 mm from Active Tooth) Vertically Activated, "Toe" of Loop Directed Distally.

	OCCLUSAL ACTIVATION		GINGIVAL ACTIVATION	
	R	A	R	A
Fy/Ay	+130.01	+126.55	+135.33	+131.27
Fx/Fy	+ 0.05	- 0.09	+ 0.08	- 0.09
Fz/Fy	- 0.02	- 0.01	- 0.01	- 0.01
Mx/Fy	+ 2.72	+ 1.58	+ 2.39	+ 1.89
My/Fy	- 0.13	+ 0.19	- 0.11	+ 0.24
Mz/Fy	- 7.56	+ 8.58	- 7.17	+ 8.84

A = Active
R = Reactive

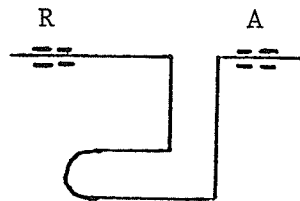

i) Centered L-loop.

The L-loop tested in this block of the experiment had the same dimensional parameters as that used in the previous sections. The loop was initially symmetrically placed in the 7 mm. interbracket space, and the "toe" of the loop directed toward the designated active (model) tooth. The loop was then activated through one millimeter in both the buccal and lingual directions, rotated 180 degrees on the y-axis, and again activated buccally and lingually one millimeter.

A one millimeter buccal activation of the active end of the loop results in the generation of a force in the opposite direction (Table XXV). The slope value of this relationship has a positive direction and a value of 26.49 gm./mm.

The slope value for force generation along the x-axis is positively directed and very small in magnitude.

The magnitude of the force developed along the y-axis is also very small, and is directed gingivally.

The slope of the rotational effect around the x-axis is positively directed, and has a value of 7.39 gm.mm./gm. At the center of resistance of the active tooth, this moment is directed such as to cause the crown of the tooth to be tipped lingually.

The moment to force ratio about the y-axis (M_y/F_z) has a value of -2.75 gm.mm./gm. The moment (M_y) has a negative value, and hence a direction that will rotate the distal aspect of the active tooth distally about this axis.

Force and Moment Relationships for Centered L-Loop Horizontally Activated, "Toe" of Loop Directed Mesially.

	BUCCAL ACTIVATION		LINGUAL ACTIVATION	
	R	A	R	A
F_z/A_z	+26.27	+26.49	+26.03	+26.35
F_x/F_z	+ 0.06	+ 0.05	+ 0.10	+ 0.12
F_y/F_z	+ 0.04	- 0.02	+ 0.07	- 0.05
M_x/F_z	+ 7.82	+ 7.39	+ 7.67	+ 7.10
M_y/F_z	- 3.22	- 2.75	- 3.47	- 3.04
M_z/F_z	- 0.49	- 0.10	- 0.21	- 0.54

A = Active
R = Reactive

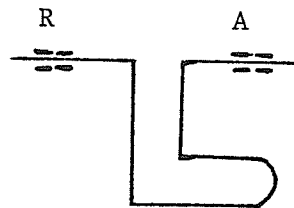

The slope value of the rotational effect around the z-axis is negatively directed and very small in magnitude.

At the designated reactive tooth differences in force and moment value, from those generated at the active tooth, occur in the M_x/F_z and M_y/F_z relationships. Both these ratios are larger in value at the reactive tooth center of resistance.

Activation of this same appliance in the lingual direction, over a distance of one millimeter, results in data of similar magnitude as for a similar one millimeter buccal activation (Table XXV).

ii) L-loop one millimeter from the active tooth bracket.

In this part of the experiment the L-loop was moved to a position one millimeter distal to the active tooth. The "toe" of the loop was directed toward this tooth. Experimental methodology again involved one millimeter buccal and lingual activation of the active end of the appliance.

A one millimeter buccal activation, of the active end of the appliance, resulted in a force generation along the z-axis (Table XXVI). This force had a magnitude of 26.55 gm., at full activation, and a lingual direction.

Force directed along the x-axis is mesially directed and is very small in magnitude.

The magnitude of the force developed along the z-axis is also very small, and has a gingival direction.

Activation of this loop results in the generation of a moment

Force and Moment Relationships for L-Loop (1.0 mm from Active Tooth) Horizontally Activated, "Toe" of Loop Directed Mesially

	BUCCAL ACTIVATION		LINGUAL ACTIVATION	
	R	A	R	A
F_z/A_z	+23.33	+26.55	+23.87	+25.28
F_x/F_z	+ 0.07	+ 0.04	+ 0.17	+ 0.20
F_y/F_z	+ 0.06	- 0.03	+ 0.07	- 0.03
M_x/F_z	+ 8.89	+ 6.92	+ 9.56	+ 6.67
M_y/F_z	- 5.54	- 2.61	- 5.65	- 2.60
M_z/F_z	- 0.18	- 0.11	- 0.85	- 0.32

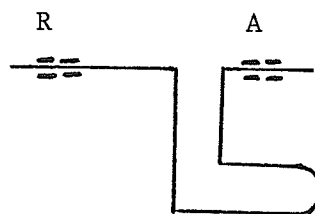

A = Active

R = Reactive

around the x-axis. The direction of this moment is such as to tip the crown of the tooth lingually. The moment to force ratio about this axis has a value of 6.92 gm.mm./gm.

The slope value of the rotational effect around the y-axis is negatively directed and has a value of -2.61 gm.mm./gm.

The slope value of the rotational effect around the z-axis is negatively directed and very small in magnitude.

The magnitudes of forces and moments generated at the center of resistance of the reactive tooth are very similar to those generated at the active tooth. There are two exceptions, namely an increase in magnitude in the M_x/F_z and M_y/F_z relationships at the reactive tooth.

Activation of this loop one millimeter in the lingual direction yields data similar in magnitude with that presented above (Table XXVI).

iii) Reversed L-loop one millimeter from the active tooth bracket.

This part of the experiment involved placement of the L-loop one millimeter distal to the active tooth bracket, the "toe" of the loop being directed toward the designated reactive tooth. The loop was activated over a one millimeter dimension in both buccal and lingual directions.

Activation of this loop one millimeter buccally resulted in generation of a force along the z-axis (Table XXVII). The slope value for this relationship had a value of 25.17 gm./mm.

The slope value for forces generated in the x direction is

positively directed and is small in magnitude.

The slope value in the z direction is positively directed and is small in magnitude.

Activation of this L-loop results in the generation of a significant moment about the x-axis. The slope value for the rotational effect around this axis is positively directed and has a value of 8.26 gm.mm./gm.

The slope value for the rotational effect around the y-axis is negatively directed and has a value of -3.22 gm.mm./gm.

The slope value for the rotational effect around the z-axis is small in magnitude. Coupled with a vertical intercept of zero, moments about this axis may be considered to be very small.

Forces and moments produced at the reactive tooth, with a one millimeter buccal activation of the active end of the loop, are presented in Table XXVII. As compared to the active tooth, of significance is the decrease in both the M_x/F_z and M_y/F_z relationships.

A one millimeter lingual activation of the active end of this L-loop configuration generated data presented in Table XXVII. Moment and force directions are opposite to those presented for an occlusal activation, but the magnitudes are similar.

TABLE XXVII

Force and Moment Relationships for L-Loop (1.0 mm from Active Tooth) Horizontally Activated, "Toe" of Loop Directed Distally.

	BUCCAL ACTIVATION		LINGUAL ACTIVATION	
	R	A	R	A
F_z/A_z	+25.00	+25.17	+26.08	+25.78
F_x/F_z	+ 0.10	+ 0.08	+ 0.08	+ 0.10
F_y/F_z	- 0.10	+ 0.08	- 0.12	+ 0.10
M_x/F_z	+ 7.39	+ 8.26	+ 6.96	+ 7.82
M_y/F_z	- 2.83	- 3.22	- 3.04	- 3.57
M_z/F_z	- 0.15	- 0.16	- 0.18	- 0.80

A = Active
R = Reactive

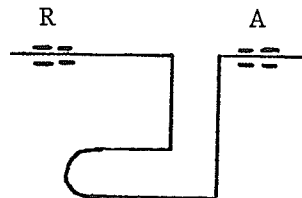

Discussion

Introduction

Most orthodontic appliances deliver a relatively complicated set of three-dimensional forces and moments to the tooth and its investing structures. Since desired tooth movement may only be initiated through the application of an appropriate force system, it is important that the mechanical properties of the appliance systems used by an orthodontist be thoroughly understood. The goal of this investigation is to experimentally define the three-dimensional mechanical behaviour of selected designs of alignment loops, activated in both the vertical and horizontal planes.

No attempt is made here to define the actual tooth movement that might result from forces and moments generated by any of the appliances tested. This may seem a severe limitation of the value of the results. However, the confusion that still reigns (Hixon et al., 1970) concerning the relationship between force magnitude and tooth movement makes interpretation of the present results, in terms of tooth movement, impossible. Conversely, the clear and quantitative statements concerning force delivery of orthodontic appliances made in the present study will help in the process of elucidating tooth movement/force applications relationships.

The use of the previously described measuring device allowed for the simultaneous measurement of forces and moments at the center of resistance of the model tooth. Data generated was then reduced to a

workable form through the use of single slope values representative of the selected relationships. The use of these slope values is contingent on the assumption of theoretical linearity.

For the most part, plots of the chosen relationships were very linear, but some non-linearities were observed in moment generation (see M_z/F_z , Figure 13). Two likely causes of such non-linearities are (i) stress in the wire having exceeded the yield level, and (ii) changes in the geometry of the loop configurations as the activation was increased.

The maximum activation distance used in any of the experimental blocks was one millimeter. At the end of each activation the loop was returned to its initial state in the measuring device, through the use of the displayed output of the L.V.D.T.'s. A force measurement was then recorded to insure that the loop was again passive and hence, that the yield stress level had not been exceeded. Consequently, the non-linearities present in some of the plots involving moment generation may be attributed to geometric effects, particularly that of buckling.

Evaluation of the performance of the tested loop configurations was based upon their ability to generate a pure translatory movement of the model tooth, and the maintenance of a constant force over the entire activation distance. In this investigation all measurements are made at the center of resistance of the model tooth, and hence pure translation is elicited when the only non-zero relationship recorded is the force generated along the activation axis.

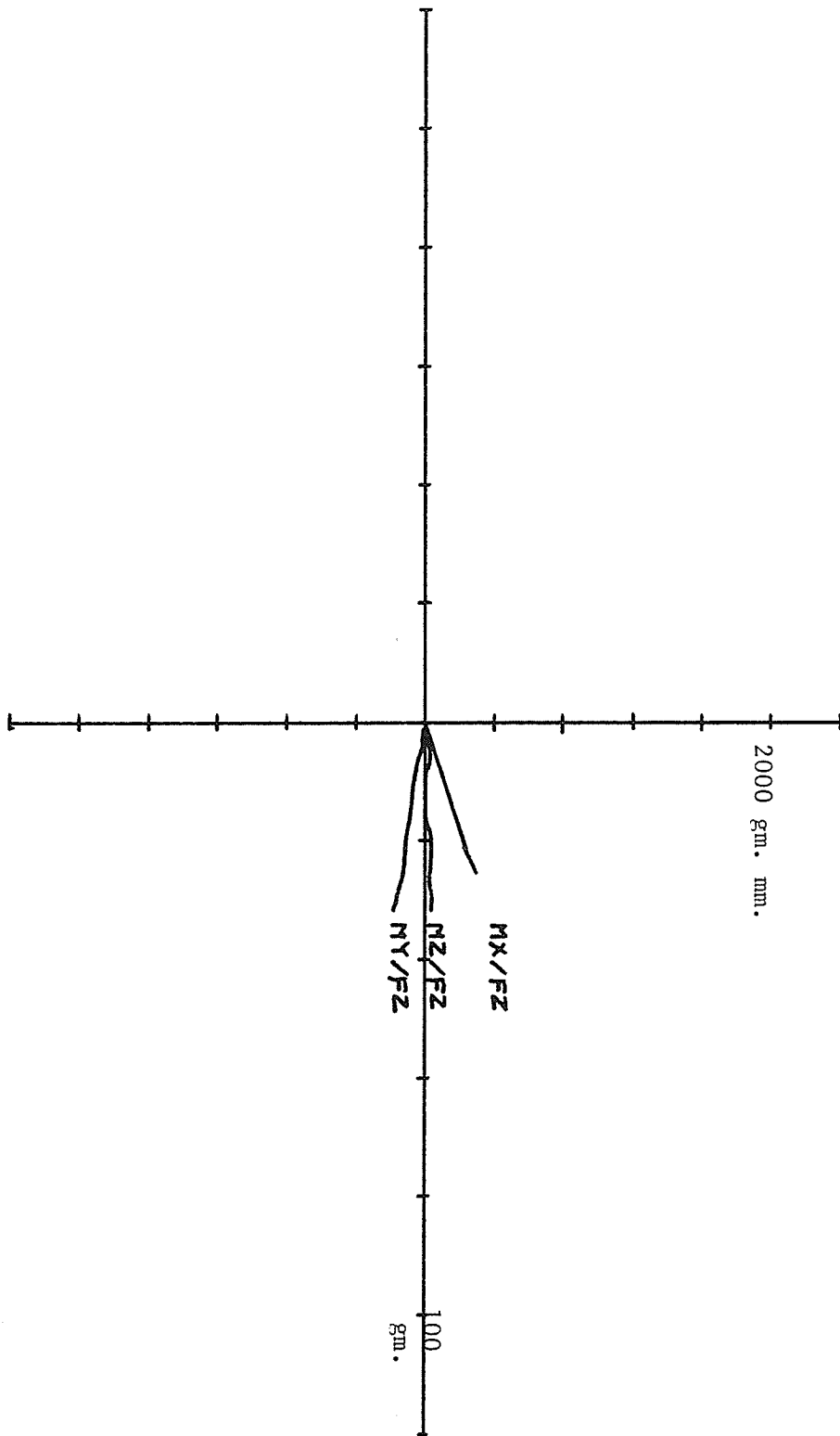

FIGURE 13: Plot of moments generated with a buccal activation of a 10 mm vertical loop.

Biological constraints necessitate the application of the force system at the "bracket" of the tooth, not at its center of resistance. This results in the generation of at least two moments at the center of resistance when a single translatory force is applied at the bracket. Thus, the ability of the loop configurations to translate the model tooth depends upon how well they counteract any spurious moments generated by applying the translatory force at the bracket.

The maintenance of a somewhat constant force, along the desired activation axis, necessitates a low appliance stiffness (load-deflection rate) value. For example, a loop with a stiffness value of 100 gm./mm., activated to develop 200 gm. of force, would lose one-half this force level per millimeter of closure. In contrast, a loop of low stiffness value (10 gm./mm.), similarly activated to 200 gm., would dissipate only 5% of its force level per millimeter of closure.

In order to thoroughly evaluate the properties of the activated loop configurations, the data generated will be discussed under the following headings:

- i) stiffness value
- ii) spurious forces
- iii) rotational effects around the x-axis
- iv) rotational effects around the y-axis
- v) rotational effects around the z-axis
- vi) summary.

Vertical Activation

i) Stiffness value

For all loops examined, a vertical activation resulted in the generation of a force along the vertical axis. The force direction was opposite to the activation direction. However, magnitudes of this force (F_y) varied considerably, this variance being attributed solely to the design of the loop itself.

Vertical additions of wire to a vertical loop did reduce the stiffness value of the loop. As can be seen in Table II, whereas an 8 mm. vertical loop had a stiffness value of 179.23 gm./mm., an increase in the vertical component to 12 mm. lowered this stiffness value to 162.63 gm./mm. Thus the interbracket addition of approximately 8 mm. of wire decreased the stiffness of this appliance, to a vertical activation, approximately 9%.

Additions of wire at the apex of the vertical loop also decreased the stiffness of the loop. As compared to the standard vertical loop with a half-helix (D) of diameter 2 mm. at its apex, an increase in diameter of this half-helix to 5 mm. lowered the stiffness value to 114.63 gm./mm. (Table IV). This configurational change in the vertical loop entailed the addition of approximately 3 mm. of wire in the horizontal plane. The result is a decrease in force production (F_y), at one millimeter of activation, of 36%.

Helical additions were also found to alter the stiffness of an 8 mm. vertical loop activated along the vertical axis (Table VI). Incorporation of a 1 1/2 turn helix at the apex of the loop lowered

the stiffness value to 168.40 gm./mm. from 179.23 gm./mm. A configurational change involving the addition of two 1 1/2 turn helices, at the reflex points of the loop where the vertical arm joins the horizontal arm, further lowered this value to 131.89 gm./mm.

The above results indicate that, when vertically activated, the vertical loop design is a very stiff appliance. The vertical addition of wire up to 12 mm., which would likely be biologically incompatible in the oral environment, still leaves a loop configuration which, for every millimeter of activation, will produce a vertical force well in excess of 150 gm. Helical additions to the appliance design do not lower the stiffness of the loop to any appreciable degree. This result is consistent with data presented by Jarabak and Fizzell (1972). In fact the above findings indicate that, for vertical activations, the most efficient design changes, directed at lowering the stiffness of the loop, occur with the addition of wire along the defined mesio-distal direction of the xy plane.

Further exploration of this hypothesis involved the testing of symmetrical T-loop designs. The T-loops had the same vertical component as the 8 mm. vertical loop, but the horizontal component of the wire was varied in these loops.

When vertically activated, a T-loop with a gingival-horizontal length of 8 mm. had a stiffness value of 110.50 gm./mm. (Table VIII). This value represents a 38% decrease in magnitude of force generated by an 8 mm. vertical loop under similar activation. A further addition to the gingival-horizontal parameter of the loop, to a total

length of 12 mm., lowered this value a further 34%, representing a total decrease in stiffness value of 72%.

Additions of wire to the d-parameter of the T-loop also decreased the stiffness of the loop to vertical activations. This addition was made along the vertical axis of the loop, and as occurred with increases in height of the vertical loop, the lowering of the stiffness value was not as dramatic as when additions were made along the horizontal axis.

Loops with low stiffness values deliver a more constant force during deactivation, and also offer greater control over the desired force magnitude. This stiffness value may be lowered through a reduction in cross-section of the wire, or by an increase in the total length of wire in the loop. However, the results of vertical activation of selected symmetrical loops indicate that arbitrary increases in length of wire in the loop may be of little value.

ii) Spurious forces

An ideal alignment loop configuration would be one for which an activation along a defined axis generated only a force along that axis. As such, vertically activated loops would generate a F_y value, but magnitudes for forces developed along the x-axis (F_x) and the z-axis (F_z) would be zero.

None of the loops tested fulfilled this requirement. All vertical activations resulted in the generation of a force along the y-axis (F_y), but in all cases the total force system also included x and

z-directed forces.

In the symmetrical loops tested, the direction of F_x was opposite for an occlusal activation, as compared to a gingival activation. When the active end of the loop was occlusally activated, a mesial directed force along the x-axis was generated at the center of resistance of the model (active) tooth. The magnitude of this force (F_x) is very consistent as regards the two major types of loop designs tested. Symmetrical vertical loop configurations maintained an F_x value approximately 10% that of the primary force (F_y). For the symmetrical T-loop configurations, the value of the F_x/F_y relationship was approximately one-half that of vertical loops.

Due to the rigid attachment of the ends of the loop to the measuring system, an occlusal displacement of the active end of a symmetrical loop would effect an opening of the vertical parameter of the loop (Figure 14). This results in the generation of a mesial force along the x-axis. The magnitude of this force is less for the T-loop design in that the gingival-horizontal component of wire allows much greater flexibility in the vertical direction.

Gingival activation of symmetrical loop configurations results in the generation of distally directed x forces. This is again a result of the ends of the loop being rigidly attached to the measuring device, thus initiating a closing of the vertical component of the loop (Figure 15).

In the clinical situation, the ends of the loop may not be rigidly attached to the tooth, and may be relatively free to slide.

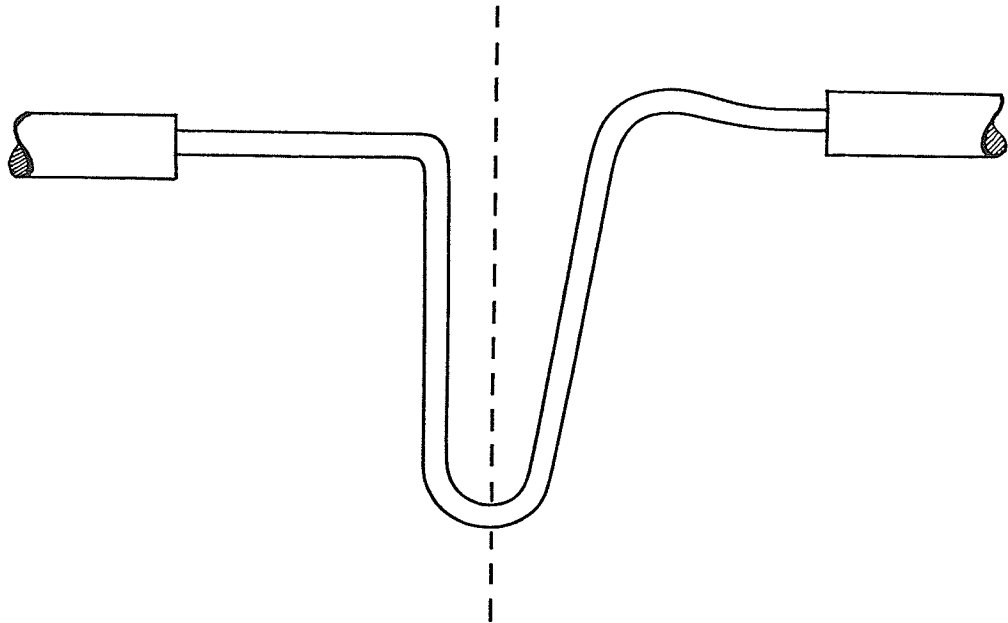

FIGURE 14; Vertical misalignment of a vertical loop in an occlusal direction.

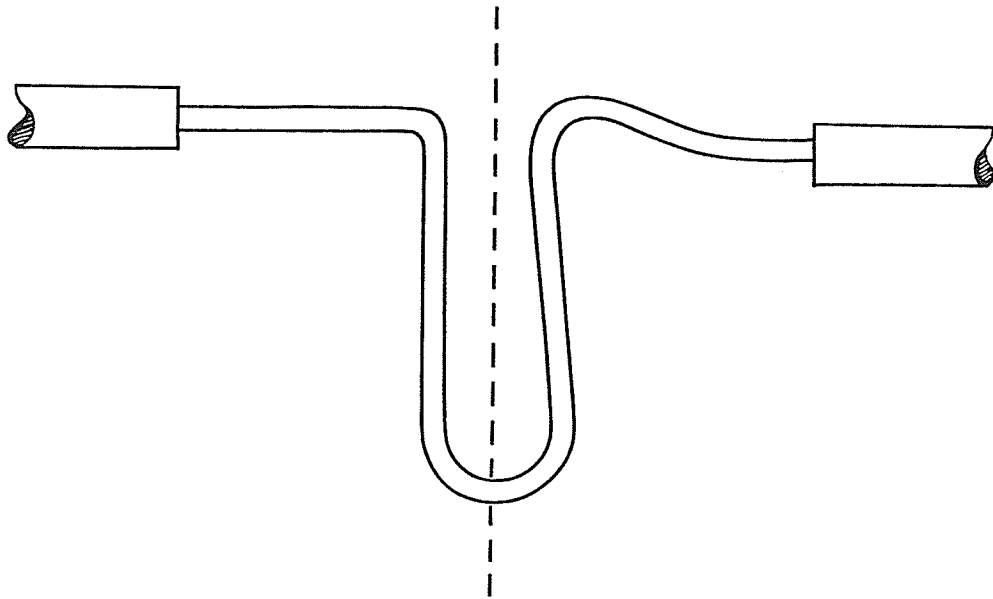

FIGURE 15; Vertical misalignment of a vertical loop in a gingival direction.

Forces developed along the x-axis for these symmetrical loops would then not be as significant. Therefore, the test conditions chosen in this investigation represent a "worst case" condition.

In the case of asymmetric loops, design and interbracket positioning have a significant effect on the magnitude and direction of any spurious forces developed along the x-axis.

Occlusal activation of both a symmetrical vertical loop, and a symmetrically positioned L-loop, generates a mesially directed F_x at the center of resistance of the active tooth. However, the symmetrically positioned L-loop has a F_x/F_y value approximately twice that of the vertical loop. This increase in F_x magnitude arises due to the asymmetric nature of the horizontal portion of the L-loop. Even though the loop itself is centered in the interbracket space, the bending that occurs in the "toe" portion is not centered (Figure 16). As a result a large moment is generated at the mounting tube. This moment has the effect of opening the vertical part of the loop, thus resulting in an increase in the mesially directed F_x .

The magnitude of F_x is further increased by moving the loop to a position one millimeter distal to the active tooth, the "toe" of the loop being directed mesial. The effect is to increase the value of F_x to approximately 30% that of the primary force (F_y). The magnitude of F_x is again a result of the combination of rigid attachments and the increased asymmetric positioning.

Reversing the direction of the "toe" of the L-loop, while still maintaining the L-loop position one millimeter distal to the active

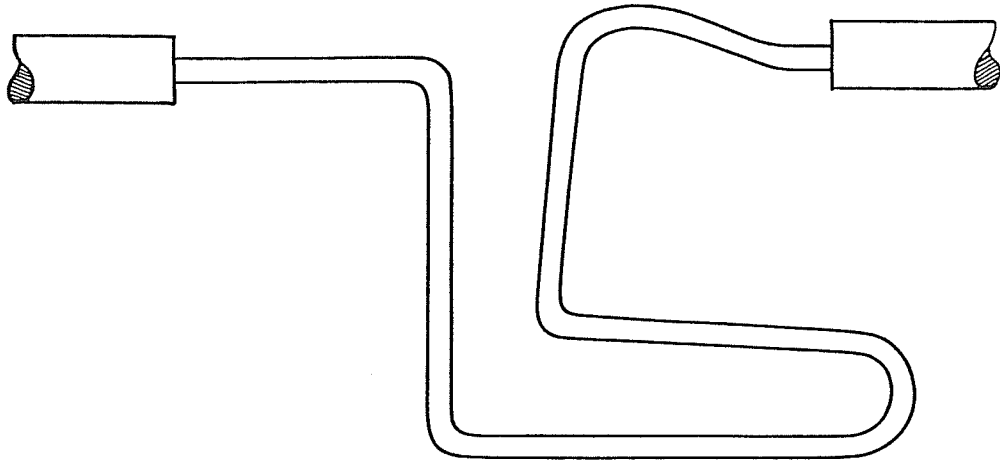

FIGURE 16; L-loop occlusally activated.

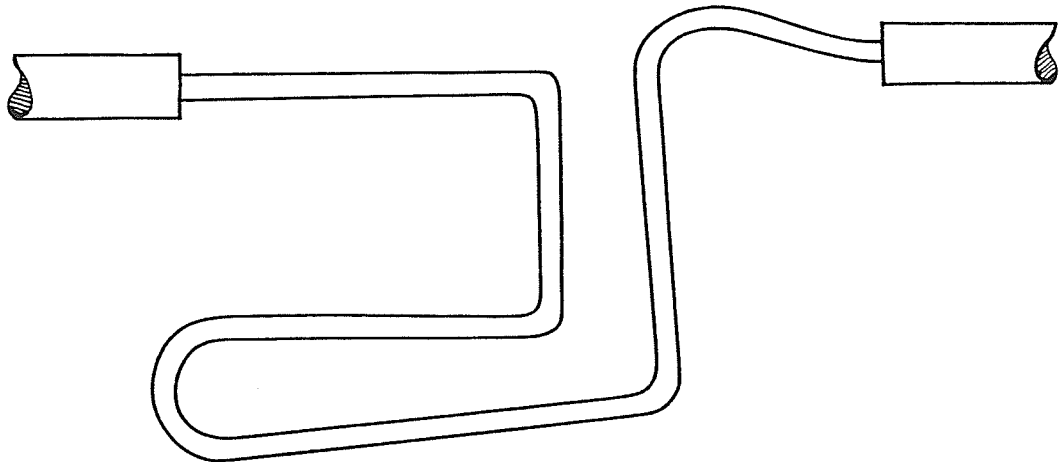

FIGURE 17: Reversed L-loop occlusally activated.

tooth, not only decreases the magnitude of F_x , but also reverses the direction of the force. The magnitude of F_x is reduced to approximately 10% that of F_y , and is now distally directed. As illustrated in Figure 17, an occlusal activation results in a closing of the vertical component of the loop, thus generating a positive (distal) x-force.

A gingival activation of the L-loop, while varying the inter-bracket positioning and configuration, generates spurious x-forces of opposite direction to those discussed in the previous three paragraphs.

Forces developed along the z-axis, for a vertical activation of the selected loops, are extremely small in magnitude. All F_z values are in fact very close to the defined ideal value of zero.

iii) Rotational effects around the x-axis

In the measuring device used in this investigation, the simulated tooth "bracket" was placed 4.2 mm. horizontally, and 12.0 mm. vertically, off the defined tooth center of resistance. A pure force, vertically directed through the "bracket", would then generate a moment about the x-axis, at the center of resistance, equal in magnitude to 4.2 mm. x F_y (gm.). Thus, a vertically activated loop, which offered no resistance to rotations about the x-axis, would have an M_x/F_y value of 4.2 gm. mm./gm. A loop which offered complete resistance to rotations would have a M_x/F_y value of zero.

All the non-helical vertical and T-loops had M_x/F_y values very

close to 2.50 gm. mm./gm. This implies that they all possess approximately the same stiffness to moments about the x-axis, and do offer some resistance to tipping of the tooth.

The vertically activated vertical loop, with a 1 1/2 turn helix at its apex, also had a Mx/Fy value of approximately 2.50 gm. mm./gm. However, for the loop configuration involving the addition of two helices to a 8 mm. vertical loop, the Mz/Fy value increased to approximately 3.30 gm. mm./mm. (Table VI). This configuration then offers little resistance to rotation around the x-axis.

When occlusally activated, the symmetrically positioned L-loop has a Mx/Fy value of 2.65 gm. mm./gm. at the center of resistance of the active tooth. At the reactive tooth this value is 2.67 gm. mm./gm. The moment about the x-axis (Mx) at the active tooth tips the crown of the tooth buccally, while the moment at the reactive tooth tips the crown lingually.

Altering the interbracket position, and direction of placement of the L-loop, changed the magnitude of the Mx/Fy values at the active and reactive teeth. This manipulation offers the versatility of more control over rotations around the x-axis at one of the attached teeth. Clinically, one would then direct the larger spurious moment to the dental unit which could mechanically most efficiently resist its effect.

iv) Rotational effects around the y-axis

A vertically directed force, at the center of resistance of a

tooth, would generate a moment about the y-axis of magnitude zero.

In none of the vertically activated loop configurations was the magnitude of M_y found to be zero. As previously discussed, the rigid attachment of the loops to the measuring device allowed for the generation of forces along the x-axis. These forces would be directed 4.2 mm. horizontally off the center of resistance of the tooth. The combination of this F_x , and a z-distance parameter, will result in a moment about the y-axis. The magnitude of this moment depended on the magnitude of F_x generated by the various loop configurations. Vertical loop configurations have a magnitude of M_y twice that of the T-loops. L-loop configurations, having increased F_x values, also have larger M_y magnitudes.

For symmetrical loops, the direction of the moment about the y-axis is related to the direction of the force along the x-axis. An occlusal activation of the loops generates a moment about the y-axis which will rotate the bracket of the active tooth mesially. This moment is distally directed for a gingival activation of the same loops.

For the asymmetric L-loop, the direction of M_y may be altered by appliance design and interbracket positioning.

At the reactive end of these vertically activated loops, the direction of M_y is opposite to that generated at the center of resistance of the active tooth.

Clinically, the lateral extensions of the loops may in most cases be free to slide horizontally through the "bracket". For the symme-

trical loop configuration, the magnitude of M_y may then be insignificant. This would not be true for the asymmetric loop where, depending on design and interbracket position, forces along the x-axis are developed due to M_z production.

v) Rotational effects around the z-axis

An occlusal activation of the active end of all the loop configurations results in the generation of a moment about the z-axis which tips the crown of the tooth distally. The direction of this moment is reversed for an equivalent gingival activation. Data presented by Vanderby et al. (1977) is in agreement with this finding.

The magnitude of the moment (M_z) varies with respect to the design of the loop. The M_z/F_y value for a 8 mm. vertical loop approximates 7.00 gm. mm./gm., and this value does not change appreciably as the vertical length of the loop is varied. However, as parameter D is increased, the magnitude of the M_z/F_y relationship also increases. An increase in the diameter of the half-helix, at the apex of a vertical loop, thus results in less control of tipping of the tooth about the z-axis.

Helical additions to the lateral extensions of a vertical loop also increase the M_z/F_y value, thereby resulting in decreased moment control about the z-axis.

The M_z/F_y value for an 8 mm. T-loop is much larger than that for a 8 mm. vertical loop. As the gingival-horizontal dimension in a T-loop is increased, the moment tipping the crown of the active tooth

to the distal decreases. However, none of the T-loops tested were as stiff about the z-axis as the vertical loop configurations.

The magnitude and direction of the moment about the z-axis is determined by the rotational stiffness of the loop configuration. This is illustrated in Figure 18. Position (1) depicts a centered, symmetrical, vertical loop prior to activation. An occlusal activation of the active end of the loop, with no restriction on rotation, would generate a configuration as in position (2). However, since the ends of the loop are rigidly constrained in the measuring device, and not free to rotate, moments are produced at the wire-mounting tube interface (position 3). For the symmetrically positioned vertical loop illustrated, these moments will have the same direction and magnitude at the center of resistance of both the active and reactive tooth. For a gingival activation of the same appliance, the direction of these moments about the z-axis will be opposite to those for the occlusal activation.

The L-loop configurations demonstrate the effect that loop design, and interbracket positioning, can have on the magnitude of M_z . Judicious selection of configuration allows for the generation of an M_z of smaller magnitude at one of the attachments, while increasing the magnitude of this moment at the other. This difference is further enhanced through asymmetric interbracket placement. Thus, clinically, an asymmetric loop offers the potential for greater control of the moment about the z-axis occurring at the center of resistance of one of the dental units.

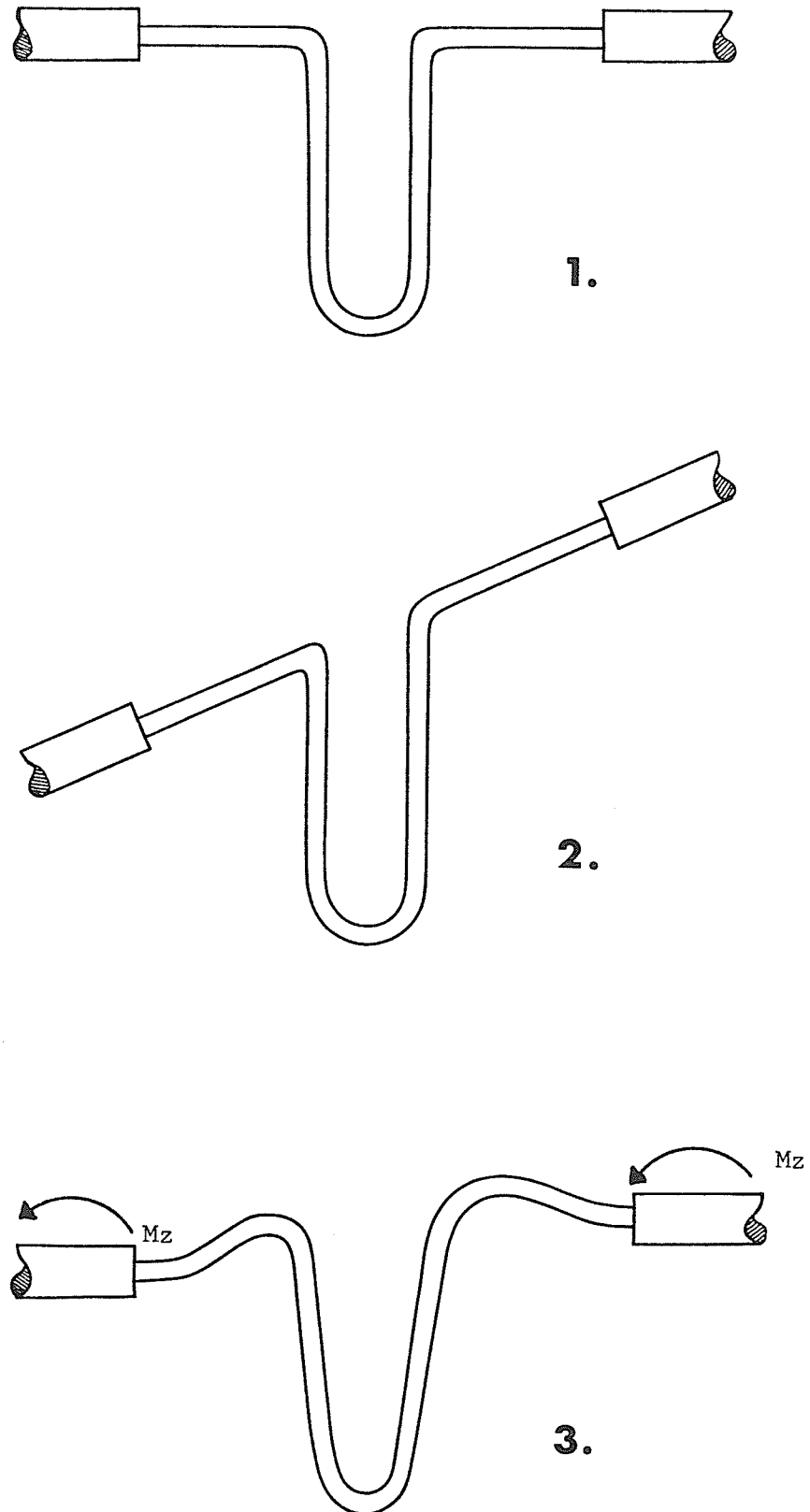

FIGURE 8: Illustration of moments about the z-axis.

vi) Summary

That any statistical variability, in force and moment production by the tested loops, does not influence the determination of the effectiveness of the selected design parameters is well demonstrated in Figure 19. It is recognized that the number of points defining each curve is small. Nevertheless, the consistent behaviour of these plots is in agreement with what one would expect from the underlying physical principles and the theory of elasticity.

The results of this investigation indicates that the selection of loop design is a most important factor in the determination of the force system which will be generated at the center of resistance of the involved teeth.

For vertical activations of alignment loops, the attainment of a low stiffness value may most efficiently be realized through configurational changes involving the addition of wire to the horizontal component in the xy plane. This is dramatically illustrated in Figure 19, which demonstrates the most rapid decrease in y force production with variation of parameter L. These horizontal additions also decrease the magnitude of any spurious forces. However, due to increased flexibility of the loop, control over the generation of tipping moments is decreased.

The addition of helices to a vertical loop is an inefficient means of decreasing the stiffness of the appliance in the vertical direction of activation. Improper positioning of these helices will

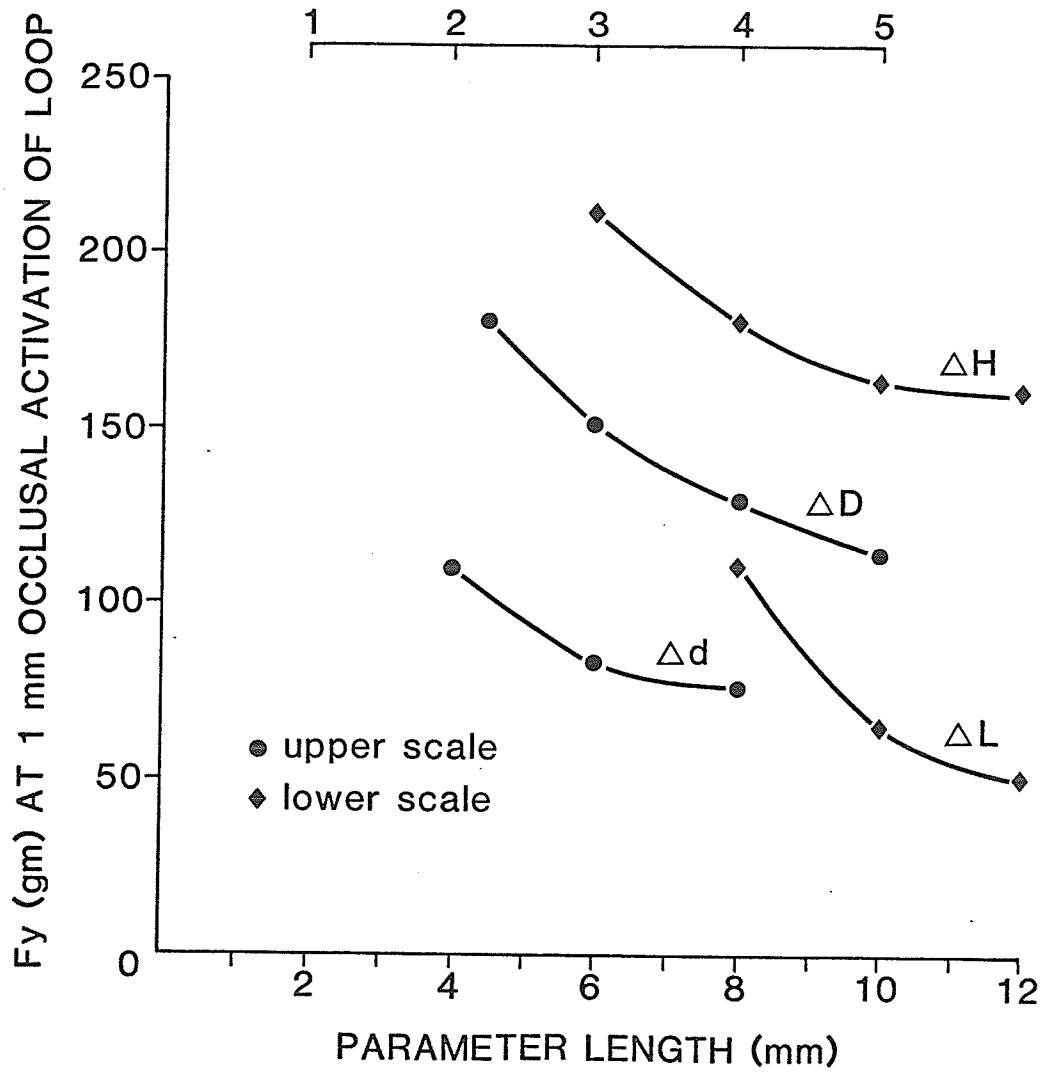

FIGURE 19: Graphic illustration of the effect of parameter variation on force generation along the y-axis

also result in less control over tipping moments.

Asymmetric loop configurations offer the versatility of directing differential moment magnitudes to desired dental units. However, when compared to symmetrically positioned symmetric loops, these loop configurations also have increased spurious force magnitudes.

Horizontal Activation

i) Stiffness value

Bucco-lingual activations of all loop configurations resulted in the generation of a force (F_z) along the defined z-axis. The direction of action of this force is opposite to the activation direction. The magnitude of F_z varies with respect to the design of the loop itself.

Configurational changes to a vertical loop, involving vertical additions of wire, lowered its stiffness value to bucco-lingual activations. From Table XII it can be seen that while a buccally activated 8 mm. vertical loop had a stiffness value of 38.57 gm./mm., an increase in the vertical component to 12 mm. lowered the stiffness value to 20.98 gm./mm. This relates as a 46% decrease in force (F_z) production, for equivalent one millimeter activations of the two appliance designs. The fact that the stiffness value is decreased, through additions of wire to the loop height, is consistent with experimental results presented by Waters (1981).

An increase in the diameter of the half-helix at the apex of a

vertical loop, or the addition of 1 1/2 turn helices to selected areas, does not appreciably alter the stiffness of the vertical loop to bucco-lingual activations.

A configurational change to a 8 mm. T-loop results in a significant lowering of the stiffness value, as compared to that for a 8 mm. vertical loop. However, the stiffness value is virtually unchanged as the gingival-horizontal parameter of the T-loop is increased from 8 mm. to 12 mm. (Table XVIII). Thus, beside the increase in the amount of wire in the loop configuration itself, additions of wire to the horizontal axis in the xy plane offer no benefit for the lowering of the stiffness of the loop to bucco-lingual activations. This is confirmed in results obtained from the alteration of the d-parameter of the T-loop. Vertical additions of wire here resulted in a more rapid decrease in the stiffness value, when compared to gingival-horizontal additions to the same loop. This is an expected result in that the gingival-horizontal component of the loop would be placed under torsion, while the vertical component would be subjected to bending. While torsional stiffness is inversely proportional to length, bending stiffness is inversely proportional to length cubed.

ii) Spurious forces

None of the alignment loops tested fulfilled the desired requirement of generating a force only along the z-axis, when activated bucco-lingually.

For all loops investigated, the magnitude of any spurious

x-directed force (F_x) is approximately 10% of the primary force (F_z). At the center of resistance of the model (active) tooth, buccal activation of the loop configurations generates a distally directed F_x . The direction of the force is reversed for a lingual activation.

As previously illustrated (Vertical activations), activation of a loop may result in the horizontal opening or closing of the vertical component of the loop configuration. Due to the rigid attachment of the ends of the loop to the measuring system, a moment is generated at the loop-mounting tube interface. For buccal activations, this moment tends to close the vertical component of the loop. This results in the generation of distally directed F_x at the center of resistance of the tooth. The direction of this force is opposite for a lingual activation.

The magnitude of the relationship F_x/F_z is similar for vertical and T-loop configurations. Contrary to the results for vertical activations, the gingival-horizontal component of the T-loop does not decrease the magnitude of F_x to horizontal activations.

The absolute magnitude of F_x is small in all cases. Clinically, where the loops are not rigidly attached to the "brackets", the value of F_x would be insignificant.

Spurious forces generated along the y-axis are also the product of the rigid attachment of the loop to the measuring system. Activation of the alignment loops results in the generation of a moment (M_x) at the loop-mounting tube interface. When the loop is activated in a buccal direction, this moment produces a gingivally directed y-force

(Fy) at the center of resistance of the active tooth. Fy is occlusally directed when the loop is lingually activated.

Data generated from bucco-lingual activation of asymmetric L-loop configurations indicates that a reversal in Fy direction may be obtained through variation in design and interbracket positioning.

Again, in situations where the lateral extensions of the loop are free to rotate, the clinical significance of any spurious Fy may be small.

iii) Rotational effects around the x-axis

In this investigation, a buccal or lingual force applied to the simulated bracket of the model (active) tooth is positioned 12 mm. vertically off the center of resistance. This force would then generate, at the center of resistance, a moment about the x-axis of magnitude 12 mm. \times Fz (gm.). A bucco-lingually activated loop, which offered no resistance to rotations about this axis, would then have a Mx/Fz value of 12.0 gm. mm./gm. The standard vertical loop, when activated along the horizontal \pm z-axis, offers no resistance to rotations about the z-axis. Vertical additions of wire to this loop have no effect on the Mx/Fz value, the magnitude of which remains constant at approximately 12.00 gm. mm./gm. (Table XII).

An increase in the D-parameter of the vertical loop results in increased control of the moment about the x-axis. A gingival-horizontal alteration of the loop configuration, to a T-loop design, also decreases the value of Mx/Fz. This trend continues as the gingival-

horizontal parameter is further increased in length.

For symmetrically positioned symmetric loop configurations, activated in a bucco-lingual direction, increases in parameters along the $+x$ axis result in more control of the moment about the x -axis. Vertical additions ($+y$) to the loop offer less control.

The asymmetric L-loop configuration offers further control over the magnitude of the moment about the x -axis. Due to the asymmetry of the loop, alterations of design and interbracket positioning allow for a decrease in magnitude of M_x at the center of resistance of one of the dental units. There is, however, an increase in M_x magnitude at the opposing dental unit. Clinically, the use of an asymmetric loop would allow the direction of the larger moment to the dental unit which could most efficiently dissipate it.

iv) Rotational effects around the y -axis

Bucco-lingual activation of the centered symmetric loop configurations results in the generation of a moment about the y -axis (M_y). This moment is the result of the ends of the loop not being free to rotate, but constrained in the horizontal plane by the measuring device.

The magnitude of the M_y/F_z relationship is very similar for all symmetric loop configurations tested. For bucco-lingual activations, loop design has no significant effect on the stiffness of these loops around the y -axis.

For a buccal activation of the active end of the loops, the

direction of M_y is such as to rotate the buccal aspect of the tooth distally. The direction of M_y is reversed for a lingual activation.

Due to the asymmetry of the horizontal parameter of an L-loop, the magnitude of M_y at the active tooth differs from that at the reactive tooth. This difference may be further accentuated through asymmetric interbracket positioning.

v) Rotational effects around the z-axis

A force directed along the z-axis would ideally generate a moment about the z-axis of magnitude zero. The absolute magnitude of M_z was non-zero for all loop configurations investigated. The M_z/F_z value was, however, very small in all cases.

The moment about the z-axis also varied in direction. This suggests that this moment is the product of random effects, rather than primary properties of the loop itself.

vi) Summary

Loop design is a critical component in the control of the force system generated for first order tooth movements. Data presented above indicates that a decrease in force magnitude, along the bucco-lingual axis, is most efficiently attained through vertical configurational changes in the xy plane (Figure 20). This alteration in stiffness value is not as dramatic as that determined when the same configurational changes were tested through vertical activation. Per-

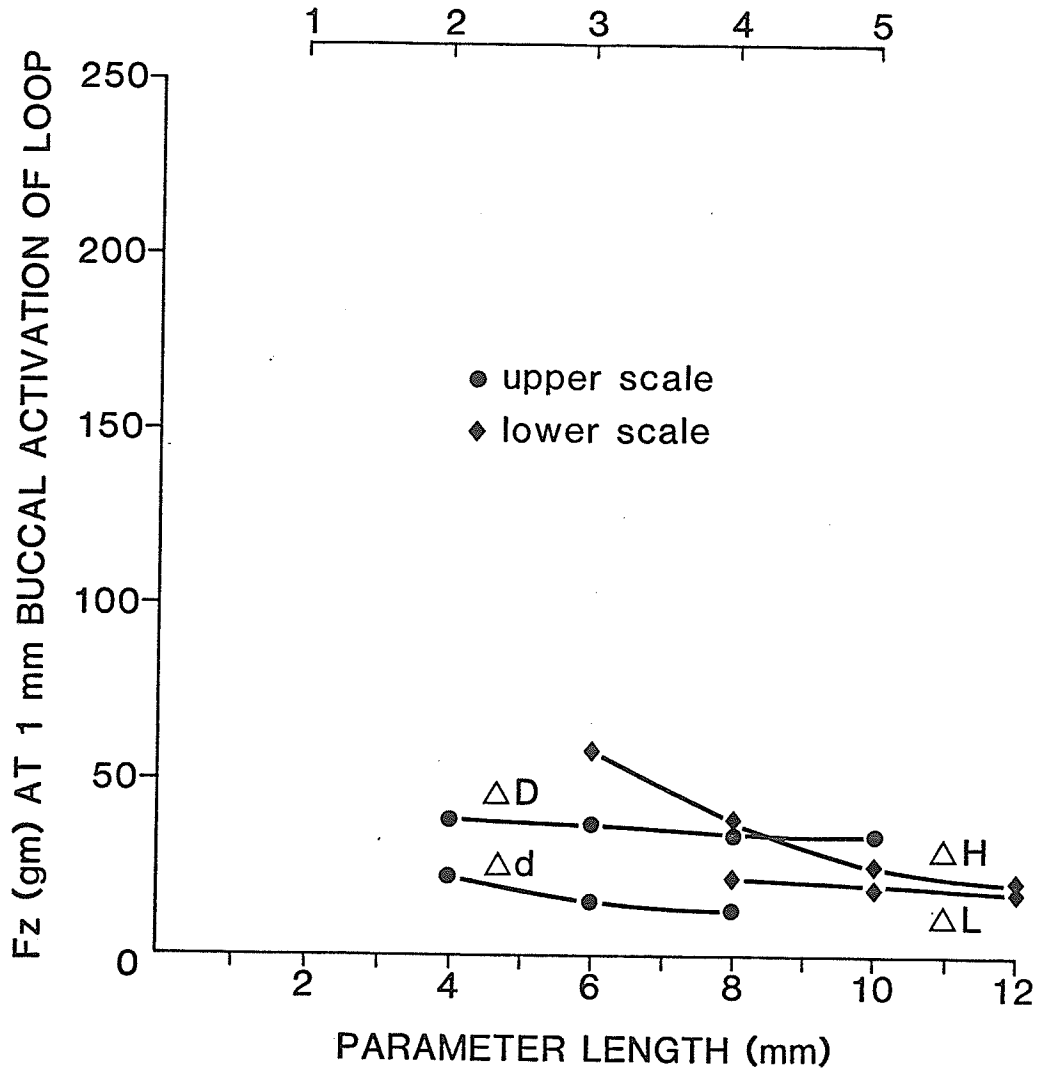

FIGURE 20: Graphic illustration of the effect of parameter variation on force generation along the z-axis

haps design changes along the $\pm z$ -axis of the yz plane should have been included in the configurational alteration of the selected alignment loops. Additions of wire in this plane may alter the stiffness value more efficiently.

The magnitude of spurious forces generated is unaffected by any of the design changes investigated. However, design and interbracket positioning of the L-loop offer the potential for reversing the direction of the spurious force along the y -axis.

Whereas vertical additions to the loop configurations more efficiently reduced the stiffness value, horizontal additions have the effect of offering more control over rotations around the x -axis. This control is further accentuated, at the center of resistance of one of the tooth supports, through the use of an asymmetric loop.

Dependent on design and interbracket positioning, the L-loop also offers the potential for a decrease in magnitude of rotation around the y -axis at one of the supports. Thus, of the alignment loops investigated, the L-loop configuration is the one of choice if differential moment magnitudes at the two supports are clinically advantageous.

Conclusion

Clinical observation of the effects of appliance design on tooth movement may lead only to a working hypothesis. In order to formulate a theory, simultaneous measurement of all input and output parameters must be analyzed. The use of a three-dimensional measuring system has in fact allowed this investigation to qualify and quantify the effects of certain design parameters on force system generation. Empirical relationships may now be developed that relate force production to parameter length variation. With this knowledge, the clinician will more accurately be able to predict the force systems produced by these loops, and avoid, or make allowance for, any undesirable side effects which might not have been directly apparent from strictly clinical observation.

Analysis of the data obtained through vertical and bucco-lingual activations of the selected alignment loops, results in the following conclusions.

- (1) Horizontal additions of wire are most effective in altering the stiffness value of a loop to occluso-gingival activations.
- (2) Vertical additions of wire are most effective in altering the stiffness value of a loop to bucco-lingual activations.
- (3) Helical additions to a loop are of little value in force control and may result in an increase in spurious moment magnitudes.
- (4) All loop configurations investigated generated spurious

forces upon activation. The magnitude and direction of these forces is dependent upon the design of the loop itself.

(5) The rotational stiffness of the loop configuration is an important factor in determining the direction and magnitude of developed moments.

(6) The L-loop configuration offers the versatility of differential moment magnitude at its supports.

References

- Ackerman, J.L., Sager, C.R., DelPriore, R.C., and Bramante, M.A.: A controlled light continuous force technique, *Am. J. Orthod.* 56: 233-251, 1969.
- Angle, E.H.: Evolution of orthodontia - recent developments, *Dental Cosmos* 54: 853-867, 1912.
- Angle, E.H.: Some new forms of orthodontic mechanism, and the reasons for their introduction, *Dental Cosmos* 58: 969-994, 1916.
- Angle, E.H.: The latest and best in orthodontic mechanism, *Dental Cosmos* 70: 1143-1158, 1928.
- Begg, P.R.: Differential force in orthodontic treatment, *Am. J. Orthod.* 42: 481-510, 1956.
- Begg, P.R. and Kesling, P.C. Begg Orthodontic Theory and Technique, Third Edition, Philadelphia: W.B. Saunders Co., 1977.
- Brown, I.D.: The flexibility of "box-loop", "cross-loop" and "vertical loop" systems in the vertical plane, *Br. J. Orthod.* 4: 79-83, 1977a.
- Brown, I.D.: Loop systems: a method of analyzing their flexibility in extrusion and intrusion, *Br. J. Orthod.* 4: 169-174, 1977b.
- Burstone, C.J., Baldwin, J.J., and Lawless, D.T.: The application of continuous forces to orthodontics, *Angle Orthod.* 31: 1-14, 1961.
- Burstone, C.J. and Koenig, H.A.: Optimizing anterior and canine retraction, *Am. J. Orthod.* 70: 1-19, 1976.
- Chaconas, S.J., Caputo, A.A., and Hayashi, R.K.: Effects of wire size, loop configuration, and gabling on canine-retraction springs, *Am. J. Orthod.* 65: 58-66, 1974.

- DeFranco, J.C., Koenig, H.A., and Burstone, C.J.: Three-dimensional large displacement analysis of orthodontic appliances, *J. Biomech.* 9: 793-801, 1976.
- Gianelly, A.A. and Goldman, H.M.: Biologic Basis of Orthodontics. Philadelphia, Lea and Febiger, 1971.
- Grief, R., Coltmann, M., and Shapiro, E.: Computer analysis of orthodontic force system, *J. Dent. Res. (I.A.D.R.)* 57: 361, (ABS.), 1978.
- Halderson, H., Johns, E.E., and Moyers, R.: The selection of forces for tooth movement, *Am. J. Orthod.* 39: 25-35, 1953.
- Hixon, E.H., Atikian, H., Callow, G.E., McDonald, H.W., and Tacy, R.J.: Optimal force, differential force, and anchorage, *Am. J. Orthod.* 55: 437-357, 1969.
- Hixon, E.H., Aasen, T.O., Arango, J., Clark, R.A., Klosterman, R., Miller, S.S., and Odom, W.M.: On force and tooth movement, *Am. J. Orthod.* 57: 476-488, 1970.
- Jarabak, J.R. and Fizzell, J.A. Technique and Treatment with the Light Wire Appliance. Second Edition, St. Louis, C.V. Mosby, 1972.
- Koenig, H.A. and Burstone, C.J.: Analysis of generalized curved beams for orthodontic applications, *J. Biomech.* 7: 429-435, 1974.
- Lack, M.L.: An investigation into the three-dimensional force and moment characteristics of selected retraction mechanisms. M.Sc. Thesis. University of Manitoba, 1980.
- Lowe Young, J.: A detachable anchorage connection for orthodontic appliances, *Dental Cosmos* 58: 612-617, 1916.
- Mahler, D.B. and Goodwin, L.: An evaluation of small diameter orthodontic wires, *Angle Orthod.* 37: 13-17, 1967.

- Matteson, A.E.: A regulating device, Dental Cosmos 30: 68-70, 1888.
- McLachlan, K.R.: Personal communication with the author, 1979.
- McLachlan, K.R.: Personal communication with the author, 1981.
- Newman, G.V.: A biomechanical analysis of the Begg light arch wire technique, Am. J. Orthod. 49: 721-740, 1963.
- Paquien, J.P.: The measurement of forces and moments delivered by dental appliances. M. Sc. Thesis. University of Manitoba 1978.
- Ricketts, R.M., Bench, R.W., Gugino, C.F., Hilgers, J.J., and Schulhog, R.J. Bioprogressive Therapy, Rocky Mountain/Orthodontics, 1979.
- Sims, M.R.: Loop systems - A contemporary reassessment, Am. J. Orthod. 61: 270-278, 1972.
- Solonche, D.J., Vanderby, R., Ratches, J., and Lai, C.: A device for determining force-moment characteristics for orthodontic appliances, J. Dent. Res. (I.A.D.R.) 55, 199 (ABS.), 1976.
- Solonche, D.J., Burstone, C.J. and Vanderby, R. Jr.: A device for determining the mechanical behaviour of orthodontic appliances, I.E.E.E. Transactions on Biomedical Engineering, 24(6): 538-539, 1977.
- Steiner, C.C.: Force control in orthodontia, Angle Orthod. 2: 252-259, 1932.
- Stoner, M.M.: Force control in clinical practice, Am. J. Orthod. 46: 163-186, 1960.
- Stoner, M. M.: Wire: Clinical considerations. In Current Orthodontic Concepts and Techniques, Second Edition. Graber, T.M. and Swain, B.F. (eds.), Philadelphia, W.B. Saunders Co., 1975.
- Storey, E. and Smith, B.: Forces in orthodontics and its relation to

- tooth movement, Austral. J. Dent. 56: 11-18, 1952.
- Strang, R.H.W. A Text-Book of Orthodontia, Philadelphia, Lea and Febiger, 1933.
- Thurrow, R.C. Edgewise Orthodontics, Fourth Edition, St. Louis, C.V. Mosby Co., 1982.
- Tweed, C.H.: The application of the principles of the edgewise arch in the treatment of malocclusions: II, Angle Orthod. 11: 12-67, 1941.
- Vanderby, R. Jr., Burstone, C.J., Solonche, D.J., and Ratches, J.A.: Experimentally determined force systems from vertically activated orthodontic loops, Angle Orthod. 47: 272-279, 1977.
- Waters, N.E.: The mechanics of finger and retraction springs of removable orthodontic appliances, Archs. Oral. Biol. 15: 349-363, 1970.
- Waters, N.E.: The mechanics of plain and looped arches. Part 1, Br. J. Orthod. 3: 75-78, 1976a.
- Waters, N.E.: The mechanics of plain and looped arches. Part 2, Br. J. Orthod. 3: 161-167, 1976b.
- Waters, N.E., Stephens, C.D., and Houston, W.J.B.: Physical Characteristics of orthodontic wires and archwires. Part 1, Br. J. Orthod. 2: 15-24, 1975a.
- Waters, N.E., Stephens, C.D. and Houston, W.J.B.: Physical characteristics of orthodontic wires and archwires. Part 2, Br. J. Orthod. 2: 73-83, 1975b.
- Waters, N.E., Houston, W.J.B., and Stephens, C.D.: The characterization of arch wires for the initial alignment of irregular teeth, Am. J. Orthod. 79: 373-389, 1981.
- Yang, T.Y. and Baldwin, J.J.: Analysis of space closing springs in

orthodontics. J. Biomech. 7: 21-28, 1974.

Additional Bibliography

- Angle, E.H.: The latest and best in orthodontic mechanism. Dental Cosmos 71: 260-270. 1929.
- Begg, P.R.: Light arch wire technique employing the principle of differential force, Am. J. Orthod. 47: 30-48, 1961.
- Begg, P.R. and Kesling, P.C.: The differential force method of orthodontic treatment, Am. J. Orthod. 71: 1-39, 1977.
- Bell, W.R.: A study of applied force as related to the use of elastics and coil springs, Angle Orthod. 21: 151-154, 1951.
- Bien, S.M.: Analysis of components of forces used to effect distal movement of teeth, Am. J. Orthod. 37: 508-521, 1951.
- Blodgett, G.B. and Andreasen, G.I.: Comparison of two methods of applying lingual root torque to maxillary incisors, Angle Orthod. 38: 216-224, 1968.
- Brantley, W.A. and Meyers, C.L.: Measurement of bending deformation for small diameter orthodontic wires, J. Dent. Res. 58: (7): 1696-1700, 1979.
- Brodie, A.G.: The new Angle mechanism, J. Am. Dent. Assoc. 16: 2085-2108, 1929.
- Bull, H.L.: Obtaining facial balance in treatment of Class II Division I. Angle Orthod. 21: 139-148, 1951.
- Burstone, C.J.: Rationale of the segmented arch, Am. J. Orthod. 48: 805-822, 1962.
- Burstone, C.J.: The mechanics of the segmented arch technique, Angle Orthod. 36: 99-120, 1966.
- Burstone, C.J., Koenig, H.A., and Solonche, D.J.: Force systems from

- two-tooth bracket segments, J. Dent. Res. (I.A.D.R.) 52: 77: (ABS.), 1973.
- Burstone, C.J. and Koenig, H.A.: Force systems from an ideal arch, Am. J. Orthod. 65: 270-289, 1974.
- Burstone, C.J.: Deep overbite correction by intrusion, Am. J. Orthod. 72: 1-22, 1977.
- Creekmore, T.D.: The importance of interbracket width in orthodontic tooth movement, J. Clin. Orthod. 10: 530-534, 1976.
- Drenker, E.W.: Forces and torques associated with second order bends, Am. J. Orthod. 42: 766-773, 1956.
- Fortin, J.M.: Translation of premolars in the dog by controlling the moment to force ratio on the crown, Am. J. Orthod. 59: 541-551, 1971.
- Hellman, M.: Mechanics in orthodontia, from a modern aspect, Dental Cosmos 62: 1385-1408, 1920.
- Hotz, B.: Force determination and control in orthodontics, J. of Dent. Assoc. South Africa 19: 370-373, 1964.
- Jacobson, A.: Biomechanics of orthodontic forces, J. of Dent. Assoc. South Africa 21: 211-218, 1966.
- Jacobson, A.: Orthodontics - mechanical or biologic objectives, Am. J. Orthod. 64: 1, 1973.
- Johns, E.E.: A study of the forces inherent in orthodontic appliances and the selection of forces for tooth movement, J. Can. Dent. Assoc. 19: 423-436, 1953.
- Khouw, F.E. and Norton, L.A.: The mechanism of fixed molar uprighting appliances, J. Prosthet. Dent. 27: 381-389, 1972.

- Lane, D.F. and Nikolai, R.J.: Effects of stress relief on the mechanical properties of orthodontic wire loops, *Angle Orthod.* 50: 139-145, 1980.
- Lebsack, D.M., Weimer, A.D., and Hanna, M.: A study of force decay in uprighting springs used in the Begg technique, *Australian Orthod. J.* 6: 95-101, 1980.
- Lowe Young, J.: The rational treatment of infra-occlusion, *Dental Cosmos* 55: 869-879, 1913.
- Neuger, R.L.: The measurement and analysis of moments applied by a light-wire torquing auxiliary and how these moments change magnitude with respect to various changes in configuration and application, *Am. J. Orthod.* 53: 492-513, 1967.
- Nikolai, R.J.: On optimum orthodontic force theory as applied to canine retraction, *Am. J. Orthod.* 68: 290-302, 1975.
- Nikolai, R.J. and Crouthers, R.C.: On the relaxation and recovery of orthodontic traction elements under interrupted loading. *J. Dent. Res.* 59(6): 1071, 1980.
- Paulich, F.: Measuring of orthodontic forces, *Am. J. Orthod. and Oral Surg.* 25: 817-849, 1939.
- Pryputniewicz, R.J., and Burstone, C.J.: The effect of time and force magnitude on orthodontic tooth movement, *J. Dent. Res.* 58: 1754-1764, 1979.
- Ramos, D.F., Weimer, A.D., and Hanna, M.: A study of the forces produced by various preformed uprighting springs, 76: 637-645, 1979.
- Richmond, J.E.: An appliance analysis with measured pressure, *Int. J. Orthod. and Dent. for Children*, 19: 898-903, 1933.
- Ringenberg, Q.M.: The philosophy and technique of the edgewise appliance, *Am. J. Orthod.* 56: 24-37, 1969.

- Romeo, D.A. and Burstone, C.J.: Tip-back mechanics, Am. J. Orthod. 72: 414-421, 1977.
- Schwartz, H.: The case against biomechanics, Angle Orthod. 37: 52-57, 1967.
- Sims, M.R.: The Begg philosophy and fundamental principles, Am. J. Orthod. 50: 15-24, 1964.
- Sleichter, C.G.: A clinical assessment of light and heavy forces in the closure of extraction spaces, Angle Orthod. 41: 66-75, 1971.
- Steiner, C.C.: Is there one best orthodontic appliance?, Angle Orthod. 3: 277-298, 1933.
- Steiner, C.C.: Power storage and delivery in orthodontic appliances, Am. J. Orthod. 39: 859-880, 1953.
- Stephens, C.D.: The orthodontic center of rotation of the maxillary central incisor, Am. J. Orthod. 76: (2): 209-217, 1979.
- Storey, E.: The nature of tooth movement. Am. J. Orthod. 63: 292-314, 1973.
- Weinstein, S.: Minimal forces in tooth movement. Am. J. Orthod. 53: 881-903, 1967.
- Weinstein, S. and Haack, D.C.: Theoretical mechanics and practical orthodontics. Angle Orthod. 29: 177-181, 1959.
- White, T.R., Caputo, A.A. and Chaconas, S.J.: The measurement of utility archwire forces. Angle Orthod. 49: 272-281, 1979.
- Williams, B.R., Caputo, A.A., and Charconas, S.J.: Orthodontic effects of loop design and heat treatment. Angle Orthod. 48: 235-239, 1978.