An Evaluation of Computational Fluid Dynamics for Spillway Modeling

by

Paul Guy Chanel

A thesis submitted to the Faculty of Graduate Studies in
partial fulfillment of the requirements for the degree of

Master of Science

Department of Civil Engineering
University of Manitoba
Winnipeg, Manitoba, Canada

Copyright © 2008 by Paul Guy Chanel

Abstract

As a part of the design process for hydro-electric generating stations, hydraulic engineers typically conduct some form of model testing. The desired outcome from the testing can vary considerably depending on the specific situation, but often characteristics such as velocity patterns, discharge rating curves, water surface profiles, and pressures at various locations are measured. Due to recent advances in computational power and numerical techniques, it is now possible to obtain much of this information through numerical modeling.

Computational fluid dynamics (CFD) is a type of numerical modeling that is used to solve problems involving fluid flow. Since CFD can provide a faster and more economical solution than physical modeling, hydraulic engineers are interested in verifying the capability of CFD software. Although some literature shows successful comparisons between CFD and physical modeling, a more comprehensive study would provide the required confidence to use numerical modeling for design purposes. This study has examined the ability of the commercial CFD software Flow-3D to model a variety of spillway configurations by making data comparisons to both new and old physical model experimental data. In general, the two types of modeling have been in agreement with the provision that discharge comparisons appear to be dependent on a spillway's height to design head ratio (P/H_d). Simulation times and required mesh resolution were also examined as part of this study.

Acknowledgements

I am grateful for the support and assistance of many organizations and people, which have allowed me to complete this thesis.

I would like to acknowledge the generous funding for this research provided by Manitoba Hydro and the Natural Sciences and Engineering Research Council of Canada, without which this research would not have been possible.

I am also very thankful to my thesis advisor Dr. Jay Doering, whose guidance and direction were essential to the completion of this project.

I would like to acknowledge the contribution and support from the Manitoba Hydro line advocates for this project, Kevin Sydor and Devon Danielson.

Other thanks to my friends and colleagues at the University of Manitoba, who have facilitated my transition to graduate studies and have helped make this experience pleasant.

Finally, I would like to thank my family and in particular my wife Jody for supporting and encouraging me throughout my post-secondary education.

Table of Contents

Abstract	i
Acknowledgements	ii
Table of Contents	iii
List of Figures	v
List of Tables	viii
Nomenclature	ix
<i>CHAPTER 1 Introduction</i>	<i>1</i>
1.1 Background	1
1.2 Literature Review	3
1.3 Research Objectives	9
<i>CHAPTER 2 The Numerical Model</i>	<i>11</i>
2.1 Introduction to Flow-3D	11
2.2 Numerical Model Set-Up	12
2.2.1 Physics	12
2.2.2 Geometry.....	13
2.2.3 Meshing.....	14
2.2.4 Boundary and Initial Conditions	15
2.2.5 Numerical Simulations Options	17
<i>CHAPTER 3 Numerical to Physical Model Comparisons</i>	<i>21</i>
3.1 Introduction	21
3.2 Wuskwatim Generating Station	22
3.2.1 Numerical Model Set-up.....	23
3.2.2 Free Overflow Simulations	24
3.2.3 Gated Numerical Modeling.....	26
3.3 Limestone Generating Station	28
3.3.1 Numerical Model Set-Up.....	29
3.3.2 Free Overflow Simulations	30
3.3.3 Gated Numerical Modeling.....	31
3.4 Conawapa Generating Station	32
3.4.1 Numerical Model Set-up.....	32
3.4.2 Free Overflow Simulations	33
3.4.3 Gated Numerical Modeling.....	35
3.5 Combined Results	36

3.6	Average Percent Difference Trend.....	36
<i>CHAPTER 4 Physical Modeling for Additional Flow-3D Comparisons.....</i>		<i>49</i>
4.1	Introduction.....	49
4.2	Physical Model Testing.....	50
4.2.1	Physical Model Installation.....	50
4.2.2	Discharge Measurements.....	51
4.2.3	Combined Pump Capacity Reduction.....	52
4.2.4	Water Surface Profile Measuring Device.....	53
4.3	Physical and Numerical Modeling.....	54
4.3.1	Free Overflow Tests.....	54
4.3.2	Gated Discharge Modeling.....	57
<i>CHAPTER 5 Simulation Times.....</i>		<i>68</i>
5.1	Introduction.....	68
5.2	Effects of Numeric Options.....	69
5.3	Effect of Mesh Size and Configuration.....	70
<i>CHAPTER 6 Summary and Conclusions.....</i>		<i>73</i>
6.1	Summary.....	73
6.2	Conclusions.....	77
6.3	Future Recommendations.....	78
<i>References</i>	<i>.....</i>	<i>80</i>

List of Figures

Figure 2.1	<i>Flow-3D nested mesh used in gated simulations</i>	19
Figure 2.2	<i>Flow-3D fluid initialization for the Limestone spillway</i>	20
Figure 3.2	<i>Auto-Cad drawing of preliminary Wuskwatim spillway without piers or upstream flow details.</i>	39
Figure 3.3	<i>Wuskwatim physical model upstream geometry details used in final Flow-3d model set-up (Lemke, 1989).</i>	39
Figure 3.4	<i>Wuskwatim physical model to Flow-3D discharge comparison.</i>	40
Figure 3.5	<i>Wuskwatim physical model to Flow-3D water surface profile comparison.</i>	40
Figure 3.6	<i>Wuskwatim physical model to Flow-3D rollway pressure comparison.</i>	41
Figure 3.7	<i>Wuskwatim physical model to Flow-3D gated discharge comparisons.</i>	41
Figure 3.8	<i>Limestone physical model to Flow-3D discharge comparison</i>	42
Figure 3.9	<i>Limestone Flow-3D model flowing at design head</i>	42
Figure 3.10	<i>Limestone physical model to Flow-3D water surface profile comparison.</i> ..	43
Figure 3.11	<i>Limestone physical model to Flow-3D rollway pressure comparison</i>	43
Figure 3.12	<i>Limestone physical model to Flow-3D gated discharge comparison</i>	44
Figure 3.13	<i>Conawapa 1992 physical model bay shape difference (Northwest Hydraulic Consultants Ltd., 1992).</i>	44
Figure 3.14	<i>Conawapa physical model to Flow-3D discharge comparison.</i>	45
Figure 3.15	<i>Conawapa physical model to Flow-3D water surface profile comparison.</i> .	45
Figure 3.16	<i>Conawapa physical model to Flow-3D gated discharge comparison.</i>	46

Figure 3.17 *Physical model to Flow-3D discharge comparisons*46

Figure 3.18 *Physical model to Flow-3D water surface profile comparisons.*47

Figure 3.19 *Physical model to Flow-3D roadway surface pressure comparisons.*47

Figure 3.20 *Physical model to Flow-3D gate discharge comparisons.*48

Figure 3.21 *Average percent difference in Flow-3D discharge trend with P/H_d as compared to physical model data.*48

Figure 4.1 *Auto-Cad drawing developed to visualize set-up and order material for installation of the Conawapa-like physical model.*.....60

Figure 4.2 *Installed Conawapa physical model running with design head.*61

Figure 4.3 *Side view of physical model showing water surface measuring device with water flowing at design head.*62

Figure 4.4 *Verification of water surface profile measuring device by comparing the measured spillway surface with design equations.*63

Figure 4.5 *Comparison of newly measured physical model discharge rating curve for the Conawapa spillway to data obtained with Flow-3D and the rating curve from the original study completed with the identical spillway model (Ye, 2004).*63

Figure 4.6 *Comparison showing newly measured physical model discharge rating curve for the Conawapa spillway reduced by 2.5 percent to the rating curve from the original study completed with the identical spillway model (Ye, 2004).*64

Figure 4.7 *Comparison of measured physical model water surface profiles for the Conawapa spillway to data obtained with the flawed Flow-3D geometry.*...64

Figure 4.8 Comparison of measured physical model water surface profiles for the Conawapa spillway to data obtained with Flow-3D for 3 different headwater levels.....65

Figure 4.9 Conawapa numerical model set-up replicating the physical model test with an 8 m gate opening66

Figure 4.10 Comparison of the physical model water surface profile shown by the points to the Flow-3D profile shown by the line for a 4 m gate opening.67

Figure 5.1 A plot of the number of active cells against the amount of real minutes required to simulate one second using data from all Flow-3D spillway modeling conducted72

List of Tables

Table 3.1	Comparison of Wuskwatim physical model flow to varied detail Flow-3D. .	24
Table 3.2	Comparison of Wuskwatim physical model to Flow-3D discharge.	25
Table 3.3	Comparison of Wuskwatim physical model gated flow to single mesh CFD.	27
Table 3.4	Comparison of Wuskwatim physical model gated flow to nested mesh CFD.	28
Table 3.5	Comparison of Limestone physical model to Flow-3D discharge.....	30
Table 3.6	Comparison of Conawapa physical model to Flow-3D discharge.....	34
Table 4.1	Comparison of measured Conawapa physical model discharge to Flow-3D.	56
Table 4.2	Gated Conawapa physical model test to Flow-3D discharge comparison.....	58

Nomenclature

Symbol	Units	Description
CFD		Computational Fluid Dynamics
H	m	Head
HWL	m	Headwater Level
hp		horsepower
H _d	m	Design Headwater Level
MW		Megawatts
P	m	Spillway Height
PM		Physical Model
Q	m ³ /s	Discharge

1.1 Background

Over the past 30 years numerical modeling techniques have been rapidly developing as computational power has enhanced to the point where numerical solutions are now possible for many applications. This development has led to the widespread use of numerical modeling as a standard design tool in many engineering disciplines.

Despite the wide range of numerical modeling applications, the fundamental principles upon which all numerical models are based is similar for all models. Problems begin with a set of partial differential equations that describe the underlying physics of the particular situation. Some type of numerical method, such as finite element analysis or the finite volume method is then used to formulate a set of algebraic equations that represent the partial differential equations. An approximate solution to those algebraic equations is then obtained through some form of either an iterative or matrix solution. This solution is

often very computationally intensive, which makes the use of modern computational power so important to the use of numerical models. In most cases, the numerical model solutions are verified or calibrated through comparisons to field observations or physical model experiments before being applied in practice. Even after extensive model verification, sound engineering judgment is required to ensure the accuracy of any model output.

Computational Fluid Dynamics (CFD) is a branch of numerical modeling that has been developed for solving problems involving fluid flow. This includes applications involving fluid-solid interaction, such as the flow of water in a river or over and around hydraulics structures. There is therefore considerable interest on the part of hydraulic engineers into the applicability of CFD to model fluid flow at hydro-electric generating stations. Although CFD can take a significant amount of computation time, it can provide 3-dimensional flow fields around curved objects as well as other flow detail not available in more simplified 1 or 2 dimensional models. Despite the fact that CFD is being utilized for modeling flow in all areas of a generating station, this study will focus on the use of CFD to model the flow of water through spillways.

Historically, the flow of water over a spillway has been investigated by means of physical model experiments on scaled down versions of spillways. In these studies, scaling laws were used to convert model flow information into full scale prototype values. Although this method of evaluating spillway performance has been successful in the past, CFD presents several advantages over physical modeling. To begin, physical modeling is

expensive to undertake, making it difficult to explore a variety of options. Construction of the models, renting of appropriate facilities, and hiring skilled researchers to conduct experiments can all be quite costly. Although obtaining a license for one of the more advanced CFD software packages may be expensive, one skilled engineer can operate the program and many different options can be easily explored. CFD also allows the users to obtain flow information at any point in the flow domain rather than just at select locations where instruments are installed, as in physical modeling. The benefits of using CFD have created interest in the software and a desire on the part of hydraulics engineers to verify the full capability of numerical models.

Although engineers at Manitoba Hydro have been using CFD for over a decade, there has yet to be a comprehensive review that evaluates the ability of the software to accurately model all aspects of fluid flow over spillways. This study was, therefore, proposed to assess the capability of CFD to model ogee crested spillways.

1.2 Literature Review

The majority of available literature on applying CFD to spillway modeling came from studies using Flow-3D. Results from studies employing Flow-3D for modeling of various spillway hydraulics report good agreement with data from physical model studies as well as U.S. Army Corps of Engineers (USACE) and U.S. Bureau of Reclamation (USBR) standard design guidelines. Studies making use of various other types of software packages to model spillway hydraulics were also discovered. These include reports on the

successful use of CFX (Bouhadji, 2004), Fluent (Sartaj et al., 2006 & Dargahi, 2006), and comparisons of both CFX and Fluent (Cederstrom et al., 1998; 2000 & Yang and Johansson, 1998) to model various spillway hydraulics. Upon completion of some research into the applicability of the three more popular software packages, Flow-3D, CFX, and Fluent, it was found that each has been successfully applied to model advanced problems involving fluid solid interaction and that each could have been used in this evaluation of CFD. Since Flow-3D appears to be the most popular program for spillway modeling and since Manitoba Hydro has had success using Flow-3D over the past decade, this study will focus on use of Flow-3D.

Most of the literature on Flow-3D modeling discusses how the program uses a finite difference solution scheme and the Volume of Fluid (VOF) method, developed by Hirt and Nichols (1981), which allows the model to include only the water portion of the flow. Use of this method results in significant reductions in simulation times as the motion in the surrounding air is neglected and this type of programming allows a sharp interface between water and air to be created without the use of very fine meshes required by other CFD programs. Flow-3D also uses a Fractional Area/Volume Obstacle Representation (FAVOR) method (Hirt and Sicilian, 1985) to define obstacles. This method allows Flow-3D to use fully structured computational grids that are much easier to generate than the deformed grids used by most other CFD programs.

A study completed by Savage and Johnson (2001) used a Flow-3D model to compute discharge and crest pressures over an uncontrolled USACE and USBR standard ogee-

crested spillway. Results from the CFD modeling were subsequently compared to results from a physical model study as well as existing USACE and USBR data. It was found that the Flow-3D discharges were in between the physical model study and the USACE and USBR data for heads ranging from about 0.1 to 0.7 times the design head (H_d). For heads higher than this, up to 1.2 times H_d , the Flow-3D results slightly over-predicted discharge when compared to all three other sources, however, remained within 1% of the physical model results in that range. A good agreement between the Flow-3D results, the physical model study, and USACE data was also obtained for crest pressures with various headwater conditions including $0.51H_d$, $0.82H_d$, and $1.20H_d$.

Ho, Boyes, Donohoo, and Cooper (2003) made comparisons of crest pressures and discharges over a standard ogee spillway from 2d and 3d simulations in Flow-3D to USACE data and empirical discharge equations. Their study found that simulated 2d and 3d crest pressures followed the general trend of data published by USACE, however, in both cases the CFD results predicted slightly larger negative pressures. It was also found that the 2d simulation over-predicted the flow-rates by about 10 to 20 percent depending on the headwater elevation. The 3d CFD simulation results were much better, within 5 percent of the empirical calculations for the three headwater levels considered. This document also goes on to discuss the successful application of Flow-3D software for analysis of spillway hydraulics on three real structures in Australia.

Ho, Cooper, Riddette, and Donohoo (2006) also prepared a document reviewing the application of Flow-3D to eight spillway upgrade projects in Australia. Their report

discusses that the general result for numerical model flow-rates for head levels equal to or greater than the design level yields a 5 percent overestimation when compared to physical models. They also state that although some pressure fluctuations may result from limitations in grid resolution, the general trend of CFD pressures is in reasonable agreement physical model data. They conclude that CFD is a viable technology for use in the design and rehabilitation of spillways. The report also states that, “Further benchmark tests against established data or design guides (USACE-WES, 1952) will provide additional confidence of the analysis technique when applying to different situations or types of problems” (Ho et al., 2006).

Gessler (2005) documented how Flow-3D was used to model discharge over an overflow spillway with newly computed probable maximum flood levels. The results for the discharge were within 5 percent of a previous physical model study and the falling jet trajectories were also in good agreement. The paper stresses a further need for validation of CFD models and that the success of this particular study “should not be considered categorical validation for all spillway type problems” (Gessler, 2005).

Teklemariam, Korbaylo, Groeneveld, Sydor, and Fuchs (2001) prepared a report outlining the use of Flow-3D by engineers at Manitoba Hydro and Acres Manitoba Ltd to model various hydroelectric facility components. The document discusses how Flow-3D was successful in matching the physical model test results for discharge as well as flow patterns and velocities in modeling of a Conawapa diversion port. The report also introduced the ability of Flow-3D to provide discharge measurements that were very

close to empirical estimates for both the Keeyask final spillway and diversion ports, respectively. Research into the use of spur groins to reduce velocities along the cofferdam and some additional forebay modeling of surface velocities was also undertaken for the Keeyask project using the CFD software. Another project involving Flow-3D was a comparison of velocity distributions for two alternative intake designs for the Wuskwatim project. The Wuskwatim spillway was also modeled to confirm the anticipated hydraulic performance of the structure. Overall, the report concludes the successful ability of Flow-3D to model critical design issues at an early stage of the design process.

Engineers at Manitoba Hydro, Acres Manitoba Ltd, and LaSalle Consulting Group have also documented the integral use of both Flow-3D and physical modeling in the design process for the Keeyask generating station. Teklemariam, Shumilak, Sydor, Murray, Fuchs, and Holder (2006) discuss the great potential for the use of CFD for the assessment of a design, as well as screening and optimizing of hydraulic structures and cofferdam layouts. They also note that there are still significant areas of fluid mechanics that are poorly understood and must be addressed through physical modeling. Their paper concludes that CFD has been successful in optimizing the final conceptual configuration for the hydraulics design of the project, but recommend that physical modeling still be used as a final confirmation.

Flow-3D was also used in a study of the impact of the spillway, stilling basin, and tailrace zones of a dam on the biological communities along the Columbia River (Cook et al.,

2004). The report discusses that comparable velocity profile results were obtained using CFD when compared to results from a 1:40 scale physical model. It was also found that the difference between pressure measurements around the baffle blocks and end sill using Flow-3D and a 1:36 scale sectional model were within the accuracy range of the piezometers. The general trends of velocity profiles obtained in a 1:80 scale model of the tailrace were found to be replicated by the software as well. The document goes on to conclude that despite the ability of Flow-3D to replicate physical model results in this case, additional verification of the software against prototype data is essential to increase confidence in the program.

Additional literature discussing successful applications of Flow-3D and other CFD software is available. This summary provides a general overview of the abilities and future promise of CFD software in the hydro-electric industry. It has been found that further studies investigating the applicability of CFD modeling to additional spillway geometries and configurations is necessary. Supplementary correlations between physical and numerical model results would enhance the confidence in the software and possibly make it a viable alternative to physical modeling in some applications. It should also be noted that in some situations, the most optimal design approach may be to use a combination of both CFD and physical modeling as discussed in Teklemariam *et al.* (2006). This research project will attempt to provide additional confidence in CFD through comparisons between results from Flow-3D and physical model testing of several Manitoba Hydro spillways.

1.3 Research Objectives

As noted above, hydraulic engineers are interested in the ability of CFD to model fluid flow at hydro-electric generating stations, including flow over spillways. Locally, engineers at Manitoba Hydro are interested in the benefits of using CFD, Flow-3D in particular, and are eager to verify the software's ability to model spillway flow. Flow-3D is one of the more advanced commercially available CFD packages and it offers many advantages over physical modeling. Exploring these advantages and verifying Flow-3D against physical models will be the focus of this research. In particular, the objectives of this research include:

- 1) To provide a comprehensive summary of all existing published research on CFD modeling of spillway flows and to identify feasible software packages that are applicable to spillway modeling.
- 2) To obtain data from reports of previously completed physical model testing of spillways for various Manitoba Hydro generating stations to compare to values obtained from numerical modeling using the CFD software Flow-3D.
- 3) To obtain and install a physical model of a potential Manitoba Hydro generating station in order to conduct a direct physical model to Flow-3D comparison of desired flow data.

Chapter 2 of this thesis will discuss the Flow-3D model set-up including preparation of spillway geometry as well as specification of model physics, mesh sizing, and boundary conditions. Chapter 3 will present comparisons of physical model experimental data to Flow-3D values for three different previously tested spillways for Manitoba Hydro generating stations. Chapter 4 will outline the installation of a physical model similar to a Conawapa spillway before discussing the experiments that were conducted and how they compared to results from the Flow-3D model. The effect of various factors on simulation times is presented in Chapter 5 along with run time data from all the free overflow and gated simulations. A summary of the physical to numerical model comparisons is provided in Chapter 6 before outlining the main conclusions of the research and some recommendations for future work.

2.1 Introduction to Flow-3D

Flow-3D is a powerful numerical modeling software capable of solving a wide range of fluid flow problems. Current areas of software application include the aerospace industry, various forms of casting, inkjet printers, and several different aspects of hydro-electric generating stations. A good selection of different options across the entire Flow-3D graphical user interface allows the software to be applicable to such a wide variety of situations. Flow-3D allows either one or two fluid flow, with or without a free surface, and a multitude of available physics options to suit the specific application. Various meshing and geometry options are available including multi-block grids and the ability to draw simple objects in the software or import different forms of more complex geometry or topographic files. A large selection of boundary conditions is also available to properly model each specific application. Another benefit of Flow-3D is the ability to select from several different implicit and explicit numerical solver options. All of these model set-up

parameters can easily be specified by either encoding selections in the text editor or by making radio button selections in the graphical user interface.

2.2 Numerical Model Set-Up

The general model set-up for all spillway simulations that were conducted was quite similar. In each case the global tab was specified with one fluid, incompressible flow, and a free surface or sharp interface being selected. Also, the fluid properties were specified as those for water at 20 degrees Celsius for all simulations. Several other model parameters remained generally constant as well, and will be further discussed in the following section.

2.2.1 Physics

Although there are many different physics options available, activation of only two selections was required to obtain accurate simulations of the data that was desired in this study. The gravity option was activated with gravitational acceleration in the vertical or z-direction being set to negative 9.806 m/s^2 . The viscosity and turbulence option was also activated with Newtonian viscosity being applied to the flow along with the selection of an appropriate turbulence model. Once the Flow-3D model was completely prepared, some select simulations were performed with different turbulence models activated. The results showed that there were only minimal differences in the data of interest in this study with different turbulence models applied, as long as the more advanced 2-equation

(k-e or RNG) or large eddy simulation (LES) models were selected. As a result, it was decided that the renormalization group (RNG) turbulence model would be used for all simulations. The decision was made based on comments in Flow-3D user's manual (2007) that the RNG turbulence model is the most accurate and robust model available in the software.

2.2.2 Geometry

Preparation of the numerical model geometry was somewhat different for each of the spillways that were modeled. Depending on the information that was available and the files provided by Manitoba Hydro, the geometry used in the simulations was either provided as a stereolithographic (stl) image or drawn in auto-cad and exported in stl format. The stl images are then directly imported into Flow-3D where the appropriate mesh can be generated. Additional information about the spillway geometry for each of the spillways modeled will be provided in their respective sections in Chapter 3. Another geometry option, that remained constant for all spillway modeling completed as part of this study, was the inclusion of a typical concrete roughness value applied on the surface of all spillway geometry. This was done in Flow-3D by specifying a surface roughness value, equal to the average height of surface imperfections, to the desired components in the meshing and geometry tab. Some simulations were run with and without a roughness and the effects on the desired output were minimal. As a result, no further sensitivity analysis was required and an approximate concrete roughness of 1 mm was applied in all simulations. Also included in the geometry tab for all simulations was a baffle, which is a plane that was defined as a flux surface and specified to be 100 percent porous so that it

would have no affect on the flow. This baffle was normally located in a plane near the crest and was responsible for providing the discharge measurement over the spillway.

2.2.3 Meshing

In a CFD numerical model, a mesh is a subdivision of the flow domain into relatively small regions called cells, in which numerical values such as velocity and pressure are computed. Determining the appropriate mesh domain along with a suitable mesh cell size is a critical part of any numerical model simulation. Mesh and cell size can affect both the accuracy of the results and the simulation time so it is important to minimize the amount of cells while including enough resolution to capture the important features of the geometry as well as sufficient flow detail. An effective way to determine the critical mesh size is to start with a relatively large mesh and then progressively reduce the mesh size until the desired output no longer changes significantly with any further reductions in mesh size. A useful option in Flow-3D that makes this process even more effective is the restart option. This allows the user to run a simulation and then make a variety of model changes, including mesh size and configuration, before restarting the simulation using information from the last time step of the previous simulation. For each of the spillways that were modeled, this process was utilized beginning with a uniform mesh and a 1 m cell size. Restart runs were then completed using a uniform 0.5 m mesh and a uniform 0.25 m mesh for free overflow simulations where discharge was the main desired model output. A similar process was also used when looking at free overflow water surface profiles and pressure data, however, 0.4 m and 0.33 m meshes were also utilized in an attempt to reduce simulation times. It should be noted that utilizing a mesh design with

different aspect ratios is possible in Flow-3D and depending on the situation may be beneficial in optimizing simulation time, however, this is not something that was explored as part of this study.

The process was modified once again when conducting gated simulations. In these simulations, initial results using 1 m, 0.5 m and 0.25 m single uniform meshes did not compare well with physical model data. Further investigation led to the thought of using a nested mesh blocks surrounding the gate, as shown in Figure 2.1, to improve resolution without excessively increasing the total number of cells. A nested mesh block is defined in Flow-3D as a mesh block that has a smaller mesh size and that lies completely within the boundaries of a surrounding mesh block. Use of this technique would allow the model to more effectively capture the complete gate geometry and flow detail below the gate without overly increasing simulations times. Simulations were therefore run using one or even two nested mesh blocks in the area surrounding the gate and resulted in significant improvements to discharges as compared to physical model data. Further details on the use of nested meshing and the effect on the numerical modeling results is available in Chapter 4.

2.2.4 Boundary and Initial Conditions

Setting the appropriate boundary conditions can have a major impact on whether the numerical model results are reflecting the actual situation one is trying to simulate. In this case flow data from free surface flows is desired and so the top boundary was set as

atmospheric pressure while the bottom boundary was specified as a wall. As for the extent of the mesh in the vertical or z-direction, the bottom boundary was set just below the model geometry in order to capture the channel bed, while the top boundary was set just above the highest water elevation. Since the goal of many of these simulations was to model flow-rate over a spillway with different headwater levels for comparison to physical model data, the upstream boundary was set as a specified fluid height. In these simulations it was also decided to set the downstream boundary to a fluid height, although there are several other boundary options available in the software that could have been applied to the downstream side as well. The extend of the mesh in the upstream x-direction was adjusted until any further increases had negligible affect on the discharge, while the downstream boundary was placed just past the bottom of the spillway so that it had no affect on the data of interest. The boundary conditions in the y-direction or the direction perpendicular to the flow depended on the amount of the spillway being modeled. In the case of the Wuskwatim spillway, only one bay was included in the physical model study and upstream conditions were included along with pier walls so the y-direction boundary conditions would not affect the flow but were set as wall boundaries to be safe. For both Conawapa and Limestone, initial comparisons were made with discharges obtained using the entire geometry, half the geometry with a symmetry boundary applied in the centre, and only one bay and two half bays with symmetry applied on both sides. In these simulations, little difference was noticed in the desired output and so the smaller mesh domain was selected with symmetry applied on both sides. Since only minimal differences were found between these simulations with a varying number of spillway bays, it appears that the pier effects are properly being

captured by the model that included only the smaller spillway slice. Use of only a slice out of the full spillway geometry significantly reduced the time required to complete those simulations.

Implementing accurate initial conditions that represent the actual flow field as closely as possible can also have a significant effect on simulation times. In all simulations conducted in this study, rectangular fluid regions were specified on the upstream and downstream sides of the spillways at the same level as the specified fluid heights at the upstream and downstream boundaries. These initializations shown in Figure 2.2, along with specifying a small initial velocity in the x-direction, were incorporated in an attempt to further reduce simulation times.

2.2.5 Numerical Simulations Options

A variety of options are available in the Numerics tab of the Flow-3D model set-up. These options present modifications to the way the Reynolds-averaged Navier Stokes (RANS) equations, which are the fundamental underlying equations in Flow-3D, are solved. In the majority of simulations completed, the default selections were used, however, adjustments and comparisons of different options were completed in some instances. The time step controls were left as default unless the simulation would crash with the provided error message being that the time step was smaller than the minimum. In that case, a smaller minimum time step was sometimes attempted to try and obtain a converging solution. Simulations using the default successive over-relaxation (SOR) and the generalized minimum residual (GMRES) pressure solver options were also compared.

Overall the two options produced fairly similar results, however, for free overflow simulations the SOR pressure solver ran slightly faster, likely due to the fact that the SOR pressure solver requires less memory than the GMRES solver. This will be further discussed in Chapter 5. Simulations were also generally completed using the default explicit solver options, although some comparisons of simulation times were conducted when using implicit solvers as also explained in Chapter 5. The difference between an explicit and implicit solution is that an explicit solution is solved progressively at each computational cell by stepping through time, while the time step is restricted to meet stability criteria. An implicit solution, however, is solved in each time step using information from another time step, something that requires more complex iterative or matrix solutions but that doesn't impose a time step restriction. In the volume of fluids advection section of the Numerics tab, most simulations were run with the default automatic button selected meaning the software would automatically select the one-fluid free surface option based on the specifications made in the global tab. In an attempt to improve Flow-3D comparisons to the physical model data, some simulations were run using the split or unsplit Lagrangian method for volume of fluid (VOF) advection. A Lagrangian solution is one where a particle or element of fluid is tracked as it moves through the computational domain. Use of these options yielded no improvement in results while taking significantly longer to simulate. Also, all simulations were run while solving both momentum and continuity equations and with first order momentum advection selected based on information found in the Flow-3D users manual (2007).

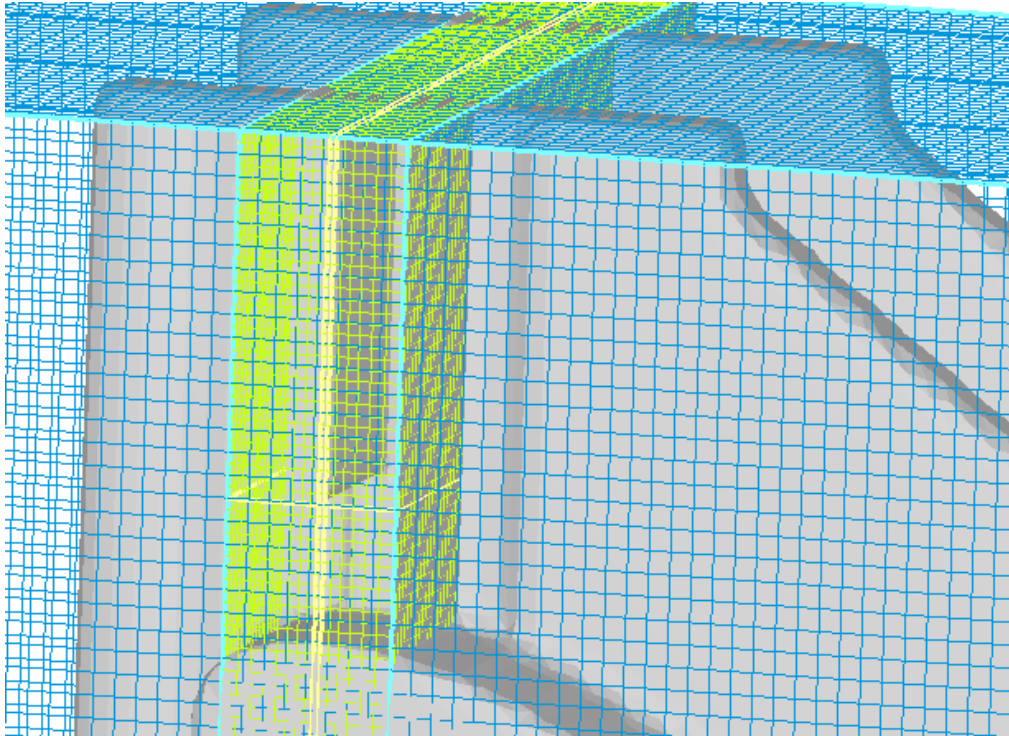

Figure 2.1 Flow-3D nested mesh used in gated simulations

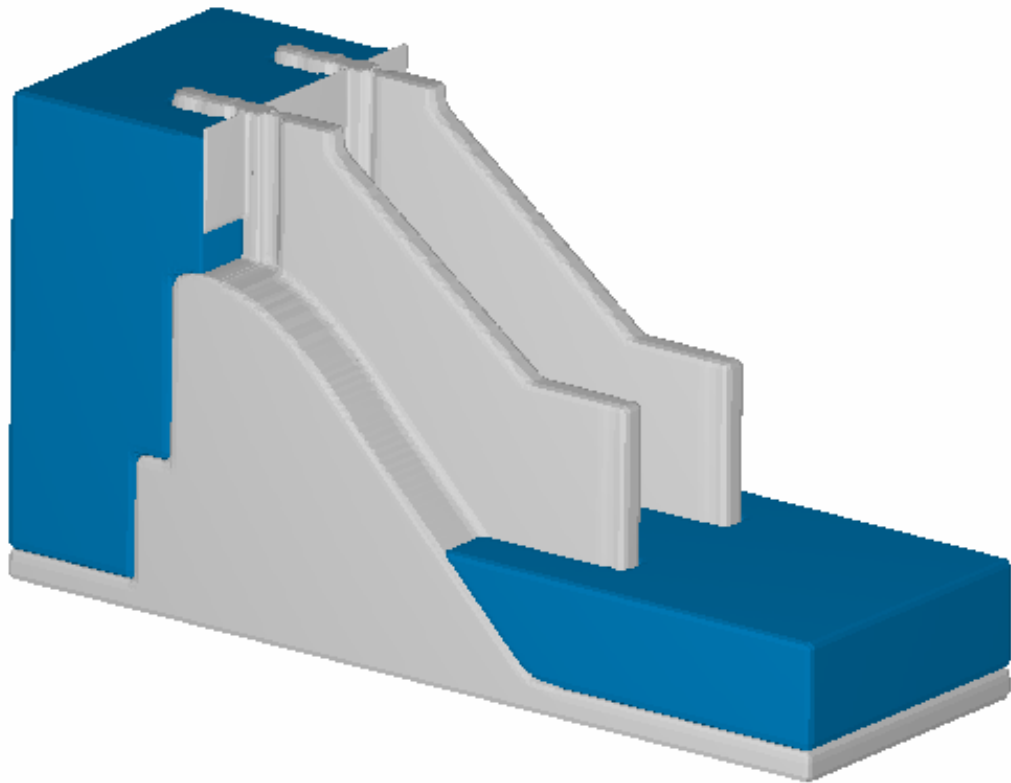

Figure 2.2 Flow-3D fluid initialization for the Limestone spillway

Comparisons

3.1 Introduction

In order to evaluate the capability of the computational fluid dynamics software Flow-3D for modeling spillway flow, a range of spillways that had previously completed physical model studies and reports were selected for comparison. Upon reviewing the Manitoba Hydro spillways with available physical model reports, a selection of three spillways with different spillway height to design head ratios (P/H_d) was completed. The decision was made in order to have three significantly different spillways to verify the general ability of CFD to model ogee crested spillways. Other factors that affected this decision included whether a numerical model already existed for a given spillway and the amount of modeling that had already been completed for that structure. The following sections will introduce the numerical to physical model comparison of various flow data for a preliminary design of the Wuskwatim ($P/H_d=0.91$) spillway, the Limestone ($P/H_d=1.41$)

spillway, and the potential Conawapa ($P/H_d=1.87$) spillway. For the preliminary Wuskwatim spillway, physical model information was available from a University of Manitoba Thesis by Lemke (1989) that compared the use of an orifice to an overflow spillway for that generating station. Limestone physical model data was available from a physical model study report prepared by Western Canadian Hydraulics Laboratories (1980), while the Conawapa physical model data was taken from a study completed by LaSalle Consulting Group (1992) with additional information obtained from another study by Northwest Hydraulics Consultants Ltd. (1992).

In this section, free overflow and gated simulations will be discussed along with the comparisons to physical model data. Evaluation of CFD and physical model discharge rating curves, water surface profiles, and roadway pressures were undertaken for the three spillways selected. Some problems that were encountered while completing the numerical modeling are also introduced, along with some discussion on mesh cell size used when simulating for different types of data. It should be noted that a uniform mesh was used in all simulations, meaning that the specified cell size is the same in all three directions.

3.2 Wuskwatim Generating Station

The site for Manitoba Hydro's proposed Wuskwatim generating station is along the Burntwood River, located in northern Manitoba. The official start date for the project was in the summer of 2006 and construction is scheduled for completion in 2012. Wuskwatim

is a relatively small project with the potential output of the station approximated at 206 MW. It should be noted that the final Wuskwatim spillway design does not incorporate a flip bucket for energy dissipation or an ogee crest as in a preliminary design that was used in this study.

3.2.1 Numerical Model Set-up

Numerical model preparation for the preliminary Wuskwatim spillway comprised of obtaining spillway geometry details from a previous M.Sc thesis (Lemke, 1989) as well as getting information directly from the 1:36 scale physical model that remains in storage in the Hydraulics Research and Testing Facility at the University of Manitoba as seen in Figure 3.1. The geometry details were subsequently used to prepare an Auto-Cad drawing that was formatted into a stereolithographic image (stl), which was then directly imported into Flow-3D for the remainder of the numerical model set-up. The physical model consisted of a single bay and so the numerical simulations were conducted using a single bay as well. Initial simulations were completed without including the upstream flow details available in the thesis. This plain rollway geometry file prepared in Auto-Cad is shown in Figure 3.2 and the CFD discharge was found to significantly overestimate the physical model data as displayed in Table 3.1. As a result, the drawing was adjusted to account for the upstream geometry, provided in Figure 3.3, and subsequent simulations yielded the improved discharge comparisons also shown in Table 3.1. This more encompassing geometry file was used for all subsequent physical to numerical model comparisons for the Wuskwatim spillway.

Table 3.1 Comparison of Wuskwatim physical model flow to varied detail Flow-3D.

Head (m)	Physical Model (m ³ /s)	CFD - No Upstream Detail	Diff. (%)	CFD - Full Upstream Detail	Diff. (%)
3.5	240	276	15.0	264	10.0
5.5	495	555	12.1	530	7.0
7.5	815	909	11.5	870	6.8
9.5	1200	1320	10.0	1260	5.0
11.5	1625	1782	9.7	1692	4.1
12.7	1900	2085	9.7	1979	4.1
14.2	2240	2478	10.6	2325	3.8

3.2.2 Free Overflow Simulations

Once the geometry replicated the physical model experimental set-up, simulations were completed with the goal of verifying free overflow discharges, water surface profiles, and rollway surface pressures against physical model data. Initial simulations were completed with a 1 m mesh size and once the model approximated steady-state, it was re-run using Flow-3D's restart option with a 0.5 m mesh size to improve accuracy. The discharge rating curve obtained using the 0.5 m mesh is displayed in Figure 3.4 along with a comparison to the physical model rating curve. From the Figure, it is obvious that the Flow-3D discharges are larger than the physical model flows for all headwaters levels. Table 3.2 provides the actual percent difference between physical model flow-rates and Flow-3D discharges using both a 1 m and a 0.5 m mesh for comparison. The discharges provided by Flow-3D follow the general trend found in the literature, namely, that CFD overestimates physical model results. Also note that when using a 0.5 m mesh, the flow-rate is within 5 percent of physical model data for the higher headwater levels considered, while the difference increases as the headwater level is reduced. This increase in error with reductions in headwater level is also something that was noticed by Savage and

Johnson (2001). A selection of headwater levels were also simulated using a 0.25 m mesh and although there were further reductions in discharge for a given headwater level, the changes amounted to less than 1 percent and therefore did not warrant the substantial increase in simulation time from hours to days that also occurred.

Table 3.2 Comparison of Wuskwatim physical model to Flow-3D discharge.

Multiple of H_d	Head (m)	Physical Model (m^3/s)	1 m mesh		0.5 m mesh	
			CFD (m^3/s)	Diff. (%)	CFD (m^3/s)	Diff. (%)
0.28	3.5	240	264	10.0	262	9.0
0.43	5.5	495	530	7.0	529	6.9
0.59	7.5	815	870	6.7	867	6.4
0.75	9.5	1200	1260	5.0	1250	4.2
0.91	11.5	1625	1692	4.1	1673	2.9
1.00	12.7	1900	1979	4.1	1946	2.4
1.12	14.2	2240	2325	3.8	2307	3.0

Simulations were next completed with the goal of reproducing a water surface profile along the spillway. The centre-line water surface profile for a headwater level of 14.2 m above the crest was available in the physical model and so this water level was specified in the numerical model to obtain a comparison. A 0.5 m mesh was initially employed throughout the entire computational domain and yielded a reasonably good comparison, however, a restart simulation with a 0.25 m mesh size compared much better, 0.5 m closer at some points, with the physical model data and is shown in Figure 3.5. In this comparison water level data is plotted in elevation where the crest is at 230.5 m above sea level. As seen in the figure the majority of the points overlap exceptionally well, while only the first and last point on the profile seem to exhibit any notable error.

Another comparison that was made between the physical and numerical models was that of centre-line rollway pressures with an upstream water level of 11.5 m above the crest. In this case an initial comparison was made with a 0.5 m numerical mesh, however, it was again found that the data obtained using a 0.25 m mesh more closely matched the physical model. Figure 3.6 displays a comparison of the physical model and the 0.25 m mesh numerical model pressures and although the data are not identical, Flow-3D is able to capture the general trend of the pressure data. An attempt to obtain more accurate pressure data was conducted by utilizing the generalized minimum residual (GMRES) pressure solver option in the Numerics tab of Flow-3D. Use of this solver, however, had a negligible impact on results while taking slightly longer to simulate and was therefore not used in subsequent free overflow simulations.

3.2.3 Gated Numerical Modeling

Although comparisons between numerical and physical model free overflow data have been made in the literature, there did not appear to be any literature comparing gated flows. In this section, discharges from simulations with various gate openings were obtained and compared to results from the physical model reports.

Since this was the first of the three spillways on which gated flow comparisons were attempted, initial simulations completed with a 4 m gate opening will be introduced. Gated simulations commenced using the same 1 m, 0.5 m, and 0.25 m uniform meshing that was used when comparing free overflow discharges. The numerical model discharges from these initial simulations were approximately 15 percent larger than the physical

model data when using a 0.5 m mesh as shown in Table 3.3. Use of finer uniform mesh sizes was also attempted but only negligible differences in flow-rates were observed. As a result of the poor comparison obtained when using uniform meshing, further investigation was completed and it was decided that including a nested mesh in the area surrounding the gate may improve resolution in that area and provide more accurate flow-rates. Initially, a 0.25 m mesh was nested inside a 0.5 m mesh such that the nested mesh extended several cells upstream and downstream from the spillway gate surfaces. The discharge that resulted from those simulations provided an approximate 50 percent improvement when compared to physical model flow-rates as shown in Table 3.4. Also shown in the table is discharge obtained when inserting a second nested mesh with a size of 0.125 m per cell along with a comparison to the physical model data that shows the difference to be less than 2 percent. This magnitude of difference is well within the accuracy of physical modeling, which has been stated to be within five percent of prototype values by Gessler (2005).

Table 3.3 Comparison of Wuskwatim physical model gated flow to single mesh CFD.

Multiple of H_d	Head (m)	Physical Model (m^3/s)	1 m mesh		0.5 m mesh	
			CFD (m^3/s)	Diff. (%)	CFD (m^3/s)	Diff. (%)
0.75	9.5	681	776	13.9	776	13.9
0.86	10.	745	852	14.4	849	14.0
1.00	12.7	817	939	14.9	936	14.6
1.13	14.3	869	1017	17.0	1011	16.3

Table 3.4 Comparison of Wuskwatim physical model gated flow to nested mesh CFD.

Multiple of H_d	Head (m)	Physical Model (m^3/s)	0.5-0.25 m nested mesh		0.5-0.25-0.125 m nested mesh	
			CFD (m^3/s)	Diff. (%)	CFD (m^3/s)	Diff. (%)
0.75	9.5	681	735	8.0	683	0.2
0.86	10.	745	806	8.1	755	1.3
1.00	12.7	817	885	8.3	833	1.9
1.13	14.3	869	954	9.8	884	1.7

Once Flow-3D discharges were comparable to physical model data for a 4 m gate opening, simulations were completed using both 2 and 6 m gate openings. When using the same 0.5-0.25-0.125 m nested mesh resolution presented in Table 3.4, it was found that the Flow-3D discharges for the 2 m gate opening were 7 to 9 percent larger than the physical model data, while the comparison of flows with a 6 m gate opening were within 1 percent. Some additional simulations were completed with a slightly finer nested mesh combination of 0.4-0.2-0.1 m, however, no improvements were noticed and simulation times were becoming excessively large. Overall the gated flow simulations progressed quite well once the nested meshing technique was implemented. A comparison between numerical and physical model data for all three gate openings is provided in Figure 3.7.

3.3 Limestone Generating Station

The Limestone generating station is situated in northern Manitoba, approximately 750 km north of Winnipeg, along the lower reach of the Nelson River. Although there is potential for additional hydro-electric generation along this river, Limestone is currently the fifth and newest generating station to be built on the Nelson. It is currently the largest

generating station in Manitoba and has been since its construction was completed in 1990. The approximate generating capacity at Limestone is 1340MW and its spillway consists of 7 bays that are each 13 m in width.

3.3.1 Numerical Model Set-Up

A geometry file provided by Manitoba Hydro was used to perform physical model to numerical simulation data comparisons on the Limestone spillway. The drawing was prepared based on the actual spillway currently in operation and not the spillway from the 1980 physical model study, carried out by Western Canadian Hydraulics Laboratories, from which physical model data was obtained. Use of this model was deemed acceptable as the major difference between the two spillways is that the actual spillway has a stilling basin for dissipation of energy, while the physical model had a flip bucket. Since this difference is located far enough downstream that the flow would be supercritical well before reaching any variations, the geometry difference was not expected to affect the results as long as one compared either discharge or other parameters high enough on the spillway surface. Other minor differences between the two spillways that were located on the upstream face of the structure were also deemed to have a negligible impact on any comparisons.

3.3.2 Free Overflow Simulations

Once the model geometry was successfully imported into Flow-3D, simulations began with the goal being to obtain the discharge rating curve, followed by water surface

profiles, and rollway pressures for comparison to physical model data. To begin, simulations were carried with different amounts of the geometry being included as discussed in Chapter 2. There, it explains that using only 1 bay with two half bays provided results that were representative of using the entire spillway geometry. A discharge rating curve was then obtained with both a 1 m and 0.5 m uniform mesh and compared to physical model data. As shown in Table 3.5, a 1 m mesh provides a relatively good comparison to physical model data and when the mesh is refined to 0.5 m, the Flow-3D flow-rates are within 3 percent of physical model data for all headwater levels considered. This difference is well within the accuracy of physical modeling and so Flow-3D has successfully modeled flow-rate for this particular spillway. A graphical look at how the physical model data and Flow-3D rating curve obtained with a 0.5 m mesh compare is also provided in Figure 3.8, while Figure 3.9 shows water flowing over the numerical model spillway under design head.

Table 3.5 Comparison of Limestone physical model to Flow-3D discharge.

Multiple of H_d	Head (m)	Physical Model (m^3/s)	1 m mesh		0.5 m mesh	
			CFD (m^3/s)	Diff. (%)	CFD (m^3/s)	Diff. (%)
0.08	1.1	189	204	7.8	194	2.8
0.27	3.7	1176	1246	6.0	1208	2.7
0.46	6.3	2765	2890	4.5	2833	2.4
0.61	8.4	4389	4571	4.2	4471	1.9
0.70	9.6	5460	5683	4.1	5607	2.7
0.81	11.1	6860	7155	4.3	7014	2.2
0.99	13.6	9520	9813	3.1	9695	1.8
1.06	14.5	10500	10889	3.7	10721	2.1

Centre-line water surface profiles for headwater levels of 77.5 m and 84.9 m were also obtained from Flow-3D. For these simulations, a 0.33 m mesh was deemed sufficient for providing a reasonably accurate comparison to available physical model data as shown in Figure 3.10. A 0.33 m mesh was also found to provide roadway pressures that were in reasonable agreement with physical model data. Figure 3.11 provides a comparison of the roadway pressure and shows that although the data do not overlap, there is generally good agreement between the types of modeling and Flow-3D is capable of providing the general trend of roadway pressures. This conclusion is in agreement with the statement made by Ho *et al.* (2006). It should also be noted that physical model data was provided along 2.5 m to the left and to the right of the centre-line for the first 4 data points and along the centre-line for the remainder of the points. Also, only one line is provided for the CFD data since the data on either side of the centre-line was identical.

3.3.3 Gated Numerical Modeling

Simulations with gate openings of 2, 4, and 6 m were completed for the Limestone spillway in a similar manner to the way they were completed for the Wuskwatim spillway, except that slightly larger mesh sizes and different nested mesh combinations were used. This was done because the flow domain of the Limestone numerical model was significantly larger and simulation times were excessively large when using the Wuskwatim gated mesh configurations. Discharge comparisons to physical model data for these simulations was quite good with only the value for the lowest headwater level modeled for the 6 m gate opening deviating by greater than 5 percent from the physical

model data. Figure 3.12 provides a comparison of the flow-rates and it can be seen that the majority of the data are in very good agreement.

3.4 Conawapa Generating Station

Conawapa is one of Manitoba Hydro's potential future generating stations. If constructed, the station would surpass Limestone as being the largest generating station in Manitoba. The site for the proposed station is along the Nelson River, approximately 28 km downstream from the existing Limestone generating station. The approximated production capacity for Conawapa would be 1380 MW. As with the Limestone spillway, the Conawapa spillway would consist of 7 bays that are each 13 m in width.

3.4.1 Numerical Model Set-up

In comparing numerical model data to data from a 1992 physical model study of a Conawapa spillway completed by LaSalle Consulting Group, two different geometry files were attempted. Initial simulations were conducted using a geometry file provided by Manitoba Hydro and Acres Manitoba Ltd. that was based on the 2003 revised design completed by Acres. Before performing simulations with this file, an adjustment of the crest level from the 2003 level of 42.1 m to the 1992 crest level of 42.8 m was completed. The discharge results from these initial simulation did not compare exceptionally well with physical model data and the comparisons did not follow the general trend found in literature, thereby prompting a more comprehensive comparison of the two models. This

led to the discovery of a different bay shape in bays 1, 3, 5 and 7 than in bays 2, 4, and 6 that was present in the 1992 design, as shown in Figure 3.13, and not the 2003 design. As a result, a new Auto-Cad drawing was developed based on the complete spillway geometry that was located in the physical model report (LaSalle, 1992). Simulations with this newly drawn geometry resulted in slightly improved comparisons to the physical model data although the comparisons still did not follow literature reported trends. Additional information about simulations with the new geometry will be presented in the following section.

3.4.2 Free Overflow Simulations

A similar verification to the one done with the Limestone spillway was also completed for the Conawapa spillway in order to ensure that using a slice out of the complete spillway geometry would provide representative results. Once this was confirmed, simulations were completed with the same 1 m and 0.5 m uniform meshes used in previous simulations, providing the results shown in Table 3.6. A comparison of the physical model and 0.5 m mesh numerical model rating curves is also provided in Figure 3.14.

Table 3.6 Comparison of Conawapa physical model to Flow-3D discharge.

Multiple of H_d	Head (m)	Physical Model (m^3/s)	1 m mesh		0.5 m mesh	
			CFD (m^3/s)	Diff. (%)	CFD (m^3/s)	Diff. (%)
0.15	2.2	735	574	-21.9	555	-24.4
0.29	4.2	1680	1548	-7.8	1514	-9.9
0.42	6.2	2905	2832	-2.5	2798	-3.7
0.56	8.2	4480	4425	-1.2	4348	-2.9
0.70	10.2	6370	6244	-2.0	6137	-3.7
0.84	12.2	8260	8283	0.3	8150	-1.3
0.97	14.2	10500	10553	0.5	10369	-1.2
1.04	15.2	11550	11748	1.7	11559	0.1
1.08	15.7	12145	12369	1.8	12182	0.3

In this comparison, the results did not follow the general trend found in the literature, or in the Wuskwatim and Limestone comparisons, that CFD over-estimates physical model flow-rates. It can also be noticed from Table 3.6 as well as in the previous discharge comparisons that in simulations on all three spillways, the discharge was reduced whenever the mesh size was reduced. As a result, refining the mesh only resulted in greater difference between the two types of modeling for the majority of headwater levels modeled for the Conawapa spillway. One should note, however, that the discharge for all headwater levels but the lowest two is still within 5 percent of the physical model data. Also, the discharge comparison for a standard ogee crested spillway presented by Savage and Johnson (2001) seems to follow the same trend as was noticed here. Both comparisons show CFD to overestimate the physical model for higher headwater levels, while CFD decreased considerably as compared to the physical model as headwater levels were reduced.

Although no pressure data was available in the physical model report and, as a result, no pressure comparisons could be completed for this spillway, some water surface profile data was extracted for comparison to the numerical model. The data was compared for a headwater level near the probable maximum flood level (PMF) and the resulting numerical model profile obtained using a 0.4 m mesh size is plotted along with the physical model data in Figure 3.15. It should be noted that the 0.4 m mesh size was selected in an attempt to find a mesh that provided an accurate water surface profile while keeping simulations time to a minimal. Once again, the CFD points are in very good agreement with the physical model curve for this spillway.

3.4.3 Gated Numerical Modeling

For the Conawapa spillway it was initially desired to compare discharges between the two types of models with 2, 4, and 6 m gate openings to better match up with the previous comparisons. This was not possible, however, as only data for 1, 3, and 5 m gate openings was available in LaSalle's report. Simulations for these three gate openings were therefore completed, once again employing the nested meshing technique. Comparisons of numerical model discharges to physical model data are provided in Figure 3.16. In this case the numerical model flow was approximately 20 percent lower than the physical model for the 1 m gate opening. The reason for this large difference is unknown and several different mesh, turbulence, and numeric options were attempted with no improvements being observed. The comparisons were significantly better for the larger two gate openings as the majority of those numerical and physical model points were within 5 percent of one another.

3.5 Combined Results

Upon completion of the numerical modeling for each of the three spillways in sections 3.2 to 3.4 above, the results were normalized and combined into a single figure for each of the types of data compared. Figure 3.17 shows the comparison of discharge rating curves while Figure 3.18 provides the water surface profile comparisons for each of the three spillways modeled. The roadway surface pressure comparisons that were completed for the Wuskwatim and Limestone spillways are displayed together in Figure 3.19. Figure 3.20 includes CFD to physical model comparisons of gates discharge rating curves for each of the three spillways and for three different gate opening in each case.

3.6 Average Percent Difference Trend

Once the free overflow discharge comparisons were completed for each of the three spillways in the study, an interesting tendency in the data was discovered. It was found, and has been documented by Chanel and Doering (2007), that the average of the difference between numerical model discharges as compared to physical model data followed a trend with the spillway's height to design head ratio (P/H_d). A plot of the averaged difference and the P/H_d ratio is shown in Figure 3.21. Upon examination of the figure one can see that as the ratio is reduced, the Flow-3D discharges are increasing relative to the physical model flow-rates. Also note that a similar trend was revealed following completion of the gated discharge comparisons. Despite the appearance of this

correlation, it should be noted that additional data from comparisons of spillways with different P/H_d ratios is require to establish the validity of the trend.

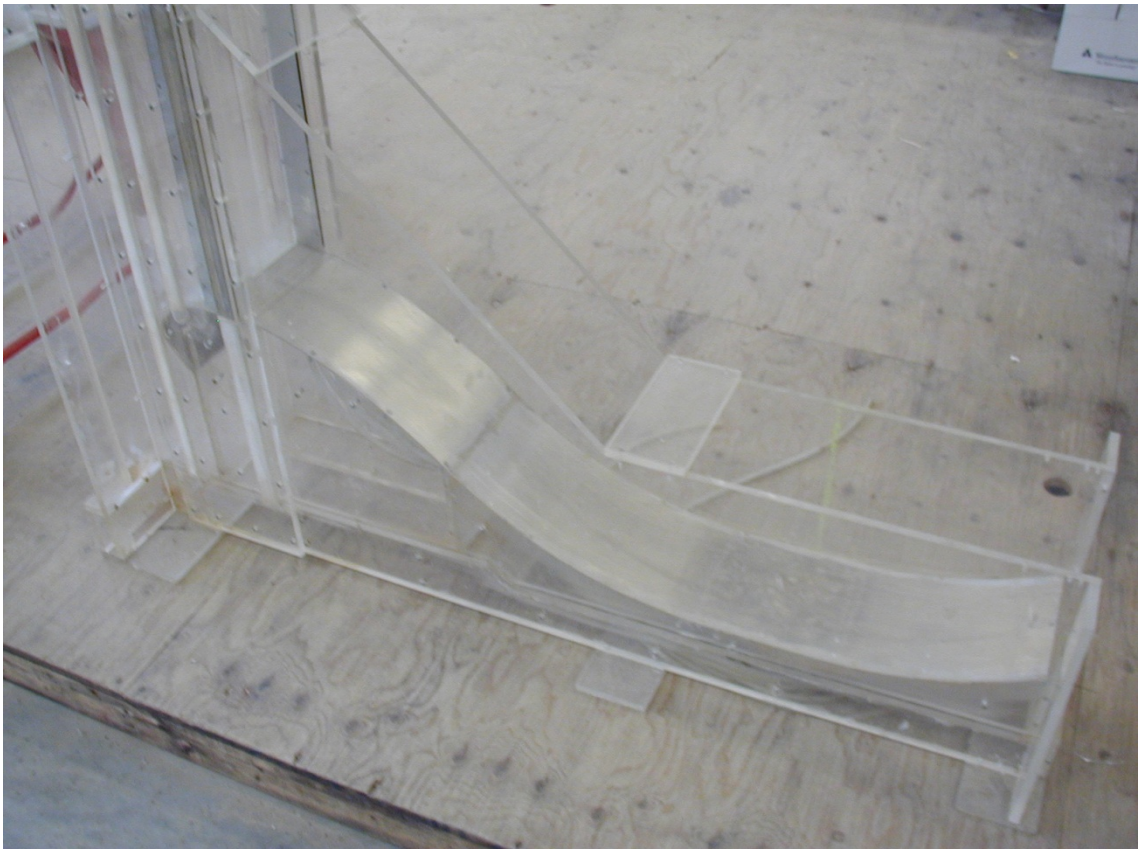

Figure 3.1 Physical model of preliminary Wuskwatim spillway.

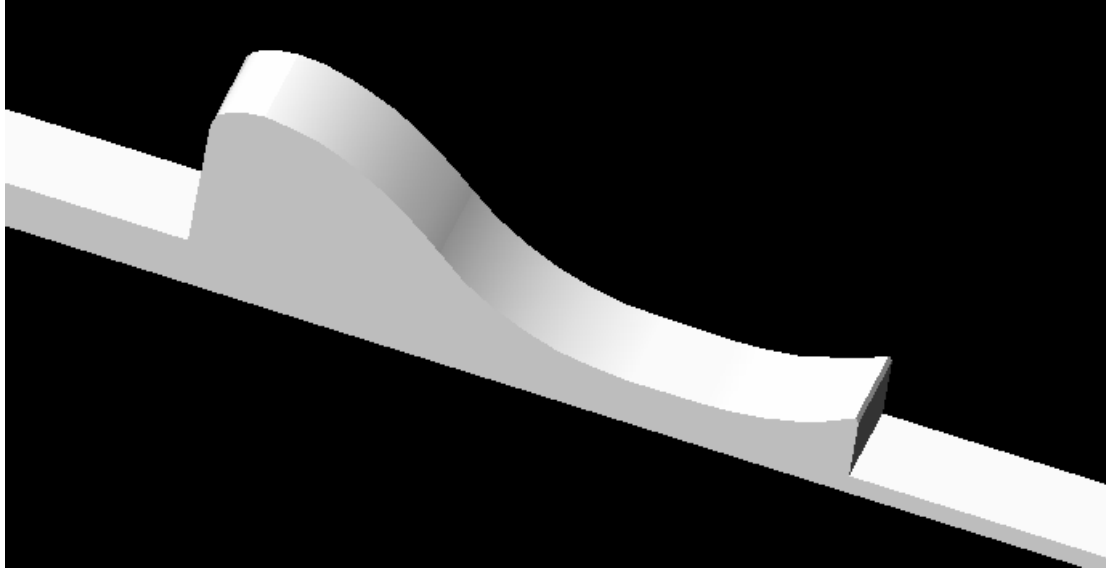

Figure 3.2 Auto-Cad drawing of preliminary Wuskwatim spillway without piers or upstream flow details.

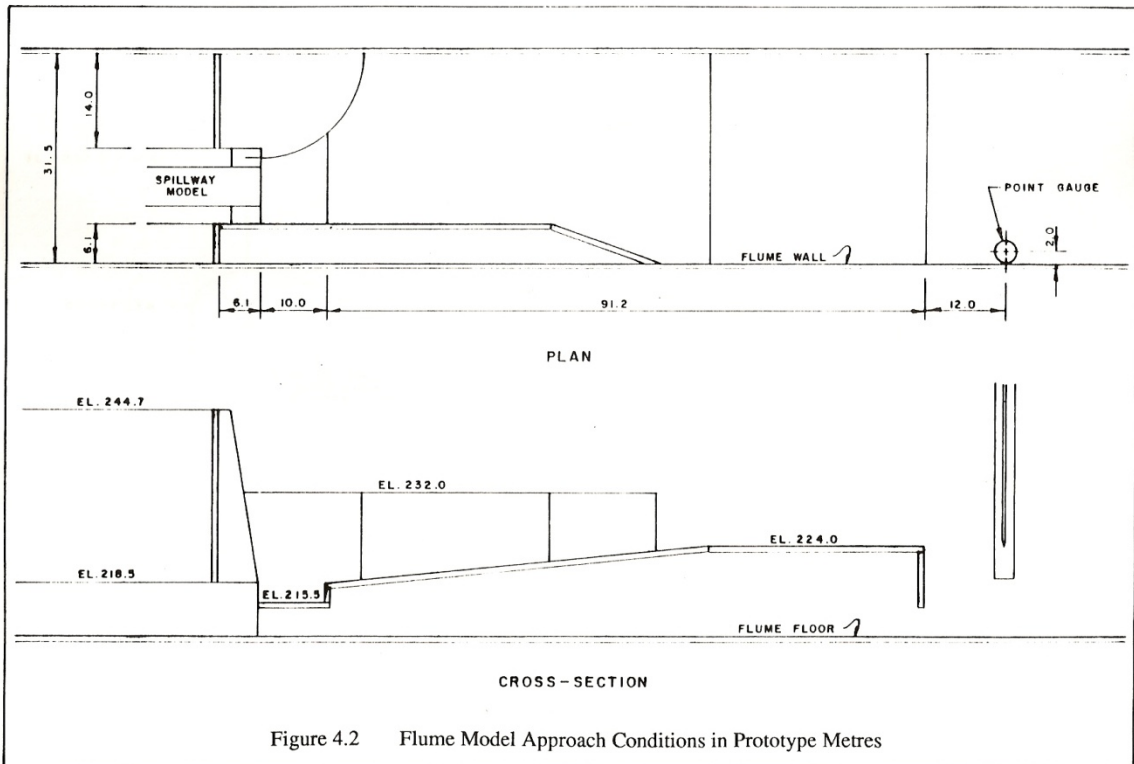

Figure 4.2 Flume Model Approach Conditions in Prototype Metres

Figure 3.3 Wuskwatim physical model upstream geometry details used in final Flow-3d model set-up (Lemke, 1989).

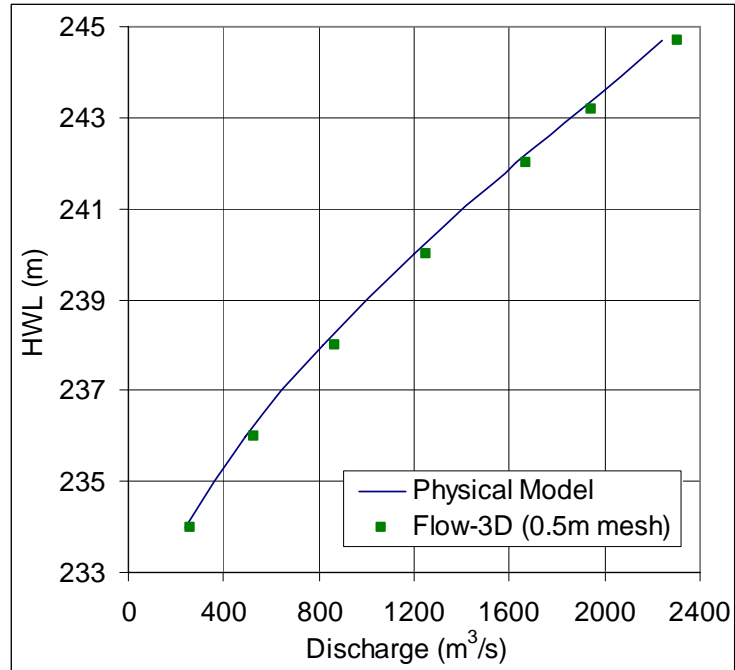

Figure 3.4 Wuskwatim physical model to Flow-3D discharge comparison.

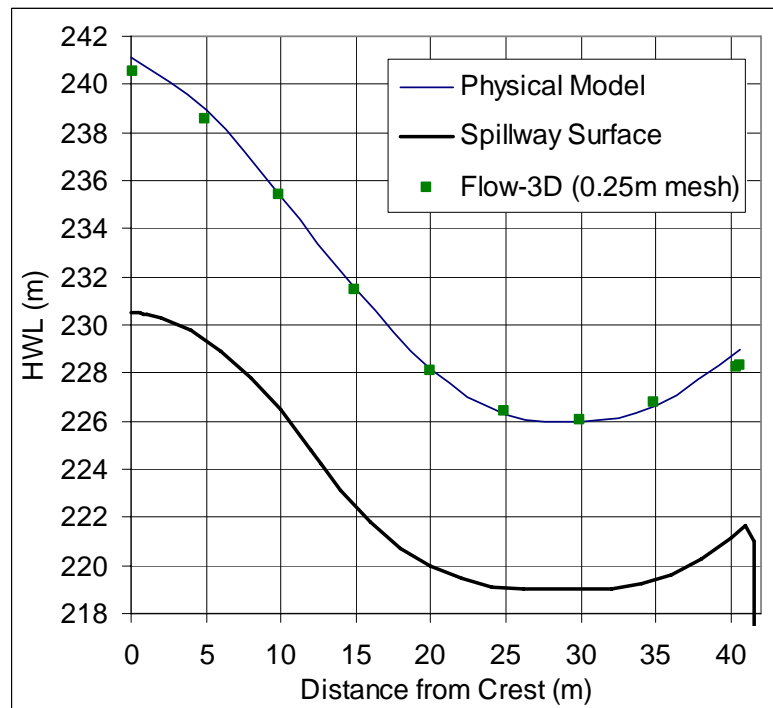

Figure 3.5 Wuskwatim physical model to Flow-3D water surface profile comparison.

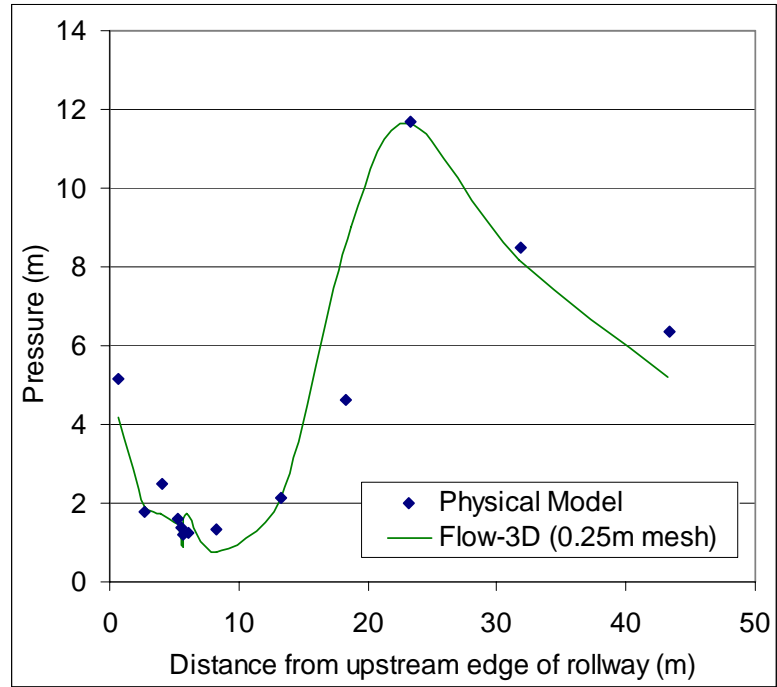

Figure 3.6 Wuskwatim physical model to Flow-3D rollway pressure comparison.

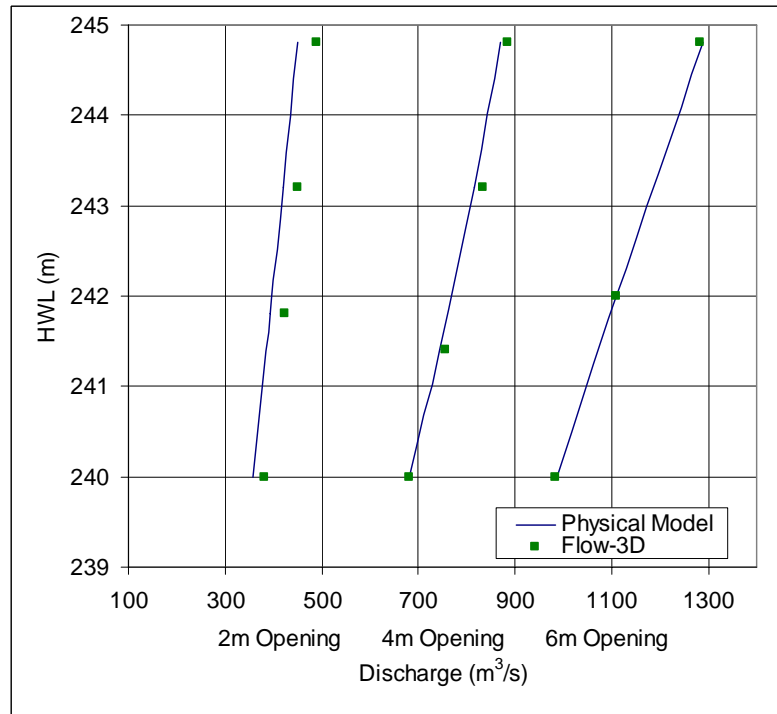

Figure 3.7 Wuskwatim physical model to Flow-3D gated discharge comparisons.

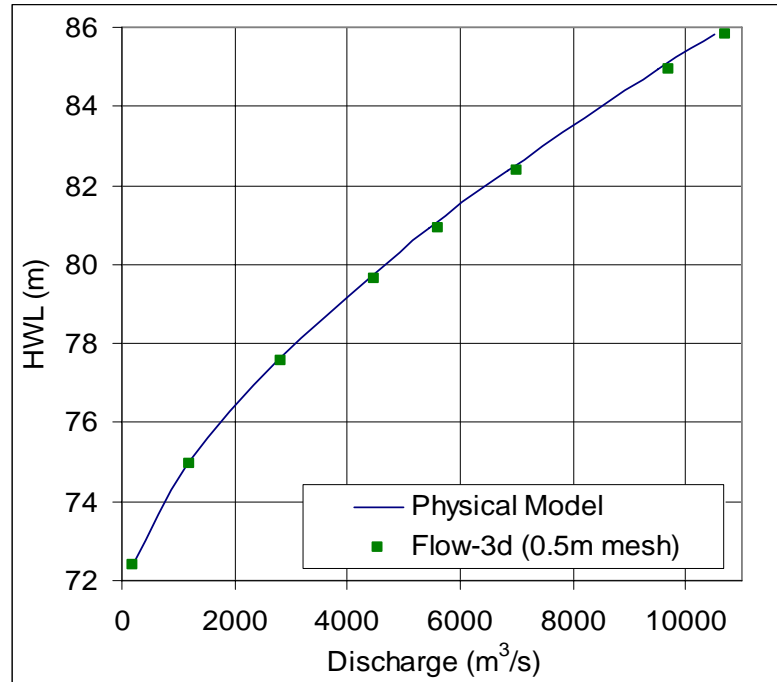

Figure 3.8 Limestone physical model to Flow-3D discharge comparison

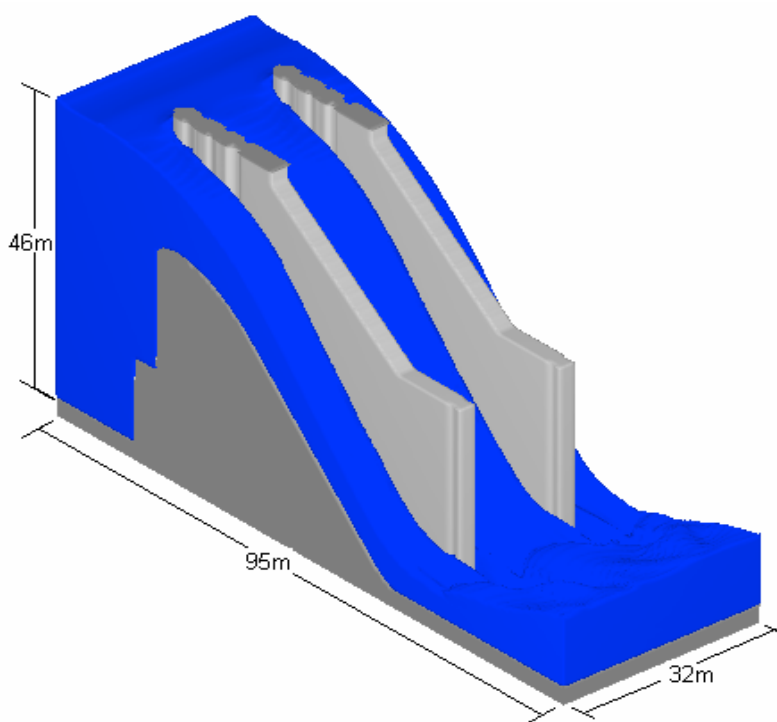

Figure 3.9 Limestone Flow-3D model flowing at design head.

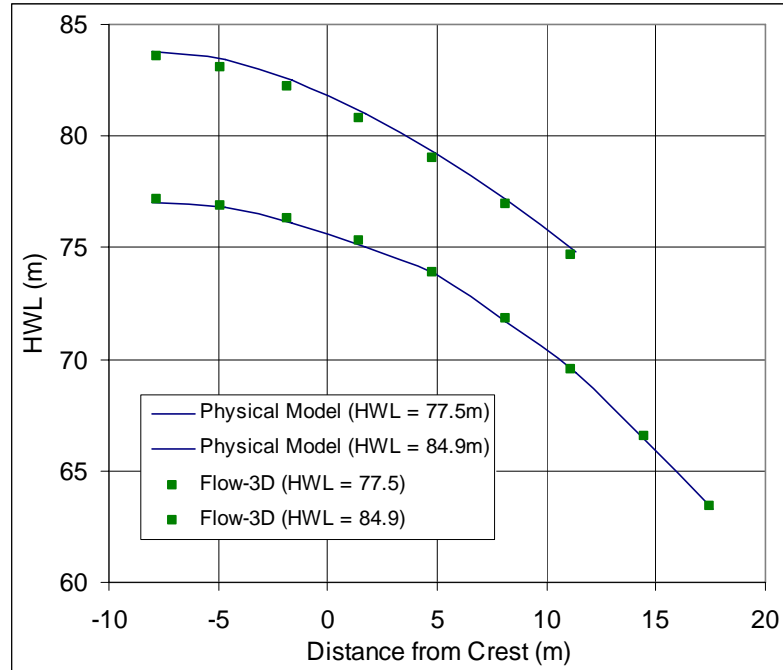

Figure 3.10 Limestone physical model to Flow-3D water surface profile comparison.

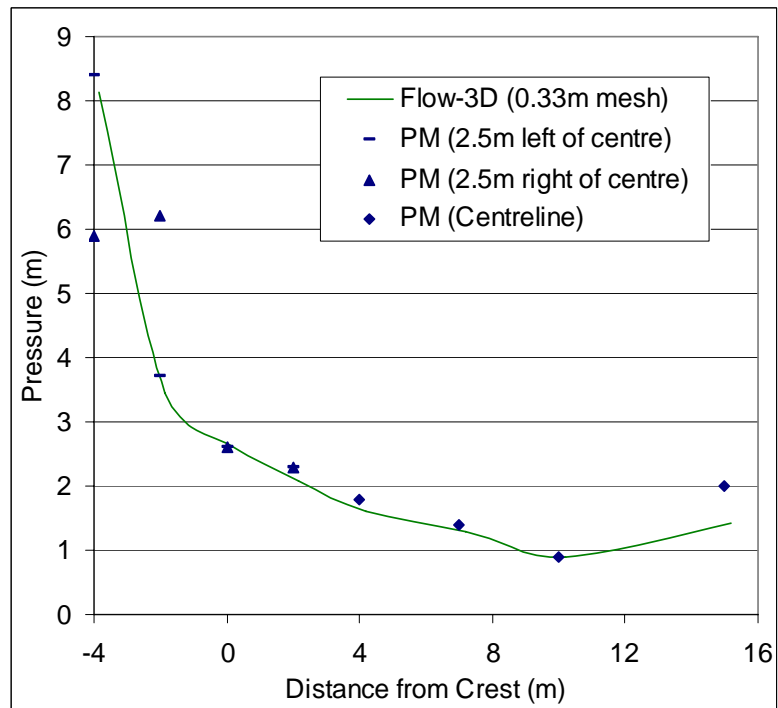

Figure 3.11 Limestone physical model to Flow-3D roadway pressure comparison.

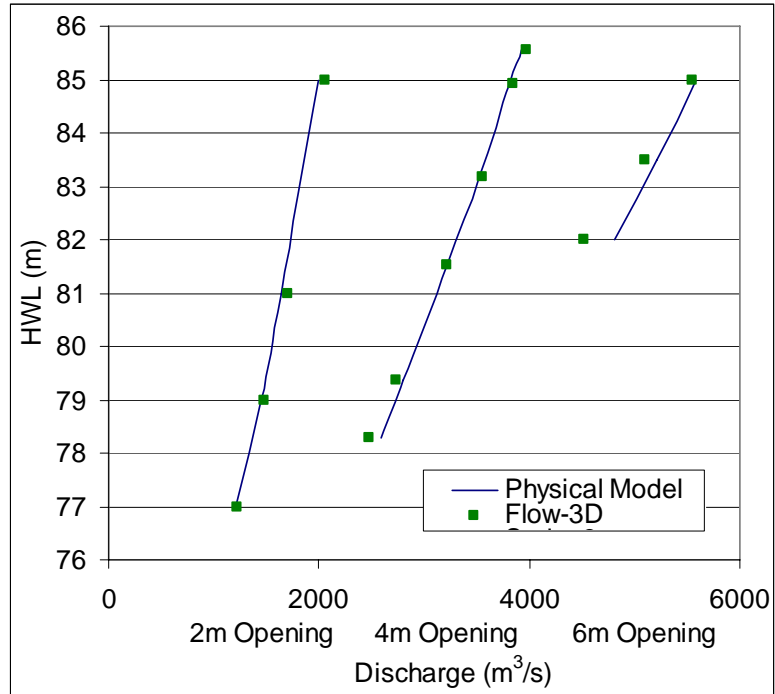

Figure 3.12 Limestone physical model to Flow-3D gated discharge comparison

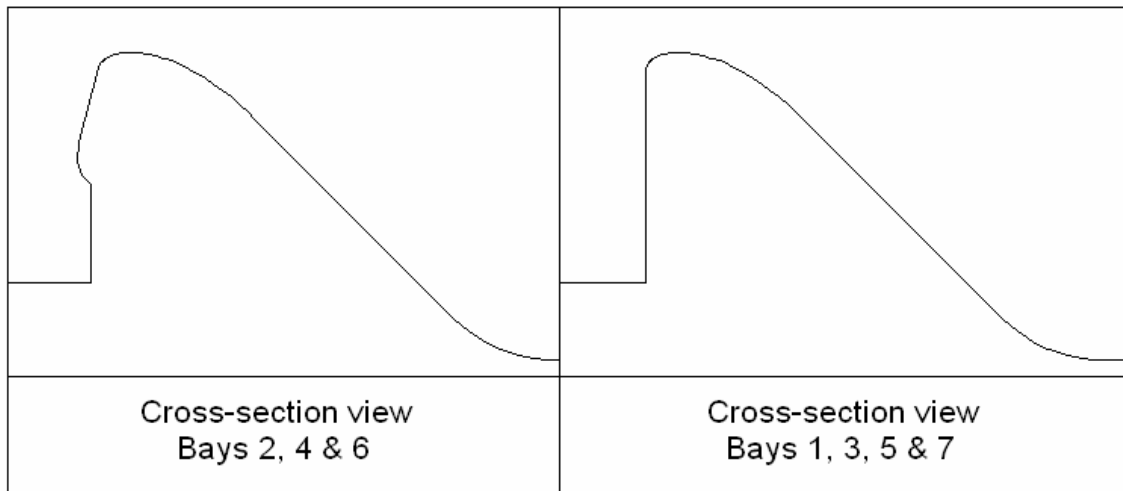

Figure 3.13 Conawapa 1992 physical model bay shape difference (Northwest Hydraulic Consultants Ltd., 1992).

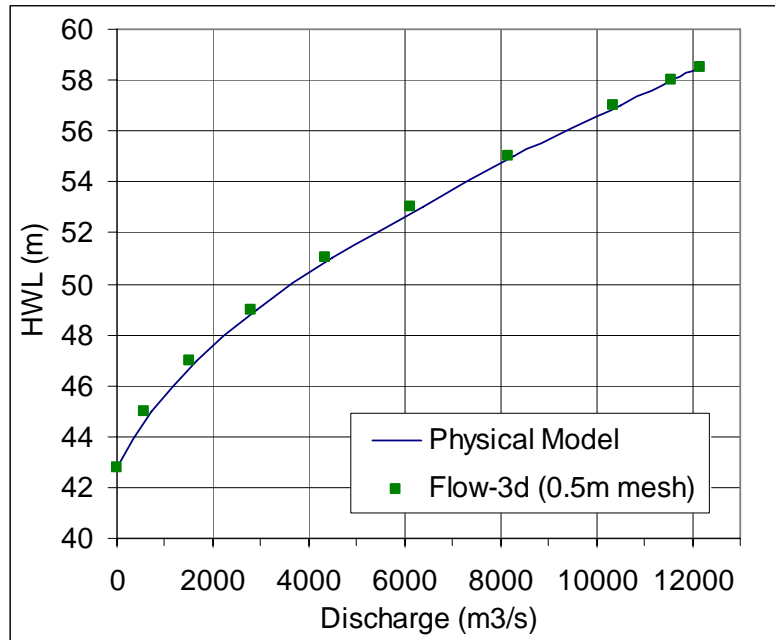

Figure 3.14 Conawapa physical model to Flow-3D discharge comparison.

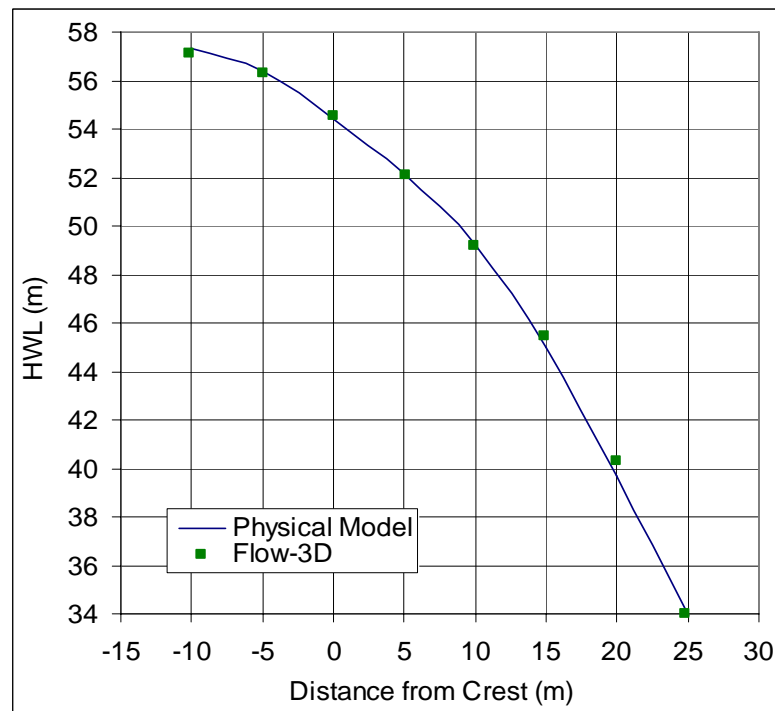

Figure 3.15 Conawapa physical model to Flow-3D water surface profile comparison.

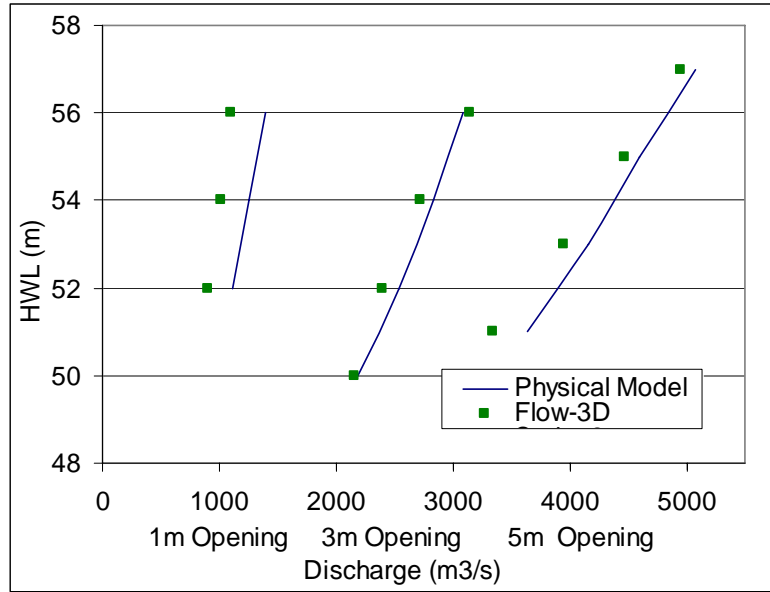

Figure 3.16 Conawapa physical model to Flow-3D gated discharge comparison.

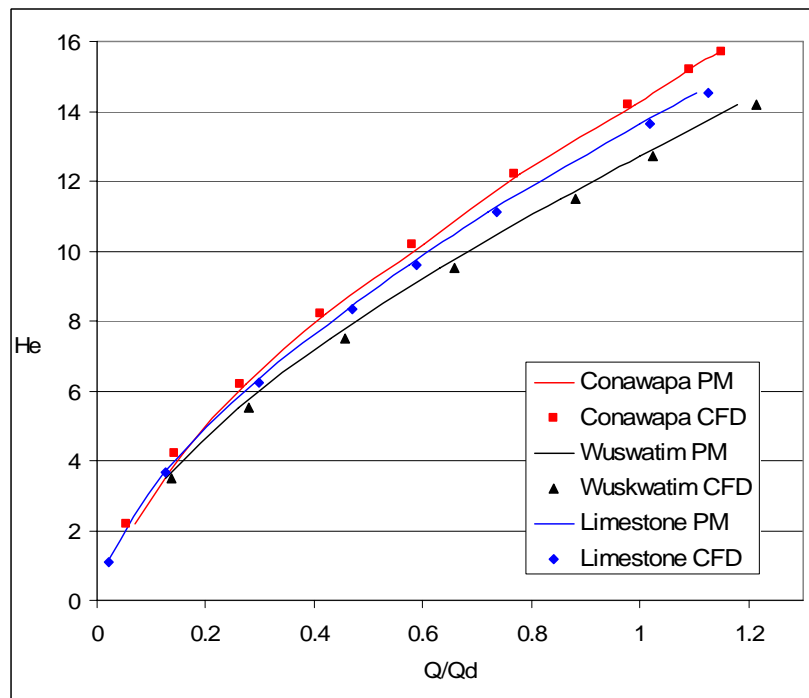

Figure 3.17 Physical model to Flow-3D discharge comparisons.

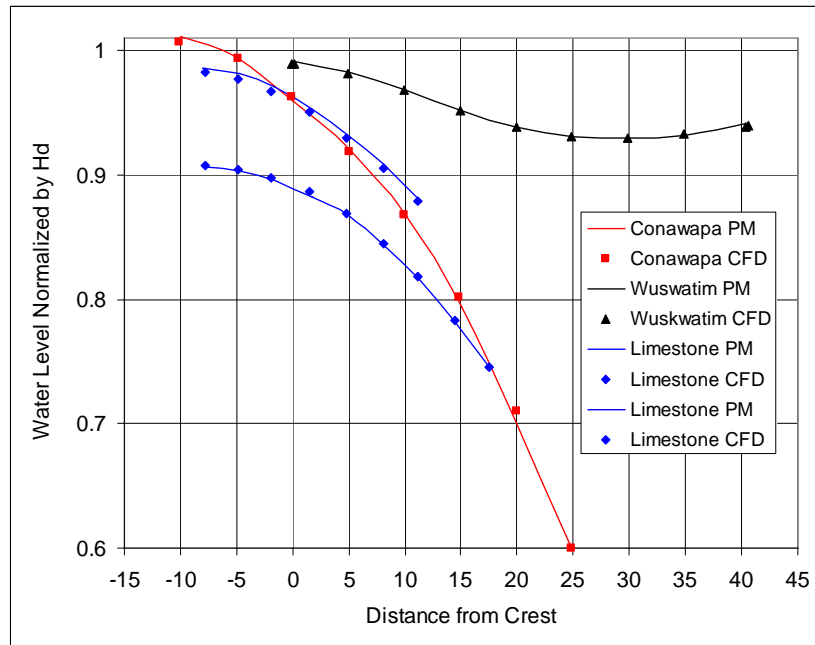

Figure 3.18 Physical model to Flow-3D water surface profile comparisons

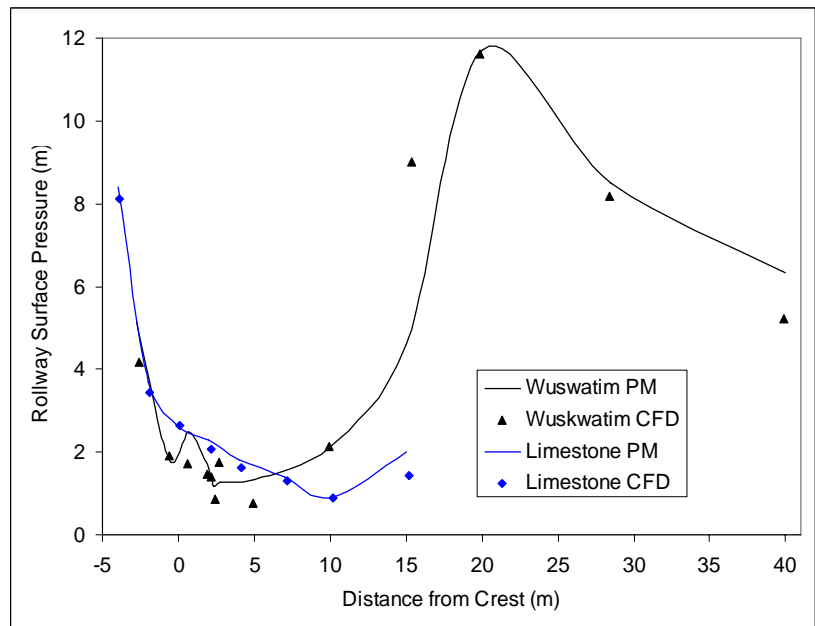

Figure 3.19 Physical model to Flow-3D rollway surface pressure comparisons

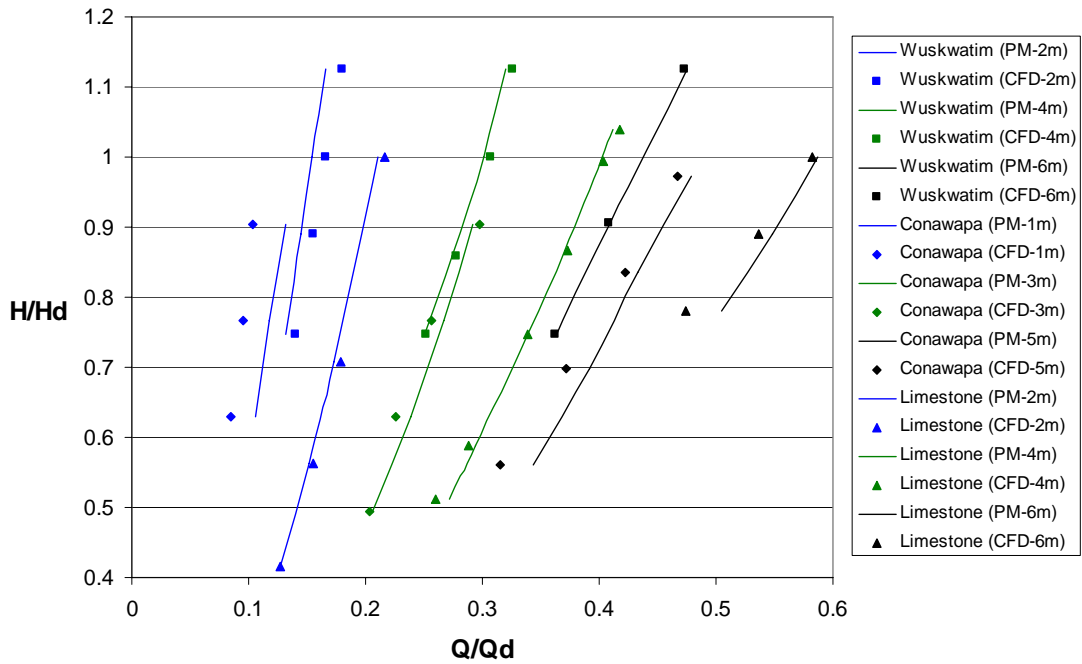

Figure 3.20 Physical model to Flow-3D gate discharge comparisons

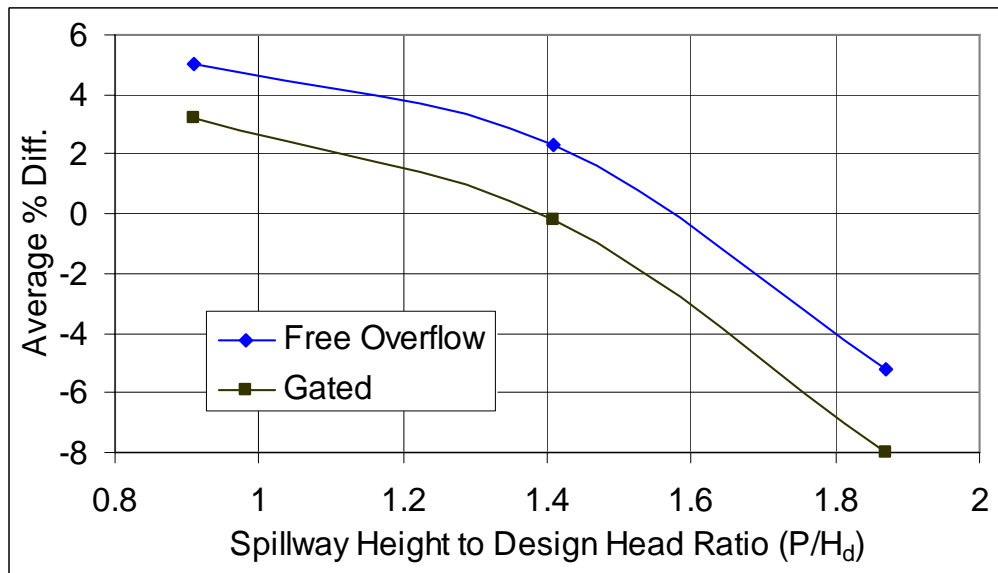

Figure 3.21 Average percent difference in Flow-3D discharge trend with P/H_d as compared to physical model data.

Physical Modeling for Additional Flow-3D Comparisons

4.1 Introduction

In order to supplement the Flow-3D comparisons presented in Chapter 3, a refurbished spillway physical model was installed in the rubber lined wooden flume on the lower level of the Hydraulics Research and Testing Facility (HRTF) at the University of Manitoba. The model represented an updated design of the Conawapa spillway from the one modeled in Section 3.4 and was used to obtain discharge rating curves and water surface profiles under both free overflow and gated conditions. Following each of the experiments a Flow-3D model, developed to replicate the tests, was simulated in order to provide addition comparisons between CFD and physical modeling.

4.2 Physical Model Testing

The physical model that was used for this research was originally constructed for a study that compared the performance of different types of end sills and stilling basin configurations for the potential Conawapa generating station spillway (Ye, 2005). The model, which included two full bays surrounded by two half bays, was constructed of different types of water-proof wood, along with one plexiglass wall to allow flow visualization and light gauge aluminum for the spillway rollways. When that study was completed, the model went into storage, but has since been returned to the HRTF and re-inserted into the flume for this study.

4.2.1 Physical Model Installation

Before the model was installed in the flume some rehabilitation work was conducted including removal of old silicone sealant, mending a cracked plexiglass outer wall, and re-sealing various parts of the model. A variety of materials were also required to install the model in the flume. Various amounts of lumber, water-proof plywood, and sealant were ordered based on photographs of the previous model set-up as well as an Auto-Cad drawing of the new model arrangement that is displayed in Figure 4.1. Once the model and surrounding conduits were constructed and sealed as shown in Figure 4.2, several test runs were conducted as the model itself was discovered to contain several leaks. After several iterations of running water, attempting to locate potential sources for the leaks, drying the model, and re-sealing, the model was nearly water tight and ready for experimentation.

4.2.2 Discharge Measurements

In the HRTF, water is supplied to hydraulic models via 14 inch lines that extract water from a constant head tank on the upper level of the facility. This tank is filled from a reservoir, located below the laboratory, which is equipped with both a 60 hp pump and a 75 hp pump. Either pump can be operated individually, or both pumps can be running at the same time for models requiring higher flow-rates. All water being pumped into the constant head tank that is not used in the laboratory overflows into one of two holding tanks which drain into the underground reservoir. The decision to overflow into either holding tank is done using a flip gate that deflects water into the desired tank, which can be manually controlled using valve attached to a compressed air cylinder. The procedure used to measure discharge and pump capacity includes closing one of the holding tanks, diverting the overflow into that tank, and measuring the length of time it takes to partially fill. A dial gauge attached to a float that has been calibrated knowing the dimensions of the tank then allows one to determine the volume of water that entered the tank and dividing this volume by the time it took for that water to enter yields the discharge. The pump capacity is taken as the overflow discharge when no water is being drawn out of the head tank. The discharge of water entering a hydraulic model is then obtained by subtracting the overflow discharge measured while water is running through the model at a constant rate from the previously measured pump capacity.

While these experiments were being completed, some difficulty was encountered when attempting to quantify the discharges. It was discovered that the discharge capacity of the two pumps, which supply water to the constant head tank, varies depending on the

reservoir water level. Once this was determined, all experiments were run with the same initial reservoir water level and all pump capacity measurements were taken with the upstream model reservoir full as well. Despite keeping these water levels consistent there was still some small fluctuation in the capacities of the pumps from day to day. The 60 hp pump had a capacity that ranged from approximately 227 to 230 l/s while the 75 hp pump ranged from about 281 to 287 l/s. These fluctuations are likely due to changes in the reservoir water temperature and thus in an attempt to obtain results as accurately as possible, it was decided to take pump capacity measurements directly after completing all sets of experiments.

4.2.3 Combined Pump Capacity Reduction

Another problem that was encountered was a reduction in pump capacity when using both pumps at the same time. Some of the experiments required discharges greater than the capacity of either pump alone and in those cases, both pumps were required. The problem was that the flip gate would not operate under the added water pressure that occurs when both pumps are running, and this did not allow the usual method of determining pump capacity. One can still get the capacity of each pump on its own and then add them together, however, this does not take into account any possible reduction in capacity resulting from having both pumps running at once. This reduction could be either a result of direct interference between the suction of the two pumps or a result of a lower reservoir headwater level due to a greater amount of storage in both the head tank and the holding tanks.

To solve this problem a test was devised to quantify any reduction in capacity. A model headwater level was selected such that the 75 hp pump alone could provide the required discharge. This model discharge was measured and then the second pump was turned on. Once again, the model discharge was measured assuming capacity was equal to the total of two pumps. As expected, the model discharge measured when using both pumps was about 4.7 l/s higher than when using only the 75 hp pump. Also, although the laboratory is equipped with a constant head tank, there is a slight change in head that results when adding the entire discharge of the 60 hp pump. This then caused a 0.9 mm increase in the headwater level in the spillway model as well. This head increase of 0.9 mm, however, only corresponds to an approximate 1.3 l/s increase in discharge according to design equations. Subtracting this from the 4.7 l/s higher that was measured and there remains about 3.4 l/s that must be a result of an over-estimate in the capacity of the two pumps that occurred from assuming that the total capacity is equal to the addition of the separate pump capacities. As a result of this, all measurements taken with both pumps running were reduced by 3.4 l/s to account for the combined pump interference.

4.2.4 Water Surface Profile Measuring Device

In order to measure the water surface profiles in the physical model, a device was constructed to move both vertically as well as horizontally along the centre-line of one of the spillway bays. The device, shown in Figure 4.3, consisted of a vertical moving dial gauge attached to a pointed steel rod used to locate the water surface. This mechanism was then mounted on a horizontal dial gauge that traverses a rectangular steel ruler that was aligned with the centre-line of the second spillway bay. Both dial gauges were

equipped with a Vernier scale allowing vertical reading to be made with 0.2 mm accuracy while the horizontal readings had an accuracy of 0.001 ft or about 0.3 mm. In order to verify that the device was properly leveled, measurements of the spillway surface were made and compared to the design equations for the spillway surface. As shown in Figure 4.4, the measured profile that is represented by the points nearly overlaps the equation that is displayed as the line.

4.3 Physical and Numerical Modeling

4.3.1 Free Overflow Tests

The first experiments conducted were aimed at measuring the free overflow discharge rating curve as well as water surface profiles for several different headwater levels. The physical modeling was conducted first such that the headwater levels could be set to approximate levels and then recorded allowing the levels to be specified in the numerical model. The method was considered to be much more efficient than trying to obtain an exact headwater level by manually adjusting the butterfly valve controlling inflow to the physical model until an exact headwater level was achieved. The rating curve obtained from the physical modeling consisted of 9 headwater levels with corresponding discharges. Measured headwater levels included an approximate of both the probable maximum flood (PMF) of 15.7 m above the crest and the design headwater level (H_d) of 14.6 m above the crest, as well as 7 headwater levels ranging between the crest level and the design head. At the same time as the discharge measurements were taken, water surface profiles were measured for three headwater levels, including one at design head

and two at lower headwater levels. The reproducibility of the discharge measurements was also verified by obtaining a second rating curve on a separate day and comparing the two curves. The plots were found to nearly overlap, providing adequate confidence in the physical model measurements.

Once the physical model measurements were obtained and verified, a numerical model was prepared. An Autocad drawing was set-up and imported into the software for the remainder of the model parameters to be inputted. It should be noted that original simulations were completed using a model geometry provided by Manitoba Hydro and Acres Manitoba Ltd. Due to some discrepancies found when comparing water surface profiles when using this model, a new model geometry file was prepared. For each simulation, the headwater level was specified to be the same as the values measured in the corresponding physical model experiments. As was done with the simulations introduced in the previous chapter, a 1 m mesh was used initially until the flow became steady. Following this, the mesh was refined to 0.5 m and although some simulations were subsequently run with a finer mesh, the changes in discharge were minimal when a mesh smaller than 0.5 m was used. As shown in Table 4.1, Flow-3D significantly underestimates the discharges observed by the physical model for this spillway. In fact, the difference between the two types of modeling may exceed the error that could be associated with the physical modeling. A comparison of these discharge rating curves is also provided in Figure 4.5 along with the rating curve measured in the original study that used the physical model completed by Ye (2004). In this figure, it is surprising to see that the physical model curve measured in this study differed slightly from the one measured

in the original study. In fact, as shown in Figure 4.6, the new physical model rating curve nearly overlaps the previously measured curve when decreased by a factor of 2.5 percent. The reason for this discrepancy is unknown and although seems somewhat strange, extreme care was taken when constructing the physical model as well as while conducting the experiments. Although a difference of 2.5 percent could reasonably be explained as being a result of physical model error, it should be re-iterated that the newly measured rating curve was completely measured on two separate days and the two rating curves were found to be in excellent agreement.

Table 4.1 Comparison of measured Conawapa physical model discharge to Flow-3D.

Multiple of H_d	Head (m)	Physical Model (m^3/s)	1 m mesh		0.5 m mesh	
			CFD (m^3/s)	Diff. (%)	CFD (m^3/s)	Diff. (%)
0.20	2.91	971	879	-9.5	851	-12.4
0.34	4.93	2042	1962	-3.9	1942	-4.9
0.47	6.91	3523	3359	-4.7	3311	-6.0
0.61	8.96	5288	5096	-3.6	5000	-5.4
0.75	10.90	7266	6916	-4.8	6807	-6.3
0.89	12.93	9658	9094	-5.8	8936	-7.5
1.00	14.58	11859	10987	-7.4	10805	-8.9
1.08	15.70	13583	12362	-9.0	12187	-10.3

Simulations were also completed to obtain comparisons of water surface profiles. As mentioned above, initial simulations were completed using a model geometry file provided by Manitoba Hydro and a problem was encountered when comparing water surface profiles. Shown in Figure 4.7 is one of two numerical model profiles that were not in agreement with the physical model data. This prompted further examination of the geometry in Flow-3D, where a flawed roadway surface was apparent in the numerical

model. As a result, a new spillway geometry file was prepared based on equations that were used to construct the physical model. Following this, additional simulations were completed in which water surface profiles were obtained for the three headwater levels that had profiles recorded during the physical modeling. The three headwater levels include one at approximately the design head, one at about three quarters of the design head, and one at about a third of the design head. Comparisons of data between the two types of modeling are provided in Figure 4.8 and in general the profiles overlap exceptionally well. The fact that the water surface profiles obtained with the newly developed geometry were in excellent agreement with physical model data provided confidence that the numerical model was now properly prepared. This new geometry file was then used to re-simulate for the discharge rating curve, which also resulted in an improved comparison to physical model discharges. Note that only discharge data obtained with the new geometry is presented in this thesis.

4.3.2 Gated Discharge Modeling

Physical modeling was also conducted to obtain discharge at design head for various gate openings. Since the flow depth was measured to be approximately 10 m at the location of the gate in prototype scale, the selected prototype gate openings were 2, 4, 6, and 8 m. Each of the discharge measurements were taken with one of the full bays and both half bays sealed off, with flow through only the second bay of the physical model. This was also the bay equipped with the water surface profile measuring device and so the water profile downstream from the gate was also recorded for the experiment conducted with the 4 m gate opening.

A similar set-up was prepared for the numerical model simulations in that only one gate was left open. A major difference, however, was that the numerical model only consisted of one bay and two closed half bays as shown in Figure 4.9, while the physical model comprised of one full bay open, and one full bay closed, surrounded by two closed half bays. Based on comparisons of simulations with different bay configurations discussed in chapter 3, these model differences are not expected to have an effect on the data comparison. Table 4.2 provides a comparison between the measured physical model discharge at near design head for the 4 different gate openings along with corresponding Flow-3D values obtained with an incrementally more refined mesh configuration.

Table 4.2 Gated Conawapa physical model test to Flow-3D discharge comparison.

	2m Opening		4m Opening		6m Opening		8m Opening	
	Q (m³/s)	% Diff	Q (m³/s)	% Diff	Q (m³/s)	% Diff	Q (m³/s)	% Diff
Physical Model	2102	--	4137	--	5953	--	7736	--
Flow-3D (1m mesh)	2601	23.7	4556	10.1	6368	7.0	8161	5.5
Flow-3D (0.5m mesh)	2419	15.1	4344	5.0	6153	3.4	7949	2.8
Flow-3D (0.5-0.25m mesh)	2275	8.2	4176	0.9	6013	1.0	7788	0.7
Flow-3D (0.5-0.25-0.13m mesh)	2118	0.8	4001	-3.3	5775	-3.0	7539	-2.5
Flow-3D (0.4-0.2-0.1m mesh)	2065	-1.8	3927	-5.1	5681	-4.6	7504	-3.0

The percent difference between the physical and numerical model is also provided and it can be seen that there are reductions in the Flow-3D discharge right down to the smallest nested mesh arrangement shown in the table. Also notice that the use of nested meshing once again caused significant changes to the discharge obtained in the Flow-3D model. In

the end, the comparisons were reasonably good with the nested 0.5-0.25-0.125 m mesh arrangement; the largest difference for this mesh arrangement (3.3 percent) was obtained with the 4 m gate opening while better comparisons occurred for the 2, 6, and 8 m gate openings. Simulations with an even further reduction in mesh size became difficult to complete, although one was finished with the model set at a 4 m gate opening and resulted in only a negligible change in discharge. Since it was observed that different mesh sizing resulted in better comparisons for different gate openings, a scaling parameter of gate opening over mesh size was examined. It was thought that there may be an optimum gate opening over mesh size ratio that would provide accurate discharges as compared to physical modeling for all gate openings, however, the data did not provide a correlation. Since the gate opening was the only thing to change throughout these simulations, there is not believed to be a scaling parameter for this data. As a result, it should be noted that when running numerical simulations one should, whenever possible, reduce the mesh size until the results no longer change significantly (1-2 percent). Figure 4.10 displays the comparison of water surface profiles obtained with the two types of modeling for a 4 m gate opening. The data are in good agreement, however, note that physical model data was only obtained downstream of the gate.

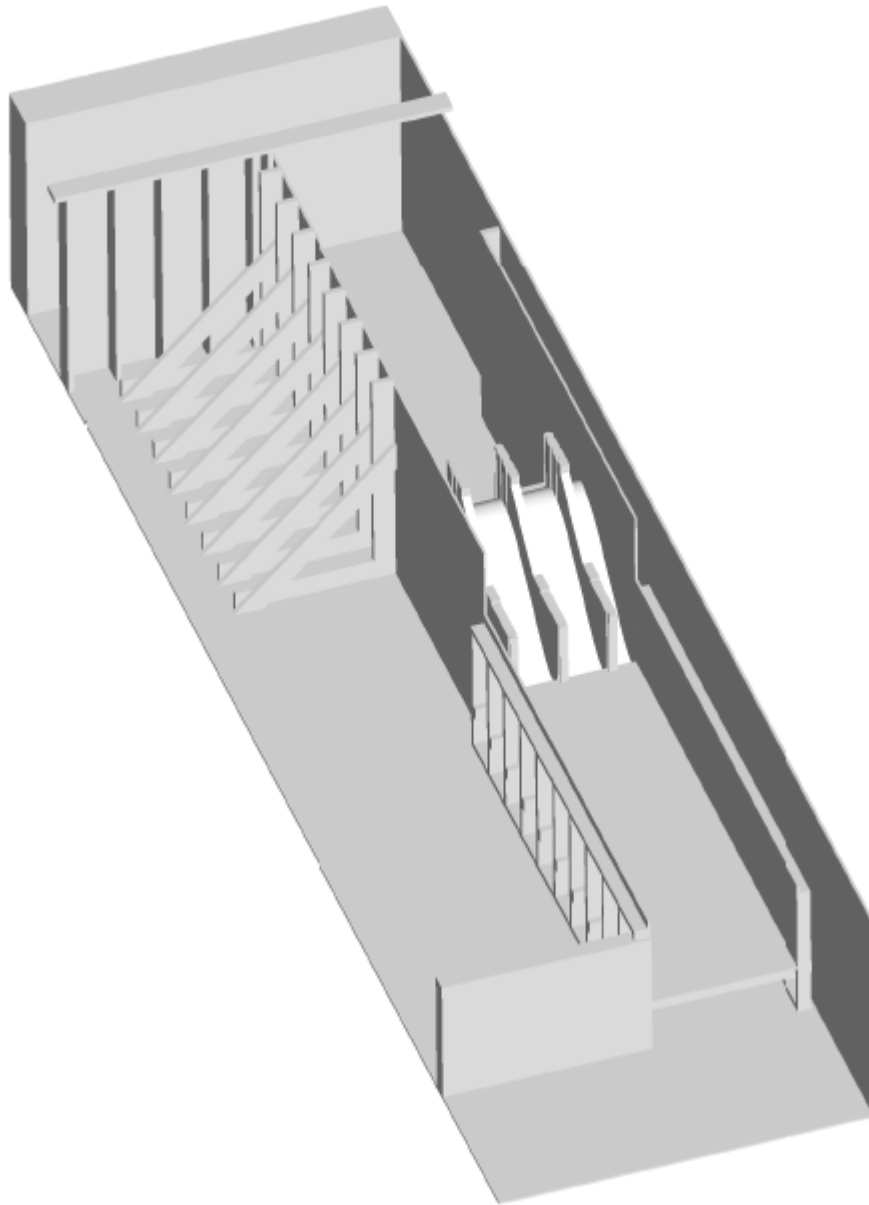

Figure 4.1 Auto-Cad drawing developed to visualize set-up and order material for installation of the Conawapa-like physical model.



Figure 4.2 Installed Conawapa-like physical model running with design head.

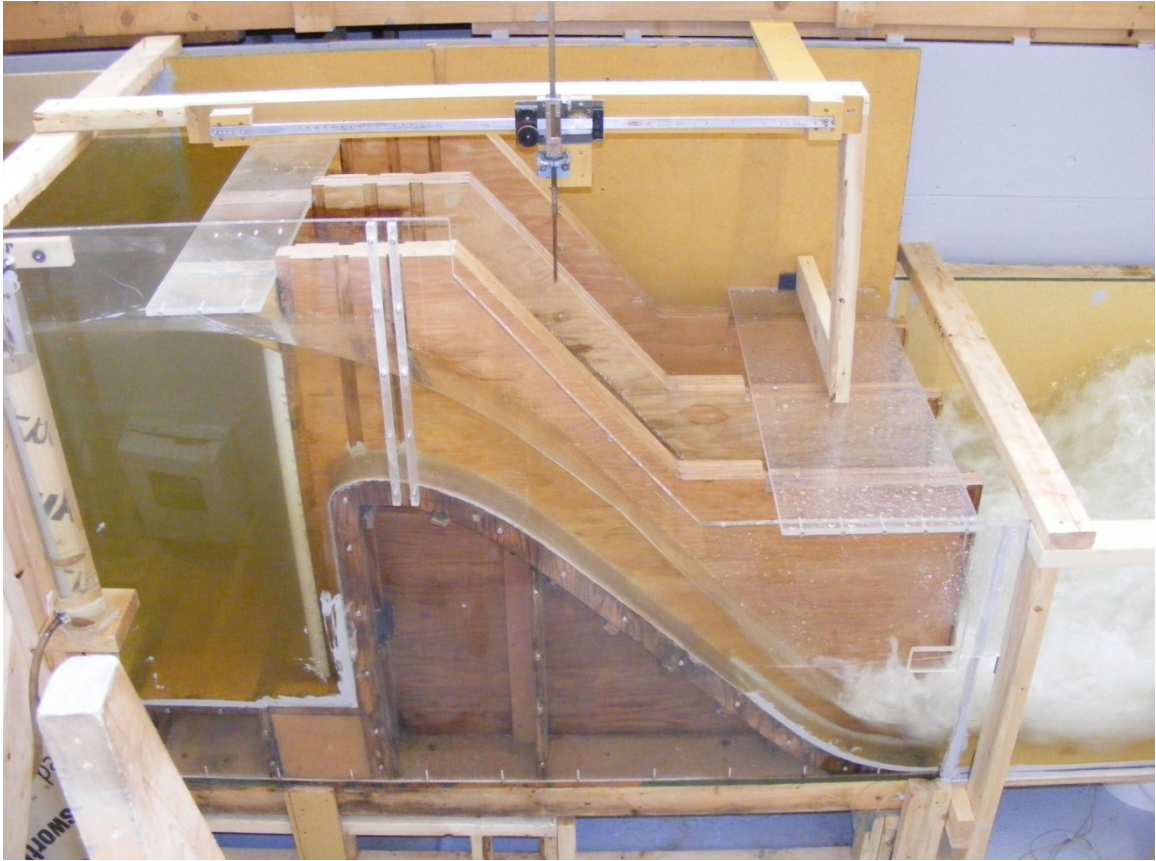

Figure 4.3 Side view of physical model showing water surface measuring device with water flowing at design head.

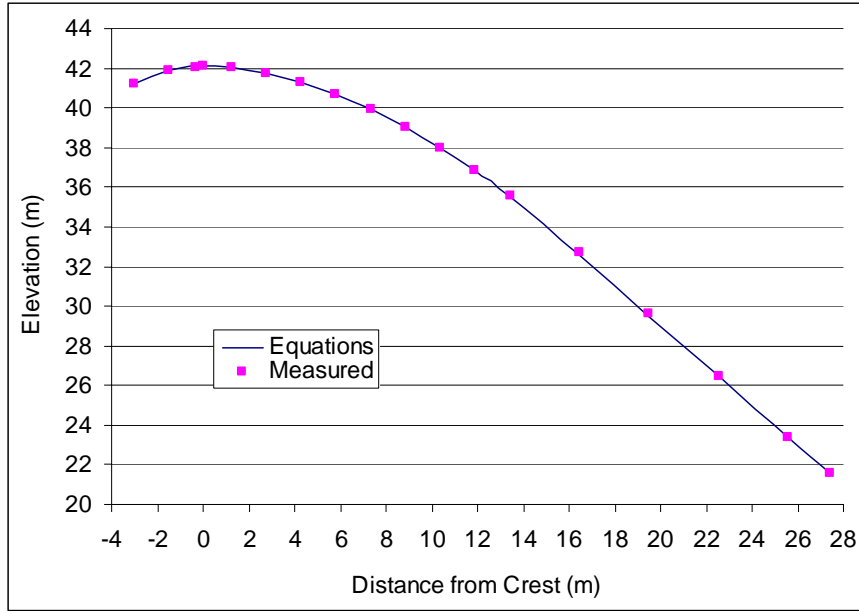

Figure 4.4 Verification of water surface profile measuring device by comparing the measured spillway surface with design equations.

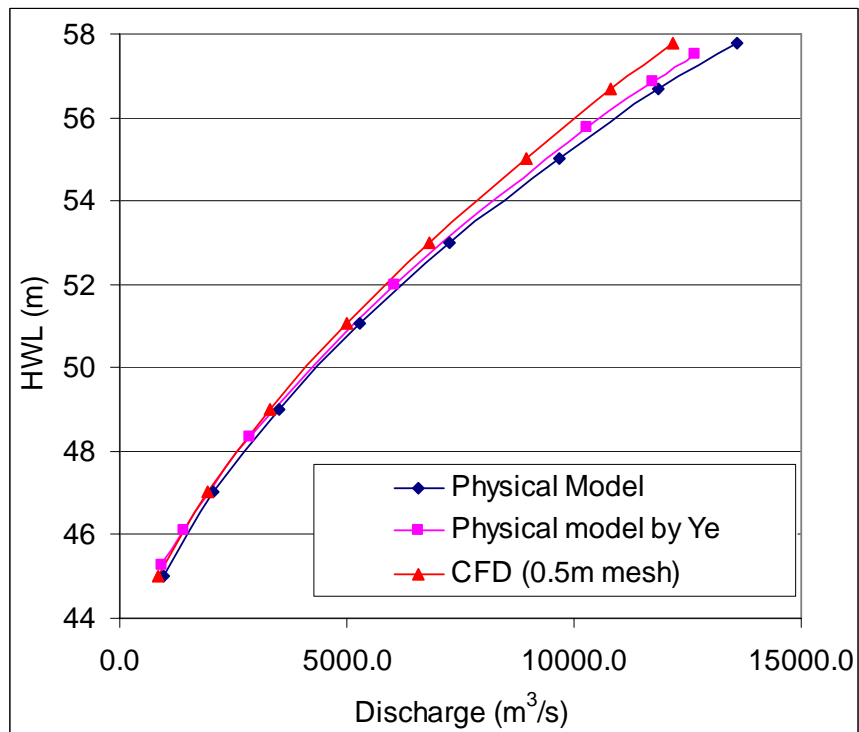

Figure 4.5 Comparison of newly measured physical model discharge rating curve for the Conawapa-like spillway to data obtained with Flow-3D and the rating curve from the original study completed with the identical spillway model (Ye, 2004).

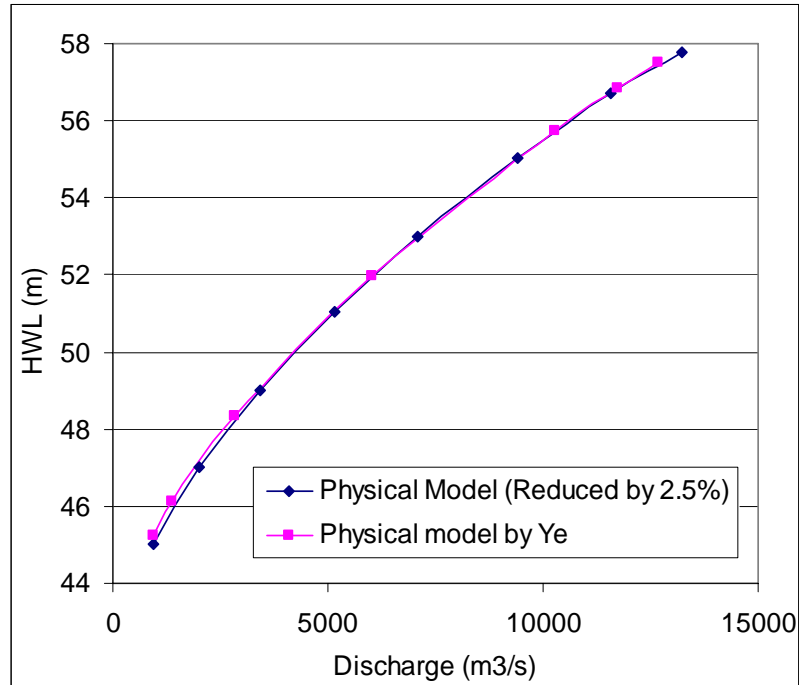

Figure 4.6 Comparison showing newly measured physical model discharge rating curve for the Conawapa-like spillway reduced by 2.5 percent to the rating curve from the original study completed with the identical spillway model (Ye, 2004).

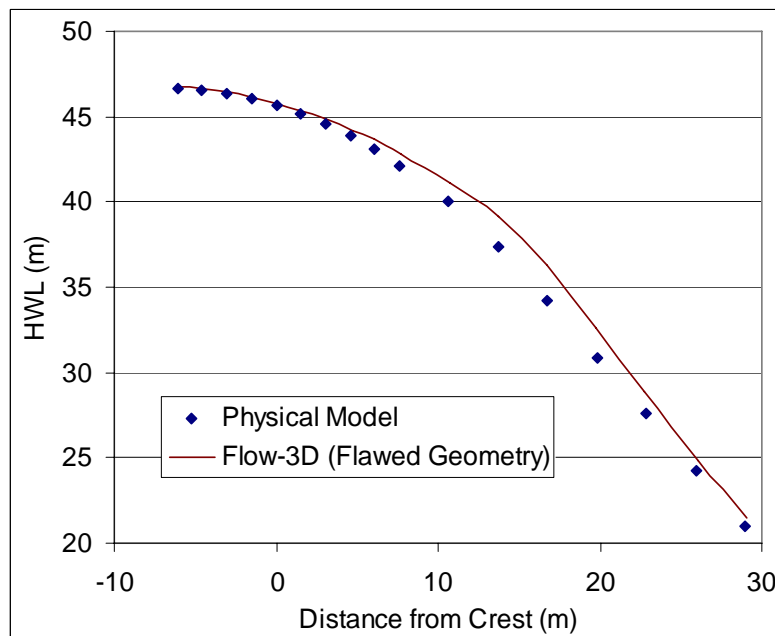

Figure 4.7 Comparison of measured physical model water surface profiles for the Conawapa-like spillway to data obtained with the flawed Flow-3D geometry.

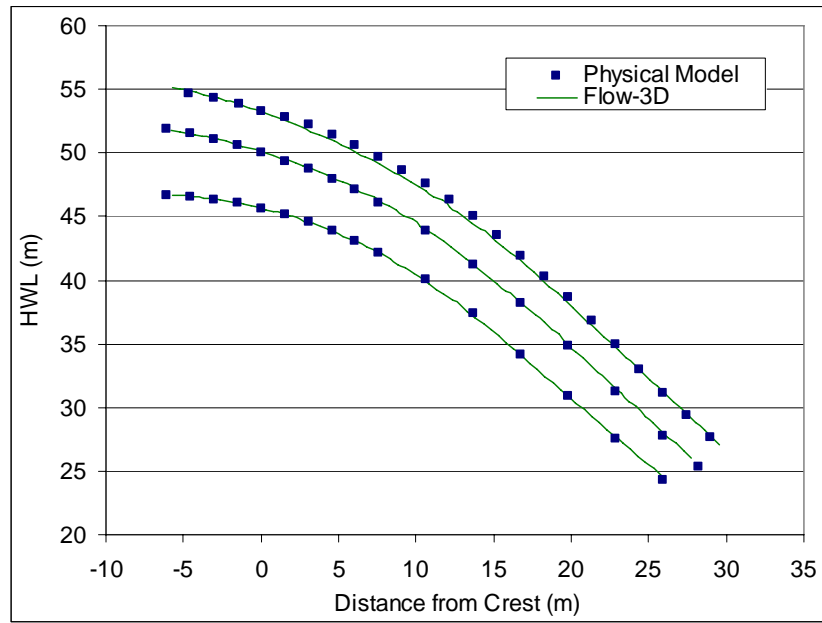

Figure 4.8 Comparison of measured physical model water surface profiles for the Conawapa-like spillway to data obtained with Flow-3D for 3 different headwater levels.

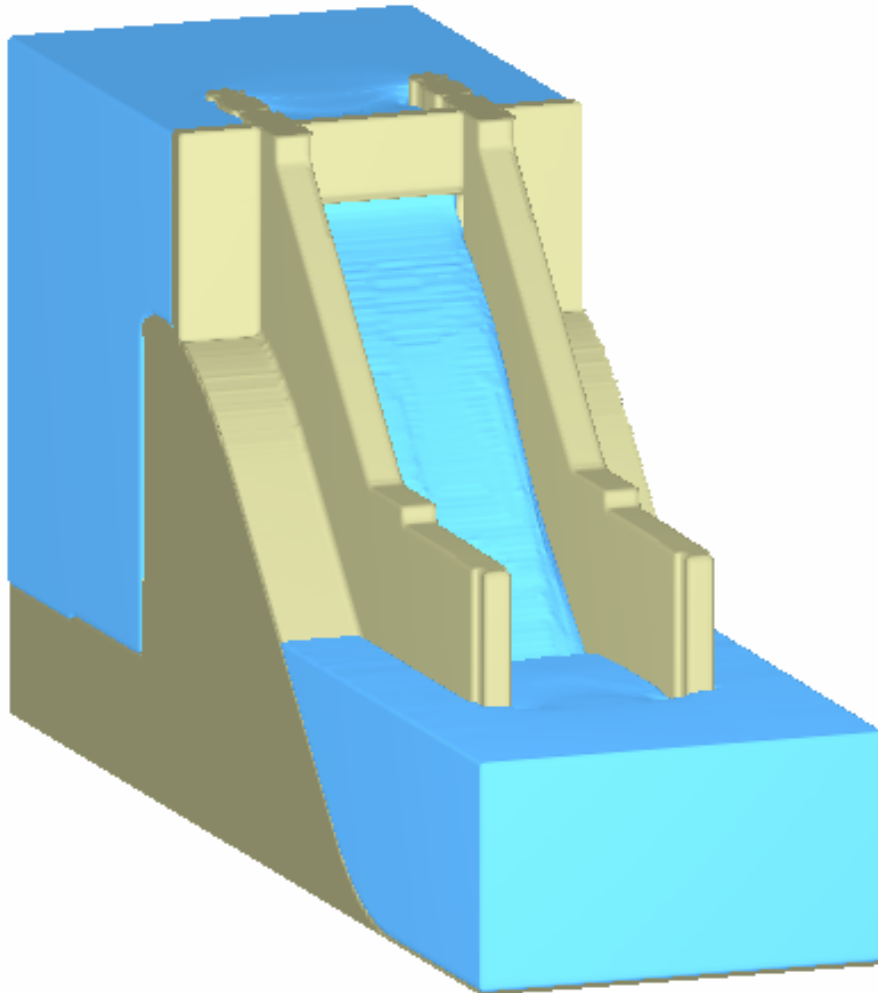

Figure 4.9 Conawapa numerical model set-up replicating the physical model test with an 8 m gate opening.

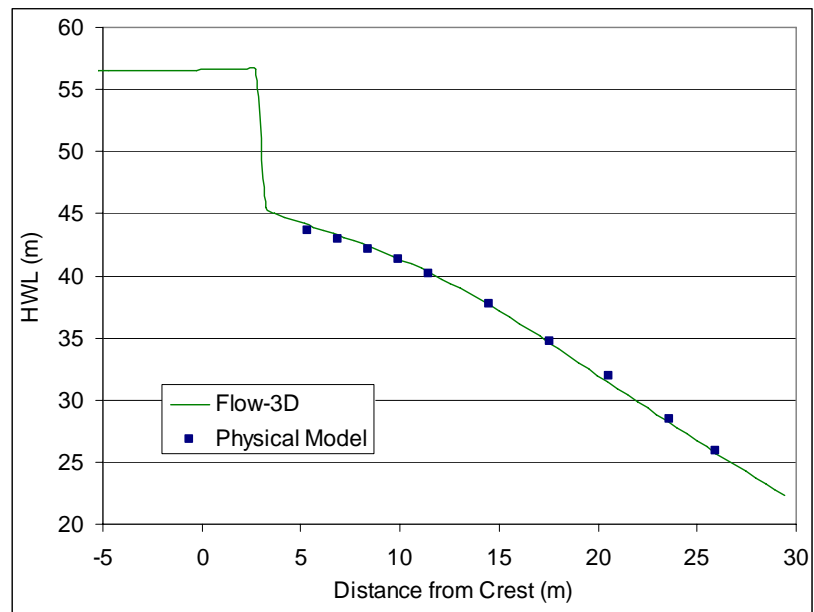

Figure 4.10 Comparison of the physical model water surface profile shown by the points to the Flow-3D profile shown by the line for a 4 m gate opening.

5.1 Introduction

The amount of time a simulation will take to reach steady-state varies depending on a multitude of different things. Obviously the size and type of problem being modeled as well as the mesh resolution and mesh block configuration has the greatest impact on simulation time. The other major factor affecting simulation times is the type of computer used for the simulations and in this study, all simulations were completed on a state-of-the-art quadruple core multi-processor computer. There are, however, many other areas of the Flow-3D model that can have a major impact as well. This includes the number of fluids being modeled, whether the flow is assumed to be incompressible, as well as the types and amount of physics options being applied to the problem. Other things that could have an effect on simulation time include the boundary and initial conditions implemented. This means that a re-run is quite different from an initial simulation as it will begin with fluid flowing steadily throughout the entire domain. A major impact on

simulation time also lies in the selection of different numeric options which were introduced in the Numerical Simulation Options section of Chapter 2.

In all the simulations conducted for this study, one fluid was modeled and assumed to be incompressible. Another option that remained generally constant was that of boundary conditions. Although there was some diversity between the different models as to the boundaries in the direction perpendicular to the flow, the main upstream and downstream boundary conditions were set as specified fluid height in all simulations. In the physics tab, gravity being applied in the negative z-direction remained constant, however, when verifying the effect of different turbulence models some variance in simulation time was observed. As expected, keeping all other things constant, the simpler one-equation models ran fastest while the large eddy simulation model (LES) took longest to simulate. The two equation k-e model ran faster than the RNG model but the RNG model was still used for all other simulations as discussed in chapter 2.

5.2 Effects of Numeric Options

A variety of different numerical options were attempted in an effort to determine the most efficient and accurate solvers for the spillway modeling. Comparative simulations were run with both the default SOR and the new GMRES solver. In general it was found that the default SOR pressure solver would run slightly faster and yielded the same desired results, however, it was found that only the more advanced GMRES pressure solver would allow the solution to converge when conducting gated simulations with

nested meshing. All simulations were also run using the default explicit solvers selected for calculating viscous stress and advection. Different combinations of the explicit and implicit solvers were also attempted when only the steady-state results were desired, however, the changes had little effect on simulation time. The reason for restricting the use of implicit solvers to simulations where only the final steady-state solution is required is that the unsteady portion of the modeling is not always accurate when using implicit solutions. A possible explanation for the lack of improvement in computational time when using the implicit solvers is that although the implicit solvers can run faster as they have larger time steps, some of the implicit solvers are not encoded for parallel computation. Since the explicit solvers were designed to run with parallelization and a multi-processor workstation was used for all simulations, this could explain why the implicit options offered little to no improvement in simulation time in this instance. Also, as mentioned in chapter 2, some attempts were made at trying to improve simulation results by using the Lagrangian VOF options. Use of these solvers ran significantly longer than the default selection while offering negligible improvements to the solution.

5.3 Effect of Mesh Size and Configuration

The variable that displayed the biggest affect on simulation time was the size of the problem domain and the mesh resolution. In other words, it was the number of cells that played the biggest role in determining the length of time required to complete a simulation. In an attempt to quantify the length of time required to conduct a given simulation, the number of active cells as well as the length of time required to run one

second of a simulation was recorded for almost all of the runs completed. The number of simulation seconds required for a run to become stable is something that varied depending on the simulation and whether the run was a restart simulation. In general initial simulations would take anywhere from 50 to 150 seconds, while restart simulations could be reduced to between 10 and 30 seconds. In logging the time data, a distinction was made between simulations with only one mesh block and simulations with multiple mesh blocks. Figure 5.1 provides this data plotted with logarithmic axes to provide better visualization of the entire data set. Also included on the figure are the best fit power regression lines and the corresponding equations that can be used to provide a rough estimate of a simulation time given the number of active cells and the length of simulation time desired. The large amount of scatter apparent in the figure is due to a variety of factors. This includes variations in turbulence and numeric options as previously discussed as well as the number of nested meshes used in the simulations making up the multiple mesh line. Also, during certain simulations data from previous numerical modeling was being recorded and at times, models for subsequent runs were being prepared. This diversity in the amount of computer usage during simulations as well as possible computer updates may have also been the cause of some of the scatter in the figure. It should again be noted that the affect of using mesh designs with various aspect ratios was not examined in this study, although could be a factor in simulation times.

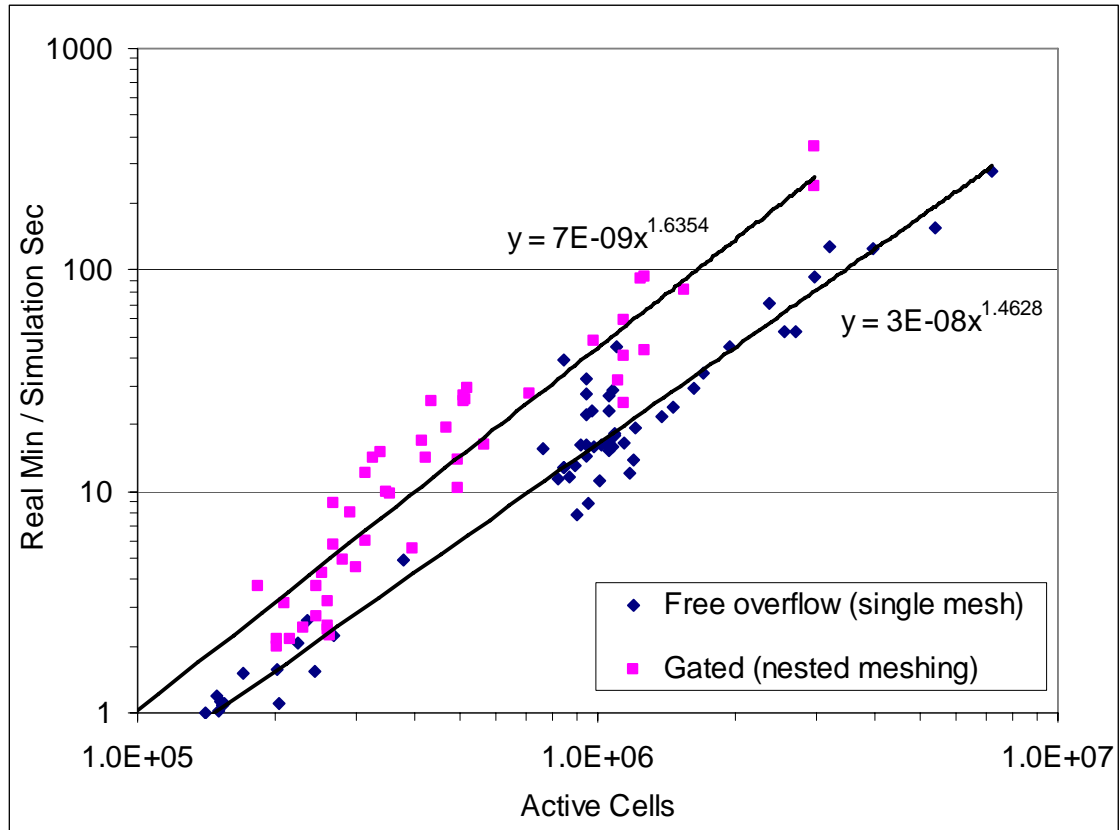

Figure 5.1 A plot of the number of active cells against the amount of real minutes required to simulate one second using data from all Flow-3D spillway modeling conducted

6.1 Summary

The use of numerical models has been increasing in many engineering applications over the past decade. Numerical models can presently provide a cost affective alternative to historic design methods and are able to provide additional insight that may not be apparent in physical model testing. Although numerical models are developed based on equations describing the underlying physics of a given situation, the models must still be verified against either established design guidelines or physical model experiments. Often an approach that makes use of both types of modeling can be beneficial. Numerical modeling to optimize the design, and physical modeling to verify the final configuration. The requirement for model validation is no different for numerical models developed for solving fluid flow. Despite successful applications of computational fluid dynamics to modeling fluid flow over a range of spillways in the literature, this thesis has documented additional comparisons of the CFD software Flow-3D to both new and old physical

model experimental data. Specifically, this study has looked into the capability of Flow-3D to model not only one specific spillway, but a variety of different ogee crested spillways.

Initially, comparisons were completed for three different spillways on which physical model testing had previously been conducted. Throughout this portion of the study, comparisons of free overflow and gated discharges, water surface profiles, and pressures over the roadway were compared between physical and numerical modeling. The three spillways tested included a preliminary design for the Wuskwatim and Limestone generating stations, as well as the 1992 version of the Conawapa-like spillway. Each of these spillways had a significantly different spillway height to design head ratio, allowing confirmation of the ability of CFD to model three different spillways. This also allowed us to look at the affect that the P/H_d ratio had on comparisons of discharge between the two types of modeling.

Discharge comparisons that were executed for these three models starting with un-gated flow conditions. For each of the three spillway numerical models, flow-rate was obtained for a range of headwater levels in order to provide a comparison of the entire discharge rating curve. The Flow-3D values were within 5 percent of the old physical model data for all comparisons except for the two lowest headwater levels examined for both the Wuskwatim and Conawapa-like spillways. A 0.5 m uniform mesh was found to provide this relatively good discharge comparison for each of the spillways and any further reductions in mesh size had a negligible impact on flow-rate. This was found to change

drastically when comparing discharges with various gate openings. For gated flow simulations, a uniform 0.5 m mesh produced discharge that was approximately 15 percent away from physical model values in the case of the Wuskwatim spillway. As a result, use of nested meshing was commenced as it was thought that more resolution was required to capture the flow detail surrounding the gate. Use of nested meshing led to significant improvements in the flow comparisons and for the majority of simulations conducted, the two types of modeling were within 5 percent. It should be noted, however, that there were still several simulations where discharge remained greater than 5 percent different from the physical model values. In fact, in the worst case of a 1m gate opening for the Conawapa-like spillway, differences in discharge between the two types of modeling exceeded 20 percent. An interesting conclusion that was drawn from both the free overflow and gated simulations was that the difference between the Flow-3D and physical model flow-rates exhibited a P/H_d dependency. For the three spillways examined, the discharge from the numerical model was found to decrease relative to the corresponding physical model data as the spillway's P/H_d ratio increased.

These same spillway models were also used to obtain comparisons of water surface profiles. Flow-3D was found to provide a water surface along the centre-line of the spillway bay that at all but a few select locations successfully overlapped the physical model data for each spillway. Comparisons were completed for one headwater level for the Wuskwatim and Conawapa-like spillways and for two different headwater levels for the Limestone spillway. Simulations to obtain these profiles were conducted using slightly smaller mesh dimensions than for the discharge comparisons. Smaller mesh sizes

were also used to perform the comparisons of rollway pressures that were completed for only the Wuskwatim and Limestone structures. From these evaluations, it was found that Flow-3D did not replicate the physical model data, however, it was capable of providing the general trend of the physical model pressures.

In order to further supplement the comparisons that were completed between Flow-3D and the three older physical model studies, some additional physical modeling was conducted on physical model that replicated a newer version of the Conawapa spillway. The previously used model was refurbished and installed in the Hydraulics Research and Testing Facility. The free overflow physical modeling that was completed included measurement of a discharge rating curve and water surface profiles for three different headwater levels. Flow-3D was found to produce water surface profiles that nearly overlapped the physical model, however, the simulated discharges were about 5 to 10 percent lower than the physical model. Some gated physical modeling was also conducted and discharges from four different gate openings were discovered to be within approximately 5 percent of Flow-3D values by using nested meshing. A comparison of one water surface profile downstream from the gate was also successful for a gate opening of 4 m.

Different aspects of the Flow-3D software were introduced and discussed in chapter 2 and the effect of some aspects as well as the number of cells and mesh blocks on simulation times was introduced in chapter 5. Throughout all of the numerical modeling, simulation times and the number of active cells was recorded along with the mesh

configuration. Overall, it was found that given the number of active cells and whether a single mesh or multiple mesh blocks were included in the simulation, there was a power law relationship that could be used to estimate the number of minutes it would take to run a simulation for one second.

6.2 Conclusions

The evaluation of the ability of the CFD software Flow-3D to model spillway flow behaviour proved to be quite successful. In general, it seems that Flow-3D can accomplish nearly the same results as a set of physical model experiments. The following conclusions can be drawn from this study:

- 1) Flow-3D is generally capable of providing spillway discharges that are within the accuracy of physical model experimental data. This was found to be true for both free overflow simulations as well as experiments with a variety of different gate openings.
- 2) Flow-3D can successfully model a spillway's water surface profile for a variety of headwater levels and different gate openings as compared to physical model testing.
- 3) The general trend of physical model spillway surface pressure data can be achieved using computational fluid dynamics.

- 4) The difference between Flow-3D and physical model flow-rates exhibited a spillway height to design head ratio (P/H_d) dependency. In general, it was observed that numerical model discharges reduced as compared to physical model data when the spillways P/H_d ratio was increased.
- 5) The required mesh refinement and configuration varies depending on the type of data desired. In general, a 0.5 m mesh was sufficient for modeling free overflow discharges, while smaller mesh sizes were required for water surface profile and pressure measurements. It was also discovered that nested meshing significantly improved Flow-3D discharges as compared to physical modeling for gated spillway operation.

6.3 Future Recommendations

Although this study has provided supplementary confidence in the capabilities of numerical modeling, there remains uncertainty as to the extent to which CFD can be safely applied. The degree of accuracy that any model, both physical and numerical, replicates an actual constructed spillway also remains largely unknown. The following recommendations are aimed at further progressing the state of CFD in the hydro-electric industry:

- a) Develop a set of physical model experiments that focus on measuring velocity and pressure profiles over the crest of a spillway as well as a broad crested weir.

Perform some corresponding numerical modeling to examine the ability of Flow-3D to replicate the measurements. This would allow verification of the ability of Flow-3D to replicate pressure and velocity patterns in both hydrostatic and non-hydrostatic flow conditions.

- b) Perform a series of site investigations of spillways in operation at various generating stations throughout Manitoba. At each site, conduct measurements of actual prototype data to compare to old physical model experimental data and Flow-3D values.
- c) Conduct some physical modeling of pressure measurements at critical locations of a spillway and stilling basin. Use the data to evaluate the capability of Flow-3D to predict the occurrence of negative pressure and cavitation.
- d) Perform similar physical to numerical model comparisons for ogee crested spillways with different P/H_d ratios in order to verify the trend that was found in the discharge comparisons presented in this report.
- e) Evaluate the use of elliptical crests under gated spillway operation to investigate the nappe and the occurrence of cavitation potential.

References

Bouhadji, L. 2004. Three Dimensional Numerical Simulation of Turbulent Flow Over Spillways. ASL-AQFlow Inc., Sidney, British Columbia, Canada.

Cederstrom, M. et al. 1998. CFD modeling of spillway capacity – A comparison between hydraulic and mathematical models. Dam Safety, Balkema, Rotterdam.

Cederstrom, M. et al. 2000. Modelling of Spillway Discharge Capacity with Computational Fluid Dynamics (CFD). ICOLD 20th Congress on Large Dams.

Chanel, P.G., Doering, J.C. 2007. An assessment of spillway modeling using computational fluid dynamics. Canadian Journal of Civil Engineering. Manuscript number 07-260.

Chanel, P.G., Doering, J.C. 2007. An Evaluation of Computational Fluid Dynamics for Spillway Modelling, The 16th Australasian Fluid Mechanics Conference, 2-7 December 2007, Gold Coast, Australia.

Cook, C., Richmond, M., Serkowski, J., Ebner, L. 2002. Free-Surface Computational Fluid Dynamics Modeling of a Spillway and Tailrace: Case Study of The Dalles Project. In Hydrovision 2002, paper no. 120. HCI Publications, Kansas City, MO.

Dargahi, B. 2006. Experimental Study and 3D Numerical Simulations for a Free-Overflow Spillway. ASCE, Journal of Hydraulic Engineering **132**: 899-907

Flow Science, Inc. 2007. Flow-3D User's Manuals, Version 9.2, Santa Fe, NM.

Gessler, D. 2005. CFD Modeling of Spillway Performance, EWRI 2005: Impacts of Global Climate Change, In Proceedings of the World Water and Environmental Resources Congress, Anchorage, Alaska. 15-19 May 2005. Edited by R. Walton. American Society of Civil Engineers.

Hirt, C.W., Nichols, B.D. 1981. Volume of Fluid (VOF) Method for the Dynamics of Free Boundaries, Journal of Computational Physics **39**: 201-225

Hirt, C.W., Sicilian, J.M. 1985. A Porosity Technique for the Definition of Obstacles in Rectangular Cell Meshes. In Proceedings of the 4th International Conference on Ship Hydro-dynamics, 24-27 September 1985, National Academic of Sciences, Washington DC.

Ho, D., Boyes, K., Donohoo, S., Cooper, B. 2003. Numerical Flow Analysis for Spillways. 43rd ANCOLD Conference, Hobart, Tasmania, October 24-29.

Ho, D., Cooper, B., Riddette, K., Donohoo, S. 2006. Application of Numerical Modelling to Spillways in Australia. In *Dams and Reservoirs, Societies and Environment in the 21st Century*. Edited by Berga *et al.* Taylor and Francis Group, London.

Ho, D., Boyes, K., Donohoo, S. 2001. Investigation of Spillway Behavior under Increased Maximum Flood by Computational Fluid Dynamics Technique. 14th Australian Fluid Mechanics Conference, Adelaide University, Adelaide, Australia. December 10-14.

La Salle Consulting Group Inc. 1992. Conawapa Generating Stations, Sectional Model Study of the Spillway. Montreal, Quebec.

Lemke, D.E. 1989. A Comparison of the Hydraulic Performance of an Orifice and an Overflow Spillway in a Northern Application Using Physical Modeling, M.Sc. Thesis, University of Manitoba, 1989.

Northwest Hydraulic Consultants Ltd. 1992. Conawapa Generating Station Hydraulics Model Study. Vancouver, B.C.

Sartaj, M., Beirami, M., Fooladgar, A. 2006. Analysis of Two-Dimensional Flow over Standard Ogee Spillway Using RNG Turbulence Model. 7th International Congress on Civil Engineering.

Savage, B.M., Frizell, K., Crowder, J. 2004. Brains versus Brawn: The Changing World of Hydraulic Model Studies. ASDSO Annual Conference 2004. Phoenix, Arizona.

Savage, B.M., Johnson, M.C. 2001. Flow over Ogee Spillway: Physical and Numerical Model Case Study, *Journal of Hydraulic Engineering*, **127**: 640-649.

Savage, B.M., Johnson, M.C, and Geldmacher, R. 2001. Comparison of Physical Versus Numerical Modeling of Flow Over Spillways. ASDSO Annual conference 2001. Snowbird, Utah.

Teklemariam, E., Korbaylo, B, Groeneveld, J., Sydor, K., Fuchs, D. 2001. Optimization of Hydraulic Design Using Computational Fluid Dynamics, Presented at Waterpower XII, 9-11 July 2001, Salt Lake City, Utah.

Teklemariam, E., Korbaylo, B., Groeneveld, J., and Fuchs, D. 2002. Computational Fluid Dynamics: Diverse Applications in Hydropower Project's Design and Analysis. In Proceedings of the CWRA 55th Annual Conference, Winnipeg, MB, 11-14 June 2002. Cambridge, Ontario: Canadian Water Resources Association.

Teklemariam, E., Shumilak, B., Sydor, K., Murray, D., Fuchs, D., Holder, G. 2006. An Integral Approach Using Both Physical and Computational Modeling Can Be Beneficial in Addressing the Full Range of Hydraulic Design Issues. Hydrovision 2006. Copyright HCI Publications, 2006.

Western Canadian Hydraulic Laboratories Inc. 1980. Final Report, Hydraulics Model Studies Limestone Generating Station Spillway/Diversion Structure Flume Study. Port Coquitlam, B.C.

Yang, J., Johansson, N. 1998. Determination of Spillway Discharge Capacity – CFD Modelling and Experiment Verification. Accessed on August 8, 2006 from: <http://kfki.baw.de/fileadmin/conferences/ICHE/1998-Cottbus/15.pdf>

Ye, S., 2005. Adverse-Current End Sill (ACES) Study. A research report submitted to the Manitoba Hydro Research and Development Program. Hydraulics Research and Testing Facility, University of Manitoba. April 2005.