

UNIVERSITY OF MANITOBA

A STUDY OF THE LOU VERB PHRASE

A THESIS SUBMITTED TO

THE FACULTY OF GRADUATE STUDIES

IN CANDIDACY FOR THE DEGREE OF MASTER OF ARTS

DEPARTMENT OF LINGUISTICS

BY

VERNA STUTZMAN

WINNIPEG, MANITOBA

(c) FEBRUARY, 1997



National Library
of Canada

Acquisitions and
Bibliographic Services

395 Wellington Street
Ottawa ON K1A 0N4
Canada

Bibliothèque nationale
du Canada

Acquisitions et
services bibliographiques

395, rue Wellington
Ottawa ON K1A 0N4
Canada

Your file Votre référence

Our file Notre référence

The author has granted a non-exclusive licence allowing the National Library of Canada to reproduce, loan, distribute or sell copies of this thesis in microform, paper or electronic formats.

The author retains ownership of the copyright in this thesis. Neither the thesis nor substantial extracts from it may be printed or otherwise reproduced without the author's permission.

L'auteur a accordé une licence non exclusive permettant à la Bibliothèque nationale du Canada de reproduire, prêter, distribuer ou vendre des copies de cette thèse sous la forme de microfiche/film, de reproduction sur papier ou sur format électronique.

L'auteur conserve la propriété du droit d'auteur qui protège cette thèse. Ni la thèse ni des extraits substantiels de celle-ci ne doivent être imprimés ou autrement reproduits sans son autorisation.

0-612-24285-4

Canada

**THE UNIVERSITY OF MANITOBA
FACULTY OF GRADUATE STUDIES
COPYRIGHT PERMISSION**

A STUDY OF THE LOU VERB PHRASE

BY

VERNA STUTZMAN

**A Thesis/Practicum submitted to the Faculty of Graduate Studies of the University of Manitoba
in partial fulfillment of the requirements for the degree of**

MASTER OF ARTS

Verna Stutzman © 1997

**Permission has been granted to the LIBRARY OF THE UNIVERSITY OF MANITOBA
to lend or sell copies of this thesis/practicum, to the NATIONAL LIBRARY OF CANADA to
microfilm this thesis/practicum and to lend or sell copies of the film, and to UNIVERSITY
MICROFILMS INC. to publish an abstract of this thesis/practicum..**

**This reproduction or copy of this thesis has been made available by authority of the copyright
owner solely for the purpose of private study and research, and may only be reproduced and
copied as permitted by copyright laws or with express written authorization from the copyright
owner.**

Table of Contents

Table of Contents	i
List of Illustrations	iv
List of Tables	v
Abbreviations	vi
Chapter 1. Introduction	1
1.1. The Setting.....	2
1.2. Linguistic Relationships.....	7
1.3. Literature Review.....	11
1.4. Overview of Phonology.....	12
1.5. Overview of Morphology.....	14
Chapter 2. Simple Verb Phrase	20
2.1. Introduction.....	21
2.2. Aspect.....	26
2.2.1. Perfect Aspect	28
2.2.2. Imperfective Aspect	35
2.2.3. Aspect Combinations	42
2.3. Irrealis Status.....	48
2.4. Negative Polarity.....	58

2.5. Directional Aspect.....	63
2.6. Main Verbs.....	72
2.7. Adverbs.....	75
2.8. Chapter Summary.....	78
Chapter 3. Serial Verb Constructions.....	79
3.1. Introduction.....	80
3.1.1. Functions of SVCs	83
3.1.2. Types of SVCs	85
3.1.3. Layered Structure of the Clause	88
3.1.4. Juncture and Nexus	90
3.1.5. Clause Layers and Serialization	94
3.1.6. Nuclear versus Core Layer Serialization	98
(1) Nominalization	99
(2) Nuclear adverb test	100
(3) Syntactic constraints on Undergoer arguments	101
(4) Presence vs absence of pause	103
3.2. Nuclear Layer Serialization.....	104
3.2.1. Introduction	104
3.2.2. Same-Subject Nuclear Layer Serialization	109
3.2.3. Switch Subject Nuclear Layer Serialization	111

3.3. Core Layer Serialization.....	114
3.3.1. Introduction	114
3.3.2. History of Prepositional Verbs	117
3.3.3. Verbal status of Prepositional Verbs	122
(1) Function as main verb	123
(2) Co-occurs with pre-verbal particles	123
(3) Modified by adverbs	126
(4) Inflected with detransitivizing suffix	126
(5) Co-occurs with 'true' preposition	127
3.3.4. Mono-clausal nature of Core Layer SVC	129
(1) Peripheral negation	133
(2) Same-subject and object-subject constraints	136
(3) Underlying meaning differences	137
3.3.5. Same-Subject Core Layer Serialization	138
3.3.6. Switch-Subject Core Layer Serialization	139
3.4. Chapter Summary.....	143
Chapter 4. Summary.....	146
Appendix A: Sample Text	150
Bibliography	161

List of Illustrations

Figure 1. Map of Papua New Guinea.....	4
Figure 2. Map of Manus Province.....	5
Figure 3. Map of Lou Island.....	6
Figure 4. Linguistic Classification.....	8
Figure 5. Genetic Tree of Austronesian Subgroups.....	10
Figure 6. Genetic Tree of Proto Oceanic.....	11
Figure 7. Non-Existent Gap for lë.....	31
Figure 8. Anteriority/Current Relevance for ë.....	33
Figure 9. Continuative Aspect.....	36
Figure 10. Layered Structure of the Clause.....	90
Figure 11. Three Nexus Types.....	93
Figure 12. Nuclear Layer Juncture.....	105
Figure 13. Nuclear Layer Serialization Hierarchy.....	106
Figure 14. Core Layer Juncture.....	115
Figure 15. Core Layer Serialization Hierarchy.....	117

List of Tables

Table 1. Phonemic Chart - Consonants.....	12
Table 2. Phonemic Chart - Vowels.....	13
Table 3. Possessive Forms.....	15
Table 4. Noun Class Numbers.....	17
Table 5. Noun Phrase.....	18
Table 6. Verb Phrase.....	24
Table 7. Co-occurrence of Verbal Particles.....	24
Table 8. Perfect-Imperfective Aspect Combinations.....	43
Table 9. Aspect Combinations with Irrealis.....	52
Table 10. Propositional Modality.....	58
Table 11. Combinations of Aspect with Negative.....	61
Table 12. Directional Aspect Particles.....	64
Table 13. List of Adverbs.....	77
Table 14. Prepositional Verbs.....	122

Abbreviations

The Lou examples are presented in orthographic transcription using bold type. In the interlinear examples, lower case type is used for glosses which represent English dictionary entries. Upper case type is used for glosses which represent grammatical classes. Following is the key to the abbreviations used in the interlinear examples and in all labeling.

GLOSSES

1d	First person dual	
1d.in	First person dual inclusive	
1p	First person plural	
1p.in	First person plural inclusive	
1pc	First person paucal	
1pc.in	First person paucal inclusive	
1s	First person singular	
2d	Second person dual	
2p	Second person plural	
2pc	Second person paucal	
2s	Second person singular	
3d	Third person dual	
3p	Third person plural	
3pc	Third person paucal	
3s	Third person singular	
ADV	Adverb	
ALT	Alternative	të
COMP	Completive	pë
CONT	Continuative	tö
DEF.CONT	Definite Continuative	tu
DES	Desiderative	pa
DIM	Diminutive	ën
DV	Directional aspect Verb	
EMPH	Emphatic	ti
GOAL	De-Transitiviser	-k
IND OBJ	Indirect Object	
IRR	Irrealis	ka, ki
MV	Main Verb	
NEG	Negative	a, sa

NOM	Nominalizer	-ian, -an, -nan
NP	Noun Phrase	
OBJ	Object	
OBL	Oblique	ë
PERF	Perfect	ë
POSS	Possessive	
PP	Prepositional Phrase	
PROG	Progressive	ën
PV	Prepositional Verb	
QUES	Question	e
RCP	Recipient	
SIM	Simultaneous	lë
SM	Subject Marker	
SUB	Subordinate Clause Marker	ta
SUBJ	Subject	
SVC	Serial Verb Construction	
VP	Verb Phrase	

LANGUAGES AND GEOGRAPICAL ENTITIES

AN	Austronesian
CEMP	Central/Eastern Malayo-Polynesian
CMP	Central Malayo-Polynesian
EMP	Eastern Malayo-Polynesian
PAd	Proto Admiralties
POC	Proto Oceanic
SHWNG	South Halmahera/West New Guinea

Chapter 1. Introduction

Crystal's dictionary (1991:372) defines the verb as referring "to an element which can display MORPHOLOGICAL contrasts of TENSE, ASPECT, VOICE, MOOD, PERSON and NUMBER". The verb is the element which, by itself or in combination with other verbs is used as the minimal predicate of a sentence, co-occurring with core arguments like the subject and object. If the predicate contains other elements like adverbs and objects, then it is the verb which affects the choice and limitation of these elements. The verb is considered the head (most important element) of the clause.

The term *verb phrase* has two applications. Traditionally, the *verb phrase* referred to a group of words which together have the same syntactic function as a single verb. In such phrases (verbal groups, verbal cluster), one word is the main verb (or lexical verb) and the other words are subordinate to it. In Generative grammar, the *verb phrase* has a much wider definition, being equivalent to the whole predicate of a sentence, including adverbials and objects. It is in the narrow traditional sense that the term *verb phrase* is used in this thesis.

This thesis will study the Lou¹ verb phrase from two perspectives. In chapter two, a descriptive functional point of

¹ Pronounced like the English adverb, 'low'.

view is utilized to describe the forms that occur in the verb phrase, including their structure, their characteristics and their function, when they appear singly or in combinations. In chapter three, the theoretical modal of Role and Reference Grammar's (RRG) view of the layered structure of the clause is utilized to describe serial verb constructions in Lou, in addition to the descriptive approach. The impetus for using the RRG theoretical modal was the fact that Lou presented two types of serial verb constructions (SVC) that were different syntactically, and yet both clearly SVCs. The RRG theory provided an analytical modal for distinguishing SVCs based on syntactic differences, namely the nuclear and core layers of the clause.

In this chapter, first a brief overview of the Lou language is presented and then the direction that this thesis follows is outlined.

1.1. The Setting

The Lou² language is spoken on Lou Island in Manus Province in Papua New Guinea. Lou Island is a small volcanic island about

² The data that this thesis is based on was collected under the auspices of the Summer Institute of Linguistics during 1992 - 1993 in Solang village on Lou Island, Papua New Guinea, with a native speaker, Mr. Solok Pwaka, a retired school teacher, and other helpful residents of Lou Island. Mr. Luek Pokomon from Rei village helped check the accuracy of the data presented in this thesis. The body of texts include traditional stories, historical narratives, personal experiences, and some translated materials. Some of the texts were recorded on tape and later transcribed, while others were collected in written form.

40 kilometers south of Manus Island in the Bismarck Sea. See the maps in Figures 1, 2, and 3.

There are four main villages on Lou Island; Rei, Solang, Baon, and Lako. These villages represent three different dialects; Rei, Baon, and Lako. Solang village and Baon village speak the Baon dialect. The linguistic differences between the dialects is minimal. The important differences between the dialects is social. This thesis presents an analysis based on the Baon dialect as spoken in the village of Solang.

Figure 1. Map of Papua New Guinea

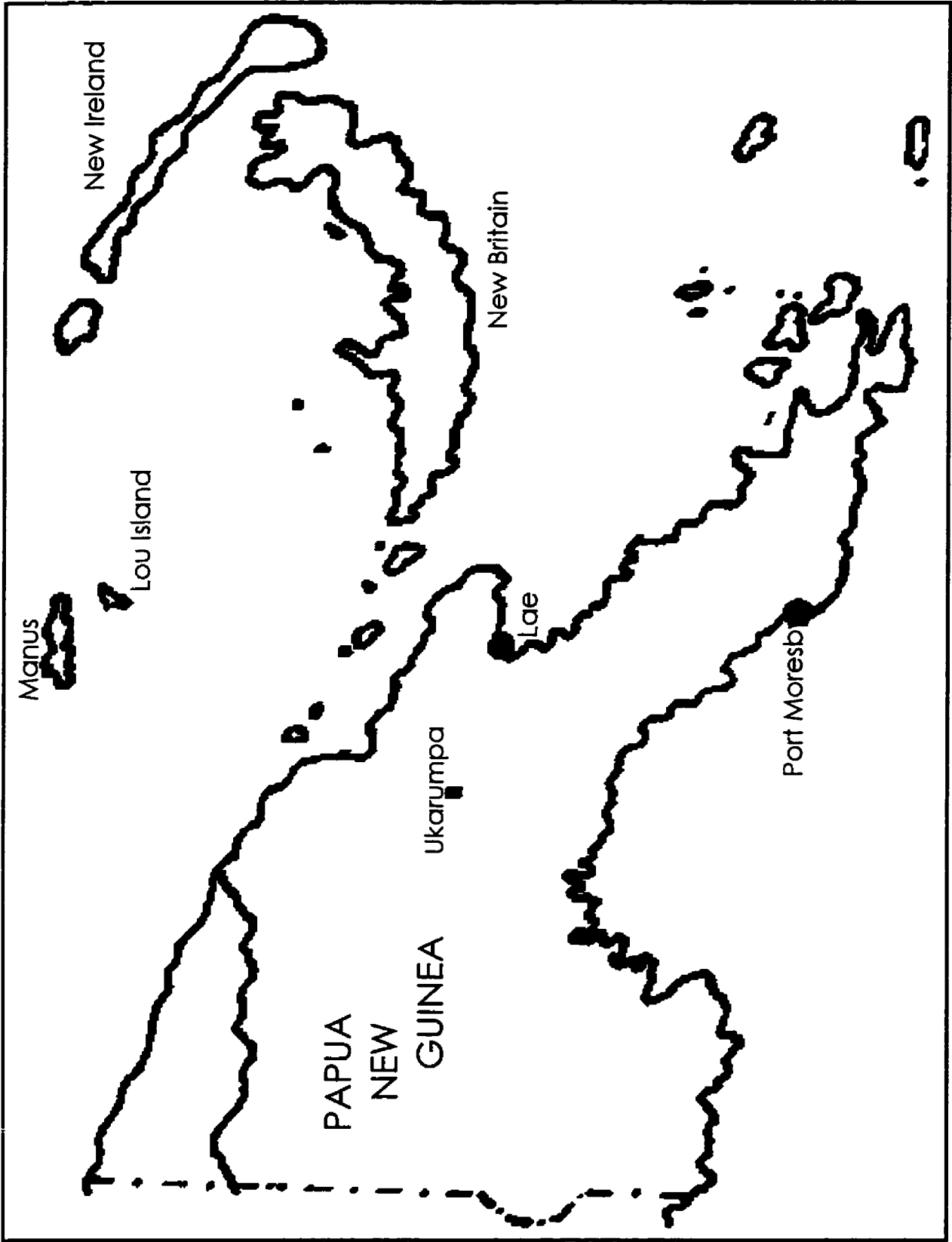

Figure 2. Map of Manus and South-East Admiralties Cluster

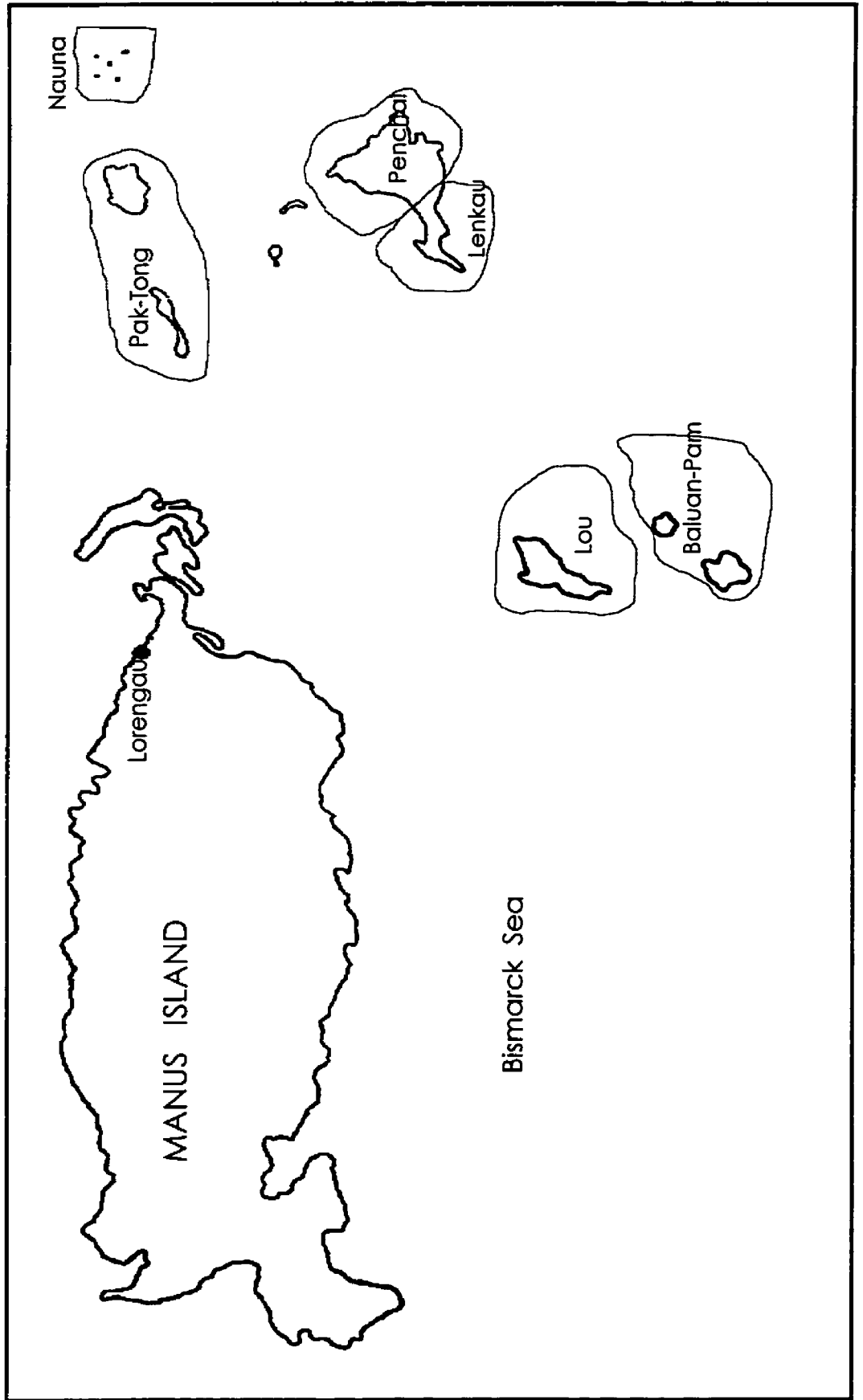
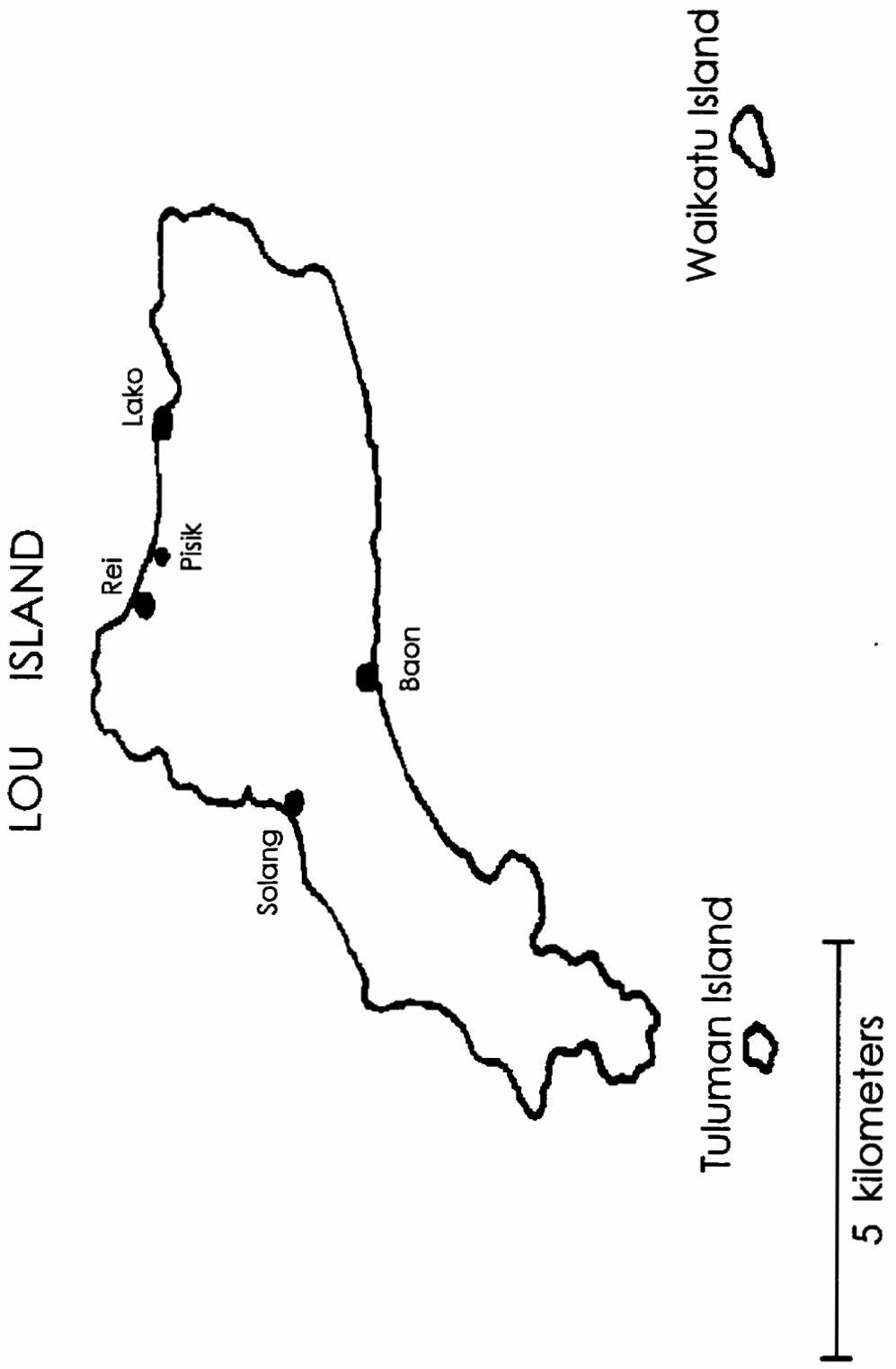

Figure 3. Map of Lou Island



The number of Lou speakers is around 1000, with about half the population being resident on Lou Island at any given time. The rest of the Lou speakers are scattered throughout the towns of Papua New Guinea in school or at jobs and only come home to Lou Island for yearly vacations.

1.2. Linguistic Relationships

Lou is an SVO Austronesian language classified as part of the South-East Islands Sub-family of the Manus family, which is part of the South-East Admiralty cluster (Healey 1976). The Admiralties cluster is a first-order Oceanic sub-group (Ross 1988:320). The other languages in the family are Nauna, Penchal, Lenkau, and Pam-Baluan.

Ross (1988:316-317) proposes the following classification, which is slightly different from Healey 1976:

Figure 4. Linguistic Classification

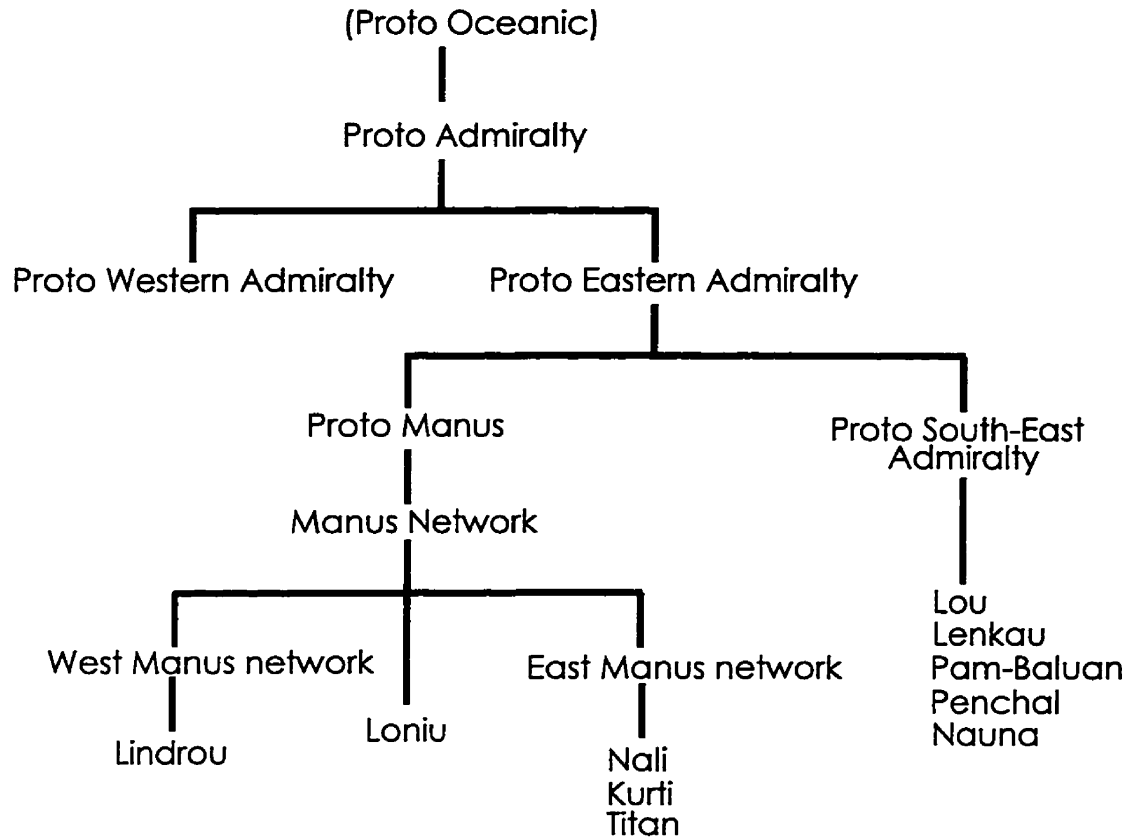

The evidence in Ross (330-345) for the Admiralties cluster includes three phonological innovations, seven morphosyntactic innovations, and three innovations associated with consonant grade. The phonological innovations are: 1) the loss of POC *R before high vowels, 2) POC *p became *-f- word medially, and 3) the loss of word final consonants.

The morphosyntactic innovations are as follows: 1) the use of numeral classifiers in the sequence of numeral + classifier, 2) the use of the numeral one as a common article, 3) the loss of the POC non-singular possessive pronominal suffixes and replacement

with disjunctive pronouns, 4) the replacement of the POC third person singular possessive pronominal suffix **-ña* with **-na*, 5) the replacement of the POC first person inclusive plural disjunctive pronoun with **ta*, 6) the loss of verbal reduplication as a means of forming the continuative aspect, and 7) the coalescing of the POC common article **na* with common nouns, resulting in phonological changes in some initial consonants.

The conventional oral-/nasal-grade pairs of POC, **p/*b*, **t/*d*, **r/*dr*, **s/*j*, and **k/*g* were reflected in PAd without change. Innovations connected with consonant grade are: 1) post-POC lenition affects only reflexes of POC medial **-s-*, and only after the break-up of PAd, and 2) secondary nasal grade which refers to a second set of reflexes of POC **p-*, **t-*, **r-*, **s-* and **k-* and occurs only word-initially and only on common nouns because of (7) above.

The shared innovations of the Eastern Admiralties family of which Lou is a member are: 1) POC/PAd initial **p-* merged with **b* as **p*, 2) POC/PAd **r* and **c* merged as **r*, 3) POC **j* merged with the secondary nasal grade as **r*, 4) POC **nus[o, a]* 'squid' is reflected as **nuy(V)*, 5) POC numerals from seven to nine were replaced by a system based on subtraction from ten, 6) POC **kami* 'D:1EP' and **kamu* 'D:2P' were replaced by their alternate forms **kai* and **kau*, 7) the tense/aspect marker PEAd **k-* plays a major role in the verb system, especially in forming the future, and 8)

the declarative negative is formed with reflexes of PAd clause-final *pwe[n].

The following figure shows the genetic tree of the Austronesian subgroups.

Figure 5. Genetic Tree of Austronesian Subgroups

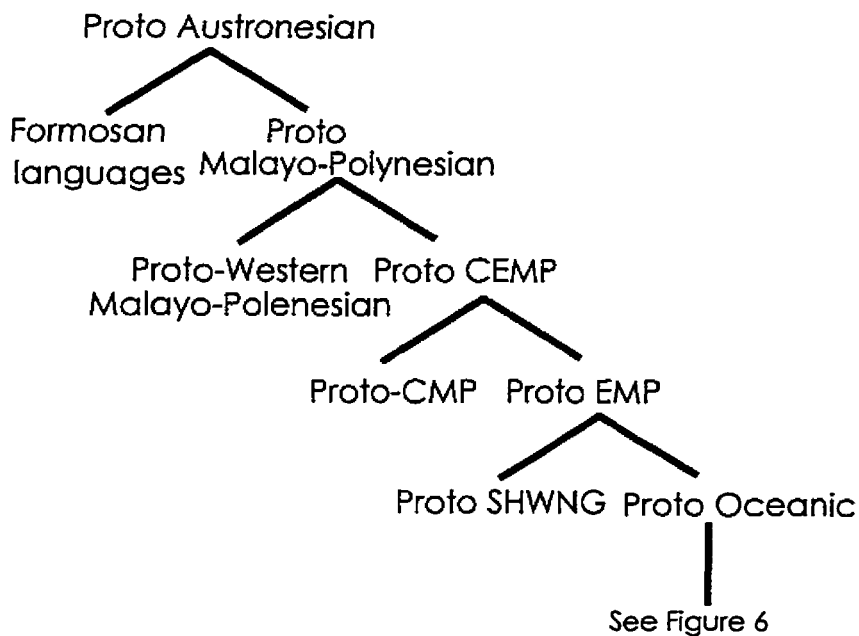
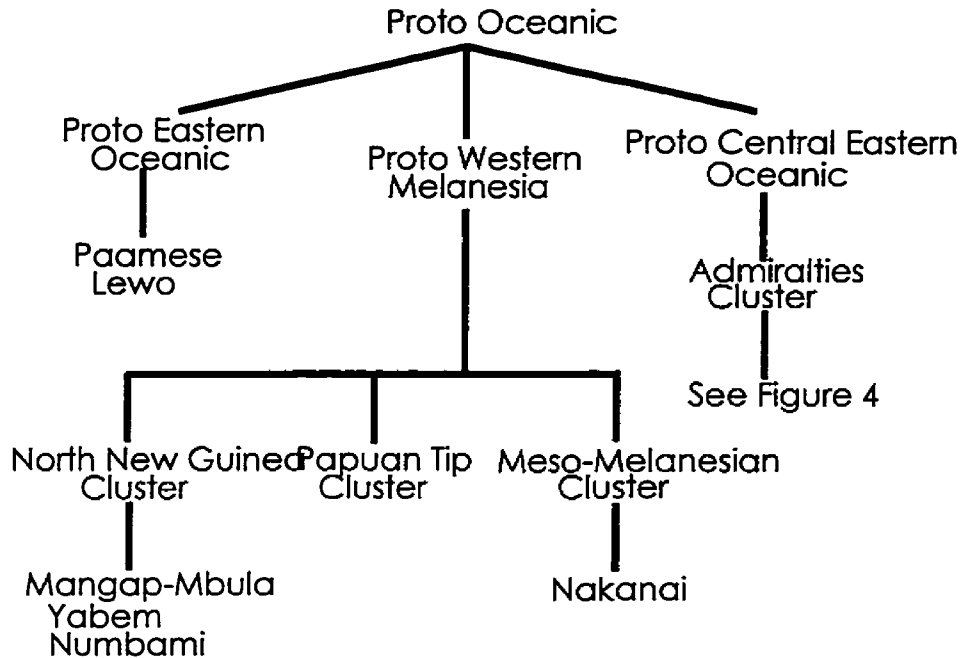

Figure 6 shows how the Admiralties cluster is related to other Austronesian languages. (Adapted from Ross 1988:20,25).

Figure 6. Genetic Tree of Proto Oceanic



1.3. Literature Review

Lou is a poorly documented language, as are most of the languages in the Admiralties cluster. Apart from some wordlists referred to in Healey (1976) and scattered examples in Ross (1988), there is currently no published material in Lou. The only exception to poor documentation among the Admiralties languages is Loniu. Hamel (1983, 1988, and 1993) has published work on the Loniu language. In addition, a complete grammar of Loniu is being published in 1994. Some unpublished work has been done by workers of the Summer Institute of Linguistics in Lindrou, Nali, Kurti, and Titan. Languages from the other clusters in the Western Melanesia grouping have fared better. There are several languages with

comprehensive grammars and numerous papers. The massive comparative work by Ross (1988) previously referred to, marked a significant contribution to Proto Oceanic and the Austronesian languages in Western Melanesia.

1.4. Overview of Phonology

The Lou language has thirteen consonants and seven vowels as shown in the accompanying charts³.

Table 1. Phonemic Chart - Consonants

	Bilabial	Alveolar	Velar
Plosive	p	t	k
Labialized Stop	pW (pw)		kW (kw)
Nasal	m	n	N (ng)
Labialized Nasal	mW (mw)		
Trill		r	
Fricative		s	
Lateral		l	
Approximant	w		

/p/ is pronounced as a voiced bilabial fricative [B] between vowels, as a voiced bilabial stop [b] following a consonant, and as a voiceless bilabial stop elsewhere. /t/ is pronounced as a voiced alveolar flap [r] between vowels, as a voiced alveolar stop

³ The orthographic symbols which differ from the phonemic symbols are shown in brackets.

[d] following a consonant, and as a voiceless alveolar stop elsewhere. /k/ is pronounced as a voiced velar fricative [ɣ] between vowels, as a voiced velar stop [g] following a consonant, and as a voiceless velar stop elsewhere. /r/ is pronounced as an alveolar trill, in contrast to the alveolar flap [r] mentioned earlier.

Table 2. Phonemic Chart - Vowels

	Front	Central	Back
High	i		u
Mid Close	I (ë)		U (ö)
Mid Open			o
Low	E (e)	a	

/I/ is pronounced as a mid close front vowel. It is very difficult for an English speaker to distinguish the difference between /I/ and /i/, when they occur between two consonants. /U/ is pronounced as a mid close vowel. It is difficult for an English speaker to distinguish between /U/ and /o/, when they occur between consonants.

Lou has no contrastive tone, and stress is predictably attracted to the heaviest syllable of the word. There are four basic syllable patterns ranked from light to heavy as follows: (C)V, (C)VV, (C)VC, CVVC. Vowel sequences are allowed, but consonant sequences are allowed only across syllable boundaries. Non-final syllables tend to be open. Final syllables frequently

are closed with a nasal or lateral. In this respect, Lou does not concur with Ross's innovation, that the Admiralties cluster lost word final consonants (page 8).

1.5. Overview of Morphology

Lou is a fairly rigid SVO language with nominative-accusative case; subjects and objects are marked strictly by word order, exemplified in example (1). Person and number are not normally marked in the verb phrase. Like many SVO languages, Lou has prepositions rather than postpositions and subordinate (non-main) verbs follow the main verb rather than precede it. Oblique arguments are marked by serial verbs or prepositions or both. Subordinate clauses⁴ of all types are introduced with the subordinate clause marker, *ta* 'SUB'. Morphological nominal case marking is restricted to the genitive and oblique cases.

	SUBJ	VERB	OBJ	IND	OBJ
(1)	<i>tipëng</i>	<i>Anabel ki</i>	<i>pë lëp kouka</i>	<i>me</i>	<i>kong</i>
	tomorrow	Anabel 3s:IRR	COMP take sweet.potato	come	1s:RCP
	<i>'Tomorrow Anabel will bring sweet potatoes to me.'</i>				

The Lou verb phrase consists of a main verb, preceded by ten optional pre-verbal particles, and seven optional directional aspect verbs which may appear singly or in combinations of two or more. These particles encode aspect, directionals, status, and

⁴ Subordinate and coordinate clauses are defined for Lou on page 131.

modality and provide a very rich grid of expression for the native speaker.

Verb serialization is also a feature of Lou. Both core layer and nuclear layer serializations occur, although a different set of verbs enter into core serialization than may enter into nuclear serialization. Only motion and stative verbs may enter into core serialization, while transitives and some other intransitives may enter into nuclear serialization.

Nouns have an extensive possessive system, including alienable and inalienable possession. Nouns that are obligatorily possessed include names of body parts, certain kinship terms, certain spatial terms, some adjectival qualities, and the names of the part in a part-whole relationship.

Table 3. Possessive Forms

Inalienable Possession

mata-ng	eye-1s:POSS	'my eye'
tama-m	father-2s:POSS	'your father'
rëi-n ke	leaf-3s:POSS tree	'tree leaf'
kamwöu-n ponat	dispute-3s:POSS land	'land dispute'
arö-n	front-3s:POSS	'it's front'
ëlëwë-n	length-3s:POSS	'it's length'

Alienable Possession

um tēp	house 1p:RCP	'our house'
buk tē Solok	book 3s:RCP Solok	'Solok's book'

Verbs and adjectives may be reduplicated fully or partially. Reduplication may mark imperfectivity in verbs, although the more productive method for marking imperfectivity is with the use of

stative verbs as pre-verbal particles. Reduplication marks intensity in adjectives. Nouns may be formed by the reduplication of verbs, or by suffixation with the nominalizer, **-ian**.

Lou has a comprehensive pronominal system, distinguishing three persons and four numbers: singular, dual, paucal, and plural, and inclusion versus exclusion with the hearer in first person non-singular. There is one set of personal pronouns used to encode the core syntactic cases of subject and object. When these pronouns encode the recipients and possessors of consumable items, they are prefixed with **k-**. When these pronouns encode the recipients and possessors of non-consumable items, they are prefixed with **t-**.

There are ten noun classes attested to in the data, which are distinguished by the set of numerals that occur with each noun. The noun classes are semantically based usually by the shape or grouping of the objects. The classes are listed in the following chart.

Table 4. Noun Class Numbers

ramat som	'one man'	animate
um sip	'one house'	general
pwentele sut	'one clam shell'	pieces
mun sēt	'one bunch of bananas'	bunches
ponu sara	'one village'	abstract
karminan sakal	'one arm'	branches
epi sör	'one bundle of sago'	bundles
ponu sopol	'one side of the village'	halves
ke se	'one tree'	long things
muli sēk	'one section of citrus fruit'	sections

The numeral one, as illustrated in the following example, is used as a common article in accord with Ross's second morphosyntactic innovation (See page 8).

- (2) **pwalē som pē tōk la lalön lēklēk**
 devil one COMP stay go.to inside basket
 'A devil stayed inside the basket.'

The unmarked order is for modifiers to occur following the nouns they modify. When a modifier occurs before the head noun, the modifier is emphasized. Some genitives occur preceding the head noun and some follow the head noun. When the possessor is a non-pronominal noun phrase, the genitive follows the head noun. When the possessor is a pronoun, the genitive precedes the head noun. In the noun phrases in the following table, the head noun is underlined.

Table 5. Noun Phrase

<u>patan</u> <u>pwakpwak</u> ri	trunk large INTS	'very large trunk'
<u>pwakpwak</u> <u>monua</u> som	large eagle one	'a large eagle'
<u>katap</u> <u>epi</u>	1p.in:RCP sago	'our sago'
<u>nenewaë</u> të tina-n	word 3s:RCP mother- 3s:POSS	'his mother's advice'

Although, this overview has been brief, it is hoped that it will help the reader to better understand the examples in this thesis.

In Chapter 2, a comprehensive description of the simple verb phrase in Lou is presented, with examples and definitions of each of the constituents. There are five orders of pre-verbal particles; status modality, polarity, perfect aspect, directional aspect, and imperfective aspect. Although, there are no explicit tense morphemes, tense is expressed with the different aspectual morphemes. The different combinations of particles will be examined as well.

Chapter 3 studies serial verb constructions in Lou. Serial verb constructions are looked at from several perspectives; their structure, their function, and types of SVCs based on the nature of the relationship between the shared nominal arguments. The layered structure of the clause as presented by RRG is described, with the view to determining that Lou has two forms of serial verb constructions. Several tests are presented to distinguish between nuclear layer serialization and core layer serialization. The Lou nuclear layer serial verb construction is shown to be

distinct from compound verbs. Both same-subject and switch-subject nuclear SVCs are listed.

The Lou core layer serial verb construction is discussed next. A historical overview of prepositional verbs is given. Several arguments are presented to indicate that the Lou core serial verb construction is indeed more verbal than prepositional. Evidence is provided to confirm that serial verb constructions in Lou constitute a single clause, rather than a series of clauses. Both same-subject and switch-subject core SVCs are identified.

Chapter 4 is a summarization of the main points of this thesis. Topics for further research are suggested as well.

Chapter 2. Simple Verb Phrase

There are two types of verb phrases in Lou: simple verb phrases and serial verb constructions. The simple verb phrase consists of optional⁵ pre-verb particles and a main verb. In the following example, **anwal** 'win' is the main verb and the other underlined words are optional particles.

- (3) **ap ka pē tō anwal tin**
2p IRR COMP CONT win fight
'You will be winning the fights.'

The serial verb construction (SVC) consists of a simple verb phrase followed by a serialized verb. The following example illustrates a fully inflected non-negative serial verb construction. **tep** 'reach' is the main verb, followed by **toan** 'look.after', the serialized verb.

- (4) **Sasgas ki pē la tō tep toan ip⁶**
Shaashgaz 3s:IRR COMP go.to CONT reach look.after 3p
'Shaashgaz would have been going to look after them.'

In this chapter, the simple verb phrase of Lou is discussed. First a general overview of the verb phrase is presented. Then each particle is discussed in detail. Serial verb constructions will be discussed in Chapter 3.

⁵ They are *optional* in the sense that none of the particles are obligatory. Emission does change the meaning.

⁶ This example is taken from translated materials. Fully inflected verb phrases such as this one are extremely rare in natural texts.

2.1. Introduction

Givón, in his opening paragraph to his chapter on Tense-Aspect-Modality (1984:269), acknowledged that of all grammatical sub-systems, tense-aspect-modality is probably the most complex and frustrating to the linguist. Because it is an obligatory category without which simple sentences cannot be produced, one faces the challenge of analyzing the tense-aspect-modality (TAM) system relatively early in studying the structure of simple clauses of a language. In addition to being an obligatory component of simple sentences, TAM also constitutes one of the major devices encoding the coherence of sentences as they are joined together in discourse. TAM is therefore intimately involved in the grammar of complex constructions and complex discourse functions, and the label 'simple' as applied to the common TAM markers is deceptive.

The Lou verb phrase illustrates this point very well. There are a total of seventeen pre-verb particles occurring in the verb phrase in various combinations. These particles encode a variety of TAM notions. In this chapter, the Lou verb phrase is investigated with particular attention given to how TAM notions are encoded within the verb phrase.

Many languages of Central-Eastern Oceania and of the Admiralties, Meso-Melanesian and Papuan Tip clusters have a Type B

verbal system⁷ (Ross 1988:101). In a Type B verbal system, tense and aspect morphemes may intervene between subject proclitic and verb-stem, or may precede and be phonologically merged with the subject proclitic. More than one tense and aspect morpheme may occur in a single verb phrase.

The verb phrase in Lou is made up of a variety of optional pre-verb particles which mark aspect, relative tense, and modality, followed by an optional directional aspect particle, another aspectual particle, and a main verb. Many of these pre-verb particles have been re-analyzed from main verbs and still function as main verbs.

As predicted, Lou, as an Oceanic language does not have specific tense morphemes; instead temporal reference is expressed with aspectual morphemes. In his description of Mangap-Mbula, an Oceanic language situated off the coast of Morobe Province, Bugenhagen (1989:14) notes that there is no morphological indication of tense or mode on Mangap-Mbula verbs. In Nakanai, an Oceanic language located on the North coast of New Britain, time is encoded by a temporal adverb or a prepositional phrase

⁷ Upon examination of the languages of Central Malayo-Polynesian, South Halmahera/West New Guinea, and Oceanic areas, Ross recognized two types of SVO languages among them. He labeled them Type A and Type B. In a Type A verbal system "the tense/aspect-marking system is simple, making distinctions between future/non-future, perfective/imperfective, habitual/punctual, and providing morphological marking for only the first member of each pair" (1988:96). The habitual is marked by reduplication, the future morpheme precedes the verb, and the perfective morpheme follows the verb.

(Johnston 1980:51). Dempwolff, in his grammar (1939) of Yabêm⁸ states that "the Yabêm verb is no 'time word'; it lacks specific 'tenses'" (translation given in Capell (1971:288)).

In Lou, there are two orders of aspectual morphemes that may be separated by a directional aspect particle. The first order of aspectual morphemes moving outward from the verb root encodes imperfectivity and the second order of aspectual morphemes encodes perfect notions. The distinct functions of the two orders of aspect will be described in more detail later on. Table 6 displays the linear order of the verb phrase constituents. All the constituents are optional except for the main verb (MV). Although adverbs are not technically a part of the verb phrase using the narrow definition of verb phrase as this thesis does, they are shown on the chart in order to give the reader a pictorial view of how the adverbs inter-relate with the verb phrase constituents.

⁸ Yabêm (=Jabêm) is an Oceanic language located on the Huon Peninsula on the mainland of Papua New Guinea.

Table 6. Verb Phrase

Status	Polarity	PERF Aspect ⁹	DV ¹⁰	IMP Aspect	ADV ¹¹	MV	ADV ¹²
ka	a	lē		tu			
ki	sa	ē		tō			
∅	∅	pē		ēn			

Any of the status, negative polarity, perfect aspect, and imperfective aspect particles may occur in the verb phrase singly, or in combination with other particles. In normal texts, at most two or three co-occur. The following chart shows which combinations may occur. The shaded boxes represent illogical combinations.

Table 7. Co-occurrence of Verbal Particles

	tu	tō	ēn	ka/ki	a/sa	lē	ē	pē
lē	yes	yes	yes	yes	no			
ē	yes	yes	yes	no	no			
pē	yes	yes	yes	yes	no			
ka/ki	yes	yes	yes		yes	yes	no	yes
a/sa	yes	yes	yes	yes		no	no	no

In the following sections, the function of the individual particles will be described and illustrated with examples, in order to isolate the basic meaning of each form. Then an attempt

⁹ Since the polarity particles are mutually exclusive with the perfect aspect particles, an alternative analysis would group these particles together into one order, with **a** = negative real; **sa** = negative unreal; **∅** = unmarked; and **lē**, **ē**, and **pē** = affirmative.

¹⁰ These forms are listed in Section 2.5. Directional Aspect .

¹¹ Only one adverb may optionally occur before the main verb in the present corpus of data.

¹² These forms are listed in Section 2.7. Adverbs.

will be made to describe the variation in meaning that occurs when these particles are combined, bearing in mind that it is difficult to differentiate the meaning of the form in question from the implicature of the context in which the form is found. According to Comrie (1985:28), the failure to distinguish between meaning and implication is the main difficulty in adequately characterizing the tenses. The failure to distinguish between meaning and implication poses difficulties for analyzing aspect and modality as well.

Where possible, it will be shown how each particle is used in extended discourse as well. A fundamental task of linguistics is to understand and organize the facts of the whole of linguistic behavior (Wallace 1982:207). It is not enough to analyze only isolated sentences; whole discourses must be analyzed to adequately understand how all the parts fit together.

The order that this thesis follows in presenting these pre-verbal particles is not entirely random. Since aspect tends to be an 'inner' operator it is discussed first. Then the other particles are discussed in the linear (left to right) order in which they occur in the verb phrase. Perfect aspect will be described first, followed by imperfective aspect. Then the combinations of perfect and imperfective aspect will be dealt with. Thirdly, status will be outlined and shown how irrealis mode interacts with aspect. Fourthly, the negative particles will be described and indicated how they interact with aspect and

irrealis. Last of all in this chapter, the directional aspect particles, main verbs, and adverbs will be described in that order.

2.2. Aspect

Aspect pertains to the temporal nature of the event itself. Aspect has been defined as different ways of viewing "the internal temporal constituency" of the event (Comrie 1973:3). The essential features of aspect are how the event is viewed temporally. Is the whole event viewed as one complete whole or is it opened up and seen as a complex event, focusing on the beginning, middle, or end of the event? Chung and Timberlake define aspect as characterizing "the relationship of a predicate to the time interval over which it occurs" (1985:212). Aspect covers two semantic parameters. The first one is dynamicity, which asks the question, Is there change throughout the time interval? The second parameter has to do with duration of the event. Is there closure of the event within the time interval or does the event endure for a period of time?

As was already mentioned, the Lou verb phrase has two structural positions where aspectual morphemes occur. The position closest to the main verb, has been labeled 'imperfective aspect'. The position that is further from the main verb has been labeled 'perfect aspect'. Foley (1986:143) establishes tense as

being an outer operator¹³ because it is associated with the proposition as a whole, while aspect is an inner operator because it modifies the verb itself. Generally, inner operators are found to occur closer to the verb root than outer ones. In his study of Hawaii English Creole, Givón found that the order of TAM particles followed the universal order proposed by Bickerton (1974), that of:

(ANTERIOR) (MODAL) (DURATIVE) V

Givón explains this order in terms of their scope of application. Durative/non-punctual aspect has the narrowest verbal scope; irrealis/modal has a wider, propositional scope; and the perfect/anterior has the widest discourse scope of all (1984:295). This is explained with the simple principle of 'morpho-syntactic iconicity'. An operator that takes only the verb under its scope, will be placed closer to the verb than operators that take the verb plus other items under its scope. The wider the scope of an operator is, and the more items it takes under its scope in addition to the verb, the farther away from the verb it will be placed. Since tense has the whole proposition under its scope, it is placed further away from the verb than aspect which has only the verb under its scope.

¹³ Operators refers to grammatical modifiers such as; tense, aspect, directionals, modality, evidentials, etc.

This universal tendency is at least partly true for Lou as well. The imperfective aspect particles occur closer to the verb root than the perfect aspect particles. The latter will be demonstrated to be more tense-like than the imperfective aspect particles, and therefore broader in scope.

2.2.1. Perfect Aspect

According to Givón (1984:278), perfect aspect involves three tense-like elements: sequentiality, the time-axis, and precedence. Sequentiality refers to a way of interpreting time as a succession of points, each one occupying a fixed position in linear order on the time-line. The time axis refers to a fixed position on the time line, to which the event time (event time₁) is referenced. The time axis may be the time of speech (absolute tense) or the time of another event (event time₂) which results in relative tense. Precedence refers to the fact that the event time occurs before the time axis. These tense elements give perfect aspect its tense-like nature.

Perfect aspect also involves four aspectual characteristics; perfectivity, anteriority, counter-sequentiality and current relevance. Perfectivity refers to the presence of or emphasis on a terminal boundary of the event at some point on the time line. Anteriority refers to the gap that exists between the terminal boundary of the event and the time axis or reference time. Counter-sequentiality involves a series of events, normally coded

in the order in which they occurred, in which one of the events is coded as taking place out of the normal sequence of events. Normally an earlier event is coded before a later event, but when an event is marked for counter-sequentiality, it is coded after a later event because of current or lingering relevance after the later event.

There are three mutually exclusive particles that mark perfect aspect in Lou: **lë**, **ë**, and **pë**. None of these particles currently function as main verbs. These perfect aspect particles will be shown to each emphasize a different set of these aspectual and tense-like elements just described.

The perfect aspect particle, **lë** involves the aspectual feature of anteriority. The particular emphasis is on the gap between the event and the time axis. The label simultaneous 'SIM' is used, as it encodes the meaning of a very short or non-existent gap between the boundary of the event and the time axis. Hamel reports that Loniu, a language from the Manus network, has a verbal particle in the pre-verbal position, **le'i**, which she has analyzed as being a "simultaneous particle" (1993:113). She states that it is used to denote that the activity of the main verb is occurring simultaneously with the moment of speech (1994:111). The Lou particle, **le** 'SIM', which is cognate with the Loniu particle, **le'i**, also encodes the notion of simultaneity. English equivalents are 'at the point of, just now, just then, etc.'. Figure

7 depicts the small or non-existent gap of time between the event time and the time axis.

Figure 7. Non-Existent Gap for *lë*

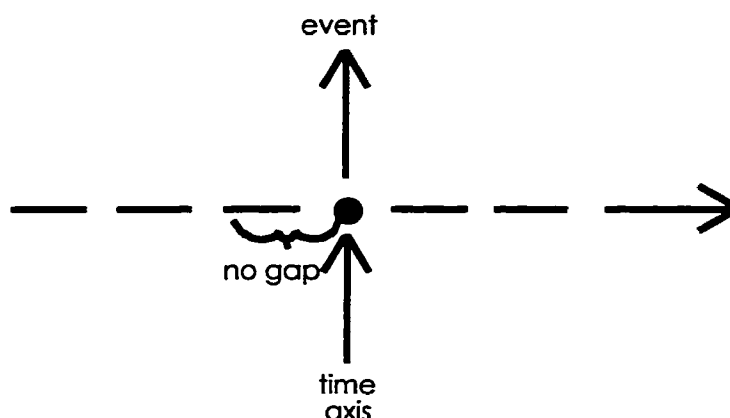

In this example, *lë* 'SIM' identifies that their disobedience has reached the speaker just now, at the moment of speaking.

- (5) *petita rōng-rōng pwën talap lë sa tep la*
 because hear-hear not 3p:RCP SIM come.up reach go.to

tetang
 1s:RCP

'...because their disobedience has just now reached up to me.'

Thus the perfect aspect particle, *lë* 'SIM' may function as relative tense, in that it relates the time of the event to be as close as possible to the time of another event (time axis). This time axis may be the time of the speech act, as in the above example or the time of some other event that happened in the past or may in fact, happen in the future. In example (6), the event of 'attracting Hegai' (event time) occurs right at the point in time in which Esther was taken in to see him (time-axis). In discourse, the time of one event always relates somehow to the preceding

event. In a sequence of clauses, an event is most likely to receive its time-axis from the event in the preceding clause (Givón 1984:275).

- (6) **Esta töpö i lë pe matsisi la matan Hekai**
 Esther this 3s SIM do attract go.to eye-3s:POSS Hegai
- ë ning-ian.**
 OBL see -NOM

'This Esther just then attracted the eye of Hegai with her beauty.'

In narrative discourse, **lë** 'SIM' is often used to mark the climax of the story. In the climax, as the action speeds up, **lë** 'SIM' is used to mark this fast pace. The following two sentences reproduced here from the narrative in Appendix A, shows **lë** 'SIM' occurring three times just before the climax of hitting Napetie with a club.

- (7) **som i aek a i lë tël som i**
 one 3s throw.hit and 3s SIM throw.spear.and.miss one 3s
- aek a i lë tël**
 throw.hit and 3s SIM throw.spear.and.miss

'One threw and it just missed; one threw and it just missed.'

- (8) **Ip tamuna aek a i lë tël sopwi**
 3p every throw.hit and 3s SIM throw.spear.and.miss finish
- 'Every one threw and it just missed.'*

The perfect aspect particle, **ë** 'PERF' encodes situations that have been completed in the past, but have current relevance. **ë** 'PERF' may mark situations that have been referred to earlier in the story as not yet happening, but are related later in the proper sequence of events and refer back to the earlier

reference. Whereas the semantics of **lë** 'SIM' focused on the gap between the event and the time axis being very short or non-existent, the semantics of **ë** 'PERF' focuses on the fact that the event was completed some time before the time axis, but it does have current relevance at the time axis.

Figure 8. Anteriority/Current Relevance for ë

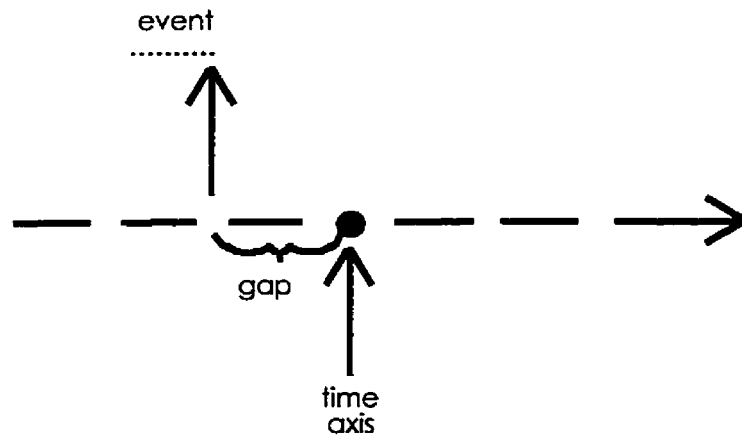

In the story from which example (9) is excerpted, several clauses before the example occurs, the command 'to sleep outside' was given and the preparations for 'sleeping outside' were made. Then some other events are related and then example (9) occurs, referencing back to the earlier mention of 'sleeping outside', a flashback. In most of the examples from narrative texts, the clause containing **ë** 'PERF' is a subordinate clause, out of sequence in the order of events, and referring to something that has taken place earlier.

- (9) **ip ë ën masarën**
 3p PERF lie outside
 'They had already slept outside.'

It is noteworthy that although both of the other perfect particles co-occur with the irrealis particles, *ë* 'PERF' does not occur with the irrealis particles, *ki/ka*. Since part of the meaning of *ë* 'PERF' involves situations that have been completed in the past, it is semantically incompatible with irrealis.

- (10) **ip ka ë ën masarën*
 3p IRR PERF lie outside

The perfect aspect particle, *pë* 'COMP' encodes completion. The essential characteristic of *pë* 'COMP' seems to be that the event is viewed as complete. All parts of the situation are presented as a single whole. Completive aspect may occur with either realis (11) or irrealis modality (12). When it occurs in the realis mode, which is unmarked, it encodes past tense.¹⁴

- (11) *ip pë sot aa punan peti Pwëk*
 3p COMP go.up move valley belong.to Pwëk
 'They went up the valley of Pwëk.'

- (12) *tatap ka pë aa ka la köl Napetie a ka*
 1p.in:RCP IRR COMP move IRR go.to wait Napetie and IRR
la sokmat i
 go.to shoot 3s
 'We will go and wait for Napetie and we will shoot him.'

In narrative text, *pë* 'COMP' occurs in coordinate clauses featuring the foreground or main events of the story. *pë* 'COMP' marks the event line of a story. This function of perfective

¹⁴ When *pë* occurs in the irrealis mode, it encodes 'definiteness'. This is discussed in Section 2.3. Irrealis Status.

aspect is attested to in other languages as well. Wallace concludes,

“If a language has a contrast between a perfective (completive, non-durative, punctual) aspect and other aspects, then part of the meaning of the perfective aspect, at least in narration, is to specify major, sequential, foregrounded events, while part of the meaning of the contrast in non-perfective aspects, particularly an imperfective, is to give supportive background information” (1982:209).

2.2.2. Imperfective Aspect

Lou has three particles that encode imperfective aspect, **tō** ‘CONT’ and **tu** ‘DEF.CONT’ and **ën** ‘PROG’. These particles are mutually exclusive. Each of these particles seem to be grammaticalizations of main verbs. Two of these particles, **tu** ‘DEF.CONT’ and **ën** ‘PROG’, also have some modality connotations, in addition to their aspectual meanings, whereas **tō** ‘CONT’ has no such modal connotations.

The imperfective aspect particle **tō** ‘CONT’ encodes the internal temporal constituency of continuity without reference to the beginning point or the endpoint of the event. This perspective is an interior one, which ignores the beginning and endpoints of the action or state. This is schematized in Figure 9 from Boutin (1991:12). The label ‘CONT’ continuative is used in this thesis.

Figure 9. Continuative Aspect

Viewpoint



.....

Situation

tö 'CONT' may occur in the realis mode (13) and in the irrealis mode (14).

(13) **i tö lëp katap epi**
 3s CONT take 1p.in:RCP sago
'He was continually taking our sago'

(14) **ip petia-n ip titsa mwan ip notu talap**
 3p wife -3s:POSS 3p teacher with 3p child 3p:RCP

ka tö aa la olunga -n
 IRR CONT move go.to accompaniment-3s:POSS

'The teachers' wives with their children would be going with her.'

Ross (1988:332) noted that in many Admiralties languages, reduplication of the verb stem to encode continuative aspect has been replaced by the verb 'stay'. In Lou, **tö** 'CONT' is also the root form of the verb 'stay' as illustrated in the following existential clause.¹⁵

(15) **uru tö eri**
 3d stay there
'The two of them are there.'

¹⁵ More discussion and examples are presented in Section 2.6. Main Verbs.

Since Lou has no overt tense morphology, the continuative aspect particle, **tö** 'CONT' is used to encode present tense, as illustrated with the following example.

(16) **ö tö teng ä sa**
2s CONT cry OBL what

'You are crying for what?/Why are you crying?'

In the English example, *John was reading when I entered*, the second verb, *entered*, presents the

"totality of the situation referred to without reference to its internal temporal constituency: the whole of the situation is presented as a single unanalysable whole, with beginning, middle, and end rolled into one; no attempt is made to divide this situation up into the various individual phases that make up the action of entry" (Comrie 1976:3).

In the Lou example (17), the first verb **me** 'come' corresponds to the second verb in the English example above. The second verb, **tö ritim** 'CONT read' makes explicit reference to the internal temporal constituency; in this case reference is made to some middle period of the time of reading, without referencing the beginning or the end points of the reading time.

(17) **ta i me Robert tö ritim buk tei**
SUB 3s come Robert CONT read book 3s:RCP

'When he arrived, Robert was reading his book.'

Habitual aspect is expressed with a time phrase or other adverb in conjunction with the continuative aspect particle **tö** 'CONT' as the following examples illustrate. In (18), the time phrase **péng tamuna** 'every day' and in (19), the adverb

pənginpəngin 'all the time', together with **tö** 'CONT', express the habitual.

- (18) **pəng tamuna ramat som la tö ləp kélin**
time every person one go.to CONT take firewood
'Every day the man was going to get firewood.'

- (19) **i tö pe pənginpəngin la talap titsa**
3s CONT do all.the.time go.to 3p:RCP teacher
'She was doing (bad treatment) regularly to the teachers.'

Continuative aspect is used to express conative modality in many languages, including Greek, Latin, Russian, and Jarkarta Malay (Wallace 1982:204). In Lou, **tö** 'CONT' is used in conjunction with a complement clause to indicate conative modality. In example (20), the complement clause is marked with the subordinate clause marker, **ta** 'SUB'.

- (20) **i tö pe [ta i pa ki sokmat puö]**
3s CONT do SUB 3s DES 3s:IRR shoot pig
'He was trying to kill the pig.'

In narrative text, **tö** 'CONT' occasionally occurs just before the climax. It has the effect of slowing the action down to 'slow motion', perhaps to heighten the senses for the soon coming climax. It signals that the climax is just around the corner. **tö** 'CONT' is also used in the settings of stories, and it may be used at the end of a story to calm things down after the climax. The following two sentences are the second last sentences in the story of Napetie in Appendix A, and the continuative aspect

particle, *tö* 'CONT' occurs three times. It has the effect of calming and slowing things down in order to end the story.

(21) *ap ka pē tö amwal tin*
 2p IRR COMP CONT win fight
'You will be winning the fights.'

(22) *ip ramat pē tö lēp lumu-n Napetie la ë*
 3p person COMP CONT take hair-3s:POSS Napetie go.to OBL

tin a ip pē tö amwal seniek ip tin
 fight and 3p COMP CONT win continuous 3p fight

'The people were taking Napetie's feathers into the fights and they were winning their fights continuously.'

Like *tö* 'CONT', the imperfective aspect particle *tu* 'DEF.CONT', a grammaticalization of the verb *tu* 'stay', encodes internal temporal constituency without reference to the beginning or end point of the event. Examples of *tu* 'stay' functioning as main verbs are given below.

(23) *i me tu ë lalön kētin sip 1960 ta ngka*
 3s come stay OBL inside year one 1960 SUB 1s:IRR

pē toktoar la ë kalas nginiöp
 COMP sit go.to OBL class six

'It was in the year of 1960 that I would have sat for the class six (exam).'

(24) *tē ka pa "som mwaen tu tetang"*
 3s:RCP IRR DES one male stay 1s:RCP

'Who will say, "There is my husband?" or "(Someone) will say, "I have no husband."'

When *tu* 'DEF.CONT' occurs in conjunction with realis mode, it encodes immediate tense. When *tu* 'DEF.CONT' occurs in conjunction with irrealis mode, it encodes imminence and urgency. The label

'DEF.CONT' for definite continuative is used. **tu** 'DEF.CONT' is used to express imperatives, permissives, compulsives, conditionals, and obligations. It is most frequently used in the irrealis mode and it frequently encodes forceful or demanding speech. Example (25) shows **tu** 'DEF.CONT' used in an imperative.

- (25) **o la ponu menengan peti Ninipe a**
 2s:IRR go.to village big belong.to Nineveh and
- o la nesek anek nenewaë ta nga tu to wot**
 2s:IRR go.to tell away word SUB 1s DEF.CONT put go
- to tapong**
 2s:RCP this

'You go to the big city of Nineveh and you tell the word that I give to you now.'

The imperfective aspect particle, **ën** 'PROG', a grammaticalization of the verb **ën**¹⁶ 'lie', encodes progressive aspect on the verb. The central meaning encoded by progressive aspect is that there is change over successive moments of time. Example (26) shows **ën** 'lie' used as a main verb.

- (26) **i lë ën mwelin um të mwaen sala topong**
 3s SIM lie under house 3s:RCP male old this
- 'He just lay under this old man's house.'*

¹⁶ **ën** is also the root form for an adjective meaning 'diminutive'. This may apply to physical size or to social status.

ën ramat som a kë -n palawëk a mwat ngan
 DIM person one and foot-3s:POSS bad and sore bite

sumsumrek pusu-n la palawëk ip suput anek i
 scar.scab nose-3s:POSS go.to bad 3p push away 3s

'One 'rubbish' man with bad feet and bad sores on his nose, they pushed him away.'

Example (27) demonstrates the use of *ën*¹⁷ 'PROG' encoding progressive aspectual notions, i.e., there was change in spatial location as the eagle flew. Example (28) is taken from a story in which the blood is in the process of drying. The old woman goes regularly to check it and one day it turns into an eagle and a snake.

- (27) *i ën öp sa -k a ip ramat polum titasip ip*
 3s PROG fly come.up-DETRAN and 3p person few first 3p
aek pelo talap lilip talap
 throw.hit obsidian 3p:RCP club 3p:POSS
 'He was flying up when a few of the first men threw their
 obsidian clubs (at him).'

- (28) *i pa ki ning-ning a tör töpö i ën posa*
 3s DES 3s:IRR see -see and blood this 3s PROG dry
 'While she looked at it, this blood was drying.'

Iterative aspect may be marked by the reduplication of certain verb stems. *lang* 'clean' may occur as the main verb referring to the simple act of picking up some debris in a new garden plot (29). In its reduplicated form, it means that the activity of picking up debris was repeated for a period of time (30). Some reduplicated forms do not have corresponding non-reduplicated forms. Presumably they have been lost over time.

¹⁷ *ën* is not used very frequently and it seems it cannot occur with all verbs. If its usage is restricted to changing stative verbs into processes, then it would make sense that it would not occur with verbs that are inherently progressive. More research is needed to determine which verbs may co-occur with *ën*.

(29) **tatë ka la -k a tatë ka la lang**
lpc:RCP IRR go.to-GOAL and lpc:RCP IRR go.to clean

sopwi katatë konum
finish lpc.in:RCP garden

'You go and you finish cleaning our garden.'

(30) **ëtë ën lang -lang**
lpc PROG clean-clean

'We cleaned and cleaned [garden].'

When no aspectual particles occur in the verb phrase, neutral aspect is encoded. Neutral aspect encodes the simple past tense, without any emphasis on any of the tense or aspectual elements of the perfect and imperfective aspect markers. Neutral aspect is used in narrative text for the setting, and for background information throughout the discourse before the climax, within the climax, and after the climax. The following example illustrates neutral aspect.

(31) **i tək kötöröt ë samël**
3s cut sugarcane OBL knife

'She cut the sugar cane with the knife.'

2.2.3. Aspect Combinations

The perfect aspect particles may combine with the imperfective aspect particles encoding unique aspectual notions. The following chart lists the possible combinations.

Table 8. Perfect-Imperfective Aspect Combinations

Perfect	Imperfective	
lë	tu	simultaneous definite continuative
lë	tö	simultaneous continuative
lë	ën	simultaneous progressive
ë	tu	anterior definite continuative
ë	tö	anterior continuative
ë	ën	anterior progressive
pë	tu	completive definite continuative
pë	tö	completive continuative
pë	ën	completive progressive (iterative)

The perfect aspect particle **lë** 'SIM' co-occurs with imperfective aspect particle **tu** 'DEF.CONT' to encode the meaning of simultaneous definite continuative. The implication is that no matter what circumstances are in opposition, the action goes on as illustrated in the following example.

- (32) **i lë tu tetak kekeseak la wat ë**
 3s SIM DEF.CONT go.up disobey.wise.counsel go.to high OBL
patpat a um.
 table and house
'He just kept on going up there on the platform and house against their wishes.'

The perfect aspect particle **lë** 'SIM' co-occurs with the continuative aspect particle **tö** 'CONT' to encode the meaning of simultaneous continuative. This is exemplified in example (33).

- (33) **Namo lë tö pe mangat**
 Namo SIM CONT do work
'Namo just keeps on working.'

The perfect aspect particle **lë** 'SIM' co-occurs with the progressive aspect particle **ën** 'PROG' to encode the meaning of simultaneous progressive as illustrated below.

(34) **mwaen sala i pē ri lēklēk i lē ēn ri i lē**
male old 3s COMP pull basket 3s SIM PROG pull 3s SIM

ēn ri aa
PROG pull move

'The old man pulled the basket, he kept on pulling and pulling and it moved (little by little).'

With **lē ēn** 'SIM PROG', the implication is that there is progression in the action. With **lē tō** 'SIM CONT', there is no such implication. This can be seen in the difference in meaning in the following two examples. In example (35), the progression is expressed with the idea of 'taking into', while the lack of progression is expressed in example (36) with the idea of 'carrying inside'.

(35) **ep lē ēn lēp ö la lälön tölē**
1p SIM PROG take 2s go.to inside drum

'We were taking you into the karamut drum.'

(36) **ep lē tō lēp ö la lälön tölē**
1p SIM CONT take 2s go.to inside drum

'We were carrying you inside the karamut drum.'

The perfect aspect particle **ē** 'PERF' co-occurs with the continuative particle **tō** 'CONT' to encode the meaning of anterior continuative. This combination corresponds to the typical 'present perfect' tense. This is illustrated in the following example, as something this person had already been doing for a long time and is still continuing to do, or at least that there is continuing relevance from her actions.

(37) pulen sip ta ë tö pe tipoop to i -a tö
habit one SUB PERF CONT do long.ago that 3s-NEG CONT

pang ip titsa pwän
feed 3p teacher not

'This habit that [she] has already been doing long ago was, she was not feeding the teachers.'

The perfect aspect particle ë 'PERF' co-occurs with the definite continuative particle tu 'DEF.CONT' to encode the meaning of anterior definite continuative. This combination corresponds to the typical 'past perfect' tense. The speaker is reporting this incident to someone else. In this case, the activity had already been going on a long time, but it is not going on at the present time.

(38) ip ë tu topur mwasön nik to kel talap
3p PERF DEF.CONT kill many fish put canoe 3p:RCP

'They had already been killing many fish and had been putting them into their canoe.'

The perfect aspect particle ë 'PERF' co-occurs with the progressive particle ën 'PROG' to encode the meaning of anterior progressive. This is exemplified below, with the idea that the activity had been going on for a time and there was change throughout. In this example, the change is that of spatial location while paddling the canoe.

(39) som ë ën tōng lēp kēl tö aa molok
one PERF PROG paddle take canoe CONT move behind

'One had already been paddling the canoe, following behind.'

The perfect aspect particle pë 'COMP' may co-occur with the definite continuative particle tu 'DEF.CONT' in the realis mode to

encode the meaning of completive definite continuative. This combination is used in reporting the incident to someone else and encodes past tense. The implication is past habitual as illustrated in the following clause.

(40) **ip not talap pë tu ananaek**
 3p child 3p:RCP COMP DEF.CONT go.away

'Their children have been going away./Their children used to go away.'

The perfect aspect particle **pë** 'COMP' may co-occur with the continuative aspect particle **tö** 'CONT' to encode the meaning of completive continuative. **pë tö** 'COMP CONT' is also used to encode the habitual past. This combination can be used when talking directly to the person involved in the incident.

(41) **o tö mwang talap petia-n ip titsa a ip**
 2s:IRR CONT berate 3p:RCP wife -3s:POSS 3p teacher and 3p

not talap pë tö ananaek
 child 3p:RCP COMP CONT go.away

'You are berating all the teachers' wives and their children have been going away.'

The perfect aspect particle **pë** 'COMP' co-occurs with progressive aspect **ën** 'PROG' to encode the meaning of completive progressive. This combination can be used to encode an iterative meaning as seen in example (42). Each man had his own club and they each threw their own club at the eagle one at a time, rather than all at the same time. The progressive aspect is used to show that change occurred from when the first man threw his club until the last man had thrown his club. The change is in the fact that

eventually no man was holding his club. In example (43), the change is the change of spatial location.

(42) ip ramat pë_ën aek lilip la tē Napetie
3p man COMP PROG throw club go.to 3s:RCP Napertie

topong
this

'All the men threw (their) clubs at this Napetie.'

(43) i pë_ën pungto rei -n uru la sal
3s COMP PROG sniff smell-3s:POSS 3d go.to road

'He kept on following the scent of those two along the road.'

2.3. Irrealis Status

Status is defined by Foley (1986:158) as expressing the actuality of the event: Has the event been realized or not? Chung and Timberlake (1985:241) use the term 'mood', which they characterize as the actuality of an event by comparing the event world(s) to a reference world, which is normally the actual world. There are two distinctions, realis and irrealis. There is usually only one way that an event is actual (realis), when it is identical to the actual world. But there are different ways that an event may be non-actual (irrealis). Realis in Lou is unmarked and is used for actual events, past and present as the following example illustrates.

- (44) i tēk kōtōrōt ē samēl
3s cut sugarcane OBL knife
'She cut the sugar cane with the knife.'

Other Oceanic languages have been analyzed as having more than one distinction of irrealis modality. Lichtenberk, in his description of Manam, identifies three sub-types of irrealis: 'definite', 'indefinite', and 'prospective' (1983:185). Johnston, in his description of Nakanai distinguishes two sub-types of irrealis: 'non-imminent' and 'imminent'. Bugenhagen, in an article on modality in Mangap-Mbula argues for five sub-types of status: 'assertion of factuality', 'non-assertion of factuality', 'presupposition of factuality', 'assertion of non-factuality', and 'assertion of uncertainty regarding the factuality of a

proposition' (1989:13). Lou seems to distinguish several subtypes of irrealis as well.

Lou marks irrealis with the particles **ki** and **ka**. **ki** (46) co-occurs with the third person singular subject, having been formed from **k-** 'future marker' and **i** 'third person singular' pronoun. The irrealis form for first person singular is the portmanteau morpheme **ngka** '1s:IRR' (45), a combination of **nga** '1s' and **ka** 'IRR'. **ka** (47) occurs with all other persons and numbers.

(45) **ngka** **pë** **söngum** **la** **tei**
1s:IRR COMP marry go.to 3s:RCP
'I will marry him.'

(46) **i** **ki** **pë** **tik** **lëp** **epi** **mwantön** **nik** **menengan** **a**
3s 3s:IRR COMP grab take sago plenty fish big and
tölë
drum
'He would have taken more sago, big fish and drums.'

(47) **tarap** **ka** **pepwën** **tapö** **tem**
1p.in IRR complete this now
'We will finish this now.'

Ross (1988:367) states that in most languages of the Manus group of the Admiralties, the future marker **k-** (<POC *g-), which is prefixed to subject proclitics, is omitted in second person. This is true in Lou as well. No form of **k-** occurs with the second person singular subject.

(48) *o **ka** **pepwën** **tapö** **tem**
2s IRR complete this now
'You will finish this now.'

The irrealis particle occurs in the first structural position of the simple verb phrase. In Lou, irrealis is used for future events, both probable and improbable. It is associated with dubitativity, conditionals, and contrafactuals. Thus it could be translated into English with 'will', 'might', 'should', or 'could'.

When the irrealis particle **ka** or **ki** occurs in a verb phrase without any aspect particles, it encodes indefinite irrealis. Indefinite irrealis is used in the apodosis of contrafactuals, the condition clause in hypothetical conditionals (49), in clauses expressing purpose (50), complement clauses (51) and (52), and in all negative clauses (53).

(49) kapa i ki me a ngka pē aa
 if 3s 3s:IRR come and 1s:IRR COMP move
 'If he comes, I'll go.'

(50) i me petita i ki la ut sō kēm
 3s come because 3s 3s:IRR go.to dip some salt
 'He came in order to get some salt.'

(51) nga pa ngka la Lorengau
 1s DES 1s:IRR go.to Lorengau
 'I want to go to Lorengau.'

(52) o tö rangrang ta o pa i ki la Moresbi
 2s CONT like SUB 2s DES 3s 3s:IRR go.to Moresby
 'You want him to go to Moresby.'

(53) a nga pa "ētē ka sa aa pwän"
 and 1s DES 1pc IRR IRR:NEG move not
 'And I said, "We will not go."'

The indefinite irrealis occurs in subordinate clauses encoding conative meaning as evidenced below.

(54) i tō pe ta i pa ki pong ramat
3s CONT do SUB 3s DES 3s:IRR wake person

'He tried to wake up the man.' (lit. *'He was doing that he wanted to wake the man.'*)

The common denominator in the environments containing indefinite realis listed above is the embedded or subordinate clause, as opposed to the matrix or coordinate clause. However, we will see that although definite irrealis occurs most frequently in the coordinate clause, it is not excluded from appearing in the subordinate clause as well.

The irrealis particle may co-occur with some of the perfect aspect particles and all of the imperfective aspect particles. It may also co-occur with several of the perfect-imperfective aspect combinations. The following chart captures the possible combinations.

Table 9. Aspect Combinations with Irrealis¹⁸

ka		Indefinite Irrealis	
ka	pē	Definite Irrealis	
ka	pē	ën	Definite Progressive Irrealis
ka	pē	tö	Definite Continuative Irrealis
ka	pē	tu	Definite Imminent Irrealis
ka	lë		Simultaneous Irrealis
ka	lë	ën	Simultaneous Progressive Irrealis
ka	lë	tö	Simultaneous Continuative Irrealis
ka	lë	tu	Simultaneous Imminent Irrealis
ka	tö		Continuous Irrealis
ka	tu		Imminent Irrealis
ka	ën		Progressive Irrealis

The irrealis particle may co-occur with the perfect aspect particles, **pē** 'COMP' and **lë** 'SIM', but never with **ë** 'PERF'. When **ka** 'IRR' and **pē** 'COMP' occur in the same verb phrase, the meaning is that of definite irrealis and is best translated with the English word 'will'. Definite irrealis occurs in declarative statements expressing determination (55), obligation, ability, possibility (56), and necessity.

- (55) **ëp ka pē lëp ö la lälön tölä**
 1p IRR COMP take 2s go.to inside drum
 'We will take you inside the karamut drum.'

- (56) **i ki pē tik lëp epi mwantön nik menengan a**
 3s 3s:IRR COMP grab take sago plenty fish big and
tölä
 drum
 'He will take more sago, big fish and karamut drums.'

¹⁸ Although only **ka** is listed in the chart, **ki** and **ngka** may co-occur with the same aspectual combinations as **ka** does.

Definite irrealis occurs in a complement clause expressing certainty about the occurrence of a future event (57); in the apodosis of a conditional sentence (58); in clauses expressing intention (59); and in clauses expressing possibility (60).

(57) **nga tö pasek ta i ki pē me**
 1s CONT know SUB 3s 3s:IRR COMP come
 'I know that he will come.'

(58) **kapa i ki me a ngka pē aa**
 if 3s 3s:IRR come and 1s:IRR COMP move
 'If he comes, then I will go.'

(59) **i pa ki pē aa ma i a aa pwën**
 3s DES 3s:IRR COMP move but 3s NEG move not
 'He wanted to leave, but he didn't.'

(60) **aman ngka pē apur kouka**
 maybe 1s:IRR COMP cook sweet.potato
 'Maybe I will cook kaukau.'

The irrealis particle may co-occur with **lē** 'SIM' to encode the meaning of simultaneous irrealis. The simultaneity of the event is in reference to the time axis, which may be the moment of speaking or the moment of some other event. In example (61), the time axis is a moment during the argument and the event is 'the running', which hasn't happened in the actual world. In example (62), the time axis is the moment of speaking and the event is 'the bad temper killing the speaker'.

(61) i pwakpwak pēin som ta i ki lē tepelek a i
 3s large female one SUB 3s 3s:IRR SIM run and 3s

ki pē opmat mat ong.
 3s:IRR COMP slap die 1s:OBJ

'She was a large woman, who would just then run and she would have slapped and killed me.'

(62) i pa, "Oo ti palaak tang ki lē mat ong
 3s DES yes EMPH temper 1s:RCP 3s:IRR SIM die 1s:OBJ

tem"
 now

'He said, "Yes, my bad temper will just now kill me."

The irrealis particle never occurs with *ē* 'PERF' as shown by the ungrammatical example presented here.

(63) *ēp ka ē lēp ö la lälön tölē
 1p IRR PERF take 2s go.to inside drum

The irrealis particles *ka* 'IRR' and *ki* '3s:IRR' may occur with the continuative particle *tō* 'CONT' to encode the meaning of continuative irrealis. This combination encodes a weak desiderative meaning.

(64) i ki tō nēnē a ö pē tō rōng
 3s 3s:IRR CONT talk and 2s COMP CONT hear

'He wants to talk and you should be listening.'

The irrealis particles *ka* 'IRR' and *ki* '3s:IRR' may occur in combination with the definite continuative particle, *tu* 'DEF.CONT'. The combination of the irrealis particle *ka* 'IRR' and the definite continuative aspect particle *tu* 'DEF.CONT' encodes the notion of imminent irrealis. Nakanai of New Britain has a separate irrealis particle, *ga*, to encode imminent irrealis, which co-occurs with aorist, continuative, perfective, and imperfective

aspects (Johnston 1980:63). In the following Lou example, **ki tu** '3s:IRR DEF.CONT' encodes urgency, along with continuative notions.

- (65) **tamuna ki tu malë ë kwarö la të God**
 every 3s:IRR DEF.CONT hurry OBL call go.to 3s:RCP God
 'Every(one) must hurry to call to their God.'

The irrealis particle occurs with **ën** 'PROG' to encode the meaning of progressive irrealis. This combination also encodes a weak desiderative meaning, but with the progressive implication that the killing would occur one person at a time in the following example.

- (66) **ngka pë ning ta ka ën lëp -mat ip siin tang**
 1s:IRR COMP see SUB IRR PROG take-die 3p clan 1s:RCP
 'I see that (someone) could be killing my clan.'

The irrealis particles **ka** 'IRR' and **ki** '3s:IRR' may also occur with the aspectual combination **pë tö** 'COMP CONT' to encode the meaning of definite continuative irrealis. There is a habitual future implication with this combination. This is illustrated with the prophetic statement below.

- (67) **ap ka pë tö anwal tin**
 2p IRR COMP CONT win fight
 'You will be winning the fights.'

The irrealis particles **ka** 'IRR' and **ki** '3s:IRR' may occur with the aspect combination **pë tu** 'COMP DEF.CONT' to encode the meaning of definite imminent irrealis. With this combination there is an implication that the speaker is not being very polite.

- (68) i ki pē tu pa sa wot to
 3s 3s:IRR COMP DEF.CONT DES what go 2s:RCP
 'What will he say to you?'

The irrealis particles **ka** 'IRR' and **ki** '3s:IRR' may occur with the aspect combination **pē ēn** 'COMP PROG' to encode the meaning of definite progressive irrealis. This combination is not as definite as **ka pē tu**. **ki pē ēn** is a more polite form than **ki pē tu**.

- (69) i ki pē ēn pa sa wot to
 3s 3s:IRR COMP PROG DES what go 2s:RCP
 'What will he say to you?'

The irrealis particles **ka** 'IRR' and **ki** '3s:IRR' may occur with the aspect combination **lē ēn** 'SIM PROG' to encode the meaning of simultaneous progressive irrealis. This is illustrated in the following example. The notion of simultaneity lies in the fact that the preparation would occur at the same time as those twelve months were going by. The progressive notion rests in the fact that as time went along, the women would be more and more prepared.

- (70) pul sangaul a ruēp to ka lē ēn mwenmweneek ip
 moon ten and two that IRR SIM PROG prepare 3p
 notu -n -pēin to ē riap pian a puangke
 child-3s:POSS-female that OBL clothes good and food
 somwa
 excellent

'During those twelve months [they] would just be preparing those young women with good clothes and excellent food.'

The irrealis particles **ka** 'IRR' and **ki** '3s:IRR' may occur with the aspect combination **lë tö** 'SIM CONT' to encode the meaning of simultaneous continuative irrealis. This combination implies permission in the context of this example.

(71) **Boas pa ngka lë tö pe mangat ë konum tei a**
 Boaz say 1s:IRR SIM CONT do work OBL garden 3s:RCP and

ki pë tu ë ta ka la riöt sopwi
 3s:IRR COMP DEF.CONT OBL SUB IRR go.to count finish

kon
 corn

"Boaz said I can just stay working in his garden until (they) will finish gathering grain."

The irrealis particles **ka** 'IRR' and **ki** '3s:IRR' may occur with the aspect combination **lë tu** 'SIM DEF.CONT' to encode the meaning of simultaneous imminent irrealis. This combination implies obligation and also refers to given information. It is not a very polite form.

(72) **i ki lë tu pa sa wot to**
 3s 3s:IRR SIM DEF.CONT DES what go 2s:RCP

'What will he say just then to you?'

The irrealis particles **ka** 'IRR' and **ki** '3s:IRR' may not occur with the combinations **ë tö** (73), **ë tu** (74) and **ë ën** (75) for the same reason the irrealis particle may not co-occur with the perfect aspect particle, **ë** 'PERF' (page 54).

(73) *i ki ë tō pa sa wot to

(74) *i ki ë tu pa sa wot to

(75) *i ki ë ën pa sa wot to

2.4. Negative Polarity

According to Givón, negation is one member of the set of propositional modalities. His schema for the primary categories of modality is presented in Table 10 (1984:321).

Table 10. Propositional Modality

PRESUPPOSITION	taken for granted as true
REALIS-ASSERTION	strongly asserted as true
IRRREALIS-ASSERTION	weakly asserted as true
NEGATIVE-ASSERTION	asserted as false

In natural language, negation is a complex functional domain, comprised of three different but inter-dependent aspects: propositional semantics, subjective certainty, and discourse-pragmatics. In negation, propositional semantics refers to the reversal of the proposition's truth value. Subjective certainty in terms of negation, pertains to a mid-level of certainty a speaker may assign to his assertion that a situation did not occur.

Within discourse-pragmatics, negation is defined as a distinct speech-act of 'denial', uttered within a well-defined sub-clause of the 'communicative contract'. The major discourse function of declarative affirmative sentences is to impart new information. However, the major discourse function of a

declarative negative sentence is not to impart new information, but to deny or contradict a belief that the speaker assumes the hearer to hold.

Lou marks negation with a discontinuous negative. Clauses in the realis mode occur with the pre-verbal particle **a** 'NEG' (76) and clauses in the irrealis mode occur with the pre-verbal particle **sa** 'IRR:NEG' (77). Both realis and irrealis negative clauses end with a clause final negator, **pwën** 'not'.

(76) **ip a la olunga -n ip petia-n ip**
 3p NEG go.to accompaniment-3s:POSS 3p wife -3s:POSS 3p

pwën
 not

'They did not take along their wives.'

(77) **ma kapa ap ka sa lëp tölë Kuam pwën...**
 but if 2p IRR IRR:NEG take drum Kuam not

'But if you will not take the Kuam drum...'

When clauses within a subordinate clause are conjoined with the coordinating conjunction, **a** 'and', each clause is negated with the negative particle in the pre-verb position, and each clause ends with the clause final negator, **pwën** 'not'. Note that in the following example, **pwën** 'not' occurs just before the coordinating conjunction **a** 'and' and again at the end of the sentence.

(78) **ma tē kamwōu -n [ta i pa not [ki**
 but 3s:RCP dispute-3s:POSS SUB 3s DES child 3s:IRR

sa mimi la um pwën] a [ki sa
 IRR:NEG urinate go.to house not and 3s:IRR IRR:NEG

pëëk la um pwën]]
 excrete go.to house not

'But her dispute was that she wanted children to not urinate in the house and to not excrete in the house.'

When a complement clause is embedded in an coordinate clause, the coordinate clause is negated with the negative particle in the pre-verb position and the clause final negator, **pwën** 'not' is placed at the end of the coordinate clause, following the embedded complement clause. In the example given here, the subordinate clause **[ta i peti sap maatan ramat sip tē i peti sap siin sip]** could be lifted out of the coordinate clause, leaving the coordinate clause **Esta i-a awak pwën** 'Esther did not tell'.

(79) **Esta i -a awak [ta i peti sap maata-n**
 Esther 3s-NEG tell SUB 3s belong.to what group-3s:POSS

ramat sip tē i peti sap siin sip] pwën
 person one ALT 3s belong.to what clan one not

'Esther did not tell that she belonged to which group of people or she belonged to which clan.'

In both the irrealis mode and the realis mode, the negative occurs only with the imperfective aspect particles. The negative does not occur with the perfect aspect particles. The following chart lists the possible combinations.

Table 11. Combinations of Aspect with Negative

	a		negative realis
	a	tō	negative continuative realis
	a	tu	negative definite continuative realis
	a	ën	negative progressive realis
ka	sa		negative irrealis
ka	sa	tō	negative continuative irrealis
ka	sa	tu	negative imminent irrealis
ka	sa	ën	negative progressive irrealis

The negative realis particle **a** 'NEG' occurs with the continuative particle **tō** 'CONT' to encode the meaning of negative continuative realis (negative present tense).

- (80) **ip a tō rōng nenewa to pwën**
 3p NEG CONT hear word 2s:RCP not
 'They are not obeying your word.'

The negative realis particle **a** 'NEG' occurs with the definite continuative particle **tu** 'DEF.CONT' to encode the meaning of negative definite continuative realis (81). The negative particle also occurs with the progressive particle, **ën** 'PROG' (82), to encode the meaning of negative progressive realis.

- (81) **Napetie la ning ta kolponu i a tu pwir ë**
 Napetie go.to see SUB snake 3s NEG DEF.CONT weak OBL

tetak la wat pwën a i pa, "Toru ka söng la
 go.up go.to high not and 3s DES 1d.in IRR run go.to

sut ta tii."
 one SUB put.separate

'Napetie went and saw that the snake was not weakened from climbing up there and he said, "We two must run away to a different place.'"

- (82) **Jon i a ën ning lili i la -ë tilitil pwën**
 John 3s NEG PROG see again 3s go.to OBL mirror not
'John did not keep looking at himself in the mirror.'

The negative irrealis particle **sa** 'IRR:NEG', occurs with the continuative particle **tö** 'CONT' in the irrealis mode to encode negative continuative irrealis. This combination is neutral with respect to modality as illustrated below.

- (83) **ngka sa tö pe soreek sö telinga-n lapan**
 1s:IRR IRR:NEG CONT do noise some ear -3s:POSS chief
pwën
 not
'I will not be making noise in the chief's ear.'

The negative irrealis particle **sa** 'IRR:NEG' occurs with the definite continuative particle **tu** 'DEF.CONT' in the irrealis mode to encode negative imminent irrealis. This combination implies a strong commitment on the part of the speaker.

- (84) **ngka sa tu pe soreek sö telinga-n**
 1s:IRR IRR:NEG DEF.CONT do noise some ear -3s:POSS
lapan pwën
 chief not
'I will definitely not make noise in the chief's ear.'

The negative irrealis particle **sa** 'IRR:NEG' occurs with the progressive particle **ën** 'PROG' in the irrealis mode to encode negative progressive irrealis. This combination implies politeness.

- (85) ngka sa _____ ën pe soreek sö talinga-n
 1s:IRR IRR:NEG PROG do noise some ear -3s:POSS

lapan pwën
 chief not

'I don't want to make noise in the chief's ear.'

The negative particle does not occur with any of the perfect aspect particles in either the realis or irrealis mode, as demonstrated with the following ungrammatical examples.

- (86) *ip a _____ ë ën masarën pwën
 3p NEG PERF lie outside not

- (87) *ip a _____ pë sot aa punan peti Pwëk pwën
 3p NEG COMP go.up move valley belong.to Pwëk not

- (88) *Namo i a _____ lë tö pe mangat pwën
 Namo 3s NEG SIM CONT do work not

- (89) *ip ka sa _____ ë ën masarën pwën
 3p IRR IRR:NEG PERF lie outside not

- (90) *ip ka sa _____ pë sot aa punan peti Pwëk
 3p IRR IRR:NEG COMP go.up move valley belong.to Pwëk

pwën
 not

- (91) *Namo ki sa _____ lë tö pe mangat pwën
 Namo 3s:IRR IRR:NEG SIM CONT do work not

2.5. Directional Aspect

Directional aspect particles have been grammaticalized from verbs and they encode the direction in which the action of the main verb takes place. The directional aspect particles are a closed class and are listed in Table 12.

Table 12. Directional Aspect Particles

la	'go to'
me	'come to'
sa	'come up'
si	'come down'
sot	'go up (short distance)' [from sa + wot]
suot	'go down (short distance)' [from si + wot]
wot	'go (short distance)'

All directional aspect particles may function as either aspectual particles or as main verbs. An example of **la** 'go.to' functioning as a main verb follows.

- (92) **i** **la** **Lorengau**
3s go.to Lorengau
'He went to Lorengau.'

When directional aspect particles occur in conjunction with motion verbs, their main function is to encode the direction of the motion. When they occur with some non-motion verbs they encode some aspectual and modal notions. Lee (1974:25) found that directional suffixes in the Kosraean and Ponapean languages of Micronesia contributed aspectual and other notions to non-motion verbs. This meaning was then occasionally extended to motion verbs as well.

One argument supporting the thesis that directional aspect particles in Lou also function to encode aspectual notions is based on the structural position in which they occur in the verb phrase. When the directional aspect particles co-occur with perfect and imperfective aspect, they are positioned between the two aspectual particles. In example (93), the directional aspect

particle **la** 'go.to' is positioned between **pë** 'COMP', the perfect completive aspect particle, and **tö** 'CONT', the imperfective continuative aspect particle.

- (93) **i pë la tö lëp epi lälön suar**
 3s COMP go.to CONT take sago inside sago.grove
'He went to be taking sago inside the sago grove.'

Earlier it was mentioned that inner operators are found to be closer in proximity to the verb root than outer operators. This principle suggests that the directional aspect particles have the status of being somewhere between an outer operator and an inner operator, since we have already established that the perfect aspect particles are more tense-like than the imperfective aspect particles.

Example (94) illustrates a verb phrase containing a directional aspect particle in conjunction with a motion verb. Here **suot** 'go.down' functions as directional aspect and **aa** 'move' functions as the main verb. **suot** 'go.down' contributes the direction of motion to the main verb **aa** 'move'.

- (94) **kanën patipëng pa këlëpëng noun pulen tonga ip pë**
 far morning DES night date dawn and.then 3p COMP

suot aa la paë
 go.down move go.to low
'It was in the early morning hours and then they went down (the hill).'

In the remainder of this section, the functions of the directional aspect particles with both motion and non-motion verbs is illustrated. The most frequently occurring directional

aspect particle is **la** 'go to'. Its primary sense is that of movement directed away from the deictic center. In the unmarked instance, the speaker is the deictic center. When **la** 'go.to' is used in conjunction with a main verb of motion in the pre-verbal position, it determines the direction of motion. In example (95), Napetie goes looking for food away from where they are staying, in order to bring it back to where they are staying, which is the deictic center of the sentence.

(95) **uru tö eri a Napetie pē la tö ik puangke**
 3d stay it and Napetie COMP go.to CONT look.for food

me kalaru
 come 3d:RCP

'They two stayed there and Napetie went looking for food for them.'

In the following example, Napetie's flying position before falling is the deictic center, and **la** 'go.to' reveals that he moved away from that position as he fell.

(96) **Napetie i la löt la tet**
 Napetie 3s go.to fall.down go.to ocean

'Napetie fell into the ocean.'

la 'go.to' encodes inceptive aspect when it modifies a non-motion verb. An interesting similarity occurs in Nuclear Micronesian. In his study of Nuclear Micronesian verbs and directional suffixes, Marck (1991) describes the extended meanings of the directional suffixes when occurring with non-motion main verbs. Although ***sake** 'to go up' is often used as the inceptive, with the verb ***maturu** 'to be asleep', "the inceptive is derived

with **la* ‘away’” (Marck 1991:228). In the following Lou example, the directional aspect particle, *la* ‘go.to’, encodes the meaning of ‘begin’.

- (97) *i la nesek la tei a Pwano i pa* “Teak a
 3s go.to tell go.to 3s:RCP and Pwano 3s DES stop and
uru ka pē me ē nenewa ē kot
 3d IRR COMP come OBL word OBL court

‘He began to tell him and Pwano said, “Stop and they two will come bring words to court.”’

In the discourse from which example (98) is excerpted, Napetie’s mother has been talking for awhile and finally in the example Napetie began to listen.

- (98) *Napetie i la rōng nenewaē tē tina -n*
 Napetie 3s begin listen word 3s:RCP mother-3s:POSS

‘Napetie began listening to the words of his mother.’

When *la* ‘go.to’ is used in conjunction with a predicate adjective, it also has an inceptive meaning, referring to the inception of a state, ‘to become’. In the following examples, *la* ‘go.to’ encodes the meaning of beginning a state of being strong (99) and a state of being dry (100).

- (99) *ip Pitilu la pwaēn ē lumu-n Napetie*
 3p Pitilu go.to strong OBL hair-3s:POSS Napetie

‘The people of Pitilu became (began to be) strong with Napetie’s feathers.’

- (100) *pang i la posa a ip pē pe mangat*
 rain 3s go.to dry and 3p COMP do work

‘When the rain stopped (began to dry), they started working.’

The primary sense of **me** 'come' is movement toward the spatial deictic center, as demonstrated in the following example. The watching people are located at the spatial deictic center in this example, and the bird came flying toward them.

- (101) **ip ramat pa ka ning-ning a i me öp**
 3p person DES IRR see -see and 3s come fly
'The people wanted to see and he came flying.'

The directional aspect particles may also be used to point to and from temporal deictic centers. The unmarked choice for the temporal deictic center is the present time. In example (102), the directional aspect particle **me** 'come' is pointing toward the temporal deictic center 'today'.

- (102) **i me tep taem 1991**
 3s come reach today 1991
'(The story) has come up till today, 1991.'

When **me** 'come' is used in conjunction with a non-motion verb, it may encode the notion of intent. In the following example, the intent was for the queen to show off her beauty. In example (112), the man came with intentions of raping the speaker, although he never carried out his intentions.

- (103) **i ki to köpköpön päin -lapan la**
 3s 3s:IRR put roof female-chief go.to
para-n a ka me totoek mwelea-n
 head-3s:POSS and IRR come show beauty-3s:POSS
la talap ramat a ip lapana-n ponu
 go.to 3p:RCP person and 3p chief -3s:POSS village
'She should put her crown on her head and should come show her beauty to all the people and the king's place.'

The directional aspect particle **wot** 'go' encodes horizontal movement away from the deictic center for a short distance. Whereas **wot** 'go' encodes a short distance (104), **la** 'go.to' is neutral concerning the amount of distance.

(104) **i pë wot pit a i pë okto**
 3s COMP go stretch.out and 3s COMP hold

nasön ke të lapan
 end tree 3s:RCP chief

'She stretched out and she touched the end of the stick of the chief.'

The primary sense of **si** 'come.down' is movement downward toward the deictic center. It may occur with a motion verb (105) and with some non-motion verbs (106). A further component of its meaning is that the motion takes place toward the front of the deictic center, rather than at the side or back.

(105) **ip pë si aa ë tapong**
 3p COMP come.down move OBL this

'They all came down to here.'

(106) **i pë si lëp tina -n**
 3s COMP came.down take mother-3s:POSS

'He came down carrying his mother.'

The extended meaning that is encoded by **si** 'come.down' seems to be intent, similar to that of **me** 'come' as illustrated in the following example.

(107) **i pa ki si nēnē la tē lapan ē**
3s DES 3s:IRR come.down talk go.to 3s:RCP chief OBL

patampalē ta i ēliek la ē sokto -nan tel la
gallows SUB 3s build go.to OBL tie.knot-NOM vine go.to

porunga-n Modekai
throat -3s:POSS Mordecai

'He wanted to come talk to the king about the gallows that he built for hanging Mordecai.'

The directional aspect particle, **suot** 'go down', which is formed from **si** 'come.down' and **wot** 'go', encodes movement downward away from the deictic center. Whereas **si** 'come.down' is neutral concerning distance, **suot** 'go.down' encodes a short distance. In the following example, the first knife goes down (a short distance) into the pig and hits on the knife that is hidden there. The direction of movement is away from the deictic center, which is the person doing the cutting.

(108) **ma ip Punet pa kasan kalap puō tong ē pelo**
but 3p Punet DES cut 3p:RCP pig that OBL obsidian.knife

a i pē suot tengrit la ē pelo ta
and 3s COMP go.down clang go.to OBL obsidian.knife SUB

i tö lalön puō topong
3s stay inside pig this

'But the Punet (people) wanted to cut their pig with an obsidian knife and it went clang on the knife that was inside the pig (meat).'

The form **sa** 'come.up' encodes movement upward toward the deictic center (109). The extended meaning that is encoded by **sa** 'come.up' seems to be inceptive, similar to that of **la** 'go.to'. In (110), Joseph began to be awake.

(109) **ip pē sa to i la lalön**
3p COMP come.up put 3s go.to inside

'They came put him inside (the karamut drum).'

(110) **Josep sa mamat ë kintir a i pē aa**
Joseph come.up awake OBL sleep and 3s COMP move

molokin ta einsol tē Lapan nesek wot tei
behind SUB angel 3s:RCP lord tell go 3s:RCP

'Joseph awoke from sleep and he followed what the angel of the Lord told to him.'

The directional aspect particle **sot** 'go up', which is formed from **sa** 'come.up' and **wot** 'go', encodes movement upward away from the deictic center for a short distance. **sa** 'come.up' is neutral concerning length of distance, whereas **sot** 'go.up' specifies that the distance is short.

(111) **ip tēt sot wat tonga ip sot ning ponat**
3p chase go.up high and.then 3p go.up see earth

sut eri
one it

'They ran away up high and then they went up and saw that place.'

The directional aspect particles freely occur with all the aspectual particles. Following are some representative examples of aspectual particles occurring with **la** 'go.to' and **me** 'come'.

(112) **i lē me kēm ong tak**
3s SIM come grab 1s:OBJ only

'He just came and grabbed me only.'

- (113) **i tö ning-ning la ë nik a palesam som pä**
 3s CONT see -see go.to OBL fish and shark one COMP
me ngan kosun la të Sintilin a i pa ki
 come bite quickly go.to 3s:RCP Sintilin and 3s DES 3s:IRR
ngan i la porunga-n
 bite 3s go.to throat -3s:POSS
'He was watching for the fish and a shark came quickly to bite Sintilin and it tried to bite him on his neck.'
- (114) **i pa ki la pung -pung la ë ke se supwak**
 3s DES 3s:IRR go.to sniff-sniff go.to OBL tree one tree
uru ë la -k tö wat
 3d PERF go.to-GOAL stay high
'He wanted to go sniffing up one tree they two had been staying at.'
- (115) **o ning ta ip mwaen la tu pe mangat la**
 2s:IRR see SUB 3p male go.to DEF.CONT do work go.to
-k
 -GOAL
'You see that the men are working.'

2.6. Main Verbs

A main verb is a verb that can occur by itself in a clause without any other verbal forms. The head of the verb phrase is a main verb. Example (116) illustrates a main verb as head of the verb phrase.

- (116) **Jon i töktök ë katam**
 John 3s knock OBL door
'John knocked on the door.'

In example (117), **palaak** 'temper', which may function as a noun, functions as the head of the verb phrase and co-occurs with

the completive aspect particle, **pë** 'COMP'. An example of **palaak** 'temper', a noun, functioning as the subject of a sentence was presented in (62).

- (117) **tia -n uru pë palaak a uru pë pe kamwö**
 belly-3s:POSS 3d COMP temper and 3d COMP do quarrel
'They-two were angry and they-two quarreled.'

Stative verb phrases consist of one of the stative verbs, **tö** 'stay' or **tu** 'stay', with pre-verbal particles **pë** (119), **lä** (120), **ë** (121), or without any pre-verbal particles, as in (118) and (122).

- (118) **i tö lälön puö topong**
 3s stay inside pig this
'It was inside this pig.'

- (119) **ëp pë tö kasön Pasta Aka**
 lp COMP stay near Pastor Aka
'We have stayed near Pastor Aka.'

- (120) **ëp lä tö kasön Pasta Aka**
 lp SIM stay near Pastor Aka
'We just stayed (at the same time) near Pastor Aka.'

- (121) **ëp ë tö kasön Pasta Aka**
 lp PERF stay near Pastor Aka
'We had stayed near Pastor Aka.'

- (122) **të ka pa "som mwaen tu tetang"**
 3s:RCP IRR DES one male stay 1s:RCP
'Who will say, "There is my husband?" or "(Someone) will say, "I have no husband."'

A stative clause with **tö** 'stay' may be negated with the negative particle, **a** 'NEG' (123). It may co-occur with the irrealis

particle (124) and may be negated with the negative particle **sa** 'IRR:NEG' in irrealis mode (125).

(123) **Sintilin i -a tö mwamwanget pwën**
Sintilin 3s-NEG stay lazy not
'Sintilin is not lazy.'

(124) **Sintilin ki pä tö mwamwanget**
Sintilin 3s:IRR COMP stay lazy
'Sintilin will be lazy.'

(125) **Sintilin ki sa tö mwamwanget pwën**
Sintilin 3s:IRR IRR:NEG stay lazy not
'Sintilin will not be lazy.'

The directional aspect particle **la** 'go to' may precede **tö** 'CONT'. The definite continuative aspect form **tu** 'DEF.CONT' is also found in this construction (127). The combination of **la tö** 'go.to CONT' seems to encode present time reference, while **la tu** 'go.to DEF.CONT' seems to encode past time reference.

(126) **taem tapö Sintilin la tö ponu tei Nihon**
today now Sintilin go.to stay village 3s:RCP Nihon
'Today Sintilin is at his village on Nihon.'

(127) **i la tu ë pëng nganesëlëp peti tolua**
3s go.to DEF.CONT OBL time seven belong.to feast
'It was the seventh day of the feast.'

Only one verb root suffix has been found to date. The morpheme **-k** 'GOAL' suffixes to the stative verb **tö** 'stay', and the directional verbs **la** 'go.to' and **sa** 'come.up'. It encodes the meaning that the goal has been arrived at. The goal may or may not be expressly stated. According to Ross, there was a verbal

suffix ***-aki** in Proto-Oceanic, which served as a transitivizing particle that was mostly confective,¹⁹ reffective, or instrumental in function. However, he reports that in the Lavongai-Nalik group of New Ireland, reflexes of ***-aki** have a detransitivizing function (1988:377). In Lou, the reflex of ***-aki**, **-k** 'GOAL', also has a detransitivizing function as illustrated in example (128), which was spoken after arriving at the goal.

(128) **ätë ka pë tö -k**
 1pc IRR COMP stay-GOAL
 'We will stay (here).'

A stative clause may occur with a null copula as exemplified by the descriptive clauses in the following example.

(129) **i tourö-n a i menenga-n**
 3s short-3s:POSS and 3s big -3s:POSS
 'He's short and he's big. (This refers to one person.)'

2.7. Adverbs

Adverbs are a closed class of words²⁰, which may operate at the nuclear level modifying just the verb, or at a higher level modifying the whole clause. Some adverbs can function at more

¹⁹ Ross adopted the terms confective and reffective from Harrison (1982). "A confective participant is typically a concomitant, occasionally an instrument, with a verb of motion. A reffective participant is 'typically a stimulus (source, cause, reason, or beneficiary)', usually with a verb expressing a psychological state or action." (1988:417).

²⁰ Other 'adverbial' notions are expressed using noun phrases.

than one level. This section discusses only the nuclear level adverbs.

The characteristic of nuclear level adverbs that distinguishes them from verbs, is whether the form has the potential to occur as a main verb or if it always occurs in conjunction with some other verb. If a form can also function as a main verb, then by this definition it is not an adverb, but a verb occurring in series. The nuclear level adverbs are listed below. Note that many of these may also function as sentence adverbs.

Table 13. List of Adverbs

anek	'away'
ën suë	'little'
kosun	'quickly'
ili	'again'
malë	'quickly'
molokin	'later'
muna	'every'
munek	'too'
patan	'really'
pënginpëngin	'all the time'
posoek	'pleasantly'
pun	'very'
seniek	'regularly'
sopwi	'finish'
tok	'away'
wat	'high'

The normal position for nuclear adverbs is following the main verb (130). It is normally ungrammatical for adverbs to precede the verb (131).

- (130) i aa isimek sopwi
 3s move go.everywhere finish
 'It went everywhere completely.'

- (131) *i aa sopwi isimek
 3s move finish go.everywhere

The only nuclear level adverb that occurs before the main verb is **patan** 'really' (132) and (133). It is ungrammatical for **patan** 'really' to occur after the main verb (134).

- (132) ö lë patan tengsi tel som tong
 2s SIM really feel.sorry vine one that
 'You really feel sorry about that vine.'

(133) i pë patan ngatap la tē tino -ng ë
3s COMP really hard go.to 3s:RCP mother-1s:POSS OBL

ik -ian soan tattarë tang
look.for-NOM funds school 1s:RCP

'It was really hard for my mother to earn my school fees.'

(134) *ö lë tengsi patan tel som tong
2s SIM feel.sorry really vine one that

2.8. Chapter Summary

In this chapter, the simple Lou verb phrase was discussed. The simple verb phrase consists of seventeen optional pre-verbal particles and a main verb. The pre-verbal particles encode status, polarity, perfect aspect, directional aspect, and imperfective aspect. These particles may occur singly or in combinations of up to five in one verb phrase.

Although there are no explicit tense morphemes in Lou, tense is encoded with the different aspectual morphemes. This accords with other Oceanic languages.

Each of the particles was described and illustrated with various examples. A definition was proposed for each particle occurring singly and also for each combination of particles. A section on adverbs was included to give the reader some background on how adverbs inter-relate with verb phrases. Understanding the simple verb phrase is foundational for the next topic, which is serial verb constructions.

Chapter 3. Serial Verb Constructions

As has been mentioned, there are two types of verb phrases in Lou: simple verb phrases and serial verb constructions. In the last chapter simple verb phrases were discussed. In this chapter, serial verb constructions (SVC) are presented.

First of all, verb serialization is defined, functions of serial verb constructions are presented, and types of serial verb constructions are discussed. Then the theory of the layered structure of the clause, including juncture and nexus is described. A literature review follows concerning the implications of the clause layers, specifically the nuclear and core layers, on verb serialization. Diagnostic tests for Lou are outlined to demonstrate how one distinguishes between nuclear layer and core layer serialization.

Secondly, nuclear layer serialization is discussed in detail, covering both same-subject and switch-subject serial verb constructions in Lou. This section is followed by a discussion of core layer serialization, including same-subject and switch-subject serial verb constructions. In Lou, the core layer serial verb construction employs a peculiar type of verb class called a prepositional verb in this thesis. Evidence is presented to demonstrate that this class of verbs are indeed verbs and therefore qualify as serial verbs. Evidence is also furnished to

show that the core layer serial verb construction is actually a single clause rather than a series of clauses. Finally, a chapter summary closes this chapter.

3.1. Introduction

Serial verb constructions have been identified in many of the world's languages, most notably languages of West Africa, many languages in Southeast Asia, and the Papuan languages of Melanesia. More recently some Oceanic languages of Melanesia have also been recognized as having some degree of productive verb serialization.²¹ In this chapter, it will also be shown that verb serialization occurs in Lou.

Durie defines verb serialization as "what happens when two or more verbs are juxtaposed in such a way that they act as a single predicate, taking a unitary complex of direct arguments" (1988:3). Cross-linguistically, serial verb constructions typically have the following characteristics:²² two or more verbs or VPs occur in a series without normal coordination or subordination, and without clause boundary markings, whether morphological or intonational, but with some degree of formal binding, probably phonological. Verbs occurring in SVCs share one or more core (and peripheral)

²¹ See Bradshaw (1993), Crowley (1987), Durie (1988), Early (1993), and Hamel (1993).

²² Both Early (1993) and Durie (1988) give a similar list of characteristics.

arguments, in that either the subjects of the verbs are coreferential (same-subject) or the object of one verb is coreferential with the subject of the other verb (switch-subject). Specifications of polarity, aspect, tense and mood may be shared by all verbs in the series.

There is a "perceived functional semantic unity of the whole expression, but with the contribution of each element recognizable" (Early 1993:67). The verbs involved are depicted as referring to sub-parts or aspects of a single whole event and act as a single predicate. The following example from Namakir, an Oceanic language of Central Vanuatu, illustrates a serial verb construction. **devan** 'be.in.line' is the first verb and **daliw** 'walk' is the second verb in the series.

(135) **na-polis ri devan ri daliw**
 Art-police 3pl be.in.line 3pl walk

'The police marched in line.'

(Sperlich 1994:100)

One of the verbs in the series may be more semantically bleached than the other verb. For example, in the Lou example (136), there are three verbs in series. **pe** 'do' is more generic in meaning than **tékték** 'paddle' or **sot** 'go.up'.

(136) **ip pē pe tékték sot**
 3p COMP do paddle go.up

'They had paddled and gone.'

In some languages, notably Lewo and Paamese of Vanuatu,²³ the main verb class is an open set of verbs, while the serialized verb belongs to a closed set of verbs and perhaps only a few verbs can function as either the main verb or the serialized verb (Early 1993:78). In Lou, the first verb in the series is part of an open class of verbs; hence it is analyzed as the main verb. The second verb in the series comprises a closed class of verbs; the second verb has been analyzed as the serialized verb. Some of the verbs that can occur in a serial verb construction may occur as either the main verb or the serialized verb in the series. *lili* 'do.again' is an example of such a verb. In the following examples, *lili* 'do.again' occurs as the main verb in example (137) and as the serialized verb in example (138).

(137) *Narko pē lili la um tē Solok*
 Narko COMP do.again go.to house 3s:RCP Solok
 'Narko had returned to Solok's house.'

(138) *ip pēin ka rōng lili ip asoa -n ip*
 3p female IRR hear do.again 3p husband-3s:POSS 3p
 'The women will listen again to their husbands.'

However, within a given SVC, the verbs may be crucially ordered. For example, if the verbs *rōng* and *lili* in example (138) are switched in order, the result is ungrammatical because *rōng*

²³ Lewo is spoken on Epi Island and Paamese on Paama Island. Both are Oceanic languages.

'hear' can never occur as a serialized verb at either the nuclear or core layer (139).²⁴

(139) *ip pëin ka lili rōng ip asoa -n ip
3p female IRR do.again hear 3p husband-3s:POSS 3p

Thus, the essence of an SVC is that it contains a series of verbs, functioning as a single unit.

3.1.1. Functions of SVCs

Early (1993) lists the functions of serial verbs to be: 1) encoding of aspect; 2) encoding of temporal, spatial, or psychological movement, distance, or location; 3) encoding of logical relations such as cause and effect, and purpose; and 4) marking various semantic roles, such as instrumental, dative, benefactive, locative, manner, comitative, accusative, and comparison.

The various functions of Lou serial verb constructions are similar. SVCs in Lou encode spatial, psychological, and temporal movement, logical relations, such as cause and effect, and they mark various semantic roles, such as recipient, benefactive, goal, manner, and instrument.

²⁴ More analysis is needed to determine which verbs are allowed to function as the serialized verb in nuclear layer SVCs and which may function only as main verbs. A list of verbs functioning as the serialized verb in core layer SVCs is presented in Section 3.3. Core Layer Serialization.

In the following examples, the SVC encodes psychological and theme notions. In (140), the speaker declares that she will marry 'him', which brings her psychologically (and also physically) closer to the goal. In (141), the SVC encodes theme.

(140) **ngka pē sōngum la tei**
 1s:IRR COMP marry go.to 3s:RCP
'I will marry him.'

(141) **ō pē mwang tang la eri**
 2s COMP berate 1s:POSS go.to it
'You berated me about it.'

In example (142), the SVC encodes the logical relationship of cause and effect. **opmat** 'slap', the main verb, encodes the cause and **mat** 'die', the serialized verb, encodes the effect. Slapping caused the death.

(142) **i ki pē opmat mat ong.**
 3s 3s:IRR COMP slap die 1s:OBJ
'She would have slapped and killed me.'

In example (143), the serialized verb **lēp** 'take' marks the semantic role of the instrument, **paa** 'oar'. **neng** 'row' is the main verb.

(143) **ip neng lēp paa**
 3p row take oar
'They rowed with the oar.'

Givón (1991:82) also adds a fifth function of SVCs, that of 'verb co-lexicalization'. In this type, two or more verbs are co-lexicalized to more accurately specify the semantic components

involved in the event. Lou also has this type of SVC. For example, in the following example, **lëp panak** ‘take steal’ combines the thought of taking (grabbing, holding) physically with the thought of doing it without permission or even other people’s awareness.

- (144) i lëp panak puangke
 3s take steal food
 ‘He stole the food.’

In summary, the various functions of SVCs in Lou are: encoding spatial, psychological, and temporal movement, logical relations, such as cause and effect, and marking various semantic roles, such as recipient, benefactive, goal, manner, and instrument.

3.1.2. Types of SVCs

Verb serialization can be sub-categorized according to the nature of the relationship between the nominal arguments of one verb with the nominal arguments of the other verb in the series. Foley and Olson (1985) identified two types of serial verb constructions; both have been attested to in Lou. The first type is same-subject serialization. This occurs when the subject of the first verb is identical to the subject argument of the second verb. The following example from Paamese illustrates same-subject serialization. The speaker both ‘went’ and ‘missed’ in the example.

- (145) inau nau-vaa tooni aute Navule
 1sg 1sg.real-go miss place Navule
 ‘I went past Navul.’ (Crowley 1987:39)

The following example from Lou represents this type. The subject of both verbs, **apur** 'cook' and **ngan** 'bite', is **ip** 'they (the people)'

- (146) **ip pē rēk i a ip pē apur ngan i pwēep**
 3p COMP kill 3s and 3p COMP cook bite 3s afternoon
'They all killed it and all cooked and ate it in the afternoon.'

The second type of serial verb construction is switch-subject serialization. This occurs when the object of the first verb is coreferential with the subject of the second verb. The following example from Paamese, an Oceanic language, illustrates switch-subject serialization. Second person (you) is the subject of the first verb, **komuasinau** 'hit' and first person (I) is the subject of the second verb, **nauva** 'go'.

- (147) **kaik komuasinau nauva netan**
 2s 2s-real-hit-1sg 1sg-real-go down
'You hit me down.' (Crowley 1987:48)

In the following Lou example, 'the man' did the 'killing' and the 'pig' did the 'dying'. The object **puō** 'pig' of the first verb, **pe** 'do', becomes the subject of the second verb, **mat** 'die'.

- (148) **petita i pe mat puō a nga la Moresbi**
 because 3s do die pig and 1s go.to Moresby
'Because he killed the pig, I went to Moresby.'

There are three other types of SVCs referred to in the literature, which have not been attested in Lou.²⁵ This concludes a brief overview of the characteristics and functions of serial verb constructions and of some of the different types that are

²⁵ Durie (1982) describes a third type of serial verb construction, which Crowley (1987) refers to as ‘multiple object serialization’. In this type of construction, ‘which are relatively rare in the world’s languages, and also diachronically somewhat unstable, there may be same-subject or switch-subject conditions of identity between the subjects of the serialized verbs, each of which is transitive, and each of which has its own object’ (1987:39). An example from Paamese with two objects; **siŪn** ‘gin’ and **oai** ‘water’ illustrates this type (1987:39).

inau namun **siŪn dal** **oai**
 1sg 1sg-real-drink gin 3sg-real-accompany water
 ‘I drank gin with water.’

Crowley (1987) proposes a fourth type of serial verb construction, which he calls “ambient serialization”. In this type there is no specific referent associated with the subject of the second verb, but rather the subject of the second verb refers to the predication or event itself of the first verb. Bradshaw (1993) calls this type of serialization, “verbal-subject” type. Again this type is illustrated with the following example from Paamese. The subject of the second verb is neither the subject or the object of the first verb, but rather the subject of the second verb is the ‘general act of counting’ (1987:40). In this example the serialized verb encodes manner.

kihuliŪn **ato** **kail hemal**
 2sg-dis-count-comm/obj chicken pl 3sg-dis-be correct
 ‘Count the chickens correctly.’

Bradshaw characterizes adverbial serialization as serial verbs functioning as adverbials, in which he distinguishes two types; the “verbal-subject” type mentioned above and a fifth type of serial verb construction he calls “ambient-subject” type. In this type the specific referent associated with the subject of one of the verbs is either a generic weather term or time-adverbial. The subject does not refer to the predication or event of the first verb as described for the ambient type of serialization above. The following example from Numbani illustrates this type (1993:156).

gê-dêng **nô-geng** **Tami sê -lac** **sê-mêng**
 3sR-reach yesterday-Adv Tami 3pR-sail 3pR-come
 ‘Yesterday the Tami people sailed here.’

distinguished in Oceanic languages. In the following section, the layered structure of the clause as presented by Foley and Van Valin²⁶ in their theory of Role and Reference Grammar (RRG) is introduced.

3.1.3. Layered Structure of the Clause

So far, SVCs have been presented within a descriptive framework, concentrating on their characteristics, functions, and types based on the nature of the relationship between the nominal arguments of one verb with the nominal arguments of the other verb in the series. Another way of looking at serialization involves the theory of the layered structure of the clause. Using the theory of clausal layers, one can categorize SVCs according to the layer they occupy in the clause.

According to the theory of Role and Reference grammar, a clause consists of three layers: nuclear, core, and peripheral layers. Grammatical operators like aspect, tense, directionals, and modality act as modifiers of the different layers of the clause. Each of the layers may have one or more operators. The innermost layer is the nucleus which consists of the main verb modified by the inner operators, such as aspect and directionals. Nuclear

²⁶ Foley and Van Valin first published a detailed exposition of their theory of Role and Reference Grammar (RRG) in 1984. In 1993 Van Valin published *A Synopsis of Role and Reference Grammar*, summarizing the main points of the theory, as well as the refinements and expansions that resulted from continuing work in RRG.

operators modify only the event, action, or state without any reference to the participants in the action. In the following English example, the verb **see** is identified as the nucleus.

(149) John saw (see+PAST) Mary in the park yesterday.

In example (150), the nucleus is modified with a nuclear layer operator, progressive aspect. The progressive aspect has no bearing on the participants. It only describes what kind of **seeing** took place.

(150) John was seeing Mary in the park.

The core layer includes the nucleus and the core arguments, usually the actor and undergoer, modified by the core operators, such as some types of modality, some kinds of directionals, and internal negation. The actor is the participant which performs, effects, instigates, or controls the situation denoted by the predicate. The undergoer is the participant that is affected in some way by the action.²⁷ Core operators modify the relationship between a core argument and the action it performed. Modality is an operator at the core layer; having both the nucleus and the core arguments under its scope. In the example below, the core consists of **John was able to see Mary**. **John** and **Mary** are both core arguments and the modal **able** is a core operator.

²⁷ Up till this point in this paper, the traditional terms, subject and object have been used as roughly the same equivalents as actor and undergoer. For the rest of this paper the RRG terminology, actor and undergoer, is used, although the distinction between the RRG terminology and the traditional terminology is not important for the arguments presented in this paper.

refer to the linkage between the juncts. A nuclear junct is a construction with two or more nuclei joined together. It is a single element, and all core and peripheral arguments are arguments of this complex nuclear construction. A nuclear junct is symbolized with three parallel lines (\equiv).

$$P[(NP) \dots (NP_C[NP(NP)_N[\text{Predicate}]_{NN} \equiv_{NN}[\text{Predicate}]_N]_C)]_P$$

In core juncture, two cores are linked together to form a larger complex core. Each core has its own nucleus and core arguments, although a feature of core juncture is that the two cores tend to share one of the core arguments. The peripheral arguments must be shared by both cores, as they form a single composite unit within the peripheral layer. A core junct is symbolized with two parallel lines ($=$).

$$P[(NP) \dots (NP_C[NP(NP)_N[\text{Predicate}]_N]_C =_C [NP(NP)_N[\text{Predicate}]_N]_C)]_P$$

Peripheral junctures entail the joining of two clauses with independent peripheries. A peripheral junct is symbolized with one line ($-$). Since the peripheral layer of the Lou clause is beyond the scope of this thesis, peripheral juncture will only be mentioned briefly in a later section.

$$P[(NP) \dots (NP_C[NP(NP)_N[\text{Predicate}]_N]_C)]_P - P[(NP) \dots (NP_C[NP(NP)_N[\text{Predicate}]_N]_C)]_P$$

Nexus refers to the nature of the relationship between the two joining juncts. There are two oppositions involved in the relationship between the juncts: embedded versus non-embedded and dependent versus non-dependent. *Embedded* refers to one junct

being inside the other junct. *Dependent* refers to one junct sharing its operator specifications with the other junct. There are three ways that two juncts of the same layer can be joined together: in coordination, in subordination, and in cosubordination. Coordination is characterized by the joining of two juncts of equal status, where neither junct is embedded within the other junct and neither junct is dependent on the other junct for specifications of the operators operating at that level. The two juncts are in a whole-whole relationship. Thus coordination is characterized by being -embedded and -dependent.

Foley and Van Valin define subordination as follows: "Subordination differs from coordination in two ways. First, one of the juncts is embedded in the other. Secondly, they are in a part-whole relationship, with the subordinate junct dependent upon the superordinate junct" (1985:239) for operator specifications. Thus subordination is characterized by being +embedded and +dependent.

Cosubordination occurs when neither junct is embedded in the other, but when one junct depends on the other for its specification of one or more of the operators at that level. Thus cosubordination is characterized by being -embedded and +dependent. These three nexus types may be represented in the following figure taken from Foley and Van Valin (1984:242).

Figure 11. Three Nexus Types

a. Coordination: -embedded, -dependent

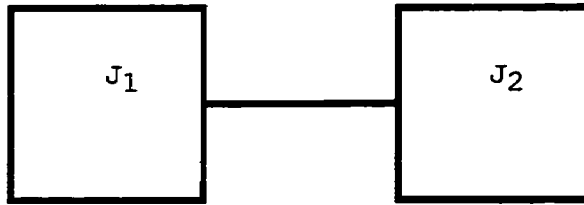

b. Subordination: +embedded, +dependent

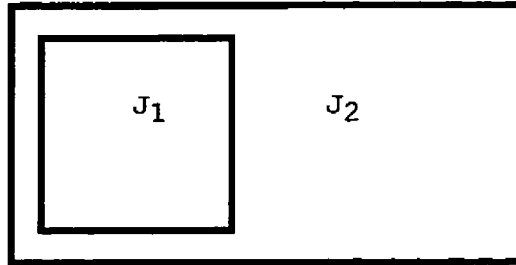

c. Cosubordination: -embedded, +dependent

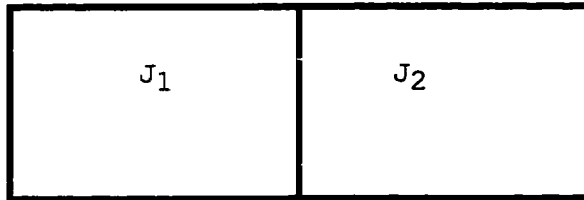

In nexus types that are -embedded, such as, coordination and cosubordination, whether a junct is dependent upon another junct is determined only by the behaviour of the operators. In coordination each junct may be specified independently for operators at the given level of juncture. In cosubordination the juncts may not be specified independently for these operators, but are under the domain of a common operator.

Since there are three nexus types and three layers in the clause, there are nine possible juncture-nexus types: nuclear coordination, core coordination, peripheral coordination, nuclear subordination, core subordination, peripheral subordination, nuclear cosubordination, core cosubordination, and peripheral cosubordination. A discussion of all the different juncture-nexus types in Lou is beyond the scope of this thesis. The different juncture-nexus types are presented here to give some background to the theory of the layered structure of the clause.

This introduction to the theory of the layered structure of the clause has been brief. The next step is to discover how the nuclear layer and core layer of the clause impact verb serialization in Lou.

3.1.5. Clause Layers and Serialization

Although, verb serialization has been recognized for quite some time, it is only relatively recently that layers of the clause - specifically, the nuclear and core layer of the clause - have been utilized to distinguish different types of verb serialization.²⁸ Some languages have one set of verbs which may be used in nuclear layer verb serialization, while another set of verbs is used in core layer verb serialization. Some languages

²⁸ On page 96, several Oceanic languages, which have been analyzed as having SVCs in both the nuclear and core layer are referenced.

may even allow both nuclear and core serialization of the same verb, with an accompanying change of meaning. Foley and Olson (1985) present the following examples from Barai,²⁹ in which the verbs **fi isoe** 'sit write' represent core serialization in example (152) and nuclear serialization in example (153).

(152) **fu fi fase isoe**
3sg sit letter write
'He sat down and wrote a letter.' (Barai)

(153) **fu fase fi isoe**
3sg letter sit write
'He sat writing a letter.'

Thus in example (152), each verb independently chooses its core arguments and only the second verb **isoe** 'write' takes an undergoer argument. In example (153), there is a single choice of the core arguments for the two verbs together. **fu** '3sg' is the actor argument of the complex nucleus and **fase** 'letter' is the undergoer argument of the nucleus, **fi isoe** 'sit write'.³⁰

²⁹ Barai is a Papuan language of Oro province in Papua New Guinea.

³⁰ Olson (1979:250-255) presents several arguments to support this analysis. The first concerns intonational patterns. The core serialization example has two intonation contours, while the nuclear serialization example has only one intonation contour. The second argument concerns the scope of nuclear adverbs. In core layer serialization, a nuclear adverb can modify either nucleus and therefore, may be positioned before either verb. In nuclear layer serialization, the adverb may only modify the nucleus as a unit and therefore, may only be positioned directly in front of the first verb of the series. There is a parallel situation occurring with the nuclear layer negative particle. In core serialization, the negative may negate either nucleus; being positioned before either verb. In nuclear serialization, the negative may only negate the nucleus as a whole and may only be positioned in front of the first verb in the complex nucleus.

In 1982, Crowley described a class of postverbal adjunct modifier particles for Paamese, an Oceanic language. However, by 1987, he had reanalyzed these same forms as nuclear layer serialized verbs. The following example of nuclear serialization in Paamese is taken from his 1987 article (1987:59). **Kisirilu** 'go through' is the main verb and **vaa** 'go' is the serialized verb in the series.

(154) **easu dupasu kisirilu vaa naimo**
 smoke 3sg-real-rise go through 3sg-real-go inside
 'The smoke filtered through inside.'

In addition, Paamese has very productive core juncture verb serialization between the verbs in the SVC. Crowley suggested that similar phenomenon in other Oceanic languages that had been described in a variety of ways in earlier grammars, could also be described as serial verb constructions.

In 1993, Volume 32.1 of *Oceanic Linguistics* was published with several articles dedicated to describing verb serialization on both the core and nuclear layer of the clause in several Oceanic languages. Early (1993) writes that both core and nuclear layer serialization are very prevalent in Lewo. He provides a number of tests in Lewo to distinguish between the two types. These tests will be detailed in the next section. Sperlich (1993) proposes both core layer and nuclear layer serialization for the Namakir language of Central Vanuatu, although being an SVO

language, nuclear layer serialization³¹ is not very productive in Namakir.

Lou also uses the layers of the clause to distinguish verb serialization. Example (155) demonstrates nuclear layer verb serialization, while example (156) demonstrates core layer verb serialization. In the nuclear layer serialization example, no word intervenes between the verbs in series, **apur ngan** 'cook bite', whereas in the core layer serialization example, **nenewa** 'word', functioning as the undergoer argument of the first verb, **to** 'put', and the actor argument of the second verb, **la** 'go.to', intervenes between the two verbs in series.

(155) **ip pë apur ngan i pweep**
3p COMP cook bite 3s afternoon
'They all cooked and ate in the afternoon.'

(156) **i pë to nenewa la tē Pokaröp Punet**
3s COMP put word go.to 3s:RCP Pokaröp Punet
'He sent word to Pokarop at Punet.'

In the following sections, the different clause layers, core and nuclear, are applied to Lou to distinguish SVCs. Tests are detailed to differentiate which SVCs are core layer and which are nuclear layer.

³¹ Foley and Olson (1985) found that nuclear layer serialization is prevalent in SOV languages and more rare in SVO languages. This is discussed in the next section.

3.1.6. Nuclear versus Core Layer Serialization

Foley and Olson (1985) found that nuclear layer serialization is prevalent in SOV languages and less frequent in SVO languages. As an SVO language, Lou falls within this prediction.³² For example, in the narrative presented in Appendix A, there are thirty-two examples of core layer serialization and only ten examples of nuclear layer serialization.

Early uses three diagnostics for determining the degree of binding that exists between the main³³ verb and other verbal elements; thus defining the boundaries of the Lewo nucleus and identifying whether a particular SVC is nuclear or core layer: negativization, nominalization, and object marking. Crowley also uses several diagnostics to define the boundaries of the Paamese nucleus: negativization, nominalization, and verb marking of inflectional categories of subject, mood, and polarity. Of these tests, only the test of nominalization applies to Lou. However this thesis proposes several other diagnostics for Lou as well, to determine when a SVC is a nuclear layer and when it is core layer. They are behaviour of nuclear layer adverbs, syntactic constraints on objects, and presence vs absence of pause.

³² Early (1993) claims that Lewo, which is SVO, is a thoroughly nuclear-serializing language and therefore counters this prediction.

³³ The main verb in Lewo is described as being the first verb in the series and it can occur independently of other verbal elements. The serialized verb in Lewo comprises a closed class of elements. Early states that the actual status (i.e. verbal or non-verbal) of these serialized elements remains a major issue.

(1) Nominalization

Lewo has discontinuous nominalization particles. The prefix attaches to the first verb in the nuclear series and the suffix attaches to the second verb in the nuclear series delineating the boundaries of the nucleus. This Lewo example shows how the verbal nucleus is bounded on both sides with a nominalization particle.

- (157) na-muni-ena
NOM-drink-NOM
'something drinkable'

Whereas Lewo has two morphemes marking a nominalized unit, a prefix **na-**, which prefixes the first verb in the series, and a suffix **-ena**, which suffixes the last verb in the series, Lou has only a suffix **-ian**, which is suffixed to the verb to nominalize it. In the following Lou example, **-ian** 'NOM' is suffixed to **mes** 'celebrate' to nominalize it. **mesian** 'celebration', a noun results.

- (158) **ma wong a lëp ë sö mes -ian ta...**
but I NEG take OBL some celebrate-NOM SUB
'But I cannot have any celebration, while...'

In the following example, **pe mat** 'do die' is a nuclear layer serial verb construction. The suffix, **-ian** 'NOM' is attached to the final verb **mat** 'die', resulting in the noun, **pe matian** 'killing'.

- (159) **Jon tö pasek pe mat-ian puö**
John CONT know do die-NOM pig
'John knows about killing pigs.'

It is not possible to nominalize a core layer serial verb construction as a unit. In example (160), **nesek la** 'say go.to' is a core layer SVC. Attempting to nominalize it as a unit results in the following ungrammatical construction.

(160) **Jon nesek la moneek**
 John say go.to slow
 'John talked slowly.'

(161) ***Jon tō pasek nesek la -ian moneek**
 John CONT know say go.to-NOM slow

This test shows clearly that a nuclear SVC may be nominalized as a unit, whereas a core SVC may not be nominalized as a unit.

(2) Nuclear adverb test

A second test in Lou involves the behaviour of nuclear layer adverbs. The normal position for adverbials occurring with simple verb phrases is following the main verb. In the following example, the adverb **ili** 'again' follows the verb, **apur** 'cook', modifying it.

(162) **ip pē apur ili i pweep**
 3p COMP cook again 3s afternoon
 'They all cooked it again in the afternoon.'

Example (163) exemplifies nuclear layer serialization. The first nucleus is the main verb, **apur** 'cook' and the second nucleus is the serialized verb, **ngan** 'bite'. **apur ngan** 'cook bite' is a nuclear SVC because the adverb **ili** 'again' follows the final verb, modifying the two verbs as a unit. Positioning the adverb between the verbs results in an ungrammatical construction (164).

(163) **ip pē apur ngan ili i pweep**
3p COMP cook bite again 3s afternoon

'They all cooked and ate it again in the afternoon.'

(164) ***ip pē apur ili ngan i pweep**
3p COMP cook again bite 3s afternoon

In core serialization, these adverbials may modify either verb. For example, the following sentence exemplifies core layer serialization. The verb, **ngan** 'bite' is the main verb, the nucleus of the first core, **palesam som pē me ngan kosun**. The verb **la** 'go.to' is the serialized verb, the nucleus of the second core, **la tē Sintilin**. This is an example of a core serial verb construction because the adverb **kosun** 'quickly' may modify the main verb **ngan** 'bite' apart from the serialized verb **la** 'go.to'.³⁴

(165) **...a palesam som pē me ngan kosun la tē**
...and shark one COMP come bite quickly go.to 3s:RCP

Sintilin
Sintilin

'...and a shark came quickly to bite Sintilin.'

(3) Syntactic constraints on Undergoer arguments

A third test in Lou involves syntactic constraints concerning undergoer arguments. In nuclear serialization, undergoer arguments

³⁴ Unfortunately, I haven't had the opportunity to check the grammaticality or meaning of the following construction.

...a palesam som pē me ngan la kosun tē
...and shark one COMP come bite go.to quickly 3s:RCP

Sintilin
Sintilin

may not intervene between the serialized verbs. The normal position for undergoer arguments occurring with simple verb phrases is following the main verb. In the following examples, the undergoer argument is **puö** 'pig'. In example (166), **ngan** 'eat' is the main verb. The normal position for undergoer arguments occurring with nuclear layer SVCs is following the serialized verb. In example (167), **pe** 'do' is the main verb and **mat** 'die' is the serialized verb in this example of a nuclear layer SVC. Example (168) illustrates that positioning the undergoer argument between the verbs in a nuclear layer SVC is ungrammatical.

(166) **i ngan puö**
 3s eat pig
'He ate the pig.'

(167) **i pe mat puö**
 3s do die pig
'He killed the pig.'

(168) ***i pe puö mat**
 3s do pig die

In example (169), which is an example of core layer serialization, the undergoer argument **nenewa** 'word' follows the main verb, **to** 'put'. In this example, **la** 'go.to' is the serialized verb. This illustrates that in core layer SVC, the undergoer argument is positioned between the main verb and the serialized verb. Example (170) illustrates that positioning the undergoer argument after both verbs in a core layer SVC is ungrammatical.

(169) **i pē to nenewa la tē Pokaröp Punet**
 3s COMP put word go.to 3s:RCP Pokaröp Punet
'He sent word to Pokarop at Punet.'

(170) ***i pē to la nenewa tē Pokaröp Punet**
 3s COMP put go.to word 3s:RCP Pokaröp Punet

(4) Presence vs absence of pause

A fourth test is phonological involving pause. In example (163), **pē apur ngan** is one phonological unit which is spoken without any pause between the words. Then there is a slight pause after **ngan** followed by the conclusion of the sentence. In example (159), **pe matian** is one phonological unit with no pause between the words. In the following example, the mark # shows where a slight pause may be taken. **tēt to** 'chase put' is an example of a nuclear layer SVC. No pause is noted between the verbs. However, **pē tēt to i la ululun ke** is an example of a core layer SVC, in which **pē tēt to i** comprises the first core and **i la ululun ke** comprises the second core. A pause is noted between the two cores.

(171) **uru mwi # pē tēt to i # la ululun ke**
 3d dog COMP chase put 3s go.to crawl.space tree
'The two dogs chased it into the outer roots of a tree.'

In this section, four diagnostics have been presented to distinguish between nuclear and core layer SVCs in Lou. They are nominalization, behaviour of nuclear layer adverbs, syntactic constraints, and the presence vs absence of pause. The fundamental test to distinguish between nuclear layer and core layer SVCs in

Lou is, can the SVC participate in these phonological and syntactic processes as a unit. If it can, then it is nuclear layer serialization. If it cannot, then it is core layer serialization.

3.2. Nuclear Layer Serialization

In this section, nuclear layer serialization in Lou is discussed. First nuclear layer serialization is defined, including a discussion on what types of verbs are allowed to enter into nuclear layer serialization. Two arguments are presented to distinguish nuclear layer SVCs from compound verbs; word stress and meaning. This is followed by a section of examples of same-subject nuclear layer SVCs and then a section on switch-subject nuclear layer SVCs.

3.2.1. Introduction

In Lou, the nuclear layer consists of a main verb, which may be optionally modified by the perfect aspect operators **pě** 'COMP', **ě** 'PERF', **lě** 'SIM', the directional aspect operators³⁵ **la** 'go.to', **me**

³⁵ According to RRG (Foley and Van Valin 1984:212, Van Valin 1993:8), directionals may be either nuclear or core layer operators. If the directionals express the directional orientation of the nucleus itself, they are nuclear layer operators. If the directionals express the orientation or motion of one of the participants with respect to the other participant, they are core layer operators.

In Lou, the directionals have been analyzed as nuclear layer operators for two reasons: they express the direction of the action, rather than the direction of the participants; and in the verb phrase the directionals are positioned between the two orders of aspect, both which are nuclear operators.

'come.to', **sa** 'come.up', **si** 'come.down', **sot** 'go.up', **suot** 'go.down', **wot** 'go', and the imperfective aspect operators **tö** 'CONT', **tu** 'DEF.CONT', **ën** 'PROG'. In the following example, the nucleus consists of the verb **pe** 'do' modified by the continuative aspect operator, **tö** 'CONT'.

(172) **kolponu ki tö pe itä la pian**
 snake 3s:IRR CONT do 3pc go.to good

'The snake will be doing good to the three of them.'

In nuclear layer serialization, two or more verbs, are joined together to form a complex nucleus. This complex nucleus functions as a single unit with a common set of nuclear layer operators. The two verbs also share all core layer and peripheral arguments. Foley and Olson (1985:38) diagram nuclear layer juncture with Figure 12.

Figure 12. Nuclear Layer Juncture³⁶

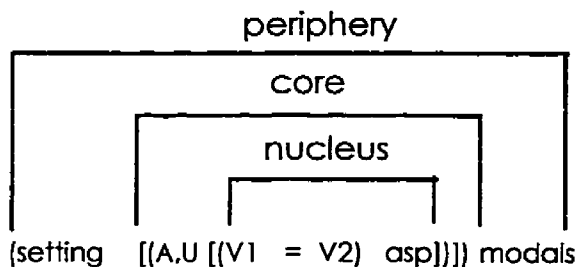



Figure 12 shows a complex nucleus with two verb roots and aspect, embedded in a core, which also includes the actor and

³⁶ A (Actor) and U (Undergoer) are the core arguments in RRG.

undergoer. The periphery contains the core, the setting, and modals.

Not all verbs are equally open to verb serialization. Crowley (1987:69) proposed a hierarchy (presented in the following diagram) of verb types which are most likely to occur in nuclear layer SVCs.

Figure 13. Nuclear Layer Serialization Hierarchy

VERB TYPE	NUCLEAR LAYER
1. Basic motion intransitives 2. Posture/active intransitives 3. Stative/process intransitives 4. Other intransitives 5. Transitives	 increasingly open to serialization

According to this proposal, transitive verbs are the most likely to enter into nuclear SVCs and basic motion intransitive verbs are the least likely to enter into nuclear SVCs.³⁷ This is true for Lou. In fact, only transitive³⁸ and some intransitive verbs may take part in nuclear serialization. Basic motion,

³⁷ The hierarchy for nuclear SVCs is in exact opposition to the one for core SVCs. An explanation for this phenomenon has been attempted on page 116.

³⁸ The definitions which this thesis assumes is as follows: an intransitive verb is one that takes only one core argument, usually an actor argument. A transitive verb is one which takes two core arguments, usually an actor and an undergoer argument.

posture, or stative intransitives are not open to nuclear layer serialization.

The serialized elements in nuclear serialization are tightly bound. Early (1993:72) states that the serialized elements in Lewo can never take person/number prefixes, and they can never be separated by arguments from the main verb. In Lou, the serialized elements can never be separated from the main verb with adverbs or undergoer arguments. The four diagnostic tests for distinguishing between nuclear and core layer serialization previously presented (page 98), indicate the tightly bound nature of the serialized elements in nuclear layer serialization.

Because of the tightly bound nature of nuclear serial verbs, it is difficult to distinguish nuclear layer serial verbs from compound verbs.³⁹ In fact, while it is possible to distinguish serial verb constructions from compound verbs in Paamese, it is not possible to do so in Lewo (Early 1993:65). In Lou, there is only the phonological characteristic of primary word stress which distinguishes between nuclear layer serial verbs and compound verbs.

³⁹ A precise definition for compound words is hard to find. Criteria for defining compounds have been used from phonology, morphology, syntax and semantics, often with contradictory conclusions. Bruce (1986:28) speaks of a 'progression from a marginal lexical status for serial constructions to an unequivocal lexical status for idiomatic compounds' for Alambiak. Lord (1977:150) states for Igbo that once a compound is created, it may take on its own peculiar meaning and syntactic performance, thus becoming lexicalized.

In a compound verb, there is only one instance of primary stress. An example of a compound verb is **ak'mat** 'fall and die', where the second syllable receives the primary stress. In a series of verbs, each verb attracts primary stress. Verbs like **akmat** 'fall and die' most likely originated as nuclear serial verbs, but because both verb roots, **ak** 'fall' and **mat** 'die', were monosyllabic, they dropped their individual stress properties and became joined phonologically as a compound verb⁴⁰. The following Lou sentence demonstrates a serial verb construction, **a'pur 'ngan** 'cook eat', in which each verb receives primary stress.

- (173) **ip pē a'pur 'ngan i pweep**
 3p COMP cook bite 3s afternoon
'They all cooked and ate it in the afternoon.'

There are a few instances of compound verbs where the meaning of the compound is not predictable from the individual verbs. Example (174) demonstrates **lang** 'lift.up' occurring by itself. In example (175), it occurs in a nuclear SVC with **aa** 'move'. Example (176) contains the compound verb **alang**⁴¹ 'walk.on.tiptoes', which is compounded from **aa** 'move' and **lang** 'lift.up'.

- (174) **ētē tō lang kētē konum totak**
 1t CONT lift.up 1t:REC garden only
'We three are cleaning our garden.'

⁴⁰ There is a possibility that compound verbs may also be nuclear junctures, but of a different nexus type. However, the different nexus types as applied to Lou, is beyond the scope of this thesis.

⁴¹ Orthographic convention dictates that only a single **a** occurs when **aa** is compounded with another word.

(175) **ētē tö aa lang kētē konum totak**
 1t CONT move lift.up 1t:REC garden only
'We three were moving and cleaning our garden.'

(176) **ētē tö alang**
 1t CONT walk.on.tiptoes
'We three are walking on tiptoes.'

In Lou nuclear layer serialization, SVCs come in two types, which will be discussed next; same-subject and switch-subject.

3.2.2. Same-Subject Nuclear Layer Serialization

Same-subject serial constructions are those in which the actor argument of the first verb is coreferential with the actor argument of the second verb and is not repeated explicitly for the second verb, but is understood. In the following example, both verbs of the series, **tēt** 'chase' and **to** 'put', are transitive and they share the same actor argument, **uru mwi** 'two dogs', and the same undergoer argument, **i** '3s'.

(177) **uru mwi pē tēt to i la ululun ke**
 3d dog COMP chase put 3s go.to crawl.space tree
'The two dogs chased it into the outer roots of a tree.'

In example (178), both verbs, **ik** 'look for' and **pwetek** 'find' of the complex nucleus are transitive; the undergoer argument of the complex nucleus is the complement clause, however, the relationship between the serial verbs is one of cause and result. The first verb, **ik** 'look.for', causes the action of the second verb, **pwetek** 'find'. **ta kae talaru ramat töpö tuënan ta uru nesek** is the complement clause.

(178) ip la ik pwetek [ta kae talaru ramat töpö
3p go.to look.for find SUB idea 3d:RCP person this

tuënan ta uru nesek]
true SUB 3d tell

'They looked and found that the idea of these two men was true that they told.'

In same-subject nuclear SVCs, both verbs may be either transitive or intransitive. Every combination has been attested to: transitive-transitive (178), transitive-intransitive (179), intransitive-transitive (180) and (181), and intransitive-intransitive (182).

(179) Esta töpö i lē pe matsisi⁴² la mata-n Hekai
Esther this 3s SIM do attract go.to eye -3s:POSS Hegai

ë ning-ian
OBL see -NOM

'This Esther just attracted the eyes of Hegai with her looks.'

(180) ip rikwang lēp pokat mwansélén kanën munek
3p jump take gun take.with arrow.bullet too

'They jumped (out of the boats) taking their guns and bullets too.'

(181) Rakole ip pē tolul lēp tin sot talap
Rakole 3p COMP stand take fight go.up 3p:RCP

'Rakole (and his men) took the fight to them.'

⁴² An example of *matsisi* 'covet/attract' functioning as a transitive verb is as follows:

lapana to mata-n lē matsisi pun tē
chief that eye -3s:POSS just covet completely 3s:POSS

Esta
Esther

'The chief's eye just coveted Esther completely.'

(182) **Jona pē sōng tē Lapan a i pē aa luek**
Jonah COMP run.from 3s:RCP lord and 3s COMP move turn

la Tasis
go.to Tarshish

*'Jonah ran from the Lord and went and turned toward
Tarshish.'*

Most of the nuclear layer SVCs in Lou are same-subject constructions, although a few switch-subject constructions have been found.

3.2.3. Switch Subject Nuclear Layer Serialization

Switch-subject serial constructions are those in which the undergoer argument of the preceding verb becomes the actor argument of a following verb. This is exemplified by causative constructions, which according to Foley and Van Valin must be used in a nuclear juncture. Foley and Van Valin (1984:198) give the following French example.

(183) **Je le ferai lire à Jean**
1sg it will.have read by John
'I'll have John read it.'

In this example, the causative auxiliary **ferai** 'will.have' is used by the verb **lire** 'read' to allow a third argument to be introduced. 'I' is the actor argument of **ferai** 'will.have' and John is the actor argument of **lire** 'read'. Foley and Van Valin (1984:198) also state that 'many languages have a very productive use of verb serialization to introduce core arguments' and these

junctures may be either nuclear or core depending on the language.

Although, nuclear layer junctcs must by definition share all core arguments, Early (1993:77) writes that it seems possible to identify different types of nuclear layer serialization in terms of argument structure in Lewo. He gives the example of **visu-kilia** 'see-know' as same-subject and **la-lua** 'take-remove' as switch-subject. Crowley (1987:62) states that Paamese nuclear serial verb constructions can be either same-subject or switch-subject types, although he notes that there is no formal marking of this distinction. In the following Paamese example, Crowley identifies the noun phrase, **puuke ona-ku** 'my books' as the semantic object of 'carry' and the semantic subject of 'stick together'. Formally, it is the undergoer argument of the verb, 'stick together'.

(184) **inau na-lahi** **pilu-ni** **puuke ona-ku**
lsg lsg-real-carry stick together-tr book poss-lsg
'I carried my books in one hand.'

The distribution of switch-subject nuclear layer serial constructions is very limited in Lou. In example (185), the first verb in the series is the cause and the second verb is the result. The semantic subject of the first verb, **ngan** 'bite', is **siöng** 'hunger', and the semantic subject of the second verb, **mat** 'die', is **uru** 'those-two', which is also the undergoer argument of **ngan** 'bite'. However, syntactically, **siöng** 'hunger' is the actor

argument and **uru** 'those-two' is the undergoer argument of the complex nucleus, **ngan mat** 'bite die'.

- (185) **petita siöng i ngan mat uru a uru pä la -k**
because hunger 3s bite die 3d and 3d COMP go.to-GOAL
'Because hunger was killing those two and they went.'

In example (186), the semantic subject of **war** 'call' is **i** 'he' and the semantic subject of **sungek** 'get together' is 'his friends and wife'. Syntactically, **i** '3s' is the actor argument and **ip koat** **tei** '3p friend 3s:RCP' is the undergoer argument of the complex nucleus, **war sungek** 'call get.together'.

- (186) **i la war sungek ip koat tei a**
3s go.to call get.together 3p friend 3s:RCP and
petia-n
wife -3s:POSS
'He called together his friends and his wife.'

Occasionally three or more verbs may occur in a nuclear layer SVC as in example (187). The first two verbs, **to** 'put' and **ik** 'look.for', are in a switch-subject relationship. The actor argument of **to** 'put' is **ip** '3p', the people, and the actor argument of **ik** 'look.for', which is the same as the undergoer argument of **to** 'put', is the 'magic' item used for divination. The last three verbs are in a same-subject relationship. The semantic subject of the last three verbs, **ik** 'look.for', **pwetek** 'find', and **nek** 'put.into' is the 'magic' item already mentioned.

- (187) **ip pä to pä ik pwetek nek Jona**
3p COMP put COMP look.for find put.into Jonah
'They put (it) and (it) looked and pointed to Jonah.'

Although most of the nuclear layer SVCs in Lou have been shown to be same-subject constructions, a few switch-subject constructions have been indicated.

3.3. Core Layer Serialization

In this section, the core layer in Lou is identified, followed by an example of core layer serialization. This introduction is followed by a history of how such constructions have been treated in other languages. It is shown that in Lou, only prepositional verbs may enter into core layer serialization. Then arguments are given to propose the verbal nature of the prepositional verbs. This is followed by a section establishing the mono-clausal status of core layer serialization. Finally, both same-subject and switch-subject core SVCs are presented.

3.3.1. Introduction

In Lou, the core layer consists of the nucleus, which may be either simple or complex, and the core arguments, the actor and undergoer. In this example, the core, **kolponu tö tək um sip**, consists of the simple nucleus, **tək** 'build', which is modified by **tö** 'CONT', the nuclear layer operator of aspect, and the core arguments, **kolponu** 'snake' and **um** 'house'.

- (188) [kolponu ki tö tək um sip]
 snake 3s:IRR CONT build house one
 'The snake will be building a house.'

In core layer serialization, two cores, each with their own nucleus and corresponding arguments, are joined together to form a larger complex core. This complex core shares all peripheral arguments such as time and location, as well as other peripheral operators like tense and mood. In the following example, there are two cores: *i pē to nenewa* and *nenewa la tē Pokaröp Punet*. In the first core, *to* 'put' is the nucleus and *pē* 'COMP', the completive aspect operator, modifies it. In the second core, *la* 'go.to' is the nucleus. An additional constraint on core layer serialization is that the two cores must share a common core argument, either the actor or undergoer. In the example, both cores share the common core argument, *nenewa* 'word', which functions as the undergoer argument of the first core (The word was sent.) and as the actor argument of the second core (The word went to Pokarop).

- (189) { *i pē to [nenewa] la tē Pokaröp Punet* }
 3s COMP put word go.to 3s:RCP Pokarop Punet
 'He sent word to Pokarop at Punet.'

Core layer juncture may be diagrammed as follows:

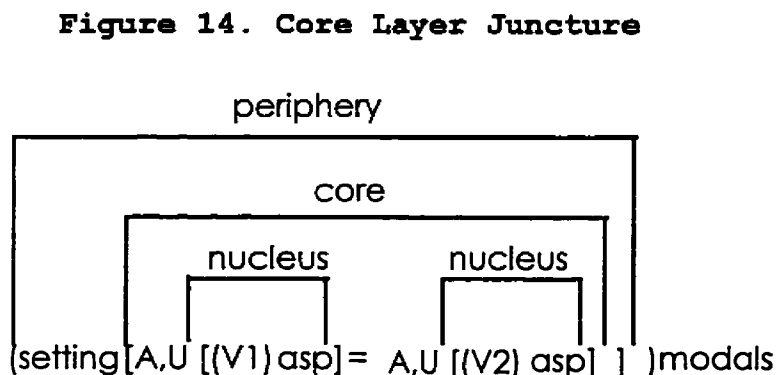



Figure 14 shows a complex core containing two cores. Each core contains a nucleus, an actor, and an undergoer. The periphery contains the complex core, the setting, and modals.

According to the serialization hierarchy presented in Figure 15, basic motion intransitive verbs are the most open to core layer serialization and transitive verbs are the least open to core layer serialization. Intransitive verbs are probably favoured because they don't normally introduce any new core arguments into the core, only non-core arguments. The core arguments are generally supplied by the main verb.⁴³ This seems to be the case for Lou. In fact, only basic motion verbs (verbs that express basic motion when used as main verbs) and two stative verbs are observed to enter into core layer serialization. Since these Lou basic motion verbs function much like traditional prepositions when they are in a core layer SVC, they have been labeled as prepositional verbs in this paper.

⁴³ This topic needs further study.

Figure 15. Core Layer Serialization Hierarchy

CORE	LAYER	VERB TYPE
increasingly open to serialization		1. Basic motion intransitives 2. Posture/active intransitives 3. Stative/process intransitives 4. Other intransitives 5. Transitives

3.3.2. History of Prepositional Verbs

Codrington, as early as 1885, and other early grammarians used the term 'prepositional verb' for certain forms which connected a verb with its grammatical object (Pawley 1973:142). Pawley also states that prepositional verbs are numerous in most of the better-known Oceanic languages, and in some western Austronesian languages, and he believes that they played an important role in POC. The following three examples demonstrate prepositional verbs in Kwara'ae, Mota, and Motu (1973:143).

- (190) nau ku lia 'ala'a 'ua -na
 I I look upwards towards-it
 'I look upwards towards it.' (The prepositional verb here is
 'ua, not ala'a.) (Kwara'ae)
- (191) mule suri -a
 go towards-him
 'go to him' (Mota)
- (192) e hereva heni-dia
 he speak to -them
 'He spoke to them.' (Motu)

Example (193) exemplifies the Lou prepositional verb, **la** 'go.to'. In the three examples above and the following Lou example, the prepositional verb occurs following a verb and preceding a noun phrase. In all four examples, the prepositional verb encodes the meaning of 'direction toward' the following noun phrase.

(193) **ngka pē sōngum la tei**
1s:IRR COMP marry go.to 3s:RCP
'I will marry him.'

Bradshaw (1993:135) asserts that in many serializing languages, non-initial verb roots in SVCs lose some of their verbal characteristics, influencing some linguists to analyze them as 'verbids' (Ansre 1966), 'coverbs' (Li and Thompson 1974), 'verbal prepositions' (Durie 1988), or some other category of deficient verb. In Lou, these prepositional verbs also seem to be a somewhat 'defective' category of verbs as they seldom co-occur with verbal particles. This will be discussed in more detail later in this section.

When serial verb constructions become unstable, a particular class may be reanalyzed into either a verbal affix or into an adposition. The former is designated as a centripetal tendency, the latter as a centrifugal tendency. The centripetal tendency results in one verb clinging more tightly to the other verb, becoming bound to it in the form of an affix, typically encoding

cause, result, manner, instrument, direction, or noun class of the undergoer argument.

The centrifugal tendency results in one verb pulling away from the other verb and attaching itself more closely to a peripheral argument of the clause, becoming an adposition.⁴⁴ The serial verb that contributes the oblique argument is more susceptible to becoming an adposition than the verb which contributes the core arguments. If the oblique role is linked into the main verb's argument structure, the centrifugal drift to adposition is inhibited. If the serial verb is commonly used as a main verb, the centrifugal drift to adposition is also inhibited. Thirdly, if the serial verb bears overt morphological marking, the centrifugal drift to adposition is inhibited. A fourth inhibition toward the centrifugal process occurs if serialization is a very common occurrence in the language.

It will be demonstrated that in Lou core layer serialization, the centrifugal tendency is at work, resulting in the prepositional verb attaching itself more closely to a peripheral argument in the clause. This tendency in Lou is inhibited by the fact that the serial verbs contributing the oblique arguments also occur commonly as main verbs.

⁴⁴ See Durie (1988:3) for a list of references to the literature that discuss these tendencies.

According to Givón, there are two universal sources of case-markers. The first is the "reanalysis of **serial verbs** as case-marking morphemes on objects" (1984:228). This case-marking system is based on the fact that verb-object combinations can be remarkably specific semantically, so that one may read the case-role of a noun off the meaning of its controlling verb (Givón 1984:179). In such a system, excluding the actor argument, each verb in the series serves implicitly as the semantic case-role marker of an adjacent noun. Lord (1973) shows how verbs in series have evolved into either prepositions or conjunctions: locative verbs into locative prepositions, and comitative verbs into either comitative prepositions or subordinating and coordinating conjunctions. It will be shown that in Lou, the core layer serial verbs are evolving into prepositions, but not into conjunctions.

A prepositional verb in Lou thus is a verb which functions as a preposition and which contributes an argument role which has oblique status for the clause. The other verb in the series contributes the core arguments, actor and undergoer, one of which will be shared by the two verbs. This concurs with other Oceanic languages. According to Durie (1988:11),

"All Oceanic languages surveyed have a particularly well-defined, closed class of intransitive, intrinsically oriented verbs, which are used in series with non-oriented verbs, and which can also appear as independent verbs."

In Lou, the prepositional verb is followed by an optional noun phrase which is the undergoer argument of the prepositional

verb. The prepositional verb may also be optionally followed by a 'true' prepositional phrase. The prepositional verb marks an oblique argument of the whole complex, encoding the semantic notions of goal (193), location (203), recipient (225), benefactive (235), indirect object (141), and manner (230). The linear ordering of constituents in a core layer serial verb construction is as follows, where the first optional nuclear layer adverb modifies the main verb and the second optional nuclear adverb modifies the prepositional serialized verb:

MV (ADV)	(NP)	PV (ADV)	(NP)
	(PP)		(PP)

All the pre-verbal particles that were described in Chapter 2 may occur before the main verb, but only status particles have been found to occur before the prepositional verb. However, the vast majority of prepositional verbs occur without any verbal particles. The following example illustrates the prepositional verb **la** 'go.to'. Example (195) below, illustrates the main verb **la** 'go.to'.

(194) **i pē to nenewa la tē Pokaröp Punet**
 3s COMP put word go.to 3s:RCP Pokaröp Punet
 'He sent word to Pokaröp at Punet.'

(195) **ma ip asoa -n ëp la kël...**
 but 3p husband-3s:POSS 1p go.to canoe
 'But our husbands went to the canoe...'

The verbs that may function as prepositional verbs are the same ones that function as directional aspect particles in the simple verb phrase, which were discussed in Section 2.5 plus four others, **la-k** 'go.to-GOAL', **sa-k** 'come.up-GOAL', **tö** 'stay', and **tö-k** 'stay-GOAL'. The inherent meanings of these words are the same as described in that section, however, their function is different. This is a closed class of words. They are listed in the following table.

Table 14. Prepositional Verbs

la	'go to'
la-k	'go to-GOAL'
me	'come to'
sa	'come.up'
sa-k	'come.up-GOAL'
si	'come.down'
sot	'go up'
suot	'go down'
tö	'stay'
tö-k	'stay-GOAL'
wot	'go (short distance)'

3.3.3. Verbal status of Prepositional Verbs

The verbal nature of these prepositional verbs is indicated by a number of different characteristics. This section will describe five conditions that demonstrate that the prepositional verbs are more verbal than prepositional at this point in time. They are their function as independent verbs, co-occurrence with pre-verbal particles, ability to be modified by verbal adverbs, co-occurrence with verbal inflection, and co-occurrence with a

'true' preposition. None of these conditions apply to the 'true' prepositions in Lou.

(1) Function as main verb

First, all of these prepositional verbs may also function as main verbs. Durie (1988:5), in discussing the motivations for verbs to be re-analyzed as prepositions, states, "To the extent that the oblique-coding verb is used independently, this will inhibit semantic bleaching and subsequent reanalysis". This means that if a very common verb is used in serialization to encode an oblique role, the verbal status of the serial usage of the verb will endure longer. It appears that complete semantic bleaching has not yet occurred in the usage of the prepositional verbs in Lou. For instance, in example (195) above, the meaning of the main verb *la* 'go.to' is movement away from the deictic center toward 'the boat'. In the example below, the meaning of the prepositional verb *la* 'go.to' is the same, also movement away from the deictic center, which is the place the men started out from.

(196) *ip ramat töpö ip pē paa la tok potu*
3p person this 3p COMP paddle go.to away far
'These men paddled far away.'

(2) Co-occurs with pre-verbal particles

Secondly, as was noted earlier, a few examples of prepositional verbs co-occurring with pre-verbal particles have

been found. Recall that the pre-verbal particles, listed in Table 6, mark different types of modality and aspect. The only aspectual or modal particle found to co-occur with the prepositional verb is status (the irrealis operators **ka** 'IRR' and **ki** '3s:IRR'). The prepositional verb normally takes its specifications for status, polarity, tense, aspect, and mode from the first verb in the series. For example, in the preceding example, **paa** 'paddle' is marked with the completive aspect, **pä**. The prepositional verb **la** 'go.to' takes its specification for completion from the same form. Both the main verb and the serialized verb are 'completed'.

In the following example, the main verb **löp** 'take' is marked for irrealis with the pre-verbal particle **ki** '3s:IRR' and the prepositional verb **la** 'go.to' takes its specification for irrealis from the main verb. However, in example (198), the prepositional verb **la** 'go.to' and the main verb **löp** 'take' are both marked for irrealis. There is no difference in meaning between the two examples. It appears that usage of the irrealis operator **ki** '3s:IRR' in conjunction with the prepositional verb is optional. However, the possibility of the prepositional verb being marked for irrealis proves the verbal nature of the prepositional verbs, since only verbs may be marked for irrealis.

(197) **i pa ki sa löp sö ip not la**
 3s DES 3s:IRR come.up take some 3p child go.to

ë tartarë Pisik.
 OBL school Pisik

'He wanted to come take some children to go to Pisik school.'

(198) i pa ki sa löp sö ip not ki la
3s DES 3s:IRR come.up take some 3p child 3s:IRR go.to

ë tartarë Pisik.
OBL school Psik

'He wanted to come take some children to go to Psik school.'

In example (199), both the main verb **okto** 'hold' and the prepositional verb **tö** 'stay' are marked for irrealis, however the main verb **okto** 'hold' is marked for non-third person singular actor argument, **ka** 'IRR', and the prepositional verb **tö** 'stay' is marked for third person singular actor argument, **ki** '3s:IRR'. These examples illustrate the verbal nature of the prepositional verbs, in that, they may be marked with a verbal particle.

(199) ip ka okto ki tö talap
3p IRR hold 3s:IRR stay 3p:RCP

'They should hold (it) for them.'

(3) Modified by adverbs

Thirdly, prepositional verbs may be modified by adverbs,⁴⁵ such as **tok** 'away', which in their normal distribution only occur with main verbs. In example (200), the prepositional verb **la** 'go.to' is modified by the adverb **tok** 'away'. This example illustrates the verbal nature of the prepositional verbs, because only verbs can be modified by verbal adverbs.

- (200) **ip ramat töpö ip pë paa la tok potu**
3p person this 3p COMP paddle go.to away far
'These men paddled far away.'

(4) Inflected with detransitivizing suffix

Fourthly, three of the prepositional verbs may be inflected with the detransitivizing suffix **-k** 'GOAL', the only inflectional suffix to occur on Lou verbs. In the following example, the prepositional verb **la** 'go.to' occurs without a following noun phrase. When this happens, **la** 'go.to' is suffixed with **-k** 'GOAL'. The goal marker **-k** may also be suffixed to **sa** 'come.up' when functioning as a prepositional verb. This results in the goal of **sa** 'come.up' being omitted (202).

⁴⁵ More analysis is needed to determine which adverbs may modify the prepositional verbs.

(201) **ëru to rōngot la -k**
2d put 200 go.to-GOAL

'We put 200 in.'

(202) **ma puleng tō lēp i sa -k a...**
but daybreak CONT take 3s come.up-GOAL and

'But when daybreak came up then...'

(5) Co-occurs with 'true' preposition

Finally, a prepositional verb may also be used in conjunction with the 'true' preposition **ë** 'OBL'. In example (203), the prepositional verb **la** 'go.to' is followed by a 'true' prepositional phrase to encode the locative argument, **ë um** 'OBL house'. This usage is very similar to example (204), in which the main verb **la** 'go.to' is followed by the 'true' prepositional phrase, **ë lotu** 'OBL church'.

(203) **i to rēin ke la ë um**
3s put leaf tree go.to OBL house

'He put the leaves on the roof.'

(204) **ma patipēng Sapat sip i la ë lotu**
but morning sabbath one 3s go.to OBL church

'But one Sabbath morning she went to church.'

There are only two 'true' prepositions attested in the data, **ë** 'OBL' (205) and **peti** 'belong.to' (206). The form **ë** 'OBL' is a generic preposition that marks a variety of case relations; locative, goal, and instrument. It occurs as the head of a prepositional phrase. **peti** 'belong.to' is a possessive preposition. It occurs as the head of a prepositional phrase that

expresses possession, which occurs immediately following the possessed noun phrase. Loniu, another language from the Manus network, also has only a limited number of prepositions, three to be exact (Hamel 1993).

(205) Jo səl lilikē-n ə maan tei
 Joe hit shin -3s:POSS OBL axe 3s:RCP
 'Joe hit his shin with his axe.'

(206) i puk katam peti um
 3s open door belong.to house
 'He opened the door to the house.'

Neither of these 'true' prepositions may be marked for status (207) or be modified with an adverb (208) as shown by the following ungrammatical examples. Neither is it possible for a 'true' preposition to occur with another preposition (209).

(207) *Jo səl lilikē-n ki ə maan tei
 Joe hit shin -3s:POSS 3s:IRR OBL axe 3s:RCP

(208) *i puk katam peti tok um
 3s open door belong.to away house

(209) *ma patipēng Sapat sip i la peti ə lotu
 but morning sabbath one 3s go.to belong.to OBL church

The 'true' prepositions may not be inflected with the detransitivizing suffix **-k** 'GOAL', as evidenced by the following two ungrammatical sentences.

(210) *Jo səl lilikē-n ē -k maan tei
Joe hit shin -3s:POSS OBL-GOAL axe 3s:RCP

(211) *i puk katam peti -k um
3s open door belong.to-GOAL house

Since Lou only has two 'true' prepositions, these prepositional verbs have filled a gap in the grammar, functioning to express various case relations. This has been a relatively simple step because of the lack of morphology on the Lou verb.

This section has described five conditions demonstrating that the prepositional verbs are more verbal than prepositional in contemporary Lou. The five conditions discussed were: their function as independent verbs, co-occurrence with pre-verbal particles, ability to be modified by verbal adverbs, co-occurrence with verbal inflection, and co-occurrence with a 'true' preposition. None of these conditions apply to the 'true' prepositions in Lou, thus proving that the prepositional verbs are in a different syntactic category than the prepositions.

3.3.4. Mono-clausal nature of Core Layer SVC

Traditionally, grammarians have accepted the hypothesis that the number of verbs in a sentence correlates with the number of underlying clauses in the sentence. Thus, much of the discussion about serial verbs has included the question as to whether serial verbs should be analyzed syntactically as being derived from complex sentences with comprehensive conjunction-reduction rules. This is the multi-clausal approach. In the mono-clausal approach,

serial verbs are analyzed as being derived from underlying complex verb phrases.

This thesis follows the mono-clausal approach in analysis. It will be shown that the core layer SVC in Lou comprises a single layered clause rather than two or more clauses⁴⁶, thus indicating that 'prepositional' verbs add another core layer to the clause rather than adding another peripheral layer to the sentence. Three tests are proposed to prove that a core layer SVC in Lou is a single peripheral layer junct with an additional core junct rather than two or more peripheral layer juncts. These tests are: peripheral negation, same-subject and object-subject constraints, and underlying meaning differences.

Before describing how peripheral negation can be used to prove that a core layer SVC in Lou is a single clause, it is necessary to outline the various clause types in Lou. In order to do this, a brief review of how RRG discusses clause types is obligatory.

In Section 3.1.4. Juncture and Nexus, three nexus types were discussed: coordination, subordination, and cosubordination. That discussion will not be repeated here. However, it should be noted that these nexus types also apply to how clauses (peripheral

⁴⁶ Whereas core juncts are juxtaposed to each other without any intervening conjunctive particles, peripheral junctures in Lou are marked with either coordinating or subordinating conjunctions.

layer junct⁴⁷) are linked together. Thus RRG posits three nexus relations between clauses in complex sentences: coordination, subordination, and cosubordination.

Two of these basic clause types⁴⁸ occur in Lou, coordinate juncture and subordinate juncture at the peripheral layer. In complex Lou sentences, a coordinate peripheral layer junct contains one verbal construction and is not embedded in another clause; neither is it dependent on another clause in any way. In other words, it can stand alone as an independent clause as is illustrated in example (212).

- (212) **ma ip asoa -n ep la kël...**
 but 3p husband-3s:POSS 1p go.to canoe
 ‘But our husbands went to the canoe...’

A subordinate peripheral layer junct can never stand alone. In complex Lou sentences, it is a peripheral layer junct that is embedded in another clause. It may be an adverbial clause (213) functioning as an oblique argument in the matrix clause or it may be a relative clause (214) modifying one of the arguments of the matrix clause. In Lou, the beginning of the subordinate peripheral layer junct is marked with **ta** ‘SUB’.

⁴⁷ In RRG, a clause is termed a *peripheral layer junct*. However, for the sake of simplicity, this paper will use the term ‘clause’ to refer to the peripheral layer junct.

⁴⁸ The third clause type, cosubordinate juncture at the peripheral layer, in which the cosubordinate junct is dependent on the matrix clause for the expression of one or more operators, such as tense and aspect, has not been detected in Lou.

(213) ta Jon pa tö aa me i lëp kone a nik me
 SUB John DES CONT move come 3s take rice and fish come
 'While John was coming, he brought rice and fish.'

(214) **Ma ip Punet pa ka san kalap puö tong ë**
 but 3p Punet DES IRR cut 3p:REC pig that OBL

pelo a i pë suot tengrit la ë
 obsidian.knife and 3s COMP go.down metal.sound go.to OBL

pelo ta i tö lälön puö topong
 obsidian.knife SUB 3s stay inside pig this

'But the Punet (people) wanted to cut their pig with
 obsidian knife and it went down and sounded like metal on
 the knife that was staying inside the pig (meat).'

In the discussion of juncture and nexus, so far only the linkage of equal units (i.e. nucleus with nucleus, core with core, and periphery with periphery.) has been discussed. RRG also allows for a juncture between periphery and core, specifically in subordinate nexus. RRG has defined a complement clause to be a peripheral layer junct (clause) embedded in a core.⁴⁹ This clause then functions as an argument of the core layer.

In Lou, there are two forms of complement clauses. In example (215), the complement clause functions as an undergoer argument, which is a core argument, in the matrix clause **ngka nesek** '1s:IRR tell', and it is introduced with the subordinate clause marker, **ta** 'SUB'. In example (216), **i ki la Moresbi** is a complement clause. It also functions as a core argument in the matrix clause **wong nga**

⁴⁹ This type of construction, a 'peripheral junct embedded in a core junct' is somewhat problematic for RRG. It is not predicted by the theory, yet it occurs extremely frequently in human language.

pa 'I 1s DES'; however, the subordinate clause marker, **ta** 'SUB' is omitted. This form of complement clause only occurs as a complement of the verb, **pa** 'DES' ('**pa**' complement).

(215) **ngka nesek ta eru päin Papua pe kamwöu**
1s:IRR tell SUB 1d female Papua do dispute
'I will tell that I and a Papuan woman had a dispute.'

(216) **wong nga pa i ki la Moresbi**
I 1s DES 3s 3s:IRR go.to Moresby
'I want him to go to Moresby.'

(1) Peripheral negation

A useful feature for establishing the monoclausal nature of the SVC in Lou is the peripheral layer negator **pwän** 'not'. It always occurs at the end of a clause, with only a limited number of sentential adverbs allowed to follow it, thus bracketing the end of the clause. Example (217) illustrates a negated coordinate clause. Negation is marked with the pre-verbal particle **a** 'NEG', which occurs preceding the verb, and the peripheral layer negator **pwän** 'not', which occurs at the end of the clause.

(217) **kolponu i a tö pe itë la pian pwän**
snake 3s NEG CONT do 3pc go.to good not
'The snake was not doing good to the three of them.'

Example (218) consists of a negated coordinate junct containing two subordinate juncts which are introduced with the subordinate clause marker, **ta** 'SUB'. The first subordinate junct, [**ta nga tö ning mwen Jiu Modokai**], is an adverbial clause and the

second one, [ta i la tö toktoar pun kəkētup tē lapan], is a relative clause. The peripheral layer negator **pwën** 'not' occurs at the end of the sentence, bracketing the end of the negated coordinate junct. Note that only the verb **löp** 'take' is negated. The verbs in the subordinate junct, **ning** 'see' and **toktoar** 'sit', are not negated. This is evidenced by the fact that the pre-verbal negation particle **a** 'NEG' only occurs before **löp** 'take', and not before **ning** 'see' and **toktoar** 'sit'.

(218) ma wong a löp ë sö mes -ian [ta nga tö
 but I NEG take OBL some celebrate-NOM SUB 1s CONT

ning mwen Jiu Modekai [ta i la tö toktoar
 see man Jew Mordecai SUB 3s go.to CONT sit

pun kəkētup tē lapan]] pwën
 entrance gate 3s:RCP chief not

'But I cannot have any celebration while I see the Jew, Mordecai, who is sitting at the entrance of the gate of the king.'

Example (219) consists of a coordinate junct containing a subordinate junct which is introduced with the subordinate clause marker, **ta** 'SUB'. The subordinate junct contains two 'pa' complement clauses conjoined with a conjunction. Each of the 'pa' complement clauses is negated with the negative particle **sa** 'IRR:NEG' and each 'pa' complement clause is closed with the peripheral layer negator, **pwën** 'not'.

(219) **Ma të kamwōu -n [ta i pa [notu ki**
but 3s:RCP dispute-3s:POSS SUB 3s DES child 3s:IRR

sa mimi la um pwën] a [ki sa
IRR:NEG urinate go.to house not and 3s:IRR IRR:NEG

pëek la um pwën]]
excrete go.to house not

'But her dispute was that she wanted children to not urinate in the house and to not excrete in the house.'

Example (220) contains a negated subordinate junct, functioning as a relative clause, also closed with the peripheral layer negator, **pwën** 'not'.

(220) **Ip ramat tapō ē im mwasōn we [ta a pian**
3p person now PERF drink many water SUB NEG good

pwën]
not

'These people have drunk much water that is not good.'

Example (221) contains three coordinate juncts joined with the conjunction **a** 'and'. The first junct is negated and the peripheral layer negator **pwën** 'not' closes this clause. Example (222) contains two coordinate juncts conjoined with the conjunction **petita** 'because'. The first coordinate junct is negated and the peripheral layer negator **pwën** 'not' closes this clause.

(221) **[ma kapa ap ka sa lëp tölë Kuam pwën] a [wong**
but if 2p IRR IRR:NEG take drum Kuam not and 1s

ngka tö -k] a [ip ka sa lëp mat ong]
1s:IRR stay-GOAL and 3p IRR come.up take die 1s:OBJ

'But if you will not take the Kuam drum then I will stay and they will come up and kill me.'

(222) [ma ip a tap pwën] petita [our a kum i teng
 but 3p NEG reach not because wind and wave 3s cry

pun la tē totoan]
 completely go.to 3s:RCP large

'But they did not reach (it), because the wind and waves were very large.'

From these examples, it is clear that all negated peripheral layer junctcs; coordinate and subordinate, including both types of complement clauses, are closed with the peripheral layer negator pwën 'not' at the end of the clause. Thus one can see in example (223), although it contains two verbs, war 'call' and la 'go.to', there is only one clause, because the peripheral layer negator pwën 'not' occurs at the end of the clause. It cannot occur following tii 'anyone', the undergoer argument of the first verb, as evidenced in the ungrammatical example (224). Even though the two verbs are separated with the undergoer argument of the first verb, the peripheral layer negator must occur at the end of the clause, following tei '3s:RCP', the goal of the second verb, thus identifying the example as a single clause.

(223) i -a tö war som tii la um tei pwën
 3s-NEG CONT call one anyone go.to house 3s:RCP not

'She did not call anyone to go to her house.'

(224) *i -a tö war som tii pwën la um tei
 3s-NEG CONT call one anyone not go.to house 3s:RCP

(2) Same-subject and object-subject constraints

Another test that demonstrates that core layer SVCs comprise a single clause rather than more than one underlying clause is

the same-subject and object-subject constraints as presented in Foley and Olson (1985). In the following examples, the first verb is **löp** 'take' and the second verb is **me** 'come'. The subject constraints require that the actor argument of the second verb be either coreferential with the actor argument of the first verb, **Jon** 'John', or coreferential with the undergoer argument of the first verb, **kouka** 'sweet potato'. Thus example (226), with a completely new actor argument, **Solok**, not referred to before, is ungrammatical.

(225) **Jon ka pē löp kouka me kong**
 John IRR COMP take sweet.potato come 1s:RCP
'John will bring me sweet potatoes.'

(226) ***Jon ka pē löp kouka Solok me kong**
 John IRR COMP take sweet.potato Solok come 1s:RCP

(3) Underlying meaning differences

A variation of this test involves the underlying meaning. In example (225), which is a core layer SVC, the meaning is that John will give me sweet potatoes, whereas in example (227), which is a multi-clausal sentence, it is irrelevant whether John gives me the sweet potatoes or not.

(227) **Jon ki pē löp kouka a Jon ki me**
 John 3s:IRR COMP take sweet.potato and John 3s:IRR come
kong
 1s:RCP
'John will take the sweet potatoes and John will come to me.'

Since serial verb constructions always contain two or more verbs, it was necessary to show that the core layer SVC in Lou comprises a single layered clause (one peripheral layer junct) rather than two or more clauses (more than one peripheral layer junct). Three tests were presented to show that a core layer SVC in Lou is a single clause rather than two or more clauses. These tests were peripheral negation, same-subject argument and object-subject constraints, and underlying differences.

In Lou, only the prepositional verbs may enter into core layer serialization. Core layer SVCs are of two types: same-subject and switch-subject argument.

3.3.5. Same-Subject Core Layer Serialization

Most of the core layer SVCs in Lou are switch-subject constructions. However, there are a few same-subject constructions. 'Same-subject' refers to the phenomenon of the actor argument of the main verb being coreferential with the actor argument of the serialized verb.

Example (228) illustrates a same-subject core layer SVC. The actor argument of **söngum** 'marry' is **ngka** '1s:IRR', which is coreferential with the actor argument of **la** 'go.to'. Note that it is possible to insert an adverb between the serial verbs in core layer serialization (229). The adverb **sopwi** 'finish' modifies the first verb of the series. In the following two examples, **la** 'go.to' marks the goal, **tei** '3s:RCP'.

(228) **ngka pē sōngum la tei**
1s:IRR COMP marry go.to 3s:RCP
'I will marry him.'

(229) **nga pē sōngum sopwi la tei**
1s COMP marry finish go.to 3s:RCP
'I already married him.'

While **la** 'go.to' usually marks goal, in example (230) it marks the manner in which an action is performed.

(230) **o nesek la moneek**
2s say go.to slow
'Say it slowly.'

Although most of the core layer SVCs in Lou will be shown to be switch-subject constructions, a few same-subject constructions have been indicated, marking goal and manner.

3.3.6. Switch-Subject Core Layer Serialization

Switch-subject serial constructions in Lou are those in which the undergoer argument of the preceding verb becomes the actor argument of a following verb. Switch-subject core layer serial constructions are very productive in Lou.

If the main verb is transitive, the undergoer argument follows the main verb and becomes the actor argument of the following prepositional verb. In example (231), the undergoer argument of **nesek** 'tell' is **i** '3s', referring to the message. The actor argument of the prepositional verb **la** 'go.to' is **i** '3s', also referring to the message. **i** '3s', the message, is the core argument

that both verbs share. In example (232), **köpköpön päinlapan** ‘queen’s roof (crown)’ is the undergoer argument of **to** ‘put’, but the actor argument of **la** ‘go.to’, i.e. ‘the crown went to her head’. The prepositional verb **la** ‘go.to’ marks the semantic notion of location in example (232).

(231) **ip pë la nesek i la të Haman ë**
 3p COMP go.to tell 3s go.to 3s:RCP Haman OBL

mwamwatou-n tong
 behaviour-3s:POSS that

‘They went and told it to Haman about his behaviour.’

(232) **i ki to köpköpön päin -lapan la para-n**
 3s 3s:IRR put roof female-chief go.to head-3s:POSS

‘She will put the queen’s roof (=crown) on her head.’

If there is no overt undergoer argument of the main verb as in example (233), the prepositional verb may immediately follow the main verb. **nesek** ‘tell’ is the main verb and **wot** ‘go’ is the prepositional verb.

(233) **i pë nesek wot talap ta tö pe mangat**
 3s COMP tell go 3p:RCP SUB CONT do work

‘He had said to them who were doing work...’

The following example proves that the actor argument of the prepositional verb **tö** ‘stay’, even though not explicitly stated, is different from the actor argument of the main verb, **okto** ‘hold’. This is demonstrated in the fact that the third person singular form of the irrealis particle **ki** ‘3s:IRR’ is used to modify the prepositional verb, whereas the non-third person singular irrealis particle **ka** ‘IRR’ is used to modify the main verb. The actor

argument of the main verb **okto** 'hold' is **ip** 'they' and the actor argument of the prepositional verb **tö** 'stay' is implied to be 'it'.

- (234) **ip ka okto ki tö talap**
3p IRR hold 3s:IRR stay 3p:RCP
'They should hold (it) for them.'

Animate goals, such as benefactive and recipient arguments, are marked with the prepositional verbs **la** 'go.to' and **me** 'come'. This suggests that in Lou, benefactive and recipient arguments are not core arguments, but rather peripheral arguments like goal and locative. In example (235), the prepositional verb **la** 'go.to' marks the benefactive argument, **ramat** 'person'. In example (236), the prepositional verb **me** 'come' marks the recipient argument, **kong** 'me'.

- (235) **i to radio sip peti pappap la tö ramat**
3s put radio one belong.to buy go.to 3s:RCP person
'He bought the radio for the man.'

- (236) **aman itë ka pë lëp kouka me kong**
maybe 3pc IRR COMP take sweet.potato come 1s:RCP
'They might bring me sweet potatoes.'

In the preceding example, the undergoer argument of the main verb, **lëp** 'take', which is **kouka** 'sweet potatoes', occurs between the verbs **lëp** 'take' and **me** 'come'. In example (237), the undergoer argument of **lëp** 'take' is omitted and no replacement pronoun is substituted because it is possible to retrieve the undergoer argument from context.

- (237) **i apur palsi puö a i pë lëp me tang**
 3s cook before pig and 3s COMP take come 1s:RCP
'When he had cooked the pig, he brought it to me.'

Example (238) demonstrates that it is possible for the undergoer argument of **me** 'come' to be omitted as well, as long as it can be understood from context.

- (238) **ngë pat kouka ta pëin sala i lëp me**
 1s plant sweet.potato SUB female old 3s take come
'I planted the kaukau that the old woman brought.'

Although **la** 'go.to' is by far the most productive of the prepositional verbs, all the other forms in this word class are observed to function as prepositional verbs. Given below are examples of clauses using the various prepositional verbs.

- (239) **o la lëp o la ut nek sö**
 2s:IRR go.to take 2s:IRR go.to dip put.into some
we sa tatatë
 water come.up lpc.in:RCP
'You go dip some water and bring it up to us.'

- (240) **uru pa "o to lëklëk si paë"**
 3d DES 2s:IRR put basket come.down low
'They two said, "You send the basket down (to us)."

- (241) **ëru ka to sö owi sot kom**
 1d IRR put some small.fish go.up 2s:RCP
'We two will send some small fish up to you.'

- (242) **ëru ka to sö owi suot kom**
 1d IRR put some small.fish go.down 2s:RCP
'We two will send some small fish down to you.'

(243) **ëru ka to sö owi tö kom**
1d IRR put some small.fish stay 2s:RCP
'We two will mark some small fish for you.'

(244) **ëru ka to sö owi tök kom**
1d IRR put some small.fish stay 2s:RCP
'We two will put aside some small fish for you.'

Switch-subject core layer serial constructions were shown to be very productive in Lou. They mark goal, location, benefactive and recipient arguments.

3.4. Chapter Summary

In this chapter, Lou serial verb constructions were discussed. Many examples of SVCs illustrated their characteristics, functions, and types. The layered structure of the clause was introduced, along with juncture and nexus, to determine if clause layers could be used to distinguish types of SVCs. SVCs in Lou were found to be of two forms; nuclear layer and core layer.

Four tests were proposed to distinguish between nuclear layer SVCs and core layer SVCs. The nuclear SVC can be nominalized as a unit, but the core SVC can not. Nuclear SVCs can only be modified by an adverbial as a unit, whereas the verbs in core layer SVCs may be modified independently by adverbials. The nuclear SVC can have no element intervene between the verbs, whereas the core SVC can have adverbs, prepositional phrases and noun phrases intervene between the verbs. No pause can normally intervene between the

verbs in a nuclear SVC, but a pause can intervene between the verbs in a core SVC.

Only transitive verbs and some non-motion intransitive verbs were found to enter into nuclear layer SVCs, while only motion and stative verbs are allowed to enter into core layer SVCs. This is in line with the prediction proposed by Crowley (1987:69). The phonological test of word stress was used to distinguish between compound verbs and nuclear layer serial verbs. Examples of both same-subject and switch-subject nuclear layer SVCs were presented.

A history of how prepositional verbs have been treated in other Oceanic languages was presented. Most Oceanic languages have been found to have a small closed class of deficient verbs that function to introduce oblique arguments. The status of this class differs from language to language, but most often it is more verbal than non-verbal.

Five characteristics of the prepositional verbs that occur in core layer SVCs were listed to indicate their verbal nature, although their function is primarily prepositional. All the prepositional verbs continue to function as main verbs. Sometimes the irrealis particles may co-occur with the prepositional verbs. However, irrealis particles never occur with 'true' prepositions. Prepositional verbs may be modified by adverbs, whereas 'true' prepositions cannot be. Three of the prepositional verbs may be inflected with the verbal detransitivizing suffix. Prepositional

verbs may occur in conjunction with 'true' prepositions in the same way that main verbs may occur with 'true' prepositions.

Three tests were proposed to show that core layer serialized verb constructions are mono-clausal, consisting of only one peripheral layer junct, rather than consisting of more than one peripheral layer junct. In order to discuss the peripheral layer negator, an overview of Lou clause types was presented. Since Lou is marked with discontinuous negation morphemes, the peripheral layer negator **pwën** 'not' was used to show that core layer serial verb constructions are not composed of two or more clauses, but rather are mono-clausal. Same-subject and object-subject constraints and underlying meaning differences also provided proof.

Examples of both same-subject and switch-subject core layer SVCs were presented. The prepositional verbs in the core layer SVCs mark various oblique arguments: goal, location, manner, benefactive, and recipient arguments.

Chapter 4. Summary

This thesis has examined the Lou verb phrase from two points of view, structure and function. A narrow definition of *verb phrase* was utilized in defining the parameters of the topic. Consequently, only verbs and verbal particles were discussed, excluding objects, either direct, indirect, or oblique. The simple verb phrase in Lou consists of optional pre-verbal particles and a main verb. The serial verb construction consists of a simple verb phrase followed by a serialized verb. In Lou, the SVC takes two forms, nuclear layer serialization and core layer serialization, following the theory of the layered structure of the clause as presented by RRG.

Chapter 1 presented a brief overview of the Lou language, where it is spoken, its linguistic affiliation, related literature, its phonology, word order and other grammatical characteristics. Lou was shown to be an Oceanic language of the South-East Admiralty cluster. It has thirteen consonants and seven vowels. It is a rigidly SVO language, having a comprehensive pronominal system, an extensive possessive system, and ten noun classes. Verb serialization is a feature of the Lou language.

In Chapter 2, all the pre-verbal particles were analyzed, described, and illustrated. It was shown that there are five orders of pre-verbal particles; status modality, polarity, perfect

aspect, directional aspect, and imperfective aspect. Although there are no explicit tense morphemes in Lou, tense is expressed with the different aspectual morphemes. The different combinations of particles were examined as well. Considering the fact that it is difficult and often impossible for an outsider to 'get inside the native speaker's head', a definition was proposed for each particle and each combination of particles. A discussion of Lou adverbs was included in this chapter, not because they are considered to be part of the verb phrase, but because adverbs are used in some of the tests presented in Chapter 3.

Serial verb constructions were discussed in Chapter 3. The different functions and types of SVCs were outlined. Foley and Van Valin's theory of the layered structure of the clause was introduced detailing three layers in the clause: nucleus, core, and periphery. The different layers of the clause provided an analytical model for distinguishing SVCs based on syntactic differences.

Nuclear layer serial verb constructions were described and illustrated. They were shown to be distinct from compound verbs. Several tests were presented to distinguish nuclear layer serial verb constructions from core layer verb constructions. It was shown that in Lou, a nuclear layer serial verb construction consists of a simple verb phrase tightly followed by a serialized verb. In fact, no other word may intervene between the verbs in series. In Lou, only transitive and some intransitive verbs can

enter into nuclear layer serialization. In comparison to core layer serialization, nuclear layer serialization is relatively unproductive in Lou.

Finally core layer serialization was discussed. It was shown that Lou core layer serial verb constructions are indeed more verbal than prepositional. Several tests were included to show that core layer serial verb constructions in Lou constitute a single clause. In Lou, a core layer serial verb construction consists of a simple verb phrase followed by an optional adverb and optional undergoer argument, followed by a 'prepositional verb', also followed by an optional adverb and optional oblique argument. Only motion and some posture stative verbs can enter into core layer serialization. There appears to be no overlap in Lou; different verbs are serialized in nuclear SVCs than in core SVCs.

With the framework established in this thesis, a logical next step would be to examine in depth the juncture-nexus types in Lou; cosubordination, coordination and subordination at all three layers of the clause; and the nucleus, core and peripheral layers, including the restrictions there might be on the different juncture-nexus types. One of the questions to consider would be whether compound verbs actually are SVCs, only of a different nexus type. It would also be worth considering whether reduplicated verbs are a form of serial verbs. Another question to consider is whether the 'pa' complement clause is possibly of a

different nexus type than the standard complement clause. It would also be worthwhile to consider whether any of the preverbal particles actually form nuclear cosubordinate or subordinate juncture with the main verb.

Perhaps with more data, different tests to distinguish nuclear layer versus core layer SVCs would become evident. Also more data might give rise to greater insight as to why basic motion intransitives are most likely to enter into core layer serialization and transitive verbs are most likely to enter into nuclear layer serialization. An additional question for discussion would be why the centrifugal tendency rather than the centripetal tendency is at work in Lou core layer serialization.

More analysis is also needed to clean up some housekeeping items. For example, it would be useful to know which verbs are allowed to function as the serialized verb in a nuclear layer SVC. Another question for further analysis is which adverbs may modify prepositional verbs in core layer SVCs. More analysis might lead to the discovery of multiple object serialization, ambient serialization, or adverbial serialization.

Since a narrow definition of *verb phrase* was utilized in defining the parameters of the topic, only verbs and verbal particles were discussed, excluding objects, either direct, indirect, or oblique. A further study might use a broader definition of the verb phrase and thus include objects as well, direct, indirect, and oblique.

Appendix A: Sample Text

The Story of Napetie⁵⁰

- (1) **Tapö wong nga pa ngka nesek nenewaë-n Napetie**
now I 1s DES 1s:IRR tell word -3s:POSS Napetie
Now I will tell the story of Napetie.
- (2) **Napetie to i ngara-n monua som**
Napetie that 3s name -3s:POSS eagle one
That Napetie is the name of an eagle.
- (3) **Pëin sala som to i peti Rambujo**
female old one that 3s belong.to Rambucho
That old woman was from Rambucho.
- (4) **Ip pe kamwöu a ip pë öppuë para-n**
3p do dispute and 3p COMP chop head-3s:POSS
They got angry and they hit her head.
- (5) **Pëin sala töpö i pë lëp pwentele sut a i pë**
female old this 3s COMP take clam.shell one and 3s COMP
[sömuek nek]_{N⁵¹ töre -n para-n}
collect.water put.into blood-3s:POSS head-3s:POSS
This old woman took a clam shell and she collected her blood from her head.

⁵⁰ This legend was produced by Solok Pwaka of Solang Village.

⁵¹ Serial verb constructions are bracketed; nuclear layer SVCs are marked with N subscript and core layer SVCs are marked with a C subscript.

- (6) **Törē -n para-n ta i tö pwentele töpö i**
 blood-3s:POSS head-3s:POSS SUB 3s stay clam.shell this 3s
pē tö teptingan seniek
 COMP CONT check continuous
The blood from her head that was in the clam shell she checked continuously.
- (7) **I pa ki ning-ning a tör töpö i än posa**
 3s DES 3s:IRR see -see and blood this 3s PROG dry
She wanted to see and the blood was slowly drying.
- (8) **I lē tö -k a i pa ki ning ili a**
 3s SIM stay-GOAL and 3s DES 3s:IRR see again and
törē -n para-n töpö i [mwang la]_c monmon
 blood-3s:POSS head-3s:POSS this 3s appear go.to bird
rumo
 two
She just stayed and she was watching again and the blood from her head appeared as two birds.
- (9) **Som i kolponua a som i monua**
 one 3s snake and one 3s eagle
One was a snake and one was an eagle.
- (10) **kolponua to apasek ngara-n pwën ma som ta**
 snake that nothing.left name -3s:POSS not but one SUB
i [mwang la]_c monua to pëin sala to i pë
 3s appear go.to eagle that female old that 3s COMP
[atë ngara-n la]_c Napetie
 speak.name name -3s:POSS go.to Napetie
That snake did not have a name, but the one that appeared as an eagle, that old woman called it's name Napetie.
- (11) **kolponua i a tö [pe itë la]_c pian pwën**
 snake 3s NEG CONT do 3pc go.to good not
The snake was not doing good for the three of them.

- (12) **Pëin sala to i a tö ta uro pwën**
 female old that 3s NEG CONT SUB happy not
The old woman was not happy.
- (13) **Salëta tatë ka lë [tö -k sungek]_N kolponu**
 if 1pc:RCP IRR SIM stay-GOAL get.together snake
ki pe keleek toru tem
 3s:IRR do spoil 1d.in now
If we three just stay together, the snake will spoil us two now.
- (14) **Napetie i la röng nenewa të tina -n a**
 Napetie 3s go.to listen word 3s:RCP mother-3s:POSS and
i pa pian a i pë öp
 3s DES good and 3s COMP fly
Napetie listened to the words of his mother and he said 'good' and he flew away.
- (15) **Napetie pë la ë supwak se ta i patan pwakpwak**
 Napetie COMP go.to OBL tree one SUB 3s trunk large
ri
 INTS
Napetie went to a tree that had a very large trunk.
- (16) **Napetie pë la [pe patpat sip la]_C ran supwak**
 Napetie COMP go.to do table one go.to branch tree
topong
 this
Napetie made a platform in the branch of the tree.
- (17) **I pë [täk um sip la]_C eri**
 3s COMP build house one go.to it
He built a house on it.

- (18) **Um a patpat la pepwën a i pë si**
 house and table go.to complete and 3s COMP come.down
[lëp tina -n la]c eri
 take mother-3s:POSS go.to it
The house and platform were finished and he came down and took his mother to it.
- (19) **kolponua töpö i pë [ik uru la]c pwën a i pë**
 snake this 3s COMP look.for 3d go.to not and 3s COMP
ën [pungto rein uru la]c sal
 PROG sniff smell 3d go.to road
The snake looked for them (and did not find them) and he followed their smell along the road.
- (20) **I la [pung la -k]c a i pë la [tep la]c**
 3s go.to sniff go.to-GOAL and 3s COMP go.to reach go.to
ë supwak ta uru tö eri topong
 OBL tree SUB 3d stay it this
He went sniffing and he went until he reached the tree that they were staying in.
- (21) **kolponua töpö i pë [tetak la]c ë supwak a i pa**
 snake this 3s COMP go.up go.to OBL tree and 3s DES
ki la ë um a patpat ta pëin sala tö
 3s:IRR go.to OBL house and table SUB female old stay
eri topong
 it this
The snake went up the tree and he tried to go into the house and platform that the old woman was staying in.
- (22) **Napetie pë [pe tin la]c tei**
 Napetie COMP do fight go.to 3s:RCP
Napetie fought him.
- (23) **kolponua i -a pwir pwën**
 snake 3s-NEG weak not
The snake was not weak.

- (24) I lē tu [[tetak kekese]N la]c wat
 3s SIM DEF.CONT go.up disobey.wise.counsel go.to high
 ē patpat a um
 OBL table and house
*He would just keep going up there on the platform and house
 against their wishes.*
- (25) Napetie la ning ta kolponu i a tu [pwir ē
 Napetie go.to see SUB snake 3s NEG DEF.CONT weak OBL
 tetak la]c wat pwën a i pa “Toru ka [söng la]c
 go.up go.to high not and 3s DES ld.in IRR run go.to
 sut ta tii”
 one SUB put.separate
*Napetie went and saw that the snake would not be weak from
 climbing up there and he said, “We two must run away to a
 different place”.*
- (26) Tina -n pa pian a toru ka [söng la]c sara
 mother-3s:POSS DES good and ld.in IRR run go.to one
 ponu tok
 village away
*His mother said, “good and we will run to a village (far)
 away”.*
- (27) Napetie monua töpö i pē [öp lēp]N tina -n a
 Napetie eagle this 3s COMP fly take mother-3s:POSS and
 uru pē la Romput
 3d COMP go.to Romput
*This Napetie flew taking his mother and they two went to
 Romput.*
- (28) Uru tö eri a Napetie pē la tö [ik puangke
 3d stay it and Napetie COMP go.to CONT look.for food
 me]c kalaru
 come 3d:RCP
*They two stayed there and Napetie went looking for food for
 them.*

- (29) I pē la tō [[tik lēp]_N epi lalōn suar
 3s COMP go.to CONT grab take sago inside sago.land
 talap Romput me]_c um talaru a uru pē tō ngan
 3p:RCP Romput come house 3d:RCP and 3d COMP CONT bite
*He went and was taking sago from inside the sago grove of
 Romput and bringing it to their house and they were eating.*
- (30) I la tō lēp epi pengin pengin lalōn
 3s go.to CONT take sago continually continually inside
 suar talap ramat
 sago.land 3p:RCP person
*He was taking sago all the time from sago groves belonging
 to (other) people.*
- (31) Ip ramat tōpō ip pa “Siē la tō [lēp panak]_N
 3p person this 3p DES who go.to CONT take steal
 katap epi”
 1p.in:RCP sago
These people said, “Who is stealing our sago?”
- (32) Ip pē ning ta monua la tō [tik lēp]_N kalap epi
 3p COMP see SUB eagle go.to CONT grab take 3p:RCP sago
 lalōn suar
 inside sago.land
*They saw that the eagle was taking their sago from inside
 the sago grove.*
- (33) Epi ta sunsun a ta i tō kōti monua lē
 sago SUB wrap.with.leaf and SUB 3s CONT net.bag eagle SIM
 tu [tik lēp]_N sopwi
 DEF.CONT grab take finish
*Sago that was wrapped in leaves and that was in a net bag,
 the eagle would just grab and take it all.*

- (34) **Pëng sip a ip ramat peti Romput pë [nënë**
time one and 3p person belong.to Romput COMP talk
sungek]N a ip pa ka sokmat i
get.together and 3p DES IRR shoot 3s
One day the people of Romput talked together and they wanted to shoot it.
- (35) **Ip tamuna pë öm lilip a ip pë [aa la]c sal**
3p every COMP cut club and 3p COMP move go.to road
Every one of them cut a club and they went (to the sago grove).
- (36) **Tatap ka sokmat i**
1p.in:RCP IRR shoot 3s
We will shoot it.
- (37) **I tö lëp sopwi katap epi ma sa**
3s CONT take finish 1p.in:RCP sago but what
He was finished taking our sago, but what!
- (38) **Napetie to i pwakpwak monua som**
Napetie that 3s large eagle one
That Napetie was a large eagle.
- (39) **I ki pë [tik lëp]N epi mwantön nik menengan a**
3s 3s:IRR COMP grab take sago plenty fish big and
tölë
drum
He would have taken more sago, big fish and drums.
- (40) **Ip ramat pa ka ning-ning a i me öp**
3p person DES IRR see -see and 3s come fly
The people wanted to see and he came flying.
- (41) **I la [öp la]c suar a i la lëp epi a**
3s go.to fly go.to sago.land and 3s go.to take sago and
i me aa
3s come move
He came flying to the sago grove and he took the sago and he left.

- (42) **Epi topol kë -n sakal kalmotu a topol kë**
 sago 50 foot-3s:POSS one right and 50 foot
 -n sakal kosur a i pë me öp
 -3s:POSS one left and 3s COMP come fly
Fifty on his right leg and fifty on his left leg and he came flying.
- (43) **Epi ta songot minökön**
 sago SUB 100 whole
Sago that was a whole hundred.
- (44) **Ip ramat pë ën [aek lilip la]c të Napetie**
 3p person COMP PROG throw.hit club go.to 3s:RCP Napetie
 topong
 this
The people threw the clubs at this Napetie.
- (45) **Som i aek a i lë tël som i**
 one 3s throw.hit and 3s SIM throw.spear.and.miss one 3s
 aek a i lë tël
 throw.hit and 3s SIM throw.spear.and.miss
One threw and it just missed; one threw and it just missed.
- (46) **Ip tamuna aek a i lë tël sopwi**
 3p every throw.hit and 3s SIM throw.spear.and.miss finish
Every one threw and it just missed.
- (47) **ën ramat som a kë -n palawëk a mwat ngan**
 DIM person one and foot-3s:POSS bad and sore bite
 sumsumrek pusu-n la palawëk ip suput anek i a
 scar.scab nose-3s:POSS go.to bad 3p push away 3s and
 ip pa i ki tö mana a i pweriöun palawëki
 3p DES 3s 3s:IRR CONT exclude and 3s artheritis bad
 -n
 -3s:POSS
There was a person with bad legs and sores eating his nose very badly; they stopped him from coming and were wanting to exclude him and he was very badly disabled.

- (48) I pē [aek lilip tei la]_c tē monua a i
 3s COMP throw.hit club 3s:RCP go.to 3s:RCP eagle and 3s
 pē sökriöt kalō-n sakal a monua i pē
 COMP throw.break arm -3s:POSS one and eagle 3s COMP
 ən öp tataöp
 PROG fly out.of.control
*He threw his club at the eagle and it hit one of his wings
 and the eagle was flying out of control.*
- (49) Ramat suē töpö i pa "Lili lili lili"
 person little this 3s DES lili lili lili
This little person said, "lili lili lili".
- (50) Ip ramat pa "Siē topur i"
 3p person DES who kill.with.speargun 3s
All the people said, "Who killed it?"
- (51) Ip sapa pa a ramat suē pweriöun töpöa
 3p some DES and person little dissabled this
Some of them say that little disabled man.
- (52) Monua töpö i lä ən öp tataöp a i pē
 eagle this 3s SIM PROG fly out.of.control and 3s COMP
 la [löt la]_c tet
 go.to fall.down go.to ocean
*The eagle just slowly flew out of control and it fell down
 into the ocean.*
- (53) I [löt la]_c tet kasön Pitilu
 3s fall.down go.to ocean near Pitilu
It fell into the ocean near Pitilu.
- (54) Ip ramat peti Pitilu ning ta monua [löt la]_c
 3p person belong.to Pitilu see SUB eagle fall.down go.to
 tet
 ocean
The people of Pitilu saw that the eagle fell into the ocean.

- (55) **Ip ramat pē [aa ē kēl la -k]c a la ning i**
 3p person COMP move OBL canoe go.to-GOAL and go.to see 3s
The people went by canoe and saw it.
- (56) **Monua pa “ap ka la lēp sip putuke a ka [to**
 eagle DES 2p IRR go.to take one wooden.dish and IRR put
ong la]c eri”
 1s:OBJ go.to it
The eagle said, “You take a wooden dish and put me into it.”
- (57) **Ip pē la lēp putuke sip a pē [to i la]c**
 3p COMP go.to take wooden.dish one and COMP put 3s go.to
eri
 it
They took a wooden dish and put him into it.
- (58) **Ip pē [lēp monua la]c ponu**
 3p COMP take eagle go.to village
They took the eagle to the village.
- (59) **Monua pa “wong ngka mat, ap ka [lēp lumu-n**
 eagle DES I 1s:IRR die 2p IRR take hair-3s:POSS
kalō-ng la]c ē kein tin tap
 arm -1s:POSS go.to OBL feather.necklace fight 2p:RCP
*The eagle said, “I will die, you all take my wing feathers
 into a feather necklace for your fights.*
- (60) **Ap ka pē tō amwal tin”**
 2p IRR COMP CONT win fight
You will be winning the fights.”
- (61) **Ip ramat pē tō [lēp lumu-n Napetie la]c ē**
 3p person COMP CONT take hair-3s:POSS Napetie go.to OBL
tin a ip pē tō amwal seniek ip tin
 fight and 3p COMP CONT win continuous 3p fight
*The people were taking Napetie’s feathers into the fights
 and they were winning their fights continuously.*

- (62) Ip Pitilu la pwaën ë lumu-n Napetie
3p Pitilu go.to strong.one OBL hair-3s:POSS Napetie
The people of Pitilu become strong with Napetie's feathers.

Bibliography

- Bickerton, Derek. 1974. Creolization, linguistic universals, natural semantax, and the brain. University of Hawaii Working Papers in Linguistics 6(3).
- Boutin, Michael E. 1991. Aspect and temporal reference in Banggi. Pacific Linguistic. Series C.118.
- Bradshaw, Joel. 1993. Actor argument relationships within serial verb constructions in Numbami and Jabêm. Oceanic Linguistics. v.32.1:133-161.
- Bradshaw, Joel. 1982. Word order change in Papua New Guinea Austronesian languages. Ph.D. dissertation, University of Hawaii.
- Bruce, Les. 1986. Serialization: The interface of syntax and lexicon. Pacific Linguistics A-70:21-37.
- Bugenhagen, Robert D. 1989. Modality in Mangap-Mbula: An exploration of its syntax and semantics. Language and Linguistics in Melanesia. v.20.1-2:9-39.
- Bugenhagen, Robert D. 1991. A grammar of Mangap-Mbula: An Austronesian language of Papua New Guinea. Ph.D. dissertation, Australian National University.
- Capell, Arthur. 1971. The Austronesian languages of Australian New Guinea. In Thomas A. Sebeok ed. Current Trends in Linguistics. Oceania. v.8:240-340. The Hague: Mouton.
- Comrie, Bernard. 1976. Aspect. Cambridge Textbooks in Linguistics. London: Cambridge University Press.
- Comrie, Bernard. 1985. Tense. Cambridge Textbooks in Linguistics. London: Cambridge University Press.
- Chung, Sandra, and Alan Timberlake. 1985. Tense, aspect, and mood. In Timothy Shopen ed. Language typology and syntactic description, 202-258. Cambridge: Cambridge University Press.

- Crowley, Terry. 1987. Serial Verbs in Paamese. Studies in Language 11-1. John Benjamins. Amsterdam.
- Crystal, David. 1991. A Dictionary of Linguistics and Phonetics. 3rd ed. Oxford: Blackwell Publishers.
- Durie, Mark. 1988. Verbal serialization and verbal-prepositions. Oceanic Linguistics. v.27.1-2:1-23.
- Early, Robert. 1993. Nuclear Layer serialization in Lewo. Oceanic Linguistics. v.32.1:65-93.
- Foley, William A., 1986. The Papuan languages of New Guinea. Cambridge: Cambridge University Press.
- Foley, William A., and Mike Olsen. 1985. Clausehood and verb serialization. In Grammar inside and outside the clause. ed. by Johanna Nichols and Anthony Woodbury. Cambridge University Press. 17-60.
- Foley, William A. and Robert D. Van Valin. 1984. Functional Syntax and Universal Grammar. Cambridge: Cambridge University Press.
- Forman, Michael L. 1993. Verb serialization, word order typology, and Zamboangueno: A comparative approach. Oceanic Linguistics. v.32.1:163-182.
- Givón, Talmy. 1984. Syntax: A Functional-Typological Introduction. v.1. Amsterdam/Philadelphia: John Benjamins.
- Givón, Talmy. 1991. Serial Verbs and the Mental Reality of 'Event': Grammatical vs. Cognitive Packaging. In Approaches to Grammaticalization ed. by Elizabeth Closs Traugott and Bernd Heine. Typological Studies in Language 19. Amsterdam/Philadelphia: John Benjamins.
- Hamel, Patricia J. 1993. Serial verbs in Loniu and an evolving preposition. Oceanic Linguistics: v.32.1:111-132.
- Hamel, Patricia J. 1994. A grammar and lexicon of Loniu, Papua New Guinea. Pacific Linguistics. Series C.103.

- Harrison, S.P. 1982. Proto-Oceanic *aki(ni) and the Proto-Oceanic periphrastic causatives. In Halim, Carrington and Wurm, eds. Pacific Linguistics Series C.74:179-230.
- Healey, Alan. 1976. Austronesian languages: Admiralty Islands area and history of research in Austronesian languages: Admiralty Islands area. In New Guinea area languages and language study. v.2. ed by S.A. Wurm. Pacific Linguistics. Series C.39:349-364.
- Johnston, Raymond L. 1980. Nakanai of New Britain. Pacific Linguistic. Series B.70.
- Lee, Kee-dong. 1974. Verbal aspect in Kusaiean and Ponapean. Working Papers in Linguistics. v.5.9:23-66. University of Hawaii.
- Lord, Carol. 1973. Serial verbs in transition. Studies in African Linguistics. v. 4:269-296.
- Lord, Carol. 1977. How Igbo got from SOV serializing to SVO compounding. Studies in African Linguistics, Supplement 7:145-156.
- Marck, Jeff. 1991. Sixteen Nuclear Micronesian verbs. Currents in Pacific Linguistics. ed. by Robert Blust. Pacific Linguistics. Series C.117.
- Milner, George B. 1980. On the centrality of Austronesian syntax. In Papers from the Second Eastern Conference on Austronesian Languages. ed. by Paz B. Naylor. University of Michigan: Michigan Papers on South and Southeast Asia. v.15:1-17.
- Pawley, Andrew. 1973. Some problems in Proto-Oceanic grammar. Oceanic Linguistics. v.12.1,2:103-188.
- Ross, Malcolm. 1988. Proto Oceanic and the Austronesian Languages of Western Melanesia. Pacific Linguistic. Series C.98.
- Sperlich, Wolfgang B. 1993. Serial verb constructions in Namakir of Central Vanuatu. Oceanic Linguistics. V.32.1:95-110.
- Stutzman, Verna. 1994. Lou Grammar Essentials. unpublished ms.

- Van Valin, Robert D. 1993. A Synopsis of Role and Reference Grammar. *Advances in Role and Reference Grammar*. Amsterdam: John Benjamins.
- Wallace, Stephen. 1982. Figure and Ground. In *Tense-Aspect: Between semantics and pragmatics*. ed. by Paul J. Hopper. Amsterdam/Philadelphia: John Benjamins. V.1:201-223.
- Wolff, John U. 1980. Verbal morphology and verbal sentences in Proto-Austronesian. In *Papers from the Second Eastern Conference on Austronesian Languages*. ed. by Paz B. Naylor. University of Michigan: Michigan Papers on South and Southeast Asia. v.15:153-167.

TEST TARGET (QA-3)

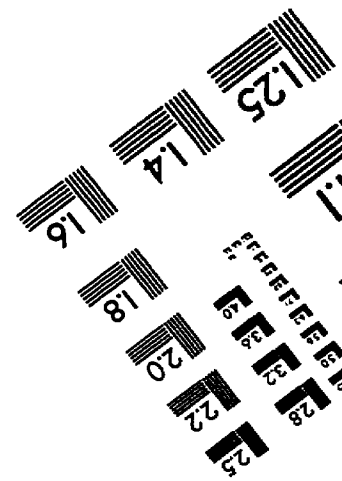
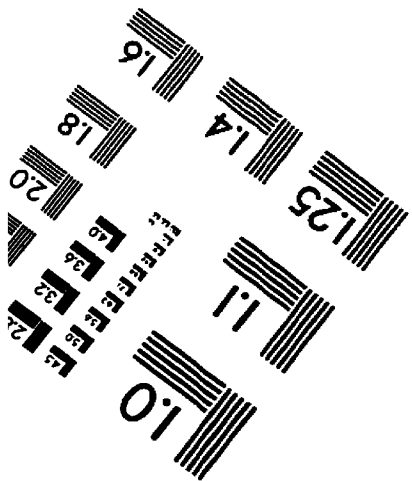
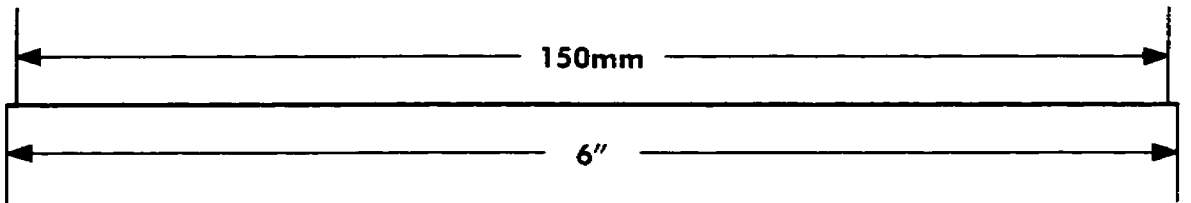
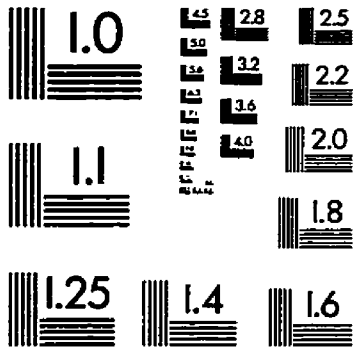
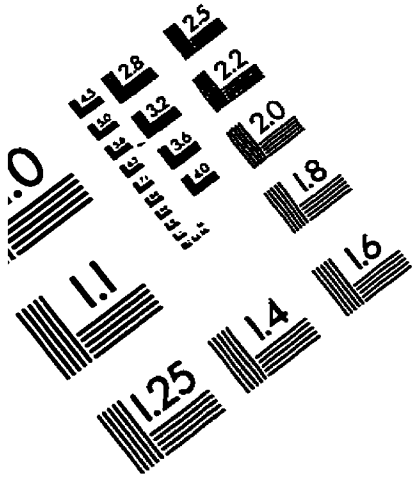

APPLIED IMAGE, Inc
1653 East Main Street
Rochester, NY 14609 USA
Phone: 716/482-0300
Fax: 716/288-5989

© 1993, Applied Image, Inc., All Rights Reserved