

BELUGA WHALE (*Delphinapterus leucas*) USE OF THE NELSON
RIVER ESTUARY, HUDSON BAY

By

Alexander J. Smith

A Thesis

Submitted to the Faculty of Graduate Studies of the University of Manitoba

In partial fulfilment of the requirements of the degree of

MASTER OF SCIENCE

Department of Environment and Geography
Clayton H. Riddell
Faculty of Environment, Earth, and Resources
University of Manitoba
Winnipeg, Manitoba

Alexander J. Smith © April, 2007

**THE UNIVERSITY OF MANITOBA
FACULTY OF GRADUATE STUDIES

COPYRIGHT PERMISSION**

BELUGA WHALE (*Delphinapterus leucas*) USE OF THE NELSON

RIVER ESTUARY, HUDSON BAY

BY

Alexander J. Smith

**A Thesis/Practicum submitted to the Faculty of Graduate Studies of The University of
Manitoba in partial fulfillment of the requirement of the degree**

MASTER OF SCIENCE

Alexander J. Smith © 2007

Permission has been granted to the Library of the University of Manitoba to lend or sell copies of this thesis/practicum, to the National Library of Canada to microfilm this thesis and to lend or sell copies of the film, and to University Microfilms Inc. to publish an abstract of this thesis/practicum.

This reproduction or copy of this thesis has been made available by authority of the copyright owner solely for the purpose of private study and research, and may only be reproduced and copied as permitted by copyright laws or with express written authorization from the copyright owner.

ABSTRACT

Most beluga whales (*Delphinapterus leucas*) (Pallas 1776) living in areas of seasonal sea ice use estuaries periodically during summer. Beluga estuary-use hypotheses include feeding, calving, moulting, killer whale (*Orcinus orca*) predation, human predation, thermal advantage, and phylogenetic inertia. The hypotheses may not be mutually exclusive and may vary with populations or regions. This study describes aspects of beluga whale summer-ecology by studying the association between inter-annual water levels and beluga habitat selection in the Nelson River estuary. Flow rates from upstream Limestone Dam doubled from the dry years of 2002–2004 to the wet year of 2005. I used radio-tracking data (N=15, 2002–2005) and aerial surveys (2003, 2005) to test the hypothesis (H1) that belugas were farther out in the estuary during the wet year. Model variables included year, day, time, tide and age-sex. Observed location-habitat distances for the radio-tracking and aerial survey data were compared to the random equivalents using a Kolmogorov-Smirnov (KS) test. A cumulative sign test determined the timing of a beluga shift in movement behaviour on August 10th. Pre-August 10th radio-tracking locations provided the spatial-temporal boundary of the Nelson River estuary. General Linear Models (GLM) for both the telemetry and aerial survey data show an association between beluga distance to the river-mouth and year. Study results provide evidence to weigh the main estuary-use hypotheses and contribute to knowledge of beluga ecology and management.

TABLE OF CONTENTS

| | |
|---|-------|
| ABSTRACT..... | ii |
| TABLE OF CONTENTS..... | iii |
| LIST OF FIGURES | vii |
| LIST OF TABLES | xv |
| ACKNOWLEDGMENTS | xviii |
| DEDICATION..... | xix |
| CHAPTER I. INTRODUCTION..... | 20 |
| I.2 BELUGA WHALE BIOLOGY..... | 23 |
| I.2.1 Description..... | 23 |
| I.2.2 Ontogeny and Reproduction..... | 24 |
| I.2.3 Diet | 25 |
| I.2.4 Distribution..... | 25 |
| I.3 STATUS AND TRENDS OF BELUGA WHALE POPULATIONS IN CANADA EXCLUDING HUDSON BAY STOCKS..... | 26 |
| I.3.1 Cumberland Sound population..... | 26 |
| I.3.2 St. Lawrence Beluga Population | 28 |
| I.3.3 Eastern High Arctic/Baffin Bay Beluga Population..... | 28 |
| I.3.4 Eastern Beaufort Sea Beluga Population..... | 29 |

| | |
|---|----|
| I.4 STUDY AREA: HUDSON BAY AND THE NELSON RIVER ESTUARY | 30 |
| I.4.1 Belugas in Hudson Bay | 34 |
| I.4.1 Eastern Hudson Bay Beluga Population..... | 34 |
| I.4.2 Ungava Bay Belugas..... | 37 |
| I.4.3 STUDY POPULATION: Western Hudson Bay Beluga Population..... | 37 |
| CHAPTER II: BELUGA WHALE (<i>Delphinapterus Leucas</i>) HABITAT USE IN THE NELSON RIVER ESTUARY DURING WET AND DRY SUMMERS | 40 |
| II.1 ABSTRACT | 40 |
| II.2 INTRODUCTION..... | 41 |
| II.3 METHODS | 43 |
| II.3.1 Tagging and Satellite Telemetry | 43 |
| II.3.2 Aerial Surveys | 47 |
| II.3.3 Statistical and Spatial Analyses..... | 49 |
| II.4.1 Caveats and Assumptions | 55 |
| II.4 RESULTS | 56 |
| II.4.1 Habitat selection..... | 56 |
| II.4.1.1 Telemetry..... | 57 |
| II.4.2 Aerial Surveys | 68 |
| II.5 DISCUSSION | 79 |
| II.5.2 Shape of Nelson River Estuary | 84 |
| II.5.3 Data Limitations | 88 |
| CHAPTER III: A REVIEW OF BELUGA WHALE (<i>Delphinapterus Leucas</i>) ESTUARY USE HYPOTHESES | 90 |

| | |
|---|-----|
| III.1 ABSTRACT..... | 90 |
| III.2 INTRODUCTION | 91 |
| III.1 Moulting..... | 91 |
| III.1.1 Warm Water for Moulting Belugas | 92 |
| III.1.2 Shallow Water for Moulting Belugas | 93 |
| III.1.3 Bottom Type for Moulting Belugas | 94 |
| III.1.4 Air Temperature / Sunlight for Moulting Belugas..... | 95 |
| III.2 Calving | 95 |
| III.5.2.1 Warm Water for Calving Belugas..... | 97 |
| III.5.2.2 Shallow Water for Calving Belugas | 99 |
| III.2.3 Shelter from Wind for Calving Belugas | 101 |
| III.2.4 Shelter from Strong Currents for Calving Belugas..... | 102 |
| III.3 Predator Avoidance; Killer Whales | 103 |
| III.4 Predator Avoidance; Humans | 111 |
| III.5 Feeding..... | 113 |
| III.6 Phylogenetic Inertia | 117 |
| CHAPTER IV: MAJOR FINDINGS AND GENERAL DISCUSSION..... | 121 |
| IV.1 MAJOR FINDINGS | 121 |
| IV.1.1 Major Findings: The Shape of Nelson River Estuary..... | 122 |
| IV.2 ANTHROPOGENIC EFFECTS | 123 |
| IV.3 MAJOR LESSONS | 126 |
| IV.4 RESEARCH PROBLEMS AND LIMITATIONS..... | 126 |
| IV.5 RECOMMENDATIONS FOR FUTURE RESEARCH | 127 |

| | |
|---|-----|
| IV.5 FINAL THOUGHTS | 128 |
| CHAPTER V. REFERENCES | 129 |
| PERSONAL COMMUNICATIONS AND UNPUBLISHED DATA | 148 |
| APPENDIX | 149 |
| V.1 3-STAGE FILTER FOR ERRONEOUS ARGOS® LOCATIONS ADAPTED FROM MCCONNELL ET AL 1992 AND AUSTIN <i>et al.</i> 2001 | 150 |
| V.2 Beluga Estuary-Use: Radio-Tracking Data and a Kernel Probability Density Function (PDE) Method..... | 178 |
| V.2 Kernel Probability Density Estimation (PDE) Methods | 178 |
| V.3 NELSON RIVER HYDROLOGY: FRESHWATER-MARINE COUPLING IN HUDSON BAY | 185 |
| Fluvial Loading Of Suspended Solids and Dissolved Organic Matter to Hudson Bay via the Churchill and Nelson-Hayes Estuaries..... | 185 |

LIST OF FIGURES

| | |
|---|----|
| Figure I.1; Map of Hudson Bay places showing the Nelson River estuary study site (shaded area lower left corner)..... | 32 |
| Figure I.2; Nelson River estuary places and the main channel (black outline) with 2005 Manitoba Hydro bathymetry data | 33 |
| Figure I.3; Map of Eastern Hudson Bay places and Rivers with summer beluga congregations | 36 |
| Figure II.1; Limestone Dam mean daily discharge for the study years of 2002–2004, and 2005, a wetter than average year from 14 July to 31 August, the period of primary habitation of the estuary by beluga whales. | 42 |
| Figure II.2; Nelson River beluga estuary-use defined using a distribution free cumulative sign value by mean of pooled day-of-year of daily median ‘distance to river-mouth’ by animal indicating the cut-off date for estuary-use locations on Julian day = 221, which corresponds to August 10 th for non-leap years..... | 51 |
| Figure II.3; Nelson River beluga estuary-use: Frequency of higher accuracy (ARGOS® location class = 1, 2, 3) estuary locations for each of the dive-enabled tags (N=13) deployed on study animals (numbered by animal (deploy id))..... | 51 |
| Figure II.4; Nelson River estuary telemetry data (2002–2005): Kolmogorov-Smirnov test (KS-test) results; Log probability plot of observed vs. random locations measuring ‘distance to river-mouth’ | 57 |

Figure II.5; Nelson River estuary telemetry data (2002–2005): Kolmogorov-Smirnov test (KS-test) results; Log probability plot of observed vs. random locations measuring ‘distance to nearest shore’ 58

Figure II.6; Nelson River estuary study with beluga locations (N=13, Number of beluga locations = 618) using a bounding polygon for locations before Aug 10th (Aug 9th for 2004, a leap year) 59

Figure II.7; Nelson River beluga radio-tracking data utilization distributions based on Kernel PDE methods for the years of 2003–2004, and 2005. 67

Figure II.8; Nelson River aerial surveys 2003: Kolmogorov-Smirnov comparison distance to nearest shore weighted by observed density vs. distance to nearest shore weighted by random density probability curves 69

Figure II.8; Nelson River aerial surveys 2003: Kolmogorov-Smirnov comparison distance to nearest shore weighted by observed density vs. distance to nearest shore weighted by random density probability curves 69

Figure II.9; Nelson River aerial surveys 2003: Kolmogorov-Smirnov comparison distance to channel weighted by observed density vs. distance to channel weighted by random density probability curves 70

Figure II.11; Nelson River aerial surveys 2005: Kolmogorov-Smirnov comparison distance to nearest shore weighted by observed density vs. distance to nearest shore weighted by random density probability curves 72

Figure II.12; Nelson River aerial surveys 2005: Kolmogorov-Smirnov comparison distance to nearest shore weighted by observed density vs. distance to nearest shore weighted by random density probability curves 72

Figure II.13; Nelson River aerial surveys 2005: Kolmogorov-Smirnov comparison
distance to channel weighted by observed density vs. distance to channel weighted
by random density probability curves 73

Figure II.14; Aerial survey beluga densities (in belugas per km²) for dry year (2003) and
a wet year (2005) depicting the shift in higher densities farther out from the Nelson
River-mouth..... 75

Figure II.15; Log transformed linear regression for Nelson River estuary beluga aerial
survey counts for the years of 2003 and 2005 in mean densities of belugas pre 1km²,
compared to ‘distance to river-mouth’ 77

Figure II.16 LANDSAT image of the Nelson River Estuary for 10 September, 2004..... 80

Figure II.17 LANDSAT image of the Nelson River Estuary for July 13th, 2005 80

Figure II.18; Nelson River estuary boundary (using beluga radio-tracking data 2002–
2005), Fisheries and Oceans Canada aerial survey extent (2004), and the Manitoba
Hydro / NorthSouth Consulting aerial survey (2003, 2005) extent 87

Figure II.1; Radio-tracking sample details for ARGOS[®] 3-stage filter on two belugas
captured during 2002, 2003 in the Nelson River estuary (N=1993). Values for each
pie are in percent 150

Figure V.2; Retained locations: Radio-tracking sample details for ARGOS[®] 3-stage filter
on two belugas captured during 2002, 2003 in the Nelson River estuary (N=1993).
Values for each pie are in percent 151

Figure V.3; Rejected locations: Radio-tracking sample details for ARGOS[®] 3-stage filter
on two belugas captured during 2002,2003 in the Nelson River estuary (N=1993).
Values for each pie are in percent 152

Figure V.4; Nelson River beluga radio-tracking data for Adult Female, TAG NO. = 10927, Captured on July 14, 2002— Inset of Hudson Bay and extent of radio-tracking data for this beluga..... 153

Figure V.5; Nelson River beluga radio-tracking data for Adult Male, TAG NO. = 10971, Captured on July 31, 2003 153

Figure V.5b; Nelson River beluga radio-tracking data for Adult Male, TAG NO. = 10971, Captured on July 31, 2003—Zoom of Nelson River Estuary and usage by this beluga 154

Figure V.6; Nelson River beluga radio-tracking data for Adult Female, TAG NO. = 10972, Captured on July Aug 4, 2003 155

Figure V.6b; Nelson River beluga radio-tracking data for Adult Female, TAG NO. = 10972, Captured on July Aug 4, 2003—Zoom of Nelson River Estuary and usage by this beluga 157

Figure V.7; Nelson River beluga radio-tracking data for Adult Female, TAG NO. = 10926, Captured on August 5, 2003 158

Figure V.7b; Nelson River beluga radio-tracking data for Adult Female, TAG NO. = 10926, Captured on August 5, 2003—Zoom of Nelson River Estuary and usage by this beluga 159

Figure V.8; Nelson River beluga radio-tracking data for Adult Male, TAG NO. = 10899, Captured on August 7, 2003 160

Figure V.8b; Nelson River beluga radio-tracking data for Adult Male, TAG NO. = 10899, Captured on August 7, 2003—Zoom of Nelson River Estuary and usage by this beluga 160

Figure V.9; Nelson River beluga radio-tracking data for Adult Male, TAG NO. = 10970,
Captured on August 5, 2003 162

Figure V.9b; Nelson River beluga radio-tracking data for Adult Male, TAG NO. = 10970,
Captured on August 5, 2003—Zoom of Nelson River Estuary and usage by this
beluga 163

Figure V.10; Nelson River beluga radio-tracking data for Adult Male, TAG NO. = 10979,
Captured on July 24, 2004 164

Figure V.10b; Nelson River beluga radio-tracking data for Adult Male, TAG NO. =
10979, Captured on July 24, 2004 —Zoom of Nelson River Estuary and usage by
this beluga 164

Figure V.11; Nelson River beluga radio-tracking data for Adult Male, TAG NO. = 10978,
Captured on July 17, 2004 166

Figure V.11b; Nelson River beluga radio-tracking data for Adult Male, TAG NO. =
10978, Captured on July 17, 2004—Zoom of Nelson River Estuary and usage by
this beluga 167

Figure V.12; Nelson River beluga radio-tracking data for Adult Female, TAG NO. =
10980, Captured on July 25, 2004 168

Figure V.12b; Nelson River beluga radio-tracking data for Adult Female, TAG NO. =
10980, Captured on July 25, 2004—Zoom of Nelson River Estuary and usage by
this beluga 169

Figure V.13; Nelson River beluga radio-tracking data for Adult Female, TAG NO. =
40622, Captured on July 26, 2004—Inset of Hudson Bay and extent of radio-
tracking data for this beluga..... 170

| | |
|---|-----|
| Figure V.14; Nelson River beluga radio-tracking data for Adult Male, TAG NO. = 40623, captured on July 27, 2004 | 171 |
| Figure V.14b; Nelson River beluga radio-tracking data for Adult Male, TAG NO. = 40623, captured on July 27, 2004—Zoom of Nelson River Estuary and usage by this beluga | 171 |
| Figure V.15; Nelson River beluga radio-tracking data for Adult Male, TAG NO. = 10970, Captured on July 23, 2005 | 173 |
| Figure V.15b; Nelson River beluga radio-tracking data for Adult Male, TAG NO. = 10970, Captured on July 23, 2005—Zoom of Nelson River Estuary and usage by this beluga | 173 |
| Figure V.16; Nelson River beluga radio-tracking data for Adult Male, TAG NO. = 40153, captured on July 31, 2005— Inset of Hudson Bay and extent of radio-tracking data for this beluga | 175 |
| Figure V.17; Nelson River beluga radio-tracking data for Sub-adult Male, TAG NO. = 57600, captured on July 31, 2005 | 175 |
| Figure V.17b; Nelson River beluga radio-tracking data for Sub-adult Male, TAG NO. = 57600, captured on July 31, 2005—Zoom of Nelson River Estuary and usage by this beluga | 177 |
| Figure V.18; Week one (mid–late July) of Nelson River estuary weekly beluga utilization distributions using Kernel methods, when some of the study whales are likely affected by the stress of capture, tagging and release methods. Colors represent utilization percentiles. Red=25%, orange=50%, yellow=75%, clear-outline=95% | 180 |

Figure V.19; Week 2 (late July) of Nelson River estuary weekly beluga utilization distributions using Kernel methods. The extent of usage has condensed back toward the mouth of the Nelson River. By week 2, most of the study whales have returned to ~ 20–50 km offshore, but within the limits of the estuary. Colors represent utilization percentiles. Red=25%, orange=50%, yellow=75%, clear-outline=95% 181

Figure V.20; Week 9 (late September) of Western Hudson bay belugas tagged in the Nelson River estuary weekly utilization distributions using Kernel methods, when all of the study whales have left the estuary and are either moving north along the west coast of Hudson Bay. Colors represent utilization percentiles. Red=25%, orange=50%, yellow=75%, clear-outline=95% 182

Figure V.21; Week 17 (early–mid October) of Western Hudson bay belugas tagged in the Nelson River estuary weekly utilization distributions using Kernel methods, when the first of the 10 study whales still transmitting arrived at Hudson strait. Individuals with Eastside migrations arrived later. Colors represent utilization percentiles. Red=25%, orange=50%, yellow=75%, clear-outline=95% 183

Figure V.22; Week 30 (December) of Western Hudson bay belugas tagged in the Nelson River estuary weekly utilization distributions using Kernel methods, where (now n=4) have now arrived at Hudson Strait. Colors represent utilization percentiles. Red=25%, orange=50%, yellow=75%, clear-outline=95% 184

Figure V.23; MODIS image showing CTD measurements transect for the Nelson River estuary for 8 August 2006 186

Figure V.24: Coloured Dissolved Organic Matter (CDOM) vs. salinity for the Nelson River estuary; An example of complex subsurface mixing in a hydrological system 186

Figure V.25: Turbidity vs. salinity for the Nelson River estuary; An example of complex subsurface mixing in a hydrological system..... 187

LIST OF TABLES

| | |
|---|----|
| Table II.1. Details regarding the 15 belugas captured and fitted with radio tags at the Nelson River estuary in the summers of 2002–2005. | 44 |
| Table II.2; Weekly sample sizes for Nelson River estuary beluga whale radio-tracking data by sampling week and year for 2002–2005 | 45 |
| Table II.3; Aerial Surveys for beluga whales (<i>Delphinapterus Leucas</i>) conducted in the Nelson River Estuary for the summers of 2003 to 2005 and included in General Linear Model..... | 49 |
| Table II.4; Nelson River estuary telemetry data (2002–2005): Kolmogorov-Smirnov (K-S) test results; Log probability plot of observed vs. random locations measuring ‘distance to river-mouth’ | 57 |
| Table II.5; GLM Results for 2002–2005 Nelson River estuary beluga whale radio-tracking data, using the dependent variable, Distance to river-mouth (in km) | 62 |
| Table II.6; Tukey's Studentized Range (HSD) test for 2002–2005 Nelson River estuary beluga whale radio-tracking data and dependent variable Distance to river-mouth (in km), where Alpha = .05, and table values are LS means | 64 |
| Table II.7; GLM Results for 2002–2005 Nelson River estuary beluga whale radio-tracking data and the dependent variable, ‘distance to shore’ (in km) | 65 |

| | |
|--|-----|
| Table II.8; Tukey's Studentized Range (HSD) test for 2002–2005 Nelson River estuary beluga whale radio-tracking data and dependent variable Distance to shore (in km), where Alpha = 0.05, and table values are LS means | 65 |
| Table II.9; Nelson River estuary aerial surveys 2003: Kolmogorov-Smirnov comparisons of distance to habitat features weighted by density: Probability plot of observed vs. random densities | 68 |
| Table II.10; Nelson River estuary aerial surveys 2005: Kolmogorov-Smirnov comparisons of distance to habitat features weighted by density (random and observed)..... | 71 |
| Table II.11; GLM Results for 2003 and 2005 Nelson River estuary beluga whale aerial survey counts and dependent variable, Density (in Belugas per km ²)..... | 76 |
| Table II.12; Aerial Surveys 'distance to river-mouth' vs. beluga whale density for the Nelson River estuary aerial surveys flown in the summers of 2003 and 2005, where * indicates the highest R ² value..... | 78 |
| Table II.13; Pearson Correlation Coefficient for Distance to River-mouth (in km) and Tide Level (in meters), number of observations = 683..... | 83 |
| Table III.14; Historic killer whale sightings for southwestern Hudson Bay, Churchill region from the 1940s to present. | 106 |
| Table V.1. Details on the 8 belugas captured and fitted with radio tags at the Churchill River estuary in the summers of 1992–93. (Source: Martin and Smith 1994, P. Hall, Department of Fisheries and Oceans, Canada, Winnipeg, Manitoba, pers. comm. 2005..... | 149 |

Table V.2; Radio-tracking sample details for ARGOS® 3-stage filter on two belugas captured during 2002,2003 in the Nelson River estuary (N=1993)..... 150

Table V.3; Retained locations: Radio-tracking sample details for ARGOS® 3-stage filter on two belugas captured during 2002, 2003 in the Nelson River estuary (N=1993) 151

Table V.4; Rejected locations: Radio-tracking sample details for ARGOS® 3-Stage filter on two belugas captured during 2002,2003 in the Nelson River estuary (N=1993) 152

Table V.5; Number of locations for each beluga whale captured in the Nelson River estuary and satellite-tag deployed for years of 2002–2005. 178

ACKNOWLEDGMENTS

I thank my major advisor, Steven Ferguson PhD, for his support, advice, and input into the analyses, compilation, and review of this study. I also thank my co-advisor David Walker PhD and my committee members Pierre Richard and Dave Barber PhD. I had the privilege of access to their expertise. Jack Orr provided expert reviews but also served as a guide on my first Arctic field experience. Jack knows how to capture belugas safely and efficiently, and knows how to manage large field operations effectively. I thank the University of Manitoba, Manitoba Hydro, the Nunavut Wildlife Research Trust Fund, ArcticNet and Fisheries and Oceans Canada for providing a functional research environment and for their funding support. Pierre Richard graciously provided the radio-tracking data that made this research possible. Roy Bukowsky has facilitated this research on the part of Manitoba Hydro. I also value greatly the friends I have made in Northern Canada and this chance to learn about First Nations people by spending time with them in the field. This study exists through the hard work of all those involved in the fieldwork as well as those involved in the manuscript review. Thanks to Jeff Higdon of the Orcas of the Canadian Arctic (OCA) research group for providing expertise, review, and numerous links to scarce killer whale references.

DEDICATION

I dedicate this thesis to my partner Meg. Megs support during my long field seasons and her understanding and support of my goals have made this research possible.

CHAPTER I. INTRODUCTION

In ecology, knowledge of a species or population relies upon an understanding of its own species parameters, but also of its interactions with its environment. Thus, habitat studies are necessary precursor to assessing its potential vulnerability to changes to its environment. Animals inhabiting Arctic ecosystems, including beluga whales (*Delphinapterus leucas*) (Pallas 1776), often face seasonally scarce resources and migrate long distances (Draper 1989; Sergeant 1973; Geraci 2005). For this reason, small environmental changes can have substantial affects on health and fecundity of Arctic animals (Gaston *et al.* 2002). Global oceanographic, climate, and general circulation models predict that the most extreme and acute effects of global warming will occur in the Arctic. Predicted effects include more erratic precipitation patterns and increased river outflows (Hinzman 1992; Tynan 1997; Fyfe 1999; Peterson *et al.* 2003). Belugas, like other marine mammals, are vulnerable to these changes for reasons including their strong philopatry to certain sites of seasonal aggregation (Degerbøl and Nielson 1930 in Heide-Jørgensen 2002; O'Corry-Crowe 1997; COSEWIC 2004).

Beluga whales are medium sized cetaceans having a primarily panArctic range. In 2002 the beluga population estimate in Canadian waters numbered between 72,000 and 144,000 (DFO 2002), with individual stock populations ranging from zero (Ungava Bay) to 57,000 (Western Hudson Bay). This study focuses on aspects of the summer ecology of the Western Hudson Bay population, considered the largest single beluga whale population on earth (Richard 2005). The goal of this thesis is to understand factors

affecting beluga whale estuary-use. Implications of this research are applicable to management of Western Hudson Bay belugas and their habitat.

Most beluga stocks use estuaries in ice-free regions during summer, but reasons for this behaviour are unknown. Beluga estuary-use hypotheses include feeding (Kleinenberg *et al.* 1969; Seaman and Burns 1981; Seaman *et al.* 1982), calving (Sergeant and Brodie 1969; Sergeant 1973; Fraker *et al.* 1979), moulting (Finley 1982; St. Aubin *et al.* 1990), avoiding killer whales (*Orcinus orca*) (Brodie 1971), avoiding humans (Caron and Smith 1990; Kilabuk 1998), thermal advantage (Sergeant and Brodie 1969; Fraker *et al.* 1978) and phylogenetic inertia (W. Doidge, Makivik Corporation, Montreal, Quebec, pers. comm. 2005). The last hypothesis, Phylogenetic inertia, describes the influence of an ancestor on its descendents; retaining traits unless altered by behavioural mutation (Dembski 2001). Little tested evidence exists for any of the above estuary-use hypotheses and some, including phylogenetic inertia, are not published (Doidge 1990; Caron 1990; W. Doidge, Makivik Corporation, Montreal, Quebec, pers. comm. 2005).

Early research suggested feeding as a main reason for this beluga estuary-use (Comeau 1915; Vladykov 1947; Kleinenberg *et al.* 1969; Seaman and Burns 1981; Seaman *et al.* 1982). Research on stomach contents of belugas in estuaries taken during local harvests however, contradicts this hypothesis. Since many female belugas with calves are observed in estuaries, calving was thought to be the primary behavioural motivation (Sergeant and Brodie 1969; Sergeant 1973; Fraker *et al.* 1979). Research on blubber and skin layers (Doidge, 1990, Boltunov *et al.* 2002) and observations of most females arriving in estuary already with calves contradicts this view. This evidence, along

with observations of warmer water in estuaries led to the hypothesis of thermal advantage to all ages and sex classes in the estuaries (Fraker *et al.*, 1978). However, belugas are adapted to a pack-ice environment with near-zero Celsius waters so evidence does not support this hypothesis (Doidge, 1990). Doidge (1990) notes that belugas and narwhals have equal insulation but only belugas exhibit seasonal occupation of warmer estuarine waters. Moreover, elevated hormone levels were found in belugas in some estuaries, strengthening the moulting hypothesis as a principle reason for beluga estuary-use (Finley 1982; St. Aubin *et al.* 1990). Past studies on belugas in estuaries offer little tested evidence and lack ecological context. Part of the reason for the absence of published research is that belugas, like other marine mammals, especially Arctic species, live most of their lives under water, and often at locations not easily accessible by humans (Martin and Smith 1992; Martin *et al.* 1993, Martin *et al.* 1998; Heide-Jørgensen *et al.* 1998).

For this thesis, I begin **Chapter I** with an overview of beluga whale biology and a brief description of the status and trends of beluga whales in the Canadian Arctic. I then provide a slightly more in-depth description of Hudson Bay, the Nelson River estuary study site, and Western Hudson Bay belugas.

Chapter II examines beluga habitat associations for wet and dry years in the Nelson River estuary, Manitoba, (Port Nelson, 133° 48' W, 55° 41' 45" N). Radio-tracking (n=15) and aerial survey data for belugas collected over the summers of 2002–2005 were used to test the hypothesis (H1) that belugas remained farther offshore during the wet year. Model variables included tide level, depth, year, Julian day, time of day, and age-sex class. First, I use Kolmogorov-Smirnov (K-S) tests to compare the observed data distributions to random-generated data distributions. I then use a distribution-free

cumulative sign test to define the estuary boundary, by measuring day-to-day differences in median distances of the belugas to the river mouth. General Linear Models (GLM) and Tukey's Studentized comparison of means tests are then used to explore the beluga-habitat associations. Finally, results are related to the beluga estuary-use hypotheses.

Chapter III uses a 'weight of evidence' approach to review existing beluga estuary-use hypotheses, including **Chapter I** results. **Chapter IV**, includes major findings and a general discussion of beluga estuary-use including a discussion on any anthropogenic effects caused by the artificial alteration of riverine systems. I conclude with recommendations for future research on the beluga estuary hypotheses. The appendix contains additional information and figures related to this study. Movement maps for each of the 14 Nelson River radio-tracked belugas are also located in the appendix.

I.2 BELUGA WHALE BIOLOGY

I.2.1 Description

The beluga whale is a medium-sized odontocete. Size varies between populations with Hudson Bay belugas being among the smallest (Kleinenberg 1964). Generally, adult male belugas measure 2.6–6.7 meters in length and weigh 450–1000 kilograms, while adult females measure 3–4 meters in length and weigh 250–700 kilograms (Kleinenberg 1969; Brodie 1971; Stewart and Stewart 1989). Neonates measure approximately 1.6 meters in length and are born grey-cream or pink in colour, and then turn dark brown or blue-grey (Brodie 1971; DFO 2002). Belugas reach maturity, which is typically

associated with a change in coloration to white at 12–18 years, and can live up to 92 years (Harwood 2002), assuming one growth layer group (GLG) per year (Stewart *et al.* 2006). However, reports exist of grey ones giving birth (S. Ferguson pers. Comm., Department of Fisheries and Oceans, Canada. Winnipeg, pers. comm. 2007). The white coloration of adults may be an adaptation to their environment. It is the source of their name, originating from *Belukha*, which is Russian for white. The scientific name '*Delphinapterus leucas*' translates as "the white dolphin without a wing"(DFO 2002). Belugas are also commonly referred to as white whales likely to differentiate them from the white (or beluga) sturgeon (*Huso huso*).

I.2.2 Ontogeny and Reproduction

The bulk of knowledge regarding the development or course of development of an individual beluga (Ontogeny) exists through in-situ observation and necropsies. The majority of beluga mating occurs during spring and timing varies geographically (Brodie, 1971). Doan and Douglas (1953) suggested that some mating in Western Hudson Bay may continue into September. Little evidence exists regarding beluga mating, although males have exhibited polygamy (Stewart and Stewart 1989). Gestation lasts approximately 14 months and births occur from June to August, followed by a nursing period of approximately 18 months. These reproductive parameters mean that females can produce young only every three years. Peak calving times also vary geographically from late march to early august (Stewart and Stewart 1989). Western Hudson Bay belugas generally give birth at the end of June, coinciding with the break up of the sea ice (Sergeant 1986). Rapid growth in neonates is due to the fat-rich milk of the mother.

Newborn calves grow from 40 percent of their mother's length to 65 percent in the first year and measure approximately 70 percent of adult length when weaned at the end of the second year (Stewart and Stewart 1989).

I.2.3 Diet

Belugas have one of the most varied diets of any cetacean. Seasonal availability of prey items results in a generalist diet consisting of capelin, Arctic cod, herring, shrimp, squid, and marine worms (Kleinenberg 1969; Seaman *et al* 1982; DFO 2002). Some unique adaptations of belugas, possibly related to feeding, include the lack of a dorsal fin and un-fused cervical vertebrae, allowing lateral flexibility of the head and neck, presumably to aid in benthic and sub-sea ice foraging (Vladykov 1949)

I.2.4 Distribution

Belugas have a primarily panArctic distribution throughout seasonally ice-covered Arctic and subArctic waters of the Northern Hemisphere (Gurevich 1980, Stewart 1989). Most beluga stocks congregate in shallow estuaries during summer months. During winter, belugas are closely associated with open leads and polynyas in ice-covered regions (Doidge and Finley, 1993; Richard 1990; Richard *et al.* 1993; Richard 2002). Depending on season and region, they may occur in both offshore and coastal waters. Sea-ice, tide, temperature, human action, and access to prey affect seasonal distribution (Lowry 1985). Annual migrations may cover thousands of kilometers (Reeves 1990). During spring, most belugas migrate to warmer coastal estuaries, bays, and rivers. Reasons for this behaviour are unknown and are the subject of

this study. Beluga stocks are generally defined by summer aggregation sites (Martin and Reeves 2000), whereas beluga populations are generally defined using genetics along with other evidence such as radio-tracking data. The International Whaling Commission (IWC) currently recognizes at least 29 separate beluga stocks, with possibly more occurring in Russian waters. Sightings of vagrant belugas exist for Iceland, the Faro Islands, Ireland, Scotland, France, the Netherlands, Denmark, Japan, coastal New Jersey, the Delaware River and Washington State (Rice 1998; Martin and Reeves 2000, L. Keith, pers. Comm. Wildlife Trust, St. Petersburg Florida, 2006). Canadian waters harbour 72,000–144,000 belugas (Fisheries and Oceans Canada 2002).

I.3 STATUS AND TRENDS OF BELUGA WHALE POPULATIONS IN CANADA EXCLUDING HUDSON BAY STOCKS

The following are status and trends of beluga whale populations with descriptions summarized from the 2004 Committee On the Status of Endangered Wildlife In Canada (COSEWIC 2004) report and other sources were applicable. See section 1.4 for equivalent information regarding Hudson Bay stocks including Western Hudson Bay belugas in the Nelson River Estuary.

I.3.1 Cumberland Sound population

Numbers of belugas using Cumberland sound have declined since the 1920s (COSEWIC 2004). The Hudson Bay Company and later the Inuit are thought to have caused this population decline (Soper 1928; Brodie 1971, COSEWIC 2004). Accordingly, hunting regulations were implemented here in the 1980s. Commercial

hunting in Cumberland sound from 1868 to 1939, mostly in Clearwater Fiord, reduced the original population of approximately 5,000 whales (Mitchell and Reeves 1981) to less than 1,000 in the 1970s (Brodie *et al.* 1971). More recent abundance estimates (n=1,547, Richard 2002) suggest that this population may be rebounding but historic data are scarce (Soper 1928; Brodie 1971). Current quotas (41 in 2003) appear to be sustainable (COSEWIC 2004). COSEWIC raised concerns about increased small vessel traffic and the noise of outboard motors, as well as possible impacts of the Greenland halibut fishery. Recent radio tracking and genetics data suggest that this population resides in Cumberland Sound year-round (Richard 1990; Richard 2002). The combined Southeast Baffin Island-Cumberland Sound population was designated as Endangered in April 1990. In May 2004, the structure of the population was redefined and named the "Cumberland Sound population". Supporting evidence for this redefinition included growth measurements, genetic and contaminants profiles and satellite tracking data. These combined data confirmed that most belugas hunted in Cumberland Sound are distinct from those hunted near Iqaluit and Kimmirut, which have more genetic links to the Western Hudson Bay population (COSEWIC 2004). Cumberland Sound hunters however, recognize three types of belugas: 1) Smaller, thinner and white belugas hunted at the floe edge in spring 2) Larger yellow belugas with signs of epidermal moult 3) Smaller, thinner belugas with thicker skin and a stronger taste that are killed outside of Clearwater Fiord on the west side of Cumberland Sound (Kilabuk 1998; Richard 2002). The status of the population was re-examined by COSEWIC in May 2004 and the proposed new designation is Threatened.

I.3.2 St. Lawrence Beluga Population

The St. Lawrence beluga population was severely reduced by commercial hunting which lasted until 1979 (Kinsley 2002). High contaminant loads may have also contributed to the population decline (COSEWIC 2004). Aerial survey estimates since 1973 suggest that the decline has ceased, yet do not provide evidence of a population increase (COSEWIC 2004). St. Lawrence belugas experience more exposure to pollutants than other beluga populations in Canada. There is debate on whether the prevalence of cancer in mortality samples for this population relates to exposure of industrial pollutants (Geraci *et al.* 1987, Muir *et al.* 1990; Martineau *et al.* 2002; Hammill *et al.* 2003). Available comparable research is limited because little information exists from other beluga populations on cancer rates. Vessel traffic and industrialization of the St. Lawrence watershed also threatens belugas and their habitat. The range of this population includes Quebec and the Atlantic Ocean and was designated Endangered in April 1983 and again in April 1997. The status of the population was re-examined in May 2004 and the proposed new designation is Threatened.

I.3.3 Eastern High Arctic/Baffin Bay Beluga Population

The range of this population includes Nunavut and the Arctic Ocean with most summering around the coastal shelf habitats of Somerset Island (Smith and Martin 1994; Innes and Stewart 1996). This population was thought to winter in the pack ice off the west coast of Greenland (Finley and Renaud 1980) with some belugas observed in the North Water polynya of Baffin Bay (Doidge and Finley, 1993; Richard *et al.* 1993).

Recent research suggests that most belugas from this population winter in Baffin Bay and the High Arctic, with a smaller number wintering in central west Greenland (Richard et al 2001). Autumn radio tracking data for this population also suggest that the North Water may harbour a larger winter population of belugas than was previously suspected (Richard et al 2001). These wintering populations may actually consist of two distinct populations (COSEWIC 2004). Hunting pressure is a concern for the portion of this population wintering in central west Greenland. For these reasons, this population received the status of Special Concern in April 1992. At the last assessment in May 2004, the proposed designation remained the same.

I.3.4 Eastern Beaufort Sea Beluga Population

The eastern Beaufort Sea beluga population is currently large (20,000–40,000) and harvests are within sustainable limits. However, there is no US-Canada international agreement that is binding to both nations. The range of this population includes the Northwest Territories and the Arctic Ocean wintering in the Bering Sea and migrating to summering areas in the Beaufort Sea and Amundsen Gulf (Marko and Fraker 1981 in Harwood 1992). Most belugas in this stock use the warm estuarine waters of the Mackenzie River with others are widely distributed offshore (Norton and Harwood 1985). In August, most disperse eastward toward the Amundsen Gulf and Viscount Melville Sound migrating westward along the Alaskan coast and offshore under polar pack ice in the autumn (Richard 2000; COSEWIC 2004). This population was designated as Not at Risk in April 1985 and proposed to remain the same again in May 2004 (COSEWIC 2004).

I.4 STUDY AREA: HUDSON BAY AND THE NELSON RIVER

ESTUARY

Hudson Bay is a semi-enclosed saltwater system fed by many large freshwater riverine systems, including the Churchill and Nelson Rivers in Manitoba. At least five whale species use Hudson Bay, including belugas, narwhals, bowheads, killer whales, and minke whales but only belugas routinely use James Bay and south eastern Hudson Bay (Stewart 2003). Unconfirmed reports also exist for sperm whales, northern bottlenose whales (Stewart 2003), and pilot whales (G. Lundie, SeaNorth tours, Churchill, Manitoba, pers. comm. 2006).

Sea ice controls seasonal marine ecosystems in Hudson Bay. The extent of coverage and episodic persistence of sea ice from late spring and into summer can cause Hudson Bay to experience colder than average air temperatures for its latitude, especially along the south western coast, including the Nelson and Churchill River estuaries (Gough and Leung, 2002; Ju and Gough, 2004). Ice coverage in winter is complete. August and September are typically the only two completely ice-free months (Gough and Allakhverdova 1999). Freeze-up typically begins in late October in northern Hudson Bay and spreads southward in November and December (Prinsenber, 1986). Sea ice coverage peaks in thickness between late March and May, depending on latitude. Break-up occurs in June and July (Gagnon and Gough, 2004a, 2004b). There is no multi-year sea ice in Hudson Bay and James Bay. Sea ice thickness over Hudson Bay averages 1.6 meters (Gough and Allakhverdova 1999; Gough 2001; Saucier and Dionne 1998) and ranges from 0.9 meters at Moosonee to greater than 2.3 meters at Inukjuak. Belugas are

well adapted for sea ice having thick insulating blubber and skin, and no dorsal fin. They also possess the ability to break through ice up to 20 cm thick using their melon or dorsal ridge to open breathing holes (Freeman 1968; Sergeant 1973; Finley and Renaud 1980; Mitchell and Reeves 1981).

The Churchill and Nelson River watersheds drain freshwater to Hudson Bay from over 1.4 million km² of the north-central region of North America. The Nelson River estuary is large and shallow, exposing vast tidal flats at low tide. Port Nelson can have currents measuring more than 2m/s (Bernhardt 2004). Limestone Dam, located approximately 30 km upstream from Port Nelson controls freshwater flow to the lower Nelson River (Figure II.2). Water moving to and from the estuary has naturally dredged a shallow channel (15–25m deep) that forks out from Port Nelson in a northeast direction to the outer estuary, and then northward along the western shore of Hudson Bay (Figure I.4; GEBCO 2000; Manitoba Hydro Bathymetry 2005). Tidal range in the Nelson River estuary is 3– 4 meters (Bernhardt 2004). The surficial geology of the Nelson River estuary is primarily composed of clay, boulders, and gravel. Belugas congregate in the Churchill and Nelson River estuaries *during summer months* and migrate to Hudson Strait in autumn (Sergeant 1973; Richard 1993; Richard 2005)

Figure I.1; Map of Hudson Bay places showing the Nelson River estuary study site (shaded area lower left corner)

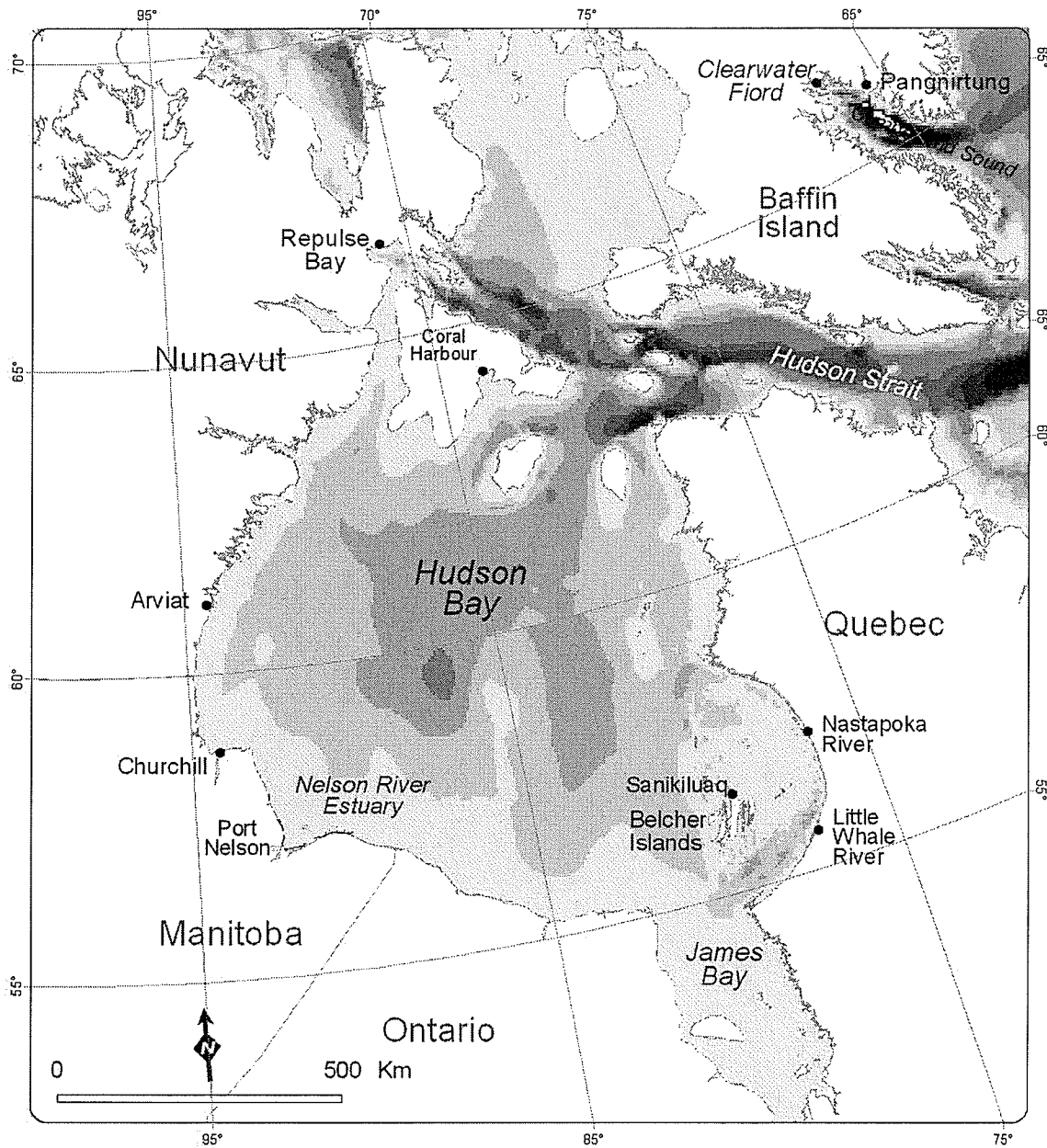
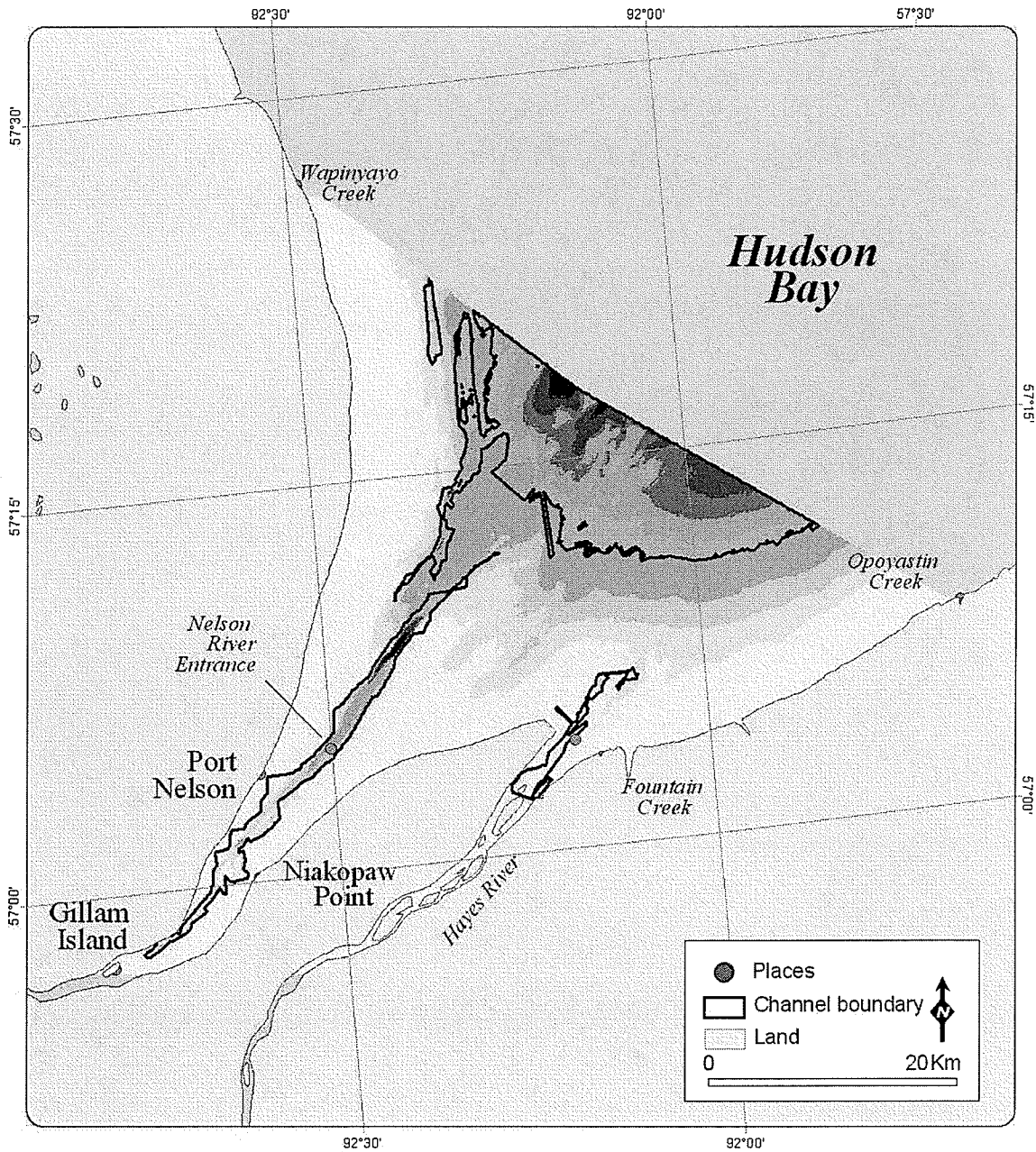

Figure I.2; Nelson River estuary places and the main channel (black outline) with 2005 Manitoba Hydro bathymetry data



I.4.1 Belugas in Hudson Bay

Beluga skin samples collected for genetic analyses indicate that animals found in eastern Hudson Bay and western Hudson Bay form two distinct populations (Brennin et al 1997; Brown-Gladden et al 1997; de March and Maiers 2001). COSEWIC recognizes at least three separate beluga management stocks, based on locations of summer aggregation sites. Insufficient genetics data exist from the James Bay and Ungava Bay beluga stocks to determine their relationship to Eastern and Western Hudson Bay belugas (Gosselin 2002).

Belugas in the Nelson River estuary belong to the Western Hudson Bay beluga stock, a genetically semi-distinct population. The term 'semi-distinct' is used here in place of 'distinct' because limited mixing take place between Western Hudson Bay and other Hudson Bay stocks (de March *et al.* 2002). This stock is considered the largest single beluga population on earth (ca. 57,000 Richard 2005). Western Hudson Bay belugas also occur in other Hudson Bay estuaries and coastal regions, in smaller numbers, during the open water season.

I.4.1 Eastern Hudson Bay Beluga Population

The Eastern Hudson Bay beluga population has been reduced by at least 50 percent of its pre-western whaling numbers and continues to decline (COSEWIC 2004). Over-exploitation continues throughout summer and migratory range. Mathematical models predict that it will likely disappear under present hunting levels in less than 10 to 15 years (COSEWIC 2004). Research on this population has also linked population declines to habitat degradation of estuaries by hydroelectric development and by small

vessel traffic disturbance (COSEWIC 2004). The summer range of this population includes the estuarine habitats of the Nastapoka and Little Whale Rivers with some coastal occupation from Kujjuarapik to Inukjuak (fig I.3). Belugas throughout this region also occur offshore extending out to the Belcher Islands (Smith and Hammill 1986, Kingsley 2000, Gosselin *et al.* 2002). In autumn, like other Hudson Bay beluga stocks, Eastern Hudson Bay belugas migrate to Hudson Strait (COSEWIC 2004). The southern boundary of the Eastern Hudson Bay population is not clearly delineated (COSEWIC 2004). This population was designated as Threatened in April 1988 by COSEWIC and its status was re-examined with a proposed new designation in May 2004 of Endangered.

Figure I.3; Map of Eastern Hudson Bay places and Rivers with summer beluga congregations

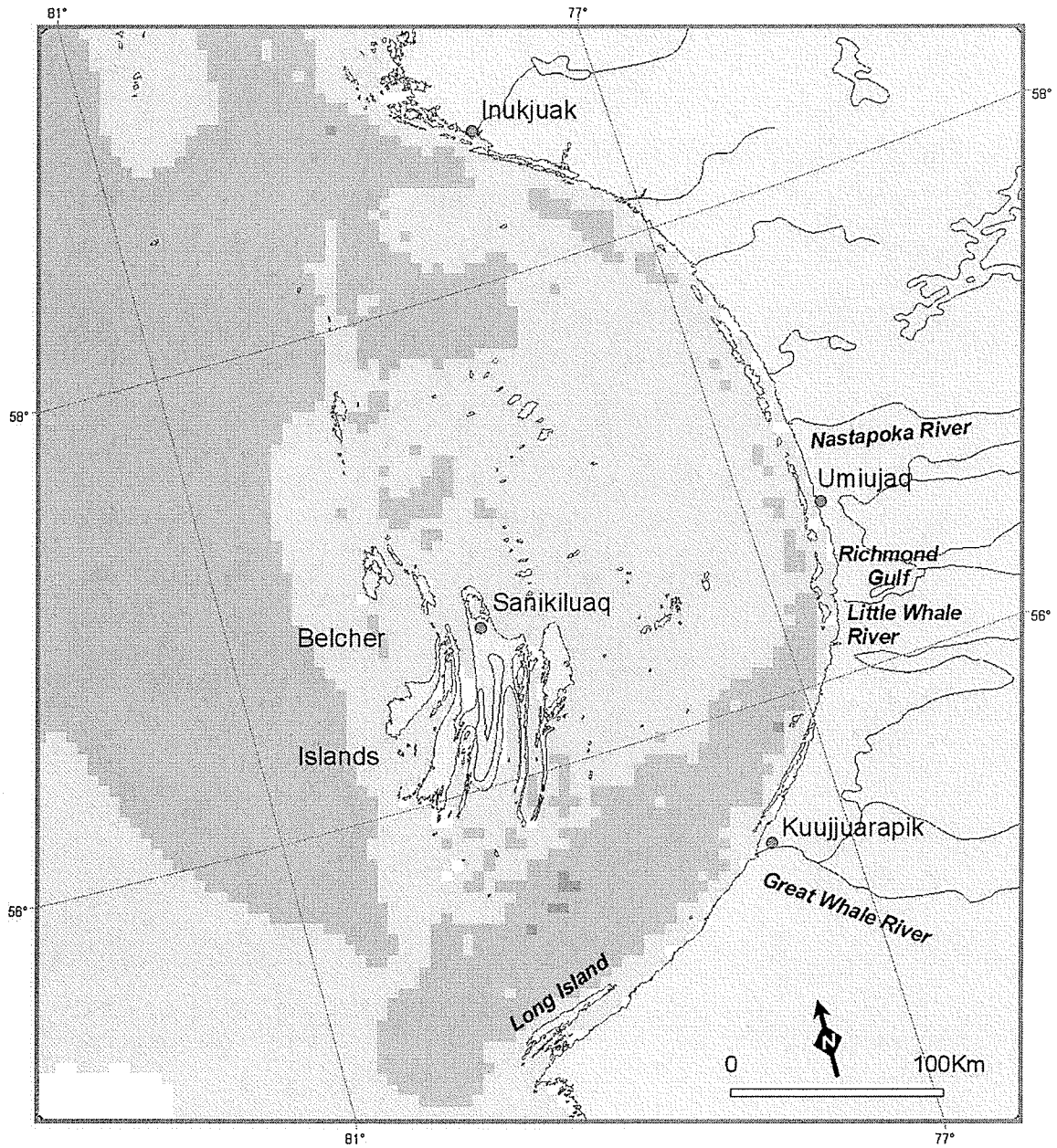

I.4.2 Ungava Bay Belugas

The Ungava Bay beluga population may be extirpated. Aerial surveys flown in Ungava Bay during the summers of 1978 and 1980 recorded approximately 50 belugas concentrated around the Mucalic River (Finley *et al.* 1982). Surveys of this region since 1985 have observed no whales (Smith and Hammill 1986; Kingsley 2000; Gosselin 2002). It is difficult to conclude this stock's extirpation. Belugas from other range-sharing stocks can occur in Ungava Bay, and Ungava Bay belugas may intersperse among other stocks while over-wintering in Hudson Strait. Over-hunting has caused the population decline and whale hunting in Ungava Bay continues to threaten any remaining belugas (COSEWIC 2004). The range of this population includes Ungava Bay and Hudson Strait (Kingsley 2000; Gosselin *et al.* 2002). COSEWIC designated this population as Endangered in April 1988 and following re-examination in May 2004 it was proposed to remain the same (COSEWIC 2004).

I.4.3 STUDY POPULATION: Western Hudson Bay Beluga Population

The Western Hudson Bay beluga population is abundant (Richard 2005). This population is hunted in parts of its range, and may be affected by shipping and hydroelectric dams. The range of this population was redefined in May 2004 to include those Southeast Baffin Island belugas outside of Cumberland Sound (figure 4). Previously, Southeast Baffin Island belugas outside of Cumberland Sound were considered part of a Southeast Baffin Island population (COSEWIC 2004). The population status of Western Hudson Bay belugas was designated as Not at Risk in April

1993. A re-examination in May 2004 proposed a designation of Special Concern (COSEWIC 2004). In August of 2004 Fisheries and Oceans Canada conducted aerial surveys of belugas in western and southern Hudson Bay (Richard 2005) revealing a total estimate of 57,300 (95% C.L.: 37,700–87,100) (Richard 2005) for the Churchill-Seal and Nelson estuaries. The uncorrected estimate (i.e.: belugas observed near the surface) in the Churchill-Seal and Nelson areas of 27,200 is close to the 1987 estimate of 25,100 (Richard 2005). Thus, recent data suggests that the population level for this stock has not experienced significant change since 1987 (Richard 2005). Many more belugas were observed along the Ontario coast of Hudson Bay but assigning them to a single stock is not possible due to a lack of stock identity information. The estimates given above are conservative due to the possibility that individuals may move amongst surveyed regions between survey dates (Richard 1993; Richard 2005).

The range of the Western Hudson Bay beluga population includes Manitoba, Nunavut, Ontario, the Arctic Ocean, and the Atlantic Ocean. In mid-July, Western Hudson Bay belugas range coastally from Eskimo Point to the Ontario border with concentrations at the Seal, Churchill and Nelson River estuaries (Richard 1993). Beginning in early August, Western Hudson Bay belugas start to move out of the Churchill and Nelson estuaries (Richard 1993). The aerial observations of Richard (1993) coincide with results of this study. After leaving the Nelson River estuary, 7 of the 14 radio-tracked belugas moved up the west coast of Hudson Bay and then across the north coast of Hudson Bay heading east to Hudson strait. Two of the fourteen belugas moved east along the Ontario coast of Hudson Bay crossing the mouth of James Bay. One of these 2 belugas traveled up the east side of the Belcher Islands past the Nastapoka and

Little Whale Rivers (figure I.5, figure V.4) and one traveled up the west side (figure V.9). Both belugas then migrated north to Hudson Strait, where their movements suggest feeding. Although the two belugas migrating along Eastern Hudson Bay left the Nelson River estuary earlier than other radio-tracked belugas, they arrived in Hudson Strait weeks later. This delay was partly due to the length of time spent (Aug 13–Nov 17 and Aug 21–Oct 12) by these two belugas around the Belcher Islands where their circular movements suggest foraging.

One other beluga exited the Nelson River estuary and moved northward but then it departed from the west coast of Hudson Bay at a position approximately 150 km north of the Nelson River on 6 October. High quality ARGOS[®] uplinks (location class=1, 2, 3) were not transmitted again until 18 October from central Hudson Bay approximately 145 km south of Coral Island. Its movements while there suggest it was feeding. Time-gaps in radio-tracking data for this beluga make it difficult to visualize any clear migration patterns (figure V.5). While Western Hudson Bay belugas are in estuaries, another population of belugas occupies southern Hudson Bay coastal waters with concentrations at the estuaries of the Severn and Winisk Rivers (Richard 1993). Genetics reveal limited mixing between the Western Hudson Bay belugas and the James Bay belugas but the relationships are still unclear. Limited mixing also exists between the James Bay stock and the Eastern Hudson Bay population (de March 2001).

CHAPTER II: BELUGA WHALE (*Delphinapterus Leucas*)
HABITAT USE IN THE NELSON RIVER ESTUARY DURING
WET AND DRY SUMMERS

II.1 ABSTRACT

Beluga whale (*Delphinapterus Leucas*) (Pallas 1776) location-habitat associations were studied using radio-tracking data (N=14) for 2002–2005 and 24 aerial surveys for 2003 and 2005 in the Nelson River Estuary, Hudson Bay. The years of 2002–04 were dry in the Nelson River watershed relative to 2005. Observed beluga-habitat distributions were compared to random distributions, using a Kolmogorov-Smirnov (K-S) statistic. A series of General Linear Models (GLM) found associations for three dependent distance measures. Results from the radio-telemetry data show belugas farther from the river mouth and channel during the wet year but not farther from the nearest shore. The aerial survey data provide confirmatory evidence of an association between beluga density and distance to river-mouth and year. A cumulative sign test determined the timing of a beluga shift in movement behaviour on August 10th. Pre-August 10th radio-tracking locations provided the boundary of the Nelson River estuary. Study results provide evidence to weigh the main estuary-use hypotheses and contribute to knowledge of beluga ecology and management.

II.2 INTRODUCTION

Beluga whales (*Delphinapterus Leucas*) (Pallas 1776) are highly mobile and well adapted to the Arctic. Most beluga populations in seasonally ice-free zones migrate long distances to estuaries during summer and then to offshore regions again in fall and winter. It is not known precisely why belugas use estuaries. The beluga estuary-use hypotheses may not be mutually exclusive, and may vary geographically, and across populations. Philopatry to certain sites of summer aggregation increases the belugas sensitivity to environmental changes, where climate change is predicted to influence Arctic ecosystems disproportionately, increasing river outflows, and causing more erratic weather patterns (Hinzman 1992; Tynan 1997; Fyfe 1999; Peterson *et al.* 2003).

I studied beluga location-habitat associations for the Nelson River estuary during the dry years of 2002–2004 relative to 2005 (figure II.1). Beluga locations were derived from ARGOS[®] satellite-telemetry data (N=14) for 2002–2005 and from 24 aerial surveys flown during 2003 and 2005. I hypothesize (H1) that beluga-habitat associations would differ when comparing wet and dry years. Model variables include distance to the mouth of the river, distance to shore, distance to channel, tide, year, and day-of-year, time of day, sex and age. Kolmogorov-Smirnov tests determine whether habitat use was different from random.

The Nelson River has artificially altered water flow due to an upstream hydroelectric dam. Much research describes the negative affects of hydroelectric development on downstream wildlife (Stanley and Warne 1993; Leichenko and Wescoat 1993; Fradkin 1996 in Kowalewski *et al.* 2000; COSEWIC 2004). Concerning

anthropogenic effects, understanding beluga estuary-use contributes to the management of the species.

Figure II.1; Limestone Dam mean daily discharge for the study years of 2002–2004, and 2005, a wetter than average year from 14 July to 31 August, the period of primary habitation of the estuary by beluga whales.

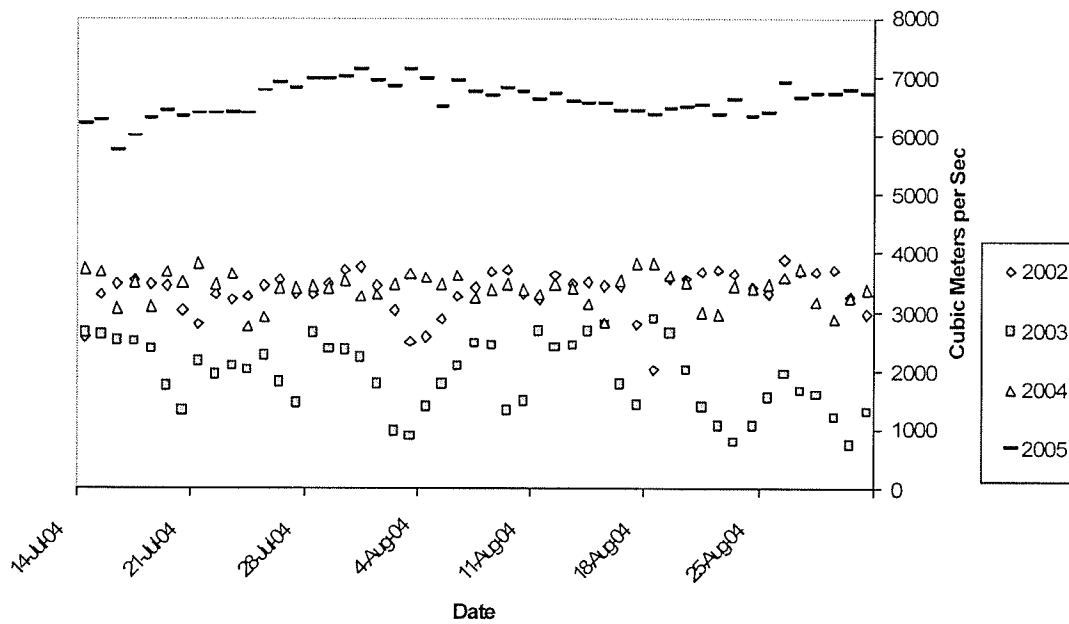

II.3 METHODS

II.3.1 Tagging and Satellite Telemetry

Fifteen beluga whales were live-captured near the mouth of the Nelson River (Figure II.1) and instrumented with ARGOS[®] satellite-linked radio tags (table II.1). This sample consists of nine adult males, five adult females, and one sub-adult male. Capture methods consisted of a nylon net¹ set in a circular purse formation from a 6-meter length jet boat. Netted whales were recovered immediately using two Zodiac[®] model MKIII boats measuring 4.3 meters. Following capture, the belugas were cleared from the net and restrained with a hoop net held around the head and a cushioned rope tied around the caudal peduncle. Time, location, morphometrics, sex, and associations with a calf were recorded (table II.2). All tags were fixed to the belugas by placing 1-centimetre stainless steel wires transversely on each side of the whale's dorsal ridge. Three 6-millimetre diameter nylon pins, inserted through the dorsal ridge, secured the wires. A nylon quick-application locking washer secured the nylon pins on the beluga. Capture handling times ranged from 20 minutes to 1.5 hours, averaging 30 minutes. Two of the 15 belugas were fitted with SPOT2 tags (see table II.2). These animals are not included in this study due to sampling differences compared to the ST16 and SPLASH dive-enabled tags. One SPOT2 tag (PTT=10971) did not provide any data.

¹ (50 meters × 3 meters, mesh size 32 centimetres, manufactured by Lakefish Net and Twine Ltd., Winnipeg, Manitoba)

Table II.1. Details regarding the 15 belugas captured and fitted with radio tags at the Nelson River estuary in the summers of 2002–2005.

| Capture location | Capture date | TAG NO. | Tag Type | Dive resolution (Meters) | Time | Last uplink | Duration (days) | Sex | Length (cm) | With calf |
|------------------|--------------|---------|----------|--------------------------|------|----------------|-----------------|-----|-------------|-----------|
| Marsh Point | 13/July/02 | 10927 | ST16 | 2 | 1644 | 3/August/02 | 21 | F | 320 | Yes |
| Marsh Point | 05/August/03 | 10899 | ST16 | 2 | 1250 | 26/October/03 | 83 | M | 370 | No |
| Marsh Point | 04/August/03 | 10970 | SPOT2 | N/A | 1650 | 28/November/03 | 117 | M | 334 | No |
| Marsh Point | 04/August/03 | 10926 | ST16 | 2 | 1528 | 23/November/03 | 112 | F | 375 | Yes |
| Marsh Point | 03/August/03 | 10972 | ST16 | 2 | 1315 | 27/November/03 | 117 | F | 344 | Yes |
| Marsh Point | 30/July/03 | 10971 | ST16 | 2 | 1010 | 14/November/03 | 107 | M | 405 | No |
| Marsh Point | 27/July/04 | 10971 | SPOT2 | N/A | 830 | 27/July/04 | 0 | F | 320 | No |
| Marsh Point | 27/July/04 | 40623 | ST16 | 1 | 1800 | 12/February/04 | 201 | M | 409 | No |
| Marsh Point | 26/July/04 | 40622 | ST16 | 1 | 1615 | 04/October/04 | 71 | F | 408 | Yes |
| Marsh Point | 25/July/04 | 10980 | ST16 | 2 | 1526 | 12/March/04 | 231 | F | 340 | Yes |
| Marsh Point | 24/July/04 | 10978 | ST16 | 2 | 1729 | 25/February/05 | 224 | M | 410 | No |
| Marsh Point | 24/July/04 | 10979 | ST16 | 2 | 1545 | 19/April/05 | 268 | M | 400 | No |
| North Side | 30/July/05 | 57600 | Splash | 1 | 1905 | 23/February/06 | 213 | M | 265 | No |
| North Side | 30/July/05 | 40153 | Splash | 1 | 1757 | 19/October/05 | 50 | M | 310 | No |
| Marsh Point | 23/July/05 | 10970 | Splash | 1 | 1210 | 7/October/05 | 37 | M | 330 | No |

Data sent from the radio-tracked belugas were received by National Oceanic & Atmosphere Administration (NOAA) polar orbiting weather satellites passing over the horizon. Sufficient message frequency and quality received throughout one satellite pass allows SERVICE ARGOS[®] (CLS) to calculate a location for the platform or “tag”. Often when the belugas are moving, surfacing intervals are shorter, resulting in lower quality locations. Once the messages from a tag are received by ARGOS[®], the message is assigned an accuracy symbol from the array (Z, B, A, 0, 1, 2 3). Z accuracy is the lowest and not suitable for most spatial analysis and 3 is the highest with near 150-meter

accuracy². The received ARGOS[®] satellite-tracking data for the 13 dive-recording tags were appended before being pre-processed³. Appending the two raw data formats temporarily creates redundant location messages but allows the SATPAK 2003⁴ data processing software to choose the best location solution from the duplicates.

Table II.2; Weekly sample sizes for Nelson River estuary beluga whale radio-tracking data by sampling week and year for 2002–2005

| Year | Week (Saturday – Friday) | Week number | Beluga sample size | Number of ARGOS [®] Locations in the Nelson River estuary |
|---------|--------------------------|-------------|--------------------|--|
| 2002 | July 14–July 20 | 1 | 1 | 53 |
| 2002 | July 21–July 27 | 2 | 1 | 43 |
| 2002 | July 28–August 3 | 3 | 1 | 58 |
| 2003 | July 28–August 3 | 3 | 1 | 16 |
| 2003 | August 4–10 | 4 | 4 | 75 |
| 2004 | July 13–July 19 | 1 | 1 | 1 |
| 2004 | July 27–August 2 | 3 | 5 | 29 |
| 2004 | August 3–9 | 4 | 5 | 66 |
| 2005 | July 14–July 20 | 1 | 1 | 6 |
| 2005 | July 21–July 27 | 2 | 1 | 50 |
| 2005 | July 28–August 3 | 3 | 3 | 176 |
| 2005 | August 4–August 10 | 4 | 3 | 110 |
| Totals: | – | – | 27 | 683 |

² See Service ARGOS[®] (CLS) (1989) for more ARGOS[®] satellite-based data-reception system details.

³ Data from ARGOS[®] Inc. was received in Compact Disc[©] format in ARGOS[®] raw data formats dispose (.ds) and diagnostic (.diag) and processed using Wildlife Computers SATPAK 2003 software

⁴ For details on SATPAK 2003 ARGOS[®] data-processing software, see SATPAK 2003 Users Guide (2003).

II.3.1.1.1 Testing ARGOS[®] Data Filters for Nelson River Beluga Radio-tracking

Applications

Studies utilizing radio-tracking data to locate marine mammals often attempt to augment existing data through various methods, including retaining less accurate data (McConnell *et al.* 1992, Austin *et al.* 2001). Similar methods were tested on the Nelson River beluga radio-tracking data for this study. Attempts were made to appropriately best-fit the gathered telemetry data with due attention to the influence of outliers. To maximize sample size, for the 13 deployments, the location data were further filtered.

First, a velocity filter (McConnell *et al.* 1992) that leaves plausible locations and includes less accurate locations that fall within the velocity threshold and a revised three-stage filter for erroneous ARGOS[®] locations (Austin *et al.* 2001). The three-stage filter, proposed by Austin *et al.* (2001) incorporates the McConnell filter, while using a five-location group to test, flag, and filter erroneous locations. This filter also includes less accurate ARGOS[®] location data that pass the multi-stage tests of the filter. Results of the filter for two test animals added approximately 12 percent more locations (figure II.2). However, the required choices of velocity and realized-distance parameters may add more uncertainty into the model, due to their relatively arbitrary assignment. Moreover, using the filter, most standard locations were retained, but the bulk of the low accuracy locations were also retained. This is concerning, since it reveals an underlying random selection element that may actually add uncertainty to our model. In the end, sample sizes for this study were sufficient for use in a General Linear Model, without including lower location classes that passed the filters. Thus, the additional records from the filter were not used. See the Appendix section V.1 of this thesis for a description of the results of the

3-stage filter. In addition, velocity thresholds (in this case 2.2 m/s) are arbitrary and likely not high enough for ARGOS[®] location messages (termed “uplinks”) that are close in time (less than 60 minutes).

A difference in logic also exists when comparing Austin *et al.* (2001) to McConnell (1992). The Austin *et al.* (2001) logic selects five locations and calculates the root mean square, whereas the original McConnell (1992) filter used the square root of the sum. If the mean velocity (in meters/second) is over threshold then it flags the middle location for removal. The “correct” went through the numbers after modifying Austin's filter to the "correct" version of the McConnell filter allows less data to pass the filter (A. Lewis unpubl. data 2007). Austin's method allows more data to pass through

In the end, results of 3-stage filter were discounted and the original subset of guaranteed-only⁵ ARGOS[®] uplink messages provided the four-year estuary sample size of 618 locations (Table II.1).

II.3.2 Aerial Surveys

Aerial surveys (N=24) were conducted in the Nelson River estuary during the summers of 2003 and 2005. Surveys dates ranged from July 29th to August 13th (Bernhardt 2004). Eighteen of the 24 aerial surveys coincided with radio-tag deployments for the summers of 2003 and 2005 (table II.2). The surveys included the Nelson River from Port Nelson to 40 km offshore, including regions influenced by altered flow from the Nelson River. Strip-transect surveys were conducted at an altitude of 305 meters

⁵Guaranteed-only ARGOS[®] uplink messages have a location accuracy index of 1, 2, or 3

using a Cessna 337 Skymaster airplane (Bernhardt 2004). The ten repeated transects were perpendicular to shore and 3.7 km apart to account for possible repeat-counts of belugas swimming across the transects, similar to methods developed by Eberhardt (1978). Pre-determined global positioning system (GPS) routes were followed to ensure consistency across surveys. Surveys at high tide originated near-shore and progressed offshore (Bernhardt 2004). Six of the dates had high tide surveys flown for both years (Table II.2)

Table II.3; Aerial Surveys for beluga whales (*Delphinapterus Leucas*) conducted in the Nelson River Estuary for the summers of 2003 to 2005 and included in General Linear Model

| Years | Survey Date | Julian Date | 2005 | 2003 |
|------------|-------------|-------------|------------------|------------------|
| 2003, 2005 | 27-July | 207 | Not surveyed | High tide survey |
| 2003, 2005 | 28-July | 208 | Not surveyed | High tide survey |
| 2003, 2005 | 29-July | 209 | Not surveyed | High tide survey |
| 2003, 2005 | 30-July | 210 | High tide survey | Not surveyed |
| 2003, 2005 | 31-July | 211 | High tide survey | Not surveyed |
| 2003, 2005 | 1-August | 212 | High tide survey | High tide survey |
| 2003, 2005 | 2-August | 213 | High tide survey | High tide survey |
| 2003, 2005 | 3-August | 214 | High tide survey | High tide survey |
| 2003, 2005 | 4-August | 215 | High tide survey | Not surveyed |
| 2003, 2005 | 5-August | 216 | Not surveyed | High tide survey |
| 2003, 2005 | 6-August | 217 | High tide survey | High tide survey |
| 2003, 2005 | 7-August | 218 | Not surveyed | High tide survey |
| 2003, 2005 | 8-August | 219 | High tide survey | High tide survey |
| 2003, 2005 | 9-August | 220 | Not surveyed | High tide survey |
| 2003, 2005 | 10-August | 221 | Not surveyed | Not surveyed |
| 2003, 2005 | 11-August | 222 | High tide survey | Not surveyed |
| 2003, 2005 | 12-August | 223 | High tide survey | High tide survey |
| 2003, 2005 | 13-August | 224 | Not surveyed | High tide survey |
| 2003, 2005 | 14-August | 225 | High tide survey | Not surveyed |
| Total | | 24 Days | 11 Surveys | 13 Surveys |

* bordered records indicate surveys flown for both years

II.3.3 Statistical and Spatial Analyses

All statistical analyses are from SAS[®] for Windows Version 8.02, Analyze-it for Excel[®], and the Saint Johns University Physics Lab online K-S test⁶.

⁶ The online K-S test is available at http://www.physics.csbsju.edu/stats/KS-test.n.plot_form.html

II. 3.3.3 Delineating the Estuary

The Nelson River estuary boundary was delineated using the beluga radio-tracking data for 2002–2005. Any locations that fell within the study area were compared to various physiographic, temporal, and physiological variables. Aerial survey data for the same defined estuary and period were also examined for relationships to the variables. A distribution-free cumulative sign test (Hodges 1955) was used to determine the timing of the beluga behavioural shift from estuary to migratory movements. The sign function (also referred to as the Signum function or Heaviside step function) is a discontinuous function whose value is zero for negative argument and one for positive argument. It extracts the sign of a real number. It is not reliant on the initial value for $H(0)$ since H is used as a distribution. Theoretically, the value of the sign reaches an apex(s)⁷ (figure II.1). The maximum sign test value⁸ occurred on August 10th⁹ therefore all locations before August 10th were included as estuary data. Estuary-use location frequencies for the 13 study belugas are displayed in figure II.2. D

⁷ The distribution-free cumulative sign test was preformed using Analyze-it® for Microsoft® Excel® for Windows© 2006

⁸ Values for the distribution-free cumulative sign test were derived using the geographic mean of daily median distances to the Nelson River mouth by animal.

⁹ 10 August for non-leap years but 9 August for leap years, including 2004, a sampled year.

Figure II.2; Nelson River beluga estuary-use defined using a distribution free cumulative sign value by mean of pooled day-of-year of daily median 'distance to river-mouth' by animal indicating the cut-off date for estuary-use locations on Julian day = 221, which corresponds to August 10th for non-leap years.

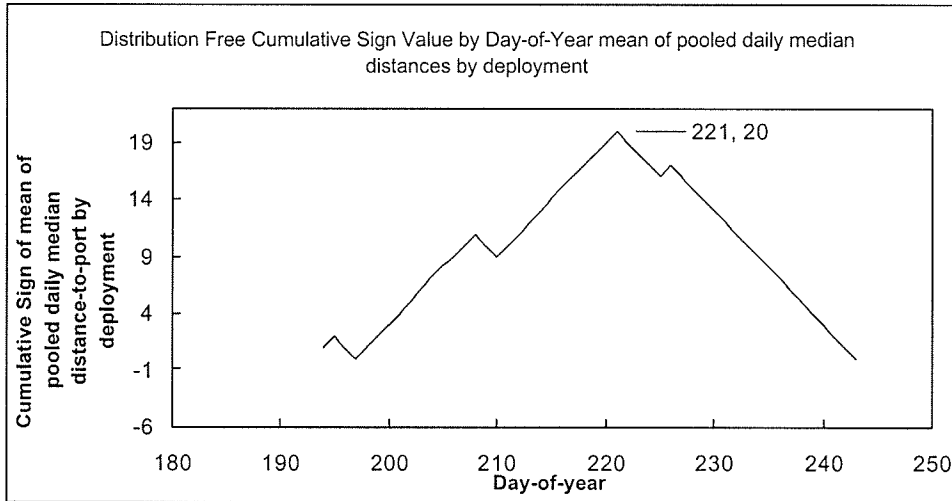

The highest frequencies of guaranteed-only (location class = 1, 2, 3) ARGOS[®] uplinks for all tagged belugas were observed with the single beluga tagged in 2002. Belugas tagged during 2005 also gave numerous uplinks, relative to 2003–2004. See Figure III.2 for details.

Figure II.3; Nelson River beluga estuary-use: Frequency of higher accuracy (ARGOS[®] location class = 1, 2, 3) estuary locations for each of the dive-enabled tags (N=13) deployed on study animals (numbered by animal (deploy id))

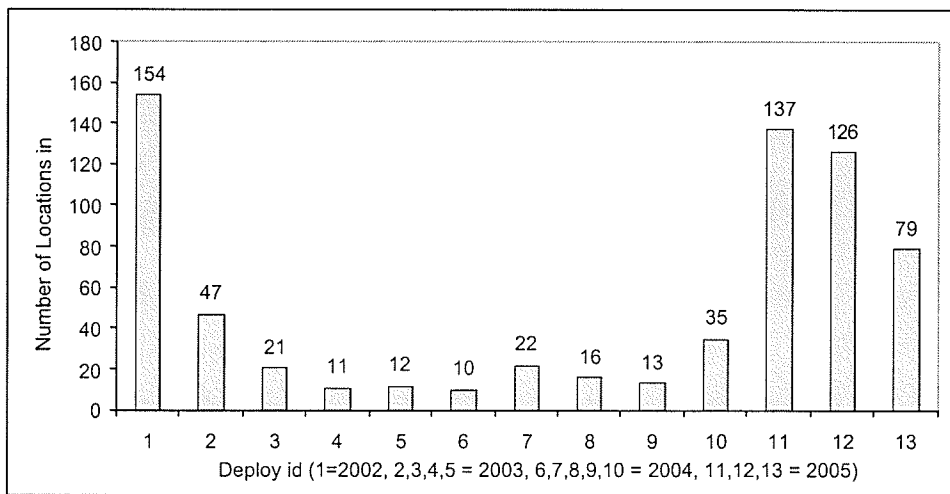

II.3.3.1 Observed vs. random distribution

Observed location-habitat correspondence distributions were compared to random location-habitat distributions for both the radio-tracking and aerial survey data using Kolmogorov-Smirnov (K-S) statistics. The K-S test is a suitable metric and first test for contrasting two cumulative frequency distributions and has been applied to similar studies (Sokal and Rohlf 1981; Barber *et al.* 2000; Ferguson and Elkie 2005). An attractive feature of the Kolmogorov-Smirnov (K-S) statistic test is that the distribution of the K-S test statistic itself does not depend on the underlying cumulative distribution function being tested.

II.3.3.1.1 Observed vs. Random Kolmogorov-Smirnov tests; Telemetry

A random sample equal in geographic extent (the defined estuary) and size to the observed radio-tracking beluga estuary locations (N=618) was created to test the hypothesis (H1) that beluga locations in the Nelson River are not randomly distributed. The corresponding random sample allows the examination of expected habitat relationships against randomness. Cumulative frequency histograms, considered continuous variables, were generated for both observed and random-generated samples including distances to various habitat features (Barber *et al.* 2000). 'Distance to river-mouth' and 'distance to nearest shore' were calculated for each 'real' telemetry location as well as for each of the random locations. Two Kolmogorov-Smirnov tests were used, one for each comparison of distance to the habitat feature. Distance to channel is not included in this test due to lack of suitable bathymetry data for the same areas used by the radio-tracked belugas.

II.3.3.1.2 Observed vs. Random K-S tests; Aerial Surveys

Methods to test for randomness differed slightly for the aerial surveys compared to the telemetry data. Each surveyed year, 2003 and 2005, was processed separately. Mean densities of belugas per 1 km² for all surveys within each year were calculated. Random densities were calculated by “shuffling the cards”, retaining the observed densities but randomizing them spatially within the survey transects extent. ‘Distance to river-mouth’, ‘distance to nearest shore’ and ‘distance to channel’ were calculated for the centroid location of each 1 km² cell and then weighted by the observed density for that cell. The same procedure was used for the random densities. The resulting ‘distance to habitat features weighted by observed densities’ were compared to the ‘distance to habitat features weighted by random densities’ using six Kolmogorov-Smirnov tests, one for each of the three weighted distance measures, for each surveyed year.

II.3.3.2 Environmental Measures

Environmental measures that may explain the patterns in locations of beluga included 1) distance to the mouth of the Nelson River¹⁰, 2) distance to the nearest shore 3) distance from the nearest channel¹¹, 4) water depth⁷, and 5) hourly tide level¹². Beluga

¹⁰ Selected from the Manitoba Geographic Names Program (MGNP) 2001

¹¹ Extracted from 2005 Manitoba Hydro bathymetry data

¹² Hourly tides were extracted from WXTIDE32.exe version 4.0 tide prediction software

information included age/sex category (adult male, female with calf, and juvenile).

Temporal variables included 1) year, 2) Julian day, and 3) time of day¹³.

Daily median 'distance to river-mouth', and daily median 'distance to shore' values were calculated for each deployment and then pooled across years for each day-of-year, using the Avenue[®] extension Nearest Features Version 3.8a (2004). By considering all years by same day-of-year values, the resultant estuary study region encompasses relevant data from all four sampling years. A Geographic Information System (GIS) from ESRI[®] analyzed the ARGOS[®] telemetry spatial data¹⁴.

II.3.3.4 Aerial Surveys

Spatial measures compared to the aerial surveys were 1) distance to river-mouth¹⁵, 2) distance to shore¹⁶, and 3) distance to channel¹⁷. Temporal variables included year and Julian day. Tide level is not included in the aerial survey analysis, as all surveys in this

¹³ Time of Day was calculated as day quartiles, with the four parts around daily sunset, sunrise, transit, and midnight times and splitting them. For example, for sunrise 330 am, day-quartile 1 starts at 330 am and lasts 6 hours until the midday quartile starts at 930 am.

¹⁴ ESRI[®] (Environmental Science Research Institute) software included ESRI[®] ArcView © version 3.3 and ESRI[®] ArcGIS © 8.3 (Copyright 1999–2002 ESRI[®] Inc., Redlands, California)

¹⁵ Distance from the mouth of the Nelson River was extracted from Manitoba Geographical Names Toponymic Data Layer (<http://www.gov.mb.ca/ia/capreg/metadata.html>)

¹⁶ Distance to shore refers to the distance for each aerial survey count centroid to the nearest shoreline

¹⁷ Water depth was extracted from GEBCO and SRTM 90m elevation

analysis occurred around high tide. Age and sex class are also not included in this analysis, as they are not available from the aerial surveys.

Beluga abundance densities were calculated for the entire study area from survey counts (every 15 seconds). The weighted total area per 1km^2 for each transect was then calculated, and weighted density estimates for each 15-second interval were calculated by dividing the number of whales observed per 15-second interval by the area sampled during that interval (Bernhardt 2004). Then, all surveys for each year (2003 and 2005) were combined and mapped in a GIS. Next, distance measures for each observed group of belugas were calculated in the GIS, including daily median 'distance to river-mouth' and daily median 'distance to shore'.

II.4.1 Caveats and Assumptions

Here we assume that a beluga location at time $t+1$ is dependent on the location at time t , within a day. Between days, negligible temporal autocorrelation is assumed since belugas are able to change location sufficiently to consider median daily locations independent. Using a conservative mean travel rate of 1 m/s, a beluga can travel 84.6 km in a day. Since the Nelson River estuary measures approximately 60 km offshore by 75 km on each side of the Nelson River, it is assumed that an adult beluga could enter or exit the estuary between days. The Kolmogorov-Smirnov (K-S) test only applies to continuous distributions (which these are). The K-S test also tends to be more sensitive near the center of the distribution than at the tails. The basic statistical assumption underlying the least-squares (LS) approach to the general linear model (GLM) is that the

observed values of each dependent variable can be written as the sum of two parts: a fixed component, β which is a linear function of the independent coefficients, and a random noise, or error, component e :

II.4.1.1 Potential for Individual Variability

Studies of this species at higher latitudes have demonstrated that there is relatively little behavioural variation between belugas in a particular population (Martin *et al.* 1998; Martin and Smith 1999). This evidence is relevant concerning statements made about the life history of Western Hudson Bay belugas, based on our relatively small sample size but Martin and Smith (1999) may be drawing premature conclusions since their analyses were also based on radio-tracking and aerial survey data.

II.4 RESULTS

II.4.1 HABITAT SELECTION

Considering the four sample years, August 10th marked the change from estuarine occupation behaviour to more migratory-like behaviour. Within this estuarial period, and resultant physical region, the belugas responded to the change in inter-annual water levels. During 2005, a wet year, the central location of the belugas was approximately 12 km farther away from the Nelson River entrance, compared to the drier years of 2002–2004. Beluga movements along the coast within or outside the defined estuary however, revealed no difference related to a change in water level.

II.4.1.1 Telemetry

II.4.1.1.1 Kolmogorov-Smirnov (K-S) Test Results of the Distance Measures

Beluga-habitat associations based on the radio-tracking data for 2002–2005 were not random because results for the two Kolmogorov-Smirnov tests for distance to river-mouth ($D=0.2184$, $P=0.000$) and distance to nearest shore ($D=0.1893$, $P=0.000$) features rejected (H_0) that the two distributions are from the same parent distribution, at the 99th percentile confidence level (table II.3). Habitat selection for the 14 radio-tracked belugas was significantly different from random.

Table II.4; Nelson River estuary telemetry data (2002–2005): Kolmogorov-Smirnov (K-S) test results; Log probability plot of observed vs. random locations measuring ‘distance to river-mouth’

| K-S tests for observed vs. random locations (n=618) for distance to habitat feature | | |
|--|----------|----------|
| | <i>D</i> | <i>P</i> |
| Distance to river-mouth (km) | 0.2184 | 0.000* |
| Distance to nearest shore (km) | 0.1893 | 0.000* |

* Reject H_0 that the two distributions are from the same parent distribution

Figure II.4; Nelson River estuary telemetry data (2002–2005): Kolmogorov-Smirnov test (KS-test) results; Log probability plot of observed vs. random locations measuring ‘distance to river-mouth’

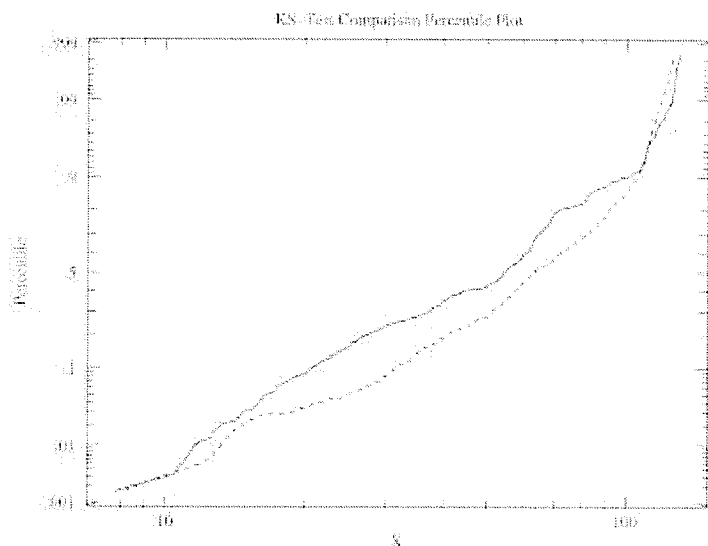

Note: the solid line represents the observed data and the dash line is the random data

Figure II.5; Nelson River estuary telemetry data (2002–2005): Kolmogorov-Smirnov test (KS-test) results; Log probability plot of observed vs. random locations measuring 'distance to nearest shore'

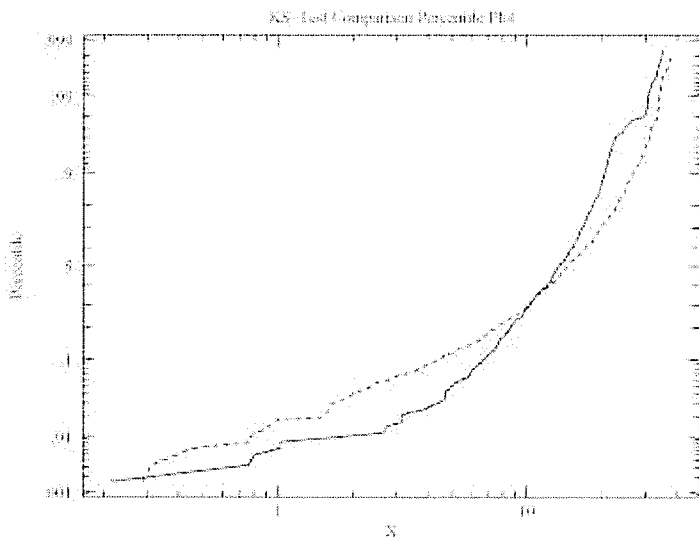

Note: the solid line represents the observed data and the dash line is the random data

Figure II.6: Nelson River estuary study with beluga locations (N=13, Number of beluga locations = 618) using a bounding polygon for locations before Aug 10th (Aug 9th for 2004, a leap year)

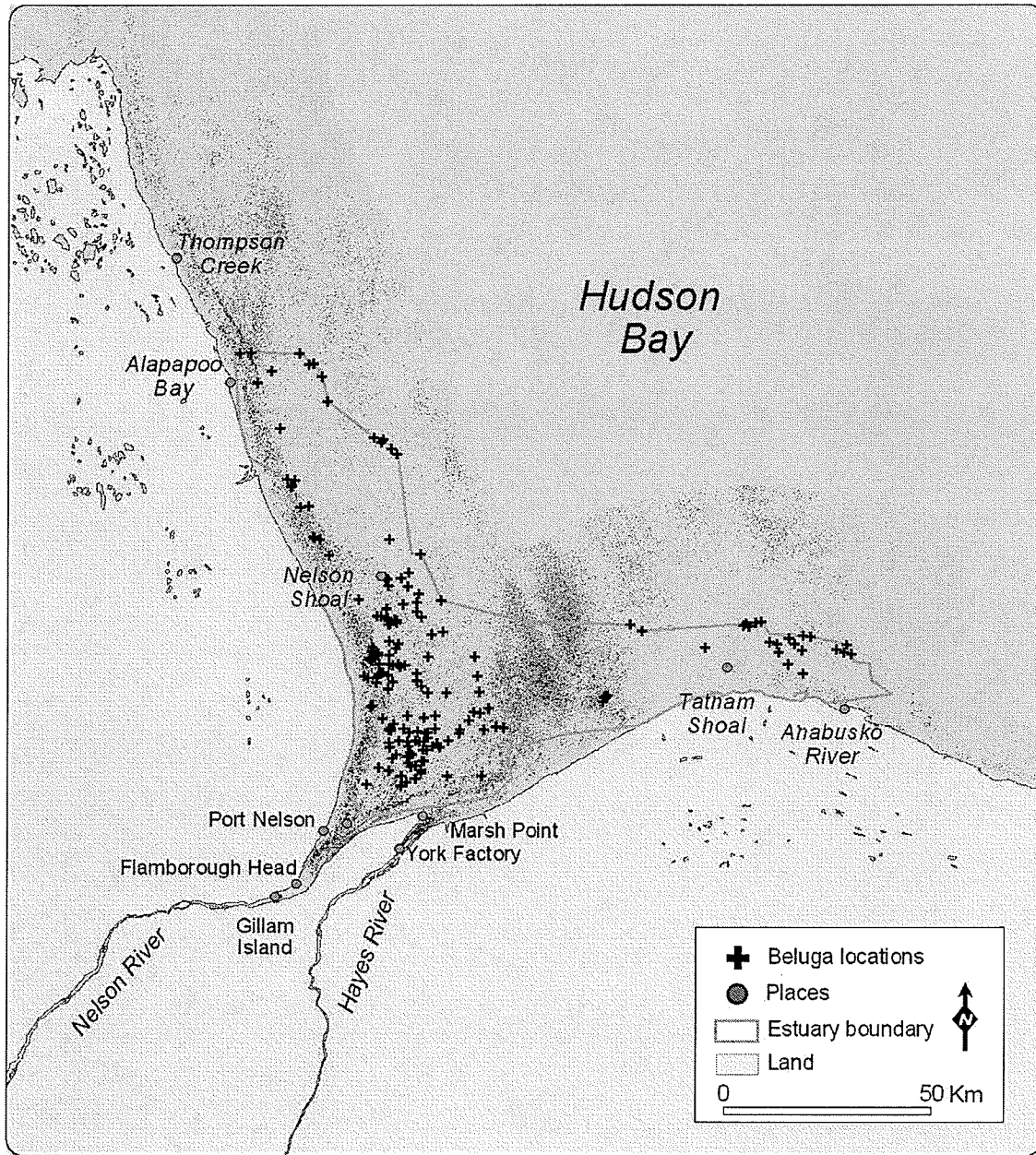

II.4.1.1.2 The Shape of the Estuary

The study area, as delineated by the radio-tracking data, measures approximately 5185 km² including roughly 150 km of the south eastern Hudson Bay shoreline and extending approximately 60 km offshore from the entrance to the Nelson River (figure II.6). Belugas used the estuarine study area through September 9th, although results of the sign test show an overall change in beluga movement behaviour starting on August 10th. Locations prior to August 10th include approximately four weeks of data for each of the three years of 2003–2005. However, 2002 data is for only three weeks before August 10th and only by one whale. Week 2 (21 July–27 July) and week 3 (28 July–3 Aug) are best represented by number of beluga locations within the estuary. Inter-annual capture-date variability caused low location frequency in the estuary for week 1 (14 July–20 July) because some belugas were not captured until after week 1 (Table II.2). None of the tagged belugas were recorded again in the direct vicinity of the captures. This evidence is contrary to observations of other belugas in the Nelson River estuary (and possibly other estuaries having belugas) based on *in situ* observations.

II.4.1.1.3 Radio-Telemetry Tagging: A Summary of the First Two Weeks

The initial movements of eight of the tagged whales out of the estuary for an initial period of 4–8 days may be due to the disturbance of capturing them. Tagged belugas had only one or two visits per whale for the area near Port Nelson, on the north shore of the inner estuary. Beluga locations (N=14) for the first week after release show five whales moving north along the west coast of Hudson Bay for less than a week and

then returning to the estuary, 40–60 km offshore where large densities of belugas were observed by aerial surveys¹⁸ (Figure II.5) (Bernhardt 2004). Three tagged belugas moved east along the south shore of the estuary and then past the mouth of the Hayes River to midway to the Ontario border. The other six belugas moved into the outer estuary, 30–60 km offshore and showed no directed movements.

II.4.1.1.4 Beluga Movements Relative to Environment

Three General Linear Models (GLM) tested for relationships between dependent variables ‘distance to river-mouth’, ‘distance to shore’, and ‘distance to channel’, relative to six independent environmental variables. Year differences were observed in ‘distance to the river-mouth’ with 2005 having greater distances when compared to 2002–2004. GLM results also show a relationship between year and ‘distance to channel’. No significant relationship exists however, for year and ‘distance to shore’. A post hoc Tukey’s (HSD) Comparison of Means test was performed within each GLM. A detailed description of results follows.

II.4.1.1.5 Results of Statistics for ‘distance to river-mouth’

Year differences in ‘distance to the river-mouth’ are due to 2005 having greater distances than 2003 and 2004. However, all of the other included variables included in the GLM reveal a significant relationship to ‘distance to shore’ with the exception of time

¹⁸ Where N=14 belugas, this includes all Wildlife Computers Inc. ST16, Splash, and SPOT2 radio-transmitters

of day (expressed as day-quartile). These results need to be interpreted due to inter-correlations among variables confusing relevance to beluga ecology. As belugas move away from shore, depth presumably increases. Similarly, as tide changes, distance from shore changes as belugas move inshore. Higher water levels on a rising tide allow the belugas to travel closer to shore along the coast, where higher freshwater inflows are non-existent. Time of day also had minimal effect on the coastal movements¹⁹ of the belugas related to 'distance from shore'.

Table II.5; GLM Results for 2002–2005 Nelson River estuary beluga whale radio-tracking data, using the dependent variable, Distance to river-mouth (in km)

| Distance to river-mouth (In km) | | | | | |
|---------------------------------|--------------------------|-------------------------|------|-------|--|
| R-Square | Coefficient of Variation | Root Mean Squared Error | Mean | N=683 | |
| 0.744 | 40.5 | 23.2 | 57.3 | | |

| Class | DF | Type III SS | MS | F Value | Pr>F |
|------------------------|-----|-------------|----------|---------|--------|
| Year | 3 | 30068.1862 | 10022.73 | 18.65 | <.0001 |
| Julian day | 27 | 39593.615 | 1466.43 | 2.73 | <.0001 |
| Day quartile | 3 | 317.6735 | 105.8912 | 0.2 | 0.8984 |
| Tide level (in meters) | 234 | 226500.2189 | 967.9497 | 1.8 | <.0001 |
| Age/Sex | 2 | 34025.0649 | 17012.53 | 31.65 | <.0001 |
| Model | 298 | 592583.4592 | 1988.535 | 3.7 | <.0001 |
| Error | 379 | 203705.2881 | 537.481 | – | – |

Results for Tukey's HSD comparison of means for 'distance to river-mouth' also indicate a significant difference when comparing 2005 to 2002–2004, but not in comparisons among the years of 2002–2004.

¹⁹ Coastal movements refers to the movements of belugas while outside the mixing zone but still within the defined estuary limits, as tested using the distance to the nearest shoreline

Table II.6; Tukey's Studentized Range (HSD) test for 2002–2005 Nelson River estuary beluga whale radio-tracking data and dependent variable Distance to river-mouth (in km), where Alpha = .05, and table values are LS means

| Year | 2002 | 2003 | 2004 | 2005 |
|------|---------|---------|---------|---------|
| 2002 | – | 5.99 | 3.803 | 16.876* |
| 2003 | 1.921 | – | 6.686 | 20.047* |
| 2004 | 4.08 | 11.004 | – | 22.176* |
| 2005 | -5.259* | -5.929* | -8.119* | – |

* Denotes a significant difference in means

II.4.1.6 Results of Statistics for 'distance to shore'

Results of the General Linear Model (GLM) for 'distance to shore' do not differ among years (Table II.5). Both tide level and depth, however, reveal a significant relationship to the 'distance to shore' measures. When belugas move away from shore, depth generally increases, as is shown in the 2006 Manitoba Hydro bathymetry layer (figure I.4)²⁰. Similarly, as tide changes, distance from shore changes, as belugas move along the coast. Time of day also had minimal effect on distance from shore. The three distance measures, distance to the river-mouth, distance to the nearest shore, and distance to channel did not show a relationship with time of day. Implications of these relationships are expanded upon in section II.5 Discussion.

²⁰ The Nelson River estuary is generally very shallow and flat. Any analysis using depth is limited to SRTM 90m data and GEBCO bathymetry data, which show very limited increase in water depth with increased distance from shore. More accurate bathymetry data is now (2006) available from Manitoba Hydro but has limited extent.

Table II.7; GLM Results for 2002–2005 Nelson River estuary beluga whale radio-tracking data and the dependent variable, ‘distance to shore’ (in km)

| Distance to Shore (In km) | | | | | |
|---------------------------|----------------------|-------------------------|----------|-------|--|
| R-Square | Coefficient Variance | Root Mean Squared Error | Mean | N=683 | |
| 0.876357 | 20.00220 | 2.693501 | 13.46602 | | |

| Class | DF | SS | MS | F | Pr>F |
|------------------------|-----|-------------|-----------|------|---------|
| Year | 3 | 29.574812 | 9.858271 | 1.36 | 0.2550 |
| Julian day | 27 | 444.452932 | 16.461220 | 2.27 | 0.0004 |
| Day quartile | 3 | 14.152231 | 4.717410 | 0.65 | 0.5832 |
| Tide level (in meters) | 234 | 3435.135846 | 14.680068 | 2.02 | <. 0001 |
| Age/Sex | 2 | 32.233653 | 16.116827 | 2.22 | 0.1099 |
| Model | 298 | 19488.77086 | 65.39856 | 9.01 | <. 0001 |
| Error | 379 | 2749.62483 | 7.25495 | -- | -- |

Results of the Tukey’s HSD comparison of means test for ‘distance to shore’ do not provide a clear pattern of difference between the wet and dry years, however select years do differ significantly (table II.6)

Table II.8; Tukey’s Studentized Range (HSD) test for 2002–2005 Nelson River estuary beluga whale radio-tracking data and dependent variable Distance to shore (in km), where Alpha = 0.05, and table values are LS means

| Year | 2002 | 2003 | 2004 | 2005 |
|------|---------|---------|----------|----------|
| 2002 | – | 0.3153 | -2.0573* | -0.5968* |
| 2003 | 1.5227 | – | -1.3419* | 0.1521 |
| 2004 | 3.8890* | 3.3971* | – | 2.5181* |
| 2005 | 1.9465* | 1.4881 | 15.148* | – |

*Denotes a significant difference in means

Kernel Probability Density Estimation (PDE) utilization distributions for the wet year (2005) and the dry years (2002–2004) show a difference in geometric mean of median daily locations of belugas of 7.46 km farther from the Nelson River mouth. The distance separating the geometric means between wet and dry years is 14.3 km (see Figure II.7, legend for details). See the Appendix of this thesis section V. 2.1 ‘Kernel

Smith A.J. Beluga Whale (*Delphinapterus leucas*) Use of the Nelson River Estuary, Hudson Bay

Probability Density Estimation (PDE) Methods' for more details on the application of Kernel PDE methods to derive utilization distributions for these telemetry data.

Figure II.7; Nelson River beluga radio-tracking data utilization distributions based on Kernel PDE methods for the years of 2003–2004, and 2005.

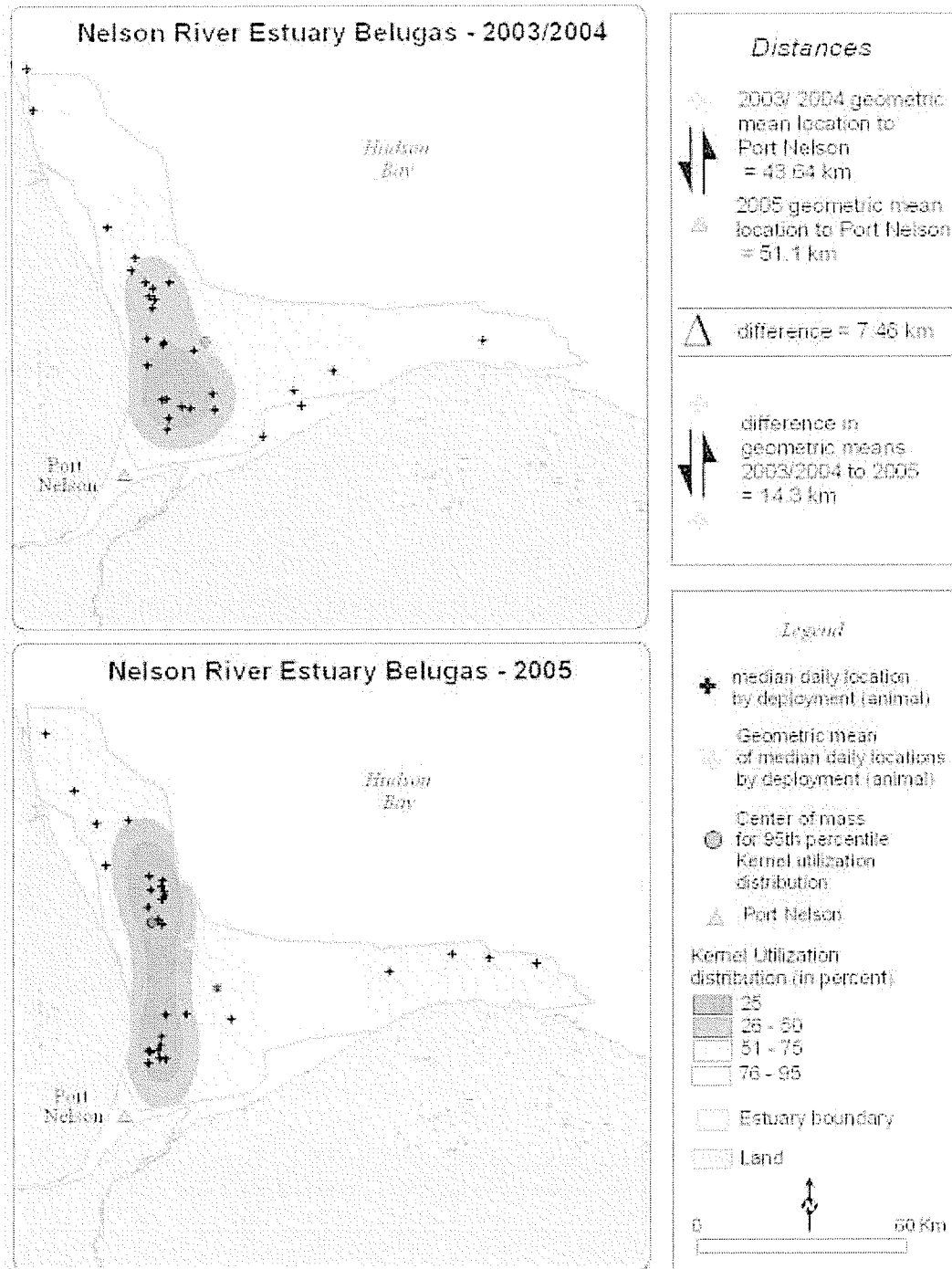

II.4.2 Aerial Surveys

II.4.2.1 Kolmogorov-Smirnov (K-S) test results of the Distance Measures

Aerial Surveys; 2003

Beluga habitat use for 2003 based on the aerial survey densities was likely not random because results for two of three Kolmogorov-Smirnov tests, distance to nearest shore ($D=0.0812$, $P=0.003$) and distance to channel ($D=0.0942$, $P=0.000$) rejected (H_0) that the two distributions are from the same parent distribution, at the 99th percentile confidence level (table II.9). K-S test results for distance to river-mouth ($D=0.0401$, $P=0.392$), however, did not reject (H_0). These results require interpretation as the highest densities for 2003 appear to be fairly constant in a direction straight out from the river mouth, following the channel closely. This closeness to random distribution however, is not observed for the 2005 survey densities.

Table II.9; Nelson River estuary aerial surveys 2003: Kolmogorov-Smirnov comparisons of distance to habitat features weighted by density: Probability plot of observed vs. random densities

| 2003 Aerial Surveys; K-S tests for observed vs. random densities (n=618) | | |
|--|----------|----------|
| for weighted distance to habitat feature | <i>D</i> | <i>P</i> |
| Distance to river-mouth (km) | 0.0401 | 0.392 |
| Distance to nearest shore (km) | 0.0812 | 0.003* |
| Distance to nearest channel (km) | 0.0942 | 0.000* |

* Reject H_0 that the two distributions are from the same parent distribution at the 99th percentile

Figure II.8; Nelson River aerial surveys 2003: Kolmogorov-Smirnov comparison distance to nearest shore weighted by observed density vs. distance to nearest shore weighted by random density probability curves

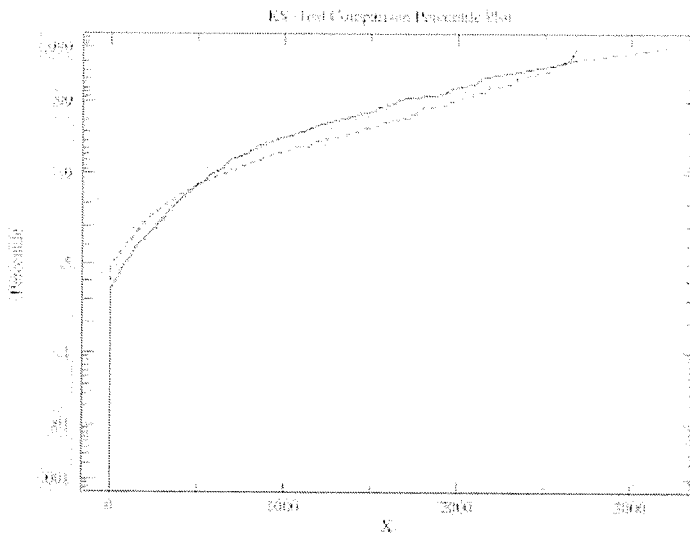

Note: the solid line represents the observed data and the dash line is the random data

Figure II.8; Nelson River aerial surveys 2003: Kolmogorov-Smirnov comparison distance to nearest shore weighted by observed density vs. distance to nearest shore weighted by random density probability curves

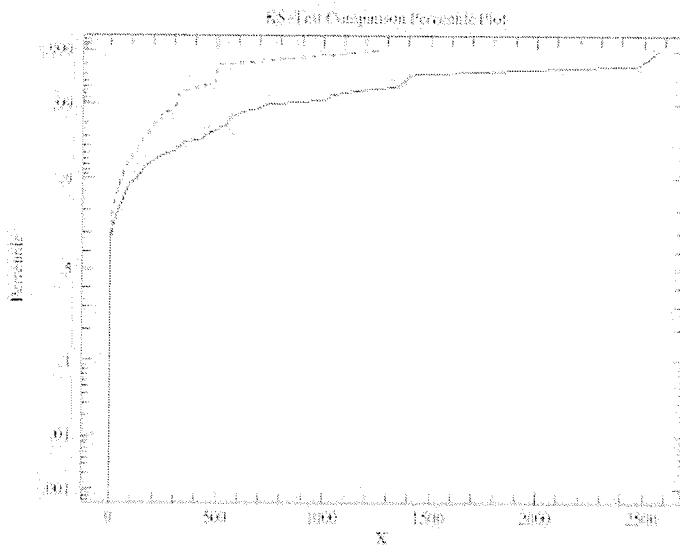

Note: the solid line represents the observed data and the dash line is the random data

Figure II.9; Nelson River aerial surveys 2003: Kolmogorov-Smirnov comparison distance to channel weighted by observed density vs. distance to channel weighted by random density probability curves

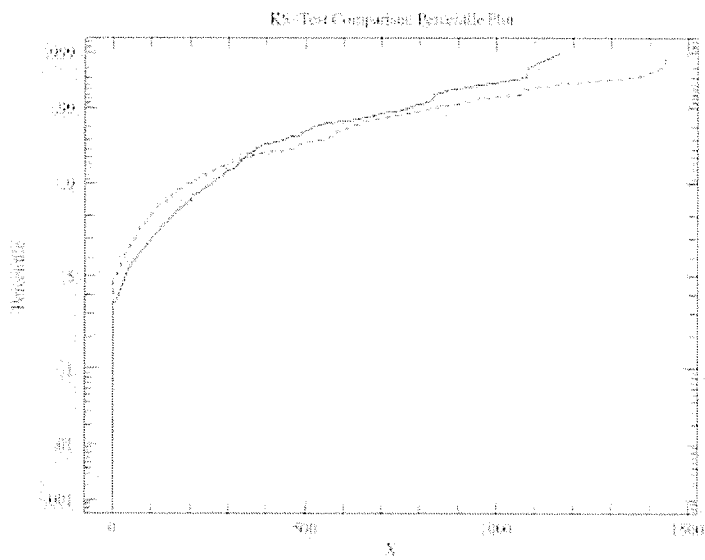

Note: the solid line represents the observed data and the dash line is the random data

Aerial Surveys; 2005

Beluga habitat use for 2005 based on the aerial survey densities was likely not random because results for two of three Kolmogorov-Smirnov tests, distance to river mouth ($D=0.1071$, $P=0.000$) and distance to nearest shore ($D=0.5696$, $P=0.000$) rejected (H_0) that the two distributions are from the same parent distribution, at the 99th percentile confidence level (table II.3). K-S test results for distance to channel ($D=0.0501$, $P=0.159$), however, did not reject (H_0).

Table II. 10; Nelson River estuary aerial surveys 2005: Kolmogorov-Smirnov comparisons of distance to habitat features weighted by density (random and observed)

| 2005 Aerial Surveys; K-S tests for observed vs. random densities (n=618) | | |
|--|----------|----------|
| for weighted distance to habitat feature | <i>D</i> | <i>P</i> |
| Distance to river-mouth (km) | 0.1071 | 0.000* |
| Distance to nearest shore (km) | 0.5696 | 0.000* |
| Distance to nearest channel (km) | 0.0501 | 0.159 |

* Reject H_0 that the two distributions are from the same parent distribution at the 99th percentile

Figure II.11; Nelson River aerial surveys 2005: Kolmogorov-Smirnov comparison distance to river-mouth weighted by observed density vs. distance to river-mouth weighted by random density probability curves

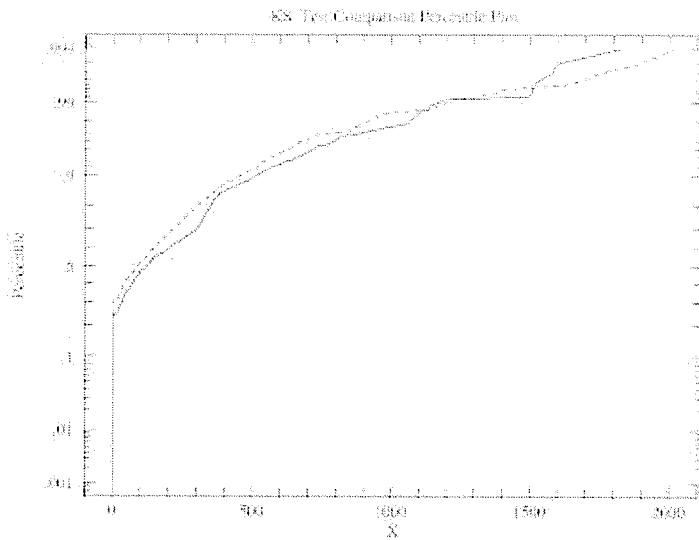

Note: the solid line represents the observed data and the dash line is the random data

Figure II.12; Nelson River aerial surveys 2005: Kolmogorov-Smirnov comparison distance to nearest shore weighted by observed density vs. distance to nearest shore weighted by random density probability curves

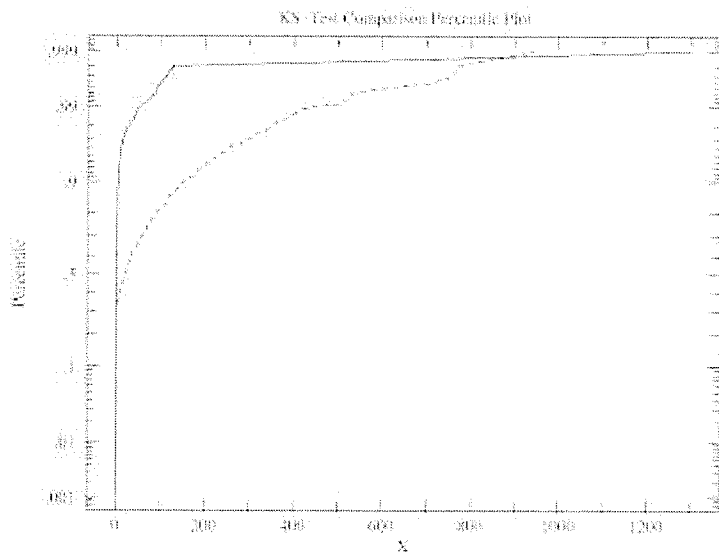

Note: the solid line represents the observed data and the dash line is the random data

Figure II.13; Nelson River aerial surveys 2005: Kolmogorov-Smirnov comparison on distance to channel weighted by observed density vs. distance to channel weighted by random density probability curves

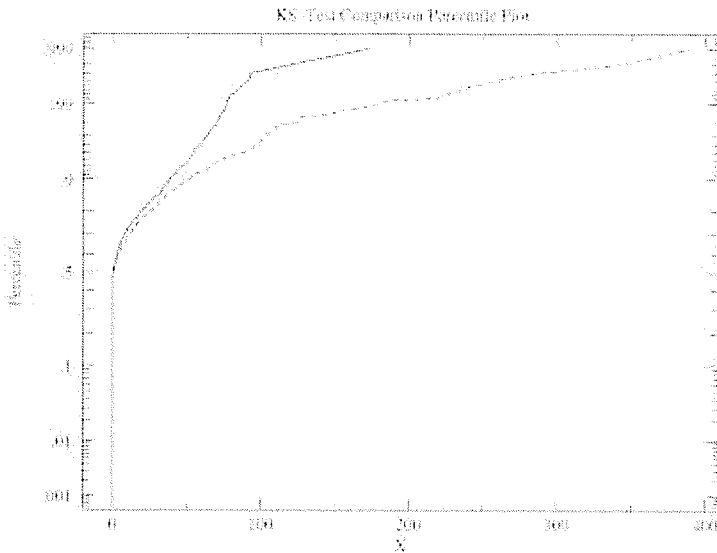

Note: the solid line represents the observed data and the dash line is the random data

Mapped beluga aerial survey densities (Figure II.4) are visually similar to the Kernel Probability Density Estimation (PDE) regions derived from the 2002–2005 telemetry data for the same extent within the estuary (figure II.7). The aerial survey densities show belugas remaining farther out in the estuary during the wet year of 2005 (Figure II.14; bottom pane) compared to the drier year of 2003 (Figure II.14; top pane). The size of the survey extent, and the large proportion of beluga telemetry data that fall beyond that extent limit any comparison between the aerial survey data and the telemetry data. Beluga-use densities for near-shore regions along the north shore of the estuary are higher for 2005. This may be due to increased availability of near-shore habitat, resulting from increased freshwater levels. Overall, it appears that more belugas used the Nelson River estuary in the area surveyed during 2005, based on the relative density surfaces created using the 2003, and 2005 survey counts of belugas, and personal communications

Figure II.14; Aerial survey beluga densities (in belugas per km²) for dry year (2003) and a wet year (2005) with inset of random densities generated for the K-S tests

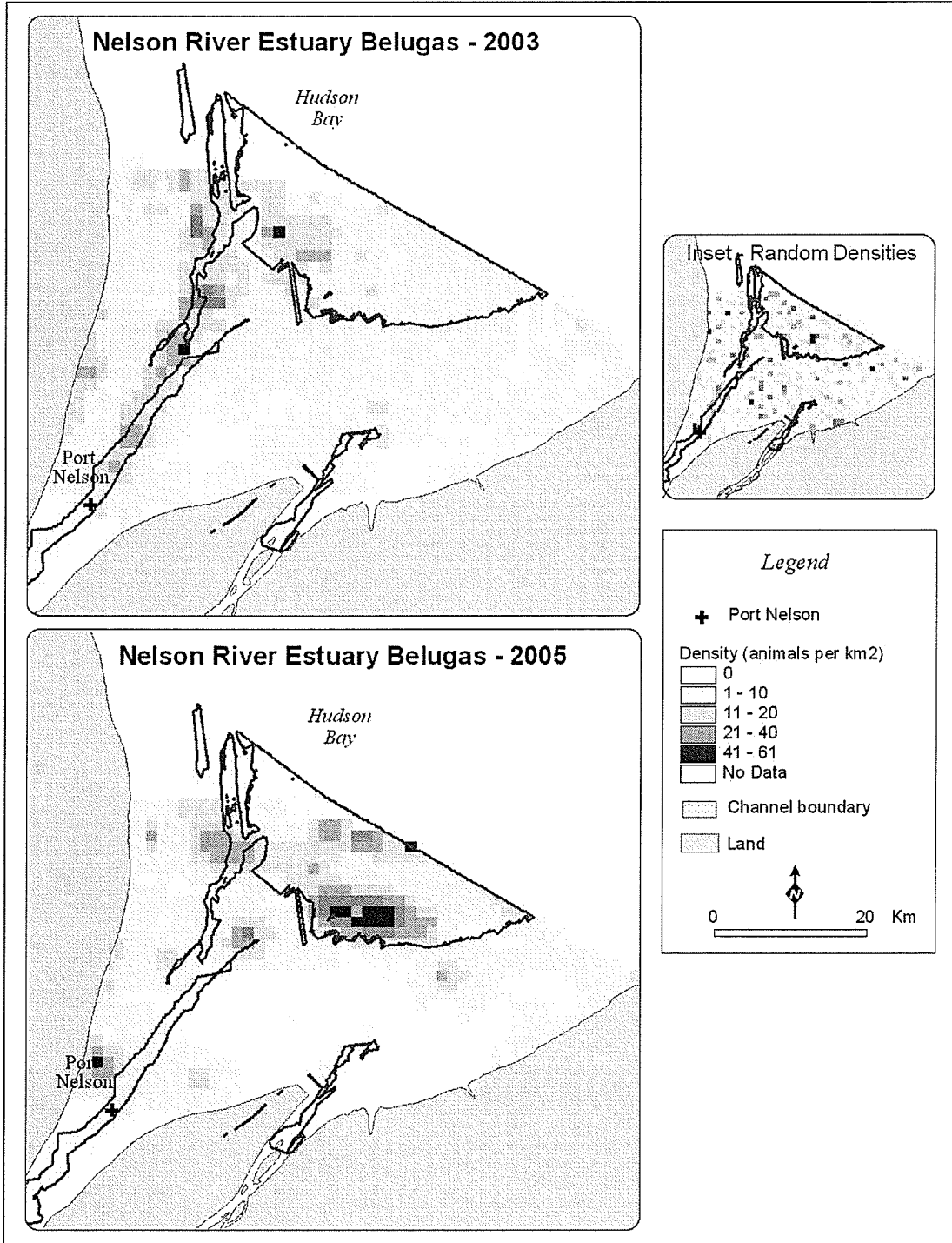

II.4.2.1 Aerial Survey Data Compared to Environment

The extent of the aerial survey data within the defined estuary had an area of 1307.3 km² extending approximately 66 km east of Port Nelson. This is approximately half of the study area defined by the radio-tracking data, which extended east approximately 132 km from Port Nelson, with an area of 5185.4 km².

The aerial survey data dependent variable was mean density of belugas per 1km². Results show a significant relationship for year and distance to river-mouth, similar results for the radio tracking data. 'Day of year' was also significant but 'distance to shore' was not. No 'distance to channel' comparison is made between the radio-telemetry and aerial survey data due to lack of accurate channel data (based on bathymetry) for the whole defined estuary (table II.11).

Table II.11; GLM Results for 2003 and 2005 Nelson River estuary beluga whale aerial survey counts and dependent variable, Density (in Belugas per km²)

| Survey density (in belugas per square kilometre) | | | | | |
|--|-------------------------|-------------------------|----------|---------|---------|
| R-Square | Coefficient of Variance | Root Mean Squared Error | Mean | | |
| 0.134588 | 122.2537 | 7.122229 | 5.825776 | | |
| Class | DF | Type III SS | MS | F Value | Pr>F |
| Year | 1 | 96.59 | 96.59 | 9.09 | 0.0026* |
| Day of Year | 16 | 20565.4 | 1285.3 | 3.31 | 0.0017* |
| Distance to Shore | 1 | 887.67 | 887.67 | 0.31 | 0.5804 |
| Distance to River-mouth | 1 | 26.18 | 26.18 | 4.14 | 0.0429* |
| Distance to Channel | 1 | 14843.6 | 14843.6 | 1.17 | 0.2799 |

*denotes significance at 95th percentile

Aerial survey count densities for the wetter year of 2005 reveal a stronger association with the channel during the dry year. The drier year of 2003 indicates a greater overall beluga-use of the inner estuary, including all habitats from approximately 0–23 km out into the estuary. At 23 km offshore, densities for both survey years are

equal. Beyond 23 km from the river-mouth, extending to the 66 km limit, higher densities exist for 2005. This inter-annual difference in beluga habitat-use within the estuary may be due to the increase in water levels. The wetter year of 2005 also revealed higher densities of belugas farther out (30–50 km) from Port Nelson (figure II.4) (W. Bernhardt, North South Environmental Consulting, Winnipeg, Manitoba, pers. comm. 2006). A linear regression shows differences in beluga densities when compared to distance from Port Nelson for the aerial surveyed years of 2003 and 2005. The log transformed polynomial quadratic equation had a higher R^2 value compared to the linear equation. Table II.12 lists the quadratic and linear equations for 'distance to river-mouth', compared to beluga whale densities for each of the two aerial surveyed years, 2003 and 2005.

Figure II.15; Log transformed linear regression for Nelson River estuary beluga aerial survey counts for the years of 2003 and 2005 in mean densities of belugas pre 1km^2 , compared to 'distance to river-mouth'.

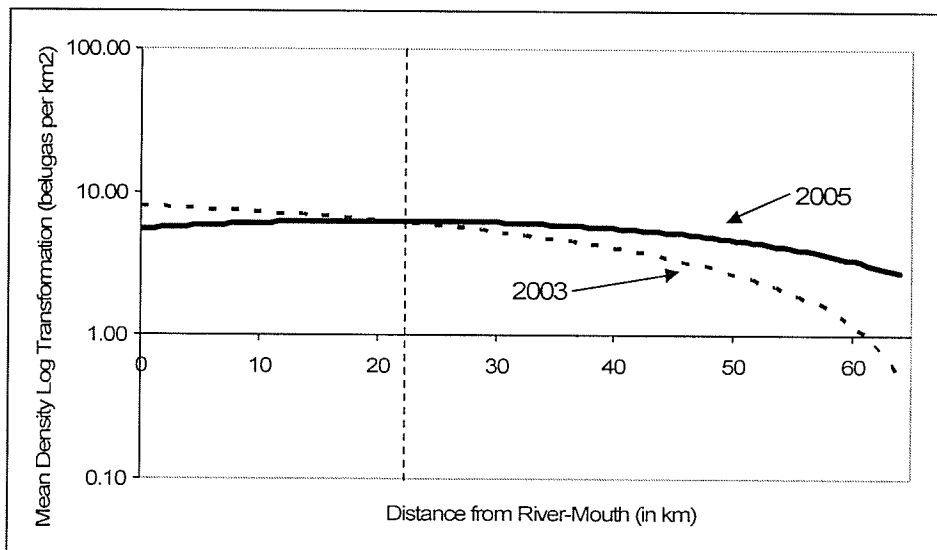

Table II.12; Aerial Surveys 'distance to river-mouth' vs. beluga whale density for the Nelson River estuary aerial surveys flown in the summers of 2003 and 2005, where * indicates the highest R² value

| Year | Equation Type | Linear Regression Equation | R ² |
|------|---------------|-------------------------------------|----------------|
| 2003 | Linear | $Y = -0.0434x + 6.8774$ | 0.0842 |
| 2003 | Polynomial | $Y = -0.002x^2 + 0.0823x + 5.5575$ | 0.1328* |
| 2005 | Linear | $Y = -0.119x + 8.7017$ | 0.4629 |
| 2005 | Polynomial | $Y = -0.0009x^2 - 0.0641x + 8.1252$ | 0.4697* |

II.5 DISCUSSION

Considering 2005 (wet year) and 2002–2004 (dry years), along with physiographic and temporal variables, the 13 sampled belugas were farther out in the estuary during 2005. Distance to shore, however reflects no significant relationship to year, suggesting that inter-annual changes in water levels do not affect beluga movements along the coast. Only when belugas reach the areas of fresh water inflow do they demonstrate a measured response by changing their behaviour.

The defined estuary study area is similar in shape, but larger than, the surficial freshwater plume and mixing zone of the Nelson River-Hudson Bay interface for two example LANDSAT images, including one from the dry year (10 Sept, 2004) and one from the wet year (13 July 2005) (figure II.16, figure II.17). There does appear to be more fresh water flow in the 2005 LANDSAT image although this observation is limited at best, considering the Hydrology of the Nelson River estuary is very complex and highly variable even within one tidal cycle (Mundy and Sydor 2006; Mundy *et al.* 2006; McCullough *et al.* 2006). For more details on the hydrology of the Nelson River estuary see http://www.arcticnet-ulaval.ca/pdf/ASMTalks/Mundy_Aziz.pdf (Mundy and Sydor 2006)

Figure II.16 LANDSAT image of the Nelson River Estuary for September 10th, 2004

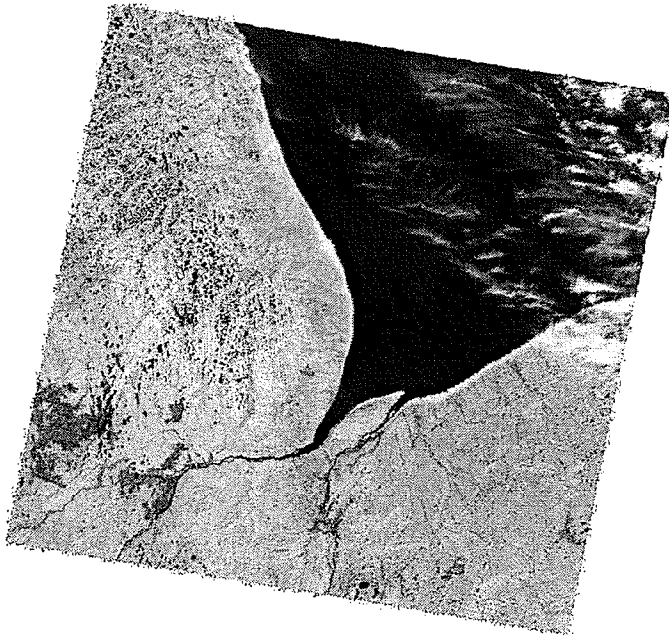

WIKI

Figure II.17 LANDSAT image of the Nelson River Estuary for July 13th, 2005

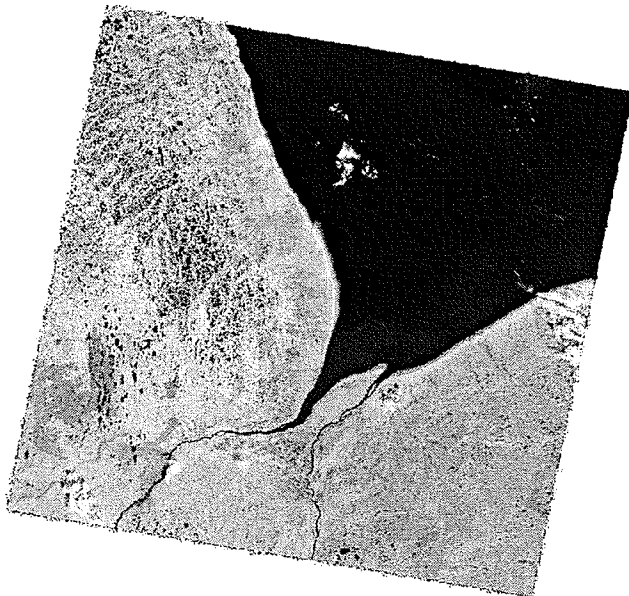

Image source: USGS

During drier years (2002–2004), the freshwater plume was, on average, closer to the river-mouth, as were the belugas. During wetter years (2005), the reverse is true. This suggests that the belugas preferred the fresh-saltwater mixing zones to the higher fresh-water levels by remaining farther offshore. Water level variations however, appear to have no effect on beluga movements up and down the coast while they are still within the designated estuary study region. The effect of change in water level appears to be isolated to regions located near the fresh-saltwater mixing zone. This suggests that the fresh water outflow from the Nelson River is influencing the locations of belugas here. A comparison of these findings is difficult because no research of this type exists for other beluga populations.

Concerns have been raised about the effects of industrial development, and in particular, the potential effects of hydroelectric dams on belugas, and the ecosystems they inhabit (Lawrence et al 1990; Sergeant 1975; Lawrence et al 1990; Gosselin 2002; COSEWIC 2004). Belugas in the St. Lawrence River now occupy a small part of their former range (Vladykov 1944; Reeves and Mitchell 1984). Previously, there were possibly two populations of belugas there, one centered on the Saguenay River and the other on the Manicouagan River (Vladykov 1944; Sergeant 1975; Kingsley 2002). The Manicouagan River population was hunted heavily (Laurin 1982) and the damming of the river could have resulted in the disappearance of this population (Sergeant 1975; COSEWIC 2004). Conversely, Sergeant (1975) also speculated that reduced flow of the Churchill River from Hydroelectric development would reduce the population of belugas using the Churchill River estuary. There is no evidence to support this claim, and the population size of belugas using the Churchill River estuary appears to be stable. The

uncorrected estimate of belugas in the Churchill-Seal and Nelson areas (27,200) in 2004 is similar to the number (25,100) estimated in 1987, suggesting that this population has not experienced a detectable change in recent decades (Richard 2004).

Given the great potential for change of freshwater flow into Hudson Bay, more research is required to determine the effects of freshwater on belugas. Do belugas require freshwater? Do other variables such as shelter draw belugas to estuaries? If freshwater is a requirement for belugas then interference with natural freshwater flows may be a potential problem, for beluga whales in Hudson Bay.

II.5.1.1 Telemetry

Considering 2005 (wet year) and 2002, 2003, and 2004 (dry years) the 13 tagged belugas were farther out in the estuary during 2005. This effect was observed for belugas in the fresh water or mixed portions of the estuary, and related to the main channels. Beluga coastal movements²¹, however, imply no difference between the wet and dry years. The GLM results for the telemetry data also suggest no relationship between time of day and any of the three dependent distance measures. This suggests that other influences, such as tide, weather, or disturbances have a greater influence on the locations of belugas in the Nelson River estuary. Similar results exist for other studies. In Cook Inlet, Alaska, no clear relationship between a single factor and beluga distribution was apparent; however, tide, water depth, and temperature were suggested as influences on

²¹ Coastal movements refers to the movements of belugas while outside the mixing zone but still within the defined estuary limits, as tested using the distance to the nearest shoreline

beluga distribution near the river deltas (Moore *et al.* 2001). In Russian waters during high spring tides, prey availability presumably motivates the coastal movements²² of belugas into rivers (Kleinenberg *et al.* 1969). These examples illustrate the argument that separate beluga populations may enter estuaries for different reasons.

For this study, each animal location within the estuary includes the respective tide level value. Table II.12 illustrates a significant correlation between tide and ‘distance to river-mouth’. Tide was not included in the GLM analysis, because animal locations for this analysis were pooled by day to account for autocorrelation.

II.5.1.1.1 Distance to Nelson River Vs Tide

Table II.13; Pearson Correlation Coefficient for Distance to River-mouth (in km) and Tide Level (in meters), number of observations = 683

| Nelson River estuary: | | |
|--|---------------------------------|------------------------|
| Pearson Correlation Coefficient for distance to river-mouth (in km) and tide level | Distance to River-mouth (in km) | Tide Level (in meters) |
| Distance to River-mouth (in km) | 1 | -0.07237, 0.0587 |
| Tide Level (in meters) | -0.07237, 0.0587 | 1 |

II.5.1.2 Aerial Surveys

For the aerial surveys, ‘year’ and ‘distance to river-mouth’ were correlated. A log transformed linear regression fit to ‘distance to river-mouth’ vs. ‘density’ indicates higher densities close to the river-mouth within 0–22 km (Figure II.15). Although aerial surveys recorded belugas upstream of Port Nelson, no radio-tracking data were recorded there. For the purposes of these analyses, any aerial survey densities recorded farther upstream than Port Nelson had “distance to river-mouth” values set equal to zero. From 22 km to the 66 km outer extent of the surveys, beluga densities for the year of 2005 are

significantly higher than for the years of 2003–2004. The maximum distance from Port Nelson measured for all surveys was 66 km, which lies in an East direction near the shallow flats located northeast of the mouth of the Hayes River. The radio-tracking data however, illustrates that belugas were farther offshore in a north direction than the coverage of the aerial surveys. The smaller extent of the aerial surveys, relative to the defined estuary, is a limitation of this analysis.

Finally, estuary-use is common to most beluga populations so these methods are applicable when testing for temporal variations in the locations of belugas in other estuaries, even though much research suggests results will vary.

II.5.2 Shape of Nelson River Estuary

Like most estuaries, the Nelson River estuary is constantly expanding and contracting as freshwater flows from upstream and saltwater circulates with the tide (Baker 1989). The shape of the estuarine study area, as defined by the beluga radio-tracking data, shows a larger region than is visible through satellite imagery of the surface plume of fresh water. It is also much larger than the extent of the aerial surveys. Thus, the aerial survey densities are not able to reinforce findings from the telemetry data for the region extending from the aerial survey limit (66 km) to the extent of the telemetry-defined estuary (134 km). The choice to use a bounding polygon around the beluga location data to delineate the estuary is a conservative measure. Convex polygons or other methods of encircling the telemetry locations often include regions outside of recorded animal locations, potentially overstating the study area. The estuary delineation

methods show that the estuary, as belugas use it, extends farther out than is visible from the MODIS imagery of the same period. This may be due to the stratification of the fresh and saltwater, where fresh water is less dense and travels along the surface. The highest densities of belugas exist beyond the surficial mixing line, suggesting that belugas in the Nelson River may not use the fresh water zone of the estuary as often as seen in other estuaries such as Millut Bay or the Mackenzie River.

The larger size of the estuary also has management implications. With regions extending almost 150 kilometers along the Hudson Bay coast, the definition of the estuary as a beluga habitat must reflect the evidence. For beluga management, the estuary includes the eastern shore of the Nelson Estuary-past the entrance to the Hayes River estuary as well as regions extending north along the western shore of Hudson Bay past the Nelson Shoal and Owl River entrance to Alapapoo Bay. The coastal region extending north of Alapapoo Bay (figure V.4) to Cape Churchill is not included in our study area. For management purposes however, it should still be considered critical Western Hudson Bay beluga habitat. The 2002–2005 radio-tracking data revealed this as the main migration route for belugas migrating between the Nelson River estuary and the Churchill River estuary and then to Hudson Strait.

The shape of the estuarine study area defined for this study is comparable to the 2004 DFO aerial survey extent²² but much larger than the 2003 and 2005 Nelson

²² The 2004 aerial surveys were conducted by Pierre Richard of Fisheries and Oceans Canada (DFO)

surveys²³. Regions included in the estuarine study area but not in the 2003 and 2005 surveys include the western stratum, located offshore of the Churchill/Seal and the eastern stratum along the Hudson Bay coast of Ontario. The 2004 surveys include the coastal region from Cape Henrietta Maria, on the Ontario coast of Hudson Bay, up the west coast of Hudson Bay, along the Manitoba coast to Thiewiaza, Nunavut.

²³ The 2003 and 2005 aerial surveys were conducted by Warren Bernhardt of NorthSouth Consulting, under contract to Manitoba Hydro

Figure II.18; Nelson River estuary boundary (using beluga radio-tracking data 2002–2005), Fisheries and Oceans Canada aerial survey extent (2004), and the Manitoba Hydro / NorthSouth Consulting aerial survey (2003, 2005) extent

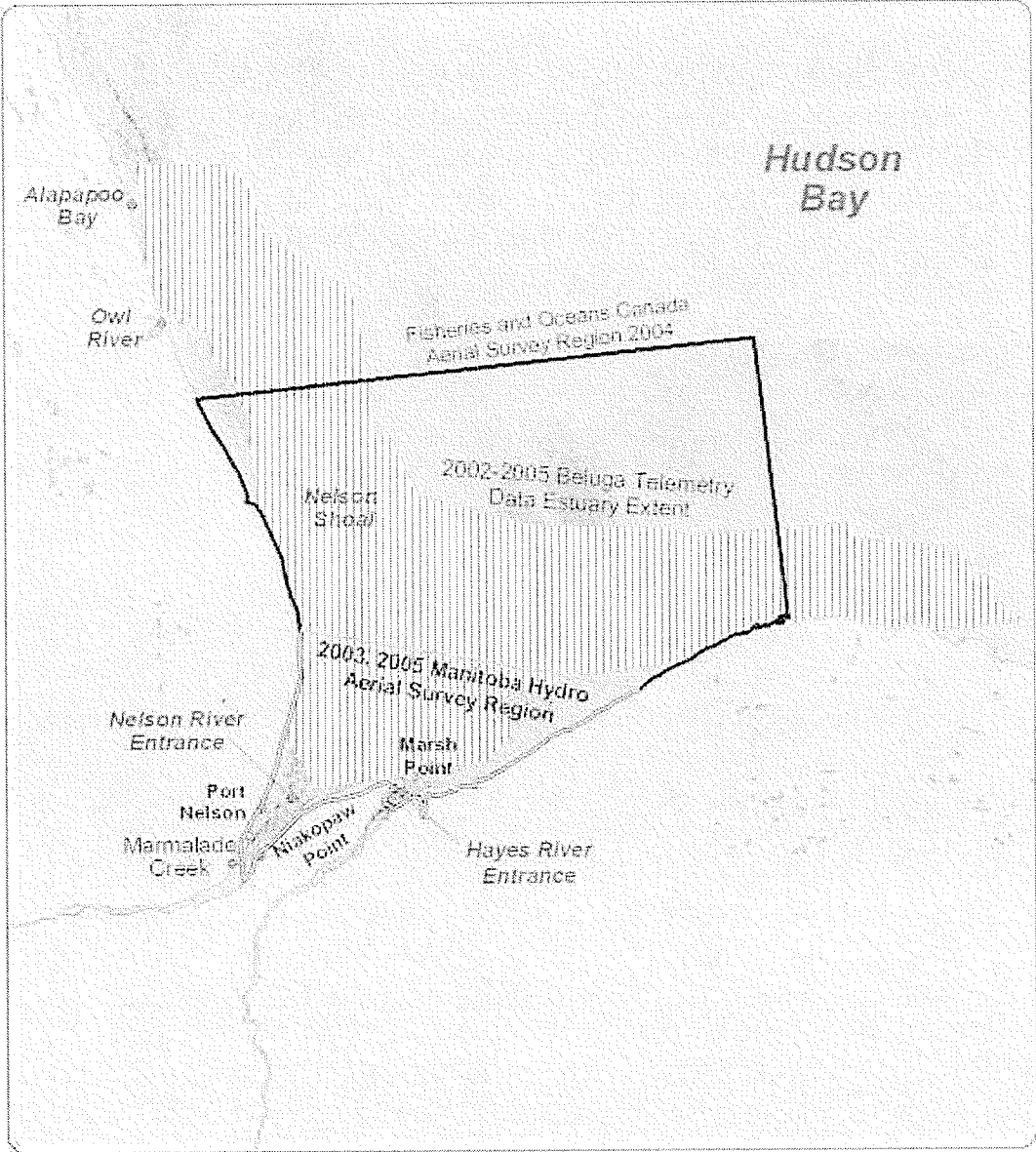

II.5.3 Data Limitations

Given the large number of belugas using this estuary²⁴ (Richard 2005), a generalization from four years of telemetry data and two years of aerial survey is insufficient to examine the nuances of beluga-use of this region. Nevertheless, some conclusions about Western Hudson Bay belugas can be drawn here since belugas at higher latitudes have demonstrated that there is relatively little behavioural variation between belugas in a particular population (Martin *et al.* 1998; Martin and Smith 1999).

The large number of belugas using the Nelson River estuary, along with the potential for mixing between or within Hudson Bay beluga stocks (de March *et al.* 2002) may also complicate short-term measurements of population change for this stock. Ungava Bay belugas, for example, exist in such low numbers²⁵ (Smith and Hammill 1986; Kingsley 2000; Gosselin 2002) that an observation of an additional 100 belugas there would be noticeable. An increase of 100 belugas using the Nelson River estuary, however, likely would go undetected, given current survey methods.

The relative strength of this study lies in its dual data-type methods and the objective method used to delineate the estuary boundary. These two data-types allowed results from analyses of the radio-tracking data to confirm findings from the aerial survey methods, and visa-versa. The consistency of results across the samples allows confidence that the principal conclusions of this study are valid. Moreover, estuary-use is common to

²⁴ The 2004 uncorrected estimate (i.e.: belugas observed near the surface) in the Churchill-Seal and Nelson areas of 27,200 is close to the 1987 estimate of 25,100).

²⁵ This stock may be extirpated. Surveys of this region since 1985 have found no whales.

most beluga populations so this model may be an applicable test for temporal variations in beluga behaviour in other estuaries.

CHAPTER III: A REVIEW OF BELUGA WHALE (*Delphinapterus Leucas*) ESTUARY USE HYPOTHESES

III.1 ABSTRACT

Beluga whales (*Delphinapterus Leucas*) (Pallas 1776) are well studied, but their seasonal use of estuaries is still a topic of speculation and misunderstanding. This study reviews the alternative hypotheses for beluga estuary-use. During summer months, belugas living in regions of seasonal ice coverage congregate in estuaries. Most beluga populations have a similar behaviour, using estuaries during summer and moving offshore in fall and winter. Beluga estuary-use hypotheses include feeding, calving, moulting, avoiding killer whales (*Orcinus orca*), avoiding humans, thermal advantage, and phylogenetic inertia. These hypotheses may not be mutually exclusive and may vary with geography and across populations. Past research on this topic has lacked ecological context, often describing the proximate but not ultimate cause(s) for beluga estuarine occupation. Moreover, the importance of freshwater to belugas is both understated and overstated, among beluga researchers. Reviewing the hypotheses is a first step in objectively answering the over-arching question of why most belugas use estuaries every summer, and contributes to scientific knowledge and management of the species.

III.2 INTRODUCTION

This research reviews the alternative hypotheses for beluga whale (*Delphinapterus Leucas*) summer estuarine occupation, using a ‘weight of evidence’ approach. It is not known precisely why belugas use estuaries but estuary occupation is not common among cetacean species. The Pacific white-sided dolphin (*Lagenorhynchus obliquidens*), for example, frequents near-shore waters during winter and spring and moves offshore *during summer* and fall. Beluga whale estuary-use hypotheses include feeding (Kleinenberg *et al.* 1969; Seaman and Burns 1981; Seaman *et al.* 1982), calving (Sergeant and Brodie 1969; Sergeant 1973; Fraker *et al.* 1979), moulting (Finley 1982; St. Aubin *et al.* 1990), avoiding killer whales *Orcinus orca* (Brodie 1971), avoiding humans, and phylogenetic inertia (W. Doidge, Makivik Corporation, Montreal, Quebec, pers. comm. 2005). Each beluga estuary-use hypothesis is discussed below and related to related to the general provisions of estuaries, including warm water, shallow water, shelter from wind and waves, bottom type, air temperature, and shelter from ocean currents. Understanding why belugas use estuaries every summer contributes to the scientific knowledge and management of the species.

III.1 MOULTING

Belugas are subject to a seasonal skin moult during summer months. In ice-free regions they are often present in estuaries, including the Nelson River estuary, while they are moulting (Finley 1982; St. Aubin *et al.* 1990). Within cetacea, moulting is unique to belugas. Killer Whales are the only other odontocete known to seek out specific regions for rubbing (Condy 1978; Ford 1988). Some pinnipeds may haul out during summer to

allow their skin to reach a suitable temperature (~15 Celsius) for epidermal growth and hair replacement. (Feltz and Fay 1966). This temperature is within the range found in estuaries used by belugas. Below I discuss characteristics of estuaries that may be conducive to beluga moulting.

III.1.1 Warm Water for Moulting Belugas

Moulting belugas may choose estuaries to initiate or promote moulting. The weight of evidence for this hypothesis is positive. During summer months, most belugas seek out warmer and often brackish water near the mouths of rivers. The removal of dead skin and rapid growth of new skin cells takes place when belugas occupy the warm estuaries (St. Aubin *et al.* 1990). The seasonality of this behaviour may be a particular feature of Hudson Bay and Eastern Baffin Island belugas. It is not clear that the moult is as seasonal in the St. Lawrence estuary (Richard *et al.* 2002). Belugas have been observed rolling on the muddy or gravel river bottom (Finley 1982; Finely *et al.* 1978; Richard *et al.* 2002), possibly to help remove dead skin. This behaviour was observed for all age classes (Richard *et al.* 2002). Such behavioural evidence however, is limited by its inability to reveal any motivations for estuarial occupation. Belugas may take advantage of the provisions of the estuary, including any available rough surfaces, but motivations for estuary-use are still unexplained. Some belugas do not use estuaries—particularly populations that have year-round access to sea-ice. For these belugas, evidence of moulting or rubbing behaviour is lacking. This lack of ecological context is a problem when attempting to examine moulting as a reason for beluga estuary-use. Thus, belugas

may not require estuaries to moult but are observed moulting while in estuaries—probably because that is where they are often observed, and estuaries offer relative safety during a potential time of vulnerability.

III.1.2 Shallow Water for Moulting Belugas

Belugas may prefer shallow estuaries during their moult. With the exception of glacier-fed estuaries, most shallow water estuaries are warmer. But, the shallow water of estuaries such as the Nelson and Churchill River estuaries, and Millut Bay may also provide safety from attacks by killer whales during this time of vulnerability (see section III.5.3 Predator avoidance; killer whales). No evidence sightings of killer whales exist for the Nelson River estuary region but sightings farther north near the Churchill River estuary and Repulse Bay are more frequent in recent years (table I.1). Historic sightings of killer whales also exist for Cumberland Sound (Baird 1999). Predator distribution often dictates prey species distribution (Sergeant *et al.* 1975). The absence of killer whales in the Nelson River suggests that belugas may congregate here because there are no killer whales.

Harwood *et al.* (1992) speculate that the occurrence of beluga in the shallow waters (2-meter isobaths) of Shallow bay and west Mackenzie bay may relate to feeding or suitable substrate for rubbing. Rubbing is not documented for these areas as it is for other estuaries in Hudson Bay (St. Aubin *et al.* 1990) and the High Arctic (Smith *et al.* 1992). Smith *et al.* noted however, that belugas in the high arctic rubbed in both shallow and deeper water, commonly diving to 2-4 meters.

III.1.3 Bottom Type for Moulting Belugas

Belugas have been observed digging in estuary sediment, which may help rid them of old skin, allowing new skin to form (Finley 1982; Finely *et al.* 1978; St. Aubin *et al.* 1990; Richard *et al.* 2002). Evidence for this hypothesis is inconclusive. Individuals roll on the muddy or rocky bottoms at the mouth of river channels, which have strong currents. All age classes appear to engage in this behaviour (Richard *et al.* 2002).

In Cumberland Sound, geologic data suggest limited differences in substrate between Millut Bay²⁶ and other less frequented estuaries such as Nettilling Fiord or Shark Bay²⁷. Cumberland Sound bottom type is generally composed of sedimentary rock but portions of Millut Bay also have large boulder fields²⁸.

Other whale species that do not undergo a seasonal moult have also been observed rubbing on sand and gravel bottoms. Killer whales sometimes rub against a hard surface or against other whales. This behaviour might comfort them or remove dead skin. Some

²⁶ The bulk of the Cumberland Sound beluga population summers in Clearwater Fiord, in Millut Bay near the mouth of the Ranger River (figure I.6)

²⁷ Substrate measurements are based on surficial geology from the Nunavut Geoscience Sampler in Compact Disk® format, from the Nunavut Geoscience Office, Canada, 2004.

²⁸ Data from Canada Nunavut Geoscience Office 2004 and J. Orr, Department of Fisheries and Oceans, Canada., Winnipeg, pers. comm. 2004).

rock rubbing areas may also be important socially for killer whales (Hoyt 1990; Baird 1999; Rendell and Whitehead 2001).

III.1.4 Air Temperature / Sunlight for Moulting Belugas

In Cumberland Sound, the arrival of belugas summering coincides with the start of the effective growing season. The effective growing season included all days with a maximum temperature of five degrees Celsius or more. The start of this season for southern regions of Cumberland Sound is 26 June (Canada-Nunavut Geoscience Office 2004). The departure of belugas from Clearwater Fiord follows the end of the effective growing season for this region, recorded as 2 September (Canada-Nunavut Geoscience Office 2004). This evidence supports seasonal weather change as a reason why belugas visit selected estuaries, such as Millut Bay in Clearwater Fiord, during summer months. Thus moulting in belugas may relate to available sunlight and warmer air, however evidence is limited. Related data for belugas in most other Arctic estuaries used by belugas are not available.

III.2 CALVING

Calving is thought to be one of the proximate causes for belugas visiting shallow, calm estuaries during summer months (Sergeant and Brodie 1969; Sergeant 1973). For this study, the term calving includes all behavioural, hormonal, and physiological actions compartmentalized into parturition, lactation, post-lactation parental care, and maternal recovery (Gittleman and Thompson 1988). Assuming a 1:1 sex ratio for the species

(Doan and Douglas 1953; Sergeant 1973; Finley et al 1982; Seaman and Burns 1981), observations of more females and cow/calf pairs than males in estuaries might suggest a specific benefit to calving here. In addition, females and females with calves may be expected to use the estuaries for longer periods. However, male belugas often accompany females and calves into the estuaries for other reasons such as existing social ties (Rendell and Whitehead 2001). Studies in two Canadian estuaries did not observe any calving events (Caron and Smith 1990; Smith *et al.* 1994). Both studies found that arriving females already had calves. The assumption is that calving is likely spread out from June to August (Brodie 1971; Sergeant 1973) and peaks in mid-June to early July. Barber *et al.*, (1999) used telemetry results to indicate seasonal bathymetric preferences for male and female belugas and found that on average, belugas prefer much shallower water *during summer*, compared to autumn. A significant difference in bathymetry use between males and females was found for the eastern Beaufort Sea population. They speculate that much of the difference may be due to the behaviour of females with calves. Barber *et al.* (1999) also suggest that mother-calf pairs spend longer periods in shallow water than other age or gender classes.

Some evidence does not support calving as an estuary-use hypothesis. Hunters and elders of Iqaluit and Frobisher Bay have observed beluga births where no known beluga calving estuarine areas exist. The hunters qualified this statement by suggesting that the small population of belugas using Frobisher Bay during summer months explains the small number of births (Kilabuk 1998). The qualitative nature of these reports limits any speculation about fecundity being affected by the suboptimal calving habitat, but future study on beluga calving occurrences in Frobisher Bay could prove very useful to weigh

the estuary-use hypotheses (D. Walker, University of Manitoba, Winnipeg, Canada 2007).

III.5.2.1 Warm Water for Calving Belugas

Warmer water may give beluga calves an energetic advantage during their early months. However, the weight of evidence in this case is inconclusive. Ambient water temperature may affect beluga calves more than adult belugas because the calves have not developed a full insulating blubber layer (Sergeant and Brodie 1969; Sergeant 1973; Fraker *et al.* 1979). Sergeant (1973) hypothesized that belugas give birth in estuaries, where the warm water confers a thermal advantage on neonatal calves much like the grey whale (*Eschrichtius robustus*) in the lagoons of Baja, Mexico (Finley 1983; Rugh *et al.* 1999).

Conversely, measurements of the insulation values of the epidermis of newborn belugas, and of pregnant belugas, partly discount this hypothesis (Doidge 1990; Ognetrov 1990). Ognetrov (1990) compared weight of blubber/skin to total weight for belugas killed in Russian waters (Ognetrov 1990). Results for belugas of all age and sex classes (N=503) show no difference comparing males with females of different physiological status suggesting that belugas do not require warmer water during pregnancy (Ognetrov 1990). Ognetrov (1990) also found considerable seasonal variations in condition, with diminishing index values from June and September. Beluga blubber and skin conditions for over-winter periods was not included, but belugas tend to be fattest in spring, presumably after feeding during winter months (Butorin 1966 in Boltunov 2002). The warm water requirement of young belugas is also disputed by existing behavioural

studies in estuaries (Finley 1982; Smith *et al.* 1994). Other similar research for Killer whales has suggested that the influence of temperature on the caloric budget may be a more useful measure, compared to insulation values (Williams *et al.* 2004). The source of the freshwater entering the Nelson River estuary, where many beluga calves are observed, is the Nelson River watershed. The Nelson River watershed includes much of Manitoba and flows mainly from the southwest to meet the colder saltwater of Hudson Bay. The resultant large fresh-saltwater mixing zone extends 10–60 km offshore, depending on many variables including outflow from Limestone Dam, tidal state, wind direction, and salt-water current. Most belugas, including calves, occur near this mixing zone. Warmer, fresher water is available farther upstream in the Nelson River but belugas remain closer to the mixing zone, suggesting that they prefer a specific temperature range. In Clearwater Fiord, Cumberland Sound, the Ranger River glacially feeds Millut Bay, the main estuary used by mothers with calves. Glacier-fed estuaries are generally colder than non-glacier-fed ones. However, Millut Bay is notably warmer than the open water of Cumberland Sound. This effect may be due to warming effects of the sun on the relatively shallow, sediment laden Ranger River (J. Orr, Department of Fisheries and Oceans, Canada. Winnipeg, pers. comm. 2004). This suggests that Cumberland Sound belugas also prefer a certain temperature range, rather than the warmest available fiords because other near-by non-glacier-fed estuaries are warmer than Millut Bay but are used much less by belugas. However, considering the range of estuary habitat used by belugas, the needs of belugas in Cumberland Sound and Hudson Bay may differ from the high-Arctic belugas studied by Smith *et al.* (1994).

Belugas are ideally adapted to their environment. For this reason, heat stress on young belugas caused by warm water *during summer*, may be as problematic as cold stress in severe winters. A similar problem exists for many cetaceans, including the bottlenose dolphin (*Tursiops truncatus*) which exhibits similar physiology in warm water, redistributing heat from the core to the blubber layer (Heath 1999).

III.5.2.2 Shallow Water for Calving Belugas

Shallow water may provide safety for female belugas with calves. Evidence for this hypothesis is positive. Small beluga calves are possibly not able to dive as deep or as long as adult belugas, and are slower swimmers (P. Richard. Department of Fisheries and Oceans, Canada. Winnipeg, pers. comm. 2004)

Much of the earlier literature on belugas in estuaries describes their movements relative to tides (Vorotnikov 1927; Aesen'ev, 1939; Golenchennko 1935, Dmokhovskii 1939; Heptner 1930, Vladykov 1949, Govorkov 1934, Kleinenburg 1964)). Belugas in the Nelson River estuary also migrate inshore primarily during high tide, often favouring the two main channels (Smith unpubl. data 2007). This is consistent with the findings of others belugas in estuaries where water levels fluctuate markedly (Doan and Douglas 1953; Kleinenberg *et al.* 1964). However, many of the belugas entering the inner Nelson Estuaries at high tide travel through areas that low tide exposes, revealing a possible depth preference for belugas with calves in estuaries, instead of the constant use of the deeper channels .

The effect of tide on belugas using the Churchill estuary is similar, with some exceptions. The relatively small tidally exposed regions of the Churchill River differ

significantly in size compared to the extensive mudflats of the Nelson River Estuary (GEBCO 2000). Furthermore, the main channel leading into the Churchill River is deeper and extends farther than those of the Nelson River Estuary, and belugas can move in the Churchill River at mid-tide (Smith unpubl. data 2007).

Segregation between beluga sexes based on water depth, may exist for Clearwater Fiord. Here, full-term and postpartum females separate from the main group, and move along the shore or into shallower bays (Brodie 1971). Belugas in the Nelson River behave similarly. All ages and sex classes use the estuary but calves were observed in large numbers upstream (Smith unpubl. data 2007). However, since calves surface more often adults, observations of this type may be misleading. In Eastern Hudson Bay belugas, Caron and Smith (1990) showed that tidal state had the most effect on group positions in the Nastapoka River estuary.

Evidence for Cumberland Sound estuaries suggests that shallow water is not a requirement for belugas in estuary. Instead, belugas may utilize regions having direct access to shallow water (Smith 2004). Cumberland Sound belugas summer in deep, canyon-like fiords such as Clearwater Fiord. (P. Richard, Department of Fisheries and Oceans, Canada. Winnipeg, Manitoba, pers. comm. 2004). Millut Bay, at the mouth of the Ranger River, transitions from shallow, tidally exposed boulder fields to a steep drop-off zone, to a deep central portion, leading out into Clearwater Fiord (Smith unpubl. data 2007). Tidal range here is among the highest occurring in Cumberland Sound (Stewart *et al.* 2003) which may explain why belugas use this type of multi-purpose habitat. Other Cumberland Sound fiords are uniformly shallow but are used much less by belugas,

perhaps because the tidal range combined with expansive shallow water increases stranding risk for belugas.

III.2.3 Shelter from Wind for Calving Belugas

Female belugas may choose the wind shelter of estuaries to give birth. The shape of some estuaries can provide calves with protection against strong winds, often present in the north (Canada Coastless; P. Richard, Department of Fisheries and Oceans, Canada. Winnipeg, Manitoba, pers. comm. 2004). The weight of evidence for this hypothesis is inconclusive. The Nelson River estuary provides a break from strong northerly winds. Weather differences can be substantial from Gillam Island, located 15 kilometres upstream in the Nelson River, to Port Nelson, located at the mouth of the estuary. The resulting change in sea-state and weather from Port Nelson to the open waters of Hudson Bay, past the eastern point, is again equally substantial. While it is 25 Celsius and calm at Gilliam Island (located ~17 kilometres upstream from Port Nelson), Niakopaw Point may experience white caps and high winds, and a 20 degree Celsius drop in temperature. Strong northerly winds also influence numbers of belugas in the Nastapoka River estuary more than warm water or water clarity (Caron *et al.* 1990).

In Cumberland Sound the highest recorded wind speed averages are found near the southern portion of Irvine Inlet and around the Mckeand River. This is likely due to the northwest winds building across the open water of Cumberland Sound. Millut Bay, where most Cumberland Sound belugas congregate during summer has high cliffs surrounding two sides that offer shelter from some wind directions but also possibly funnelling winds

from other directions (J. Orr and P. Richard, Department of Fisheries and Oceans, Canada., Winnipeg, Manitoba, pers. comm. 2006). The region surrounding Millut Bay and Clearwater Fiord has wind speeds of 14 km/h and 14.5 km/h, suggesting that some guarding against the prevailing winds occurs there. This amount of wind protection may provide a calm environment, favourable for female belugas to give birth and nurse calves. However, other Cumberland Sound estuaries have similar physiographic surroundings, but are used much less by belugas. Other marine mammal species seek out sheltered environments for giving birth. One example is the Florida Manatee, which is sometimes observed giving birth in small rivers or in canals (Megan Martz, Margie Barlas, Florida Fish and Wildlife Conservation Commission, St. Petersburg, Florida, pers. comm. 2004).

III.2.4 Shelter from Strong Currents for Calving Belugas

Estuaries with weaker water currents may provide favourable conditions for belugas giving birth. The weight of evidence for this hypothesis is inconclusive. In the Nastapoka River, Caron *et al.* (1990) showed that tidal state had the biggest effect on the position of the beluga groups in the estuary. Tidal state affects water depth and currents, which influence beluga distribution in an estuary (Caron *et al.* 1990). Tidal currents can also stir up or congregate food, increasing foraging productivity (Zamon 2001). Related to this, bathymetry also affects water currents in an estuary. In fluvial systems, shallow regions often have reduced a flow rate compared to deeper areas where large volumes of water push through narrow channels, increasing the flow rate.

III.3 PREDATOR AVOIDANCE; KILLER WHALES

Predation by killer whales is an important cause of beluga mortality (Reeves and Mitchell 1988; Kilabuk 1998). Beluga whales may enter estuaries to seek shelter in shallow waters during ice-free periods to hide from killer whales (Brodie 1971, Richard 2005). Evidence supports this hypothesis. Beluga distribution in some regions may be an adaptation to avoid killer whale predation (Sergeant *et al.* 1975). Similarly, some baleen whales may also migrate to avoid killer whales (Corkeron and Conner 1999) since killer whales are most abundant in coastal habitats and higher latitudes (Leatherwood *et al.* 1976). Ice cover, availability of prey, and human predation, limits the range of killer whales (Reeves and Mitchell 1988). Thus, killer whale use of the Arctic is seasonal, unlike resident or non-migratory killer whale populations of lower latitudes. *During summer months*, in seasonally ice-free zones, belugas cannot rely on heavy sea-ice for shelter (P. Richard, Department of Fisheries and Oceans, Canada. Winnipeg, Manitoba, pers. comm. 2004). Killer whales inhabiting coastal regions often enter shallow bays, estuaries, and river-mouths (Leatherwood *et al.* 1976). Newborn calves are particularly susceptible to predation because they are slow swimmers and shallow divers (P. Richard, Department of Fisheries and Oceans, Canada. Winnipeg, Manitoba, pers. comm. 2004).

Killer whales are widely distributed in the western North Atlantic Ocean, and sightings exist from near Baffin Island and in Hudson Bay (Reeves and Mitchell 1988). These regions often overlap seasonal ranges of beluga whales. Historically, killer whales were common in Cumberland Sound near the mouth of Kingnait Fiord, near the Kikastan Islands, where bowhead whales were hunted (Reeves and Mitchell 1988; Richard *et al.* (2003).

Millut Bay in Clearwater Fiord, where belugas aggregate in summer, is inside an interspersed series of passages and away from the main Cumberland Sound waters. Belugas here may be hiding somewhat protected from ranging killer whales with little or no familiarity with the area. Millut Bay is also shallow upstream and may provide shelter if killer whales do find their way there (P. Richard, Department of Fisheries and Oceans, Canada. Winnipeg, Manitoba, pers. comm. 2004). This island maze may also serve as an acoustic barrier (J. Orr, Department of Fisheries and Oceans, Canada. Winnipeg, Manitoba, pers. comm. 2004). Acoustics may also play a role in the locations of belugas in other estuaries, including the Nelson River estuary where the fresh-saltwater mixing zone may act as an acoustic smokescreen, due to speed differences between sound travelling through silt-laden fresh water and clearer saltwater. Acoustics, concerning belugas resource selection, is a relatively unexplored area of research but acoustic barriers as avoidance techniques from predators are common, including sea otters (*Enhydra Lutris*) hiding from killer whales (Trites 2006). See section II.3.1 'Predator Avoidance; Killer Whales; Acoustic Barriers' for more discussion.

Hunters in Cumberland Sound have reported evidence of killer whale predation on beluga (Cosens 2002) and some are concerned that an influx of killer whales caused local population decline in other marine mammals (Hay *et al.* 2000). In the 1960's, Inuit hunters in Cumberland Sound expressed concern that killer whale numbers in this region were increasing and that it was reducing their marine mammal harvest. In the mid-1970's, killer whales used the mouths of Kingnait and Pagnirtung fiords in August and September, and sometimes drove narwhals into Pagnirtung Fiord allowing Inuit to make

larger harvests (Richard *et al.* 2003). In September 1977, fourteen killer whales became stranded while chasing belugas into a saltwater bay near Kekertellung Island (Reeves and Mitchell 1988). Local Inuit killed the whales in early October of the same year. More recently, a pod of 10 killer whales was seen coming from Clearwater Fiord and hunters reported seeing evidence of killer whale predation on both belugas and bowheads (Cosens 2002). In 1987, The Committee on the Status of Endangered Wildlife in Canada (COSEWIC) was interested in the killer whale but did not consider the species to be of immediate concern. However, there is evidence supporting the hypothesis that killer whales hunt and kill belugas in Cumberland Sound, and that belugas make efforts to avoid them.

In Hudson Bay, more frequent killer whale sightings exist from recent years (Richard 2005; J. Higdon, Orcas of the Canadian Arctic, Winnipeg, Manitoba, pers. comm. 2006). Climate change may be making it possible for killer whales to arrive earlier and stay longer before they are driven out by the formation sea-ice (Higdon *et al.* 2006). Although killer whale numbers may still be low in Hudson Bay, it does not take a large number of these top-level predators to cause a noticeable reduction in a marine mammal population (Williams *et al.* 2004). The potential effect of killer whales on Hudson Bay marine mammals is notable. Annual killer whale sightings exist since the late 1990s for Repulse Bay, Northwest Hudson Bay (Figure 2), north of Southampton Island, and Roes Welcome Sound. These sightings are usually associated with movements of narwhal. In 1998, 1999 and 2004–2006 locals reported that killer whales kept the narwhal packed in close to shore during the hunt (J. Higdon, Orcas of the Canadian Arctic, Winnipeg, Manitoba, pers. comm. 2006).

Reports of killer whales also exist for south western Hudson Bay although no killer whale sightings exist south of Churchill to the Nelson River estuary (J. Higdon, Orcas of the Canadian Arctic, Winnipeg, Manitoba, pers. comm. 2006) (Figure I.6). However, unconfirmed reports exist for the Severn River and York Factory, on the Ontario coast.

See section III.3.3 for more discussion on potential future impacts of killer whales on belugas.

Table III.14; Historic killer whale sightings for southwestern Hudson Bay, Churchill region from the 1940s to present.

| Year | Month | Day | Location | Killer whales seen | Pred-ation | Source | Latitude | Longitude |
|------|-----------|-----|-------------------------|--------------------|------------|-----------------------------|----------|-----------|
| 1949 | Summer | – | Churchill (near) | – | – | Doan and Douglas 1953 | 58.92 | -93.66 |
| 1980 | Summer | – | Churchill (near) | 1 | – | Reeves and Mitchell 1988 | 59.01 | -93.99 |
| 1996 | August | – | Churchill (15 km north) | 9 | – | W. Bernhardt, NS Consulting | 58.82 | -93.26 |
| 1996 | Summer | – | Churchill (in town) | – | – | local residents | 58.88 | -93.71 |
| 2000 | Summer | – | Churchill | 4–5 | 1 | local resident | 58.88 | -93.71 |
| 2002 | August | | Churchill | 2 | – | local resident | 58.88 | -93.71 |
| 2002 | August | 31 | Churchill River-mouth | ~7–9 | 1 | local resident | 58.88 | -93.71 |
| 2002 | August | 30 | Churchill (near) | 7 | 1 | W. Bernhardt, NS Consulting | 58.92 | -94.13 |
| 2004 | August | 1 | North of Cape Churchill | 6–7 | – | P. Richard (DFO) | 58.82 | -93.21 |
| 2005 | August | – | Churchill | – | – | P. Hall (DFO) | 58.88 | -93.71 |
| 2005 | Summer | – | Churchill (near) | – | – | W. Bernhardt, NS Consulting | 58.93 | -93.51 |
| 2006 | September | 1 | Churchill | 1 | 1 | E. Kublutsiak | 58.88 | -93.71 |

The first recorded sightings of killer whales in Hudson Bay occurred in the 1940s when killer whales chased beluga and narwhal into Repulse Bay and later attacked bowhead whales in Lyon Inlet (Hay *et al.* 2000, Gonzalez 2001). However, reports were sporadic until the late 1980s (Reeves and Mitchell 1988) and then almost annually from

1998 to 2006. Most killer whale sighting records are for 2005 and 2006, likely due to increased collection by the Orcas of the Canadian Arctic (OCA) research group.

In Repulse bay, killer whale sightings are usually associated with narwhal but there are also some reports of attacks on bowhead whales. Reports of attacks on beluga are rare but because of the vast remoteness of the north, almost all attacks likely occur undetected by humans.

III.3.1 Predator Avoidance; Killer Whales; Acoustic Barriers

Sound waves in the oceans travel great distances and this feature is used by some whale species, including belugas and killer whales. Since salt water has a greater density than fresh water, sound should travel faster compared to sound through fresh water. But sound travels at approximately 1500 m/s in saltwater and approximately 1435 m/s in freshwater, depending on salinity. For a liquid, the speed of sound decreases with increasing density but increases with increasing bulk modulus. Bulk modulus is a substance's resistance to uniform compression defined as the pressure increase needed to effect a given relative decrease in volume. For saltwater (compared to fresh water) the percent increase in bulk modulus is greater than the percent increase in density so the sound velocity increases with salinity. The speed of the sound pushing various molecules causing a domino effect in the ocean. With the mixing of particular matter and sodium in estuaries, in particular the Nelson River Estuary, using acoustics to locate prey is likely not as productive compared with other open water regions.

The large amount of fresh water outflow in the Nelson Rive estuary during 2005 made it possible for belugas to move farther into the estuary, however they did not. Instead, higher beluga densities in the outer Nelson estuary for the wetter year of 2005.

This seems contradictory to evidence from other Arctic regions where belugas, narwhal, and bearded seals respond to the presence of killer whales by moving close to shore (G. Williams, NTI, Iqaluit pers. comm. 2006). Such reports however, are likely when belugas travel along coastal areas, rather than when they have already arrived at the relative safety of an estuary. In addition, other estuaries such as Millut Bay are much deeper than the Nelson River estuary, and the vast shallow flats of the Nelson Rive estuary probably offer more safety options to resident belugas.

Nevertheless, there may be other reasons, related to anti-predation tactics, why belugas show a spatial preference for the salt-freshwater mixing zone. Rather than finding places that are inaccessible to the predator (fish reference) beluga may benefit from the “smoke screen” effect created by the turbidity and highly variable salinity. Cephalopods (Squid) (*Cephalopoda*) have adapted a step further. When squid perceive a threat they are able to change colour, texture, body shape and even make their own smoke screen by releasing a ink-like secretion in the surrounding water to confuse the enemy while they quickly attempt to hide (Pearse 1987)).

III.3.2 Shallow Water for Belugas avoiding Killer Whales

Shallow water may help belugas evade attacks from killer whales. The weight of evidence for this hypothesis is positive. Inuit informants in Cumberland Sound and Iqaluit have reported that beluga whales, bowhead whales, and narwhal, often head to shallow inshore waters when killer whales are present, and may close in to land even before killer whales appear, as they can detect the killer whales by the sound of their dorsal fins slicing through the water. This fear reaction to the presence of killer whales is

called 'aarlungajut' (NWMB; Hay 2000). The belugas likely hear the killer whales before seeing them (Shelden and Rugh 2003). Belugas are highly sensitive to their surroundings, and are recorded reacting to disturbances up to 80 km away (Caron and Smith 1990). This sensitivity may be a characteristic of predator avoidance. Ocean predators often hunt and attack from below, generally when their prey surfaces. The color pattern of killer whales may assist them to approach prey from below. Their backs are black and presumably when viewed from above, not visible. Shallow water, such as is found in Millut Bay and parts of Irvine Inlet, may provide safety from such attacks by killer whales. Dramatic tidal changes across extensive mud flats such as those found in Clearwater Fiord may also provide belugas protection from killer whales. Killer whales are generally vulnerable to unintentional stranding for extended periods when they enter shallow, complex mudflats (Frost *et al.* 1992). This may explain why belugas generally occur in shallow water such as Millut Bay in Cumberland Sound or the Churchill and Nelson rivers in Hudson Bay. The avoidance of killer whales may also be why belugas are common in northern parts of Cook Inlet and relatively scarce elsewhere, as described by Shelden and Rugh (2003). Shelden and Rugh (2003) also noted that Cook Inlet is a semi-enclosed, shallow, and tidal estuary that is seasonally ice-covered and appears to be an ideal environment for belugas to evade killer whales.

III.3.2 Shelter for Belugas avoiding Killer Whales

Shelter may help belugas avoid killer whales. Evidence for this hypothesis is inconclusive. Caron and Smith (1990) illustrated that visibility (a proxy for turbidity) affected the position of the Nastapoka belugas. The belugas slightly preferred clearer

water to turbid water, when moving upstream. Complex shorelines may provide more protection from killer whales while guarding against wind and waves. The mouth shape of an estuary may also affect predator movements near that estuary. In Alaska, beluga whales and harbour seals (*Phoca vitulina*) are the most common marine mammal prey of killer whales (Matkin and Saulitis 1994). In Cook Inlet, Alaska, killer whale predation on belugas has become a concern since the decline of resident beluga stocks was noticed in 1990s (Shelden and Rugh 2003). Killer whales are common in lower Cook Inlet and there were at least 100 sightings from 1975 to 2002. Beach-cast beluga carcasses with teeth marks and missing flesh and observed killer whale-beluga interactions, serve as evidence that killer whales are killing belugas here. During 11 observed interactions between belugas and killer whales, the belugas were obviously injured or killed, through direct attacks or indirectly because of stranding. From this, a minimum estimated one death per year was attributed to killer whale predation, not including adults that were attacked while accompanied by calves (Shelden and Rugh 2003). In 1993 in Cook Inlet, regurgitated stomach contents of a stranded killer whale included a harbour seal flipper and beluga skin and blubber (Matkin and Saulitis 1994). An average killer whale eating pinnipeds (having an average caloric value of 3,000 calories) (Perez 1990 in Matkin *et al.* 2001) translates to a daily caloric requirement of ~60-70 kg per day—approximately the weight of a beluga calf. An adult killer whale requires a minimum of three seal pups a day to survive (Matkin and Saulitis 1994; Barrett-Lennard 1995).

III.4 PREDATOR AVOIDANCE; HUMANS

Belugas may enter estuaries to avoid humans, but the weight of evidence for this hypothesis is negative. Changes have occurred in Eastern Baffin Island belugas since the 1960s, when motorized boats were first introduced to the North (Kilabuk 1998). This is presumably because hunters started using them to hunt whales, and because of the noise and the possibility of danger associated with the noise. Locals state that initially, the alien noise motorized boats brought was not feared (Kilabuk 1998). Most whales were curious when they first heard them. Today, whales avoid areas where motorized boats are heard and are scattered in areas where they were once densely concentrated (Kilabuk 1998). Local communities also state that this has contributed to the thinning of whale concentrations and their population sizes.

Belugas sometimes travel through areas where human hunters are present in order to enter Clearwater Fiord, where the natives also hunt them. This suggests that Cumberland Sound estuaries such as Millut Bay in Clearwater Fiord, where they were hunted intensively in the past, provide a requirement which belugas must meet forcing them to risk being killed to get there (Kilabuk 1998). These needs, while not fully understood, are evident through the recurrence of belugas in Millut Bay, and the Churchill and Nelson River estuaries *during summer*, year after year. This type of behaviour is known in other species. African Wildebeest, a species disliking wet or sticky ground, is forced to cross the Mara River. They know the Mara River has crocodiles but they risk being eaten to avoid almost certain death by starvation. The reaction of belugas to the presence of humans can differ across estuaries. In the Churchill River, belugas often approach vessels and appear to be curious about humans. However, belugas are

sometime hunted near the Churchill River and locals have stated that this affects beluga behaviour for a period after, causing the belugas to remain outside of the estuary even at high tide (G. Lundie, SeaNorth tours, Churchill, Manitoba, pers. comm. 2006). In the Nelson River, belugas from the same Western Hudson Bay stock are much more elusive. Reasons for this change in behaviour from the Churchill River to the Nelson River are unknown. Belugas in the Nelson River react to boat noise by quickly changing direction and moving out of the estuary. If overtaken by a vessel, they often dive to the shallow bottom where the turbid water makes them invisible from the surface (J. Orr, Dept of Fisheries and Oceans, Winnipeg, pers. comm. 2005). The presence of humans around belugas often means the presence of a vessel.

Finley *et al.* (1990) studied responses of belugas and narwhals (*Monodon monoceros*) to Canadian Ice breaking ships over a three-year period. Belugas and narwhals exhibited different behavioural responses to ship approaches and ice-breaking activity. The belugas often moved fast along the ice edge away from approaching ships. Narwhals expressed no overt panic reaction (Finley *et al.* 1990). The response of the beluga involves forming large herds and making long dives close to or beneath the ice edge (Finley *et al.* 1990). Pod integrity of the belugas broke down and diving appeared to be less organized (Finley *et al.* 1990). Narwhals showed more subtle responses to approaching ships and did not form large herds. Their movements were slow or non-existent near the ice edge and they huddled in pods often engaging in physical contact (Finley *et al.* 1990). No similar field studies exist on pristine marine environments (in this case, a population of marine mammals that have had little or no exposure to human

activities) possibly explaining the responses of the studied narwhal and beluga at unprecedented ranges (Finley et. al 1990).

III.5 FEEDING

Belugas sometimes feed while in estuaries and may seek out estuaries to forage, however evidence does not support this hypothesis. Most beluga feeding behaviour in estuaries is probably opportunistic. Feeding was among the early hypotheses put forth (Comeau 1915; Vladykov 1947; Kleinenberg 1969). Stomach contents of belugas in the Nelson River examined by Comeau (1915) contained whitefish, capelin, and sucker. However, a more recent survey of the Nelson River estuary found few whitefish and no adult capelin (Draper 1989). Stomach contents of belugas in the Churchill River were mostly found to be empty (Doan and Douglas 1953; Sergeant 1973). Where food was present there was much variation in diet composition, and between years suggesting opportunistic feeding (Sergeant 1973). Doan and Douglas (1953) speculate that the strong digestive juices of the beluga stomach are the reason for the empty stomachs, but there is no scientific support for this claim. Most St. Lawrence beluga stomachs (usually from beach-cast carcasses) are also empty (Kingsley 2002).

Feeding also does not appear to be a proximate cause for Cumberland Sound belugas to occupy Millut Bay. Belugas summering here rarely feed on schooling fish but during their time outside the estuary in the open waters of Cumberland Sound, they often dive to the bottom (Richard 2002). The deep dives appear to be feeding dives (Richard 2002). The stomachs of belugas here also were often empty suggesting that belugas feed little during summer months while in the estuary (Brodie 1967, 1970).

However, there is some evidence supporting feeding as an estuary-use hypothesis. Brodie observed that postpartum female belugas were often accompanied by a new calf plus one or two non-white adults which may be previous offspring. Brodie speculated that this social grouping may be advantageous when feeding (Brodie 1971). Based on the statements of Brodie (1971), however, it is not clear whether these types of groupings are more common when belugas are in estuary, compared to open water areas. Belugas have also been observed digging into the estuary bottom sediment, suggesting some foraging behaviour. Stomach contents, presumably from benthic feeding, have included bark, sand, parts of plants and paper (Vladykov 1947; Doan and Douglas 1953). In the Beaufort Sea, some mature male belugas choose offshore areas for feeding during the summer, and travel to Mackenzie River estuary for other reasons (figure I.2; Loseto 2006). Every year from late June to late July or early August, belugas congregate in the warm estuarine waters of the Mackenzie River, while others are widely distributed offshore (Norton and Harwood 1985). Norton and Harwood (1985) found that the offshore groups ranged 5–50 km out. In July 1992, the aggregation encompassed more than 2500 km squared in the nutrient-rich waters off Cape Bathurst. Belugas in the near-shore areas of the Mackenzie River estuary were found with Arctic cisco, burbot and whitefish in their stomachs. Here, they are also known to feed on a variety of nekton including crustaceans, cephalopods and fishes (Moore 1997). Belugas elsewhere have also feed on invertebrates while in estuary (Vladykov 1947, Kleinenberg *et al.* 1969).

In general, the belugas diet varies greatly, likely after adapting in many different habitats, during summer and autumn migration, and at winter feeding sites.

Results for the Nelson River estuary (this study), concerning the feeding hypothesis, support the idea that belugas follow prey in and out of the Nelson River estuary. The fresh-saltwater mixing zone and the belugas were farther out in the Nelson River estuary during 2005. The movements of belugas in the Nelson River estuary during the summer of 2005 compared to the three previous years suggest that belugas choose to remain close to the mixing zone. The mixing zone, where gravity acts on density differences of freshwater and saltwater creating a convectional current, is often the most productive part of an estuary (Baker 1989). This convectional current stirs up sediment and benthic invertebrates, a known food choice of belugas. This cycle also provides food for fish such as capelin, whitefish, and arctic cod, which have been found in the stomachs of Western Hudson Bay belugas (Doan and Douglas 1953, Sergeant 1973). Several other marine predators show feeding behaviour related to tides. Zamon's (2001) findings relative to harbour seal (*Phoca vitulina richardsi*) predation on salmon with reference to tidal currents, for the San Juan Islands, revealed harbour seal movements between resting and foraging areas correlated with tidal phase (Zamon 2001). Seal abundance in the water during flooding tides was significantly greater than median daily abundance during 1995–97 (Zamon 2001). Seals also aggregated near a channel constriction (Zamon 2001). Both of these behaviours are similar to beluga behaviour in the Nelson River estuary during summer. For harbour seals, the median per capita capture rates were highest in currents during slower flooding. The results of Zamon (2001) support the hypothesis that interactions among tidal currents, topographic features, and fish play a role in structuring marine predator–prey dynamics.

III.6 PHYLOGENETIC INERTIA

Phylogenetic inertia describes the influence of an ancestor on its descendents, retaining traits unless altered by behavioural mutation (Dembski 2001). As a hypothesis explaining beluga summer use of the Nelson River estuary this means that they do because they and their ancestors always have. Beluga whales were thought to be closely related to Irrawaddy dolphins genetically and therefore placed in the same taxonomic family. The phylogenetic position of *Orcaella brevirostris* is now a topic of controversy. Irrawaddy dolphins were formerly grouped with true dolphins (*Delphinidae*) but research suggests the species is more closely related to narwhals and belugas (*Monodontidae*) than to delphinids (Kasuya 1973; Barnes *et al.* 1985; Lint *et al.* 1990 in Messenger 1998). Recent genetics data support the placement of Irrawaddy dolphin within *Delphinidae* (Messenger 1998). Moreover, the morphological data suggest that the Irrawaddy dolphin is actually the sister taxon to the remaining species of true dolphins rather than nested within the delphinid lineage. Finally, all whales listed above relate more closely to *Delphinidae* than do beaked whales (*Ziphiidae*) or Sperm whales (*Physeteridae*), among toothed whales (suborder *Odontoceti*) (Messenger 1998). Belugas and Irrawaddy dolphins (*Orcaella brevirostris*) both use freshwater resources, and appeared to be closely related genetically (Kasuya 1973; Barnes *et al.* 1985; Lint *et al.* 1990 in Messenger 1998). Thus, it was thought that belugas were motivated to use estuaries as an artifact of this relationship. Phylogenetic Inertia may explain the evolution of ineffective anti-predation behaviour for other aquatic species.

Effects of Phylogenetic Inertia exist elsewhere in marine ecosystems. The streamside salamander, (*Ambystoma barbouri*), exhibits ineffective anti-predation

behaviour and thus suffers heavy predation in streams with sunfish (*Centrarchidae*) (Sih 2000). This salamander evolved relatively recently from an ancestor that closely resembled a sister species, *A. texanum*, which breeds in fishless, temporary ponds. Sunfish thus represent a relatively new selection pressure for *A. Barbouri*. Phylogenetic inertia predicts that *A. texanum* should be very poor at avoiding sunfish relative to *A. barbouri*. As predicted, *A. texanum* suffered heavy sunfish predation. Compared to *A. texanum*, *A. barbouri* were more likely to initiate alarm moves that enhanced escape success from the sunfish fish. Moreover, in both the presence and absence of predators, *A. barbouri* showed higher emergence rates from refuge and higher movement while out of refuge compared to *A. texanum*, increasing exposure to sunfish. Conclusively, for these key behaviours, *A. barbouri* seems to have evolved in the wrong direction as far predation avoidance is concerned.

For Belugas, the opposite may be true. If the spring migration behaviour of belugas to estuaries is an anti predation tactic, the predation pressure does not appear to be proportional. Concerning Phylogenetic Inertia, this behaviour may be remnant from a time when densities of killer whales were higher throughout beluga habitat at higher latitudes. This would also explain reports of apparent irrational flight-response of belugas and narwhal to the presence of killer whales (G. Williams, NTI, Iqaluit pers. comm. 2006).

As for belugas being drawn to freshwater because of some distant ancestral relationship to Irrawaddy Dolphins, recent genetics evidence suggests that River dolphins are not distant ancestors of belugas but remnants of other ancient dolphin families (Cassens *et al.* 2000). Much of speculation about the origin and relationships of

belugas to River dolphins, including Irrawaddy dolphins, stems from a lack of fossil evidence (Hamilton 200?)

Figure II.7; Location by sex of beluga whales tagged with satellite transmitters across the Canadian Arctic 1993–2005, for, (left to right) Mackenzie estuary, Churchill River estuary, Nelson River estuary, Somerset Island, and Cumberland Sound. Green=Female, Blue=Male

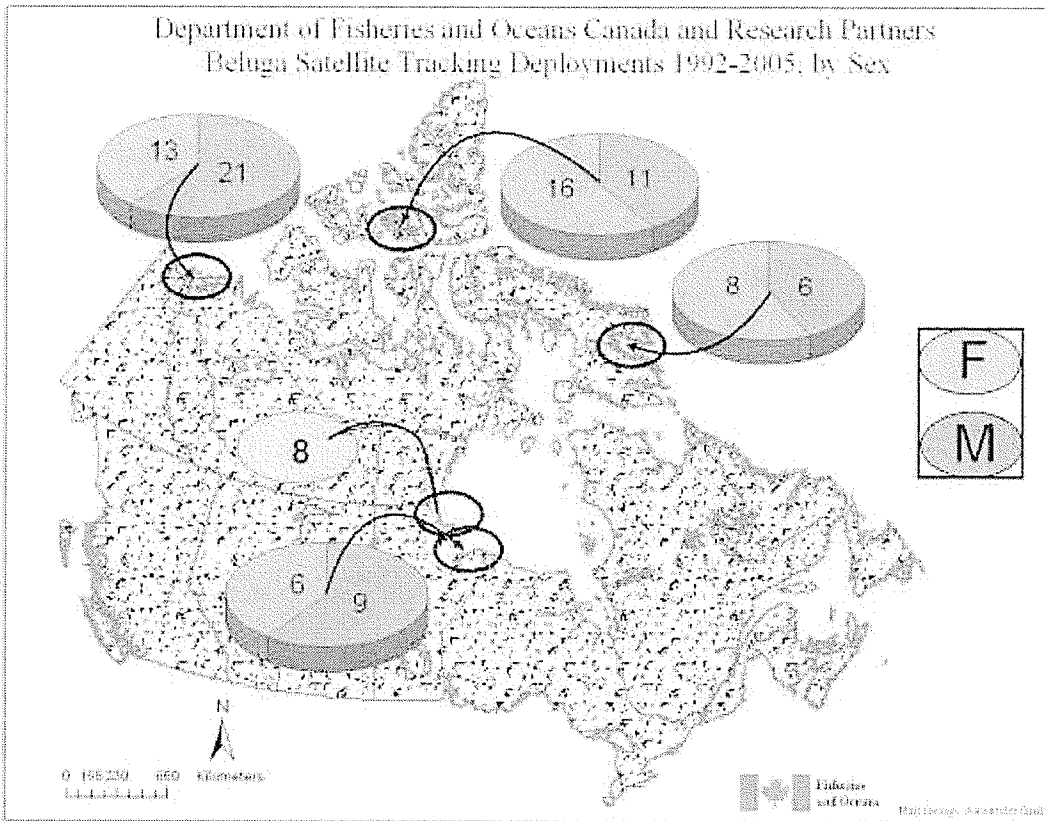

For figure II.7 (above) sex data for belugas captured in the Churchill River (N=8, 1992–1993) were not available when this figure was constructed. However, these data are now available (Martin and Smith; 1994, P. Hall Dept of Fisheries and Oceans, Winnipeg, pers. comm. 2007). Please see the Appendix section for more details.

CHAPTER IV: MAJOR FINDINGS AND GENERAL DISCUSSION

IV.1 MAJOR FINDINGS

Overall, a shift in beluga distribution is evident when comparing the distance to habitat features for the dry years of 2002–2004 and the wet year of 2005. Seven major findings as listed: 1) The Nelson River estuary extent, based on beluga radio-tracking data is larger and includes more coastline compared to the extents of past aerial surveys for belugas in this region, 2) Beluga-habitat use for all years was not random, based on a series of Kolmogorov-Smirnov statistical tests for aerial survey densities and radio-tracking data, 3) Belugas were farther away from the river mouth during the 2005, compared to the three previous dry years, 4) Coastal movements based on the radio-tracking data, did not differ significantly comparing the wet and dry years. 5) The aerial survey beluga densities reveal a stronger spatial association with channels during the dry years, 6) Higher aerial survey densities past 23 km away from river mouth for wet year using a log-transformed linear regression 7) Aerial survey beluga densities provided confirmatory evidence for the radio-tracking data analysis but are limited by differing data extents.

All of these findings have implications on management of belugas, with respect to the estuary-use hypotheses reviewed in Chapter III.

IV.1.1 Major Findings: The Shape of Nelson River Estuary

The Delineated Estuary vs. the Visible Freshwater Plume

Like most estuaries, the Nelson River estuary is constantly expanding and contracting as freshwater flows from upstream and saltwater is flushed in and out with the tides (Baker 1989; Mundy and Sydor 2006; Mundy *et al.* 2006; McCullough *et al.* 2006). Acknowledging the limitations of modelling complex hydrological systems, the shape of the estuary as defined by this study encompasses a larger region than what appears as the surface plume of fresh water visible through LANDSAT or MODIS imagery for the same period. The difference in shape of the defined estuary compared to the freshwater plume is based on the calculated beluga-habitat associations. The stratification of the fresh-saltwater may partly explain why belugas were farther out within the estuary compared to any visible freshwater reviewed on the imagery. Much research is currently being conducted on the hydrology of the Nelson River estuary. (Bernhardt 2004; Mundy and Sydor 2006; Mundy *et al.* 2006; McCullough *et al.* 2006). Accepting the limitations of this study, however, the highest densities of belugas based on the radio-telemetry data still appear to be beyond the surficial mixing line, suggesting that belugas in the Nelson River may not use the fresh water part of the estuary as extensively as observed for other estuaries such as Millut Bay or the Mackenzie River.

The Delineated Estuary vs. the Aerial Survey Limits

The estuary limit, as defined by the radio-telemetry data is also much larger than the extent of the aerial surveys. Thus, the observed aerial survey densities are limited in

their confirmatory capacity regarding any findings from radio-telemetry data. A region lacking in hydrologic and bathymetric data also exists extending from the aerial survey limit of 66 km east to the extent of the telemetry-defined estuary approximately 134 km along the south eastern coast of Hudson Bay.

Future study of this estuary, linking the hydrology and beluga-habitat associations will improve knowledge on precise relationships between belugas and the provisions of estuaries. The Nelson River estuary is a promising study case, as there is both hydrological and biological research is currently underway.

IV.2 ANTHROPOGENIC EFFECTS

Acute habitat loss related to industrial development, resulting in the direct displacement of wildlife, is often more visible than indirect habitat loss, caused for example by climate change or artificially altered water and sediment levels. Thus, studies measuring longer-term effects are often more difficult to design and costly to execute.

Moreover, the ability of a wild species to survive facing anthropogenic influences depends on many variables including its reproduction, social structure, and adaptability (Fair 2000). Belugas are long-lived, and have a low reproduction rate compared with most other animals (Stewart *et al.* 2006). Like other marine mammals, beluga also have highly developed social structures. The ability of belugas to adapt to changes in their environment is a topic of much speculation (Lawrence 1992, Kingsley 2002).

Prior to this study, the effects of hydroelectric development on the estuarine habitat of Western Hudson Bay belugas were largely unknown (Richard 1993). Kingsley (2002)

addresses this issue, concerning the difficulty in studying the effects of hydroelectric development on belugas. He states that “even in Arctic situations, with fewer confounding influences, it proved difficult to design definitive research studies on the down-stream effects of hydro dams on estuary use by belugas (Lawrence *et al.* 1992) so for various reasons this remains an unresolved question—but the Manicouagan banks are still unfrequented.” Such a study already exists for Eastern Hudson Bay belugas. Caron and Smith (1990) studied the effects of environmental conditions and human disturbances on the position of beluga groups in the Nastapoka River. They found that tide, wind, water temperature, and water clarity, in decreasing order of significance, affected the position of beluga groups within the estuary. This thesis demonstrates that similar variables may affect belugas using the Nelson River estuary.

Human efforts to divert and control the major rivers of the world result in erosion and reduction of deltas and the deterioration of their ecosystems (Stanley and Warne 1993; Leichenko and Wescoat 1993; Fradkin 1996 in Kowalewski *et al.* 2000). Very few studies however, describe the effects of water level changes to marine mammals. Similarly, the lack of knowledge on beluga estuary-use, and the apparent damage to pristine habitats from hydroelectric development is concerning (Sergeant 1975; Lawrence *et al.* 1990; Gosselin 2002; COSEWIC 2004). Belugas in the St. Lawrence River now occupy a small part of their former range (Vladykov 1944; Reeves and Mitchell 1984) and previously, there possibly were two populations of belugas there, one centered on the Saguenay River and the other on the Manicouagan River (Kingsley 2002). The Manicouagan River population was hunted heavily (Laurin 1982) and the damming of the river might have resulted in the disappearance of this population (COSEWIC 2004).

In dry years, hydroelectric dams must retain a larger percentage of the river to generate electricity in these years. This accentuated hydrological pulsing within an estuary forces change on local wildlife using that freshwater supply (Luecke *et al.* 1999). Since the 1930s, the Colorado River delta, which flows into the Gulf of California, is subject to damming and irrigation projects. The diversion of water from the Colorado River resulted in a substantial decrease of nutrient and sediment flow into the delta (Gulf of California) (Thompson 1968; Fradkin 1996). These actions triggered the collapse of the delta ecosystem, including the smallest known marine mammal, the vaquita (*Phocoena sinus*). This porpoise population is now reduced to a few hundred individuals (Luecke *et al.* 1999).

Other aquatic animals, such as Chinook salmon in the Fraser River, benefit from the shelter of turbid water. Gregory and Levings (1998) found that predation by piscivorous fish is reduced in turbid water of the Fraser River compared with the clearer water of the neighbouring Harrison River, located in British Columbia. Harrison River stocks of Pacific salmon (*Oncorhynchus* spp.) obligately pass through turbid and clear parts of these rivers during migration. Of 491 predators examined, 30 percent of Harrison River (clear) piscivores had recently consumed fish compared with only 10 percent of Fraser River (turbid) piscivores. However, in a clear-water side channel of the Fraser River both predation rate and number of fish prey per predator were similar to values for the clear waters of the Harrison River. Belugas may similarly benefit from the use of turbid water as a type of smoke screen to hide from predators. This study substantiates their affinity for the turbid waters of the fresh-saltwater mixing zone in the Nelson River

estuary. Thus, potential future problems may arise for belugas using the Nelson River if estuary sediment levels diminish.

IV.3 MAJOR LESSONS

This study only address a few aspects of beluga estuary-use, but as a stepping-stone for further research on the topic, it provides a platform to continue adding and weighing evidence for the underlying motivations for beluga estuary-use. Through this thesis, I have explored the history and progression of research on beluga whales. Belugas are well studied relative to other arctic species and marine mammals. Life history data for this species is limited compared to temperate and tropical marine mammals such as Bottlenose Dolphins (*Tursiops truncatus*) and Florida Manatees (*Trichechus manatus latirostrus*). Testing hypotheses for this species in the wild is challenging. Confounding factors and lack of context often create confusion and doubts concerning what belugas require (Lawrence *et al.* 1992, Kingsley 2002).

IV.4 RESEARCH PROBLEMS AND LIMITATIONS

Arctic research is costly and complicated. Remoteness, extreme weather, and lack of sunlight during winter are just a few of the difficulties facing Arctic researchers. Environmental data for northern research can be difficult to find, if available at all. Fortunate for this study, Manitoba Hydro is conducting extensive research in the Nelson River estuary for a proposed upstream dam, which provided the bulk of the data for this study. A major limit regarding data availability was the lack of suitable bathymetry data

to coincide with the radio-telemetry data. Nevertheless, I acknowledge that bathymetry data can be extremely costly to collect, and therefore consider any available data as a bonus.

Radio-tracking and aerial survey data vary in many ways, including data sampling and modeling. Each data-type has its own set of caveats and sources of error. Comparing telemetry data to aerial survey observation can be an involved and complicated process. Some tests, such as repeated measures, work with large sample size and objective sampling such as aerial survey transects. Others, such as Kernel methods work well with radio-tracking data yet are not suitable for aerial survey counts, where locations of the sightings are uniformly spaced. For a more detailed description of Kernel PDE methods, see section V.2.1 'Kernel Probability Density Estimation Methods'. Density surfaces for the aerial survey sightings were mapped using Inverse Distance Weighting (IDW) methods (figure II.14)

IV.5 RECOMMENDATIONS FOR FUTURE RESEARCH

More research on the beluga-estuary-use hypotheses is required. Studies such as the acoustic network, currently under development by the Orcas of the Canadian Arctic (OCA) research group, will help further the current knowledge of killer whale abundance and distribution in the eastern Canadian Arctic, providing evidence to weigh predation avoidance as a reason for beluga estuarine occupation. Future research should also combine the results of similar studies in other Hudson Bay estuaries, including the Churchill River and James Bay, as these estuaries share similar beluga populations where Eastern Hudson Bay belugas and Western Hudson Bay belugas share portions of their seasonal ranges and demonstrate some signs of mixing (de March *et al.* 2002).

IV.5 FINAL THOUGHTS

The beluga whale is a relatively well-studied animal. However, there is still considerable speculation about beluga summer use of estuaries, and a corresponding lack of tested evidence. The bulk of the observations leading to the estuary-use theories were collected *in-situ*. With few exceptions (Hansen 1987; Caron and Smith 1990), beluga estuary-use hypotheses were not tested using the scientific method, creating the impetus for this study.

An underlying question of this study is whether the Nelson River estuary nutritionally supports tens of thousands of whales or whether belugas only forage opportunistically while there, as they also appear to do in the Churchill River (Doan and Douglas 1953; Sergeant 1973). Results of radio-tracking studies suggest that the bulk of Western Hudson Bay beluga foraging takes place in and around Hudson Strait. Compared to the Nelson and Churchill River estuary, Hudson Strait is a much more productive zone in terms of secondary production and potential prey species for belugas. Belugas have also been recorded to be much fatter after winter (Butorin 1966 in Ognetrov 1990). It is more likely that belugas feed while occupying the Nelson River estuary, while taking advantage of the shelter from predation, but do not seek out the estuary to fill the bulk of their nutritional needs. The Nelson River is farthest, geographically; from killer whales enter Hudson Bay through Hudson Strait. Clearwater Fiord is farthest and most remote from the mouth of Cumberland Sound. Beluga seasonal distribution may be an adaptation to avoid killer whale predation (Sergeant *et al.* 1975). Recent evidence of more killer whales in Hudson Bay (Higdon *et al.* 2006) may also influence the beluga by altering

their predator avoidance strategies, and thus their habitat usage. Alternatively, the site tenacity exhibited by belugas may leave them at a great disadvantage as killer whale range expands, possibly farther into south western Hudson Bay.

Climate change will play a large role in future of beluga whales in Canada. Predicted increases in river outflows resulting in larger freshwater plumes and larger corresponding fresh-saltwater mixing zones will likely influence belugas in the Nelson River estuary. In combination with human demand for hydroelectric energy, the future state of the Nelson River estuary is unclear. These changes to the beluga environment may have effects on foraging, reproduction and risk of predation. Appropriate beluga management is possible with an understanding of what belugas require to live. Currently there are still many unknowns for this species and life history data are most lacking. Further study is required to decipher reoccurring patterns that persist over potentially anomalous behaviour captured in snapshots. The continued health of beluga whale populations and the people who rely on them as a food source depends upon it.

REFERENCES

Smith A.J. Beluga Whale (*Delphinapterus leucas*) Use of the Nelson River Estuary, Hudson Bay

ARGOS® 1989. Guide to the ARGOS® System. Toulouse: CLS/Service ARGOS®.

ARGOS® 1996. User's Manual. Toulouse: CLS/Service ARGOS®.

Austin, J.D., I. McMillan, and W.D. Bowen. (2003) A Three-Stage Algorithm For Filtering Erroneous ARGOS® Satellite Locations. *Marine Mammal Science* 19:371–383

Baird, R.W. 1999. Status of Killer Whales in Canada. Contract report to the Committee on the Status of Endangered Wildlife in Canada. Ottawa.

Baker, R.F. 1989. An environmental assessment and biological investigations of the Nelson River estuary. A report prepared for Manitoba Hydro by North/South Consultants Inc., Winnipeg, MB, Canada. 179 p.

Barrett-Lennard, L.G., Heise, K., Saulitis, E., Ellis, G. & Matkin, C. (1995) The Impact of Killer Whale Predation on Steller Sea Lion Populations in British Columbia and Alaska, p. 77. University of British Columbia, Fisheries Centre, Vancouver, British Columbia, Canada.

Bernhardt, W.J. 2004. Beluga Abundance And Distribution In The Nelson River Estuary 2003 Lower Nelson River Aquatic Studies. Draft Report # 04-05 for Manitoba Hydro

Boltunov, A.N., and Belikov, S.E. (2002) Belugas (*Delphinapterus leucas*) of the Barents, Kara, and Laptev seas. *NAMMCO Sci. Publ.* 4:149–168

Brennin, R., B.W. Murray, M.K. Friesen, D. Maiers, J.W. Clayton, and B.N. White. (1997) Population genetic structure of beluga whales (*Delphinapterus leucas*):

Smith A.J. Beluga Whale (*Delphinapterus leucas*) Use of the Nelson River Estuary, Hudson Bay

mitochondrial DNA sequence variation within and among North American populations. *Can. J. Zool.* 75:795–802

Brodie, P.F. (1967) The biology of the beluga, *Delphinapterus leucas* Pallas of Cumberland Sound, Baffin Island, MSc thesis, McGill University, Montreal. iii + 55 p. + appendices.

Brodie, P.F. (1970) Life history of the white whale, *Delphinapterus leucas* (Pallas) in the waters of Baffin Island, Canada. PhD thesis, Department of Biology, Dalhousie University, Halifax. 127 + v p.

Brodie, P.F. (1971) A reconsideration of aspects of growth, reproduction, and behaviour of the white whale (*Delphinapterus leucas*), with reference to Cumberland Sound, Baffin Island, population. *Journal of the Fisheries Research Board of Canada* 28:1309–1318

Brown, D.H., and K.S. Norris. (1956) Observations of Captive and Wild Cetaceans. *Journal of Mammalogy* 37:311–326

Brown-Gladden, J.G., M.M. Ferguson, and J.W. Clayton. (1997) Matriarchal genetic population structure of North American beluga whales, *Delphinapterus leucas*, (Cetacea: Monodontidae). *Molecular Ecology* 6:1033–1046

Byers, T., and L.W. Roberts (1995) Harpoon and Ulus: Collective wisdom and traditions regarding the beluga (*qilalugaq*) in the Mackenzie River estuary. Unpublished Report to the Department of Indian and Northern Affairs (Arctic Environmental Strategy) and the Joint Management Committee, Inuvik. 76p.

British Oceanographic Data Centre, Natural Environment Research Council. General Bathymetric Charts of the Oceans (GEBCO). 2000.

Smith A.J. Beluga Whale (*Delphinapterus leucas*) Use of the Nelson River Estuary, Hudson Bay

Butorin, D.A (1966) Gde zimuyet belukha. Rybnoye khoziaistvo [Where do belugas winter? Fishery] 1:28–29 (In Russian)

Canada Nunavut Geoscience Office. 2003. Nunavut Geoscience Sampler Compact Disk

Caron, L.M.J., and T.G. Smith (1990) Philopatry and site tenacity of beluga,

Delphinapterus leucas, hunted by the Inuit at the Nastapoka estuary, eastern

Hudson Bay, p.69–79. In T.G. Smith, D. J. St. Aubin, and J.R. Geraci [ed.]

Advances in research on the beluga whale, *Delphinapterus leucas*. Can. Bull. Fish.

Aquatic Science 224

Cassens, I., Vicario S., V. G. Waddell, H. Balchowsky, D. Van Belle, W. Ding, C. Fan,

R. S. Lal Mohan, P.C. Simões-Lopes, R. Bastida, A. Meyer, M. J. Stanhope, and M.

C. Milinkovitch. 2000. Independent adaptation to riverine habitats allowed survival

of ancient cetacean lineages PNAS 97: 11343-11347

Condy, P.R., R.J. Van Ararde, and M.N. Bester (1978) The seasonal occurrence and

behaviour of killer whales, *Orcinus orca*, at Marion Island. Journal of Zoology,

London 184:449-464

Consultative Group for International Agriculture Research (CGIAR), CGIAR-CSI. 2003.

Shuttle Radar Topography Mission (SRTM) 90-meter Digital Elevation Data

Corkeron, P.J. and R.C. Connor. (1999) Why Do Baleen Whales Migrate? Marine

Mammal Science 15:1228–1245

Cosens, S.A. (2002) Cumberland Sound Beluga. Department of Fisheries and Oceans

Canada Science Stock Status Report E5-32 (2002).

COSEWIC, Beluga Whale Stock Assessment Summary. 2004.

Smith A.J. Beluga Whale (*Delphinapterus leucas*) Use of the Nelson River Estuary, Hudson Bay

de March, B.G.E., L.D. Maiers (2001) Stock discrimination of belugas (*Delphinapterus leucas*) hunted in eastern Hudson Bay, northern Quebec, Hudson Strait, and Sanikiluaq (Belcher Islands), using mitochondrial DNA and 15 nuclear micro-satellite loci, Fisheries and Oceans Canada Science, Research Document 20001/50

de March, B.G.E., L.D. Maiers, and M.K. Freisen. (2002) An Overview of genetic relationships of Canadian and adjacent populations of belugas (*Delphinapterus leucas*) with emphasis on Baffin Bay and Canadian eastern Arctic populations. NAMMCO Sci. Publ. 4:17–38

Dembski W.A. (2001). If Not Natural Selection? A review of Steven Hecht Orzack and Elliott Sober, [eds], Adaptationism and Optimality, in Cambridge Studies in Philosophy and Biology (New York: Cambridge University Press, 2001), 416 pages

Doidge, D.W. (1990)a Integumentary heat loss and blubber distribution in the beluga (*Delphinapterus Leucas*), with comparisons to the narwhal, (*Monodon monoceros*). Can. Bull. Fish. Aquatic Sci. 224:129 –140

Doidge, D.W. (1990)b Population dynamics of beluga whales. PhD. Thesis, Department of Renewable Resources, McDonald College, McGill University, Montreal, Quebec, Canada. 189 p.

Doidge, DW; Finley, K.J. (1993) Status of the Baffin Bay population of Beluga, *Delphinapterus Leucas*. Canadian field-naturalist 107:533–546

Eberhardt, L.L. (1978) Transect methods for population studies. J. Wildl. Manage. 42:1–31.

Fair, P.A. and Paul R. Becker (2000) Review of stress in marine mammals. Journal of Aquatic Ecosystem Stress and Recovery 7:335–354

Smith A.J. Beluga Whale (*Delphinapterus leucas*) Use of the Nelson River Estuary, Hudson Bay

Feltz, E.T., and Fay, F.H. (1966) Thermal Requirements in vitro epidermal cells from seals. *Cryobiology* 3:261–264

Ferguson, S. H., and P.C. Elkie. (2005) Use of Lake Areas in winter by Woodland Caribou. *Northeastern Naturalist* 12(1):45–66

Finley, K.J., and Renaud, W.E. (1980) Marine mammals inhabiting the Baffin Bay North Water in winter. *Arctic* 33(4):724–738

Finley, K.J. (1982) The estuarine habit of belugas or white whales, *Delphinapterus leucas*. *Cetus* 4:4–5

Finley, KJ, G.W. Miller, RA Davis and CR Greene (1990) Reactions of belugas, *Delphinapterus leucas*, and narwhals, *Monodon monoceros*, to ice-breaking ships in the Canadian High Arctic. *Canadian Bulletin of Fisheries and Aquatic Science* 224

Fisheries and Oceans Canada. (2000) Eastern Beaufort Sea Beluga. Department of Fisheries and Oceans Canada Science Stock Status Report. E5-38 (2000).

Fisheries and Oceans Canada. (2001) Northern Quebec (Nunavik) Beluga (*Delphinapterus leucas*). Department of Fisheries and Oceans Canada Science Stock Status Report E4-01 (2001).

Fisheries and Oceans Canada. (2002)a. Cumberland Sound Beluga. Department of Fisheries and Oceans Canada Science Stock Status Report E5-32 (2002).

Fisheries and Oceans Canada. (2002)b. Underwater World. Revised by Pierre Richard, Published by Communications Directorate Fisheries and Oceans Canada. DFO/6080 UW/6

Ford, J.K. b. (1988) Acoustic behaviour of resident killer whales (*Orcinus orca*) off Vancouver Island, British Columbia. *Can. J. Zool.* 67:727–745

Smith A.J. Beluga Whale (*Delphinapterus leucas*) Use of the Nelson River Estuary, Hudson Bay

Fradkin, P. (1996) A river no more: Los Angeles, University of California Press, 360 p.

Fisheries Research 12:139–156

Fraker, M.A., C.D. Gordon, J.W. McDonald, J.K.B. Ford and G. Cambers. (1979) White

whale (*Delphinapterus leucas*) distribution and abundance and the relationship to physical and chemical characteristics of the Mackenzie Estuary. Fisheries and

Marine Service Technical Report 863:56

Freeman, M.M.R. (1968) Winter observations on beluga (*Delphinapterus Leucas*) in

Jones Sound, N.W.T. Canadian Field-Naturalist 82: 276–286

Frost, K.J., R.B. Russell and L.F. Lowry (1992) Killer whales (*Orcinus orca*) in the south

eastern Bering Sea: Recent sightings and predation on other marine mammals.

Marine Mammal Science 8:110–119

Fyfe, J.C., G.J. Boer And G.M. Flato (1999) The Arctic and Antarctic Oscillations And

Their Projected Changes Under Global Warming. Geophysical Research Letters

26:1601–1604

Gaston, Anthony J., Hipfner, J. Mark & Campbell, Doug (2002) Heat, and mosquitoes

cause breeding failures and adult mortality in an Arctic-nesting seabird. Ibis 144

(2), 185–191

Gittleman, J.L and S. D. Thompson (1988). Energy Allocation in Mammalian

Reproduction. American Zoologist 28(3):863-875

Geraci, J.R., N.G. Palmer, and D.J. St. Aubin (1987) Tumours in cetaceans: analysis and

new findings. Can. J. Fish. Aquatic Sci. 44:1289–1300

Geraci J.R. and V.J. Lounsbury (2005) Marine Mammals Ashore: A Field Guide for

Strandings

Smith A.J. Beluga Whale (*Delphinapterus leucas*) Use of the Nelson River Estuary, Hudson Bay

Gosselin, J.F., Veroniques Lesage, Mike O. Hammill and Hugo Bourdages (2002)

Abundance indices of beluga in James Bay and Ungava Bay *during summer* 2001.

Fisheries and Oceans Canada Research Document 2002/042.

Gurevich, V. S. (1980) Worldwide distribution and migration patterns of the white whale

(beluga), *Delphinapterus leucas*. Rep. Int. Whal. Comm. 30:465–480

Hammill, M.O., M.C.S. Kingsley, and D. Lesage (2003) Cancer in beluga from the St.

Lawrence Estuary, Quebec, Canada. Environmental Health Perspectives 111:A77–

A78

Harwood, L. A., S. Innes, P. Norton, and M. C. S. Kingsley (1996) Distribution and

abundance of beluga whales in the Mackenzie estuary, southeast Beaufort Sea, and

west Amundsen Gulf during late July 1992. Can. J. Fish. Aquat. Sci. 53: 2262–2273

Harwood, L. A., P. Norton, B. Day, and P. A. Hall (2002). The Harvest of Beluga Whales

in Canada's Western Arctic: Hunter-Based Monitoring of the Size and Composition

of the Catch ARCTIC 55: 1:10–20

Hay, K. (2000) Final report of the Inuit bowhead knowledge study. Published by Nunavut

Wildlife Management Board, P. O. Box 1379, Iqaluit, and Nunavut. X0A 0H0.

Hansen D.V., and Maurice Rattray, Jr. (1966) New Dimensions in Estuary Classification

Limnology and Oceanography 11:319–326

Heath, M.E., and S.H. Ridgway (1999) How dolphins use their blubber to avoid heat

stress during encounters with warm water. Am J Physiol Regul Integr Comp

Physiol 276, Issue 4, R1188–R1194

Smith A.J. Beluga Whale (*Delphinapterus leucas*) Use of the Nelson River Estuary, Hudson Bay

- Heide-Jørgensen, M.P., Richard, P.R. & Rosing-Asvid, A. (1998) Dive patterns of belugas (*Delphinapterus leucas*) in waters near eastern Devon Island. *Arctic* 51:17–26
- Heide-Jørgensen, M.P. and Oystein Wiig (2002) Belugas in the North Atlantic and the Russian Arctic. *NAMMCO Sci. Publ.* 4:9–15
- Higdon, J.W., W. Bernhardt, M. Chambellant, E. Chmelnitsky, and S.H. Ferguson (2006) Are killer whales (*Orcinus orca*) increasing in Hudson Bay? Poster presented at Third ArcticNet Annual Scientific Meeting, December 12–15, 2006, Victoria, British Columbia, Canada.
- Hinzman, L.D. and Douglas L. Kane (1992) Potential response of an Arctic watershed during a period of global warming. *Journal of Geophysical Research* 97:2811– 2820
- Hoyt, E. (1990) Orca, the whale called killer. 3rd Edition. Camden House. Canada.
- Hodges, J. L.. (1955) A Bivariate Sign Test *The Annals of Mathematical Statistics*, Vol. 26:3:523-527
- Innes, S. and Stewart, R.E.A. (2002) Population size and yield of Baffin Bay beluga (*Delphinapterus leucas*) stocks. *NAMMCO Sci. Publ.* 4:225–238
- Innes, S., Heide-Jørgensen, M.P., Laake, J.L., Laidre, K.L., Cleator, H.J., Richard, P. and Stewart, R.E.A. (2002)b Surveys of belugas and narwhals in the Canadian High Arctic in 1996. *NAMMCO Sci. Publ.* 4:169–190
- Kilabuk, P. (1998) A Study of Inuit knowledge of the southeast Baffin beluga. Published by Nunavut Wildlife Management Board, P. O. Box 1379, Iqaluit, Nunavut. X0A 0H0.

Smith A.J. Beluga Whale (*Delphinapterus leucas*) Use of the Nelson River Estuary, Hudson Bay

- Kingsley, M, C. (2000) Numbers and distribution of beluga whales, *Delphinapterus leucas*, in James Bay eastern Hudson Bay, and Ungava Bay in Canada during the summer of 1993. Fish Bulletin 98:736–747
- Kingsley, M.C.S. (2002) Status of the belugas of the St. Lawrence estuary, Canada. NAMMCO Sci. Publ. 4:239–258
- Kleinenberg, S.E., Yablokov, A.V., Bel'kovich, B.M., & Tarasevich, M.N. (1969) Beluga (*Delphinapterus Leucas*): Investigation of the Species. Translation, Published Originally in Russian in 1964. Jerusalem: Israel Program For Scientific Translations
- Laurin, J. (1982) La chasse au béluga, *Delphinapterus leucas*, du Saint-Laurent et le statut actuel de la population. Carnet Zoologique 42: 23–27
- Leatherwood, J.S., D.K. Caldwell, and H. E. Winn. (1976) Whales, Dolphins and Porpoises of the Western North Atlantic. NOAA TR NMFS Clrc-396, 1972 pp.
- Leichenko, R.M., and Wescoat, J.L. (1993) Environmental impacts of climatic change and water development in the Indus delta region: International Journal of Water Resources Development 9:247–261
- Luecke, D.F., Pitt, J., Congdon, C., Glenn, E., Valdés- Casillas, C., and Briggs, M. (1999) A delta once more: Washington, D.C., Environmental Defence Fund Publications, 51 p.
- Lowry, L. F. (1985) The belukha whale (*Delphinapterus leucas*). Pp. 3–13, In J. J. Burns, K. J. Frost, and L. F. Lowry (eds.), Marine mammal species accounts. Alaska Dep. Fish and Game, Game Tech. Bull. 7.

Smith A.J. Beluga Whale (*Delphinapterus leucas*) Use of the Nelson River Estuary, Hudson Bay

Manitoba Geographic Names Program. 2001. Manitoba Geographical Names Toponymic Data Layer, <http://www.gov.mb.ca/ia/capreg/metadata.html>)

McConnell, B.J; Chambers, C; Nicholas, KS; Fedak, MA. (1992) Satellite tracking of grey seals (*Halichoerus grypus*). *Journal of Zoology* 226:271–282

McCullough, G.M. Granskog, P. Collin and D.G. Barber. 2006. Fluvial loading of suspended solids and dissolved organic matter to Hudson Bay via the Churchill and Nelson-Hayes estuaries. ArcticNet Theme 3.1. Poster presented at second annual ArcticNet annual meeting in Victoria, Canada. Dec 11-16th, 2006

Marko, J.R., and Fraker, M.A. (1981) Spring ice conditions in the Beaufort Sea in relation to bowhead whale migration. Arctic Sciences Ltd. and LGL Ltd. for the Alaska Oil and Gas Association. University Library, University of Calgary, Calgary, AB T2N 1N4, Canada.

Martin, A.R., and Smith, T.G. (1992) Deep diving in wild, free ranging beluga whales, *Delphinapterus Leucas*. *Can. J. Fish. Aquat. Sci.* 49:462–466

Martin, A.R., Smith, T.G., and Cox, O.P. (1993) Studying the behaviour and movements of High Arctic belugas with satellite telemetry. *Symp. Zool. Soc. Lond.* No. 66:195–210

Martin, A. R., T. G. Smith, and O. P. Cox. (1998) Dive form and function in belugas *Delphinapterus leucas* of the eastern Canadian High Arctic. *Journal of Polar Biology* 20, Number 3

Martin, A.R. and T.G. Smith (1999) Strategy and capability of wild belugas, *Delphinapterus leucas*, during deep, benthic diving. *Can. J. Zool.* 77:1783–1793

Smith A.J. Beluga Whale (*Delphinapterus leucas*) Use of the Nelson River Estuary, Hudson Bay

Martin, A.R., and R.R. Reeves. (2000) Status of *Monodontid* whales. Report of the Int.

Whal. Comm. Scientific Committee. Annex I. J. Cetacean Res. Manage. 2: 243–251.

Martin, A.R., P. Hall and P. R. Richard (2001) Dive behaviour of belugas

(*Delphinapterus leucas*) in the shallow waters of western Hudson Bay. Arctic 54:276–283

Martineau, D., K. Lemberger, A. Dallaire, P. Labelle, T. P. Lipscomb, P. Michel, and I.

Mikaelien. (2002) a Cancer in wildlife , a case study: Beluga from the St. Lawrence Estuary, Quebec. Canada Environmental Health Perspectives 10: 285–292.

Matkin, C.O., and E. L. Saulitis (1994) Killer Whale (*Orcinus Orca*) Biology and

Management in Alaska. Final Report for Marine Mammal Contract T75135023.

Ntis Pb95-166203, U.S. Department Of Commerce, Springfield, Va. 46 P.

Mitchell E, Reeves RR (1981) Catch history and cumulative catch estimates of initial

population size of cetaceans in the eastern Canadian Arctic, Reports of the International Whaling Commission, 31:645–682

Moore, S.E. and D.P. DeMaster (1997) Cetacean Habitats in the Alaskan Arctic. J.

Northw. Atl. Fish. Sci. 22:55–69

Muir, D.C.G, Ford, C.A., Stewart, R.E.A., Smith, T G., Addison, R F., Zinck, M. E. and

Béland, P. (1990) Organochlorine contaminants in belugas, *Delphinapterus leucas*,

from Canadian waters. In: Advances in research on the beluga whale,

Delphinapterus leucas. T.G. Smith, D.J. St. Aubin and J.R. Geraci (eds). Can.

Smith A.J. Beluga Whale (*Delphinapterus leucas*) Use of the Nelson River Estuary, Hudson Bay

- Mundy, C.J, and K.M Sydor. 2006 The Nelson River Estuary Study: A focus for the Manitoba Hydro-ArcticNet partnership. Talk presented at Third ArcticNet Annual Scientific Meeting, December 12–15, 2006, Victoria, British Columbia, Canada.
- Mundy, C.J, M. Granskog, D.G. Barber, A. Hare, G. Stern, R. Bukowsky, K. Sydor and W. Bernhardt. 2006. A long-term biophysical study of the Nelson and Hayes Rivers and their impact on coastal and marine processes in Hudson Bay. Poster presented at Third ArcticNet Annual Scientific Meeting, December 12–15, 2006, Victoria, British Columbia, Canada.
- National Aeronautics and Space Administration (NASA). 2002. Shuttle Radar Topography Mission (SRTM) Elevation Data (meters, 90m grid)
- Norton, P., and Harwood. L.A. (1985) White whale use of the south eastern Beaufort Sea, July–September 1984. Can. Tech. Rep. Fish. Aquatic Science 1401
- Nunavut Wildlife Management Board. 2000. Final Report Of The Inuit Bowhead Knowledge Study, Nunavut, Canada.
- O'Corry-Crowe GM, Dizon AE, Suydam RS, Lowry LF. (2002). Molecular genetic studies of population structure and movement patterns in a migratory species: the beluga whales (*Delphinapterus leucas*), in the western Arctic. In Molecular and Cell Biology of Marine Mammals (C.J. Pfeiffer, ed.). Kreiger Publishing Co., Malabar. Pp 53–64.
- Ognetov, G. N. (1990) Changes in the body condition of white whales (*Delphinapterus leucas*). In the White and Kara Seas, 1977–1985. Rep. Int. Whaling Comm. 40:477-479

Smith A.J. Beluga Whale (*Delphinapterus leucas*) Use of the Nelson River Estuary, Hudson Bay

Pearse, J, and Ralph Buchsbaum, (1987). Living Invertebrates, The Boxwood Press.

SBN: 0-86542-312-1;

Perez, M.A. (1990) Review of marine mammal population and prey information for

Bering Sea ecosystem studies. NOAA Tech. Memo. NMFS F/NWC-186.

Peterson, B.J., Robert M. Holmes, James W. McClelland, Charles J. Vorosmarty, Richard

B. Lammers, Alexander I. Shiklomanov, Igor A. Shiklomanov, and Stefan

Rahmstorf (2002) Increasing River Discharge to the Arctic Ocean. Science 298,

2171

Reeves, R.R. and E. Mitchell (1984) Catch history and initial population size of white

whales, *Delphinapterus leucas*, in the river and gulf of the St. Lawrence, eastern

Canada. Naturalist Can. 111:63–121

Reeves, R.R. and E. Mitchell (1988) Distribution and seasonality of killer whales in the

eastern Canadian Arctic. Rit Fiskideildar 11:136–160

Rendell, L. and Hal Whitehead (2001) Culture in whales and dolphins. Behavioural and

Brain Sciences 24:309–382

Rice, D. W. (1998) Marine mammals of the world: Systematics and distribution, Soc.

mar. Mamm. Spec. Publ. 4

Richard, P.R., J.R. Orr, and D. G. Barber (1990) The distribution and abundance of

beluga, *Delphinapterus leucas*, in eastern Canadian subArctic waters: a review and

update. Can. Bull. Fish. Aquat. Sci. 224:23–38

Richard, P. R. (1990) Status of the beluga, *Delphinapterus leucas*, of Southeast Baffin

Island, Northwest Territories. Canadian Field-Naturalist 105:206–214

Smith A.J. Beluga Whale (*Delphinapterus leucas*) Use of the Nelson River Estuary, Hudson Bay

- Richard, P. R. (1993) Status of the beluga, *Delphinapterus leucas*, in western and southern Hudson Bay. *Can. Field-Nat.* 107:524–532
- Richard, P. R., Orr, J. R., Dietz, R., and Dueck, L. (1998)a. Sightings of belugas and other marine mammals in the North Water, late March 1993. *Arctic* 51(1):1–4.
- Richard, P. R., Heide-Jørgensen, M. P. and St. Aubin, D. (1998) Fall movements of beluga (*Delphinapterus leucas*) with satellite-linked transmitters in Lancaster Sound, Jones Sound, and northern Baffin Bay. *Arctic* 51:5–16
- Richard, P. R. [ed.], 2000. Stock Status Report E5–38. 2000. Eastern Beaufort Sea Beluga Whales. Report for Fisheries and Oceans Canada.
- Richard, P. R. [ed.], 2000. Stock Status Report E4–01. 2001. Northern Quebec (Nunavik) Beluga (*Delphinapterus leucas*). Report for Fisheries and Oceans Canada, Laurentian Region.
- Richard, P. R., Heide-Jørgensen, M. P., Orr J. R., Deitz R. and Smith T.G. (2001) Summer and Autumn Movements and Habitat Use by Belugas in the Canadian High Arctic and Adjacent Areas. *Arctic* 54: 3: 207–222
- Richard, P.R. [ed.], 2002a. Stock Status Report E5–32. 2002. Cumberland Sound Beluga. Report for Fisheries and Oceans Canada.
- Richard, P.R. [ed.], 2002b. Underwater World: Belugas, Fisheries and Oceans Canada, Science.
- Richard, P.R., Orr, J.R., and Heide-Jørgensen, M. P. 2003. Beluga Whale Autumn and Early Winter Use of Cumberland Sound, Baffin Island, Canada. Draft Paper for Polar Biology.

Smith A.J. Beluga Whale (*Delphinapterus leucas*) Use of the Nelson River Estuary, Hudson Bay

Richard, P.R. [ed.], 2005. Stock Status Report, 2005. An estimate of the Western Hudson Bay beluga population size in 2004. Report for Fisheries and Oceans Canada.

Research Document 2005/017

Ridgway, S.H., Harrison, R. Handbook of Marine Mammals, Volume 6: The Second Book of Dolphins and Porpoises p 281–322.

Rugh, D.J., Muto, M.M., Moore, S.E., and DeMaster, D.P. 1999. Status review of the eastern North Pacific stock of Gray whales. NOAA Technical Memorandum NMFS-AFSC-103. 96 pp.

St. Aubin, D. J., T. G. Smith, and J.R Geraci. 1990. Seasonal epidermal moult in beluga whales, *Delphinapterus leucas*. Can. J. Zool. 58: 359–367.

Saulitis, E., C. Matkin, L. Barrett-Lennard, K. Heise and G. Ellis. 2000. Foraging strategies of sympatric killer whale (*Orcinus orca*) populations in Prince William Sound, Alaska. Marine Mammal Science 16:94–109.

Schmitt, R. J. 1987. Indirect Interactions Between Prey: Apparent Competition, Predator Aggregation, and Habitat Segregation. Ecology, Vol. 68, No. 6, pp. 1887–1897

Seaman, G.A., and J.J. Burns. 1981. Preliminary results of recent studies of Belukhas in Alaskan water. Rept. Internat. Whaling Comm., 31:567–574

Seaman, G.A., L.F. Lowry, and K.J. Frost. 1982. Foods of *belukha* whales (*Delphinapterus leucas*) in Western Alaska. Cetology 44: 1–19.

Seaman, D. E. and Powell, R. A. 1996. An evaluation of the accuracy of Kernel density estimators for home range analysis. Ecology 77: 2075–2085.

Sergeant, D.E. 1973. Biology of white whales (*Delphinapterus leucas*) in western Hudson Bay. J. Fish. Res. Board Can. 30:1065–1090.

Smith A.J. Beluga Whale (*Delphinapterus leucas*) Use of the Nelson River Estuary, Hudson Bay

Sergeant, D.E. 1986. Sea mammals. In Canadian inland seas. Edited by I.P. Martini.

Elsevier Science Publishers B.V., Amsterdam, The Netherlands pp. 327–340

Netherlands. pp. 327?340.

Sergeant, D.E., P.F. Brodie. 1975. Identity, abundance, and present status of populations

of white whales, *Delphinapterus leucas*, in North America. J. Fish. Res. Board Can.

32: 1047–1054.

Shelden, K.E., and Rugh, D.J., 2003. Killer Whale Predation on belugas in Cook Inlet,

Alaska: Implications for a Depleted Population. Marine Mammal Science, 19(3):

529–544 (July 2003).

Sih, A, L.Kats and E Maurer (2000). Does phylogenetic inertia explain the evolution of

ineffective anti-predator behaviour in a sunfish-salamander system? Behav Ecol

Sociobiol (2000) 49:48–56

Shumilak, B.E. 1993. Lower Nelson River dynamic river modeling. Manitoba Hydro

Power Supply Planning Report.

Smith, T.G., and M.O. Hammill. 1986. Population estimates of the white whale,

Delphinapterus leucas, in James Bay, eastern Hudson Bay and Ungava Bay. Can. J.

Fish. Aquat. Sci. 43: 1982–1987.

Smith, T.G., St. Aubin, D.J., and Hammill, M.O. 1992. Rubbing behaviour of belugas,

(*Delphinapterus leucas*) in a high Arctic estuary. Can. J. Zool. 70: 2405–2409.

Smith, T.G., and A. R. Martin. 1994. Distribution and movements of belugas,

Delphinapterus leucas, in the Canadian High Arctic. Can. J. Fish. Aquat. Sci. 51:

1653–1663.

Smith A.J. Beluga Whale (*Delphinapterus leucas*) Use of the Nelson River Estuary, Hudson Bay

Smith, A.J. Beluga Whale (*Delphinapterus leucas*) use of Cumberland Sound Estuaries, Baffin Island Canada. 2004. A report prepared for The Department of Fisheries and Oceans, Arctic Research Division, October, 2004.

Sokal, R.R., and Rohlf, F.J. 1981. Biometry. New York: W.H Freeman and Company

Soper, J. D. A faunal investigation of southern Baffin Island. National Museum of Canada Bulletin 53. 143 pp.

Stanley, D.J., and Warne, A.G., 1993, Nile delta: Recent geological evolution and human impact: Science, v. 260, p. 628–634.

Stewart, B. E. and R. E. A. Stewart. 1989. *Delphinapterus leucas*. Mammalian Species, Am. Soc. of Mamm., 336: 1–8.

Stewart, D.B., Savard, T. 2003. An overview of the ecology of Cumberland Sound, Baffin Island, Nunavut, Draft report, for Canada Department of Fisheries and Oceans.

Stewart, R.E.A., S.E. Campana, C.L. Jones, and B.E. Stewart. 2006. Bomb radiocarbon dating calibrates beluga (*Delphinapterus leucas*) age estimates. Can. J. Zool. 84: 1840–1852.

Thompson, R.W., 1968, Tidal flat sedimentation on the Colorado River delta, north western Gulf of California: Geological Society of America Memoir, 107, 133p.

Tynan, C.T. and Douglas P. Demaster. 1997. Observations And Predictions Of Arctic Climatic Change: Potential Effects On Marine Mammals Arctic. Vol. 50, No. 4 (December 1997) P. 308–322

U.S. EPA, 2001. Estuaries: National Treasures (A narrated multi-media CD describing estuaries). www.epa.gov/owow/estuaries/ Hall, J. Project Lead

- Vladykov, V.D. 1944. Études sur les mammifères aquatiques. III. Chasse, biologie et valeur économique du marsouin blanc ou béluga (*Delphinapterus leucas*) du fleuve et du golfe du Saint-Laurent. Dép. Pêch. Pro. Qué. 194 pp.
- Vladykov, V.D. 1947. Etudes sur les mammifères aquatiques IV. Nourriture du marsouin blanc ou beluga (*Delphinapterus leucas*) du fleuve Saint-Laurent. Contribution de l'Institut de biologie generale et de zoologie. No 19, 160p. + 40 figure + 28 tables.
- Q.J.A. Khan, B.S. Bhatt, and R.P. Jaju, 1998. Switching Model with Two Habitats and a Predator Involving Group Defense. Journal of Nonlinear Mathematical Physics, V.5, N 2, 212–223.
- Williams, T.M. J.A. Estes, D.E. Doak, and A.M. Springer. 2004. Killer appetites: Assessing the role of predators in ecological communities. Ecology 85(12): 3373–3384.
- Wildlife Computers Inc. 1997. SPLASH User Guide. 2004. Redmond Washington. 41 pp.
- Wildlife Computers, Inc. 2003. SATPAK version 2003. Redmond Washington. 41 pp.
- Zamon, J.E. 2001. Seal predation on salmon and forage fish schools as a function of tidal currents in the San Juan Islands, Washington, USA. Fisheries Oceanography Volume 10 Page 353, Volume 10 Issue 4

PERSONAL COMMUNICATIONS AND UNPUBLISHED DATA

1. K. J. Gaston Biodiversity and Macroecology Group, Department of Animal and Plant Sciences, University of Sheffield, Sheffield, England, pers. comm., 2006,
2. S. Ferguson, Department of Fisheries and Oceans, Winnipeg, pers. comm., 2004
3. B. Doidge, Makivik Corporation, Montreal, Quebec, pers. comm. 2005. 2005
4. J. Orr, Department of Fisheries and Oceans, Winnipeg, pers. comm., 2004
5. P. Richard, Department of Fisheries and Oceans, Winnipeg, pers. comm., 2004
6. H. Funk, North South Environmental Consulting, Winnipeg, Manitoba, pers. comm., 2004
7. M. Martz, Florida Fish and Wildlife Conservation Commission, St. Petersburg, Florida, pers. comm., 2004
8. M. Barlas, Florida Fish and Wildlife Conservation Commission, St. Petersburg, Florida, pers. comm., 2004
9. J. Higdon, Orcas of the Canadian Arctic, Winnipeg, Manitoba, pers. comm., 2006
10. G. Lundie, SeaNorth tours, Churchill, Manitoba, pers. comm., 2006
11. L. Loseto, University of Manitoba, Winnipeg, Manitoba, pers. comm., 2005

APPENDIX

Since belugas using the Churchill River Estuary belong to the same population as those using the Nelson River Estuary, I have included details of belugas fitted with radio-transmitters at Churchill River Estuary. While not central to the focus of this study, it may provide valuable information for future study of Western Hudson Bay belugas.

Table V.1. Details on the 8 belugas captured and fitted with radio tags at the Churchill River estuary in the summers of 1992–93. (Source: Martin and Smith 1994, P. Hall, Department of Fisheries and Oceans, Canada, Winnipeg, Manitoba, pers. comm. 2005)

| Capture Location | Capture Date | Tag No. | Sex | Length (cm) | Description | Age Class | Tag longevity (Days) | Notes |
|------------------|--------------|----------|-----|-------------|-------------|-----------|----------------------|-----------|
| Churchill River | 4-Jul-1992 | 10215_92 | M | 330 | – | – | 22 | – |
| Churchill River | 5-Jul-1992 | 5803_92 | M | 328 | – | – | 32 | – |
| Churchill River | 5-Jul-1992 | 7277_92 | M | 361 | – | – | 30 | – |
| Churchill River | 5-Jul-1992 | 7278_92 | M | 391 | – | – | 45 | – |
| Churchill River | 29-Jul-1993 | 5800_93 | M | 373 | White | adult | 56 | – |
| Churchill River | 29-Jul-1993 | 5801_93 | F | 340 | Light | grey | 48 | with calf |
| Churchill River | 30-Jul-1993 | 5803_93 | F | 325 | Light | grey | 31 | with calf |
| Churchill River | 29-Jul-1993 | 5805_93 | M | 411 | White | adult | 47 | – |

Tracking data for all tagged belugas in the Nelson River estuary for 2002–2005 are included hereafter, to provide a synoptic view of migrations and habitat use.

Table V.3; Retained locations: Radio-tracking sample details for ARGOS® 3-stage filter on two belugas captured during 2002, 2003 in the Nelson River estuary (N=1993)

| Location Class (LC) | LC frequency | % of sample |
|---------------------|--------------|-------------|
| 3 | 28 | 1.4 |
| 2 | 99 | 5.0 |
| 1 | 271 | 13.6 |
| 0 | 326 | 16.4 |
| A | 358 | 18.0 |
| B | 650 | 32.6 |
| Z | 18 | 0.9 |
| | 1750 | 87.8 |

Figure V.2; Retained locations: Radio-tracking sample details for ARGOS® 3-stage filter on two belugas captured during 2002, 2003 in the Nelson River estuary (N=1993). Values for each pie are in percent

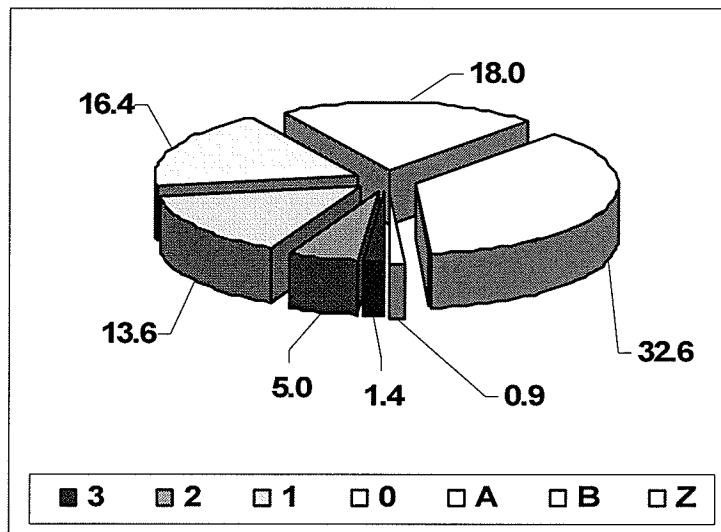

Table V.4; Rejected locations: Radio-tracking sample details for ARGOS® 3-Stage filter on two belugas captured during 2002,2003 in the Nelson River estuary (N=1993)

| Location Class (LC) | LC frequency | % of sample |
|---------------------|--------------|-------------|
| 3 | 6 | 0.3 |
| 2 | 24 | 1.2 |
| 1 | 47 | 2.4 |
| 0 | 48 | 2.4 |
| A | 61 | 3.1 |
| B | 55 | 2.8 |
| Z | 1 | 0.1 |
| | 242 | 12.2 |

Figure V.3; Rejected locations: Radio-tracking sample details for ARGOS® 3-stage filter on two belugas captured during 2002,2003 in the Nelson River estuary (N=1993). Values for each pie are in percent

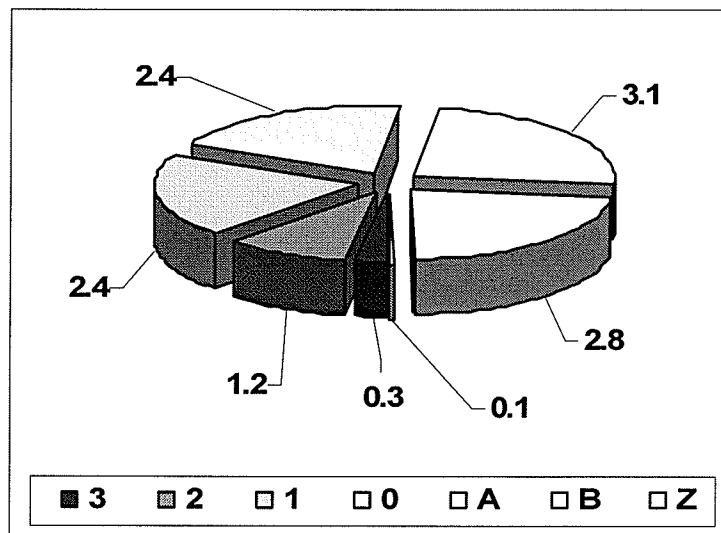

Figure V.4; Nelson River beluga radio-tracking data for Adult Female, TAG NO. = 10927, Captured on July 14, 2002— Inset of Hudson Bay and extent of radio-tracking data for this beluga

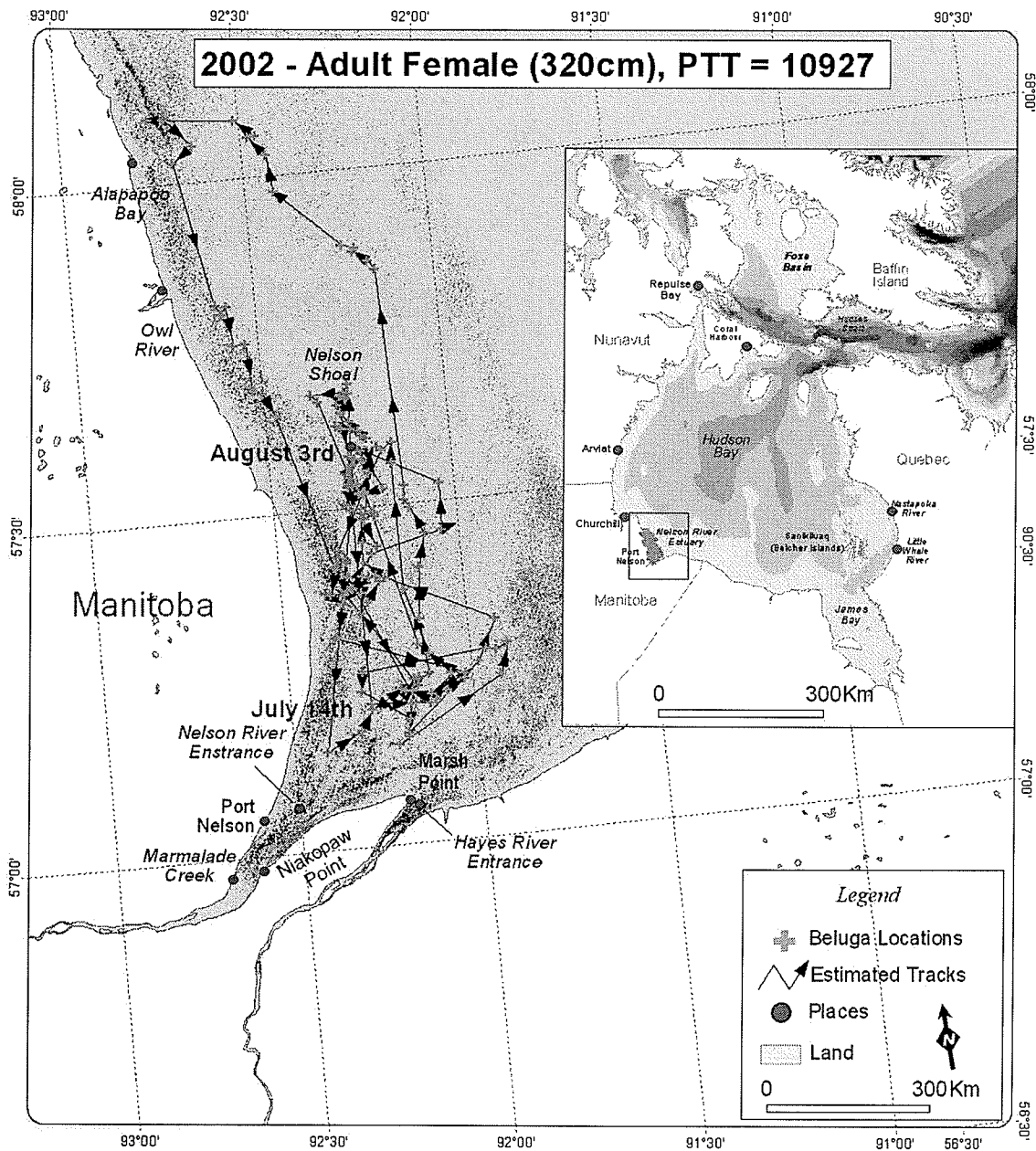

Figure V.5; Nelson River beluga radio-tracking data for Adult Male, TAG NO. = 10971, Captured on July 31, 2003

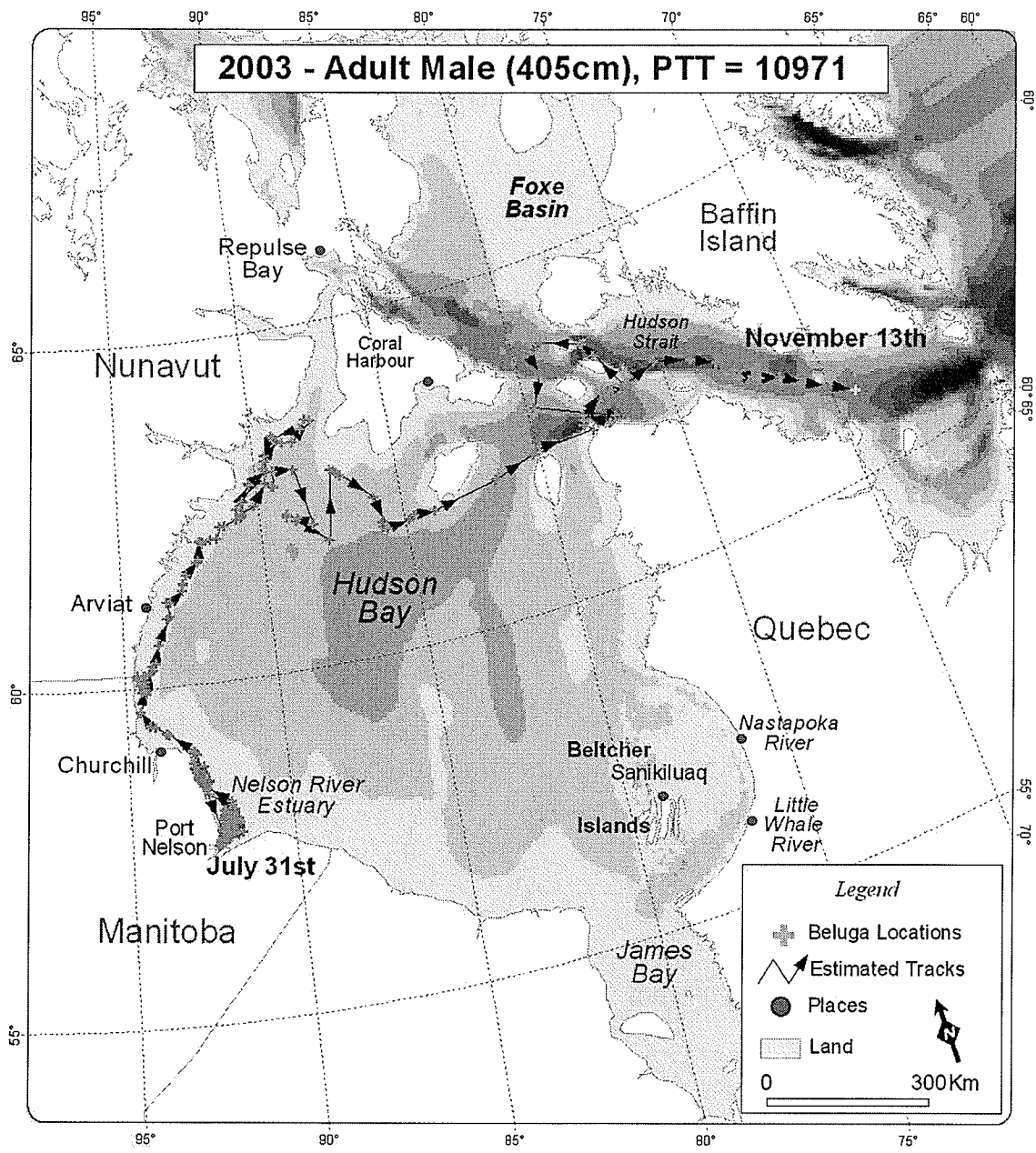

Figure V.5b; Nelson River beluga radio-tracking data for Adult Male, TAG NO. = 10971, Captured on July 31, 2003—Zoom of Nelson River Estuary and usage by this beluga

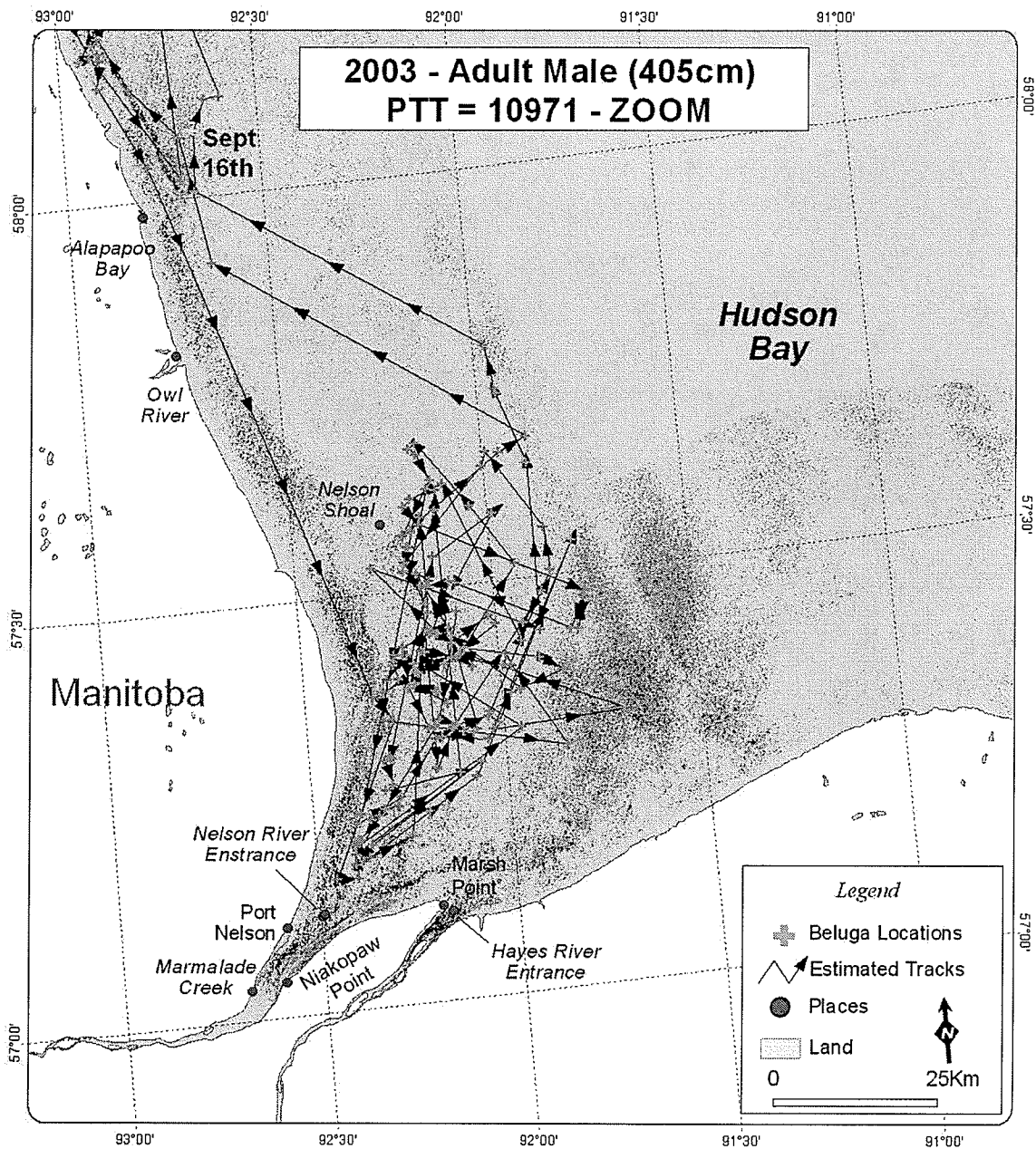

Figure V.6; Nelson River beluga radio-tracking data for Adult Female, TAG NO. = 10972, Captured on July Aug 4, 2003

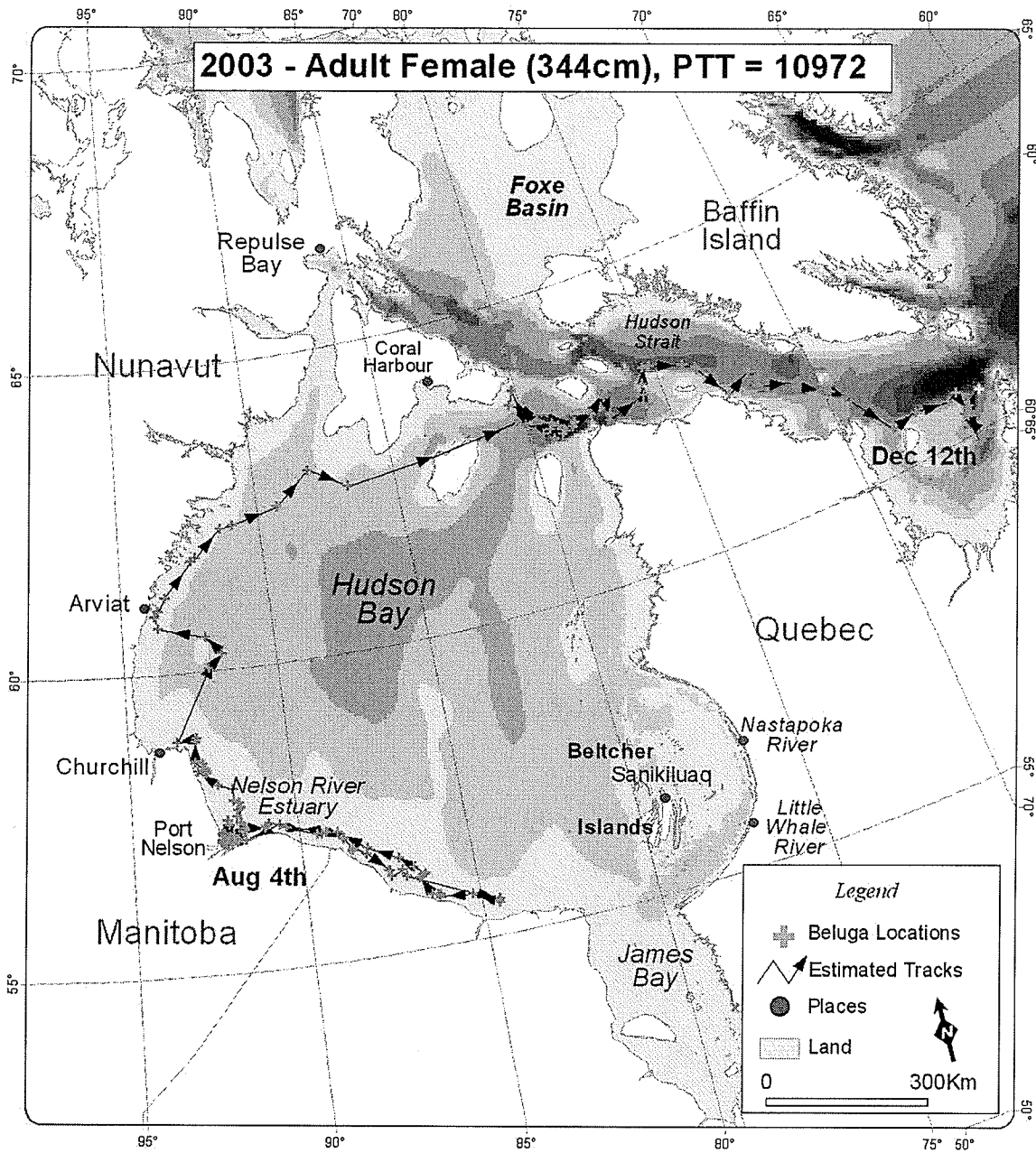

Figure V.6b; Nelson River beluga radio-tracking data for Adult Female, TAG NO. = 10972, Captured on July Aug 4, 2003—Zoom of Nelson River Estuary and usage by this beluga

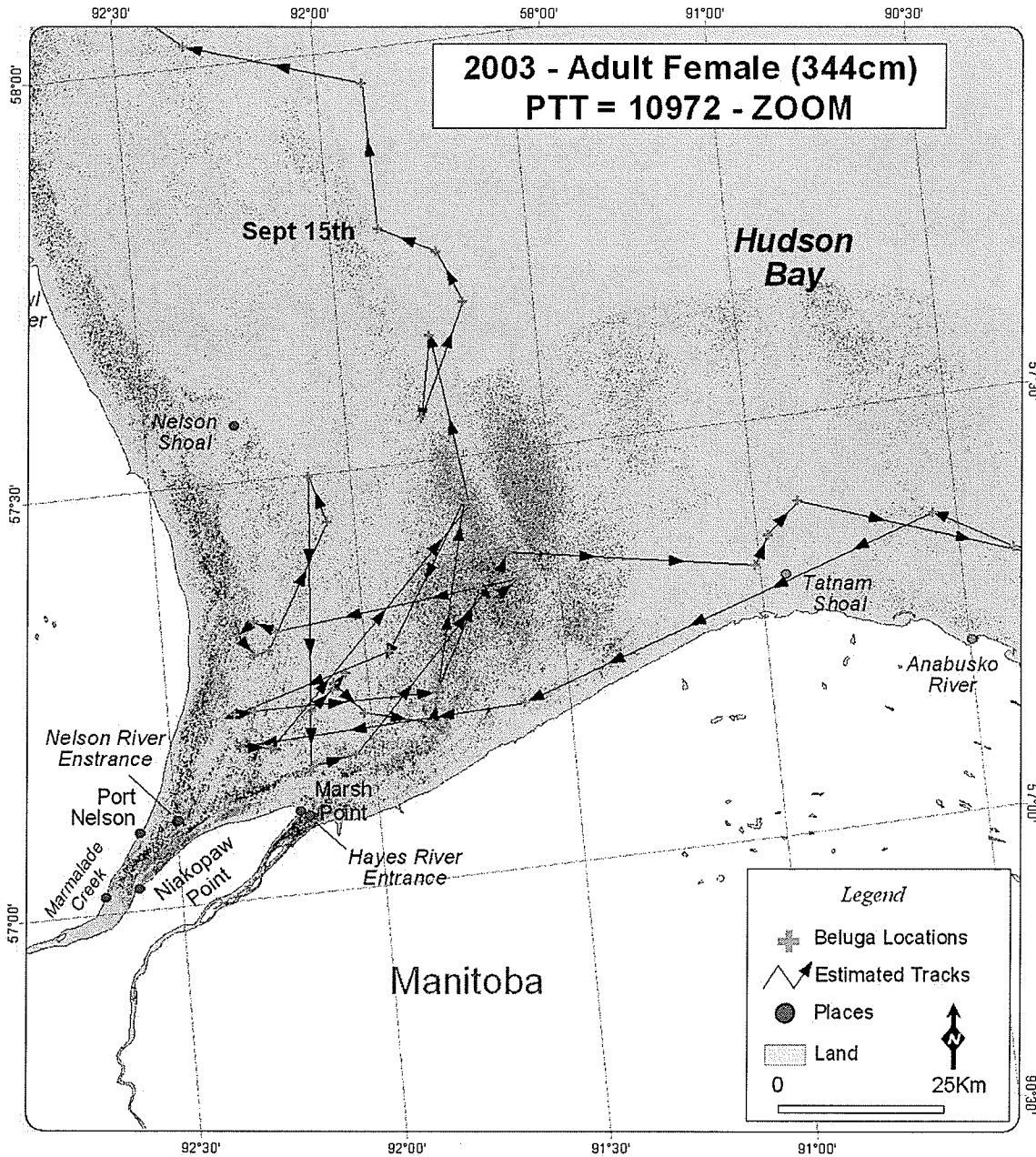

Figure V.7; Nelson River beluga radio-tracking data for Adult Female, TAG NO. = 10926, Captured on August 5, 2003

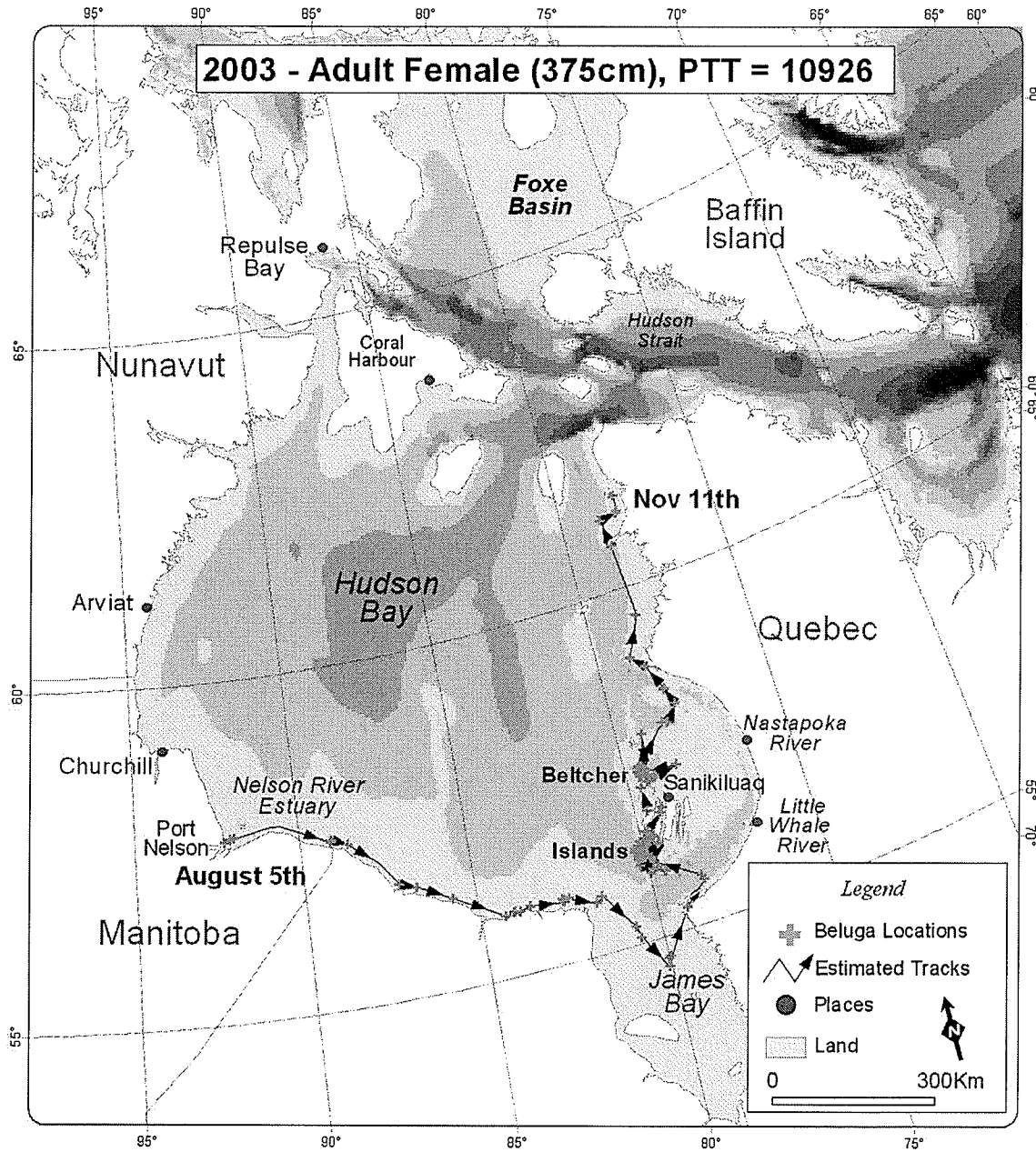

Figure V.7b; Nelson River beluga radio-tracking data for Adult Female, TAG NO. = 10926, Captured on August 5, 2003—Zoom of Nelson River Estuary and usage by this beluga

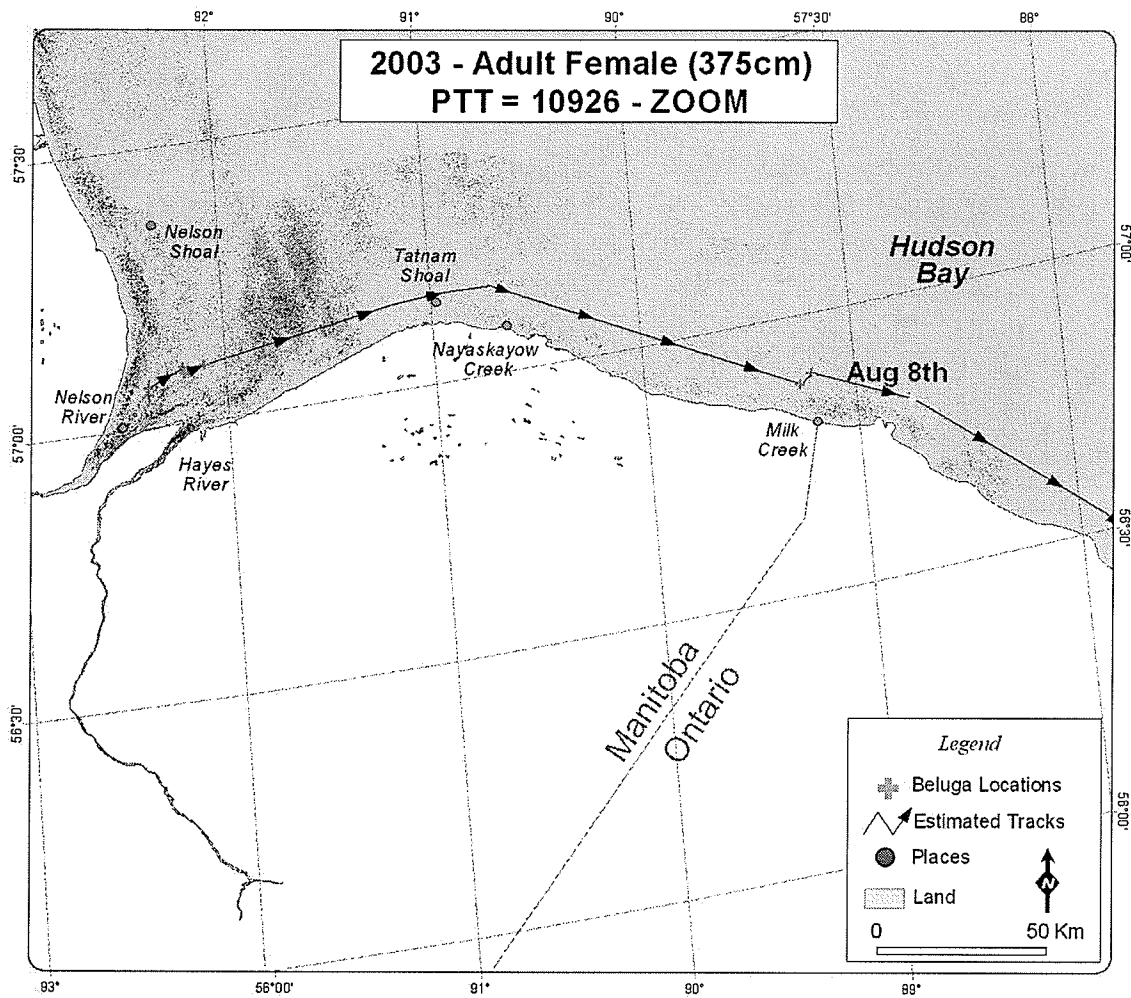

Figure V.8; Nelson River beluga radio-tracking data for Adult Male, TAG NO. = 10899, Captured on August 7, 2003

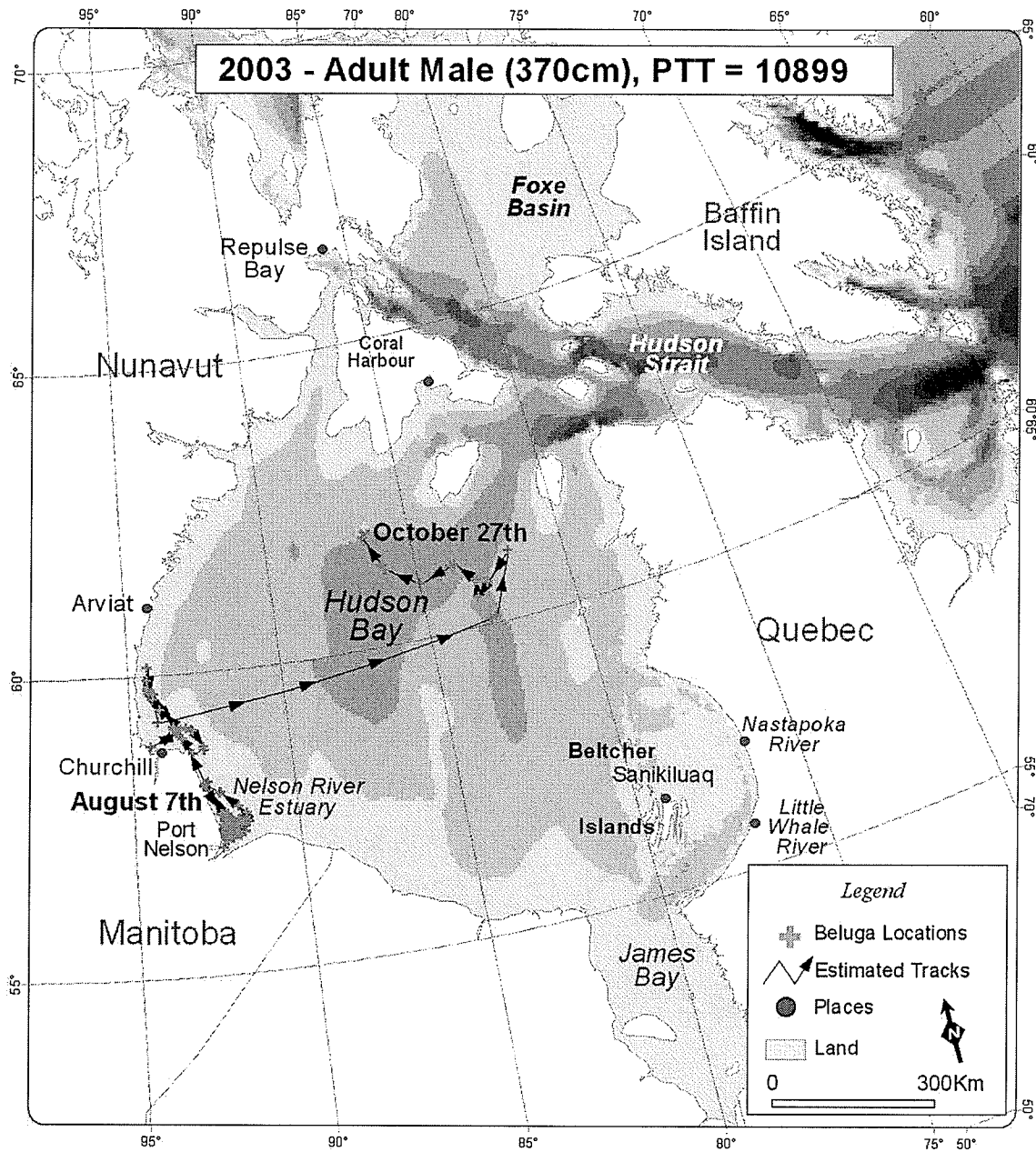

Figure V.8b; Nelson River beluga radio-tracking data for Adult Male, TAG NO. = 10899, Captured on August 7, 2003—Zoom of Nelson River Estuary and usage by this beluga

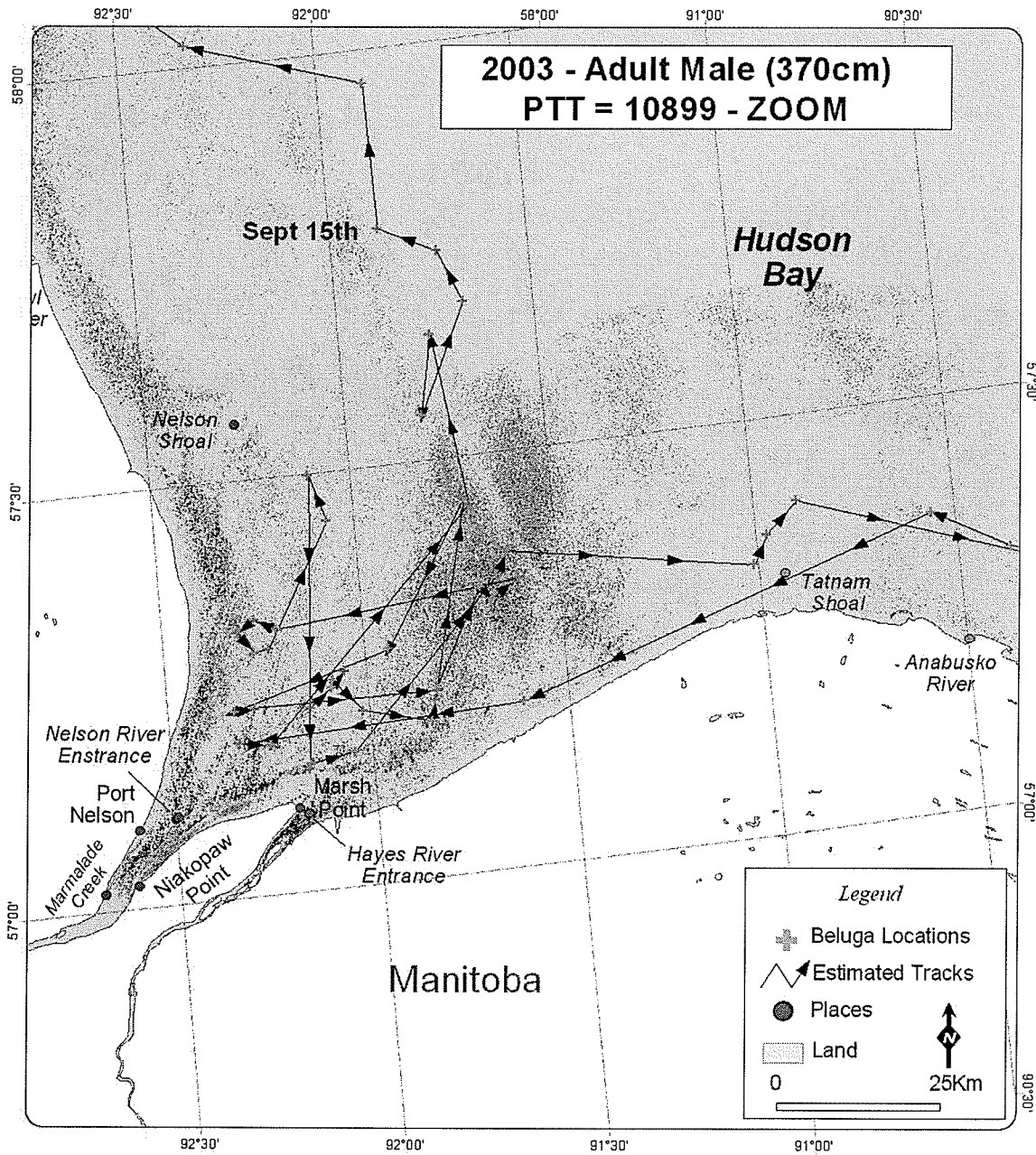

Figure V.9; Nelson River beluga radio-tracking data for Adult Male, TAG NO. = 10970, Captured on August 5, 2003

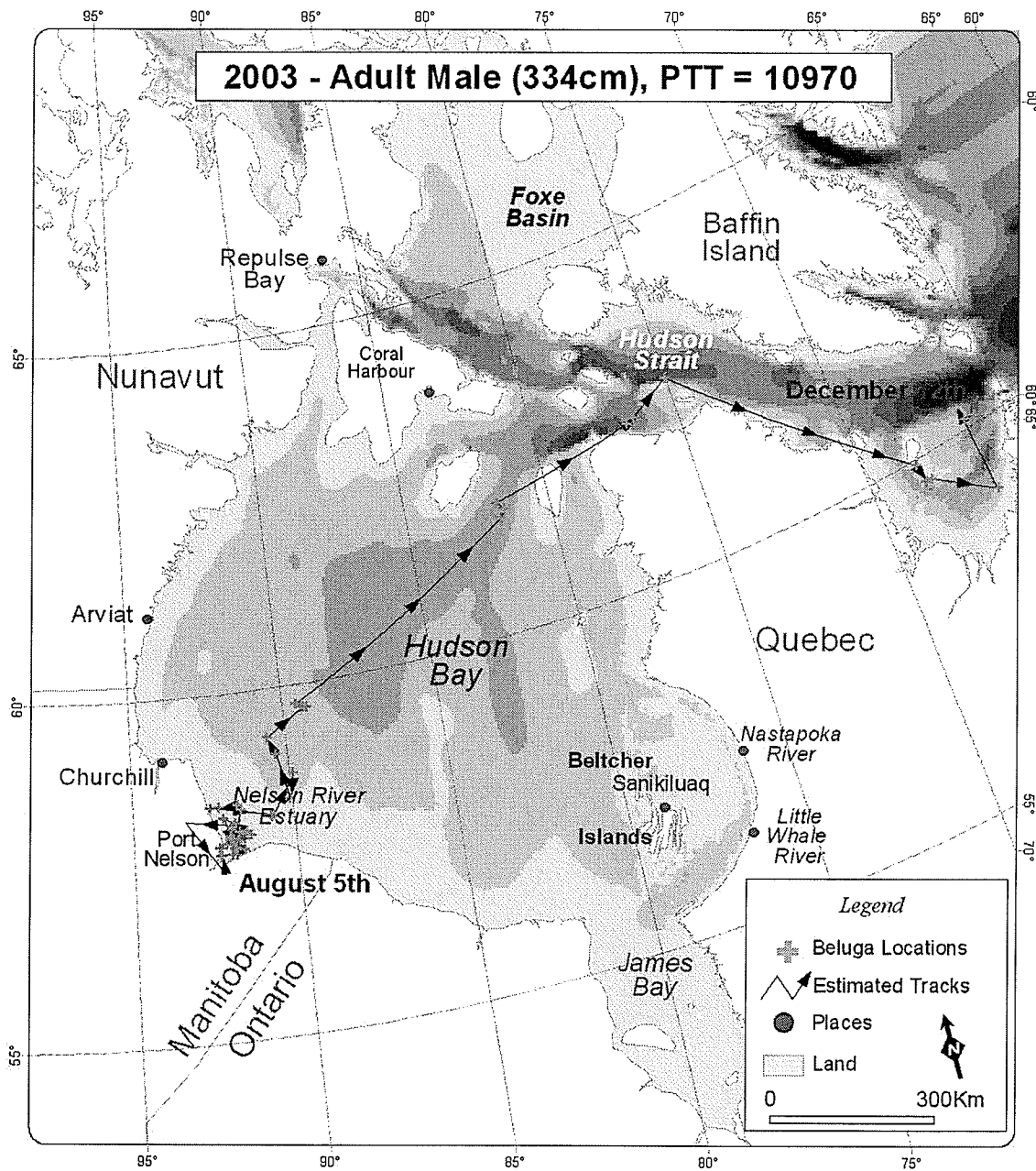

Figure V.9b; Nelson River beluga radio-tracking data for Adult Male, TAG NO. = 10970, Captured on August 5, 2003—Zoom of Nelson River Estuary and usage by this beluga

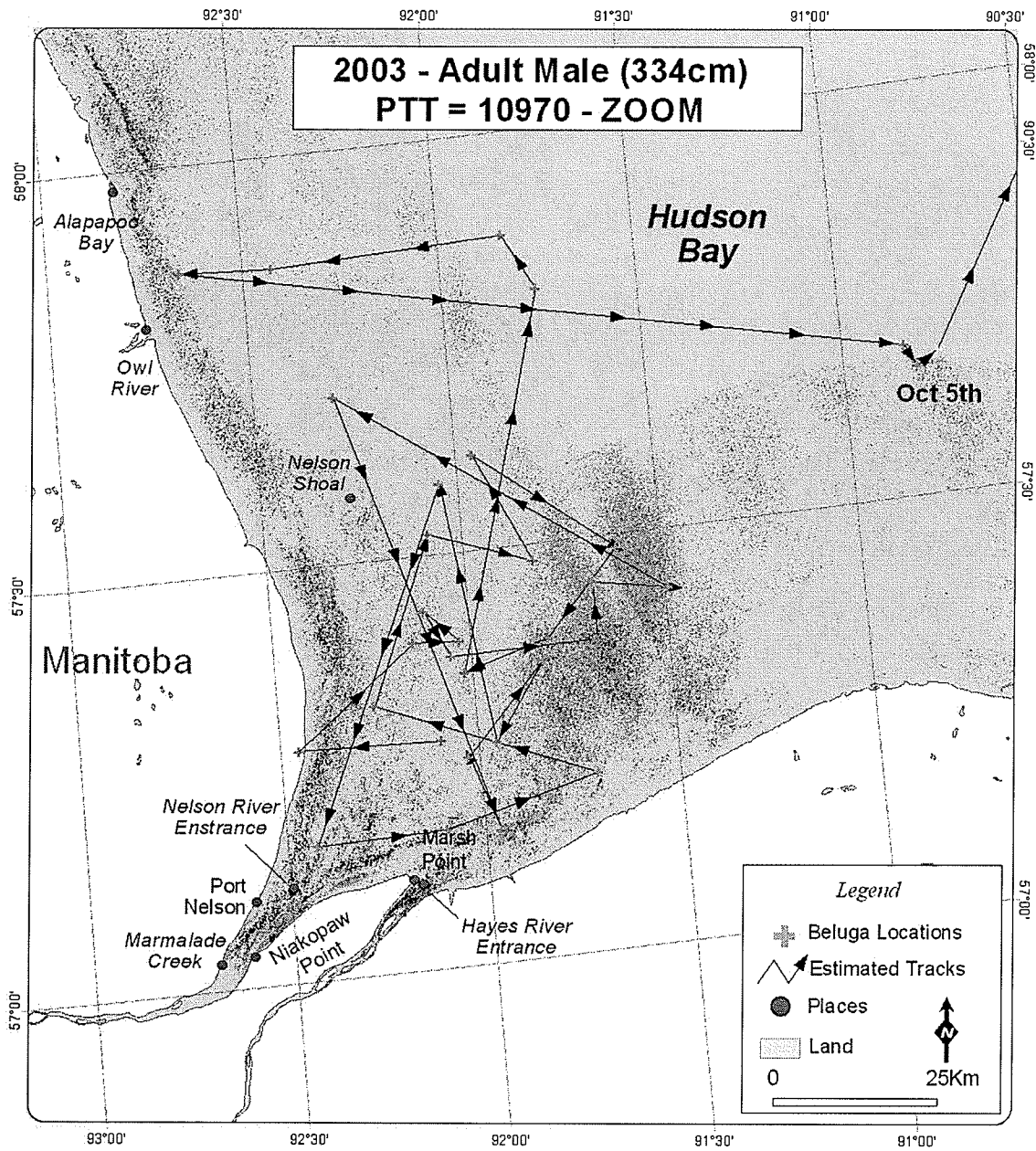

Figure V.10; Nelson River beluga radio-tracking data for Adult Male, TAG NO. = 10979, Captured on July 24, 2004

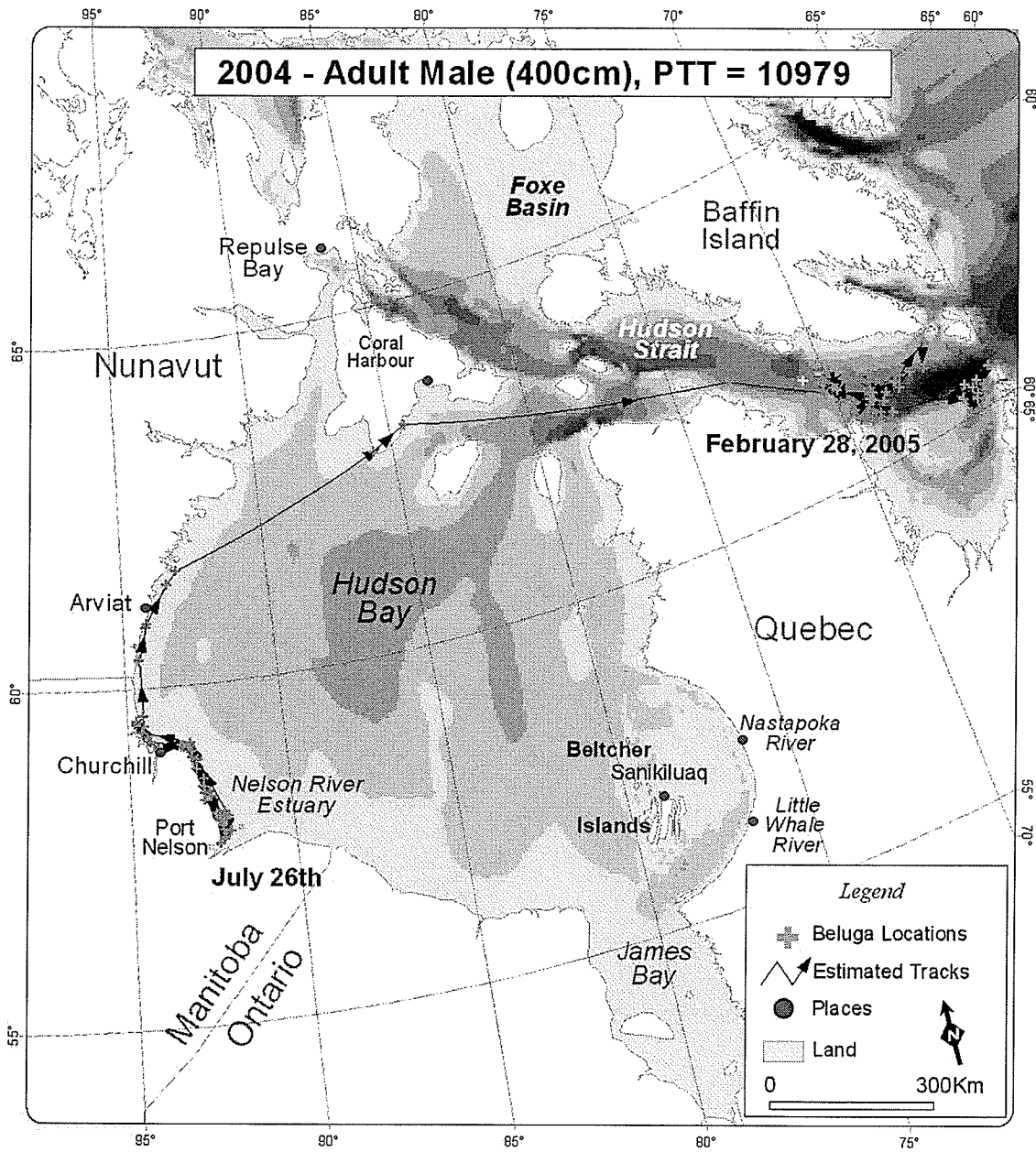

Figure V.10b; Nelson River beluga radio-tracking data for Adult Male, TAG NO. = 10979, Captured on July 24, 2004 —Zoom of Nelson River Estuary and usage by this beluga

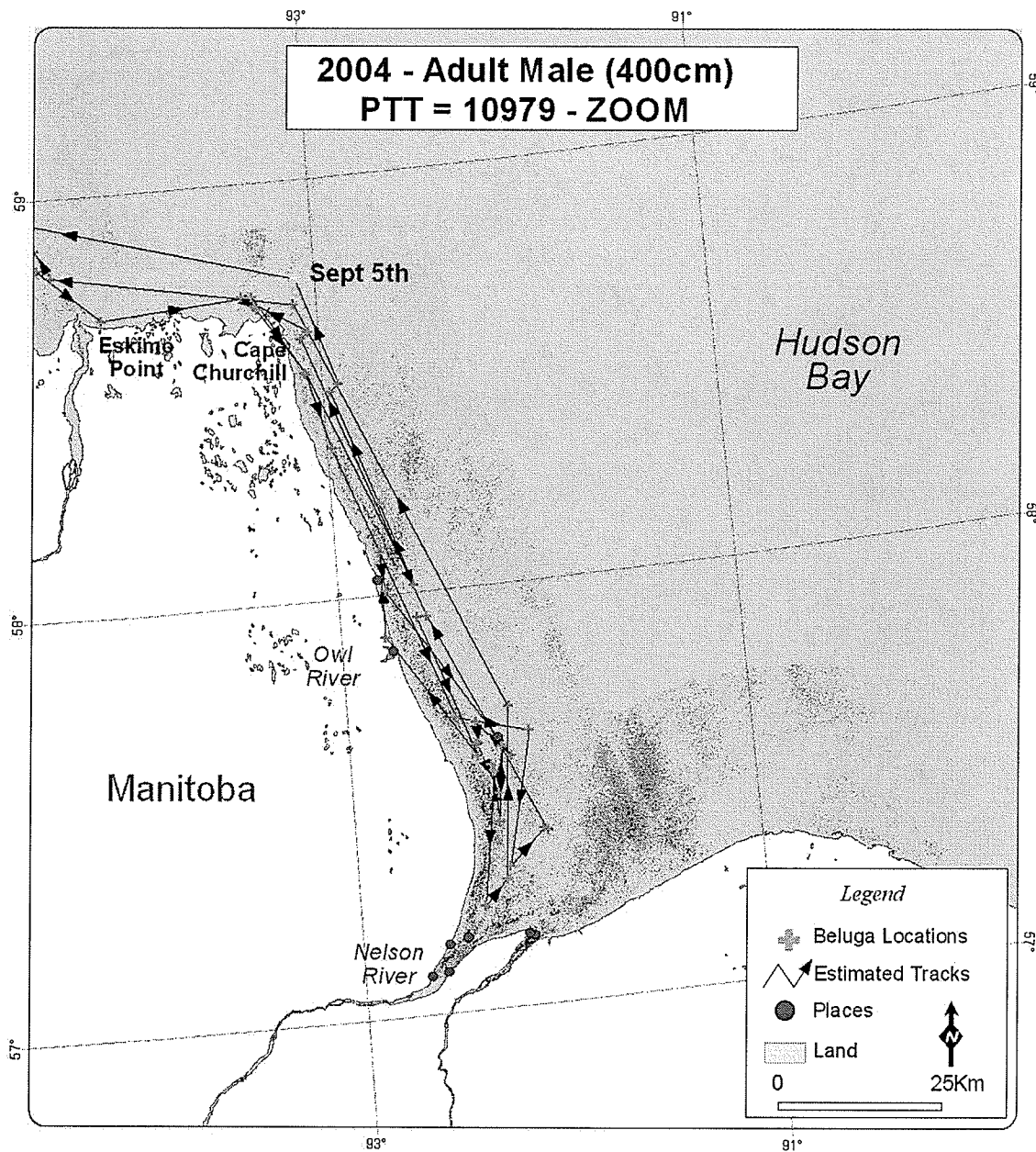

Figure V.11; Nelson River beluga radio-tracking data for Adult Male, TAG NO. = 10978, Captured on July 17, 2004

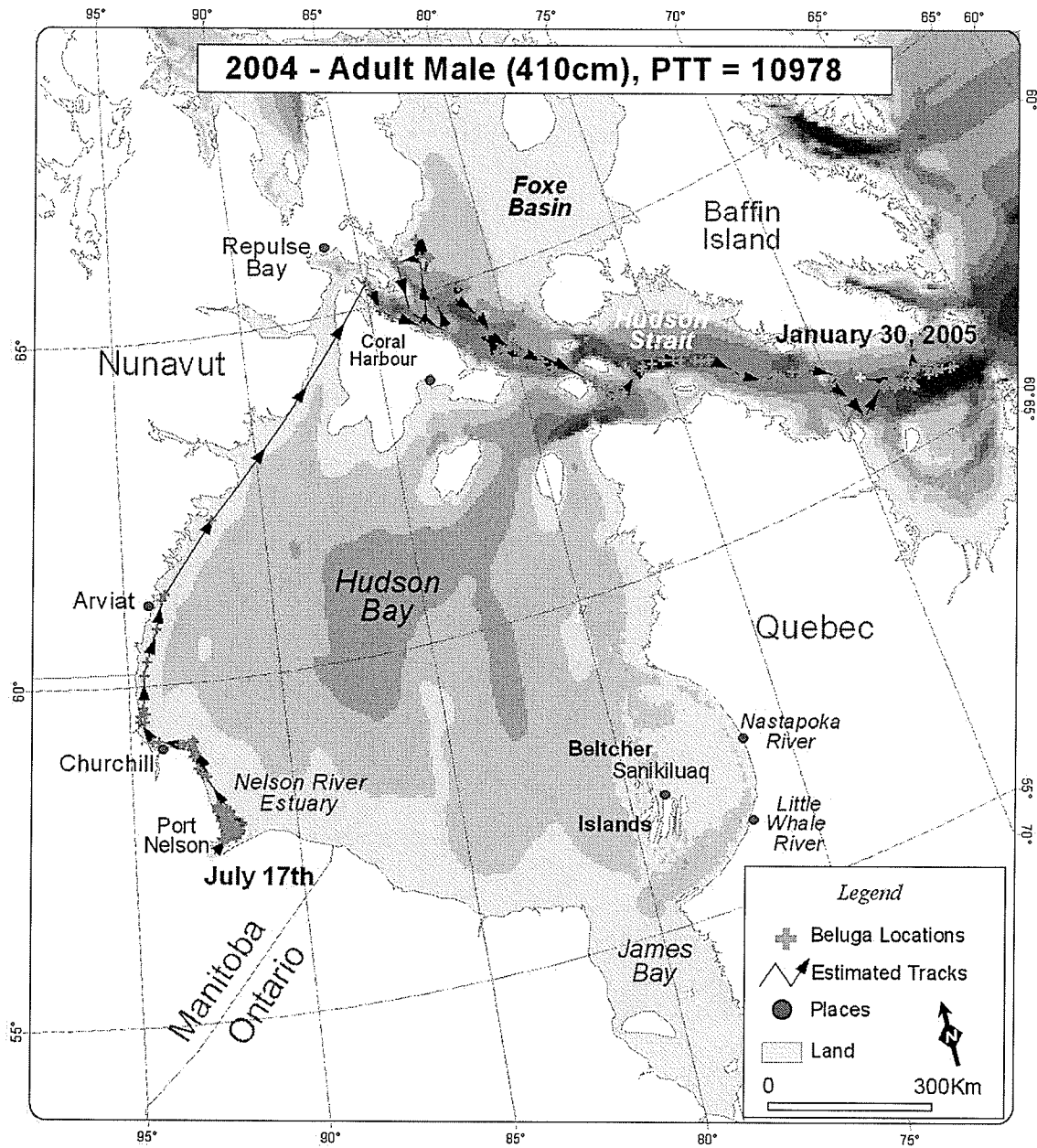

Figure V.11b; Nelson River beluga radio-tracking data for Adult Male, TAG NO. = 10978, Captured on July 17, 2004—Zoom of Nelson River Estuary and usage by this beluga

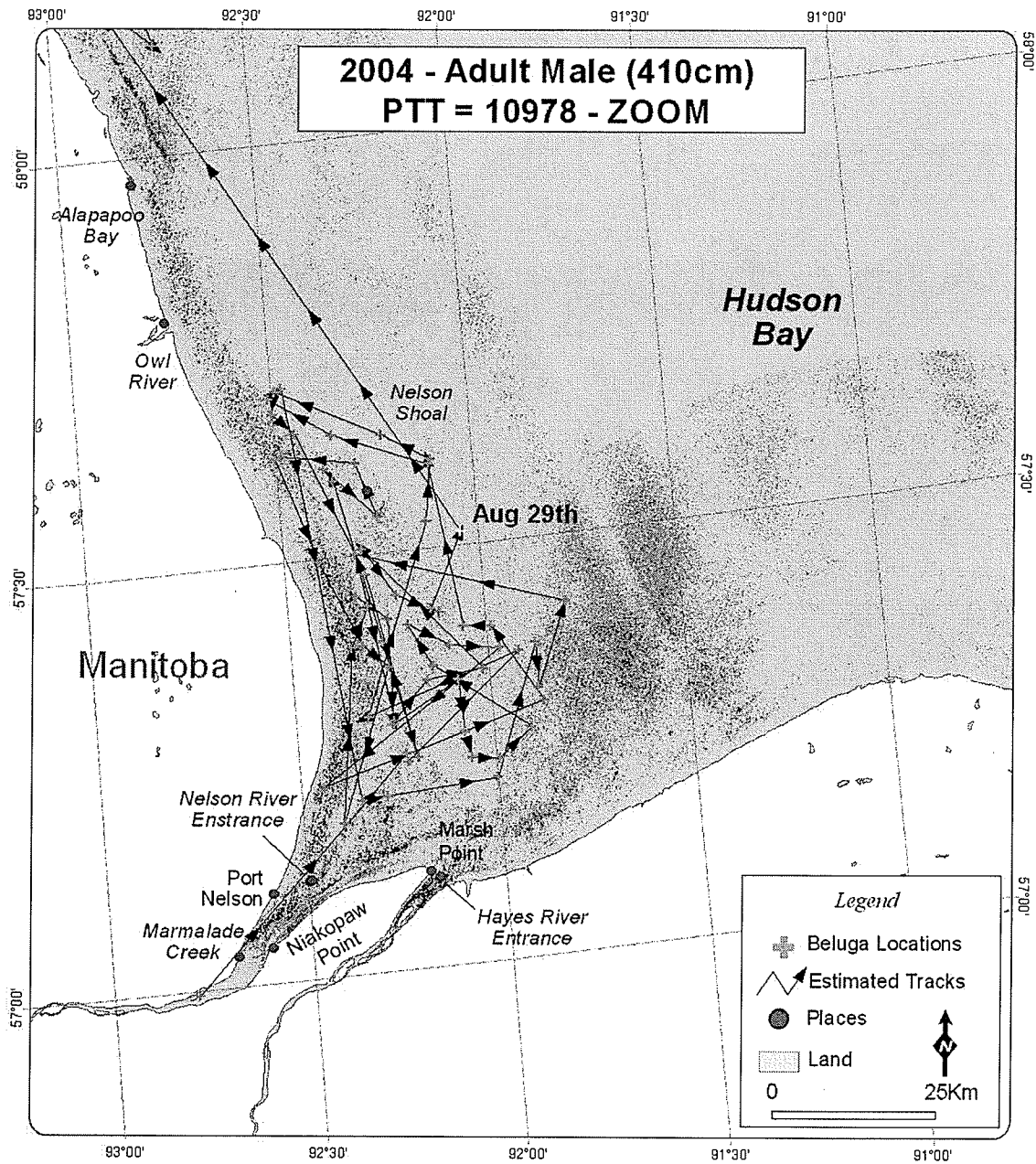

Figure V.12; Nelson River beluga radio-tracking data for Adult Female, TAG NO. = 10980, Captured on July 25, 2004

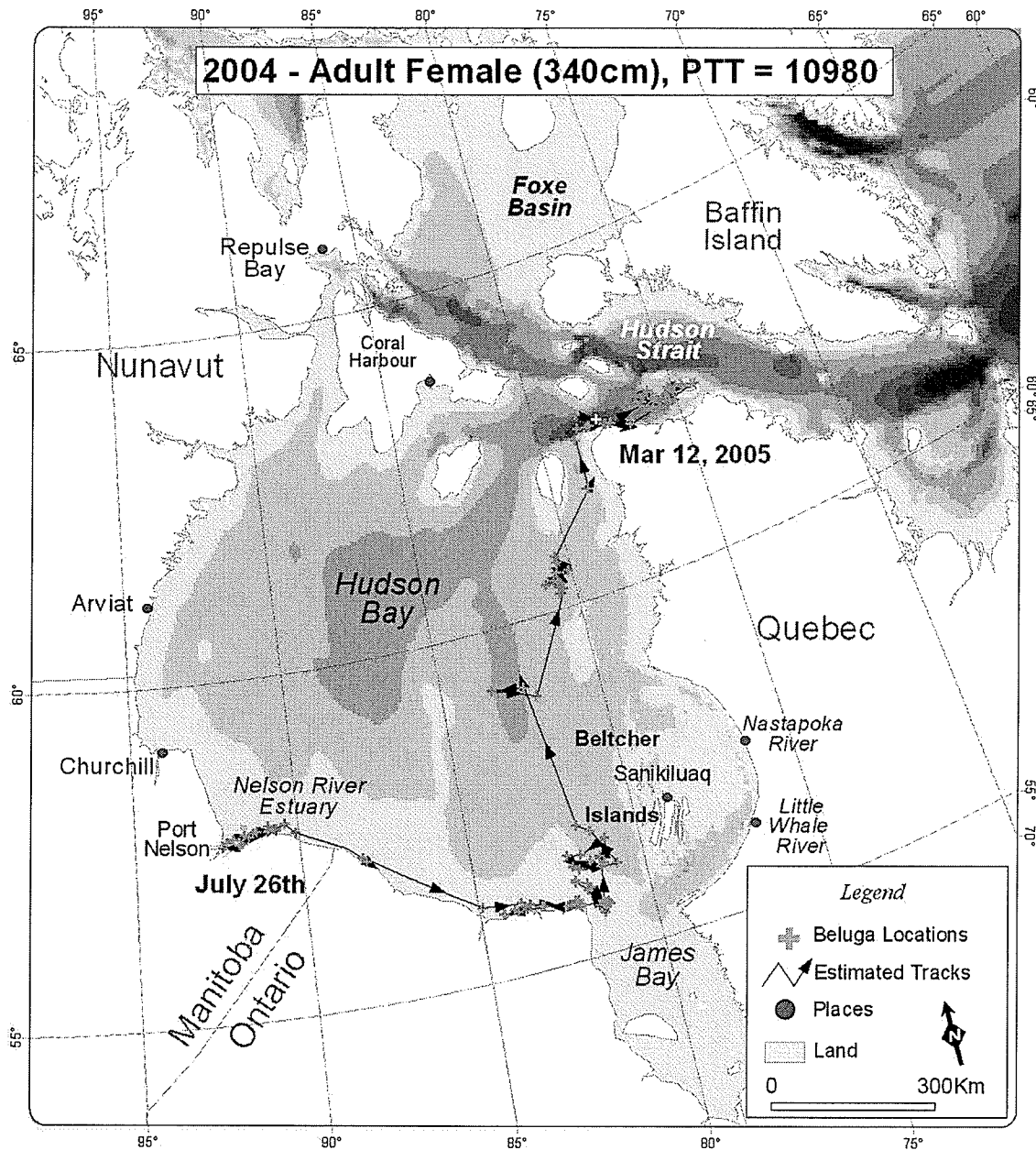

Figure V.12b; Nelson River beluga radio-tracking data for Adult Female, TAG NO. = 10980, Captured on July 25, 2004—Zoom of Nelson River Estuary and usage by this beluga

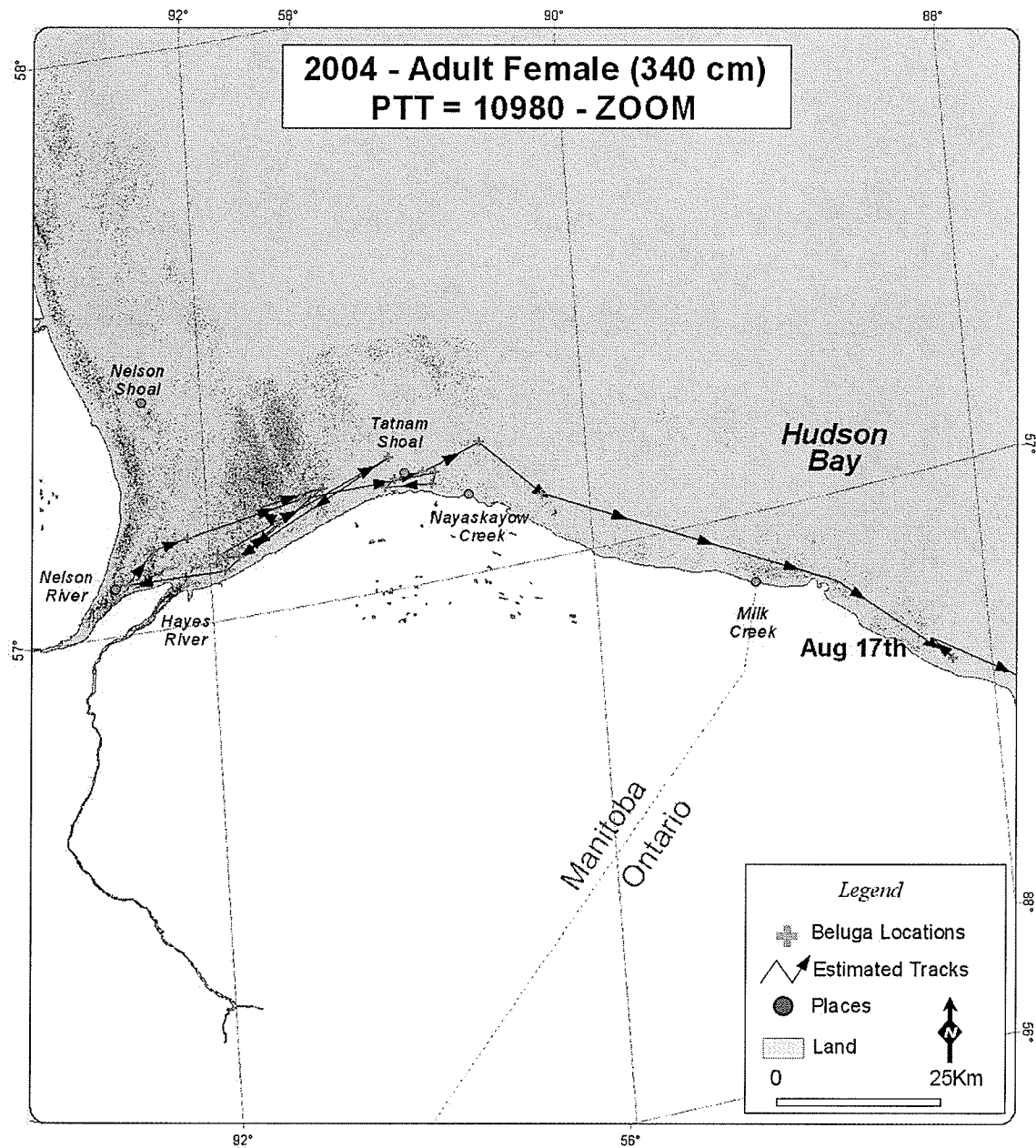

Figure V.13; Nelson River beluga radio-tracking data for Adult Female, TAG NO. = 40622, Captured on July 26, 2004— Inset of Hudson Bay and extent of radio-tracking data for this beluga

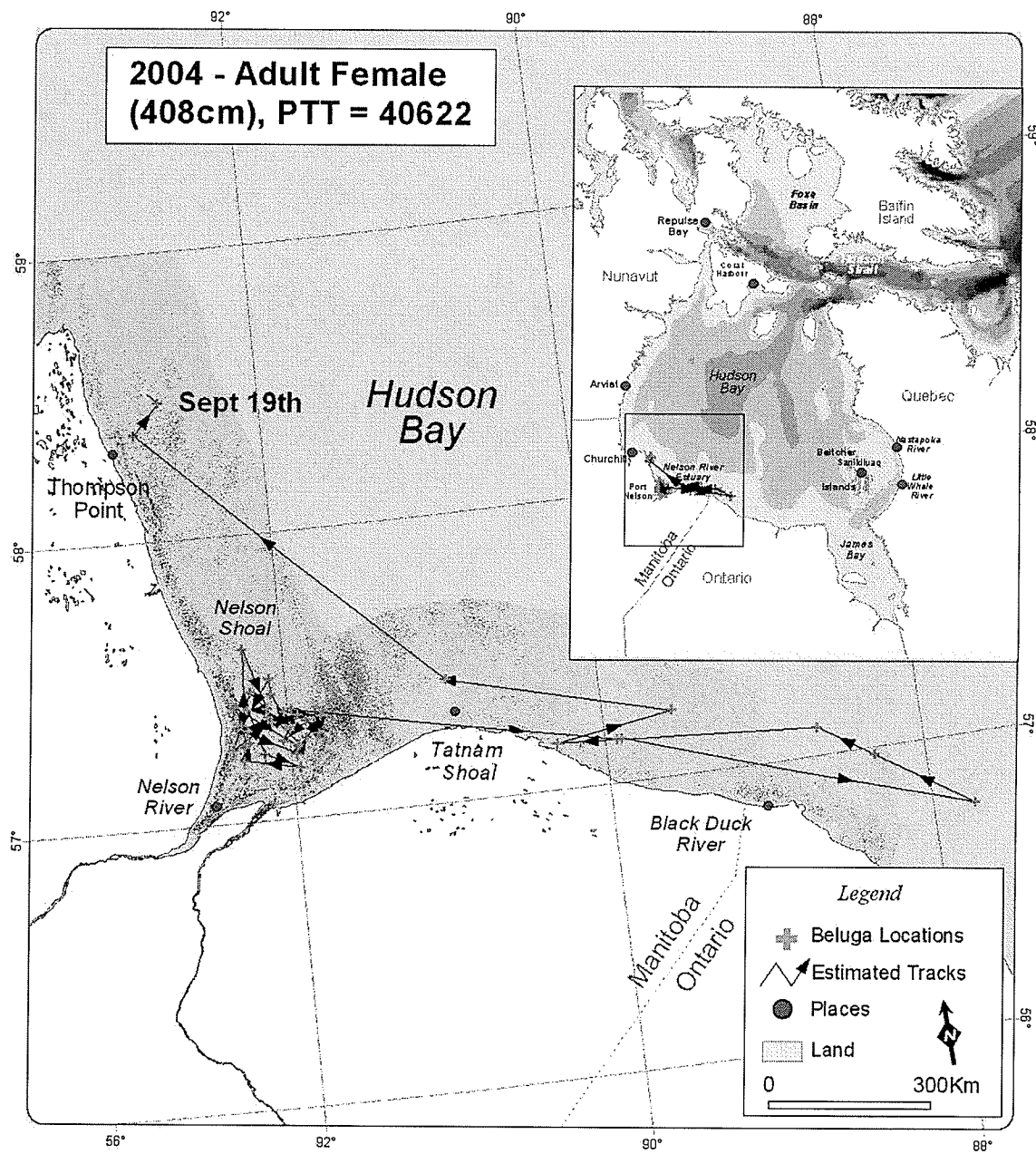

Figure V.14; Nelson River beluga radio-tracking data for Adult Male, TAG NO. = 40623, captured on July 27, 2004

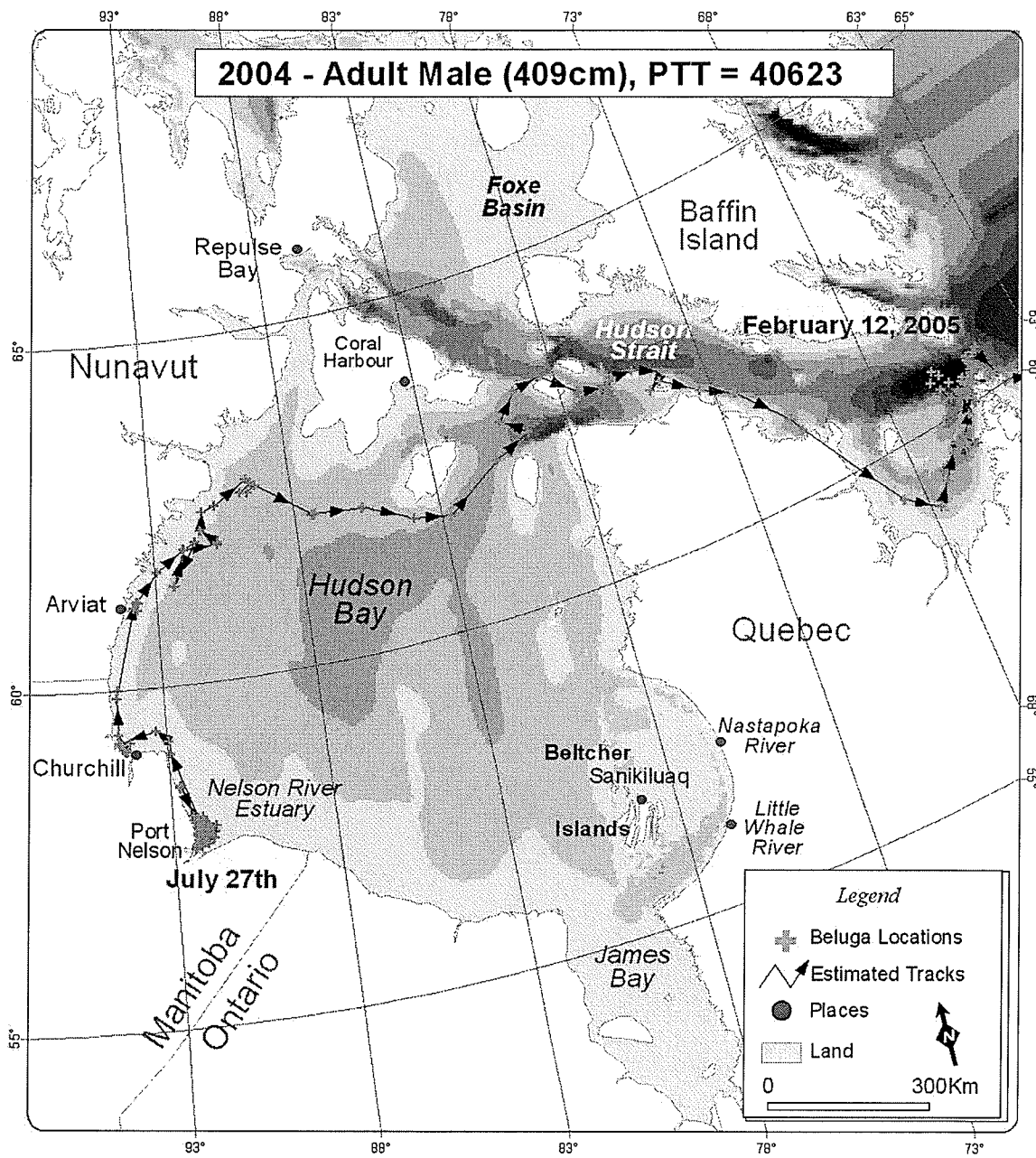

Figure V.14b; Nelson River beluga radio-tracking data for Adult Male, TAG NO. = 40623, captured on July 27, 2004—Zoom of Nelson River Estuary and usage by this beluga

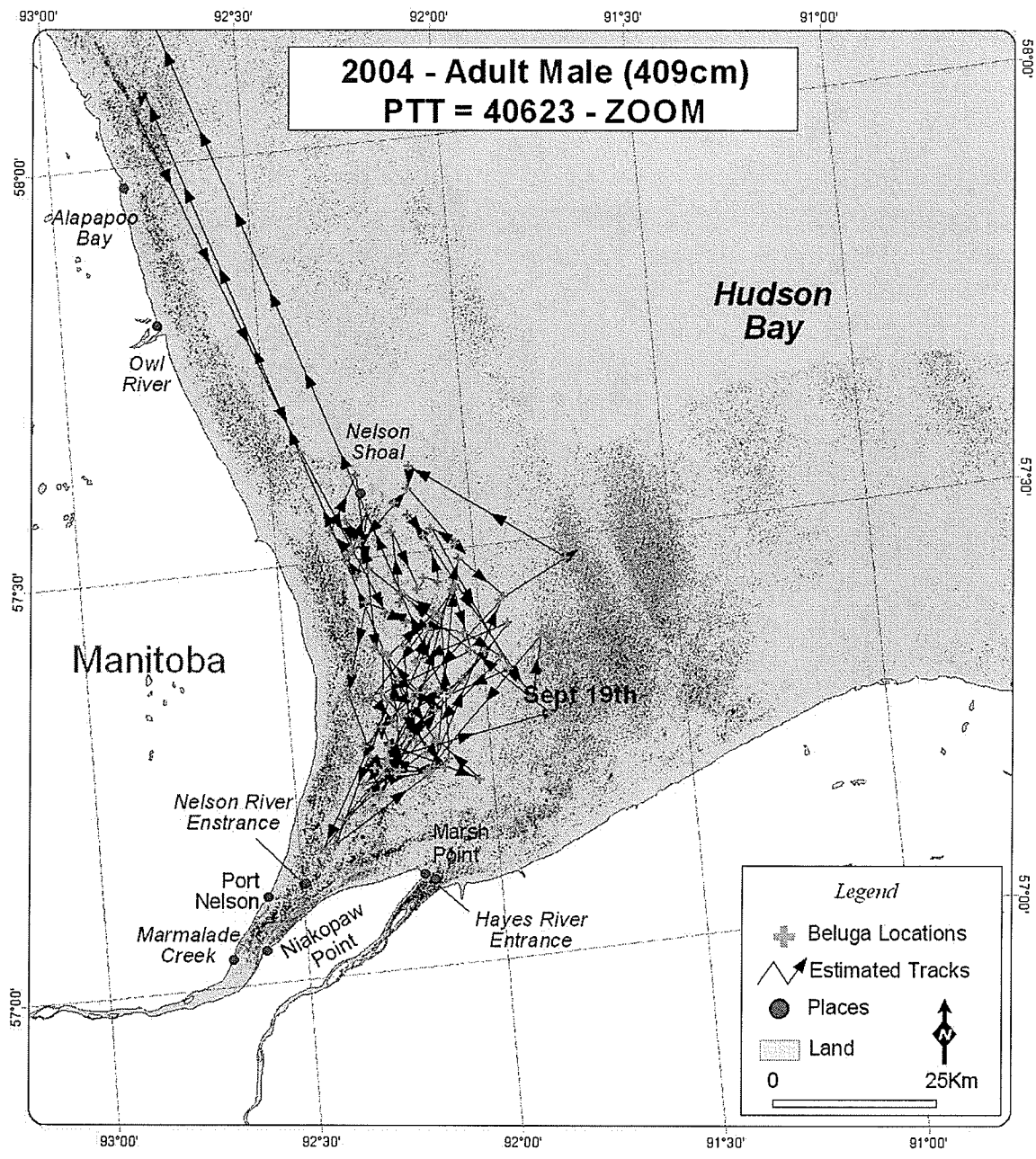

Figure V.15; Nelson River beluga radio-tracking data for Adult Male, TAG NO. = 10970, Captured on July 23, 2005

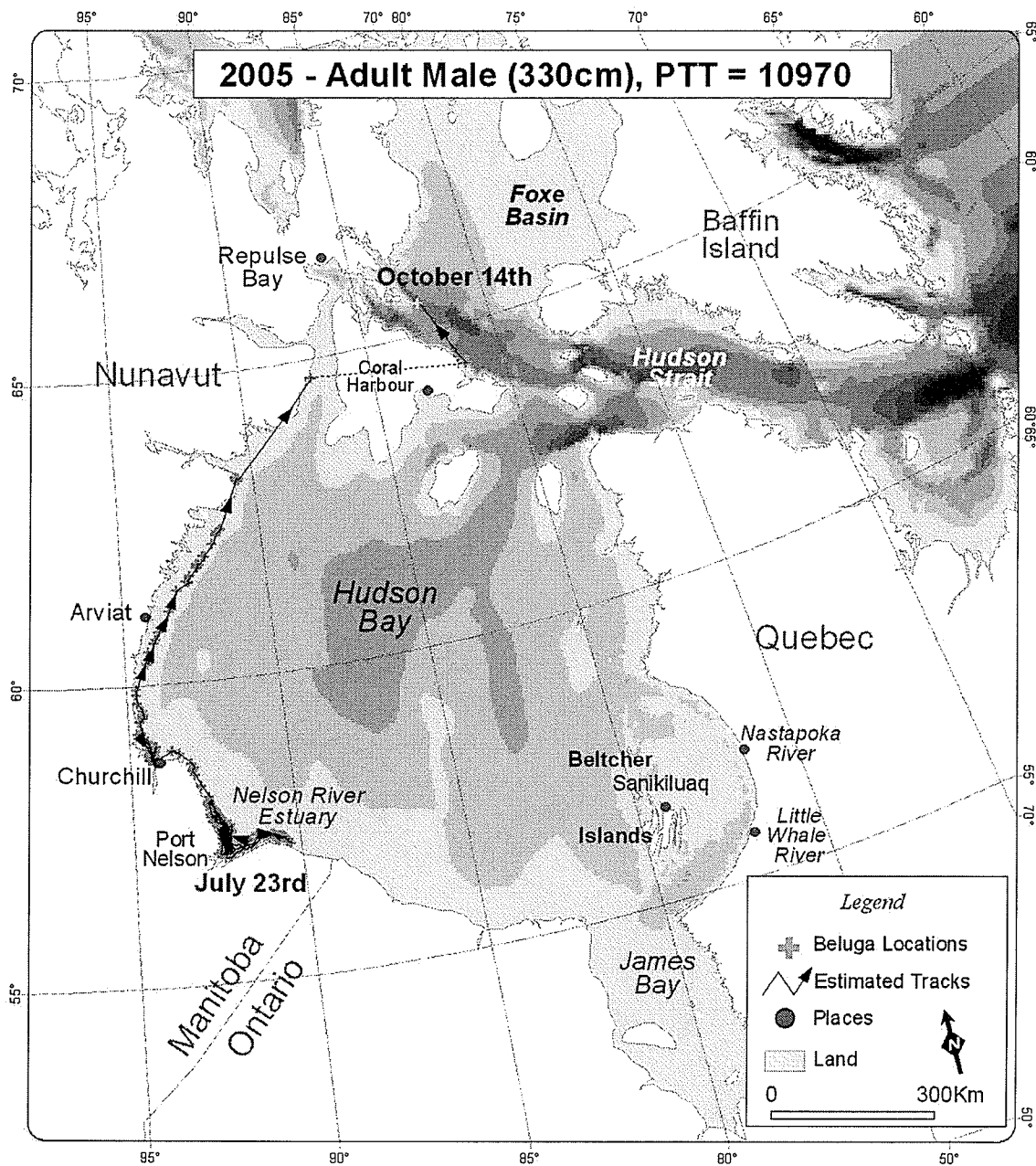

Figure V.15b; Nelson River beluga radio-tracking data for Adult Male, TAG NO. = 10970, Captured on July 23, 2005—Zoom of Nelson River Estuary and usage by this beluga

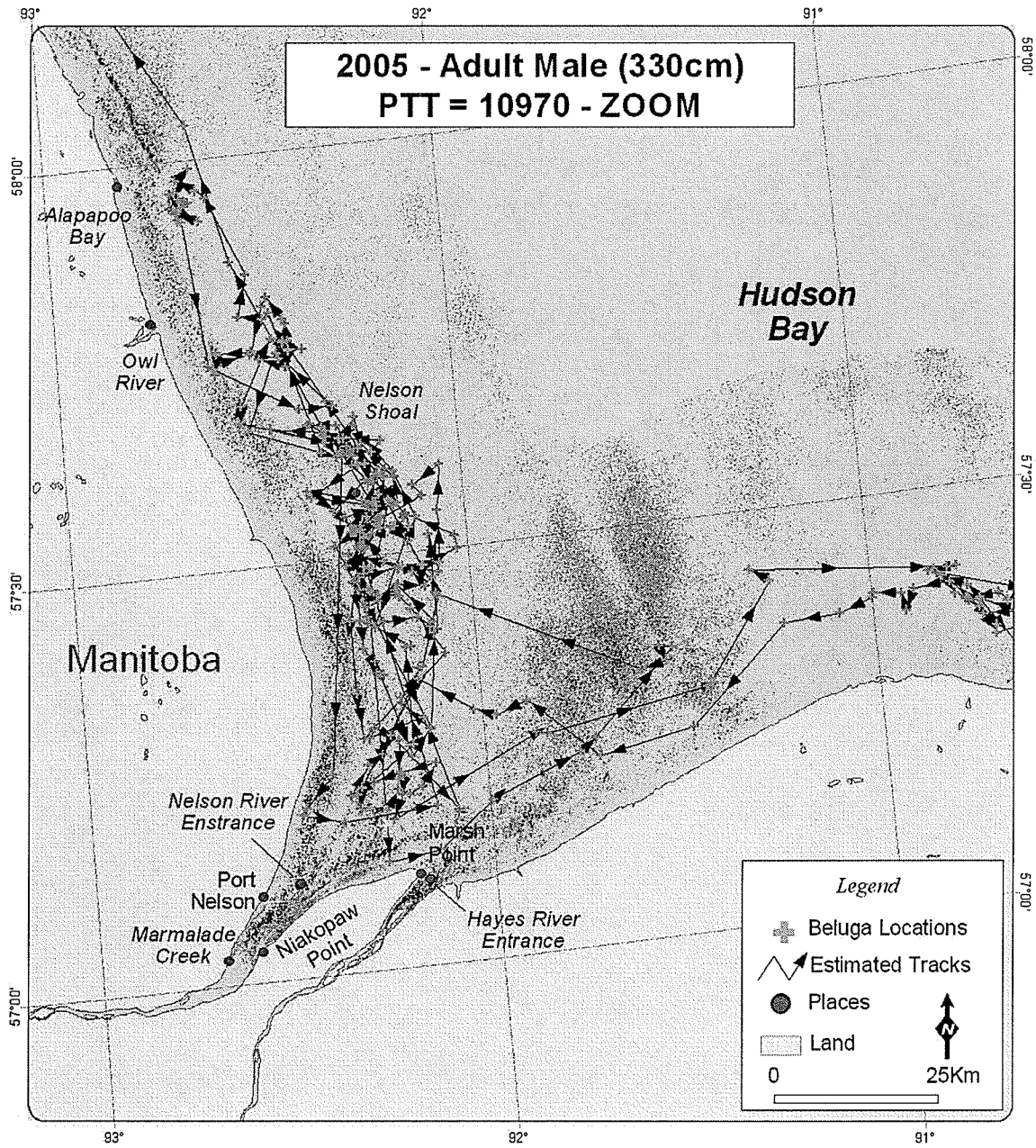

Figure V.16; Nelson River beluga radio-tracking data for Adult Male, TAG NO. = 40153, captured on July 31, 2005— Inset of Hudson Bay and extent of radio-tracking data for this beluga

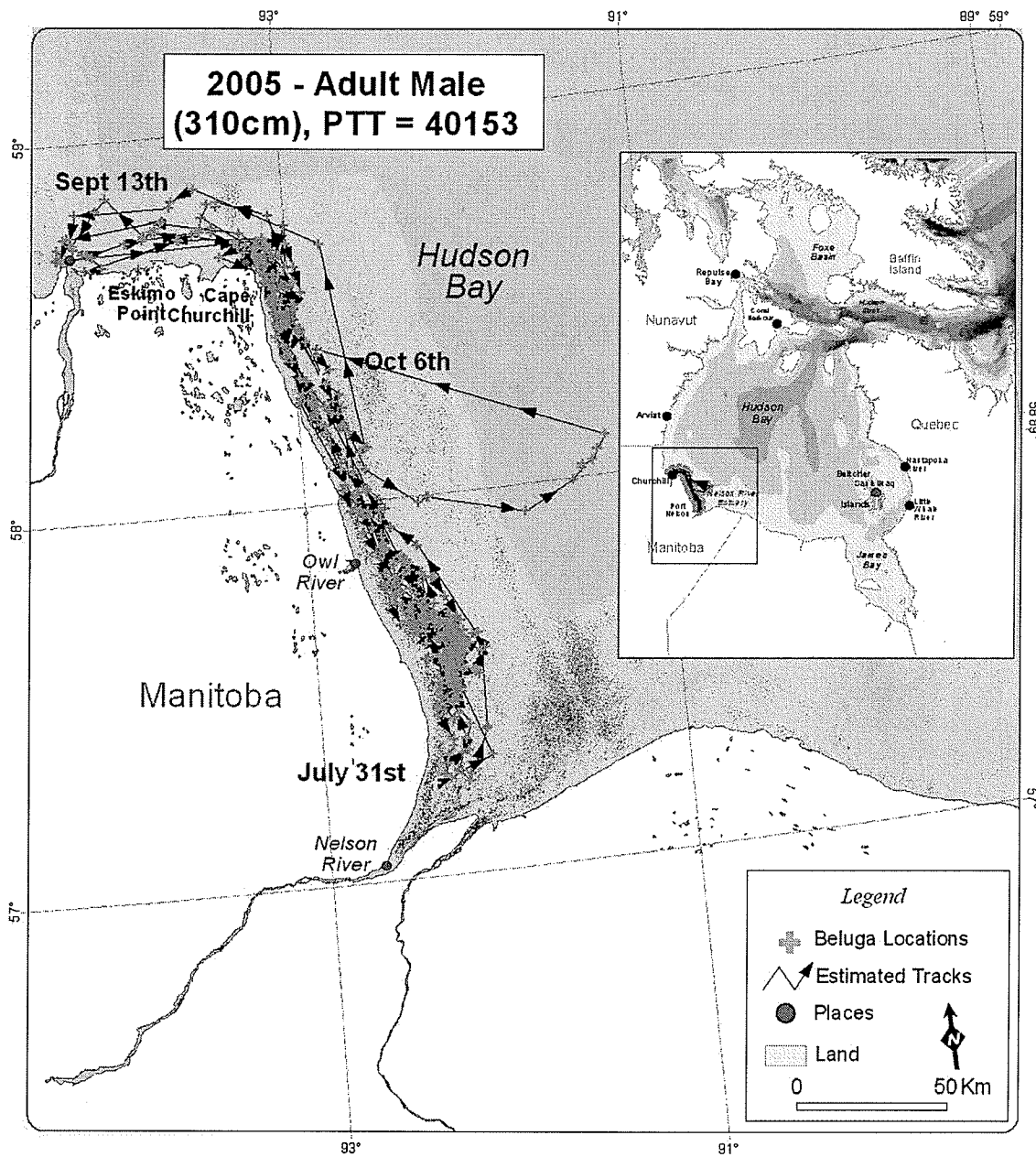

Figure V.17; Nelson River beluga radio-tracking data for Sub-adult Male, TAG NO. = 57600, captured on July 31, 2005

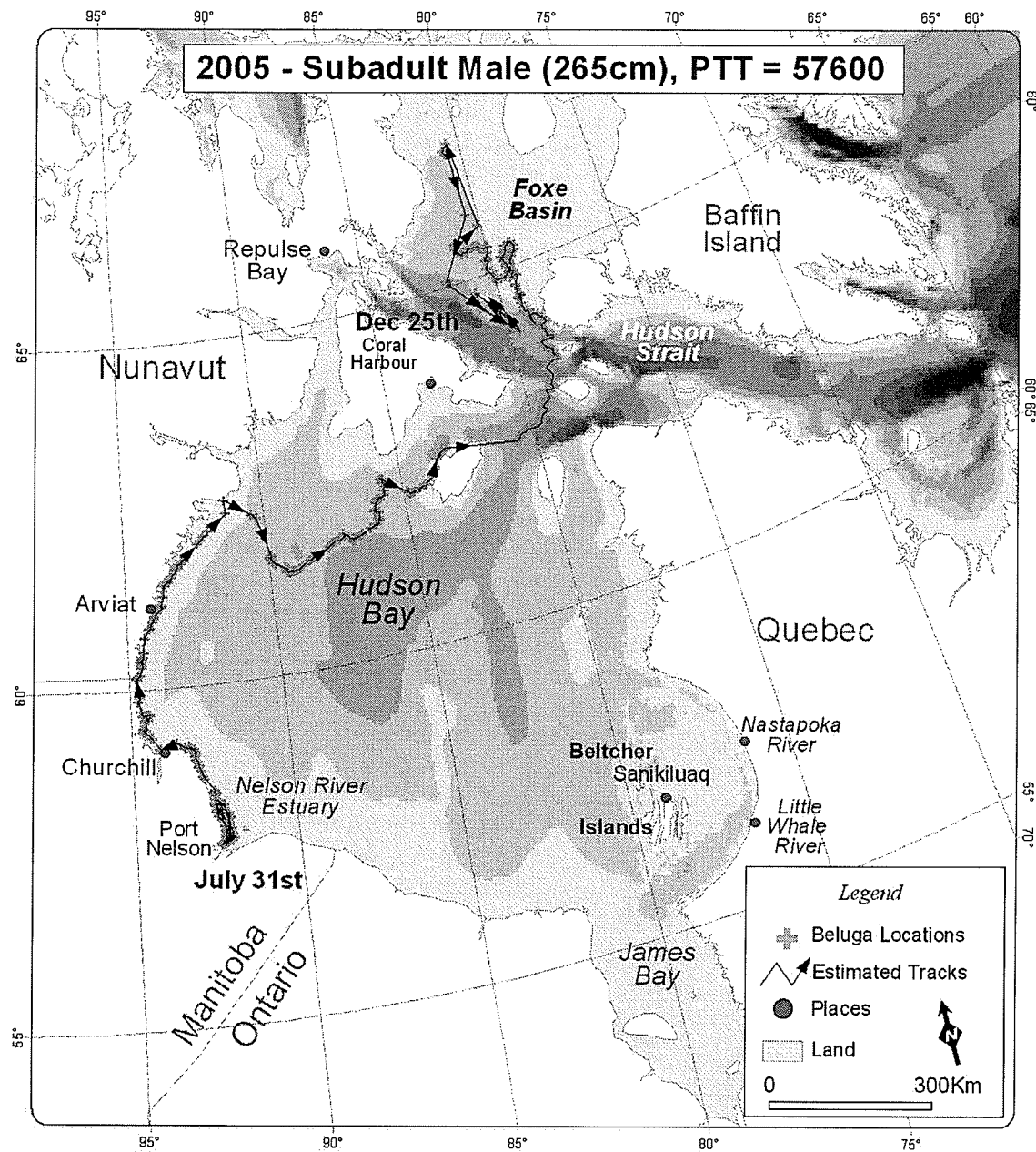
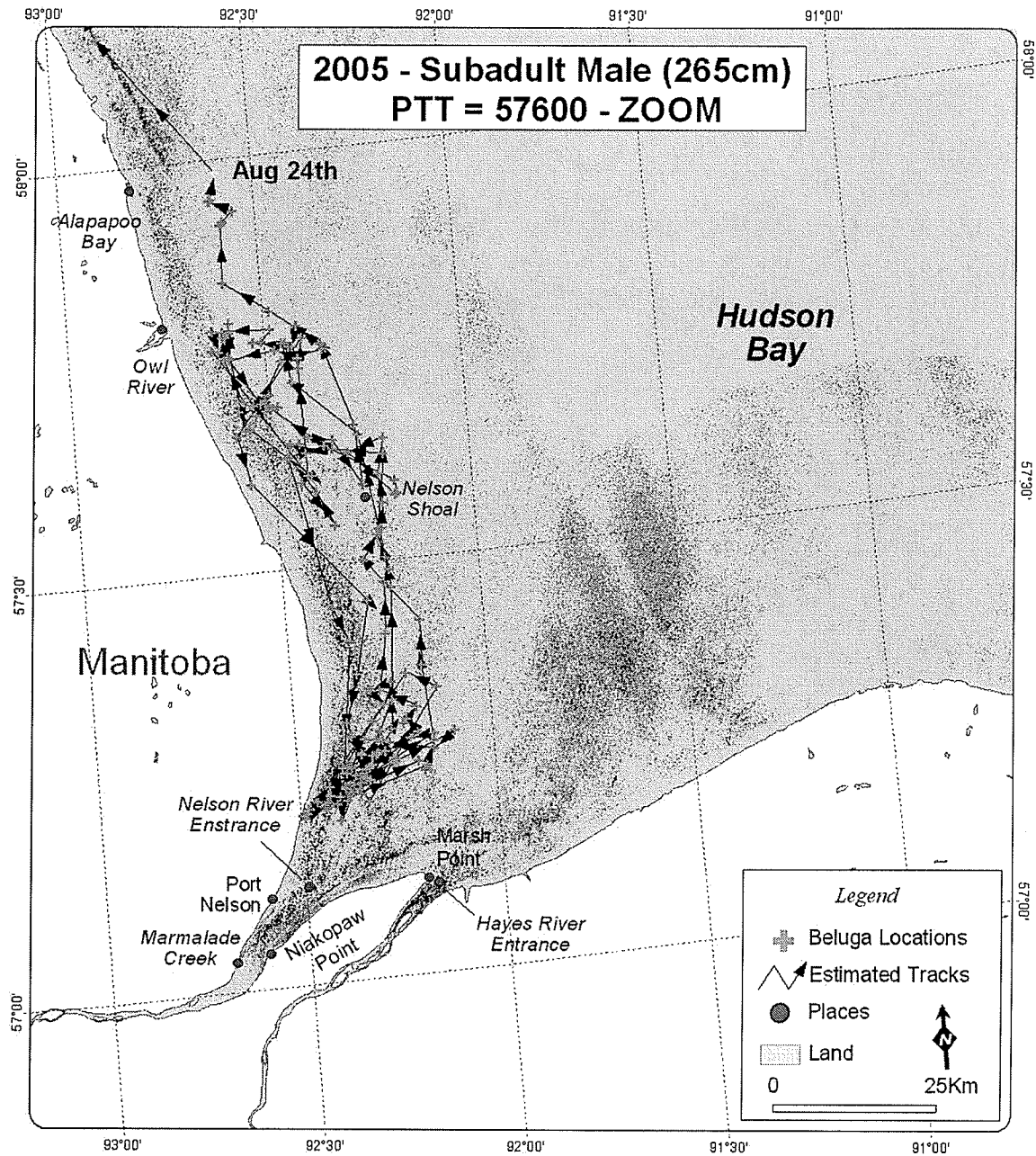

Figure V.17b; Nelson River beluga radio-tracking data for Sub-adult Male, TAG NO. = 57600, captured on July 31, 2005—Zoom of Nelson River Estuary and usage by this beluga



V.2 BELUGA ESTUARY-USE: RADIO-TRACKING DATA AND A KERNEL PROBABILITY DENSITY FUNCTION (PDE) METHOD

Along with testing of locations of belugas in the defined Nelson River estuary study region, I also employed Home Range (HR) and seasonal Utilization Distributions (UD) by week, using Kernel Probability Density Estimation (PDE) methods and satellite-linked radio telemetry data for all 13 belugas (pooled) tagged with dive-enabled tags in the Nelson River estuary. Kernel (PDE) methods are statistical techniques that smooth a surface of spatial usage fitted to discrete observations, such as satellite telemetry data. ARGOS[®] beluga location data for the Nelson River estuary provide a cursory view of their movements (by intuitively linking locations to form patterns), but do not provide discrete regions or account for intensity of use. Thus, Kernel home range analysis can be a powerful management tool allowing further analyses, and better simplification of the belugas movements in the estuary and around Hudson Bay.

V.2 Kernel Probability Density Estimation (PDE) Methods

Sample sizes for each of the 13 (ST16 and Splash tags only) belugas were large enough to use Kernel PDE methods. For the purposes of these analyses, all data for all tags were pooled before being used. Table 1 shows deployment durations for all 15 tags and table 2 shows numbers of uplinks during each deployment. Both describe beluga location samples sizes.

Table V.5; Number of locations for each beluga whale captured in the Nelson River estuary and satellite-tag deployed for years of 2002–2005.

| Deployment | Number of ARGOS [®] Locations |
|------------|--|
| 2002_1 | 601 |
| 2003_2 | 1639 |
| 2003_3 | 2359 |
| 2003_4 | 1671 |
| 2003_5 | 2260 |
| 2004_6 | 1127 |
| 2004_7 | 751 |
| 2004_8 | 1316 |
| 2004_9 | 212 |
| 2004_10 | 1095 |
| 2005_11 | – |
| 2005_12 | – |
| 2005_13 | – |

Most of the locations before August 10 are 10–60 *km* from the estuary, but some locations were recorded directly at the mouth of the River, when individuals tended to enter on the rising tide and exiting on the slack tide. Figure 4 shows the week two (~July 28th) of the Kernel or all three years of data and individuals pooled. Results show the belugas staying close to the estuary. Individuals who moved away from the estuary during the first week following the captures, likely did so as a response to the capture and tagging procedures. Figure V.15 is a large scale map of the Nelson River estuary and the week two (after captures) Kernel utilization distributions, categorized by percent relative use, and divided in four (25, 50, 75, and 95 percent) regions. The choice for these percent relative use regions are based on the work of Seaman *et al.* (1996). In the Utilization Distribution maps shown in this paper, the relative probability of occurrence of belugas varies among grid cells distributed across the study area. Occurrence probabilities are contour maps with each contour line corresponding to a change in relative probability.

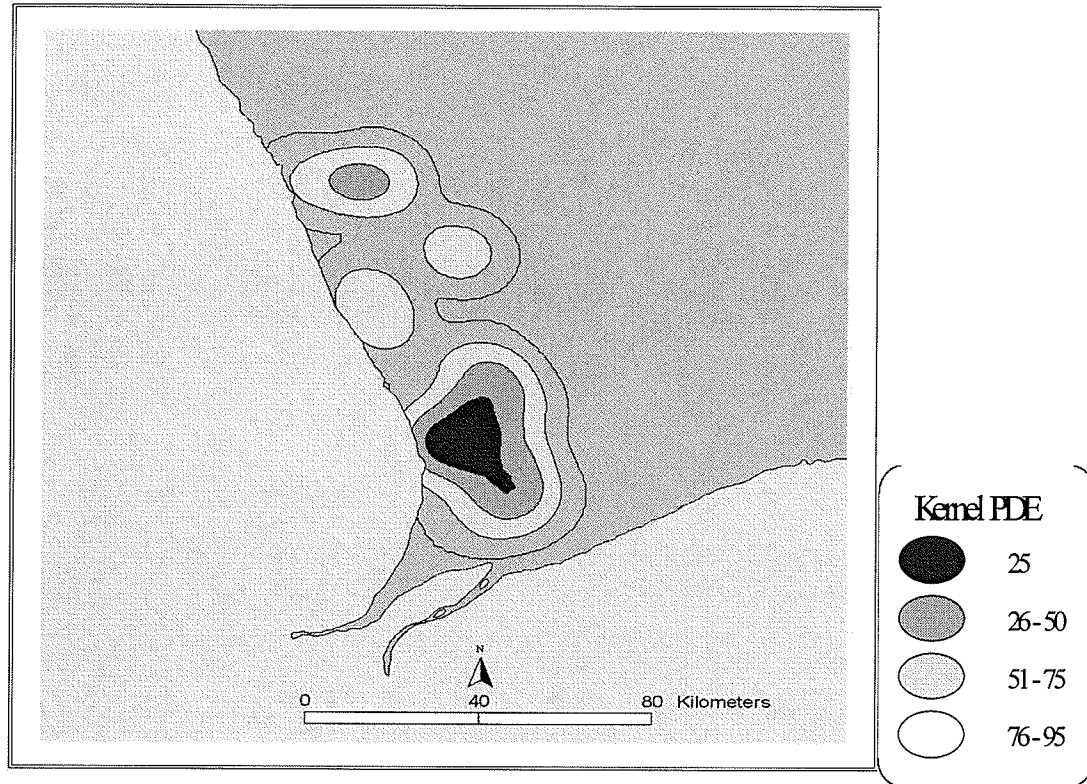

Figure V.18; Week one (mid-late July) of Nelson River estuary weekly beluga utilization distributions using Kernel methods, when some of the study whales are likely affected by the stress of capture, tagging and release methods. Colors represent utilization percentiles. Red=25%, orange=50%, yellow=75%, clear-outline=95%

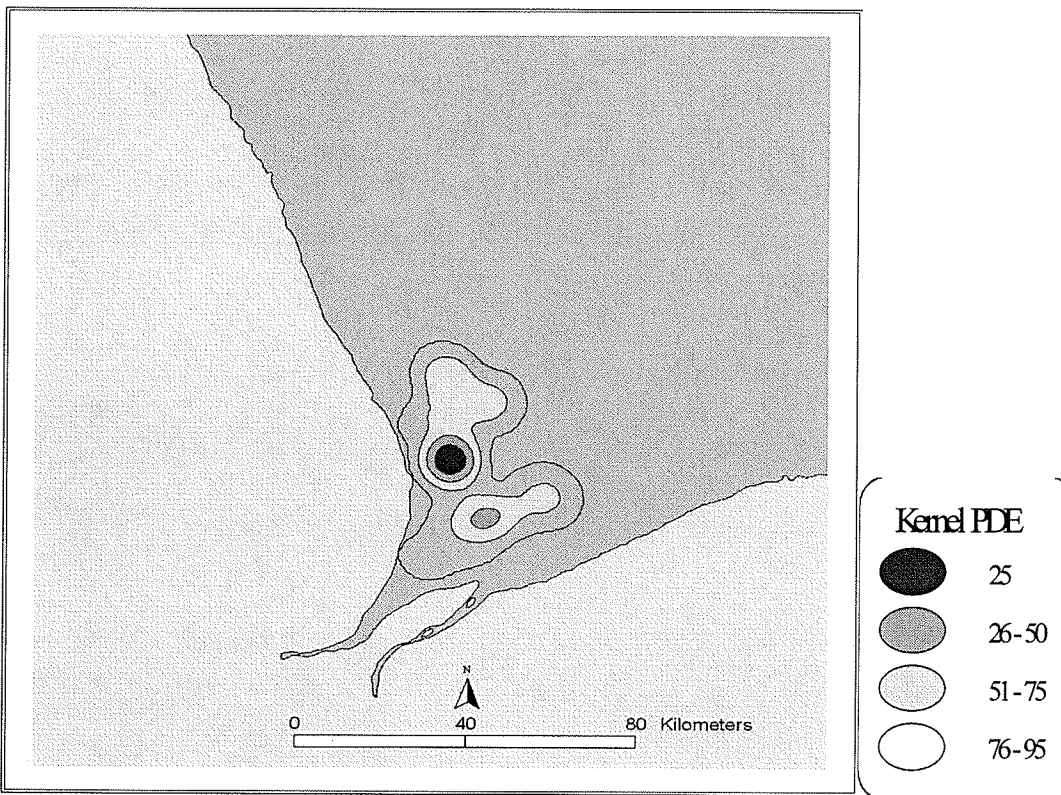

Figure V.19; Week 2 (late July) of Nelson River estuary weekly beluga utilization distributions using Kernel methods. The extent of usage has condensed back toward the mouth of the Nelson River. By week 2, most of the study whales have returned to ~ 20–50 km offshore, but within the limits of the estuary. Colors represent utilization percentiles. Red=25%, orange=50%, yellow=75%, clear-outline=95%

Beginning at week three (early August), a few of the study belugas started moving out of the estuary and not returning. By week 7 (early September) almost all had left the estuary and some had not returned. The utilization distributions show this transition in movements clearer than just viewing the ARGOS[®] locations for each tagged beluga. However, because of the sampling variability of ARGOS[®] data, and because of natural variability in the actions of the whales, some regions such as the south eastern corner of Hudson Bay, above James Bay, are weighted more heavily. The two belugas that migrated along the Ontario coast and then along the eastern coast of Hudson Bay spent

longer periods with non-directed movements, and these movements suggest foraging near the Belcher Islands. They also had more possibilities for satellite uplinks that did the 10 whales that migrated north along the western coast of Hudson Bay. These results also suggest differences in surfacing intervals between belugas with east coast Hudson Bay migration routes and others having west coast migrations.

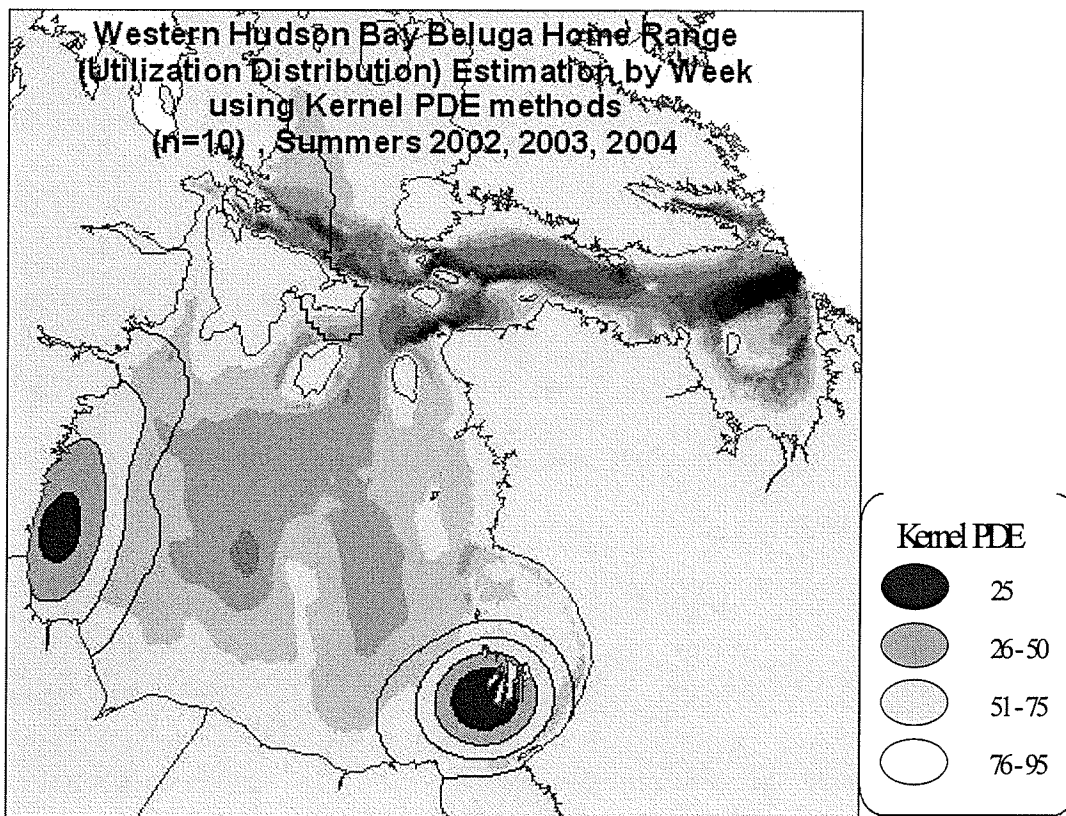

Figure V.20; Week 9 (late September) of Western Hudson bay belugas tagged in the Nelson River estuary weekly utilization distributions using Kernel methods, when all of the study whales have left the estuary and are either moving north along the west coast of Hudson Bay. Colors represent utilization percentiles. Red=25%, orange=50%, yellow=75%, clear-outline=95%

The first of the 12 study whales arrived at Hudson Strait in early to mid-October. Individuals with Eastside migrations tended to move slower, arriving later, as the Kernel Utilization Distributions show in Figure 8, Week 17 (after captures) of weekly utilization distribution calculation using Kernel methods.

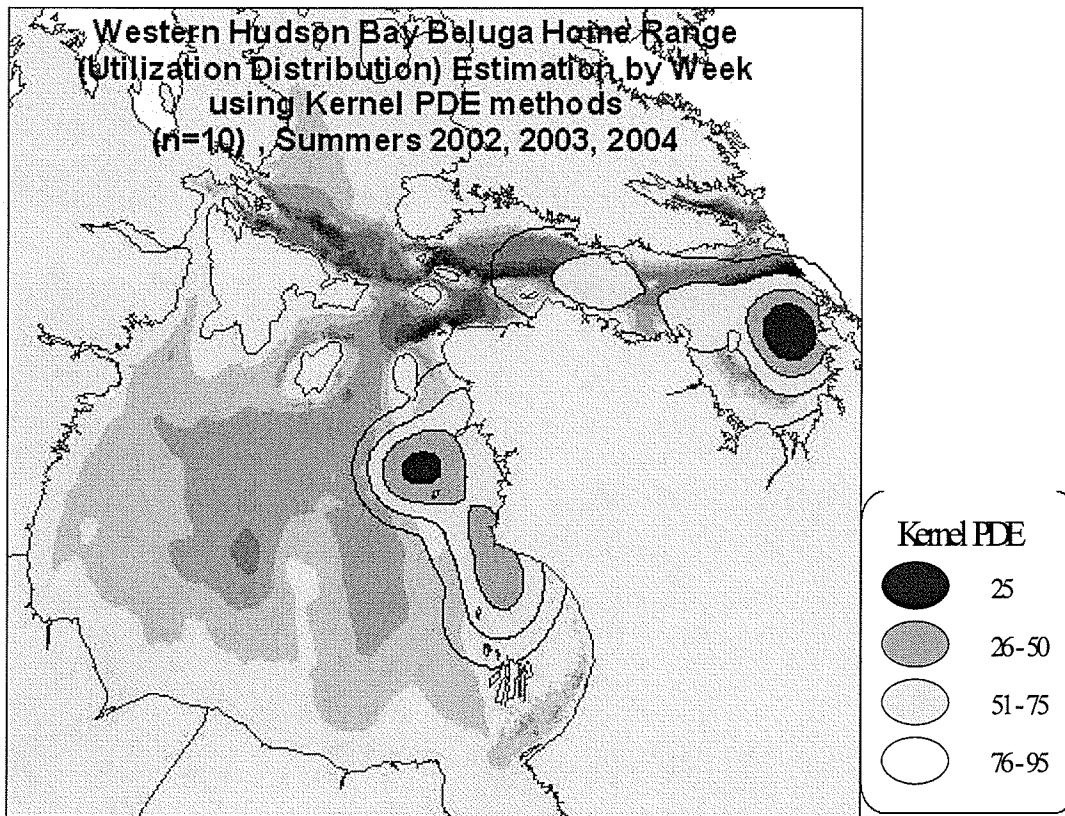

Figure V.21; Week 17 (early–mid October) of Western Hudson bay belugas tagged in the Nelson River estuary weekly utilization distributions using Kernel methods, when the first of the 10 study whales still transmitting arrived at Hudson strait. Individuals with Eastside migrations arrived later. Colors represent utilization percentiles. Red=25%, orange=50%, yellow=75%, clear-outline=95%

By mid-November (week 30 after captures, Figure 7) all study whales still wearing satellite tags had reached Hudson Strait. Here, the pooled relative-use patterns remain similar for approximately five weeks, until the last satellite tag stops transmitting. The

whales' movements during this timeframe suggest foraging or possibly moving within the pack ice, with weekly movements wavering slightly east and west as if to follow prey distributions.

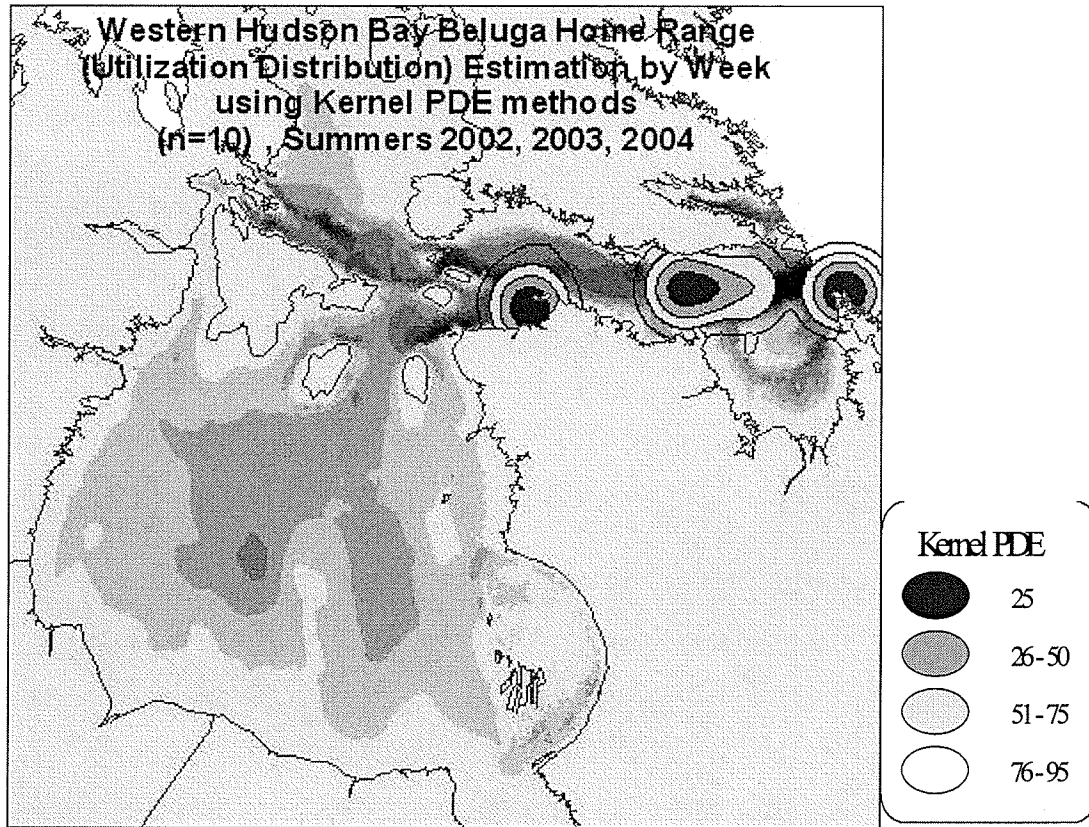

Figure V.22; Week 30 (December) of Western Hudson bay belugas tagged in the Nelson River estuary weekly utilization distributions using Kernel methods, where (now n=4) have now arrived at Hudson Strait. Colors represent utilization percentiles. Red=25%, orange=50%, yellow=75%, clear-outline=95%

V.3 NELSON RIVER HYDROLOGY: FRESHWATER-MARINE

COUPLING IN HUDSON BAY

FLUVIAL LOADING OF SUSPENDED SOLIDS AND DISSOLVED ORGANIC MATTER TO HUDSON BAY VIA THE CHURCHILL AND NELSON-HAYES ESTUARIES

The hydrological processes of the Nelson River estuary are complex and ever-changing. McCullough *et al.* (2006) studied fluxes of suspended solids and dissolved organic matter from the Nelson watersheds to describe the pathways of these loads through the estuary and their effects on light in the estuary water column. They found that along longitudinal transects Coloured Dissolved Organic Matter (CDOM) is correlated with salinity as in the mouth of the Nelson River. Turbidity has only a weak correlation with salinity. The strong correlation between CDOM and salinity along the path of flow of Nelson River water indicates that it is the main source of CDOM for the one recorded transect. Very high turbidity near the sediment-water interface at the mouth of the Nelson indicates that sediment is re-suspended by flow, tidal or wave energy in shallow water in the estuary and that turbidity is not correlated with salinity in this region (McCullough *et al.* 2006).

Figure V.23; MODIS image showing CTD measurements transect for the Nelson River estuary for 8 August 2006



Image source: McCullough *et al.* (2006) / rapidfire.sci.gsfc.nasa.gov

Figure V.24: Coloured Dissolved Organic Matter (CDOM) vs. salinity for the Nelson River estuary; An example of complex subsurface mixing in a hydrological system

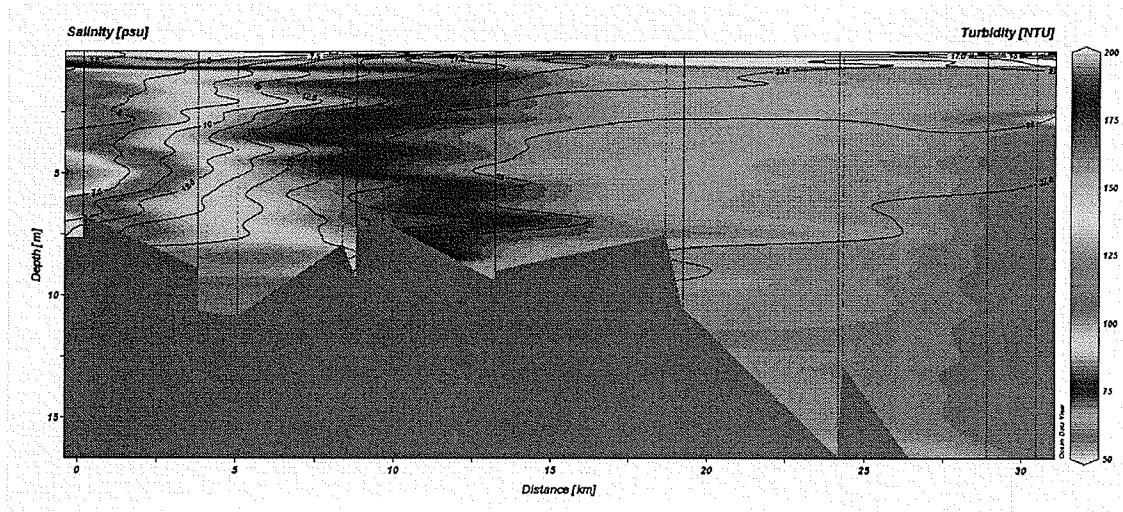

Image source: McCullough *et al.* (2006)

Figure V.25: Turbidity vs. salinity for the Nelson River estuary; An example of complex subsurface mixing in a hydrological system

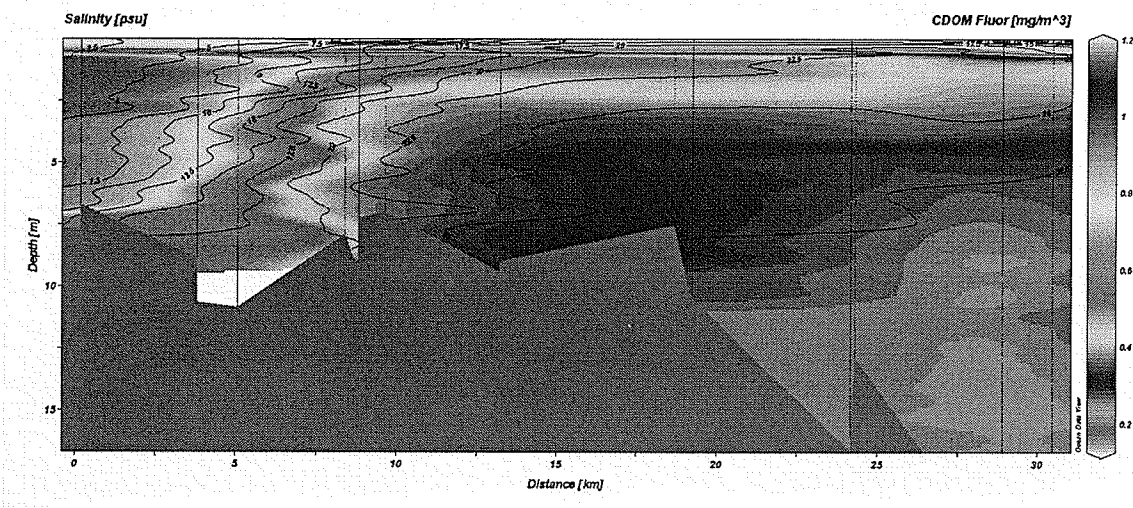
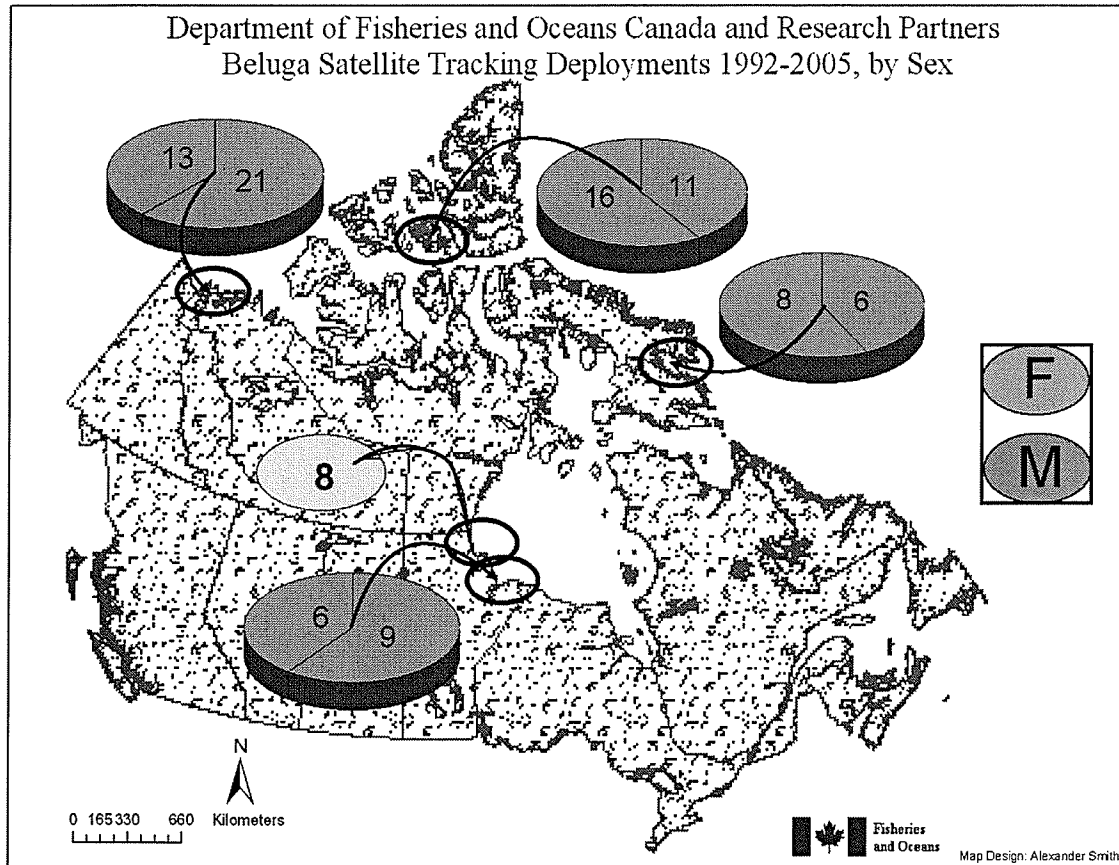

Image source: McCullough *et al.* (2006)

Results of McCullough *et al.* (2006) illustrate the complexities and limitations of research in hydrologically pulsed ecosystems. To further study beluga whales in the Nelson River estuary, more data for a larger extent is required, even though the Nelson River estuary is a well-studied estuary, relative to other arctic estuaries used by belugas.

Figure V.26; Location by sex of beluga whales tagged with satellite transmitters across the Canadian Arctic 1993–2005, for, (left to right) Mackenzie estuary, Churchill River estuary, Nelson River estuary, Somerset Island, and Cumberland Sound. Green=Fem



For figure V.26 (above) sex data for belugas captured in the Churchill River (N=8, 1992–1993) were not available when this figure was constructed. However, these data are now available (Martin and Smith; 1994, P. Hall Dept of Fisheries and Oceans, Winnipeg, pers. comm. 2007). Please see the Appendix section for more details.