

AN INVESTIGATION OF INTER-RIVET BUCKLING OF
AIRCRAFT PANELS IN COMPRESSION

A Thesis
Presented to
the Faculty of Graduate Studies and Research
University of Manitoba

In Partial Fulfillment
of the Requirements for the Degree
Master of Science in Civil Engineering

by
Charles Mansur Hovey

May 1952



ACKNOWLEDGMENT

The author wishes to express his appreciation to Dean A. E. Macdonald for his successful efforts in obtaining financial assistance in the form of a National Research Council Grant for this project, and also to the Research Council for their continued interest and guidance.

Much credit is due the efforts of Messrs. W. J. Patton, W. Zukowsky, and Cornel Gross, who, as paid assistants under the above grant, participated in all phases of the experimental work as well as in the reduction and organization of test data.

TABLE OF CONTENTS

CHAPTER I. INTRODUCTION

Introduction.	1
Design Methods.	2
Limitations of Present Design Data.	3

CHAPTER II. STATEMENT OF PROBLEM

Behaviour of Stiffened Panels Under Load.	5
Variables of the Problem.	9
Limitations of Present Investigation.	11

CHAPTER III. THEORETICAL CONSIDERATIONS

Small Deflection Theory	12
Large Deflection Theory	15

CHAPTER IV. LABORATORY TECHNIQUE

Construction of Specimens	18
Test Equipment.	19
Test Procedure.	27
Suitability of Laboratory Methods	28

CHAPTER V. RECORDED TEST DATA

Organization of Material.	29
Photo-grid Calibration.	29
Strain and Dial Gauge Readings.	31
Buckled Form of Stiffeners.	90
Control Test Data	90
Grid Displacement Readings.	101

CHAPTER VI. CALCULATIONS

Determination of Photo-grid Dimensions.	114
Pin-end Lengths	116
0.2 Per Cent Buckle Amplitude	117
Critical Buckling Stress.	117
Additional Calculations	123

CHAPTER VII. PRESENTATION AND DISCUSSION OF RESULTS

Presentation.	124
-----------------------	-----

TABLE OF CONTENTS (Continued)

Discussion of Results	128
Load Distribution	128
Pin-end Lengths.	134
Ultimate Stresses	135
Critical Buckling Stresses.	135
0.2 Per Cent Buckle Amplitude	136
Plate Buckling.	136
BIBLIOGRAPHY.	138

LIST OF FIGURES

	page
1. Panel Section.	6
2. Four Types of Failure.	6
3. Fixed-end Column Length.	10
4. Stiffener Cross-section.	10
5. Loaded Panel Element	13
6. Assembly of Platens, Panels, and Edge Supports . .	21
7. Section Through Edge Support	21
8. Dial Gauge Assembly.	22
9. Photo-grid Equipment	23
10. Compression Guide and Tuckerman Gauges	26
11. Dimensions of Control Samples.	28a
12. Arrangements of Strain Gauges and Dials.	31a
13-67. Buckled Form of Stiffeners	91-100
68-69. Tension Stress-strain Curves	102-103
70-71. Compression Stress-strain Curves	104-105
72. Sheet Profiles at Stiffeners of Panel 32	106
73. Vertical Cross-sections of Panel 19 at 32,000 lb. .	107
74. Vertical Cross-sections of Panel 19 at 36,000 lb. .	108
75. Typical Photo-grid Appearance.	110
76. Anti-symmetrical Plate Buckling, Panel 18.	111
77. Inter-rivet Buckling, Panel 18	111
78. Panel Set Up for Test.	112
79. Load-strain Curves, Panel 43	119

LIST OF FIGURES (Continued)

	page
80. Southwell Curves, Panel 43.	121
81. Load Deflection Curves, Panel 43.	122
82. Curve of Ultimate Stress versus L/t	129
83. Curve of Critical Buckling Stress versus L	130

LIST OF TABLES

I	Calibration of Photo-grid Equipment.	30
II-LVI	Strain Readings for Panels 1 to 55	32-89
LVII	Summary of Results	125-127

ABSTRACT

The material presented herein is the result of a study of the buckling behaviour of stiffened flat panels, excluding the case of plate buckling. The test procedure is described and the values obtained, consisting of ultimate stress, critical buckling stress, stress at an arbitrary lack of smoothness, pin-end length of the principal buckle, and type of instability, are tabulated for each panel. These data are intended for use as a more comprehensive approach to the development of design charts than has been available in the past.

In addition, evidence is submitted from which the following conclusions are drawn.

- 1..... Conventional methods of loading with parallel platens cannot provide uniform stress distribution in test panels.
- 2..... Three separate regimes of buckling exist within the range of panels tested.
- 3..... Initial instability was always in the form of plate buckling.

CHAPTER I

INTRODUCTION

The successful structural design of a modern aircraft involves not only the provision of adequate strength and stiffness, but also demands that these be obtained with a minimum weight of material. In addition, aerodynamic efficiency at high speeds requires exceptional smoothness of all external surfaces.

Of particular importance is freedom from waviness in laminar flow wing construction. In present day stressed-skin design the compression loads resulting from bending of the wing are carried by the wing cover, which must be adequately stiffened to avoid buckling. Wing panels are normally stiffened by longitudinal stringers of suitable cross-section, riveted in place between transverse ribs spaced at intervals sufficiently small to prevent column buckling of the panel as a unit. The problem of designing structurally efficient skin-stiffener panels is a complex one, both because of the extremely large variation in loading conditions encountered with different aircraft, and because there are many panel proportions which meet the design conditions for almost any particular application reasonably well.¹

¹ Norris F. Dow, Design Charts for Longitudinally Stiffened Wing Compression Panels, 1948.

Design methods. There have been many attempts to develop methods for predicting the strength of such panels. Of particular interest is the effective width concept of von Karman which has been widely used.²

The purely theoretical approach has been used by a few investigators. Generally speaking, however, theories sufficiently comprehensive to include more than narrowly restricted ranges of panel proportions and types of failure have not yet been evolved.³

The experimental, or possibly semi-empirical, approach has been far more extensively employed than presently available theory. Vast numbers of flat stiffened panels have been tested covering such a wide range of proportions, materials, and stiffener shapes, that it has been possible to produce design charts directly from experimental results. The work of Dow and Hickman at Langley Field has been phenomenal in this accomplishment. From these charts the most efficient panel proportions may be selected to carry a given load intensity over a given panel length with a given skin thickness.

² Th. von Karman, E. E. Sechler and L. H. Donnell, Transactions, American Society of Mechanical Engineers, volume 54, page 53, 1932.

³ George L. Gallaher and Rolla B. Bougham, NACA-TN 1482, A Method of Calculating the Compressive Strength of Z Stiffened Panels that Develop Local Instability, November 1947.

Limitations of present design data. Unfortunately it is becoming increasingly apparent that most of the work of Dow and Hickman and others falls somewhat short of providing the designer with sufficient information. Practically all of the design charts now available are based on loads at failure of the panels. Little information is available on the specific type of failure or the amplitude and wave form of the buckled sheet prior to ultimate failure. At airspeeds close to or above the velocity of sound, the accuracy of wing profile contour becomes of great importance. A slight waviness resulting from buckling in its initial stages, which would not be important from the standpoint of adequate strength, may seriously affect the aerodynamic characteristics of the wing. For this reason the critical buckling stress would seem to be assuming a position of greater importance than the actual failing load. Work on this phase of the problem is in progress at the National Research Council, Ottawa; and at Vickers-Armstrongs Ltd., (Weybridge Works), Messrs. Short Brothers and Harland, and Flight Refuelling Ltd. under contract to the Ministry of Supply, in England. It also forms a principal part of the investigation on which this thesis is based.

The results presented herein are those which have been obtained in connection with an assisted research project sponsored by the National Research Council at the University

of Manitoba. In obtaining these results, an attempt was made to record as many details as possible concerning the buckling behaviour of the panels tested. More than ordinary care was exercised to secure accuracy, with the thought in mind that the results might be used at some future date as the basis for theoretical design.

CHAPTER II

STATEMENT OF PROBLEM

Behaviour of stiffened panels under load. On compression loading of a stiffened flat panel along two opposite edges, the load being parallel to the stiffeners as in Figure 1, a state of simple compression exists until a certain critical load is reached. At this point the sheet buckles, and further loading, by increasing the amplitude of the buckle, will result in decreased stiffness of the panel as a whole. The axial stiffness of the panel now changes continually with the load and an increasingly greater share of the total load is carried by the stiffeners. As the deflection of the sheet becomes comparable with its thickness both bending and membrane stresses of significant magnitude are developed in it. These stresses acting in both longitudinal and transverse directions, in general result in compound curvature of the sheet, flexural loading of the stiffener at its points of contact with the sheet, and twisting of the stiffener. Final failure occurs when one or more stiffeners fail by some form of instability. Four types of failure of stiffened panels are sketched in Figure 2 and may be described as follows:¹

¹ Norris F. Dow, Design Charts for Longitudinally Stiffened Wing Compression Panels.

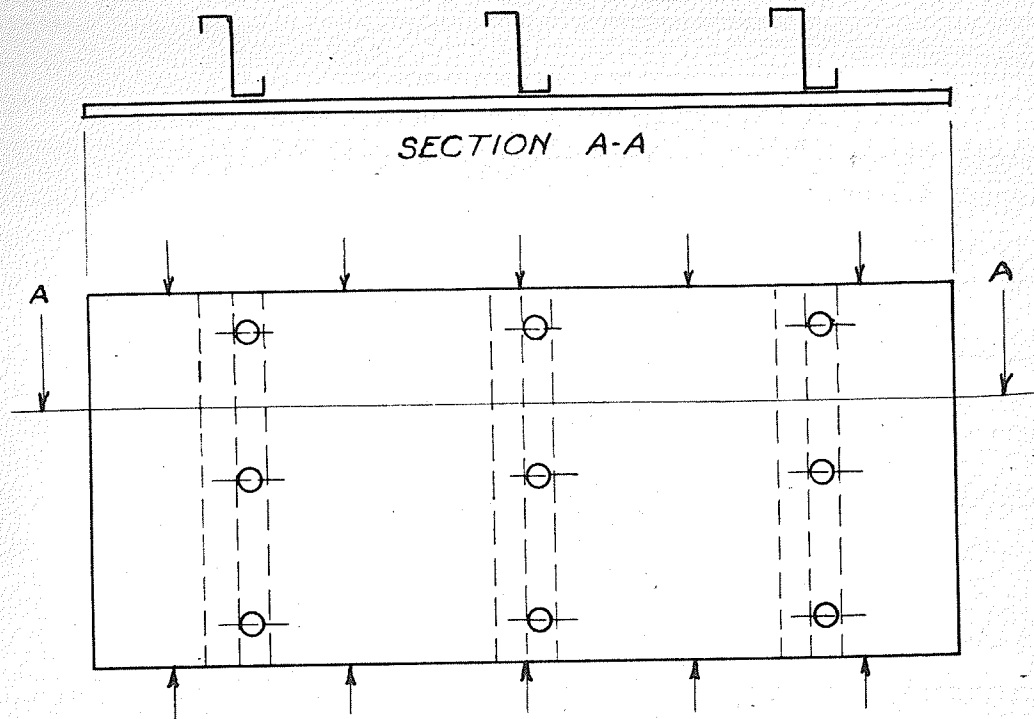
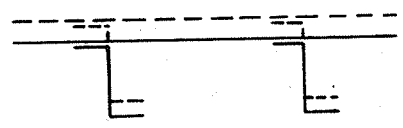
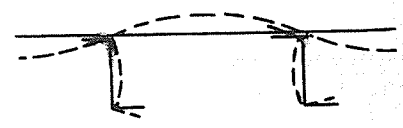

FIGURE 1



A- Column bending;- translation of entire cross section.



B- Local buckling:- distortion of cross section without translation of outstanding flanges.

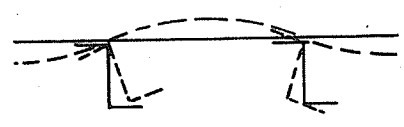

C- Stiffener twist:- distortion of section with translation of outstanding flanges.

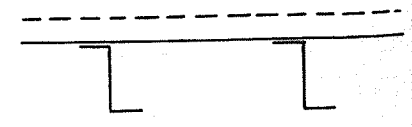

D- Rivet failure :- separation of sheet and stiffeners.

FIGURE 2

A. Column bending, involving translation of the entire cross-section perpendicular to the plane of the sheet.

B. Local buckling, causing distortion of the cross-section without translation of the corners of the plate elements.

C. Stiffener twist, resulting in translation of the outstanding flange of the stiffener. This is primarily due to column failure of the stiffener in a plane parallel to that of the sheet, but, because of restraint of one flange at the sheet, the stiffener twists and "rolls over".

D. Rivet or inter-rivet failure, involving separation of sheet and stiffeners.

In addition to the above the buckling behaviour of the sheet alone may assume any of several modes. For example, the sheet may remain in full contact with the stiffeners but buckle in several waves between them. This is actually a case of plate buckling, but is more complicated than simple plate buckling because of the associated deformation of the stiffener. If the buckling pattern in adjacent bays is symmetrical with respect to the stiffener, bending of the stiffener will ensue. If anti-symmetrical, a torsional moment will be introduced into the stiffener. The latter case is well illustrated by the photo-grid picture of Panel 18 on page 111. In either case, the critical load for the stiffener alone is altered from its normal value by the

addition of either lateral loads or twist, due to buckling of the sheet.

A second form of buckling which may occur at large rivet pitches involves buckling of the sheet as a fixed Euler column of length equal to the rivet pitch.

A third form involves buckling of the sheet between rivets, in such a manner that the deflection of the sheet is alternately towards and away from the stringer in consecutive rivet spaces.

A fourth mode seems to consist of a series of buckles predominantly along the stiffener, but not a function of rivet pitch. This type of instability appears to be analogous to buckling of a sheet supported on an elastic foundation.

With the exception of the first case of plate buckling all of these forms may be termed inter-rivet buckling. That is, they involve buckling along the line of rivets as well as in the plate between the stiffeners. Although the investigation described in this thesis was concerned with inter-rivet buckling only, it should be pointed out that it is seldom, if ever, that one form of instability occurs to the exclusion of all others. On the contrary, it is in fact difficult to ascertain in many cases which type of instability initiates failure.

The problem investigated and herein presented under the heading of "Inter-Rivet Buckling" may best be described as a study of the buckling behaviour of stiffened flat

panels, excluding the case of plate buckling.

Variables of the problem. The main variables requiring investigation are:

- a. Rivet pitch
- b. Sheet thickness
- c. Stiffener thickness
- d. Stiffener form
- e. Stiffener spacing
- f. Rivet diameter and type

The major variables in the above list are rivet pitch and sheet thickness. Some indication of the importance of the variables c, d, e, and f, may be seen in the following paragraph.

It is reasonable to assume that the stress at which the plate buckles between the rivets is a function of the ratio of rivet pitch to sheet thickness. Considering a narrow element of sheet between rivets, one would expect it to buckle as a fixed ended strut having a length slightly less than the rivet pitch, because of the clamping action of the rivet heads. (Figure 3). Three factors tend to reduce the stress attainable under this assumption. Firstly, it depends upon the ability of the stiffener to keep the rivet heads in the initial plane of the sheet. Secondly, strut failure of the sheet midway between the stringers may occur over a length greater than the rivet pitch. Finally, the clamping effect of the rivet depends upon the size and shape of its head.

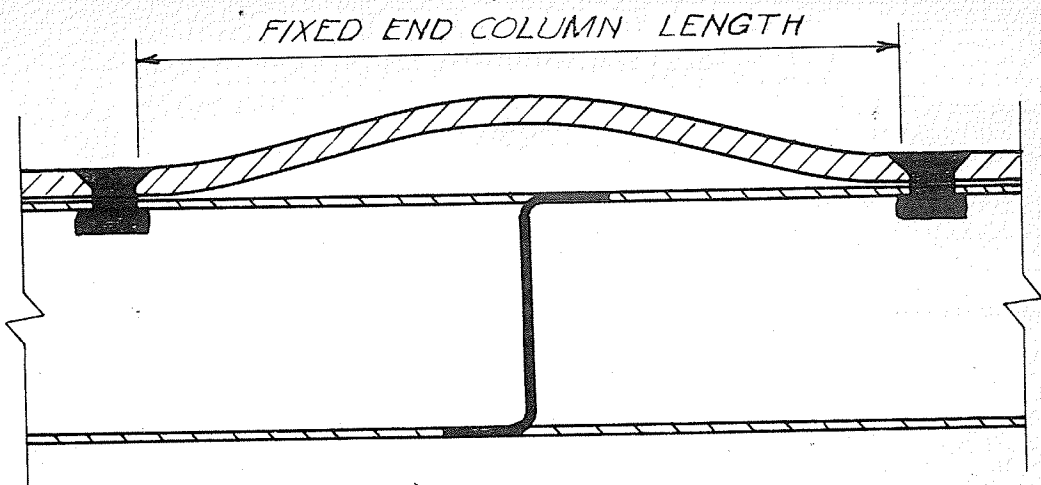
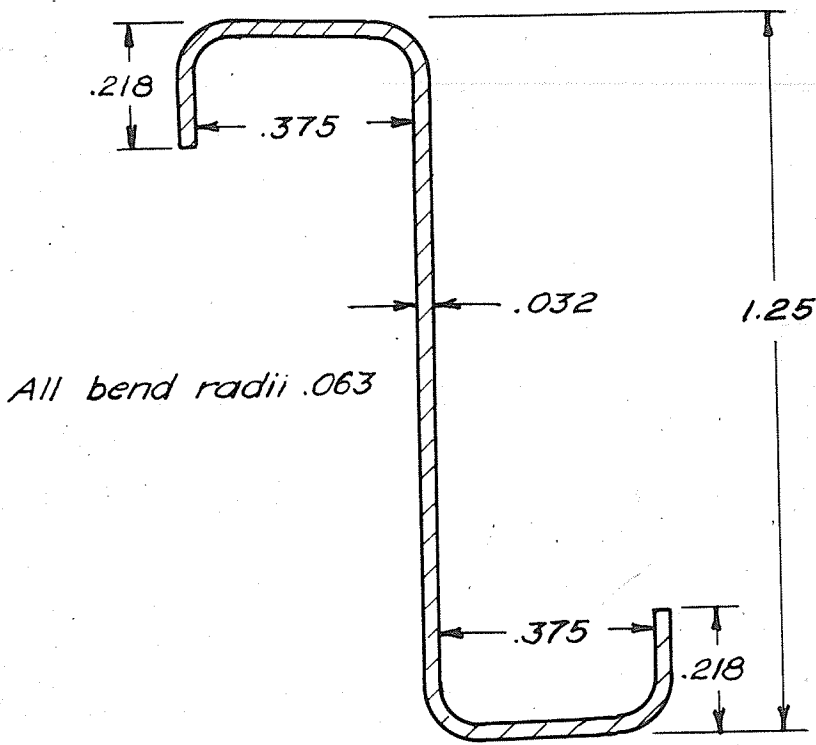

FIGURE 3



STIFFENER SECTION

FIGURE 4

Limitation of present investigation. Because of the large number of variables involved, it was decided to limit the investigation to one stringer size and form, a section of which is illustrated in Figure 4 on the previous page. All rivets used were 100° countersunk one-eighth inch diameter Al7S-T rivets of one-quarter inch length, specified as AN-426-AD-4-4 by the aircraft industry. The sheets were of 24S-T Alclad material, all but a few being of .081 inch nominal thickness. The length of all sheets used in the panels tested was thirteen and one-half inches. The width varied between fifteen and seventeen inches. The stringer design was selected so as to conform with present design charts, and its form was purposely chosen to coincide closely with those used in other investigations so as to permit of easier comparison of test results. Test results for fifty-five panels are presented herein.

CHAPTER III

THEORETICAL CONSIDERATIONS

Although the approach to this problem was experimental with the principal aim of providing test results to be used in the construction of design charts, the effects of the variables may be better appreciated in the light of general thin plate theory.

Small deflection theory. Referring to Figure 5, a thin plate having deflections, w , normal to its plane, of magnitude much less than the thickness, t , of the plate, and subjected to a force per unit width, N_x , applied in its plane, will be in equilibrium if the following relation is satisfied:

$$\nabla^4 w = \frac{N_x}{D} \cdot \frac{\partial^2 w}{\partial x^2} \quad (1)^1$$

where $D = \frac{Et^3}{12(1-\nu^2)}$ the flexural rigidity. This relation is derived from the conditions of equilibrium of any element of the plate.

The axial load at which buckling of the plate occurs will be the smallest value of N_x which satisfies equation (1). The deflection, w , may be found directly as a solution of this equation and the critical value of N_x deduced. The deflection, w , must of course satisfy the boundary conditions at the edges of the plate. Energy, or variational methods may also be used to approximate the critical load. By any

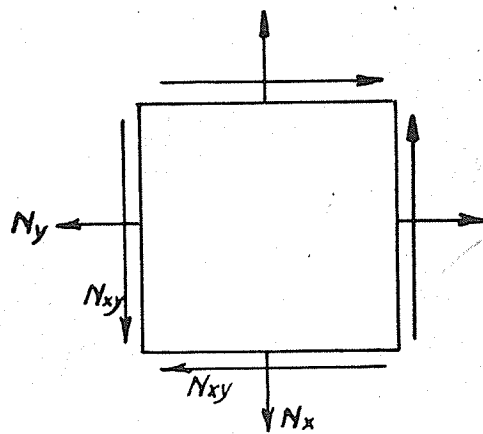
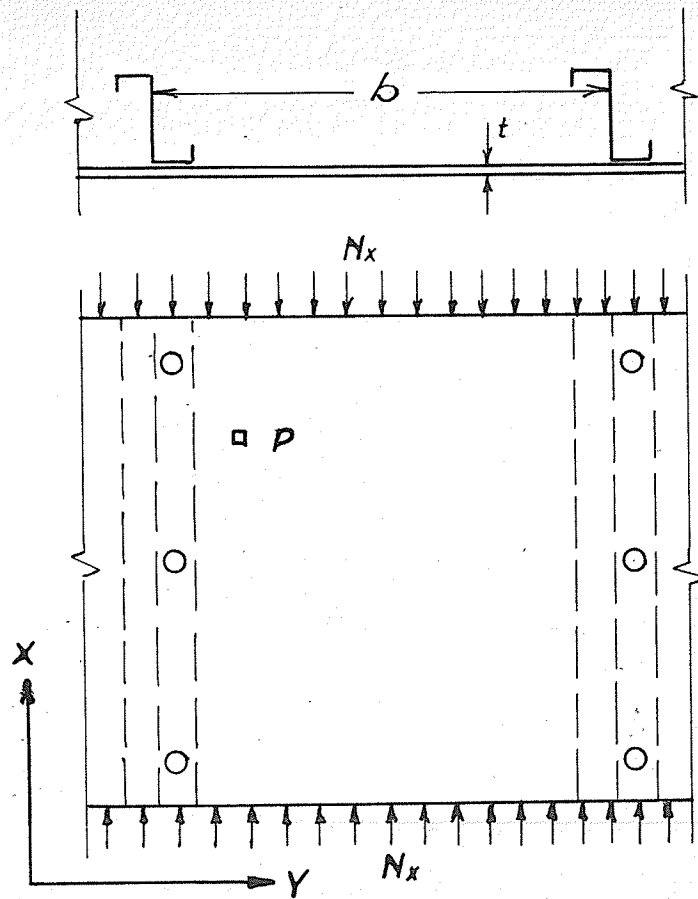

ELEMENT OF PLATE, P
All stresses shown positive

FIGURE 5

one of these methods the critical load has been derived in the form

$$N_{x_{cr}} = K_1 t \frac{\pi^2 E}{12(1-\nu^2)} (t/b)^2$$

where ν = Poisson's ratio and b is the width of the plate.

Or we may write this in the form

$$\sigma_{cr} = KE (t/b)^2 \quad (2)$$

where σ_{cr} is the critical buckling stress.

At the edges of the plate, restraint against bending and torsion is provided by the stiffeners. The imposed conditions to be satisfied by the deflection, w , are of the form

$$D \left(\frac{\partial^2 w}{\partial x^2} + \nu \frac{\partial^2 w}{\partial y^2} \right) = C \frac{\partial^3 w}{\partial x^2 \partial y} \text{ for torsional restraint } (3)^2$$

$$\text{and } D \left\{ \frac{\partial^3 w}{\partial y^3} + (2-\nu) \frac{\partial^3 w}{\partial x^2 \partial y} \right\} - A \sigma_x \frac{\partial^2 w}{\partial x^2} = EI \frac{\partial^4 w}{\partial x^4} \quad (4)^3$$

for restraint against bending along the unloaded edge. In this expression σ_x is the edge stress in the sheet, I the moment of inertia of the stiffener and C the torsional rigidity of the stiffener. Methods of calculating C for conventional stiffeners attached to plates are given by Lundquist and Stowell.⁴ Solutions of equation (1) in the form (2) for the boundary conditions (3) and (4) have been found for several particular cases. It is common practice

1 S. Timoshenko, Theory of Elastic Stability, page 337.

2 S. Timoshenko, Op. Cit., page 343.

3 S. Timoshenko, Op. Cit., page 346.

4 E. E. Lundquist and Stowell, Restraint Provided a Flat Rectangular Plate by a Sturdy Stiffener Along an Edge of the Plate. NACA TR Number 735, 1942.

to assume that the deflection $w = 0$ along all edges, but it is apparent that this procedure may introduce large errors on the unsafe side. Most theoretical and semi-empirical methods of design are based on solutions to these equations. As such they do not include the case of inter-rivet buckling since there is an implicit assumption that the plate remains in contact with, and fastened to, the stiffener continuously along its length.

Large deflection theory. Above the critical load equation (1) is not valid because it neglects membrane stresses which are not negligible when the deflection, w , is of the same order as the thickness, t .

For large deflections of the above type the expression

$$\nabla^4 w = \frac{1}{D} \left(N_x \frac{\partial^2 w}{\partial x^2} + 2 N_{xy} \frac{\partial^2 w}{\partial x \partial y} + N_y \frac{\partial^2 w}{\partial y^2} \right) \quad (5)^5$$

must be satisfied. N_x , N_y , and N_{xy} , are direct and shear loads per lineal inch on elements of the sheet and depend not only on the external forces applied but also on the membrane stresses.

These stresses may be found by use of the Airy stress function. There is a function, F , such that

$$\begin{aligned} \sigma_x &= \frac{\partial^2 F}{\partial y^2} \\ \sigma_y &= \frac{\partial^2 F}{\partial x^2} \\ \sigma_{xy} &= - \frac{\partial^2 F}{\partial x \partial y} \end{aligned} \quad (6)$$

From the large deflection compatibility of strains with the

⁵ S. Timoshenko, Theory of Elastic Stability, page 324.

above membrane stresses, it can be shown that

$$\nabla^4 F = E \left\{ \left(\frac{\partial^2 w}{\partial x \partial y} \right)^2 - \frac{\partial^2 w}{\partial x^2} \cdot \frac{\partial^2 w}{\partial y^2} \right\} \quad (7)^6$$

Functions F and w which satisfy equations (5), (6), and (7), have been determined for only a few practical cases, such as simply supported or clamped square, circular, and elliptical plates. For inter-rivet buckling the problem becomes non-linear to a high degree and therefore hopelessly complicated. In addition, isotropic material has been assumed in deriving the above equations, whereas aluminum alloys are definitely anisotropic, especially in the vicinity of the elastic limit.

In applying any of the equations (1) to (7) to the present case one has to face the difficult problem of mathematically expressing the boundary conditions imposed by the rivets. For example, with inter-rivet buckling, in alternate rivet spaces the sheet is in contact with the stiffener over one inter-rivet space, but in adjacent spaces it buckles away from the stiffener at some short distance from the rivet. This distance varies with the load on the panel, and therefore introduces a non-linear variation of the effective column length of the sheet between rivets. In some cases this has a pronounced effect on the buckling mode of the sheet. For example, the sheet may initially develop anti-symmetrical plate buckling. As the amplitude of the

⁶ S. Timoshenko, Theory of Plates and Shells, page 343.

buckle increases the sheet may begin to buckle between rivets. Resulting membrane stresses modify the wave length and rivet restraint modifies the form of the initial buckle, which may eventually cause the plate buckling to be entirely replaced by inter-rivet buckling. This is well illustrated by Figures 76 and 77 of Panel 18 on page 111.

The analytic solution of the inter-rivet buckling problem is obviously not a simple one. An accurate knowledge of the manner in which buckling takes place would undoubtedly give material assistance to any one proposing to work on such a project. Data of this general nature have been collected for the present series of tests and are, in part, presented herein.

CHAPTER IV

LABORATORY TECHNIQUE

Construction of specimens. Material for all panels tested was 24S-T Alclad provided by MacDonald Brothers Aircraft Limited, Winnipeg. Sheet stock was inspected and culled for waviness, after which it was sheared and the stringers formed by the above company. One strip of one inch width was sheared from the stock adjacent to each panel for determination of physical constants. All panels and strips were numbered at this time for future identification.

Sheets and stringers were jig drilled for rivets and a series of five-sixteenth inch holes was provided in each end, for bond of the cerrobend caps. The rivet holes in the sheet were countersunk to a depth such that the rivet heads protruded about .005 inches from the sheet. Riveting of the stiffeners to the sheets was accomplished by assembling the unit under the head of the testing machine and loading an entire row of rivets simultaneously with a smooth steel bar. Heavy flat springs were used between the bar and stiffener to hold the stiffener and sheet in close contact while they were being riveted. A load of 1,900 pounds per rivet was found suitable and was used in all cases. By this means very uniform riveting was obtained leaving the sheet free from initial deformations which might have occurred if the rivets had been hand driven one by one.

After riveting, a cap three-quarters inch in thickness of a low melting alloy known as Cerrobend was cast at each end of the panel using a pouring temperature of 200°F. In order to reduce warping from thermal expansion, the panels were clamped between wooden blocks. In spite of this, a small amount of curvature was invariably introduced, the effect of which was probably negligible.

After capping, the panels were assembled in a fixture clamped to the table of a sixteen inch shaper and the ends were machined flat and parallel to within \pm .001 inches.

Electrical resistance strain gauges were then cemented to sheet and stiffeners at desired locations using Duco cement. The locations used in most cases were the outstanding flanges of both the extreme and central stiffeners at mid-panel length, and at corresponding points on the outer surface of the sheet. Additional gauges were used in some instances for specific purposes to be mentioned later. The gauges were wired to a terminal block fastened to the cerrobend cap on the stiffener side of the panel. The outer sheet surface was then spray-painted with white Duco, and the rivets outlined with ink, making the panel complete and ready for testing.

Test equipment. The panels were tested in a 60,000 pound hydraulic testing machine accurate to within one-half of one per cent. To provide the necessary restraint against

relative rotation of the panel ends, parallel platens, illustrated in Figure 6, were used. The surfaces of these platens were ground flat to within $\pm .001$ inches. Supports, illustrated in Figure 7, were employed to prevent premature buckling at the panel edges. By clamping in these supports a strip of the sheet being tested, a clearance of .003 inches was maintained between the supports and the panel edge, providing a condition closely approximating that of simple support.

In the case of Panels 1 and 2, buckling of the sheet between rivets was measured with the dial gauge assembly shown in Figure 8, the fixed points being placed on the sheet adjacent to a pair of rivets. The instrument was initially adjusted by placing it on a surface plate and rotating the bezel until zero reading was obtained.

In all subsequent tests the deflection surfaces of the panels were recorded by means of the photo-grid method, shown in Figure 9. In this method, a grid of parallel black threads, accurately spaced in a plane parallel to the panel surface, is placed as indicated. An arc lamp and condensing lens illuminated the panel and grid. Shadows of the threads were thus cast upon the panel. A camera photographed both the threads and their shadows from the position shown in the sketch. The relative spacing of lamp, grid, and panel, were chosen so that shadows at one-quarter inch spacing were

PARALLEL PLATENS

Showing assembly of platens, test panel and edge supports.

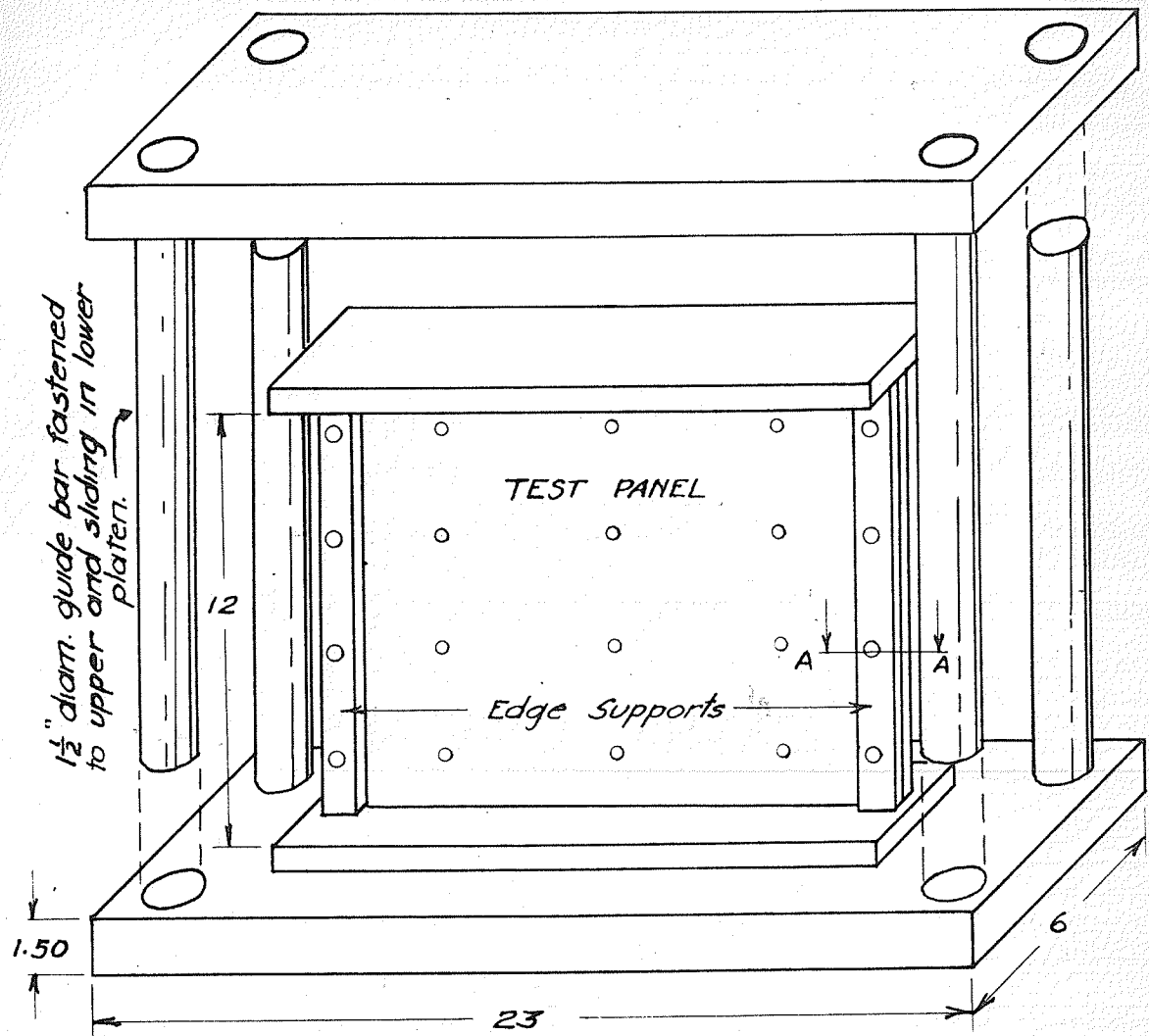

FIGURE 6

SECTION A-A THROUGH EDGE SUPPORT

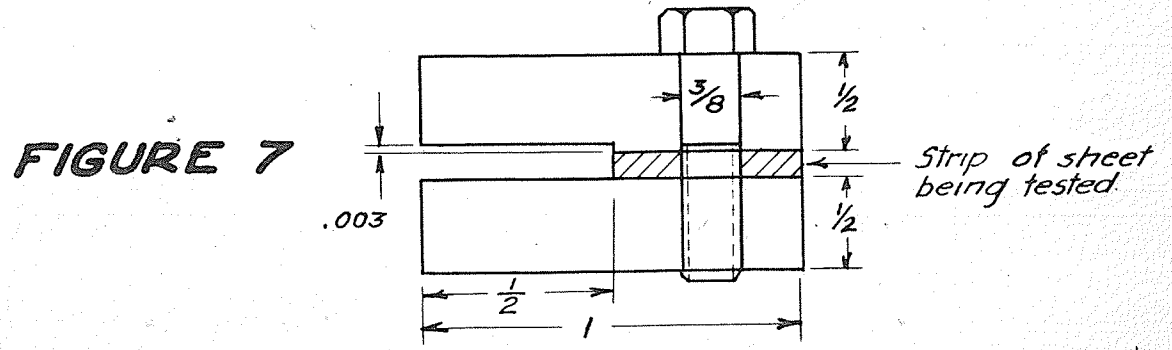

FIGURE 7

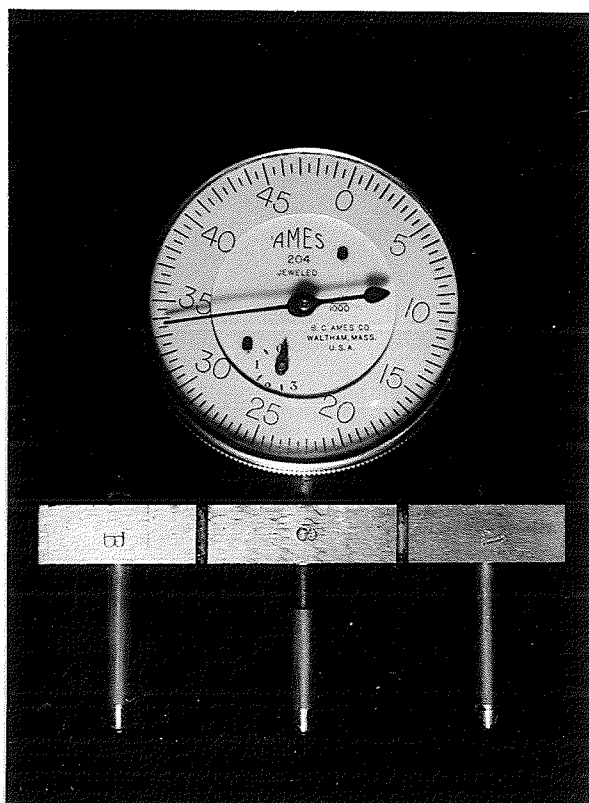
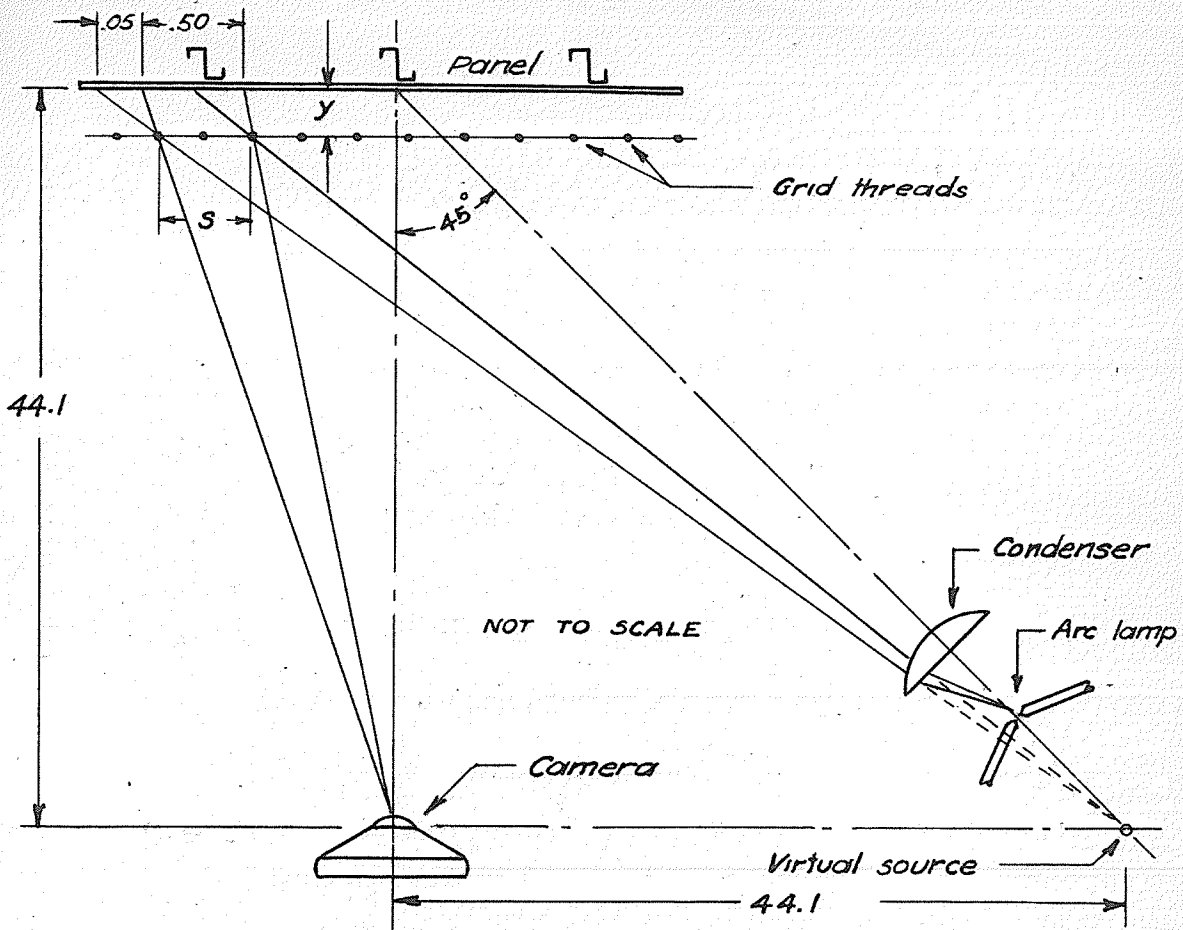

Figure 8.— Dial gauge used for measurement of inter-rivet buckle displacement.

GRID, CAMERA, AND LAMP ASSEMBLY



GRID

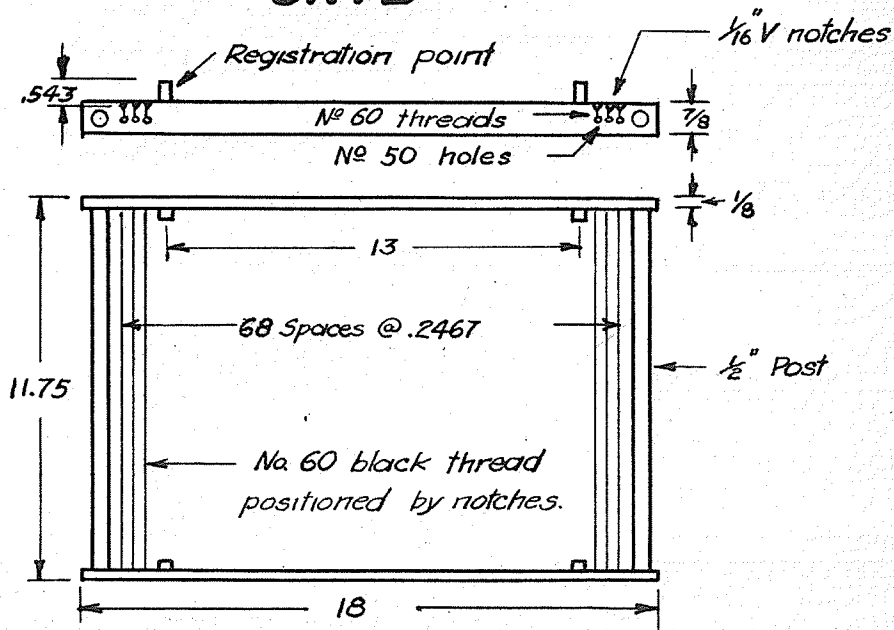

FIGURE 9 PHOTO-GRID EQUIPMENT

produced on a perfectly flat panel. Viewed from the camera location, the shadows were displaced one-twentieth inch to the left of the threads. Any deformation of the panel towards the grid resulted in an equal movement of the shadows to the right, and vice versa. A single photograph thus recorded the buckled form of the entire panel at any desired load. Deflections of the sheet at any point were subsequently determined by measurement of the shadow displacement recorded on the film. In the present investigation a thirty-five millimeter camera loaded with micro-file film was employed, and measurements of the negatives were accomplished with a microscope, using a thirty-two millimeter objective and a filar micrometer eyepiece. By suitable choice of camera and lamp positions, a calibration factor of .002 inches deflection per micrometer division was obtained. The actual dimensions used are indicated in Figure 9. Calculation of these distances is included in Chapter VI.

Considering the small size of the image on the film, which was less than one-twentieth of the panel size, the accuracy and sensitivity of the method was amazing. Panel deflections of .001 inches could be detected easily. The results of a calibration test of this equipment are given on page 30.

In some cases, dial gauges were used at the four corners of the platens to measure the over all compression strain of the panel. In one case, the lateral movement of

the top platen relative to the lower one was also measured with a dial gauge to check the fixity of the entire loading assembly.

The electrical resistance strain gauges used were connected to a Baldwin Type K Strain Indicator through a twenty point switching and balancing unit constructed for this particular project.

Tension and compression test specimens from sheet and stiffener stock were tested in a 10,000 pound Tinius Olsen testing machine, accurate to less than one-half of one per cent. Strain readings were made with a pair of Tuckerman strain gauges having a certified accuracy of one-tenth of one per cent, and a reading sensitivity of two micro-inches on a one inch gauge length. The Tuckerman gauge is well described by B. L. Wilson, National Bureau of Standards, Washington.¹ Compression tests of the sheet stock were accomplished with the use of a guiding fixture constructed especially for the work. The design of the fixture was substantially in accordance with one developed by the U. S. National Bureau of Standards.² The device, with specimen and strain gauges attached, is shown in Figure 10.

¹ B. L. Wilson, Characteristics of the Tuckerman Strain Gage, ASTM Proceedings, volume 44, 1944, page 1017.

² Op. Cit., page 683.

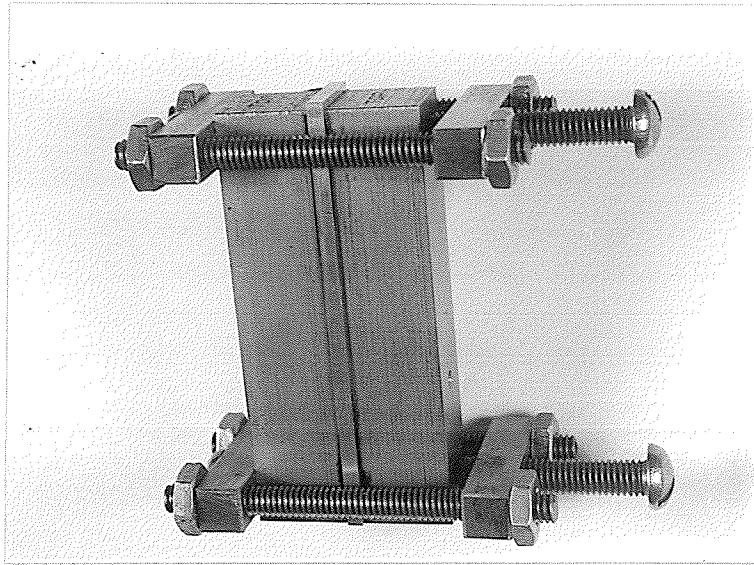

Specimen supported in compression testing guide.

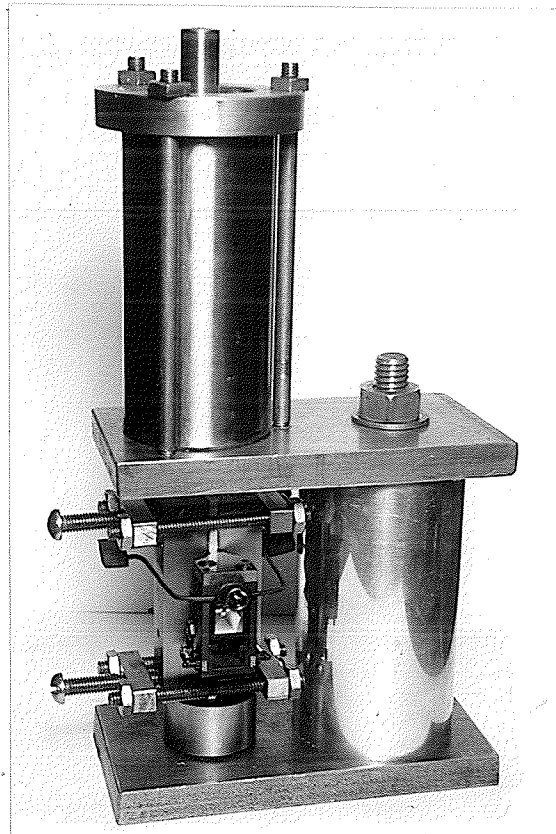

Specimen, guide, and Tucker-man gauges, assembled in subpress ready for test.

FIGURE 10

Test procedure. In general, the following sequence of operations was performed in testing a completed panel. The panel ends were first carefully cleaned and lightly scraped to remove accidental burrs or foreign matter adhering to them. The platens were then placed around the panel and the edge supports assembled, after which the entire assembly was centred in the testing machine. The electrical strain gauges were then connected, balanced to a predetermined initial reading and an initial load of 2,000 pounds was applied to the panel through a spherical loading head. Strain gauge readings were recorded at this load and at loads of 4,000 and 6,000 pounds. At loads of these magnitudes the strain readings should have indicated a condition of pure compression; that is, all strain readings should have been identical. Some adjustment of the panel laterally or front to back was usually necessary before uniform strain readings over this range of load were closely approached. When a satisfactory condition of uniform loading was attained, the photo-grid was fastened to the panel with rubber bands and the test proper was started. Strain readings, dial gauge readings, and photographs, were taken at 2,000 pound increments or less until the panel failed. The failing load and any peculiarities noticed during the test were recorded. After developing the film, the displacements of the sheet between rivets and

occasionally at other points, were measured using the micrometer eyepiece of the microscope.

Standard procedure was followed in testing the tension and compression samples for determining physical properties of the sheet. The specimen dimensions for these tests are shown in Figure 11.

Suitability of laboratory methods. The test equipment and laboratory technique which have been described were carefully thought out and thoroughly checked before actual testing of panels was begun. Considerable time, skill, and care, were required in the preparation of test specimens. For this reason alone, a procedure of testing which would adequately and consistently produce all the necessary data was absolutely necessary in order to avoid waste of time and material in the event of unsatisfactory behaviour of equipment during an actual test.

No difficulty resulting in invalidation of the test data was encountered in any test with any of the equipment. It can therefore be said, without question, that the equipment and technique used were entirely satisfactory at all times. The wealth of data accumulated, part of which is given in Chapter V is a confirmation of this statement.

TENSION SPECIMEN

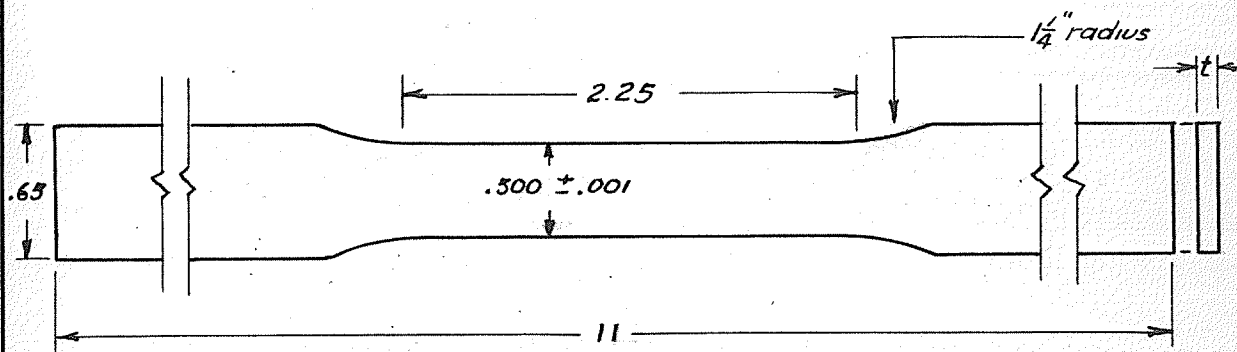

COMPRESSION SPECIMEN

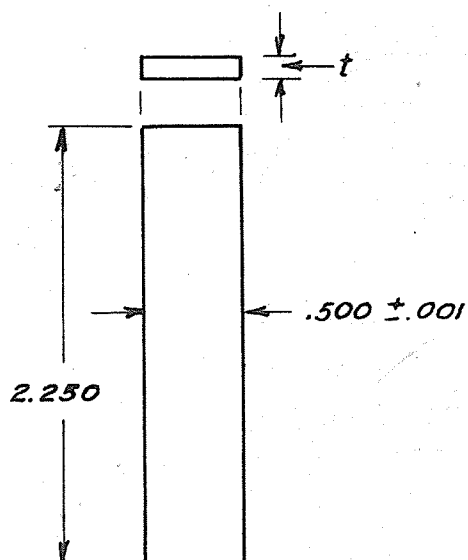

Ends to be flat, square, and parallel within $\pm .0001$ "

FIGURE 11 CONTROL SAMPLES

CHAPTER V

RECORDED TEST DATA

Organization of material. As many as possible of the experimental test data are presented in this chapter, including a calibration check of the photo-grid equipment. Strain readings of the electrical resistance gauges, as well as dial gauge readings, are given in tabular form, so that future investigators may use them directly for various determinations not included in the present work. Results of tension and compression tests of the sheet stock are given in graphical form. Because of the very large number of displacement readings from photo-grid measurements, these have been omitted, and this phase of the work is covered by only a few examples presented graphically. It is intended to file the micro-file film records along with this thesis so that a complete record of data will be available to any one interested.

Photo-grid calibration. The photo-grid equipment was calibrated by photographing a spray-painted sheet of plate glass in place of the usual test panel. Glass was used because of its superior surface flatness and rigidity. Shims of various thicknesses were placed under the grid registration points to displace it definite amounts from

glass surface. Photographs were taken with each set of shims in place, and without any shims. The shim thickness was then computed from measurements on the film negatives and compared with the actual values obtained by direct measurement. In addition, the grid spacing was determined and compared with the theoretical spacing. Film measurements were made at five points in each case. The results obtained are given in Table I.

TABLE I
CALIBRATION OF PHOTO-GRID EQUIPMENT

Point	Readings for shims in inches		
	No. 1	No. 2	No. 3
1	.0135	.0355	.0025
2	.0137	.0357	.0032
3	.0153	.0358	.0038
4	.0157	.0357	.0042
5	.0143	.0373	.0053
Mean			
Reading0145	.0360	.0038
Actual			
Value0138	.0343	.0038

It can be seen from the above Table that the accuracy of grid measurements is of the order of .001 inches.

A check of the grid spacing at five points gave a mean reading of 0.249 inches compared with a theoretical value of 0.250 inches.

Strain and dial gauge readings. Tables II to LVI contain the electrical resistance strain gauge and dial gauge readings, and dimensions of each panel tested. The gauge positions are given by reference to the appropriate sketch shown in Figure 12. Terminology for panel dimensions is as follows:

t = sheet thickness
L = rivet pitch
b = stiffener pitch
W = panel width
N = number of stiffeners

All dimensions are given in inches, loads in pounds, strain gauge readings in micro-inches per inch, and dial gauge readings in inches. The strain gauges are designated by number and dial gauges by lower case letters.

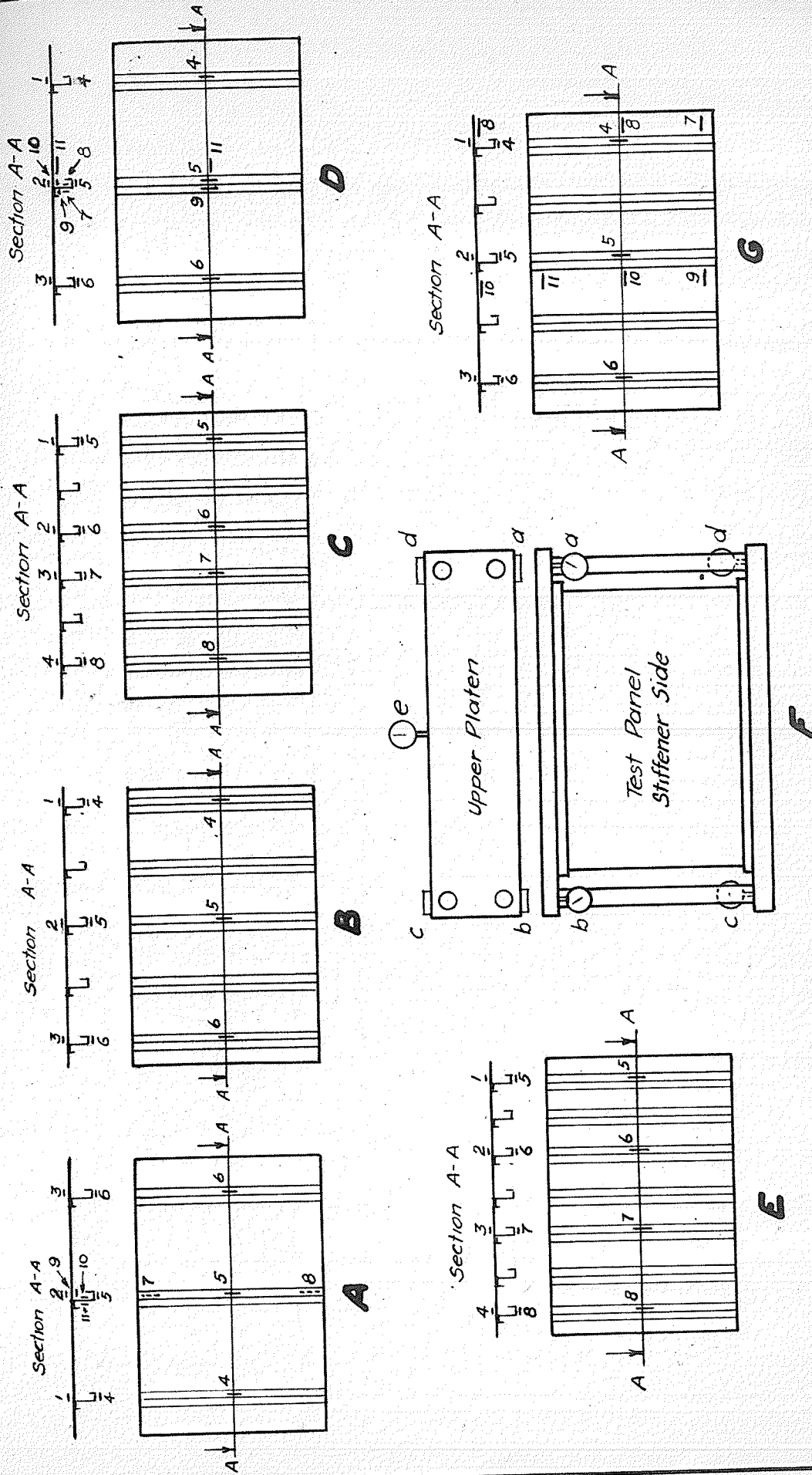

FIGURE 12 ARRANGEMENTS OF STRAIN GAUGES AND DIALS

TABLE II

STRAIN READINGS FOR PANEL 1

t = .0830 in. L = 2.00 in. b = 4.00 in.
W = 16 in. N = 3

Gauge arrangement A, Figure 12

Gauge readings in micro-inches per inch

Load	1	2	3	4	5	6	7	8	9	10	11
0	0	0	0	0	0	0	0	0	0	0	0
2000	118	117	120	107	131	124	77	128	120	124	126
4000	246	239	241	222	258	227	167	248	243	250	253
6000	363	357	360	332	384	342	254	366	362	367	378
8000	487	478	475	447	514	474	358	479	488	494	506
10000	620	617	599	590	666	621	480	606	620	632	648
12000	753	749	715	734	811	770	588	726	748	762	788
14000	891	881	832	882	960	912	703	848	879	895	928
16000	1030	1015	942	1015	1091	1023	820	970	1007	1021	1071
18000	1176	1152	1043	1143	1215	1147	942	1095	1137	1146	1213
20000	1328	1287	1132	1277	1356	1304	1060	1222	1270	1271	1360
22000	1498	1420	1212	1411	1508	1450	1172	1351	1402	1387	1520
24000	1748	1542	1322	1527	1671	1634	1262	1496	1563	1481	1713
24650	Ultimate load										

TABLE III

STRAIN READING FOR PANEL 2

$t = .0820$ in. $L = 2.50$ in. $b = 2.50$ in.
 $W = 15$ in. $N = 5$

Gauge arrangement B, Figure 12

Gauge readings in micro-inches per inch

Load	1	2	3	4	5	6
0	0	0	0	0	0	0
2000	94	106	107	130	148	153
4000	212	240	228	245	262	260
6000	332	362	343	365	382	373
8000	441	492	456	477	494	500
10000	554	620	568	590	610	600
12000	674	722	673	703	730	705
14000	782	832	776	815	850	817
16000	887	960	880	935	970	915
18000	977	1075	973	1060	1090	1020
20000	1074	1138	1046	1160	1202	1113
22000	1132	1130	1100	1283	1330	1217
24000	1132	950	1104	1430	1478	1350
25000	1084	745	1070	1505	1565	1420
26000	902	252	970	1575	1692	1500
26500	512	-458	800	1663	1849	1587
26700	260	-1152	608	1720	1990	1667
27000	-1353 ^a	-2875	-182	1997	2548	2003
27500	-1413	-3625	-812	2293	3015	2295
28000	-3450	-4445	-1487	2605	3528	2610
28500	-4113	-4901	-1992	2855	4110	2910
29000	-5103	-5720	-3022	3625	6035	3665
29300	Ultimate load					

a Negative readings indicate tension strains.

TABLE IV

STRAIN READING FOR PANEL 3

$$t = .0830 \text{ in.} \quad L = 2.00 \text{ in.} \quad b = 3.20 \text{ in.}$$

$$W = 16 \text{ in.} \quad N = 4$$

Gauge arrangement C, Figure 12

Gauge readings in micro-inches per inch

Load	1	2	3	4	5	6	7	8
0	0	0	0	0	0	0	0	0
2000	108	114	108	103	119	130	120	124
4000	234	241	235	214	219	244	250	248
6000	348	371	358	318	330	374	384	369
8000	467	495	480	421	443	503	512	481
10000	586	616	603	523	557	626	637	591
12000	709	744	732	628	677	758	767	709
14000	821	860	854	728	794	886	893	817
16000	939	981	982	828	914	1022	1023	934
18000	1055	1097	1104	928	1034	1155	1162	1057
20000	1166	1205	1222	1018	1159	1292	1302	1179
22000	1257	1297	1320	1090	1278	1426	1442	1300
24000	1334	1347	1385	1138	1409	1574	1590	1428
26000	1336	1245	1307	1107	1560	1753	1766	1569
27000	1186	859	990	973	1679	1903	1900	1654
27500	Ultimate Load							

TABLE V

STRAIN READING FOR PANEL 4

$t = .0830$ in. $L = 2.50$ in. $b = 4.00$ in.
 $W = 16$ in. $N = 3$

Gauge arrangement B, Figure 12

Gauge readings in micro-inches per inch

Load	1	2	3	4	5	6
0	0	0	0	0	0	0
5000	268	248	230	215	192	120
10000	570	528	502	540	520	386
15000	795	713	730	875	863	671
17000	760	723	770	1025	1017	796
18000	650	540	740	1125	1123	861
19000	390	163	620	1565	1270	951
20000	-300 ^a	-942	75	1865	1615	---
23360	Ultimate Load					

a Negative readings indicate tension strains

TABLE VIII
STRAIN READING FOR PANEL 7

$t = .0800$ in. $L = 2.00$ in. $b = 2.50$ in.
 $W = 15$ in. $N = 5$

Gauge arrangement B, Figure 12

Gauge readings in micro-inches per inch

Load	1	3	4	5	6
0	0	0	0	0	0
2000	115	115	85	78	102
4000	240	230	204	206	210
6000	370	330	325	333	322
8000	495	430	435	458	444
10000	598	518	560	586	560
12000	724	614	695	718	679
14000	848	714	825	848	790
16000	980	807	860	988	905
18000	1120	880	905	1120	1020
20000	1250	932	1030	1253	1127
22000	1382	980	1160	1388	1238
24000	1522	1012	1285	1516	1340
26000	1655	962	1415	1652	1452
28000	1795	864	1540	1790	1560
30000	1955	871	1657	1910	1657
32000	2210	1046	1755	2003	1765
33200	Ultimate load				

TABLE IX

STRAIN READINGS FOR PANEL 8

$t = .0665$ in. $L = 1.50$ in. $b = 3.20$ in.
 $W = 16$ in. $N = 4$

Gauge arrangement C, Figure 12

Gauge readings in micro-inches per inch

Load	1	2	3	4	5	6	7	8
1000	0	0	0	0	0	0	0	0
3000	142	143	141	140	139	142	146	150
5000	288	288	282	280	289	282	284	292
7000	432	440	430	417	420	421	426	410
9000	578	603	582	552	557	566	571	547
11000	722	776	722	688	696	702	712	680
13000	873	898	837	827	844	817	861	835
15000	1011	1043	940	957	989	944	1010	985
17000	1160	1140	1057	1090	1116	1082	1165	1141
19000	1305	1258	1131	1220	1256	1222	1327	1300
20000	1385	1318	1254	1288	1322	1295	1405	1380
21000	1455	1340	1263	1358	1385	1377	1494	1462
22000	1558	1288	1253	1499	1546	1483	1605	1555
26050	Ultimate load							

TABLE X

STRAIN READINGS FOR PANEL 9

$t = .064$ in. $L = 2,00$ in. $b = 3.2$ in.
 $W = 16$ in. $N = 4$

Gauge arrangement C, Figure 12

Gauge readings in micro-inches per inch

Load	1	2	3	4	5	6	7	8
1000	0	0	0	0	0	0	0	0
3000	136	132	144	158	139	138	114	110
5000	272	269	288	310	283	275	246	246
7000	409	403	428	458	424	411	376	401
9000	545	542	569	608	570	548	480	558
11000	475	678	710	758	707	682	601	712
13000	810	825	870	923	854	820	737	878
15000	960	997	1053	1108	1006	969	882	1045
17000	1140	1133	1198	1238	1148	1106	1014	1200
18000	1288	1336	1412	1443	1223	1176	1079	1270
19000	1560	1646	1703	1708	1285	1242	1134	1340
20000	1880	2018	2063	2113	1373	1337	1220	1430
23075	Ultimate load							

TABLE XI

STRAIN READINGS FOR PANEL 10

t = .0650 in. L = 2.50 in. b = 3.20 in.
 W = 16 in. N = 4

Gauge arrangement C, Figure 12

Gauge readings in micro-inches per inch

Load	1	2	3	4	5	6	7	8
1000	0	0	0	0	0	0	0	0
3000	132	141	141	154	123	117	109	113
5000	262	273	273	295	253	245	228	233
7000	362	401	407	425	386	375	356	473
9000	440	520	525	552	516	487	471	613
11000	471	609	615	652	645	601	608	755
13000	452	608	611	684	781	732	751	906
14000	400	512	506	615	851	805	827	985
15000					935	895	921	1080
16000					1049	1034	1051	1197
17000					1226	1237	1241	1387
18000					1431	1485	1481	1630
19000					1693	1815	1761	1745
20000					1996	2167	2106	2074
21000					2384	2575	2668	2570
21750	Ultimate load							

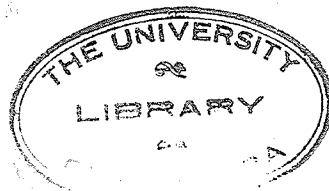

TABLE XII

STRAIN READINGS FOR PANEL 11

$t = .0655$ in. $L = 3.00$ in. $b = 3.20$ in.
 $W = 16$ in. $N = 4$

Gauge arrangement C, Figure 12

Load	1	2	3	4	5	6	7	8
1000	0	0	0	0	0	0	0	0
2000	63	68	69	65	61	78	75	71
3000	130	132	137	135	140	142	144	137
4000	201	200	206	203	227	209	206	195
5000	267	265	272	271	309	280	274	256
6000	333	328	339	327	390	355	341	321
7000	398	390	400	378	462	437	413	390
8000	457	450	457	423	539	519	486	470
9000	507	498	508	463	617	600	556	549
10000	547	531	532	483	699	688	626	633
11000	570	530	530	463	769	765	694	711
12000	553	430	383	362	851	850	774	801
13000	358	-80 ^a	-260	-67	954	985	896	929
18000	Ultimate load							

a Negative readings indicate tension strains.

TABLE XIII

STRAIN READINGS FOR PANEL 12

$t = .0403$ in. $L = 1.00$ in. $b = 3.20$ in.
 $W = 16$ in. $N = 4$

Gauge arrangement C, Figure 12

Gauge readings in micro-inches per inch

Load	1	2	3	4	5	6	7	8
1000	0	0	0	0	0	0	0	0
2000	96	104	108	101	90	90	77	76
3000	192	208	212	205	182	205	182	160
4000	282	305	312	302	270	310	281	246
5000	377	407	414	402	363	420	382	343
6000	469	508	509	503	464	527	500	439
7000	557	623	580	634	578	640	614	554
8000	662	925	569	896	696	769	749	---
9000	752	1165	614	1114	816	913	881	846
18975	Ultimate load							

TABLE XIV

STRAIN READINGS FOR PANEL 13

$t = .082$ in. $L = 1.50$ in. $b = 2.50$ in.
 $W = 15$ in. $N = 5$

Gauge arrangement B, Figure 12

Gauge readings in micro-inches per inch

Load	1	2	3	4	5	6
1000	0	0	0	0	0	0
3000	115	118	104	108	115	90
5000	233	240	222	232	235	205
7000	352	365	339	371	355	324
9000	464	485	453	508	470	448
11000	575	602	571	647	582	579
13000	687	723	684	792	703	722
15000	795	848	806	938	823	867
17000	910	976	932	1100	955	1020
19000	1018	1094	1042	1242	1070	1160
21000	1122	1213	1162	1393	1177	1310
22000	1179	1276	1221	1468	1234	1384
23000	1238	1337	1282	1541	1292	1458
24000	1294	1396	1339	1619	1345	1535
25000	1347	1458	1401	1696	1400	1606
26000	1394	1516	1459	1768	1457	1681
27000	1450	1579	1522	1837	1505	1745
28000	1501	1646	1591	1923	1563	1829
29000	1546	1703	1642	1990	1615	1899
30000	1600	1769	1712	2073	1675	1975
31000	1644	1828	1770	2143	1730	2045
32000	1750	1888	1830	2217	1785	2120
33000	1790	1952	1898	2298	1845	2194
34000	1834	1923	1962	2377	1906	2266
35000	1872	2075	2032	2458	1970	2340
36000	1905	2131	2092	2533	2027	2414
37000	1927	2193	2154	2603	2083	2480
38000	1934	2248	2222	2639	2134	2547
39000	1934	2302	2294	2763	2195	2620
40000	1904	2332	2377	2853	2273	2698
41080	Ultimate load -- sudden failure					

TABLE XV

STRAIN READINGS FOR PANEL 14

t = .0810 in. L = 2.25 in. b = 2.50 in.
 W = 15 in. N = 5

Gauge arrangement B, Figure 12

Gauge readings in micro-inches per inch

Load	1	2	3	4	5	6
1000	0	0	0	0	0	0
3000	120	120	113	100	101	119
5000	240	242	233	215	220	248
7000	357	363	350	342	335	369
9000	470	468	468	363	453	496
11000	585	570	588	454	570	624
13000	704	665	718	543	698	759
15000	820	727	848	674	823	901
17000	935	850	968	808	948	1029
18000	990	904	1030	868	1010	1096
19000	1071	952	1093	942	1077	1164
20000	1121	984	1152	999	1138	1232
21000	1175	1018	1212	1047	1206	1302
22000	1225	1046	1268	1107	1267	1367
23000	1267	1069	1318	1165	1325	1429
24000	1308	1099	1373	1230	1388	1497
25000	1345	1122	1421	1300	1356	1564
26000	1375	1129	1460	1365	1428	1634
27000	1400	1139	1498	1430	1488	1697
28000	1395	1108	1502	1498	1663	1767
29000	1369	1017	1357	1570	1748	1849
30000	1300	829	1263	1645	1848	1929
30940	Ultimate load					

TABLE XVII

STRAIN READINGS FOR PANEL 16

$$t = .0405 \text{ in.} \quad L = 0.75 \quad b = 3.20 \text{ in.}$$

$$W = 16 \text{ in.} \quad N = 4$$

Gauge arrangement C, Figure 12

Gauge readings in micro-inches per inch

Load	1	2	3	4	5	6	7	8
1000	0	0	0	0	0	0	0	0
2000	74	86	94	98	62	60	75	90
3000	173	188	199	205	155	154	170	189
4000	268	285	299	305	262	252	263	292
5000	368	385	409	413	337	361	365	407
6000	462	460	524	495	574	465	473	524
7000	585	504	791	540	787	575	603	657
7500	658	523	843	590	875	637	679	732
8000	740	545	940	634	945	689	743	793
8500	838	580	1056	647	998	761	822	865
20520	Ultimate load							

TABLE XVIII

STRAIN READING FOR PANEL 17

$t = .0405$ $L = 1.25$ in. $b = 3.20$ in.
 $W = 16$ in. $N = 4$

Gauge arrangement C, Figure 12

Gauge readings in micro-inches per inch

Load	1	2	3	4	5	6	7	8
1000	0	0	0	0	0	0	0	0
2000	102	110	105	109	86	80	92	84
3000	195	205	208	206	178	173	200	177
4000	289	305	310	304	271	268	292	267
5000	378	403	408	402	366	365	396	369
6000	477	505	521	516	466	471	504	465
7000	627	598	603	659	572	580	612	567
7500	700	660	743	757	636	643	675	627
8000	740	718	813	849	696	708	736	682
9000	876	853	963	1054	818	843	869	805
10000	1033	998	1123	1279	956	995	1020	940
11000	1192	1140	1308	1479	1982	1143	1160	1074
12000	1368	1281	1543	1689	1230	1298	1304	1187
13000	1580	1423	1732	1889	1372	1445	1453	1310
14000	1815	1598	1900	1993	1531	1598	1619	1428
15000	2047	1852	2343	2281	1694	1745	1772	1542
16490	Ultimate load							

TABLE XIX

STRAIN READINGS FOR PANEL 18

$t = .0405$ in. $L = 1.75$ in. $b = 3.20$ in.
 $W = 16$ in. $N = 4$

Gauge arrangement C, Figure 12

Gauge readings in micro-inches per inch

Load	1	2	3	4	5	6	7	8
1000	0	0	0	0	0	0	0	0
2000	102	109	101	101	75	77	81	79
3000	197	206	195	194	162	169	183	169
4000	293	299	284	272	260	275	289	262
5000	392	380	371	351	362	378	392	349
6000	547	415	451	428	467	486	504	437
6500	705	410	543	476	530	539	566	484
7000	816	427	640	521	590	596	626	535
7500	915	460	732	578	652	652	686	591
16200	Ultimate load							

TABLE XX

STRAIN READINGS FOR PANEL 19

$$t = .0800 \text{ in.} \quad L = 1.75 \text{ in.} \quad b = 2.50 \text{ in.}$$

$$W = 15 \text{ in.} \quad N = 5$$

Gauge arrangement B, Figure 12

Gauge readings in micro-inches per inch

Load	1	2	3	4	5	6
2000	0	0	0	0	0	0
4000	110	115	131	95	110	122
6000	217	230	256	205	231	248
8000	324	340	377	323	352	382
10000	432	455	496	443	477	519
12000	540	567	613	563	599	656
14000	642	675	728	683	721	791
16000	749	790	844	803	845	930
18000	849	1100	966	931	978	1077
20000	947	1015	1082	1048	1098	1213
22000	1050	1133	1207	1175	1230	1360
24000	1150	1250	1328	1304	1360	1507
26000	1249	1368	1444	1424	1488	1639
28000	1342	1495	1592	1553	1627	1767
30000	1435	1620	1715	1673	1755	1897
31000	1480	1688	1778	1733	1820	1962
32000	1532	1762	1855	1801	1895	2028
33000	1580	1840	1930	1863	1965	2088
34000	1623	1926	2017	1925	2031	2145
35000	1666	2012	2099	1983	2090	2190
36000	1715	2155	2112	2043	2147	2230
37010	Ultimate load					

TABLE XXI

STRAIN READINGS FOR PANEL 20

$t = .0815$ in. $L = 2.50$ in. $b = 3.00$ in.
 $W = 15$ in. $N = 4$

Gauge arrangement C, Figure 12

Gauge readings in micro-inches per inch

Load	1	2	3	4	5	6	7	8
2000	0	0	0	0	0	0	0	0
4000	129	122	117	120	117	122	114	112
6000	252	237	235	234	244	248	239	222
8000	374	355	348	342	362	368	360	333
10000	496	470	457	452	492	492	482	455
12000	619	589	576	561	622	618	609	582
14000	741	707	686	670	762	744	739	710
15000	801	767	747	726	832	807	802	770
16000	859	822	797	774	892	823	862	828
17000	922	883	857	831	965	928	931	895
18000	979	938	911	882	1032	990	992	955
19000	1037	993	964	932	1100	1053	1054	1015
20000	1092	1045	1017	981	1170	1113	1120	1079
21000	1149	1100	1068	1031	1240	1177	1184	1142
22000	1201	1153	1122	1081	1312	1245	1255	1210
23000	1256	1203	1171	1127	1382	1301	1319	1272
24000	1304	1245	1214	1170	1449	1366	1382	1332
25000	1347	1284	1254	1211	1522	1433	1449	1396
26000	1384	1315	1289	1251	1597	1500	1519	1465
27000	1408	1332	1314	1282	1667	1562	1583	1525
28000	1396	1315	1313	1310	1750	1638	1662	1597
29000	1309	1230	1279	1318	1832	1703	1735	1660
30750	Ultimate load							

TABLE XXII

STRAIN READINGS FOR PANEL 21

$t = .0800$ in. $L = 3.00$ in. $b = 3.00$ in.
 $W = 15$ in. $N = 4$

Gauge arrangement C, Figure 12

Gauge readings in micro-inches per inch

Load	1	2	3	4	5	6	7	8
2000	0	0	0	0	0	0	0	0
4000	129	125	119	120	67	96	103	110
6000	246	237	237	232	190	220	224	230
8000	363	355	350	342	309	345	358	359
10000	476	472	462	443	457	475	491	481
12000	586	587	569	537	587	609	622	610
14000	689	697	677	624	712	746	758	740
15000	731	743	720	662	795	815	823	805
16000	769	787	757	694	857	885	893	875
17000	801	819	786	722	928	961	960	931
18000	816	834	792	719	1004	1032	1026	1010
19000	792	804	768	708	1085	1113	1102	1080
26500	Ultimate load							

TABLE XXIII

STRAIN READINGS FOR PANEL 22

t = .0810 in. L = 1.50 in. b = 2.00 in.
W = 16 in. N = 7

Gauge arrangement E, Figure 12

Gauge readings in micro-inches per inch

Load	1	2	3	4	5	6	7	8
2000	0	0	0	0	0	0	0	0
4000	94	118	96	85	90	80	88	70
6000	184	215	187	163	203	182	141	164
8000	270	314	277	241	328	293	221	265
10000	354	411	368	315	455	408	316	371
12000	441	508	462	392	582	521	401	476
14000	527	594	550	464	707	635	558	584
16000	616	685	648	543	835	752	761	693
18000	704	767	744	621	963	870	978	806
20000	786	851	837	693	1093	985	1022	919
22000	872	935	932	770	1218	1105	1163	1036
24000	956	1016	1027	845	1348	1222	1202	1143
26000	1038	1094	1119	920	1470	1338	1228	1259
28000	1121	1174	1211	993	1593	1458	1445	1372
30000	1203	1254	1307	1068	1723	1583	1345	1489
32000	1278	1326	1395	1133	1843	1698	1371	1600
34000	1355	1397	1487	1203	1968	1825	1475	1725
36000	1426	1467	1577	1271	2078	1942	1566	1831
38000	1496	1534	1666	1336	2213	2067	1672	1949
40000	1560	1596	1754	1399	2349	2197	1778	2063
42000	1614	1654	1832	1456	2482	2322	1878	2169
44000	1648	1697	1902	1503	2615	2448	1978	2283
45000	1664	1722	1936	1528	2674	2518	2033	2341
46000	1657	1733	1959	1548	2743	2587	2084	2398
47000	1626	1733	1971	1564	2792	2663	2133	2454
48000	1564	1708	1968	1579	2866	2748	2190	2509
49000	1446	1681	1942	1588	2959	2852	2225	2567
50000	Ultimate load							

TABLE XXIV

STRAIN READINGS FOR PANEL 23

$t = .0810$ in. $L = 2.50$ in. $b = 3.00$ in.
 $W = 15$ in. $N = 4$

Gauge arrangement C, Figure 12

Gauge readings in micro-inches per inch

Load	1	3	4	5	6	7	8
2000	0	0	0	0	0	0	0
4000	143	135	123	88	94	100	86
6000	260	258	237	197	212	213	191
8000	330	387	353	320	344	341	304
10000	437	518	473	455	473	473	421
12000	545	640	583	585	612	598	527
14000	650	768	700	725	736	735	648
16000	750	890	807	853	868	869	765
18000	820	997	891	983	1000	1000	886
20000	885	1085	959	1113	1154	1135	1013
21000	902	1104	984	1185	1229	1213	1078
22000	890	1085	981	1260	1392	1289	1143
23000	802	950	916	1353	1481	1302	1213
24000	398	---	---	----	----	----	----
26280	Ultimate load						

TABLE XXV

STRAIN READINGS FOR PANEL 24

$t = .0805$ in. $L = 1.75$ in. $b = 3.00$ in.
 $W = 15$ in. $N = 4$

Gauge arrangement C, Figure 12

Gauge readings in micro-inches per inch

Load	2	3	4	5	6	7	8
2000	0	0	0	0	0	0	0
4000	136	130	129	136	138	112	97
6000	255	250	244	259	265	237	208
8000	384	376	364	388	396	368	336
10000	514	503	486	518	528	500	469
12000	641	628	608	649	659	631	600
14000	764	751	726	776	795	767	733
16000	888	873	843	897	918	891	860
18000	1026	1008	971	1032	1058	1032	1002
20000	1156	1138	1096	1164	1195	1174	1148
22000	1293	1270	1219	1288	1323	1307	1279
24000	1433	1405	1341	1420	1451	1440	1416
26000	1576	1540	1468	1556	1585	1582	1560
28000	1735	1690	1600	1693	1718	1725	1703
29000	1821	1768	1668	1759	1782	1792	1774
30000	1927	1856	1749	1827	1848	1862	1850
31000	2039	1943	1821	1886	1904	1926	1925
32000	2187	2048	1912	1943	1955	1987	2000
33000	2316	2166	2024	1996	1993	2035	2062
34000	2558	2383	2271	2044	2000	2044	2108
34350	Ultimate load						

TABLE XXVI

STRAIN READING FOR PANEL 25

$t = .0805$ in. $L = 1.75$ in. $b = 3.00$ in.
 $W = 15$ in. $N = 4$

Gauge arrangement C, Figure 12

Gauge readings in micro-inches per inch

Load	1	2	3	4	5	6	7	8
2000	0	0	0	0	0	0	0	0
4000	120	118	125	122	105	111	136	121
6000	233	238	257	249	225	239	263	241
8000	337	346	375	363	351	358	384	360
10000	448	552	502	490	468	492	521	492
12000	551	647	622	606	581	618	655	617
14000	657	746	748	730	681	748	789	747
16000	761	840	870	852	786	879	925	880
18000	862	923	992	967	898	1011	1066	1019
20000	959	1016	1132	1100	1025	1143	1200	1151
22000	1062	1105	1275	1231	1147	1277	1348	1212
23000	1107	1144	1352	1295	1193	1332	1412	1356
24000	1150	1185	1432	1363	1249	1395	1485	1425
25000	1198	1228	1508	1438	1306	1464	1564	1496
26000	1248	1272	1598	1521	1331	1532	1640	1565
27000	1297	1313	1692	1613	1381	1603	1721	1637
28000	1356	1362	1783	1722	1453	1665	1794	1706
29000	1416	1412	1895	1839	1511	1736	1885	1774
30000	1553	1546	-----	-----	-----	-----	-----	-----
30000	Ultimate load							

TABLE XXVII

STRAIN READINGS FOR PANEL 26

$$t = .0810 \text{ in.} \quad L = 1.75 \text{ in.} \quad b = 2.00 \text{ in.}$$

$$W = 16 \text{ in.} \quad N = 7$$

Gauge arrangement E, Figure 12

Gauge readings in micro-inches per inch

Load	1	2	3	4	5	6	7	8
2000	0	0	0	0	0	0	0	0
4000	124	104	118	117	91	97	99	94
6000	194	193	220	210	175	196	202	186
8000	277	282	317	300	254	291	301	267
10000	366	372	417	393	336	389	401	350
12000	440	454	508	479	410	478	492	432
14000	519	542	606	568	508	571	591	519
16000	602	631	707	660	578	672	696	617
18000	674	716	804	753	656	763	789	707
20000	759	802	903	828	753	861	890	799
22000	841	890	1003	897	847	959	994	894
24000	919	973	1100	981	945	1054	1099	992
26000	1001	1061	1202	1076	1015	1154	1200	1077
28000	1079	1140	1298	1164	1092	1246	1300	1169
30000	1164	1227	1395	1256	1176	1344	1403	1267
32000	1242	1315	1485	1353	1202	1359	1508	1358
34000	1326	1402	1588	1444	1172	1330	1608	1447
36000	1402	1488	1691	1535	1319	1421	1705	1536
37000	1442	1528	1740	1579	1333	1466	1753	1577
38000	1481	1572	1783	1628	1367	1515	1805	1617
39000	1524	1620	1833	1673	1401	1559	1851	1667
40000	1555	1670	1885	1720	1436	1604	1893	1697
41000	1599	1649	1940	1776	1429	1649	1938	1737
42000	1644	1696	1945	1826	----	1696	1986	1779
43000	1677	1758	2055	1978	----	1741	2024	1815
44000	1723	1828	2139	2033	----	1779	2055	1850
45000	1760	1913	2246	2098	----	1821	2079	1892
45900	Ultimate load							

TABLE XXVIII

STRAIN READINGS FOR PANEL 27

$$t = .0815 \text{ in.} \quad L = 2.50 \text{ in.} \quad b = 2.286 \text{ in.}$$

$$W = 16 \text{ in.} \quad N = 6$$

Gauge arrangement C, Figure 12

Gauge readings in micro-inches per inch

Load	1	2	3	4	5	6	7	8
2000	0	0	0	0	0	0	0	0
4000	108	111	99	80	88	87	98	82
6000	209	220	193	158	189	182	204	171
8000	305	323	292	241	293	283	313	261
10000	397	407	383	324	401	384	422	351
12000	490	477	472	399	503	480	523	434
14000	588	539	561	478	611	579	629	521
16000	682	608	647	554	717	673	731	593
18000	773	670	724	627	818	762	831	676
19000	822	701	762	667	878	805	884	707
20000	855	731	795	696	918	841	932	744
21000	898	768	829	734	966	880	981	982
22000	946	803	860	771	1020	923	1038	824
23000	990	828	891	804	1067	962	1084	864
24000	1033	848	917	834	1120	1007	1137	902
25000	1075	865	935	864	1172	1049	1192	944
26000	1102	873	948	891	1221	1079	1239	980
27000	1142	883	950	916	1274	1121	1292	1021
28000	1165	871	938	935	1324	1161	1344	1064
29000	1165	830	902	946	1381	1203	1403	1103
30000	1151	759	832	956	1438	1248	1466	1148
33210	Ultimate load							

TABLE XXIX

STRAIN READINGS FOR PANEL 28

t = .0805 in. L = 2.00 in. b = 2.286 in.
 W = 16 in. N = 6

Gauge arrangement C, Figure 12

Gauge readings in micro-inches per inch

Load	1	2	3	4	5	6	7	8
2000	0	0	0	0	0	0	0	0
4000	91	109	107	108	94	103	109	98
6000	179	219	214	216	198	204	219	195
8000	264	329	324	324	303	314	330	289
10000	349	441	431	411	406	433	445	396
12000	433	553	539	477	511	554	578	518
14000	515	661	644	561	612	678	704	644
16000	599	774	751	657	714	801	829	770
18000	685	887	858	753	816	927	959	897
20000	770	1000	969	851	924	1052	1084	1025
22000	856	1110	1071	940	1020	1172	1201	1150
24000	942	1227	1181	1039	1126	1300	1330	1281
26000	1029	1342	1290	1135	1231	1423	1455	1411
28000	1118	1459	1397	1229	1332	1544	1579	1539
30000	1207	1581	1508	1322	1437	1671	1709	1674
32000	1287	1710	1629	1422	1544	1789	1832	1804
33000	1320	1776	1688	1477	1597	1851	1893	1864
34000	1360	1849	1749	1531	1645	1905	1949	1929
35000	1405	1929	1821	1601	1695	1957	2000	1991
36000	1450	2009	1909	1692	1746	2010	2050	2054
37000	1503	2112	2043	1750	1804	2057	2090	2114
37950	Ultimate load							

TABLE XXX

STRESS READINGS FOR PANEL 29

$t = .0825$ in. $L = 3.00$ in. $b = 2.00$ in.
 $W = 16$ in. $N = 7$

Gauge arrangement E, Figure 12

Gauge readings in micro-inches per inch

Load	1	2	3	4	5	6	7	8
2000	0	0	0	0	0	0	0	0
4000	87	88	100	98	103	98	94	88
6000	177	182	205	200	216	205	190	183
8000	261	270	310	292	318	302	295	275
10000	349	360	413	395	423	415	405	373
12000	429	452	515	493	521	515	508	463
14000	509	543	620	587	626	618	617	564
16000	589	635	727	685	728	723	725	665
18000	669	724	829	776	826	823	830	763
20000	745	818	935	874	928	923	931	860
22000	817	903	1042	966	1027	1023	1033	952
24000	887	995	1145	1060	1128	1124	1135	1046
26000	954	1080	1255	1155	1226	1226	1239	1143
28000	1016	1162	1363	1242	1321	1323	1339	1238
30000	1061	1249	1488	1340	1425	1422	1435	1332
32000	1084	1313	1598	1435	1520	1518	1525	1420
33000	1080	1347	1660	1496	1576	1569	1573	1468
34000	1073	1381	1737	1584	1631	1615	1604	1513
35000	929	752	1333	1450	-----	-----	-----	-----
36460	Ultimate load							

TABLE XXXI

STRAIN READINGS FOR PANEL 30

$t = .0815$ in. $L = 3.00$ in. $b = 2.286$ in.
 $W = 16$ in. $N = 6$

Gauge arrangement C, Figure 12

Gauge readings in micro-inches per inch

Load	1	2	3	4	5	6	7	8
2000	0	0	0	0	0	0	0	0
4000	114	112	108	93	93	103	101	89
6000	230	221	212	185	194	217	215	197
8000	336	325	315	276	307	339	336	308
10000	442	420	414	364	425	456	459	415
12000	550	520	509	453	544	576	580	519
14000	655	620	607	545	663	700	703	626
16000	757	710	696	633	781	822	822	729
18000	862	745	777	721	894	939	935	829
20000	967	866	854	813	1012	1062	1058	935
21000	1012	889	981	857	1071	1123	1118	971
22000	1053	897	998	902	1129	1180	1179	1041
23000	1093	890	1004	941	1185	1240	1237	1089
24000	1111	847	979	981	1247	1305	1298	1142
25000	1096	729	895	1009	1307	1374	1367	1199
32400	Ultimate load							

TABLE XXXII

STRAIN READINGS FOR PANEL 31

$$t = .0815 \text{ in.} \quad L = 2.50 \text{ in.} \quad b = 2.00 \text{ in.}$$

$$W = 16 \text{ in.} \quad N = 7$$

Gauge arrangement E, Figure 12

Gauge readings in micro-inches per inch

Load	1	2	3	4	5	6	7	8
2000	0	0	0	0	0	0	0	0
4000	78	106	108	97	109	122	108	95
6000	153	208	213	191	209	230	221	200
8000	226	309	320	284	307	334	334	305
10000	298	410	427	378	404	437	452	415
12000	366	504	523	463	494	541	561	519
14000	436	603	628	554	584	642	672	625
16000	503	702	730	642	674	742	783	731
18000	571	801	834	734	766	845	895	835
20000	638	901	939	822	856	945	1006	935
22000	708	1001	1042	916	948	1044	1117	1043
24000	772	1101	1149	1002	1034	1147	1225	1143
26000	839	1201	1259	1096	1124	1259	1341	1253
28000	902	1309	1379	1191	1213	1362	1447	1358
29000	928	1355	1431	1231	1259	1416	1500	1404
30000	956	1402	1485	1272	1299	1467	1554	1450
31000	989	1461	1555	1319	1343	1519	1606	1500
32000	1018	1519	1625	1369	1385	1568	1649	1547
33000	1051	1585	1708	1419	1429	1613	1690	1593
34000	1081	1671	1820	1477	1474	1647	1715	1637
35000	1119	1789	1970	1552	1514	1675	1731	1677
35720	Ultimate load							

TABLE XXXIV

STRAIN READINGS FOR PANEL 33

$t = .0810$ in. $L = 2.00$ in. $b = 3.75$ in.
 $W = 15$ in. $N = 3$

Gauge arrangement B, Figure 12

Gauge readings in micro-inches per inch

Load	1	2	3	4	5	6
2000	0	0	0	0	0	0
4000	122	131	130	148	130	129
6000	241	259	255	303	280	275
8000	356	381	375	455	429	420
10000	477	510	500	608	585	571
12000	574	639	625	758	735	618
14000	708	761	745	909	888	766
15000	755	812	800	985	968	841
16000	812	872	860	1068	1049	914
17000	871	934	925	1147	1136	994
18000	929	1002	992	1234	1218	1070
19000	992	1070	1058	1315	1297	1149
20000	1052	1151	1132	1397	1370	1219
21000	1119	1232	1213	1487	1451	1397
22000	1192	1328	1310	1583	1540	1472
23000	1282	1470	1430	1689	1637	1559
24000	1689	2012	1838	1927	1903	1774
24300	Ultimate load					

TABLE XXXV

STRAIN READINGS FOR PANEL 34

$$t = .0830 \text{ in.} \quad L = 3.50 \text{ in.} \quad b = 2.00 \text{ in.}$$

$$W = 16 \text{ in.} \quad N = 7$$

Gauge arrangement E, Figure 12

Gauge readings in micro-inches per inch

Load	1	2	3	4	5	6	7	8
2000	0	0	0	0	0	0	0	0
4000	94	82	88	91	86	85	77	101
6000	188	165	169	183	192	173	159	214
8000	277	242	248	271	294	257	243	336
10000	356	334	346	351	385	356	350	448
12000	424	425	444	420	465	464	464	553
14000	492	520	544	492	550	575	584	658
16000	557	611	638	556	630	688	699	766
18000	618	689	714	611	712	805	806	873
20000	675	737	741	642	794	918	913	978
22000	709	695	619	598	879	1037	1080	1088
23000	712	585	416 ^a	515	920	1097	1020	1144
24000	680	295	-46 ^a	328	965	1161	1184	1210
34200	Ultimate load							

^a Negative value indicates tension strain

TABLE XXXVI

STRAIN READINGS FOR PANEL 35

$t = .0805$ in. $L = 1.00$ in. $b = 3.00$ in.
 $W = 15$ in. $N = 4$

Gauge arrangement C, Figure 12

Gauge readings in micro-inches per inch

Load	1	2	3	4	5	6	7	8
2000	0	0	0	0	0	0	0	0
4000	121	127	123	120	129	129	131	125
6000	247	257	249	240	270	240	257	245
8000	372	386	375	361	418	403	390	363
10000	500	516	500	477	549	548	529	488
12000	622	639	620	587	677	678	671	616
14000	750	767	742	686	815	789	810	745
16000	873	892	862	798	963	958	953	875
18000	996	919	986	909	1125	1088	1097	1005
20000	1114	1041	1103	1028	1282	1235	1243	1141
22000	1242	1168	1223	1136	1459	1410	1385	1271
23000	1299	1226	1279	1186	1549	1484	1453	1333
24000	1359	1287	1337	1229	1635	1561	1531	1407
25000	1421	1351	1395	1291	1713	1622	1600	1471
26000	1484	1416	1457	1346	1996	1680	1676	1541
27000	1542	1574	1511	1398	1877	1736	1752	1609
28000	1598	1632	1564	1442	1945	1801	1816	1671
29000	1659	1698	1620	1493	2028	1898	1899	1748
30000	1720	1765	1681	1544	2101	1974	1971	1813
31000	1779	1825	1737	1589	2172	2063	2042	1881
32000	1839	1887	1793	1632	2252	2158	2124	1956
33000	1899	1955	1850	1672	2324	2224	2197	2027
34000	1958	2023	1907	1705	2402	2298	2274	2097
35000	2017	2095	1964	1752	2482	2411	2359	2181
36000	2087	2185	2025	1804	2560	2494	2441	2262
37000	2191	2321	2102	1853	2634	2556	2513	2356
38000	2454	2627	2297	1923	2687	2473	2541	2477
38500	Ultimate load							

TABLE XXXVII

STRAIN READINGS FOR PANEL 36

t = .0830 in. L = 3.25 in. b = 2.00 in.
W = 16 in. N = 7

Gauge arrangement E, Figure 12

Gauge readings in micro-inches per inch

Load	1	2	3	4	5	6	7	8
2000	0	0	0	0	0	0	0	0
4000	95	104	93	86	90	99	101	187
6000	195	209	191	173	195	209	206	187
8000	286	309	281	256	301	318	311	284
10000	380	415	381	343	417	433	424	385
12000	473	521	472	423	530	545	536	485
14000	562	623	558	498	639	659	643	580
16000	647	728	641	575	753	778	756	680
18000	734	821	723	647	869	888	861	779
20000	821	919	801	718	977	1002	965	878
22000	906	1014	876	788	1089	1118	1074	980
24000	986	1099	945	854	1207	1238	1188	1086
26000	1010	1046	915	889	1319	1369	1316	1196
27000	974	903	805	877	1366	1450	1392	1255
28000	813	640	443	793	1443	1548	1478	1325
36180	Ultimate load							

TABLE XXXVIII

STRAIN READINGS FOR PANEL 37

$t = .0830$ in. $L = 1.25$ in. $b = 2.50$ in. $W = 15$ in. $N = 5$

Gauge arrangement BF, Figure 12

Gauge readings in
micro-inches per inch

Dial readings
in inches $\times 10^{-4}$

Load	1	2	3	5	6	a	b	c	d
2000	0	0	0	0	0	0	0	0	0
4000	103	123	123	87	88	16	18	16	14
6000	214	260	242	193	171	30	33	29	26
8000	327	388	332	310	258	44	47	43	37
10000	435	509	449	430	345	57	61	56	51
12000	543	611	568	548	439	71	73	70	64
14000	652	694	690	670	541	84	86	81	76
16000	760	775	808	787	646	97	99	94	91
18000	865	890	932	914	764	110	112	106	103
20000	980	1026	1055	1033	873	124	125	122	117
22000	1085	1138	1177	1155	991	137	140	136	131
24000	1200	1253	1296	1275	1102	150	155	152	143
26000	1307	1377	1313	1394	1216	166	170	167	156
28000	1417	1493	1436	1517	1334	181	184	180	170
29000	1476	1539	1506	1580	1359	176	187	192	188
30000	1533	1580	1665	1633	1442	195	199	194	182
31000	1590	1622	1723	1692	1500	202	206	201	189
32000	1646	1647	1788	1754	1558	210	214	209	195
33000	1705	1687	1850	1807	1609	218	221	215	201
34000	1766	1729	1918	1865	1663	226	227	222	208
35000	1825	1791	1985	1919	1719	233	235	229	215
36000	1885	1868	2049	1971	1770	240	243	235	222
37000	1947	1948	2118	2023	1828	247	240	243	228
38000	2017	2033	2193	2070	1879	254	256	250	235
39000	2083	2120	2260	2114	1931	263	264	256	242
40000	2155	2216	2318	2143	1971	270	271	264	250
41000	2245	2340	2418	2158	2013	278	279	271	257
42000	2333	2496	2528	2140	2051	286	287	278	265
42680	Ultimate load								

TABLE XXXIX

STRAIN READINGS FOR PANEL 38

$t = .0825$ in. $L = 2.75$ in. $b = 2.50$ in.
 $W = 15$ in. $N = 5$

Gauge arrangement BF, Figure 12

Load	Gauge readings in micro-inches per inch						Dial readings in inches $\times 10^{-4}$			
	1	2	3	4	5	6	a	b	c	d
2000	0	0	0	0	0	0	0	0	0	0
4000	110	119	112	117	135	118	20	18	11	10
6000	218	228	217	231	260	239	36	35	24	21
8000	326	337	328	347	386	360	54	50	35	34
10000	428	441	431	457	500	470	71	64	46	49
12000	533	547	535	572	619	583	86	77	58	63
14000	638	648	640	683	737	702	104	91	70	76
16000	753	749	742	793	850	812	118	104	82	90
18000	858	849	848	906	959	927	134	117	93	105
20000	957	944	955	1411	1072	1037	149	130	104	120
21000	1002	987	1013	1071	1134	1098	158	136	111	126
22000	1043	1031	1068	1124	1189	1151	165	143	116	134
23000	1080	1084	1128	1183	1250	1212	172	148	123	142
24000	1110	1134	1189	1240	1302	1265	180	155	129	150
25000	1128	1176	1253	1298	1361	1320	187	162	135	159
26000	1128	1212	1330	1365	1430	1375	195	168	141	165
27000	1029	1088	1395	1431	1495	1425	204	175	146	172
28000	-----	-----	-----	-----	-----	-----	266	239	215	243
29500	Ultimate load						332	310	290	315

TABLE XL

STRAIN READINGS FOR PANEL 39

t = .0840 in. L = 2.75 in. b = 2.00 in.
W = 16 in. N = 7

Gauge arrangement DF, Figure 12

Load	Gauge readings in micro-inches per inch								Dial readings in inches x 10 ⁻⁴			
	1	2	3	4	5	6	7	8	a	b	c	d
2000	0	0	0	0	0	0	0	0	0	0	0	0
4000	110	109	102	90	97	117	115	98	20	14	6	6
6000	200	214	203	175	186	227	224	195	34	26	15	18
8000	295	318	303	262	274	337	334	291	48	36	24	30
10000	390	421	401	346	359	428	439	383	62	49	33	41
12000	485	526	499	432	443	485	548	478	75	60	40	53
14000	582	630	594	519	530	564	657	578	89	71	50	65
16000	679	733	684	603	611	611	762	671	103	82	58	76
18000	778	840	779	690	694	720	879	771	118	95	66	88
20000	872	943	874	777	781	838	994	871	132	106	75	97
22000	970	1046	963	858	862	951	1107	967	146	118	83	109
24000	1066	1145	1042	945	942	1070	1218	1061	160	130	91	120
26000	1162	1242	1120	1025	1016	1183	1337	1165	174	142	100	131
28000	1257	1330	1179	1098	1087	1296	1447	1256	190	155	109	142
29000	1310	1366	1195	1135	1130	1360	1509	1307	198	161	115	148
30000	1352	1399	1207	1166	1171	1425	1567	1353	203	165	118	152
31000	1402	1396	1181	1180	1209	1486	1635	1401	210	171	124	157
32000	1442	1321	1091	1178	1250	1559	1704	1449	218	176	128	162
33000	1445	1053	813	1125	1301	1659	1784	1501	225	183	133	169
34000	-----	-----	-----	-----	-----	-----	-----	-----	234	191	140	176
35000	-----	-----	-----	-----	-----	-----	-----	-----	297	244	208	253
35970	Ultimate load								574	364	340	548

TABLE XLI

STRAIN READINGS FOR PANEL 40

$t = .0815$ in. $L = 2.00$ in. $b = 2.66$ in. $W = 15.95$ in. $N = 5$

Gauge arrangement BF, Figure 12

Gauge readings in
micro-inches per inch

Dial readings
in inches $\times 10^{-4}$

Load	1	2	3	4	5	6	a	b	c	d	
2000	0	0	0	0	0	0	0	0	0	0	
4000	96	107	110	110	115	115	14	17	10	7	
6000	200	211	199	212	230	215	28	30	21	20	
8000	307	321	278	312	309	318	42	40	31	33	
10000	407	422	397	436	438	423	54	51	41	45	
12000	515	536	508	536	537	519	67	63	52	57	
14000	622	651	638	525	659	626	80	77	63	69	
16000	712	756	743	621	777	726	93	89	73	81	
18000	807	864	880	729	935	841	107	101	83	93	
19000	852	900	972	786	1036	891	114	108	88	98	
20000	910	961	1019	838	1126	942	121	115	93	103	
21000	960	1015	1082	990	1216	995	128	122	99	107	
22000	1011	1067	1145	1044	1303	1056	134	130	103	112	
23000	1063	1119	1218	1107	1380	1108	141	136	108	118	
24000	1113	1175	1287	1157	1353	1158	148	142	112	123	
25000	1166	1231	1340	1210	1525	1213	154	149	118	128	
26000	1221	1288	1407	1267	1609	1281	162	153	124	134	
27000	1273	1346	1462	1323	1673	1326	169	162	130	139	
28000	1331	1412	1515	1374	1728	1380	175	169	136	145	
29000	1392	1492	1584	1422	1795	1437	182	176	142	150	
30000	1451	1573	1653	1487	1865	1492	189	183	148	155	
31000	1513	1664	1728	1539	1919	1544	196	190	153	160	
32000	1581	1762	1808	1596	1986	1603	204	196	160	166	
33000	1655	1862	1903	1648	2041	1656	211	203	166	172	
34000	1739	1942	2026	1706	2095	1721	219	210	172	178	
35000	1849	2193	2167	1753	2101	1774	227	218	179	185	
35650	Ultimate load										

TABLE XLII

STRAIN READINGS FOR PANEL 41

$t = .0820$ in. $L = 3.25$ in. $b = 2.286$ in. $W = 16$ in. $N = 6$

Gauge arrangement CF, Figure 12

Load	Gauge readings in micro-inches per inch								Dial readings in inches $\times 10^{-4}$			
	1	2	3	4	5	6	7	8	a	b	c	d
2000	0	0	0	0	0	0	0	0	0	0	0	0
4000	94	118	111	94	78	114	115	102	10	10	9	8
6000	183	198	220	187	160	212	222	196	22	22	20	19
8000	276	261	329	281	232	342	336	300	32	30	32	31
10000	378	369	438	373	301	478	471	400	42	38	44	44
12000	480	477	551	470	372	621	583	499	52	48	55	57
14000	575	581	667	571	438	758	694	598	63	57	67	69
16000	667	688	771	659	495	882	804	700	73	66	78	83
18000	750	786	871	756	582	1023	925	805	84	76	91	96
20000	831	865	971	850	672	1152	1037	906	93	89	101	107
22000	893	912	1058	950	761	1289	1155	1009	103	94	112	120
23000	895	878	1061	998	806	1359	1214	1060	109	99	118	128
24000	850	730	986	1043	851	1429	1276	1112	114	104	124	135
32800	Ultimate load											

TABLE XLIII

STRAIN READINGS FOR PANEL 42

$t = .0815$ in. $L = 3.50$ in. $b = 2.50$ in.
 $W = 14.97$ in. $N = 5$

Gauge arrangement BF, Figure 12

Load	Gauge readings in micro-inches per inch						Dial readings in inches x 10^{-4}				
	1	2	3	4	5	6	a	b	c	d	
2000	0	0	0	0	0	0	0	0	0	0	
4000	111	112	103	124	128	110	15	15	14	12	
6000	227	225	213	238	245	216	29	29	25	25	
8000	339	349	324	363	372	333	45	44	39	39	
10000	449	469	436	489	502	450	60	58	52	53	
12000	549	568	545	609	629	566	72	72	65	65	
13000	591	588	595	661	680	614	78	79	70	70	
14000	633	615	654	721	750	681	85	85	77	77	
15000	670	631	713	782	811	740	92	92	84	84	
16000	691	630	770	843	883	805	99	99	90	90	
17000	692	585	813	895	940	862	103	108	97	96	
18000	641	377	663	961	1020	912	113	116	104	102	
19000	501	18	565	1028	1104	984	120	124	113	111	
28000	---	---	---	---	---	---	450	455	475	480	
28950	Ultimate load										

TABLE XLIV

STRAIN READINGS FOR PANEL 43

t = .0825 in. L = 3.25 in. b = 2.50 in.
 W = 15 in. N = 5

Gauge arrangement BF, Figure 12

Load	Gauge readings in micro-inches per inch						Dial readings in inches x 10 ⁻⁴				
	1	2	3	4	5	6	a	b	c	d	
2000	0	0	0	0	0	0	0	0	0	0	
4000	96	120	123	123	118	93	19	17	14	9	
6000	225	228	217	237	237	191	34	34	26	21	
8000	343	330	303	359	369	299	50	41	39	32	
10000	445	440	408	469	479	403	63	67	51	44	
12000	565	555	530	584	598	519	78	83	64	56	
13000	623	614	590	659	676	579	85	90	70	62	
14000	676	658	643	709	734	638	91	98	76	67	
15000	735	707	698	769	797	698	99	106	84	72	
16000	787	745	745	823	857	753	105	115	91	77	
17000	840	780	785	881	921	816	111	122	100	83	
18000	883	792	815	946	989	884	119	130	108	89	
19000	933	770	885	1001	1054	941	125	136	115	94	
20000	975	681	792	1066	1131	1013	131	145	122	100	
21000	965	440	678	1176	1212	1091	136	154	132	105	
22000	780	-89	407	1241	1320	1183	144	165	142	110	
29000	---	---	---	---	---	---	312	362	358	280	
29810	Ultimate load										

TABLE XLV

STRAIN READINGS FOR PANEL 44

$t = .0815$ in. $L = 1.00$ in. $b = 2.50$ in. $W = 15$ in. $N = 5$

Gauge arrangement BF, Figure 12

Load	Gauge readings in micro-inches per inch						Dial readings ⁻⁴ in inches x 10 ⁻⁴			
	1	2	3	4	5	6	a	b	c	d
2000	0	0	0	0	0	0	0	0	0	0
4000	116	100	93	76	97	81	30	21	18	15
6000	217	202	190	159	197	172	52	38	32	30
8000	315	295	276	246	298	279	71	55	46	44
10000	415	388	361	336	408	374	90	71	59	58
12000	514	477	446	426	514	475	107	86	74	69
14000	604	570	531	519	629	581	124	101	88	82
16000	695	658	621	616	740	680	142	117	91	93
18000	785	742	704	710	858	787	159	135	116	108
20000	867	828	782	805	967	886	178	146	125	117
22000	953	897	854	895	1080	993	197	163	138	130
24000	1048	981	932	937	1190	1093	214	179	147	143
26000	1142	1071	1014	1088	1310	1202	232	194	161	155
28000	1234	1151	1081	1187	1421	1301	252	212	172	168
29000	1283	1180	1121	1239	1482	1357	262	222	176	174
30000	1327	1208	1152	1279	1529	1402	270	229	182	180
31000	1373	1232	1187	1325	1581	1455	281	238	187	187
32000	1418	1265	1223	1375	1633	1502	290	246	192	193
33000	1468	1300	1263	1426	1688	1557	300	256	199	199
34000	1523	1335	1301	1476	1740	1603	310	264	204	205
35000	1573	1361	1337	1521	1790	1653	320	273	210	210
36000	1630	1390	1372	1565	1835	1699	329	281	215	216
37000	1690	1428	1410	1609	1885	1751	340	290	220	223
38000	1745	1462	1443	1649	1924	1792	350	299	225	229
39000	1802	1498	1486	1697	1974	1844	361	308	230	236
40000	1857	1532	1422	1726	2000	1883	371	319	235	243
41000	1955	1592	1464	1756	2016	1927	387	329	243	251
42000	2005	1629	1491	1775	2026	1956	394	335	246	255
43000	2105	1702	1539	1788	2006	1994	406	344	252	263
44000	2325	1881	1616	1723	----	----	----	----	----	----
44000	Ultimate load									

TABLE XLVI

STRAIN READINGS FOR PANEL 45

t = .0835 in. L = 1.25 in. b = 2.00 in.
W = 16 in. N = 7

Gauge arrangement EF, Figure 12

Load	Gauge readings in micro-inches per inch							Dial readings in inches x 10 ⁻⁴			
	1	2	3	4	6	7	8	a	b	c	d
2000	0	0	0	0	0	0	0	0	0	0	0
4000	105	92	102	93	60	52	61	26	25	15	13
6000	189	182	201	170	160	117	125	43	40	28	26
8000	275	273	298	243	248	204	190	57	52	38	36
10000	355	462	393	315	332	294	263	69	65	48	46
12000	434	454	492	392	420	382	338	81	77	58	56
14000	511	541	585	468	519	468	419	94	97	69	66
16000	588	627	678	538	603	541	494	108	101	79	78
18000	662	718	773	615	703	624	564	118	115	88	89
20000	741	810	874	693	801	688	650	131	127	97	100
22000	813	899	966	770	896	765	728	144	140	106	110
24000	883	984	1058	840	991	813	807	157	154	116	121
26000	955	1012	1153	910	1086	871	887	169	168	126	131
28000	1032	1165	1254	990	1201	977	979	183	182	135	141
30000	1102	1254	1348	1063	1293	1068	1058	196	194	144	151
31000	1142	1301	1397	1109	1349	1117	1108	207	207	153	162
32000	1169	1340	1442	1142	1401	1164	1145	211	211	154	163
33000	1202	1383	1491	1178	1453	1207	1181	217	217	158	167
34000	1236	1421	1538	1212	1508	1257	1224	224	224	164	173
35000	1272	1464	1583	1248	1551	1297	1257	230	230	168	177
36000	1307	1512	1633	1285	1599	1347	1300	238	237	173	182
37000	1334	1550	1678	1319	1642	1384	1328	246	243	177	187
38000	1370	1598	1731	1358	1703	1430	1370	254	250	182	192
39000	1403	1637	1779	1395	1752	1472	1408	261	257	187	197
40000	1439	1687	1831	1423	1803	1516	1448	268	264	191	201
41000	1471	1734	1881	1459	1854	1559	1488	276	272	197	207
42000	1504	1777	1930	1493	1893	1604	1528	283	278	202	211
43000	1539	1831	1982	1531	1951	1647	1570	291	285	207	217
44000	1570	1882	2038	1573	2006	1688	1607	299	292	213	222
45000	1600	1934	2091	1608	2033	1718	1639	305	298	217	227
46000	1632	1985	2151	1648	2068	1754	1672	312	306	222	231

TABLE XLVI (continued)

Load	Gauge readings in micro-inches per inch							Dial readings in inches $\times 10^{-4}$				
	1	2	3	4	6	7	8	a	b	c	d	
47000	1659	2031	2211	1685	2104	1780	1800	319	314	227	236	
48000	1692	2084	2281	1708	2166	1816	1736	327	321	233	241	
49000	1723	2139	2351	1744	2220	1845	1770	335	328	238	247	
50000	1755	2202	2435	1790	2276	1866	1807	344	335	243	250	
51000	1788	2270	2525	1838	2333	1875	1840	352	344	249	256	
52000	1828	2367	2650	1900	2352	1847	1876	360	351	254	261	
52760	Ultimate load											

TABLE XLVIII

STRAIN READINGS FOR PANEL 47

t = .0820 in. L = 3.50 in. b = 2.286 in.
 W = 16 in. N = 6

Gauge arrangement CF, Figure 12

Load	Gauge readings in micro-inches per inch							Dial readings in inches x 10 ⁻⁴			
	1	2	3	5	6	7	8	a	b	c	d
2000	0	0	0	0	0	0	0	0	0	0	0
4000	88	84	97	80	101	110	77	20	16	11	11
6000	186	181	192	170	198	217	147	36	30	19	21
8000	285	176	285	274	297	331	224	54	43	28	33
10000	380	267	380	389	406	451	304	72	54	36	45
12000	470	344	462	503	519	574	392	90	66	45	58
14000	551	404	531	625	638	680	478	108	77	51	70
16000	606	421	567	746	768	815	576	126	90	59	83
17000	608	382	558	799	819	873	617	135	96	63	89
18000	601	336	528	864	880	934	658	144	100	65	95
19000	552	288	428	932	950	1001	707	155	107	70	103
20000	438	44	242	1002	1026	1070	755	165	112	74	112
21000	210	-421 ^a	-135	1089	1111	1157	817	176	119	80	124
31000	---	---	---	---	---	---	---	424	273	225	375
31960	Ultimate load										

a Negative values indicate tension strains.

TABLE L

STRAIN READINGS FOR PANEL 49

$t = .0815$ in. $L = 1.50$ in. $b = 2.286$ in. $W = 16$ in. $N = 6$

Gauge arrangement CF, Figure 12

Load	Gauge readings in micro-inches per inch								Dial readings in inches $\times 10^{-4}$			
	1	2	3	4	5	6	8	a	b	c	d	
2000	0	0	0	0	0	0	0	0	0	0	0	
4000	66	71	68	92	86	109	70	15	21	7	0	
6000	149	163	146	189	167	197	132	36	45	18	6	
8000	232	256	224	252	240	278	190	53	66	29	13	
10000	311	352	304	380	303	354	262	70	90	42	17	
12000	393	446	383	469	368	431	331	86	109	52	24	
14000	482	541	461	555	434	509	395	104	128	61	32	
16000	577	644	544	640	496	584	455	122	148	71	41	
18000	666	742	620	721	560	661	512	139	164	81	50	
20000	759	843	695	798	623	734	589	156	181	90	61	
22000	853	944	771	858	687	813	680	173	199	100	72	
24000	945	1043	843	915	750	891	774	190	214	110	84	
26000	1041	1151	919	982	820	982	875	209	232	117	94	
27000	1089	1196	951	1007	855	1026	920	219	241	122	100	
28000	1136	1251	988	1029	880	1066	967	228	248	126	105	
29000	1181	1301	1024	1060	915	1110	1016	237	255	131	110	
30000	1229	1356	1061	1092	953	1160	1062	246	263	136	116	
31000	1278	1408	1098	1120	985	1206	1113	255	271	141	122	
32000	1326	1464	1138	1152	1023	1261	1165	265	280	146	129	
33000	1370	1516	1171	1182	1064	1311	1210	274	288	151	134	
34000	1419	1571	1206	1207	1095	1354	1250	292	295	155	140	
35000	1469	1634	1246	1238	1140	1411	1310	291	304	162	147	
36000	1513	1689	1281	1263	1178	1459	1351	300	311	166	152	
37000	1561	1748	1321	1290	1220	1508	1401	310	319	171	158	
38000	1610	1803	1353	1311	1255	1553	1445	319	328	177	165	
39000	1656	1864	1391	1337	1296	1596	1492	328	336	182	170	
40000	1707	1923	1434	1367	1347	1648	1547	337	345	187	176	
41000	1756	1983	1472	1390	1388	1683	1587	345	353	192	181	
42000	1803	2050	1518	1420	1435	1724	1635	354	361	198	187	
43000	1852	2119	1562	1449	1480	1763	1687	364	370	203	194	
44000	1908	2196	1613	1529	1523	1791	1728	373	380	208	200	
45000	1960	2284	1673	1585	1570	1822	1770	383	390	213	207	
46050	Ultimate load											

TABLE LI

STRAIN READINGS FOR PANEL 50

t = .0815 in. L = 2.50 in. b = 2.00 in. W = 16 in. N = 7

Gauge arrangement EF, Figure 12

Load	Gauge readings in micro-inches per inch								Dial readings in inches x 10 ⁻⁴			
	1	2	3	4	5	6	7	8	a	b	c	d
2000	0	0	0	0	0	0	0	0	0	0	0	0
4000	94	110	108	94	101	112	83	60	23	22	6	6
6000	182	211	206	182	205	224	172	143	40	36	12	14
8000	269	317	308	268	308	345	261	237	57	50	19	22
10000	354	418	407	353	410	455	345	322	72	64	26	31
12000	450	521	509	440	513	568	430	410	89	78	34	41
14000	544	627	611	527	618	684	516	507	106	92	41	56
16000	624	734	718	620	728	803	597	598	123	106	49	60
18000	727	834	815	705	826	910	686	707	140	121	56	69
20000	822	946	928	803	940	1035	763	800	156	135	62	78
22000	912	1051	1033	892	1040	1170	845	888	172	149	69	87
24000	1006	1156	1135	984	1143	1287	924	985	188	165	77	95
26000	1099	1261	1240	1075	1248	1407	1006	1087	206	182	85	104
28000	1192	1375	1346	1164	1350	1500	1080	1182	222	198	93	113
30000	1284	1484	1452	1255	1452	1613	1154	1280	238	214	101	121
32000	1384	1604	1560	1345	1553	1730	1232	1388	255	230	110	131
34000	1480	1751	1688	1444	1660	1852	1301	1480	271	245	119	140
35000	1527	1826	1756	1492	1712	1908	1335	1534	280	254	124	145
36000	1577	1928	1858	1547	1765	1975	1372	1582	289	261	129	149
37000	1672	2137	2036	1625	1825	2063	1412	1639	300	271	134	154
37950	Ultimate load											

TABLE LII

STRAIN READINGS FOR PANEL 51

$t = .0830$ in. $L = 2.00$ in. $b = 2.00$ in. $W = 16$ in. $N = 7$

Gauge arrangement EF, Figure 12

Gauge readings in micro-inches per inch δ Dial readings in inches $\times 10^{-4}$

Load	1	2	3	4	5	6	7	8	a	b	c	d
2000	0	0	0	0	0	0	0	0	0	0	0	0
4000	104	110	81	90	95	128	94	67	22	22	9	7
6000	202	204	157	173	188	254	204	134	38	38	16	14
8000	302	320	243	248	269	370	310	212	51	51	24	22
10000	401	429	314	339	340	490	417	297	66	64	32	32
12000	502	532	406	406	403	510	527	385	81	77	40	39
14000	599	642	477	470	481	727	634	478	96	91	48	48
16000	693	750	563	535	566	846	741	572	110	114	56	56
18000	787	857	658	553	648	965	851	672	128	118	65	67
20000	881	967	751	586	730	1080	958	766	144	131	72	77
22000	981	1079	837	669	839	1202	1071	867	160	145	81	87
24000	1072	1189	929	708	944	1317	1178	964	175	158	89	97
26000	1165	1299	1012	788	1043	1433	1283	1059	190	171	98	107
28000	1264	1410	1099	876	1151	1555	1398	1160	206	185	106	118
30000	1360	1528	1203	978	1250	1663	1498	1253	222	199	115	128
32000	1451	1638	1283	1086	1352	1782	1608	1353	239	213	124	138
33000	1499	1495	1316	1146	1400	1837	1662	1399	245	219	127	142
34000	1549	1552	1361	1195	1456	1900	1717	1449	253	226	131	148
35000	1597	1613	1414	1238	1507	1954	1767	1495	260	234	134	152
36000	1647	1772	1451	1276	1555	2010	1818	1541	268	242	138	158
37000	1694	1835	1487	1326	1606	2065	1870	1590	276	249	143	162

TABLE LII (continued)

Load	Gauge readings in micro-inches per inch								Dial readings in inches x 10 ⁻⁴			
	1	2	3	4	5	6	7	8	a	b	c	d
38000	1745	1999	1532	1355	1657	2120	1923	1639	285	256	146	168
39000	1797	2064	1581	1396	1706	2175	1973	1689	292	264	150	173
40000	1850	2133	1632	1438	1760	2235	2027	1740	300	272	155	178
41000	1902	2205	1686	1480	1805	2277	2073	1787	307	279	159	184
42000	1957	2278	1705	1513	1843	2317	2107	1828	316	288	163	188
43000	2010	2375	1783	1546	1896	2364	2157	1879	324	296	167	194
44000	2080	2487	1855	1591	1947	2397	2197	1929	333	303	172	200
45000	2161	2635	1952	1636	1987	2404	2225	1976	340	310	176	205
46000	Ultimate load											

TABLE LIII

STRAIN READINGS FOR PANEL 52

$t = .0830$ in. $L = 2.25$ in. $b = 3.00$ in.
 $W = 15$ in. $N = 4$

Gauge arrangement CF, Figure 12

Load	2	3	4	5	6	7	8	a	b	c	d
2000	0	0	0	0	0	0	0	0	0	0	0
4000	136	134	126	77	84	87	83	27	29	10	9
6000	266	258	245	174	190	202	183	48	50	20	22
8000	404	391	367	281	306	335	282	68	68	31	34
10000	536	418	484	402	430	476	410	85	86	44	44
12000	673	651	606	532	554	623	544	104	104	55	56
14000	816	778	724	667	684	773	691	124	122	65	67
16000	957	908	839	805	812	923	841	141	142	78	80
18000	1094	1038	956	944	947	1074	984	163	160	90	93
19000	1177	1116	1025	1027	1020	1163	1071	176	172	96	101
20000	1223	1171	1069	1084	1077	1231	1135	184	179	100	105
21000	1296	1241	1127	1150	1140	1303	1204	192	188	106	111
22000	1376	1317	1187	1224	1207	1383	1283	203	198	113	118
23000	1443	1386	1241	1287	1270	1457	1359	213	206	118	124
24000	1525	1478	1308	1357	1311	1531	1430	222	215	125	130
25000	1610	1621	1408	1424	1392	1615	1513	233	226	132	138
26000	1705	1768	1547	1491	1444	1674	1580	241	235	137	143
27000	1823	1908	1705	1560	1501	1735	1657	252	244	144	150
28000	1975	2086	1876	1626	1544	1776	1725	264	254	150	156
29000	2303	2463	2154	1867	1540	1755	1770	276	265	159	165
29300	Ultimate load										

TABLE LIV

STRAIN READINGS FOR PANEL 53

$t = .0820$ in. $L = 1.75$ in. $b = 2.00$ in. $W = 16$ in. $N = 7$

Gauge arrangement EF, Figure 12

Load	Gauge readings in micro-inches per inch								Dial readings in inches x 10 ⁻⁴			
	1	2	3	4	5	6	7	8	a	b	c	d
2000	0	0	0	0	0	0	0	0	0	0	0	0
4000	108	120	120	110	59	79	47	31	20	21	9	8
6000	208	235	240	218	136	172	205	95	37	40	19	18
8000	300	342	349	316	231	277	318	188	50	55	28	26
10000	390	449	461	417	329	383	434	294	64	70	38	36
12000	482	560	578	521	431	497	558	407	78	86	48	44
14000	570	667	690	620	529	602	673	520	92	102	59	52
16000	661	778	810	725	632	718	797	636	107	118	70	61
18000	750	885	924	827	738	832	922	754	121	134	82	71
20000	846	1000	1047	934	845	945	1044	874	135	151	95	81
22000	939	1114	1167	1038	949	1059	1170	994	151	168	107	90
24000	1027	1222	1285	1142	1053	1170	1290	1112	165	184	119	98
26000	1119	1339	1408	1250	1161	1281	1411	1232	179	201	130	106
28000	1211	1450	1525	1352	1262	1390	1530	1350	195	216	142	115
30000	1301	1564	1650	1460	1371	1509	1653	1474	212	233	154	124
32000	1396	1682	1780	1571	1481	1615	1774	1597	227	250	166	132
33000	1446	1795	1840	1622	1530	1665	1829	1653	235	259	172	136
34000	1486	1795	1898	1672	1575	1715	1882	1712	243	266	177	140
35000	1533	1858	1970	1733	1632	1772	1946	1777	250	275	184	145
36000	1581	1915	2029	1782	1681	1819	1998	1833	258	283	189	149

TABLE LV

STRAIN READINGS FOR PANEL 54

t = .0825 in. L = 1.50 in. b = 2.50 in. W = 15 in. N = 5

Gauge arrangement GF, Figure 12

Load	Gauge readings in micro-inches per inch												Dial readings in inches x 10 ⁻⁴			
	1	2	3	4	5	6	7	8	9	10	11	a	b	c	d	
2000	0	0	0	0	0	0	0 ^a	0	0	0	0	0	0	0	0	
4000	115	113	81	76	109	67	-20	-41	-8	-42	-17	16	10	3	12	
6000	241	235	183	163	221	147	-41	-82	-16	-83	-30	35	20	11	24	
8000	362	358	293	266	335	274	-58	-119	-26	-122	-41	52	32	21	38	
10000	479	478	399	370	450	347	-77	-155	-34	-164	-54	69	46	32	50	
12000	597	601	511	495	594	468	-99	-194	-43	-202	-64	86	61	44	63	
14000	714	717	620	616	727	581	-120	-227	-54	-245	-80	104	76	56	74	
16000	833	837	723	749	874	707	-145	-262	-63	-282	-92	120	92	67	86	
18000	952	954	844	877	1018	831	-169	-294	-74	-323	-105	140	107	79	100	
20000	1072	1068	951	1003	1157	950	-198	-330	-83	-363	-119	157	123	90	112	
22000	1194	1188	1066	1139	1307	1080	-226	-362	-93	-402	-132	174	139	100	124	
24000	1316	1301	1178	1270	1454	1210	-254	-397	-101	-442	-144	193	155	111	138	
26000	1441	1413	1291	1406	1607	1342	-285	-434	-111	-482	-159	211	170	122	151	
28000	1565	1523	1399	1539	1756	1470	-316	-468	-122	-522	-173	230	186	132	163	
30000	1690	1630	1509	1672	1909	1602	-354	-504	-132	-561	-189	250	203	144	163	
32000	1822	1729	1619	1806	2064	1733	-387	-541	-144	-600	-198	270	218	155	187	
34000	1954	1823	1724	1932	2222	1866	-421	-575	-156	-645	-212	291	235	167	201	
35000	2022	1867	1779	1997	2306	1934	-444	-594	-159	-662	-219	300	240	171	207	
36000	2097	1900	1833	2063	2389	2000	-462	-609	-166	-681	-225	310	251	177	214	
37000	2168	1932	1885	2123	2478	2072	-481	-628	-173	-698	-232	320	260	182	220	
38000	2243	1953	1928	2177	2568	2142	-501	-645	-177	-713	-241	331	267	188	236	
39000	2327	1955	1963	2230	2584	2226	-518	-664	-183	-720	-249	342	275	194	235	
39900	Ultimate load															

a Negative values indicate tension strains.

TABLE LVI

STRAIN READINGS FOR PANEL 55

t = .0825 in. L = 1.50 in. b = 3.20 in. W = 16 in. N = 4

Gauge arrangement CF, Figure 12

Load	Gauge readings in micro-inches per inch								Dial readings in inches x 10 ⁻⁴				
	1	2	3	4	5	6	7	8	a	b	c	d	e
2000	0	0	0	0	0	0	0	0	0	0	0	0	0
4000	112	129	129	124	83	111	98	47	20	20	13	9	18
6000	222	255	251	241	184	252	233	154	36	37	26	22	38
8000	333	381	371	351	300	388	367	273	53	53	39	32	48
10000	444	514	496	469	425	529	512	405	67	68	51	42	61
12000	558	643	616	581	551	667	652	533	82	84	63	52	71
14000	670	776	745	699	686	818	803	673	99	101	76	62	87
16000	783	904	865	809	813	960	948	806	114	117	86	74	99
18000	892	1032	984	921	943	1107	1097	950	128	133	98	74	118
19000	947	1100	1051	979	1009	1183	1164	1016	135	141	104	88	124
20000	1002	1162	1109	1032	1071	1257	1239	1090	143	150	109	92	140
21000	1054	1223	1168	1087	1138	1328	1307	1154	150	158	114	97	145
22000	1110	1290	1227	1140	1201	1405	1384	1226	159	166	120	101	153
23000	1162	1357	1290	1197	1271	1481	1454	1292	165	174	125	106	166
24000	1220	1424	1354	1254	1343	1558	1534	1367	174	183	131	111	170
25000	1279	1592	1414	1311	1414	1647	1612	1446	182	192	137	116	186
26000	1334	1660	1472	1362	1476	1714	1685	1521	190	200	143	121	195
27000	1395	1735	1542	1426	1554	1803	1768	1600	198	210	149	126	200
28000	1450	1807	1604	1480	1619	1882	1842	1672	205	218	155	131	211
29000	1512	1888	1676	1541	1691	1967	1922	1752	213	227	160	135	216
30000	1574	1982	1763	1604	1764	2040	2002	1835	221	237	166	140	222
31000	1630	2064	1843	1666	1832	2123	2085	1918	230	248	171	143	242
32000	1702	2172	1955	1733	1896	2198	2157	2003	239	259	178	148	246
33000	1787	2220	2082	1805	1963	2300	2259	2107	249	269	185	152	264
33540	Ultimate load												

Buckled form of stiffeners. Figures 13 to 67 inclusive show the stiffener sides of each panel after failure and removal of the load. The form of stringer failure is clearly indicated, and, in practically every case involved torsion or rolling over of the outstanding flange. Local failure of the stringer lip at the rivets adjacent to the principal buckle will be observed, but in all cases this occurred after the primary failure. Of particular interest is the similarity of the buckled form of each stringer in any one panel.

Control test data. A few representative stress-strain curves for tension and compression control test specimens of the sheet stock are given in Figures 68 to 71 inclusive. The values of E, the modulus of elasticity, are written in on each curve. The curve numbers indicate the corresponding panel, and the letter S signifies stringer stock. The ordinate at the intersection of the dashed line with the curve gives the 0.2 per cent yield strength. It will be noticed that all of these curves have a steeper slope up to 10,000 pounds per square inch than beyond this stress. This is due to the fact that the pure aluminum "Alclad" coating approximately .003 inches thick reaches its elastic limit at about 10,000 pounds per square inch, and the coating

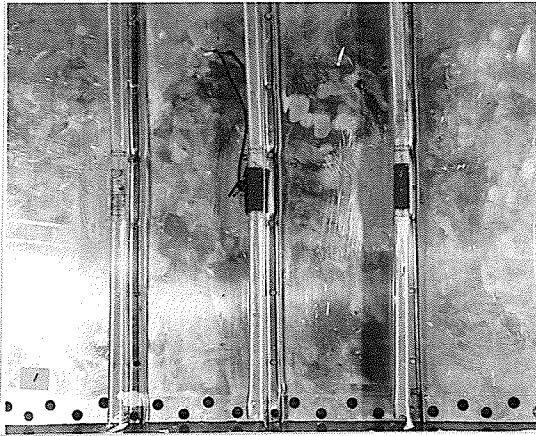

Figure 13 Panel 1

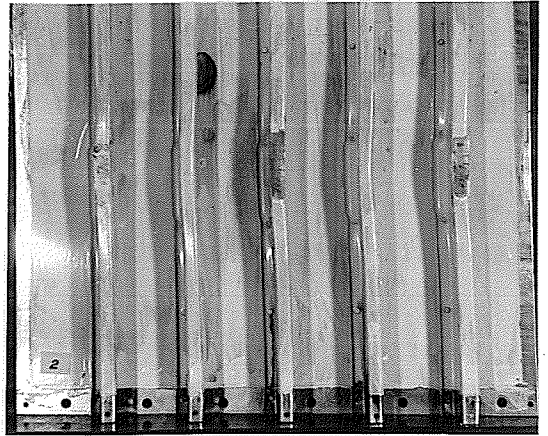

Figure 14 Panel 2

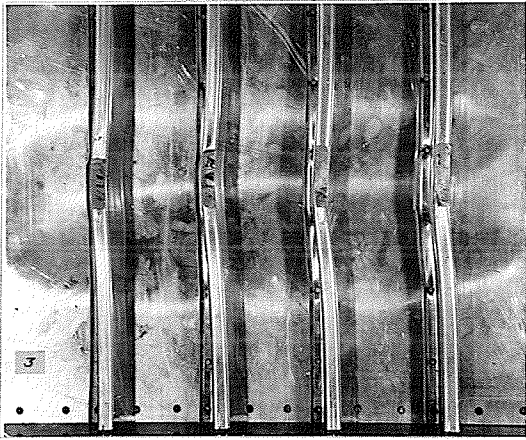

Figure 15 Panel 3

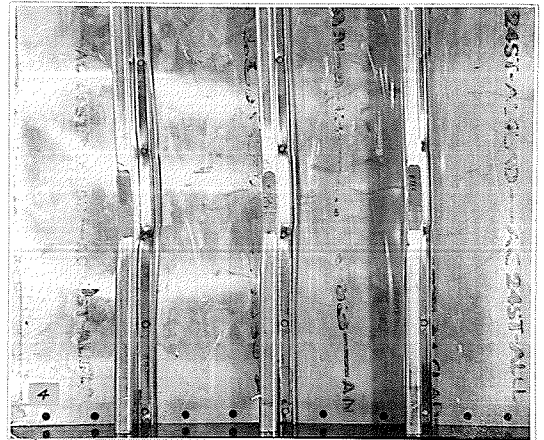

Figure 16 Panel 4

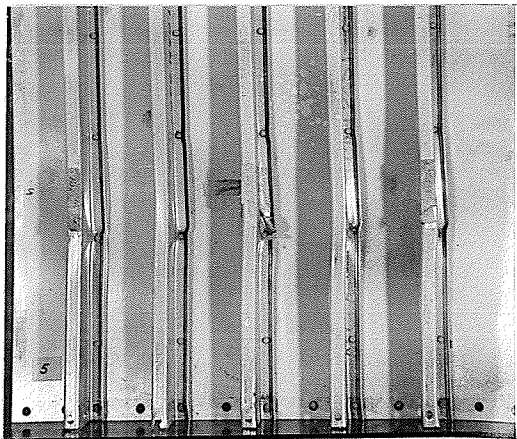

Figure 17 Panel 5

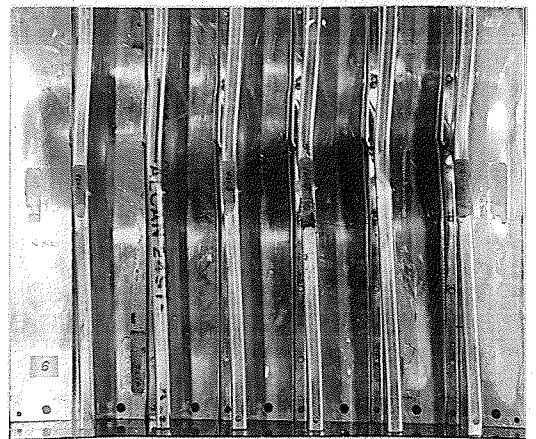

Figure 18 Panel 6

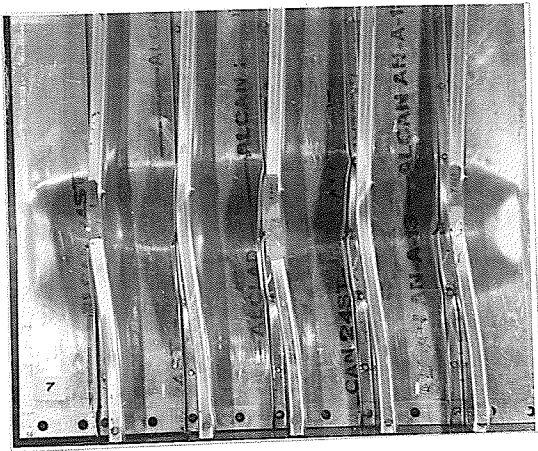

Figure 19 Panel 7

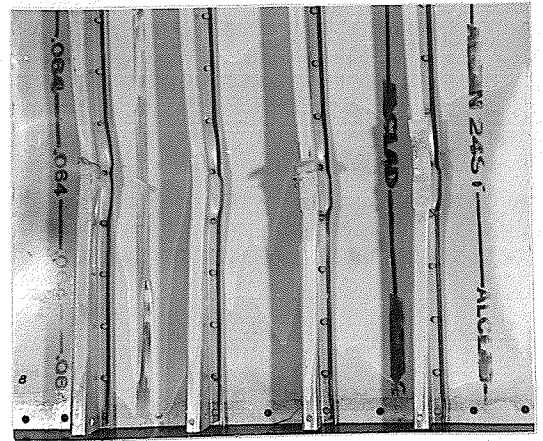

Figure 20 Panel 8

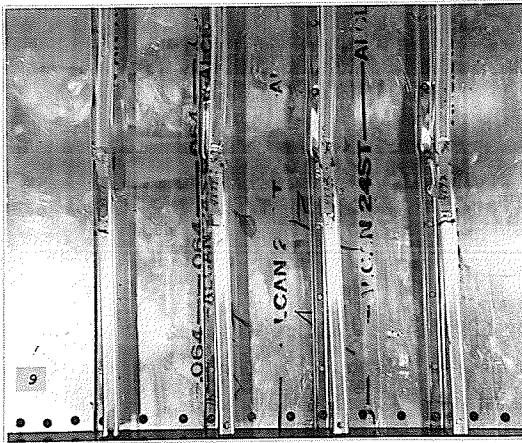

Figure 21 Panel 9

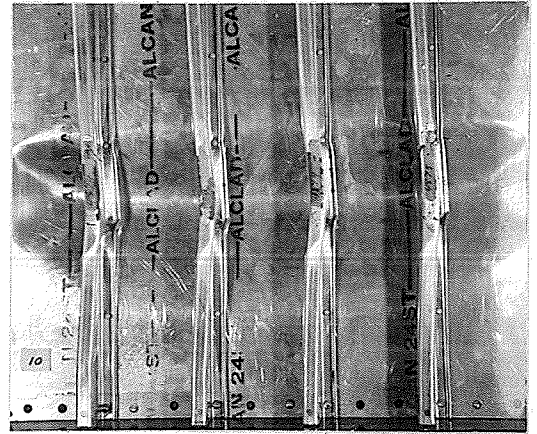

Figure 22 Panel 10

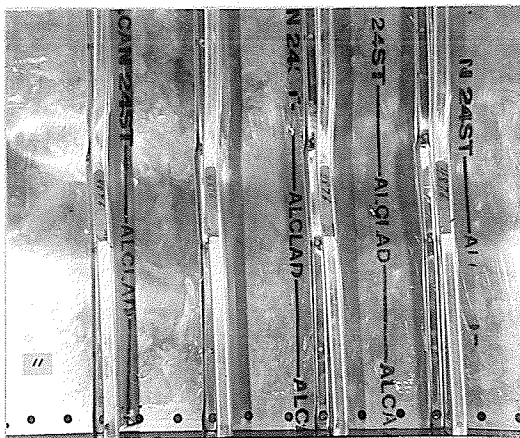

Figure 23 Panel 11

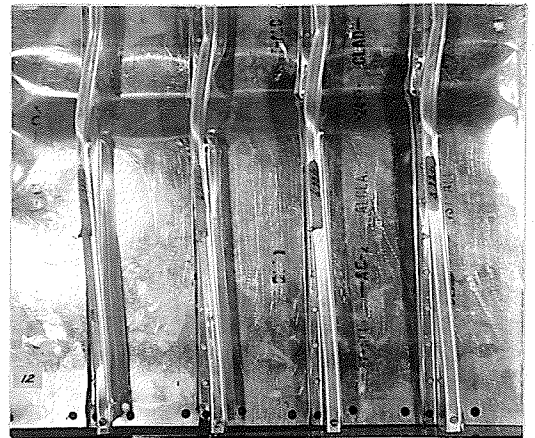

Figure 24 Panel 12

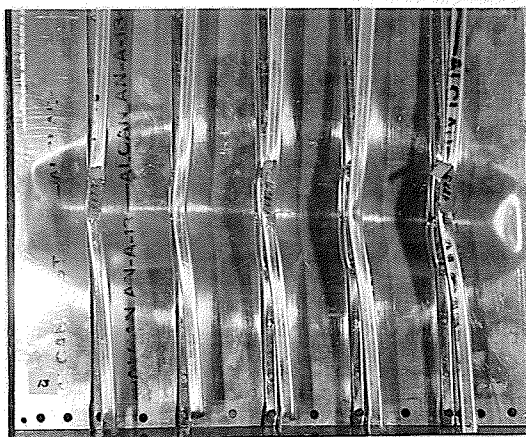

Figure 25 Panel 13

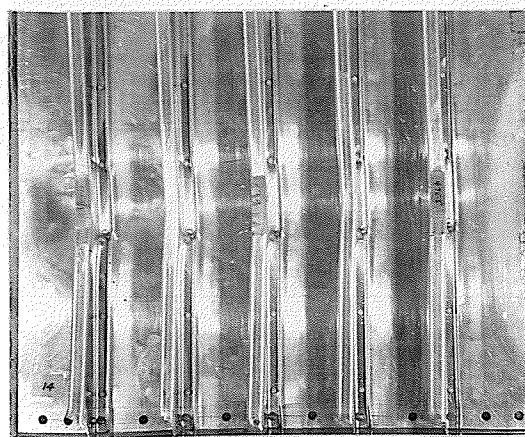

Figure 26 Panel 14

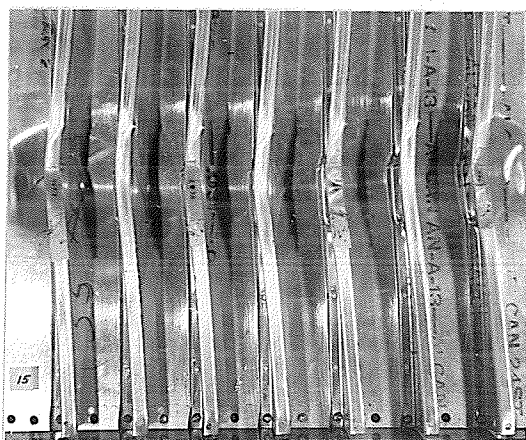

Figure 27 Panel 15

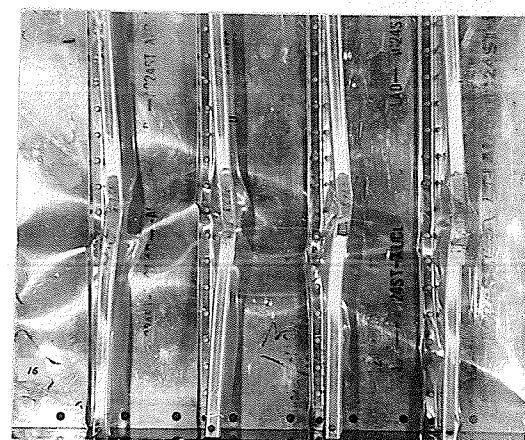

Figure 28 Panel 16

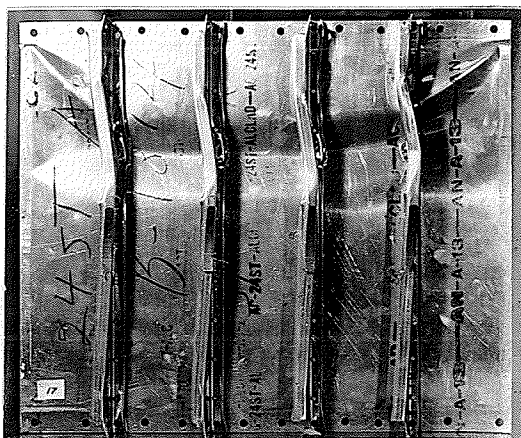

Figure 29 Panel 17

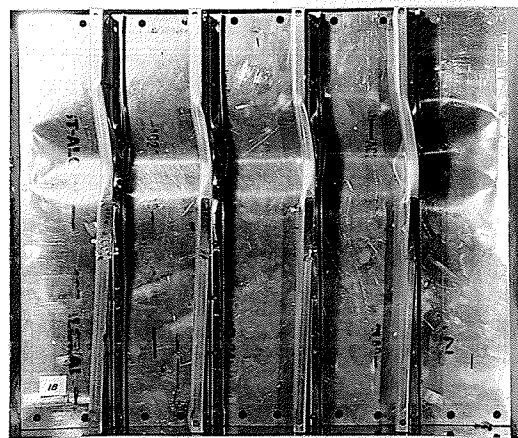

Figure 30 Panel 18

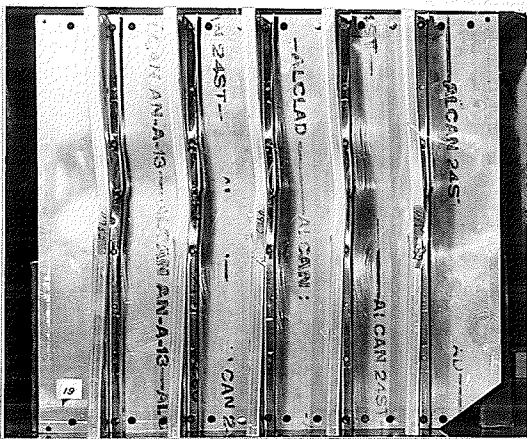

Figure 31 Panel 19

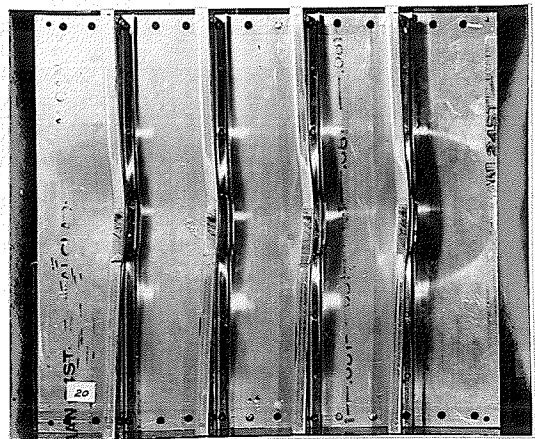

Figure 32 Panel 20

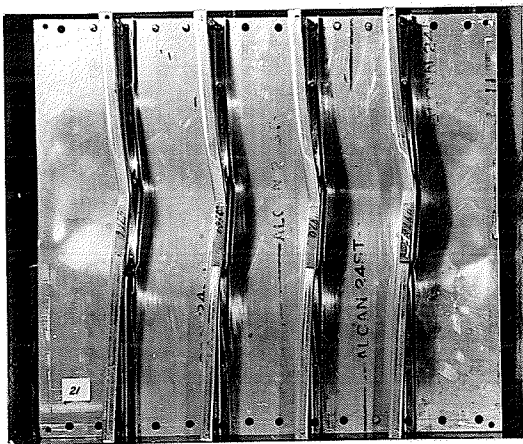

Figure 33 Panel 21

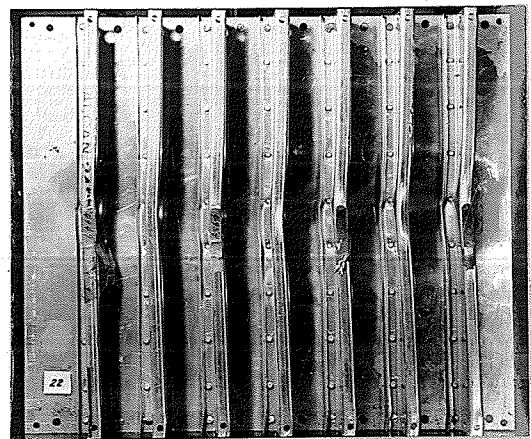

Figure 34 Panel 22

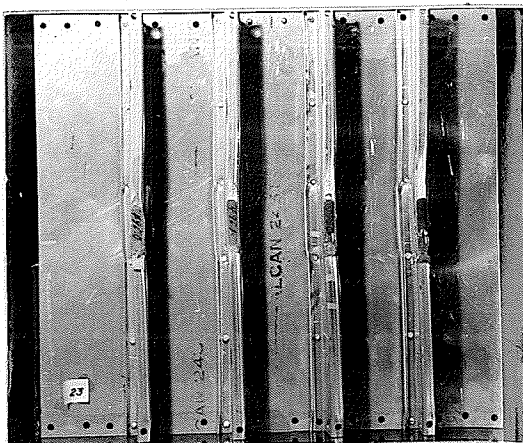

Figure 35 Panel 23

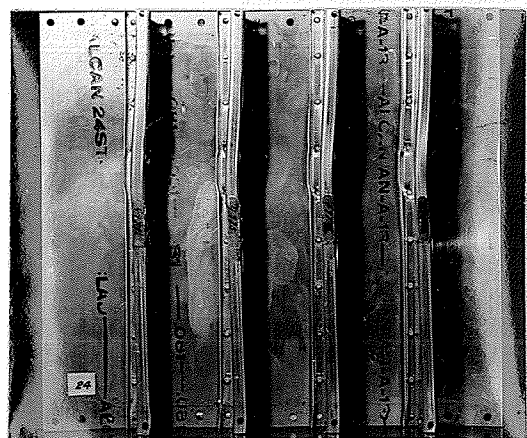

Figure 36 Panel 24

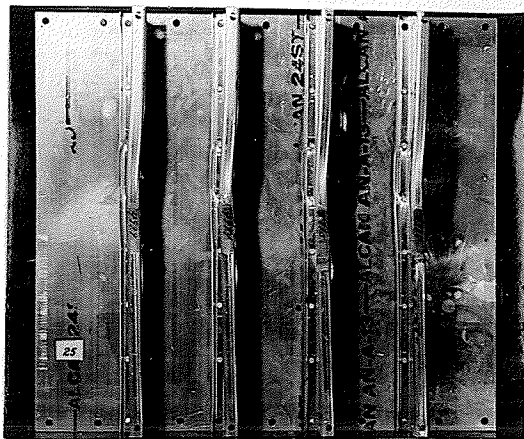

Figure 37 Panel 25



Figure 38 Panel 26

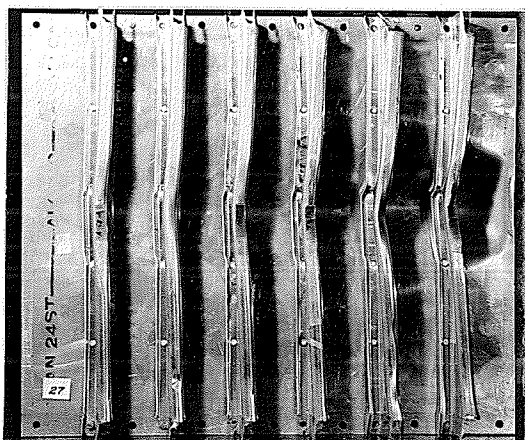

Figure 39 Panel 27

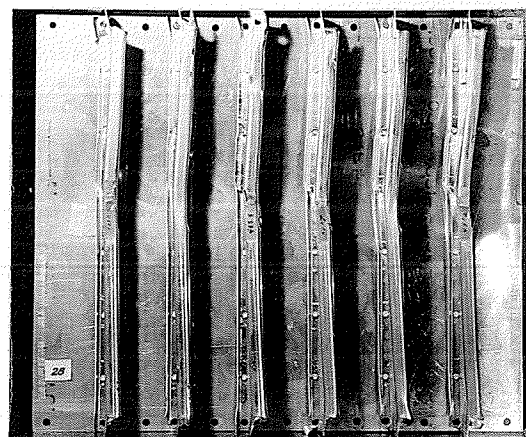

Figure 40 Panel 28

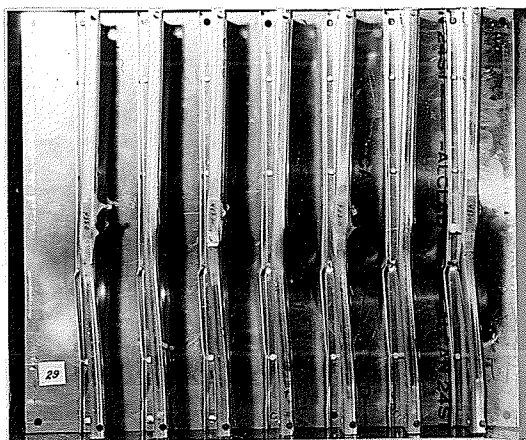

Figure 41 Panel 29

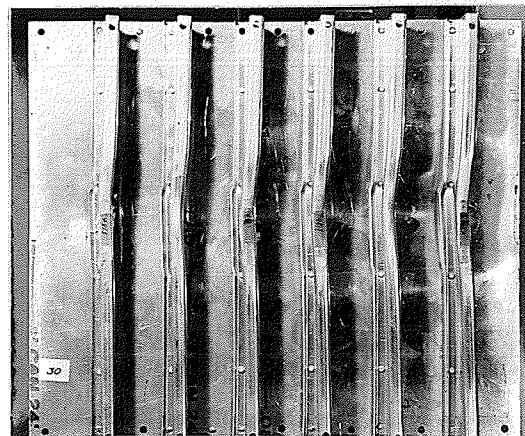

Figure 42 Panel 30

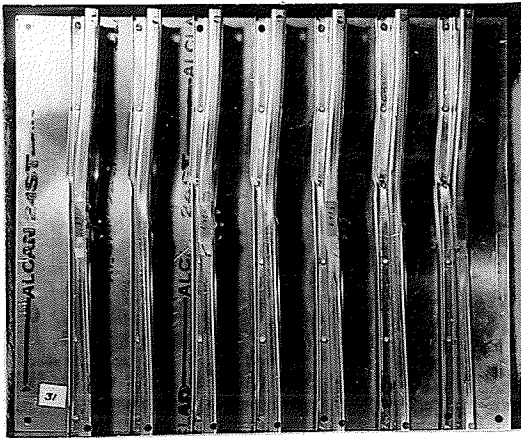

Figure 43 Panel 31

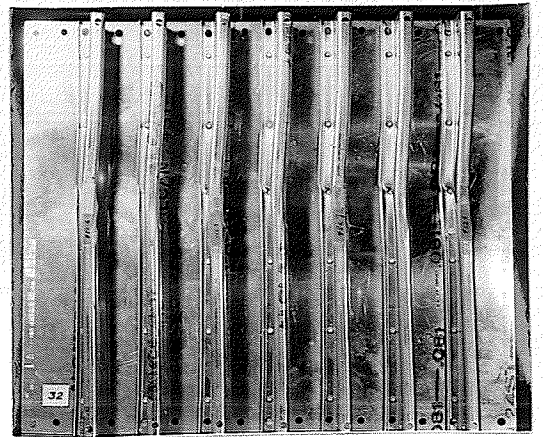

Figure 44 Panel 32

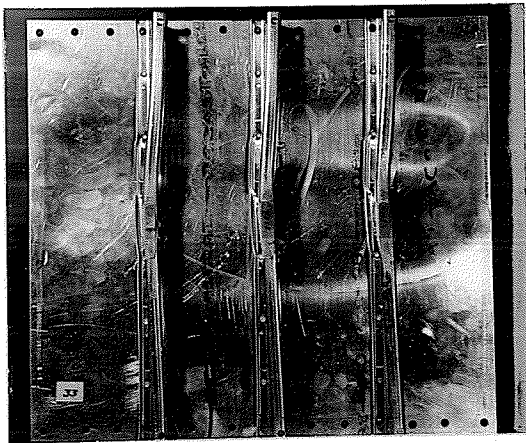

Figure 45 Panel 33

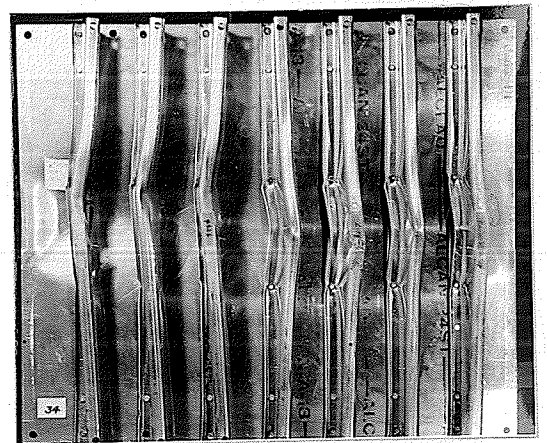

Figure 46 Panel 34

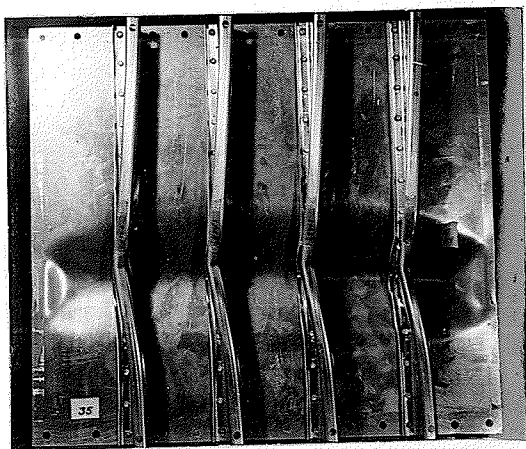

Figure 47 Panel 35

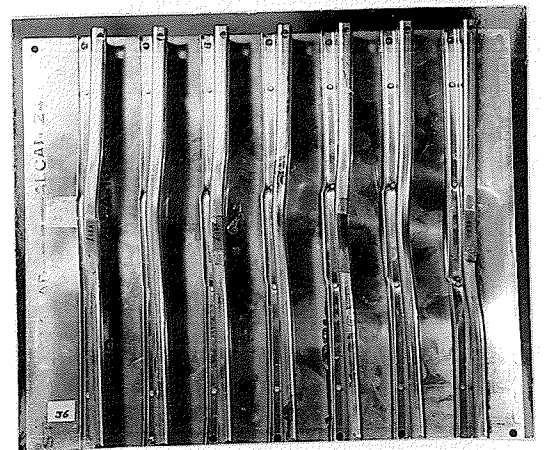

Figure 48 Panel 36

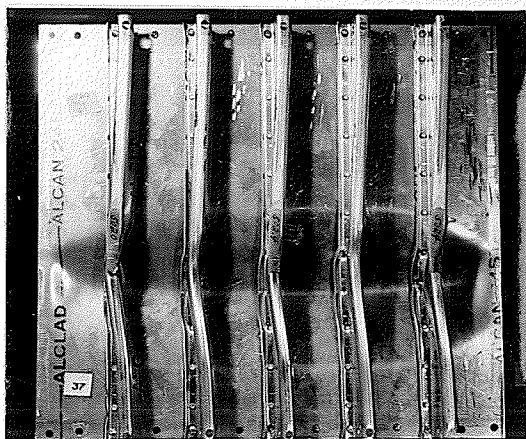

Figure 49 Panel 37

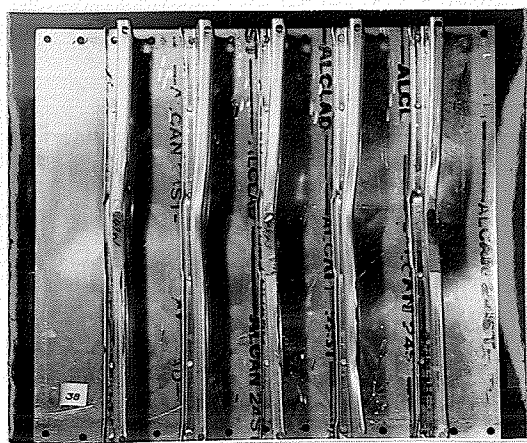

Figure 50 Panel 38

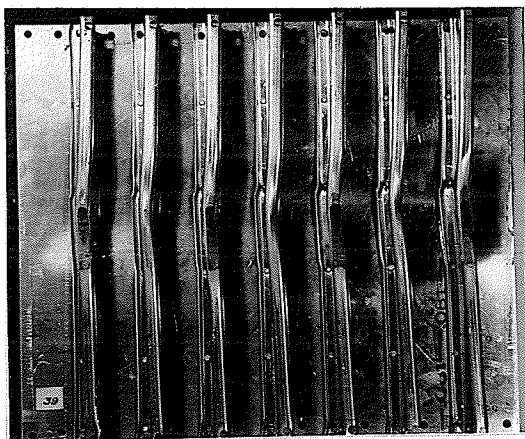

Figure 51 Panel 39

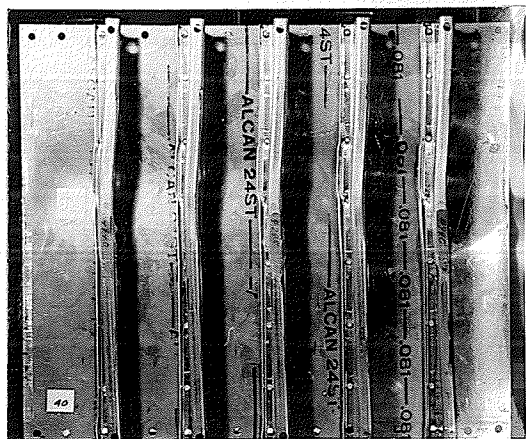

Figure 52 Panel 40

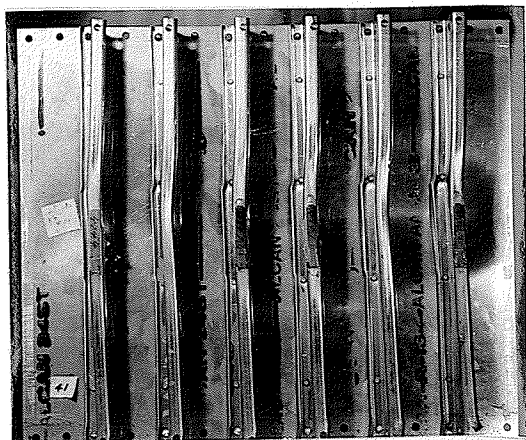

Figure 53 Panel 41

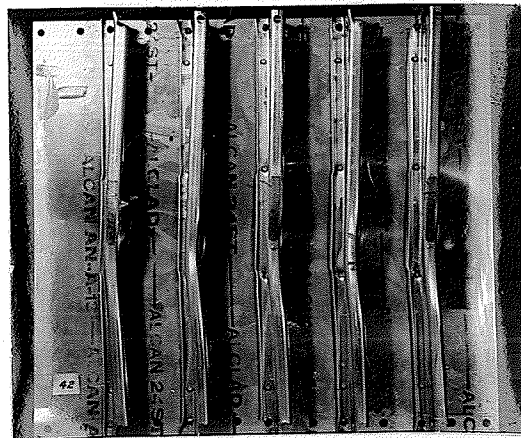

Figure 54 Panel 42

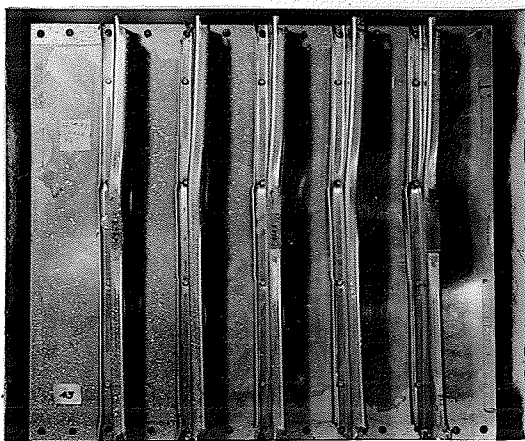

Figure 55 Panel 43

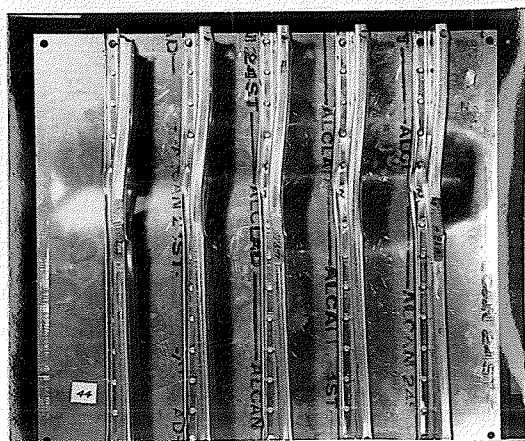

Figure 56 Panel 44

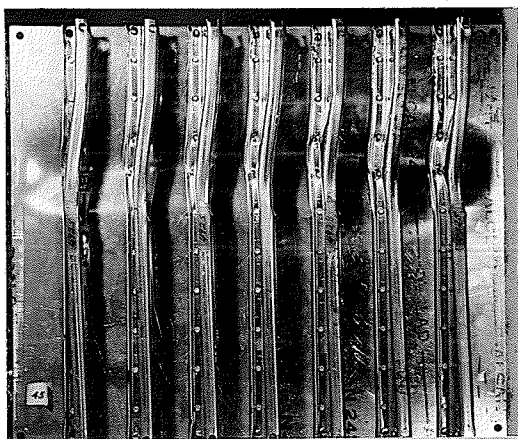

Figure 57 Panel 45

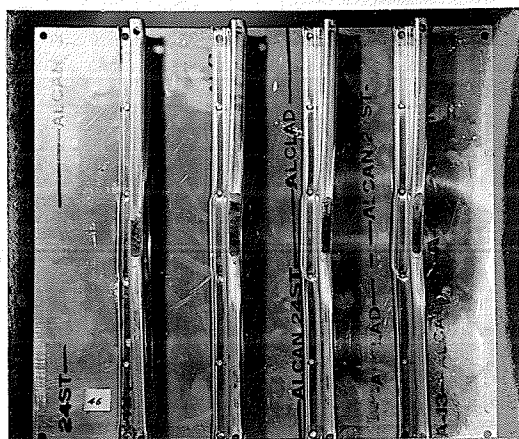

Figure 58 Panel 46

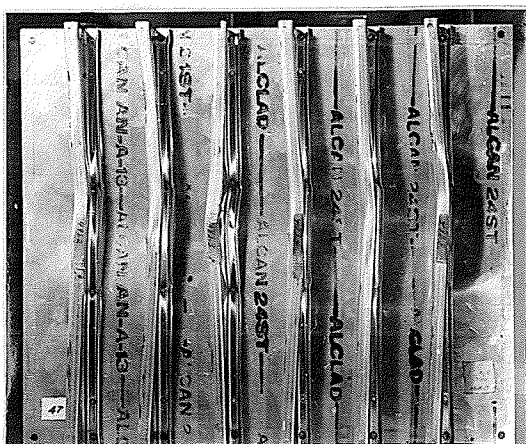

Figure 59 Panel 47

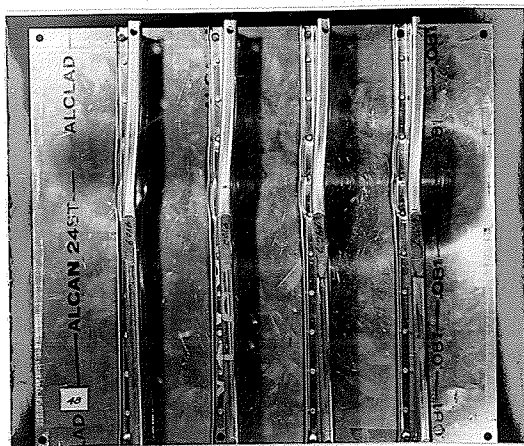

Figure 60 Panel 48

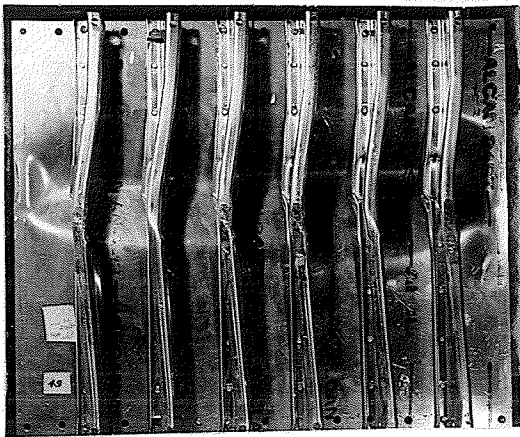

Figure 61 Panel 49

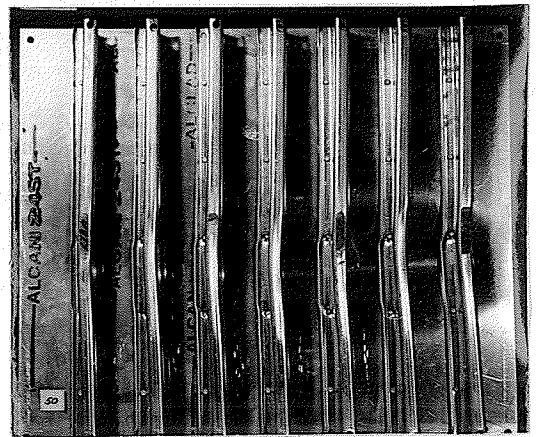

Figure 62 Panel 50

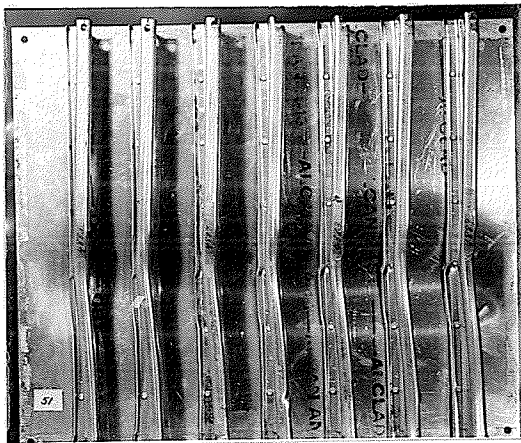

Figure 63 Panel 51

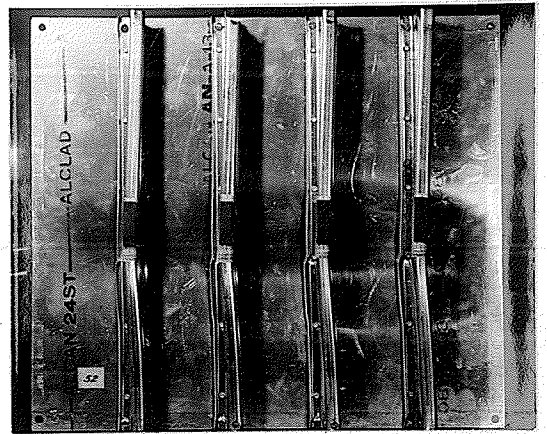

Figure 64 Panel 52

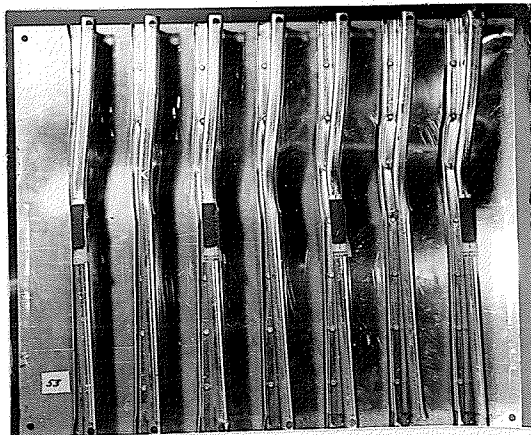

Figure 65 Panel 53

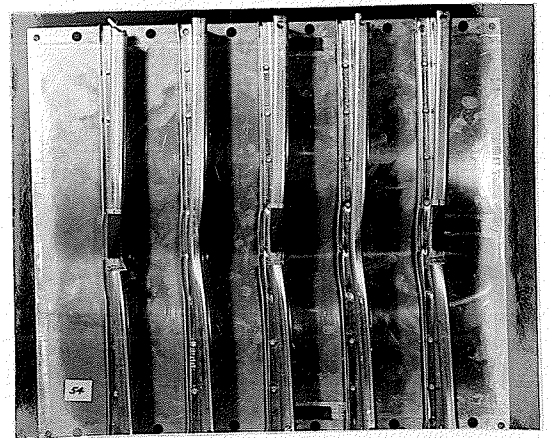

Figure 66 Panel 54

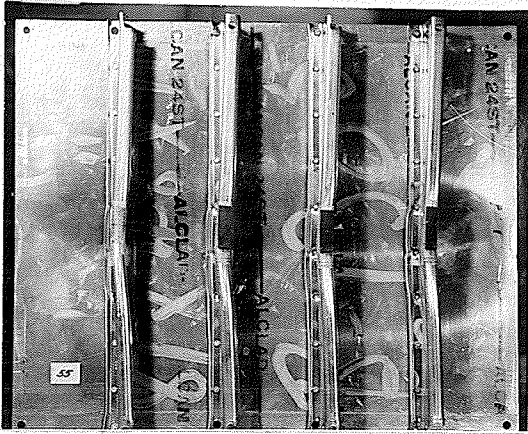

Figure 67

Panel 55

thereafter deforms plastically at more or less constant stress. The modulus recorded is that of the second part of the curve and is known as the secondary value. Since the aluminum coating is the same thickness for all sheet sizes, the secondary modulus is lower for the thinner sheets. Average values of E in tension were found to be 9.98, 9.88, 9.65, and 9.33, million pounds per square inch for sheet thicknesses of .081, .066, .040, and .032, inches respectively. The modulus in compression was in general about four per cent higher than the tension value. Average value of the 0.2 per cent yield strength was 48,500 pounds per square inch in tension, and 45,000 pounds per square inch in compression.

Grid displacement readings. A typical set of photo-grid readings is plotted graphically on Figure 72. This shows the vertical profile of the sheet at each stiffener. Horizontal dashed lines indicate the rivet locations. From similar curves the pin-end length of the major buckle, the number of half-waves, and the type of buckling were deduced for each panel. Data for determining the critical buckling stress were also obtained from the displacement readings.

Figures 73 and 74 show sheet profiles at stringers and at lines midway between stringers for one of the panels tested. It is apparent from Figure 73 that anti-symmetrical plate buckling has taken place to a small degree at the

FIGURE 68 TENSION STRESS STRAIN CURVES

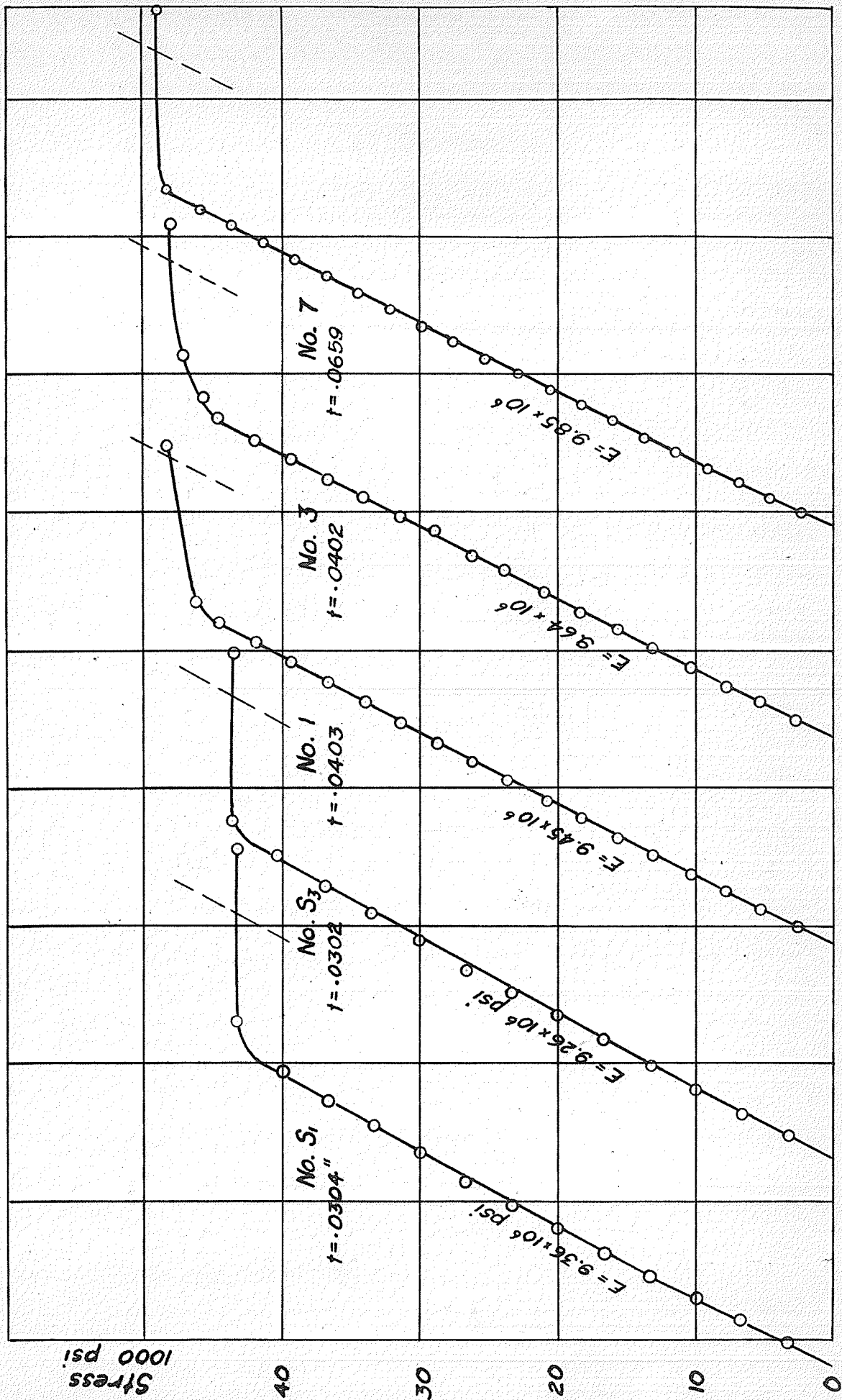

Strain 1 in. = .002 in./in.

FIGURE 69 TENSION STRESS STRAIN CURVES

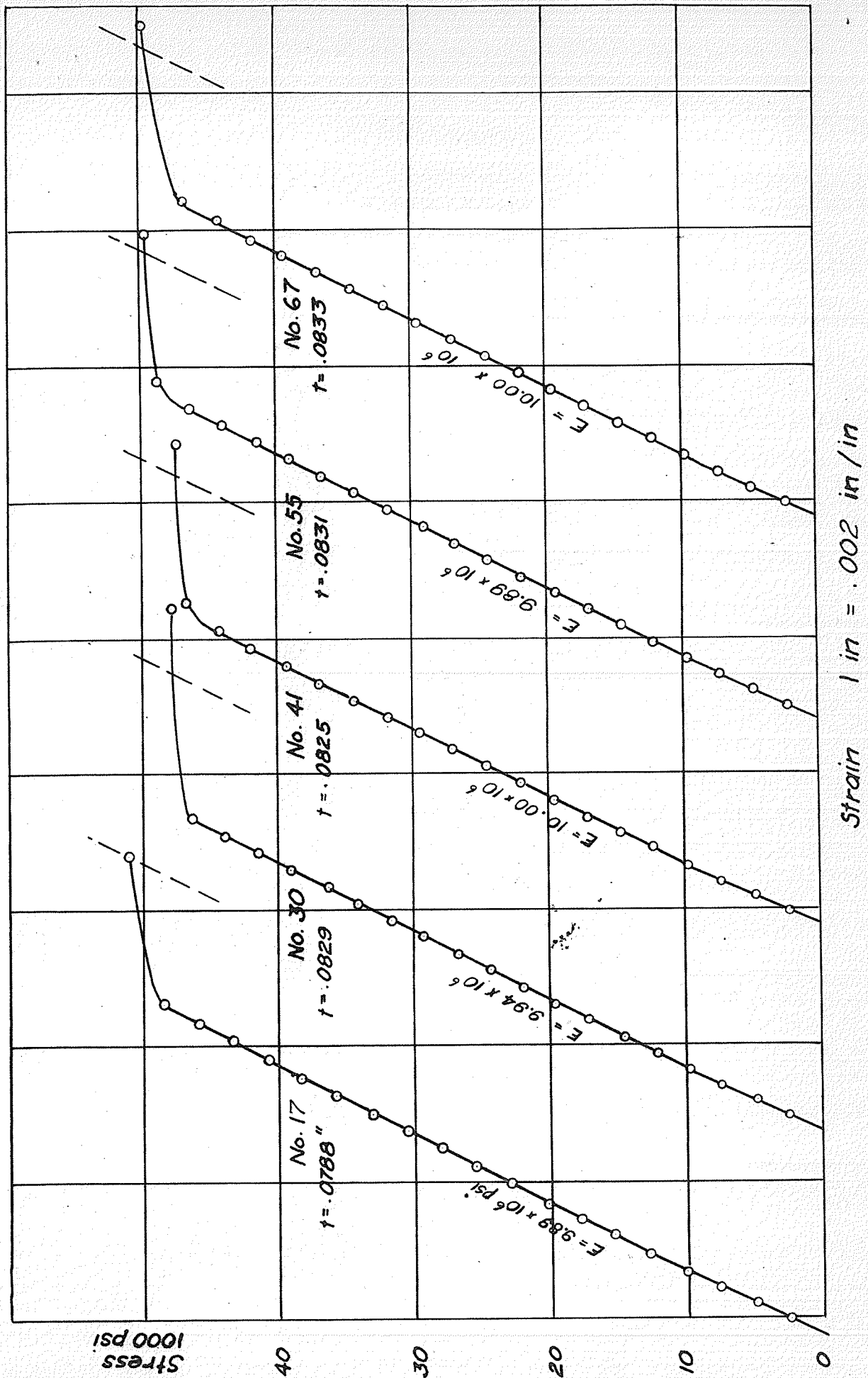
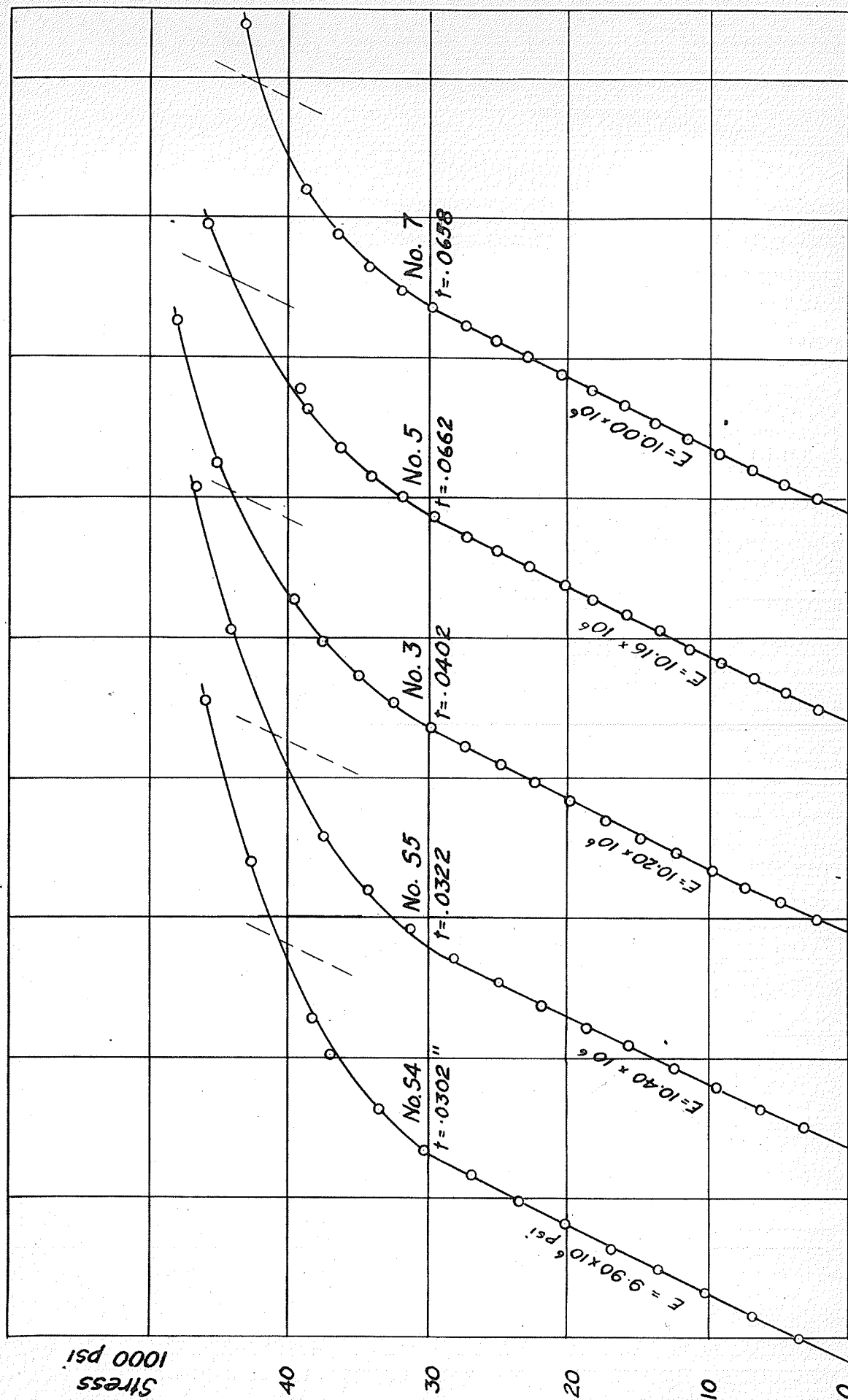
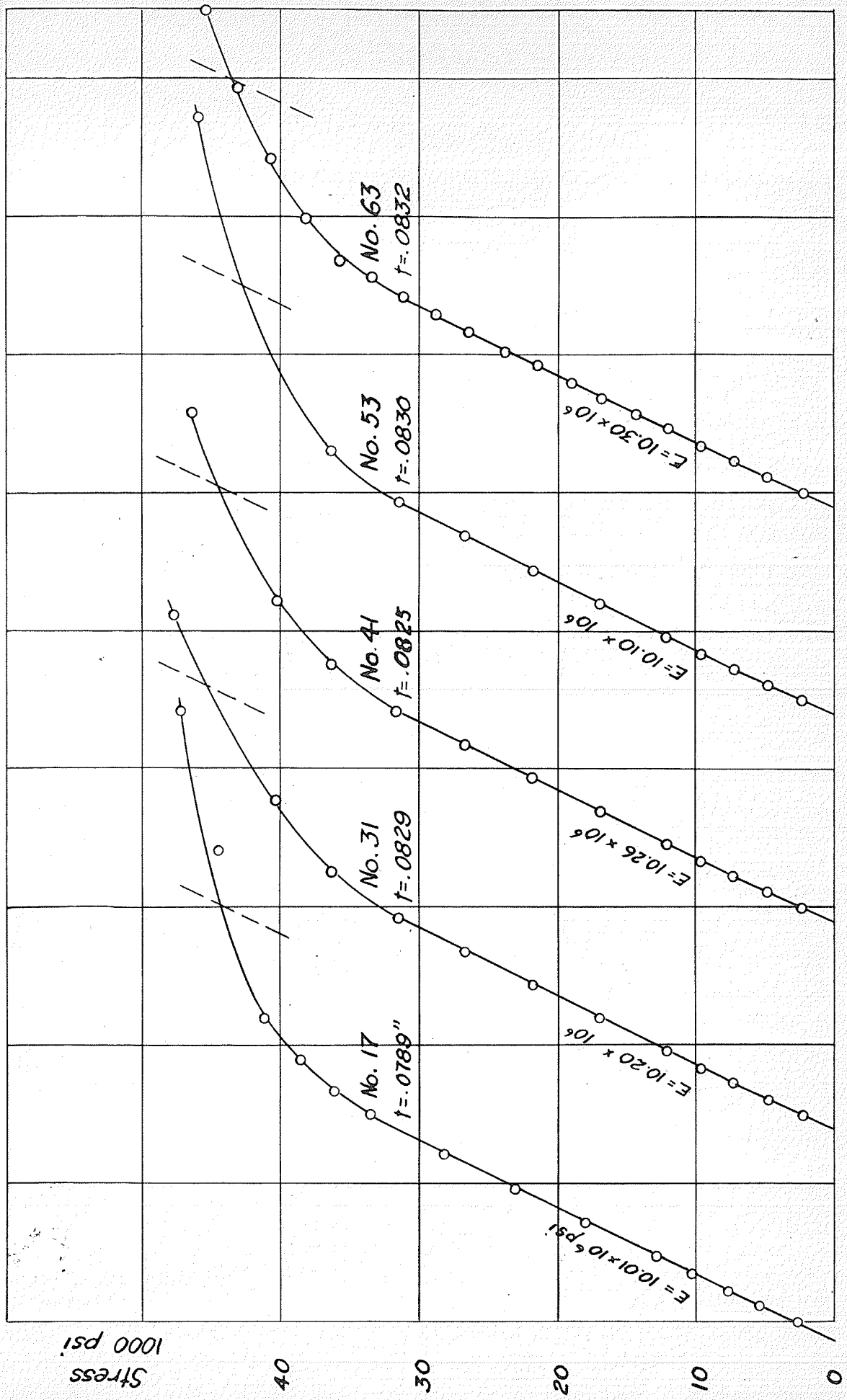

FIGURE 70 COMPRESSION STRESS-STRAIN CURVES



Strain 1 in. = .002 in./in.

FIGURE 71 COMPRESSION STRESS STRAIN CURVES



Strain in./in. = 0.002 in./in.

FIGURE 72 PANEL 32

Sheet profiles at each stiffener for 40,000 load.
Horizontal Scale 1 in = .02 in

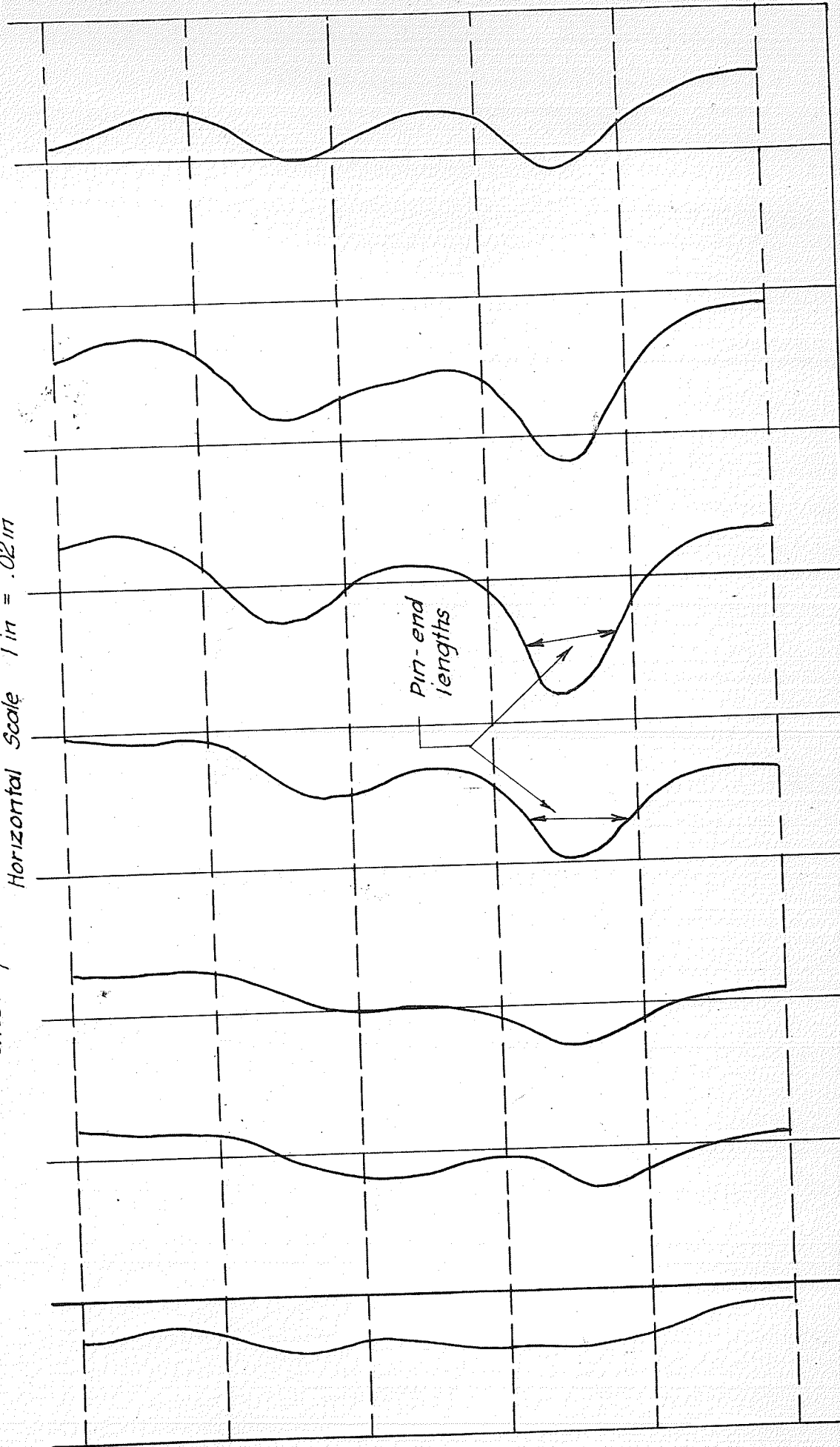

FIGURE 73

PANEL 19

VERTICAL CROSS-SECTIONS

Deflections from 0 to 32,000 lb.

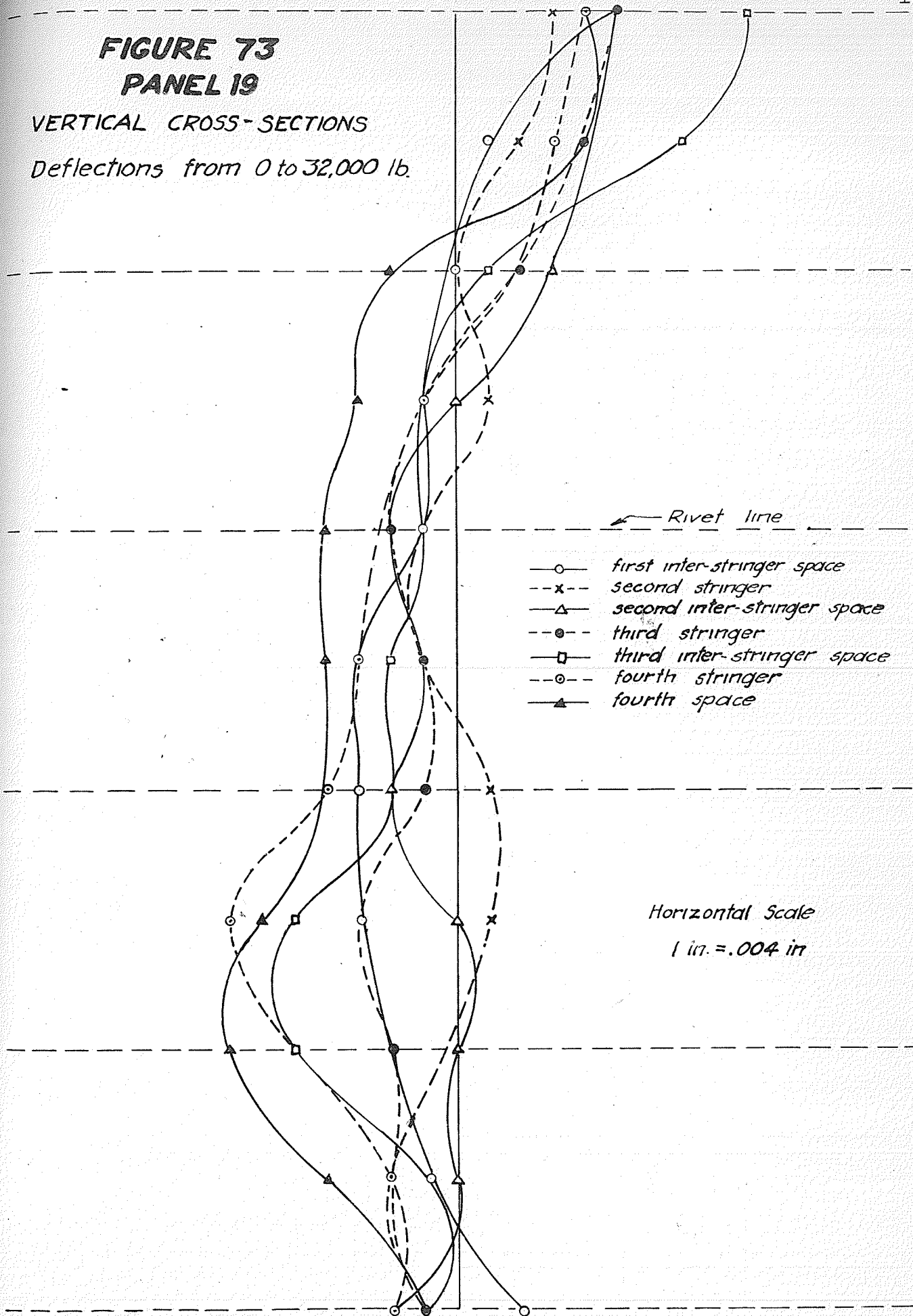
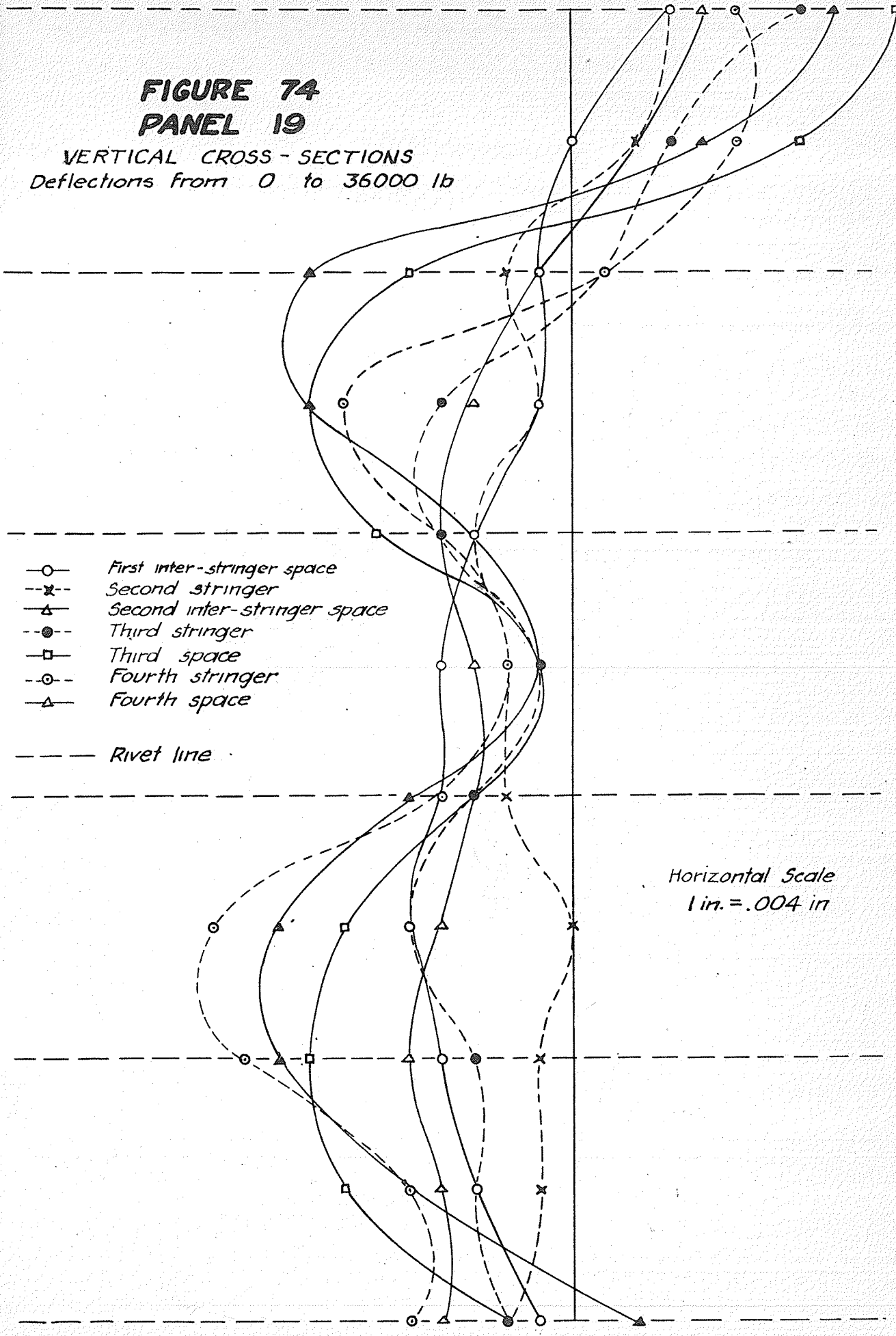

FIGURE 74 PANEL 19

VERTICAL CROSS - SECTIONS
Deflections from 0 to 36000 lb



- — First inter-stringer space
- x— Second stringer
- △— Second inter-stringer space
- Third stringer
- Third space
- Fourth stringer
- △— Fourth space
- — Rivet line

Horizontal Scale
1 in. = .004 in

lower load. At higher loads this has disappeared, and has been replaced by inter-rivet buckling as shown in Figure 74. The amount of plate buckling developed in this and similar panels .081 inches thick is so small that it could not be detected except by precise measurement. This phenomenon was observed in many of the panels tested, and will be considered further in discussion of test results.

The effective way in which the photo-grid method delineates buckling behaviour is illustrated in Figure 75. It should be pointed out that this photograph was taken at failure, and that the second line of rivets had pulled through the stiffeners. This explains the large wavelength of the principal buckle. Figures 76 and 77 again illustrate the transition from plate buckling to inter-rivet buckling for increased loads. In this case, however, the sheet thickness was only .040 inches, and the panel design was such that well-developed plate buckling was to be expected.

The general arrangement of photo-grid equipment is illustrated in Figure 78, which shows a panel set up for test. The arc lamp may be seen supported on a tube clamped to the right-hand testing machine column. The tube fixed to the left-hand column is the camera support. The method used for carrying the lamp and camera was necessitated by the fact that the testing machine table rises as load is applied. In order to obtain pictures from a fixed position relative

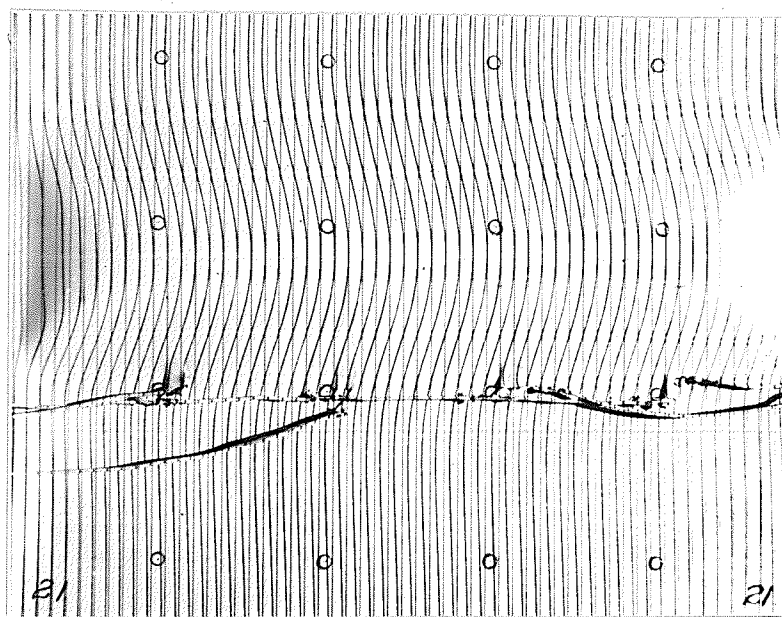

Figure 75.— Typical appearance of a photo-grid record. The irregular horizontal lines are strain gauge lead wires.

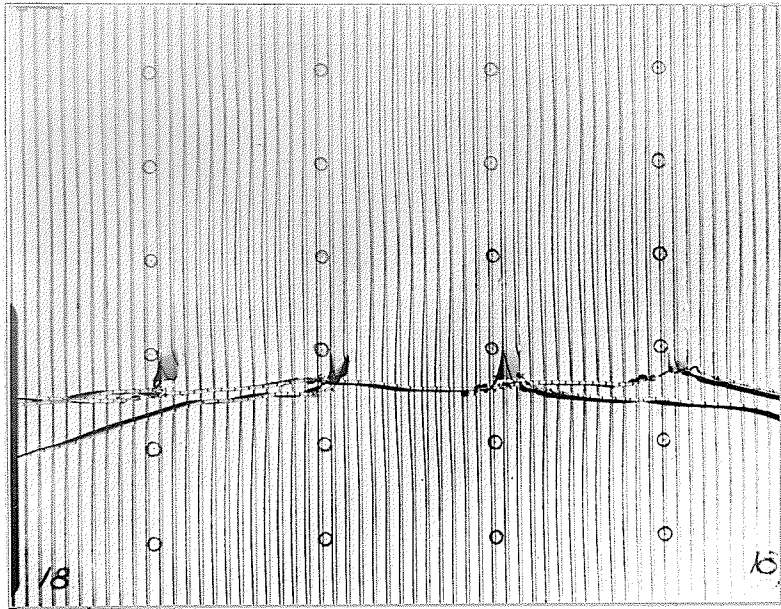

Figure 76.— Anti-symmetrical plate buckling of panel 18 at 9,000 lb. load.

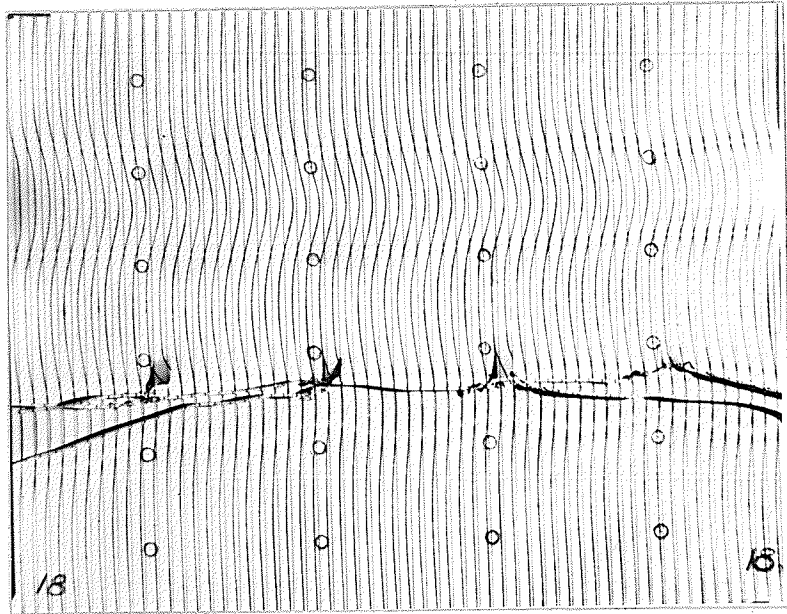

Figure 77.— Panel 18 at failure. Plate buckling has been replaced by inter-rivet buckling.

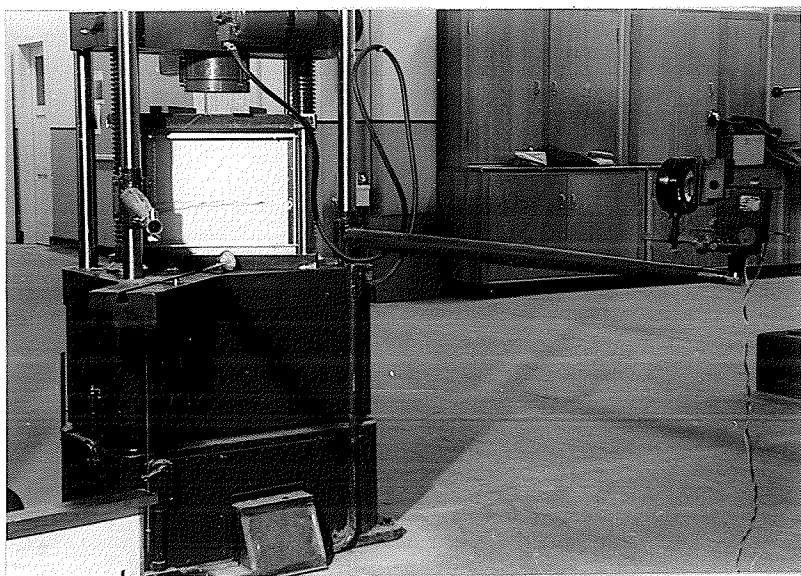

Figure 78.— Panel set up for test. The arc lamp may be seen at the extreme right. The end of the camera support tube appears at the lower left corner of the panel.



to the panel it was therefore necessary to support the equipment on the machine columns, which are attached to the table.

CHAPTER VI

CALCULATIONS

Determination of photo-grid dimensions. In designing the photo-grid equipment, it was deemed desirable to set it up so that readings of panel deformations could be taken directly without the use of one or more calibration constants. A reading sensitivity of at least .002 inches was required. Because of the large number of photographs involved, the use of a 35 millimeter camera taking 36 exposures on one loading was considered for obvious reasons. On account of the small negative size, a microscope was necessary for reading to the required sensitivity. Preliminary investigation of images on micro-file film showed that a visual magnification of about 60X was most suitable, because at this value the full resolution of the film was clearly readable. At greater magnifications, the individual grains in the film became objectionably large, interfering with ease of reading image displacement. Films of finer grain and greater resolution than micro-file have not yet been produced. A Bausch and Lomb metallurgical microscope, fitted with a 32 millimeter objective and bi-filar micrometer eyepiece, was selected for film measurement. This eyepiece and objective combination gave a visual magnifica-

tion of 58x.

The first step in designing the equipment was to determine the calibration constant for the eyepiece. Using a stage micrometer having .01 millimeter graduations, the eyepiece constant was found to be 4.21 divisions for .01 millimeter image displacement.

That is $1 \text{ division} = \frac{.01}{4.21} = .002375 \text{ mm.}$

For one division to be equivalent to .002 inches panel displacement, the film magnification must be

$$\frac{.002375}{.002 \times 25.4} = \frac{1}{21.4}$$

The camera, a Kine Exacta, was equipped with a Tessar type lens of 50 millimeters nominal focal length. The optical properties of a simple lens system give the following relations:

$$\frac{1}{d_i} + \frac{1}{d_o} = \frac{1}{f} \quad \text{and}$$

$$\frac{d_o}{d_i} = \frac{1}{M}$$

where d_i and d_o are image and object distances from the nodal planes of the lens respectively, and M is the magnification.

Hence on substitution we have

$$\frac{1}{d_i} + \frac{1}{d_o} = \frac{1}{50}$$

$$\frac{d_o}{d_i} = 21.4$$

$$\frac{21.4}{d_o} + \frac{1}{d_o} = \frac{1}{50}$$

i.e. $d_o = 1120 \text{ mm. or } 44.1 \text{ inches}$

The distance from the front nodal plane of the camera lens to the face of the panel was thus fixed in all tests at 44.1 inches.

A shadow spacing of one-quarter inch with shadows appearing one-twentieth inch to the left of the grid threads was selected as being most suitable. Referring to Figure 9, on page 23, by similar triangles

$$\frac{0.55}{44.1} = \frac{y}{44.1 - y}$$

from which the grid distance, $y = 0.543$ inches.

Also $\frac{S}{0.5} = \frac{44.1 - y}{44.1} = \frac{43.557}{44.1}$

from which $S = .4933$ inches. The grid spacing $= \frac{S}{2} = .2467$ inches.

These distances were used in all panel tests. It should be observed that the camera was focused on the plate, and that the grid threads appear at one-quarter inch spacing, as do their shadows, at this lens setting, in spite of the fact that they are actually spaced at less than one-quarter inch.

Pin-end lengths. From the photo-grid negatives, the length between inflection points of the principal buckle was measured and recorded as the pin-end length. This informa-

tion will be of considerable value in checking the validity of any theoretical method of design which may be developed. The figures tabulated in the summary of results are the best approximations that could be made of this parameter at loads close to the critical buckling value. Great personal error is involved in the pin-end length determination because of the small amplitude of the wave form, and the fact that it varied in magnitude across the width of the panel. The values reported are the average of measurements made at each stiffener location. Any measurements which appeared inconsistent were disregarded.

0.2 per cent buckle amplitude. The importance of wing smoothness has been previously mentioned. An obvious criterion of design is therefore the stress beyond which an arbitrary acceptable buckling amplitude is exceeded. A buckling amplitude of 0.2 per cent of the rivet pitch was chosen as a reasonable upper limit. The stress at this value was determined from the photo-grid measurements and will be found in the tabulation of results. Again, some personal error is involved in its determination. It is not surprising to find that the value so determined was close to the critical buckling stress.

Critical buckling stress. The value of P_{cr} , the critical buckling load, was determined by three different

methods as follows:

1. The load was plotted against the readings of the strain gauges attached to the sheet at mid-panel length as shown in Figure 79. The ordinate, at the point of intersection of the initial straight-line portion of the curve with a tangent to the curve at a point just beyond the knee, was taken as the critical buckling load. The values for each gauge were averaged and divided by the cross-sectional area of the panel to obtain the critical buckling stress. This method is very satisfactory when the principal buckle occurs in the zone of gauge attachment, but may give inaccurate results if the buckle occurs outside this area.

2. P_{cr} was determined by Southwell's¹ method. This method assumes a small initial curvature of the panel under a load below the critical value. A general expression for the column deflection in the form of a trigonometric series is employed, the first term of which is predominant at loads close to the critical value. Assuming that the deflection is given with sufficient accuracy by the first term alone we have

$$\delta = \frac{a_1}{(P_{cr} / P) - 1}$$

in which δ is the deflection, a_1 the initial deflection, and P the load on the panel. Rearranging terms we obtain

$$\frac{\delta}{P} P_{cr} - \delta = a_1$$

¹ S. Timoshenko, Theory of Elastic Stability, McGraw Hill, 1936, page 177.

LOAD - STRAIN CURVES PANEL 43

P_{cr} :- Gauge 1 : 21800 lb
 Gauge 2 : 20300 lb
 Gauge 3 : 21000 lb

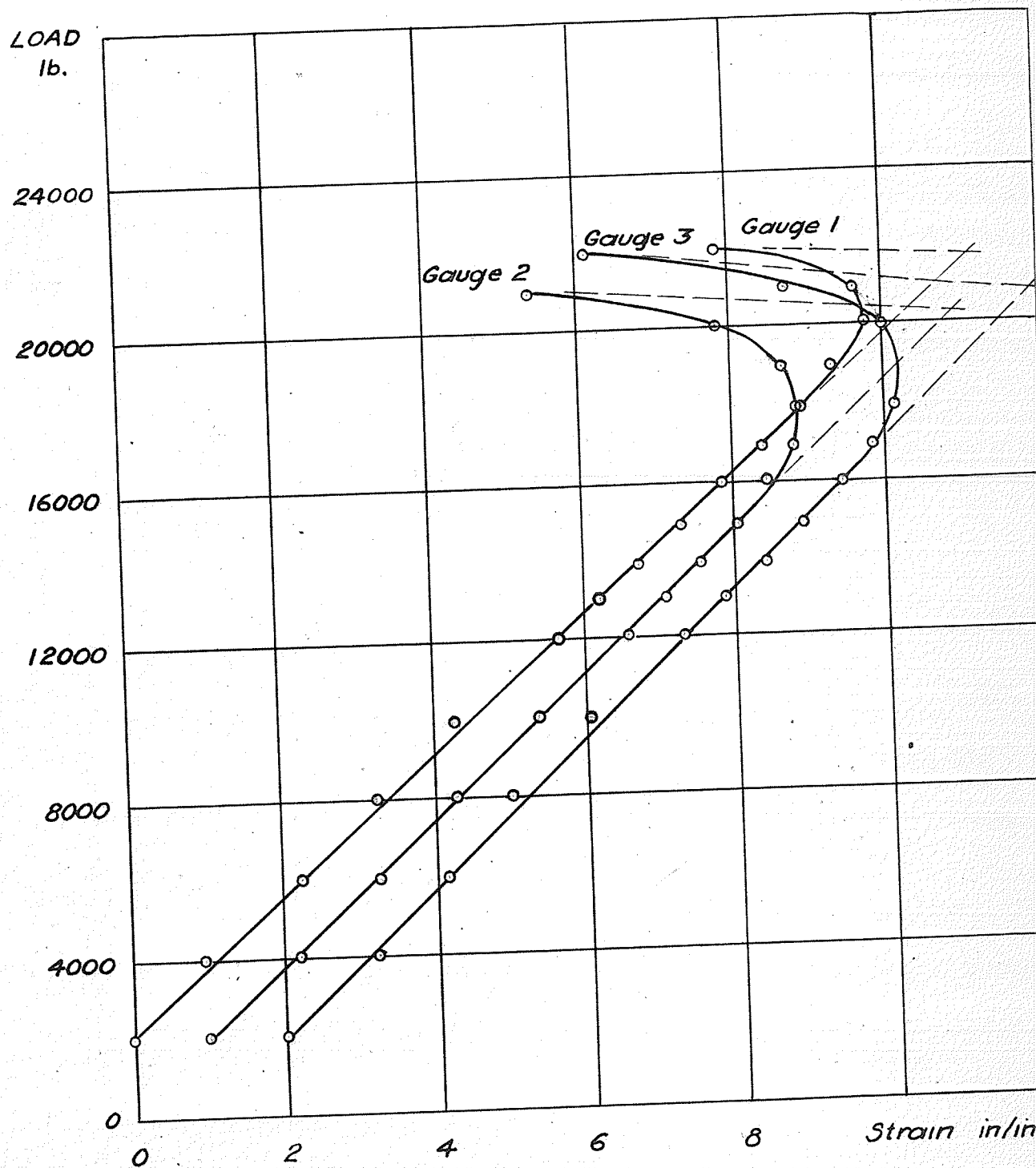

FIGURE 79

This indicates that, if δ/P is plotted against δ the points will fall on a straight line. The equation is now seen to be that of a straight line in terms of the inverse slope and x intercept. The x intercept gives a_1 , and P_{cr} is found as the inverse slope of the line.

In using this method the displacements at the centre of the principal buckle were measured from the photo-grid negatives, and plotted as illustrated in Figure 80, for the sheet at each stringer location. The average value of the inverse slopes was divided by the panel sectional area, and recorded as the critical buckling stress.

This method is always applicable except that in a few cases the points do not lie on a straight line, due possibly to initial lack of straightness.

3. The third method employed consisted of plotting the load against the deflection at the principal buckle. This curve, theoretically, should have a sharply defined knee at P_{cr} . Actually, for various reasons, the knee is not sharp. The curve is therefore idealized by projecting a tangent to the second part of the curve backward to intersect the load axis. The ordinate at this point of intersection was taken as P_{cr} and the values so obtained were converted to the critical buckling stress as in the previous methods. A typical curve illustrating this method is given in Figure 81.

SOUTHWELL CURVES

PANEL 43

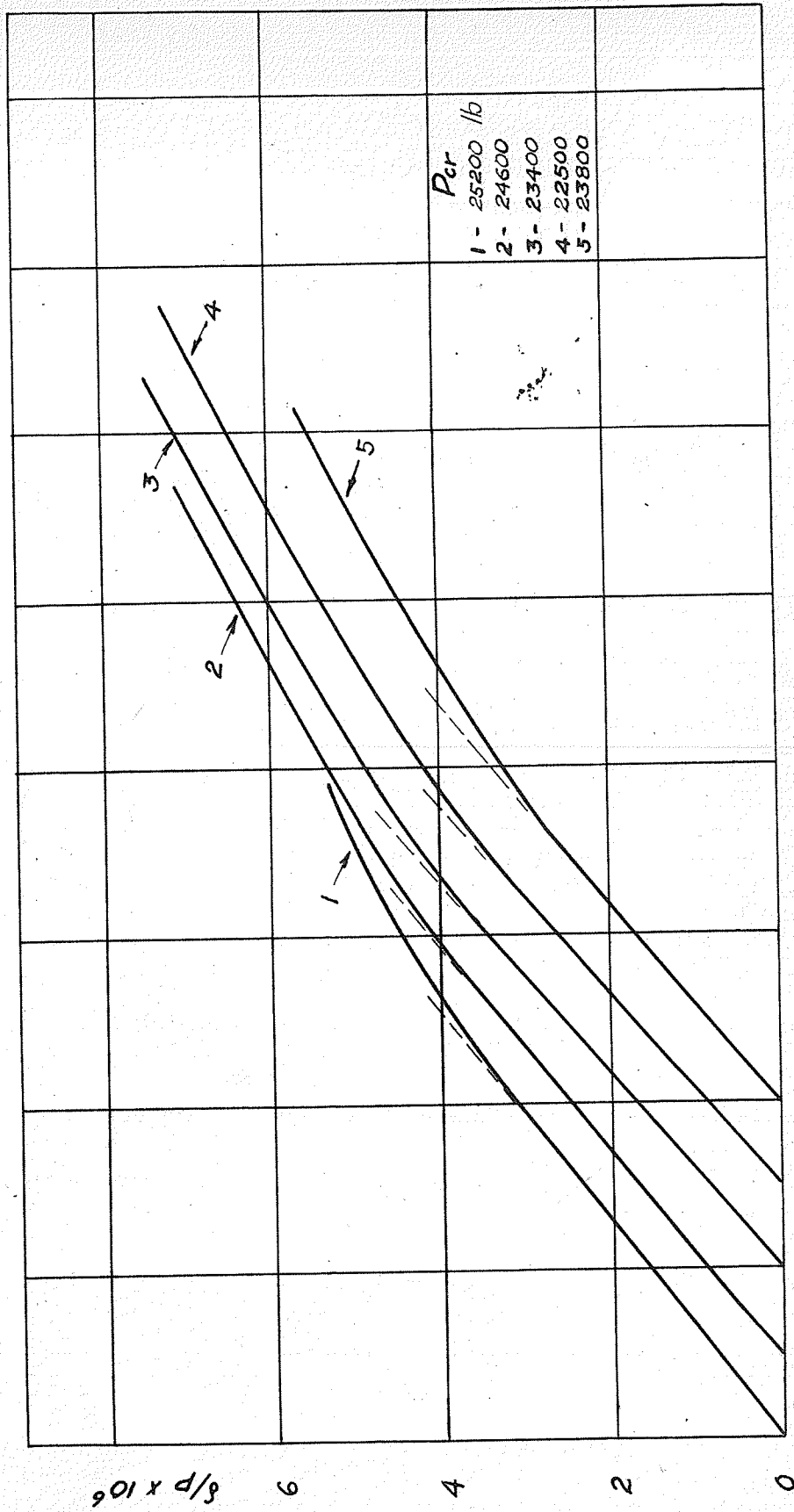

δ 1 in. = .04 in.

FIGURE 80

LOAD-DEFLECTION CURVES

PANEL 43

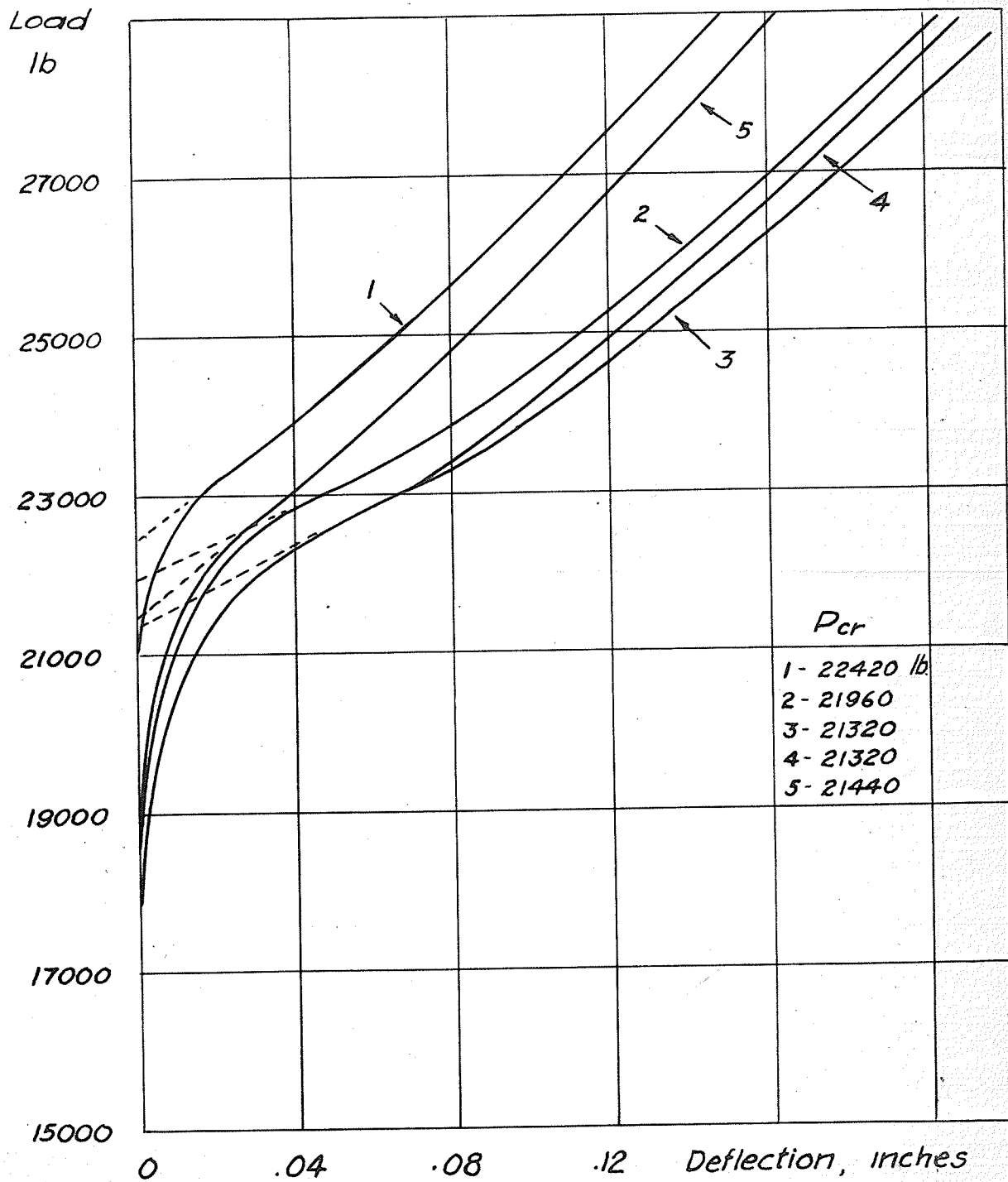

FIGURE 81

Additional calculations. Values of the non-dimensional parameters, A_{str}/bt (stiffener area over sectional area of sheet between stiffeners) and L/t (rivet pitch over sheet thickness) were calculated and have been recorded. These values are commonly used for graphical presentation by other investigators, and have been included for this reason only.

CHAPTER VII

PRESENTATION AND DISCUSSION OF RESULTS

Presentation. A tabulation of the results obtained from the fifty-five panels tested is given in Table LVII. In a few cases it will be observed that some of the values have been omitted. In these instances it was not possible to determine the figure with reasonable accuracy. Included in the table are values of the number of half waves into which the panel buckled, and also the type of instability. With respect to the number of half waves, it should be pointed out that it is incorrect to assume that these were of uniform length. The rivet spacing seldom coincided with the half-wavelengths and this effect, together with the necessarily small buckle amplitude toward the stiffener, caused differences in the lengths of each half wave.

The type of instability is indicated by letter as follows:

- R—inter-rivet buckling
- P—plate buckling of such magnitude as to be clearly visible to the unaided eye.
- W—wrinkling of the sheet into five or more half-waves. In this type of failure the half-wavelength appeared to be independent of rivet pitch, the form of instability being somewhat analogous to sandwich buckling.

- PR—plate buckling initially, followed by inter-rivet buckling at failure.

The critical buckling stress tabulated is that value

SUMMARY OF RESULTS

PANEL NUMBER	PANEL WIDTH	SHEET THICKNESS	NUMBER OF STRINGERS	CROSS-SECTIONAL AREA OF PANEL	RIVET PITCH	STRINGER PITCH	PIN-END LENGTH OF HALF-WAVE	NO. OF HALF WAVES PARALLEL TO LOAD	$\frac{A_{str}}{b}$	$\frac{L}{t}$	CRITICAL BUCKLING STRESS	C.B.S. for $d = 0.2\% L$	ULTIMATE LOAD	AVERAGE ULTIMATE STRESS	$\frac{P_{ult}}{P_{cr}}$	TYPE OF INSTABILITY
PANELS WITH SEVEN STRINGERS. $b = 2$ "																
45	16	.0835	7	1.851	1.25	2.00	2.0	5	0.440	14.97	27800	27000	52760	28500	1.024	W
22	16	.081	7	1.810	1.50	2.00	1.5	8	0.454	18.5	25200	25200	50000	27650	1.095	R
26	16	.081	7	1.810	1.75	2.00	1.75	7	0.454	21.6	24500	24300	45900	25400	1.036	W
15	16	.082	7	1.827	2.00	2.00	2.0	6	0.448	24.4	failure	failure	48950	26850	1.00	R
32	16	.0825	7	1.836	2.25	2.00	1.7	5	0.445	27.3	21200	21200	40900	22300	1.052	R
31	16	.0815	7	1.819	2.50	2.00	2.50	5	0.451	30.5	19000	17000	35720	19640	1.035	R
39	16	.084	7	1.858	2.75	2.00	2.75	4	0.438	32.7	18150	17100	35970	19370	1.067	R
29	16	.0825	7	1.836	3.00	2.00	3.00	4	0.445	36.4	18500	18500	36450	19870	1.074	R
36	16	.083	7	1.843	3.25	2.00	2.00		0.443	39.2	15700	13600	36180	19610	1.25	R
34	16	.083	7	1.843	3.50	2.00	1.75		0.443	42.2	12500	11400	34200	18670	1.493	R
PANELS WITH FIVE STRINGERS. $b = 2.5$ "																
44	15	.0815	5	1.588	1.00	2.50		4	0.361	12.3	27700		44000	27700	1.00	W
37	15	.083	5	1.613	1.25	2.50			0.354	15.05	25300		42680	26450	1.045	W
13	15	.082	5	1.599	1.50	2.50	2.2	5	0.358	18.3	25000	25000	41080	25700	1.03	W
19	15	.080	5	1.568	1.75	2.50	2.2	5	0.368	21.9	23200	23200	37010	23450	1.01	W
7	15	.080	5	1.568	2.00	2.50	2.0	6	0.368	25.0	19200	19150	33200	21200	1.105	R
14	15	.081	5	1.584	2.25	2.50	1.8	5	0.363	27.8	18800	17000	30940	19520	1.037	R
2	15	.082	5	1.598	2.50	2.50	2.5	5	0.358	30.5	16500	15200	29300	18300	1.11	R
38	15	.0825	5	1.605	2.75	2.50	2.75	4	0.356	33.3	14900	14900	29500	18380	1.235	R
5	15	.081	5	1.583	3.00	2.50	1.5	4	0.363	37.0	15700	14500	29780	18700	1.19	R
43	15	.0825	5	1.605	3.25	2.50	1.7	4	0.356	39.4	13600	12500	29810	18500	1.365	R
42	15	.0815	5	1.605	3.50	2.50	1.75		0.361	42.9	11600	8800	28950	18220	1.57	R

TABLE LVII

SUMMARY OF RESULTS. Cont'd.

PANEL NUMBER	PANEL WIDTH	SHEET THICKNESS	NUMBER OF STRINGERS	CROSS-SECTIONAL AREA OF PANEL	RIVET PITCH	STRINGER PITCH	PIN-END LENGTH OF HALF-WAVE	NO. OF HALF WAVES PARALLEL TO LOAD.	$\frac{A_{str}}{bt}$	$\frac{L}{t}$	CRITICAL BUCKLING STRESS	C. B. S. for $d = 0.2\% L$	ULTIMATE LOAD	AVERAGE ULTIMATE STRESS	$\frac{P_{ult}}{P_{cr}}$	TYPE OF INSTABILITY
PANELS WITH SIX STRINGERS. $b = 2.286$ "																
49	16	.0825	6	1.761	1.50	2.286	2.0	5	0.39	18.2	25600	25600	46050	26200	1.02	W
28	16	.0805	6	1.729	2.00	2.286			0.40	24.85	19700	19700	37950	21950	1.115	W
27	16	.0815	6	1.745	2.50	2.286	1.8	4	0.395	30.7	18300	15500	33210	19020	1.04	R
30	16	.0815	6	1.745	3.00	2.286	1.5	4	0.395	36.8	15800	14330	32400	18590	1.177	R
41	16	.082	6	1.753	3.25	2.286	1.6		0.392	39.6	14000	13700	32800	18710	1.336	R
47	16	.082	6	1.753	3.50	2.286	1.8		0.392	42.7	10600	9200	31960	18220	1.72	R
PANELS WITH FOUR STRINGERS. $b = 3$ "																
35	15	.0805	4	1.501	1.00	3.00	2.0	6	0.304	12.4	24700	22000	38500	25650	1.037	W
48	15	.083	4	1.538	1.25	3.00	2.0	6	0.295	15.07	23200	20500	36700	23850	1.028	W
24	15	.082	4	1.524	1.50	3.00	2.25		0.299	18.3	22000	21000	34350	22530	1.024	W
25	15	.0805	4	1.501	1.75	3.00	1.75		0.304	21.75	20000		30000	20000	1.00	W
20	15	.0815	4	1.517	2.00	3.00	2.0	6	0.300	24.55	20100	19000	30750	20300	1.01	W
52	15	.083	4	1.544	2.25	3.00	2.25	6	0.295	27.1	17500	16000	29300	18950	1.083	R
23	15	.081	4	1.509	2.50	3.00	2.50	5	0.302	30.9	16100	15000	26280	17430	1.08	R
46	15	.082	4	1.524	2.75	3.00	2.75	4	0.299	33.6	17100	16800	26620	17440	1.02	R
21	15	.080	4	1.494	3.00	3.00	2.0	4	0.306	37.5	14100	12700	26500	17720	1.257	R

SUMMARY OF RESULTS. Cont'd.

PANEL NUMBER	PANEL WIDTH	SHEET THICKNESS	NUMBER OF STRINGERS	CROSS-SECTIONAL AREA OF PANEL	RIVET PITCH	STRINGER PITCH	PIN-END LENGTH OF HALF-WAVE	NO. OF HALF WAVES PARALLEL TO LOAD	$\frac{A_{str}}{bt}$	$\frac{L}{t}$	CRITICAL BUCKLING STRESS	C. B. S. for $d = 0.2\% L$	ULTIMATE LOAD	AVERAGE ULTIMATE STRESS	$\frac{P_{ult}}{P_{cr}}$	TYPE OF INSTABILITY
MISCELLANEOUS PANELS.																
6	15	.082	6	1.672	2.00	2.14	2.00	6	0.419	24.4	21500	18200	36120	21600	1.005	R
40	15.95	.0815	5	1.669	2.00	2.66	2.0	6	0.339	24.5	21000	19800	35650	21350	1.015	R
55	16	.0825	4	1.521	1.50	3.20	2.25	5	0.278	18.2	21650		33540	20700	1.0	W
3	16	.083	4	1.622	2.00	3.20		4	0.284	24.1	16800	14800	27500	16950	1.01	W
33	15	.081	3	1.436	2.00	3.75	2.00	6	0.244	24.7	15800	14600	24300	16910	1.07	R
1	16	.083	3	1.549	2.00	4.00		6	0.2215	24.1	15800	15500	24650	15900	1.005	R
4	16	.083	3	1.549	2.50	4.00	2.00	5	0.2215	30.1	12300	11600	23360	15100	1.23	
DUPLICATE PANELS.																
50	16	.0815	7	1.821	2.50	2.00	2.50		0.450	30.6	19600	20300	39750	20800	1.06	R
51	16	.083	7	1.844	2.00	2.00	2.00	6	0.443	24.1	24400	22800	46000	25000	1.025	R
53	16	.082	7	1.825	1.75	2.00	1.75	5	0.448	21.4	24300	24100	46710	25600	1.055	W
54	15	.0825	5	1.607	1.50	2.50	2.6	5	0.356	18.2	24250	24200	39900	24800	1.02	W
THIN PANELS.																
8	16	.0665	4	1.359	1.50	3.20	3.0	4	0.345	22.6	15500	9500	26050	19180	1.24	P
9	16	.0655	4	1.342	2.00	3.20	2.0	6	0.350	30.6	14150	11200	23075	17200	1.215	R
10	16	.065	4	1.335	2.50	3.20	2.5	4	0.353	38.5	11700	10500	21750	16300	1.39	R
11	16	.0655	4	1.342	3.00	3.20	3.0	4	0.350	45.8	9400	8200	21490	16000	1.70	R
16	16	.0405	4	0.942	0.75	3.20	3.0	4	0.565	18.5	6500	5000	20520	21750	3.35	P
12	16	.0405	4	0.942	1.00	3.20	2.5	4	0.565	24.7	6250		18975	20130	3.22	P
17	16	.0405	4	0.942	1.25	3.20	2.5	5	0.565	30.85	6100		16490	17490	2.87	P
18	16	.0405	4	0.942	1.75	3.20	2.5	4	0.565	43.2	6100	6000	16200	17180	2.82	P, R

which was thought to be the most reliable from the three methods used for its determination. In most cases the three values were in close agreement. For the few panels in which inconsistencies occurred, there was usually at least one value which appeared to be well-defined.

The ultimate stresses for panels of nominal thickness .081 inch, with 4, 5, 6, and 7, stiffeners, are shown plotted against L/t in Figure 82. Figure 83 shows the variation of critical buckling stress with rivet pitch L , for panels having 4, 5, and 7, stiffeners. In the latter case, the tabulated critical buckling stress values have been adjusted, to compensate for variations from the nominal .081 inch sheet thickness. The curve for six stiffeners is of similar shape, but has been omitted for the sake of clarity.

DISCUSSION OF RESULTS

Load distribution. Trustworthy laboratory results from an investigation of this nature depend primarily on the attainment of uniform load distribution at the ends of the panel. In compression testing of any type, this requirement is difficult to satisfy since a small eccentricity of load application causes bending of the specimen, which, in turn, increases the eccentricity. Nearly all panel buckling investigators have employed some type of sliding parallel platen arrangement similar to the one shown in Figure 6, and have

FIGURE 82 VARIATION OF ULTIMATE STRESS WITH L/t

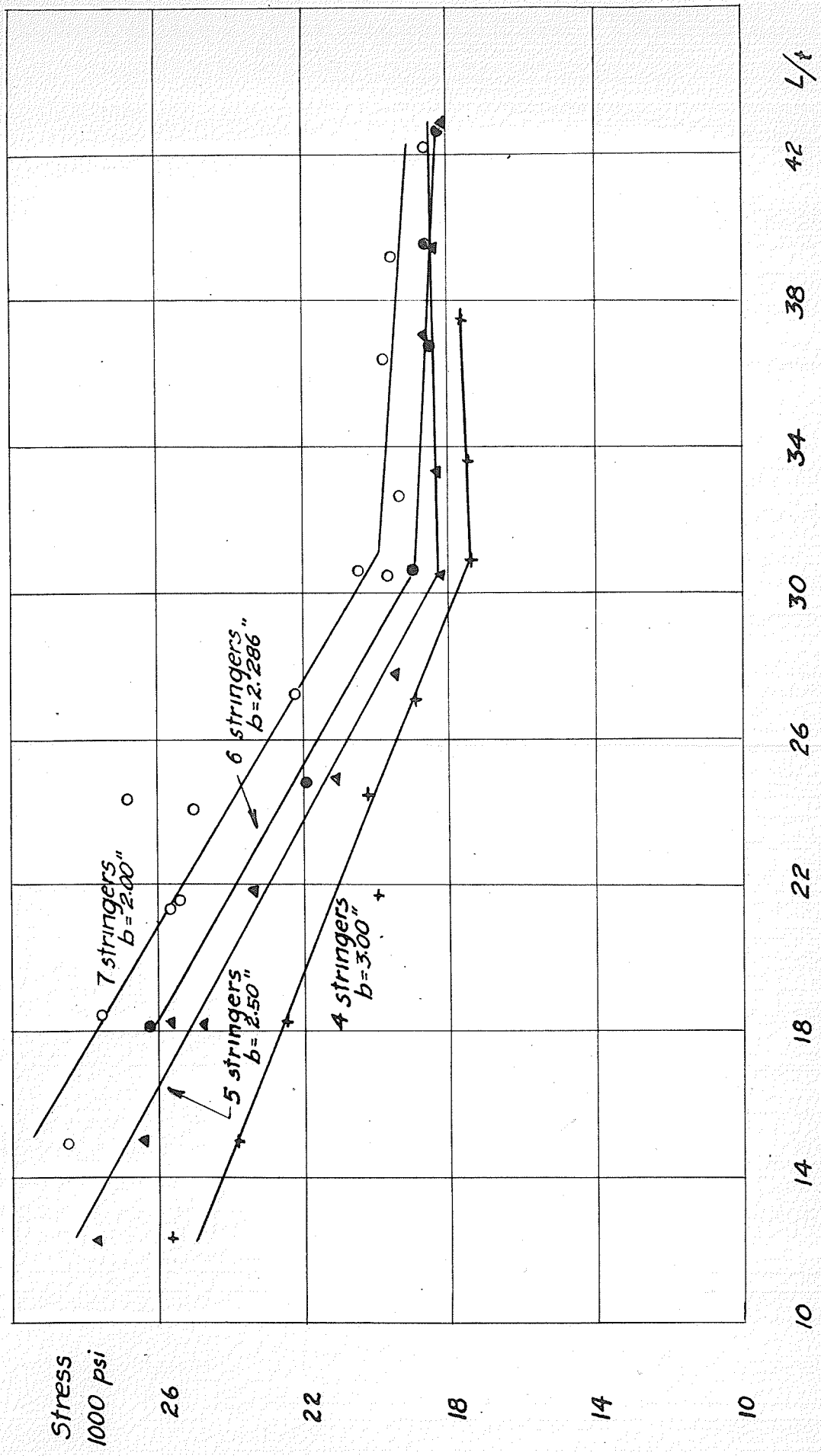

Stress
1000 psi

L/t

VARIATION OF CRITICAL BUCKLING STRESS WITH RIVET PITCH - L

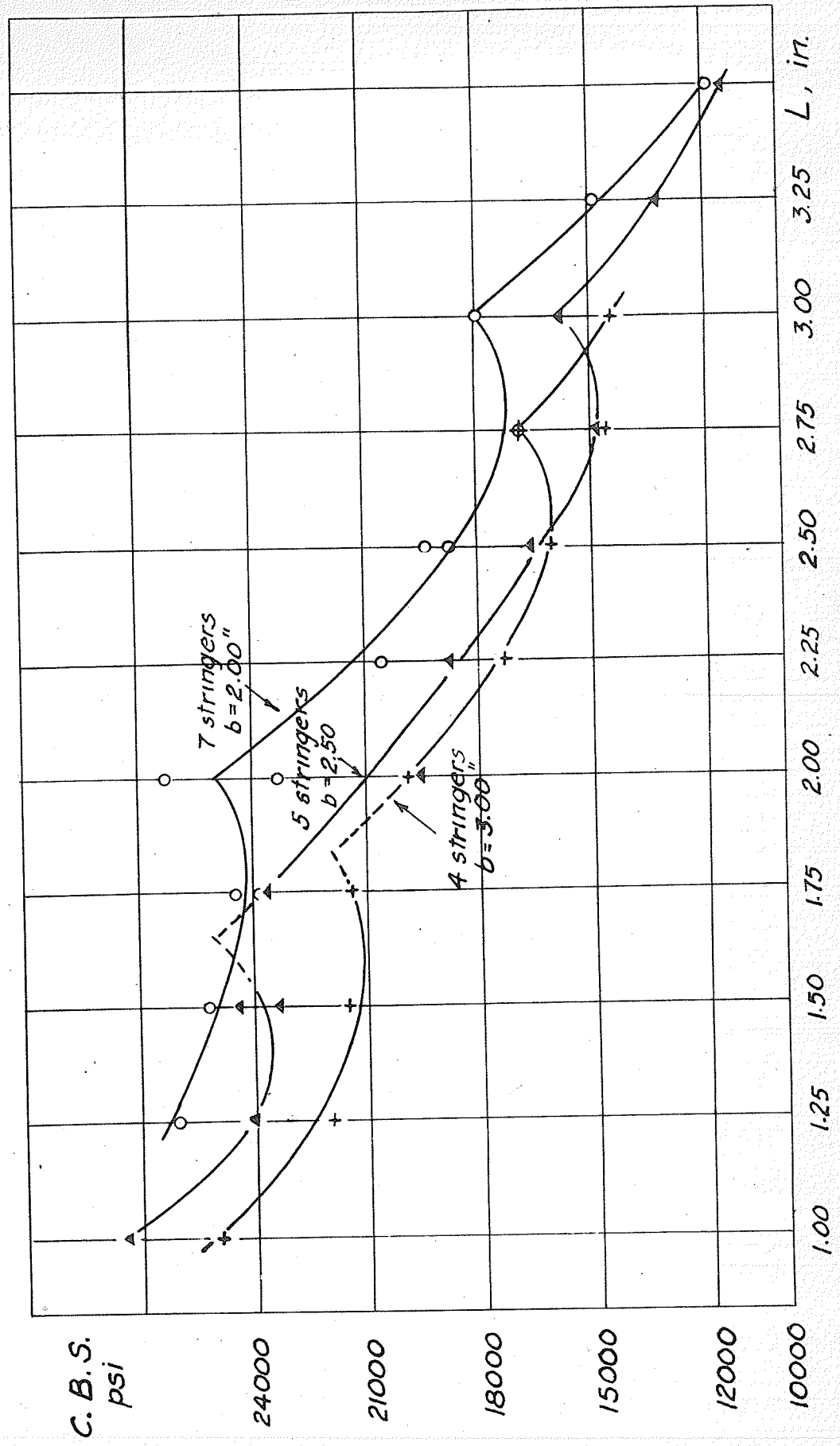

FIGURE 83

attempted to obtain uniform load distribution by providing accurately machined flat and parallel surfaces at the panel ends. Many reports have been published in which dial gauges at the four corners of the platen, as in Figure 12F, were used as an indication of uniform loading. In these cases, the panels were loaded so that all four dials gave the same reading during the test, that is, the panel ends were, at all times, parallel. This method does not result in uniform stress distribution at any point in the panel. The reason for this is due principally to the large width of the panel relative to its length. Considering, for the moment, the sheet alone, it is evident that its ends are almost completely restrained from lateral expansion in accordance with Poisson's ratio by the cerrobend cap, and by frictional resistance to sliding at the platen surface. The usual practical interpretation of St. Venant's principle indicates that the effects of this end restraint should die away more or less completely at a distance from the end of about half the width, that is, about eight inches in the present case. Since the panel length is only twelve inches, no part of it will be free from the effects of end restraint. For complete restraint the effective value of the modulus of elasticity in compression is $\frac{E}{1-\nu^2}$. It may be stated, then, that the compressive

stiffness varies from $\frac{E}{1-\gamma^2}$ at the ends, to approximately E at mid-length, for the sheet alone. This, of course, will result in a corresponding variation of the unit strain along the panel length.

Considering the stiffener alone, it is logical, from the above discussion, to expect that the effects of end restraint should disappear at about five-eighths of an inch from each end. In other words, the effects of end restraint on the stiffener alone are negligible, and its effective compression stiffness is E for almost its entire length. When sheet and stiffener are attached, and considered as a unit, it is apparent that there will be incompatibility between the stiffener and sheet stresses or strains, or both. If the platens remain parallel during loading, then the stress in the sheet will be higher than that in the stringer at all points, since the average effective modulus is higher.

More recent investigations have employed resistance strain gauges on the sheet and stiffeners, and have tried to establish uniform stress distribution across the mid-panel section. This was the procedure followed in the present series of tests. If uniform stress in stiffeners and sheet are maintained during loading, it is obvious from the previous discussion that the panel ends cannot remain parallel, but must approach each other more rapidly on the

stiffener side of the panel. There is thus rotation of the panel ends, resulting in bending of the stiffeners and hence the panel as a whole.

One more effect should be mentioned. The edge of the sheet, say up to the first stiffener, is not so greatly affected by the end restraint as is the central portion. This is partly due to the fact that the stiffeners mechanically anchor the central portion of the sheet in the cerrobend cap. As a result, the stiffness and therefore the stresses in the end bays of the sheet may be expected to be lower than in the centre.

Difficulties in obtaining uniform stress without rotation of the platens has been frequently reported, but it is believed that the above is the first reasonable explanation of the phenomenon.

As a check on its validity, several transverse gauges were installed on panel No. 54. An examination of Table LV will reveal the following information, all of which corroborates the above analysis. Transverse gauges 9 and 11, near the panel ends at the centre line, gave very low readings, indicating nearly complete fixity at these points. Gauge 7, also at the panel end, but at the edge instead of the centre, gave much higher readings, indicating that end restraint was not as effective in the end bays. Gauges 8 and 10 at panel mid-length showed the highest

readings, approximately thirty per cent of the longitudinal strains at the same points. Since Poisson's ratio is 0.30, this indicates that the horizontal mid-section of the panel was practically free from the effects of end restraint. Further, the dial gauge readings a and b, on the stiffener side of the panel, are larger than c and d, on the sheet side, indicating platen rotation.

One of the best panels from the standpoint of strain distribution was panel 55. A glance at the gauge readings of Table LVI will show the readings in the end bays to be lower than the central readings. This condition, as well as platen rotation, was evident in nearly all tests.

A conclusion which may be drawn from the above is that it is not possible with flat platens to load a stiffened panel in such a way as to obtain either a condition of uniform stress or strain.

Since failure of the panel usually occurs at mid-length, it is believed that the closest possible approach to uniform strain at this position is better than maintaining parallelism of the platens.

Pin-end lengths. The pin-end lengths of half-waves included in the summary of results should prove to be of value in developing and checking theoretical aspects of this problem. A few observations are of interest. Consi-

dering the .081 inch panels, it will be noticed that in those panels which fail by wrinkling, the pin-end length is approximately 2.00 inches, regardless of rivet pitch, stiffener pitch, or number of stiffeners. Wrinkling did not occur at rivet pitches greater than 2.50 inches. At rivet pitches greater than 3.00 inches, the pin-end length was about half the rivet pitch, the sheet failing like a fixed Euler column between rivets, as in Figure 3. At rivet pitches between 2.00 and 3.00 inches, the pin-end length was nearly equal to the rivet pitch. This, of course, involves distortion of the rivets and stiffeners.

Ultimate stresses. These values, plotted on Figure 82, have been checked as far as possible with other data, and have been found to be in close agreement, especially at the higher stresses. Duplicate panels were tested in a few cases, and will be found in Table LVII. The results checked remarkably well with the original values.

Critical buckling stresses. Figure 83 shows curves of some of these values. The most striking part of these curves is the appearance of cusps, dividing each curve into three parts. This suggests that there are three buckling regimes depending on rivet pitch, and this is borne out by the three varieties of pin-end lengths previously mentioned. Curves of this nature have not been previously reported, and

are definitely of interest from the theoretical standpoint. A great deal of time has been spent on photo-grid readings in an attempt to find some definite type of buckling corresponding to these regimes, but without success. About all that can be said at present is that they correspond with the pin-end lengths associated with wrinkling, Euler sheet buckling, and the phase in between these two. At the peaks of the cusps, the critical stress will be found to be very close to the ultimate stress.

0.2 per cent L buckle amplitude. The smoothness criterion of specifying critical stresses will be seen to give results which are close to the critical buckling stress, but which are in general somewhat lower. This is an indication that if a high degree of skin smoothness is desired, even the critical buckling stress is on the unsafe side. If this statement is accepted as true, then no theoretical solution to the problem is possible by existing methods, since all of these methods involve determinations of P_{cr} .

Plate buckling. According to published data, panel 19 should have failed by "pure inter-rivet buckling", unaffected by plate buckling. It is difficult to visualize just how the sheet could buckle between rivets before buckling between the stiffeners, but this has been presumed to be the case by most authorities. Careful measurement of photo-grid

negatives has revealed the fact that panel 19 developed slight, but well-defined, anti-symmetrical plate buckling initially, after which inter-rivet buckling occurred, causing disappearance of the plate buckling. This is illustrated in Figures 73 and 74. This condition was observed in many of the panels tested, and is believed to have occurred in all of them.

The original problem, namely, buckling of stiffened panels excluding the case of plate buckling is, in the above light, an impossibility. The difference between thin and thick panels in this regard appears to be only one of degree, the plate buckling in the latter case being of such small amplitude as to have escaped notice. This perhaps is a statement which would only interest the theorist, because the amount of plate buckling is so small as to be practically negligible.

BIBLIOGRAPHY

- Cox; H. L., and Riddell; J. R. Buckling of a Longitudinally Stiffened Flat Panel, Aeronautical Quarterly, Vol. 1, November 1949, Part III, Royal Aeronautical Society, London. 20 p.
- Cox; H. L., Thurston; F. R., Coleman; E. P., Smith; H. E., Compression Tests on Seven Panels of Monocoque Construction, R & M No. 2042, Ministry of Supply, Aeronautical Research Council, Her Majesty's Stationery Office, London. 21 p.
- Dow; Norris F., Design Charts for Longitudinally Stiffened Wing Compression Panels, a paper presented at the SAE National Aeronautic and Air Transport Meeting, Hotel New Yorker, New York, April 13 - 15, 1948. 34 p.
- Dow; Norris F., and Hickman; W. A., Effect of Variation in Diameter and Pitch of Rivets on Compressive Strength of Panels with Z Section Stiffeners, Supt. of Documents, Washington, D. C., NACA RB L5G03, August 1945. 13p.
- NACA TN 1421, September 1947. 18 p.
- NACA TN 1467, October 1947. 27 p.
- NACA TN 1737, November 1948. 21 p.
- Dunn; L. G., An Investigation of Sheet Stiffener Panels Subjected to Compression Loads with Particular Reference to Torsionally Weak Stiffeners, NACA TN 752, February 1940. 59 p.
- Gallaher; George L., and Boughan; Rolla B., A Method of Calculating the Compressive Strength of Z Stiffened Panels That Develop Local Instability, NACA TN 1482, November 1947. 15 p.
- Hu; Pai C., Lundquist; Eugene E., and Batdorf; S. B., Effect of Small Deviations from Flatness on Effective Width and Buckling of Plates in Compression, NACA TN 1124, September 1946. 42 p.
- Joyce; N. B., The Strength of Sheet-Stiffener Combinations in Compression, Part I--Flat Panels, Council for Scientific and Industrial Research, Division of Aeronautics, Report SM 67, Aeronautical Laboratory, Fishermen's Bend, Melbourne, Australia.

- Kotanchik; Joseph N., Weinberger; Robert A., Zender; George W., Neff; John Jr., Compressive Strength of Flat Panels with Z and Hat Section Stiffeners, NACA ARR No. L4F01, June 1944. 33 p.
- Lundquist; E. E., and Stowell; E. Z., Critical Compressive Stress for Outstanding Flanges, NACA ACR 12, April 1941, 27 p.
- Rossmann; Carl A., Bartone; Leonard M., Dobrowski; Charles V., Compressive Strength of Flat Panels with Z Section Stiffeners, NACA ARR No. 4B03, February 1944. 18 p.
- Rossmann; Carl A., Schuette; E. H., Data on Compressive Strength of Flat Panels with Z-Section Stiffeners, NACA RB 8, September 1942, 10 p.
- Schuette; Evan H., Charts for Minimum-Weight Design of 24S-T Aluminum-Alloy Flat Compression Panels with Longitudinal Z-Section Stiffeners, NACA ARR L5F15, August 1945. 64 p.
- Anonymous; Strength of Aircraft Elements, ANC - 5 Army-Navy-Civil Committee on Aircraft Design Criteria, December 1942.